



THE LONE RANGER



79110





2x

75

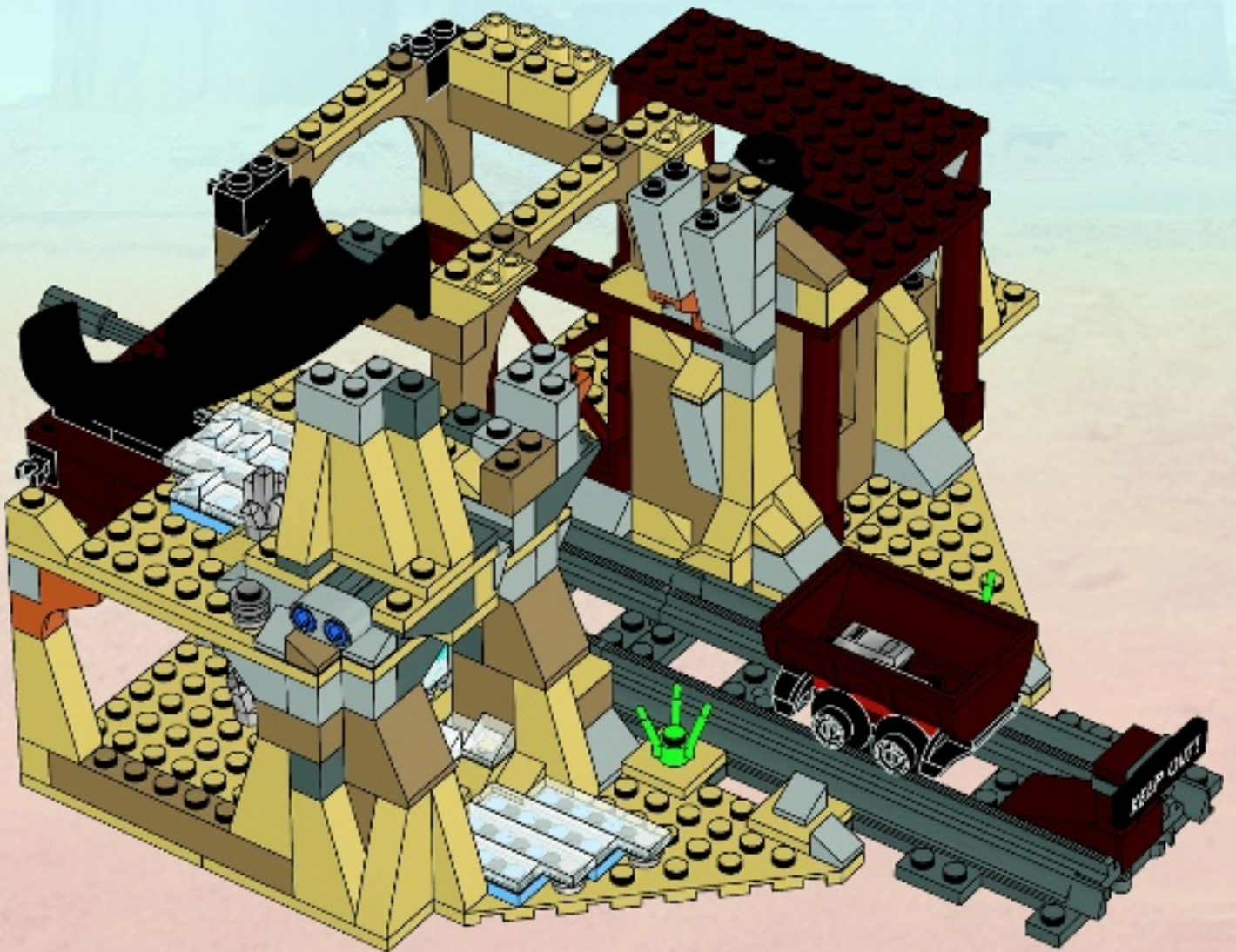
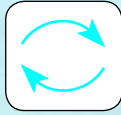



1x

76





77

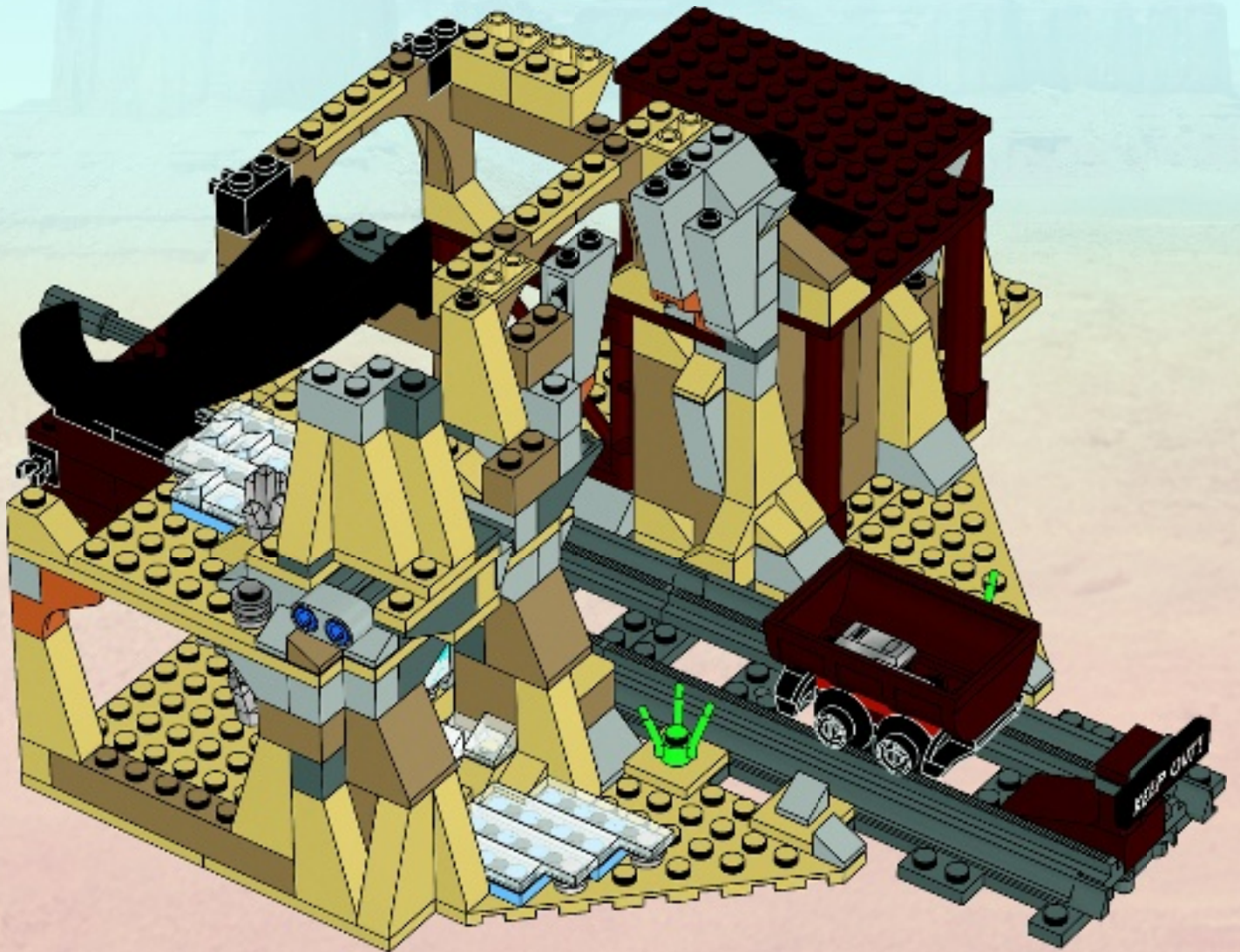

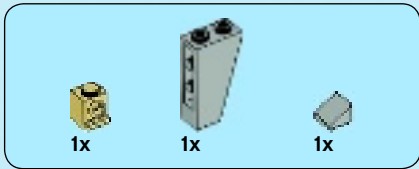

78

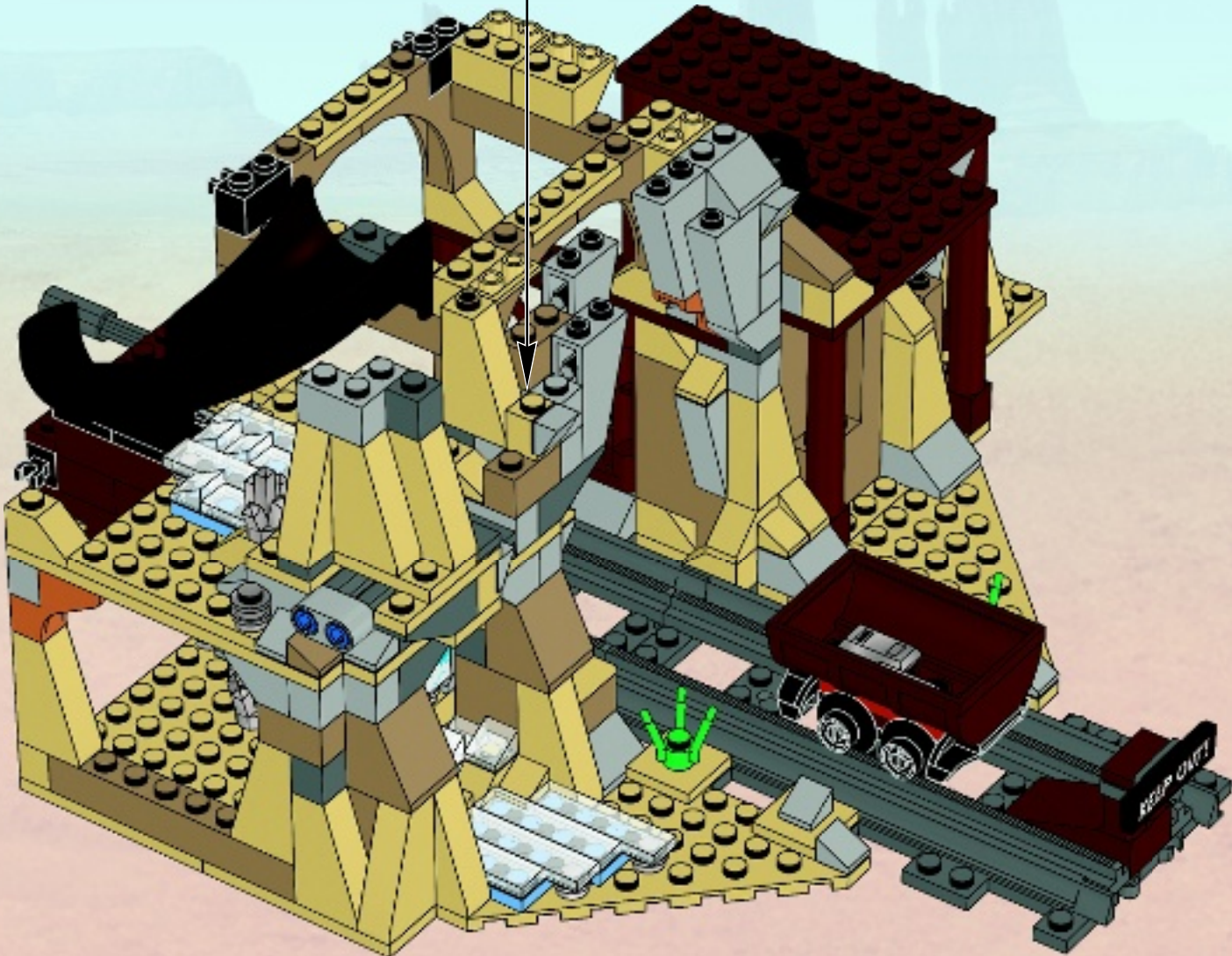
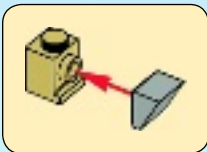



3x

79

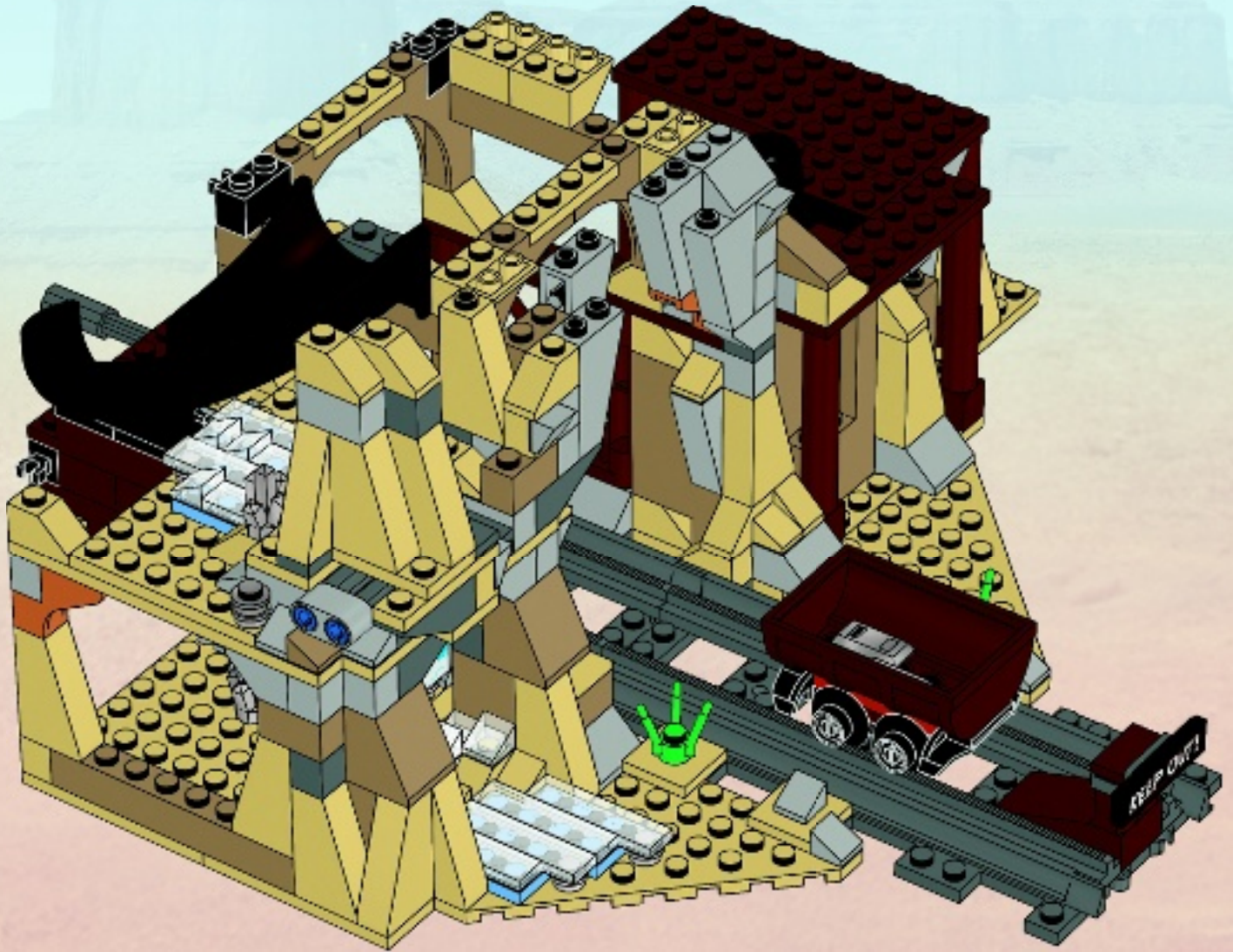



1x

80

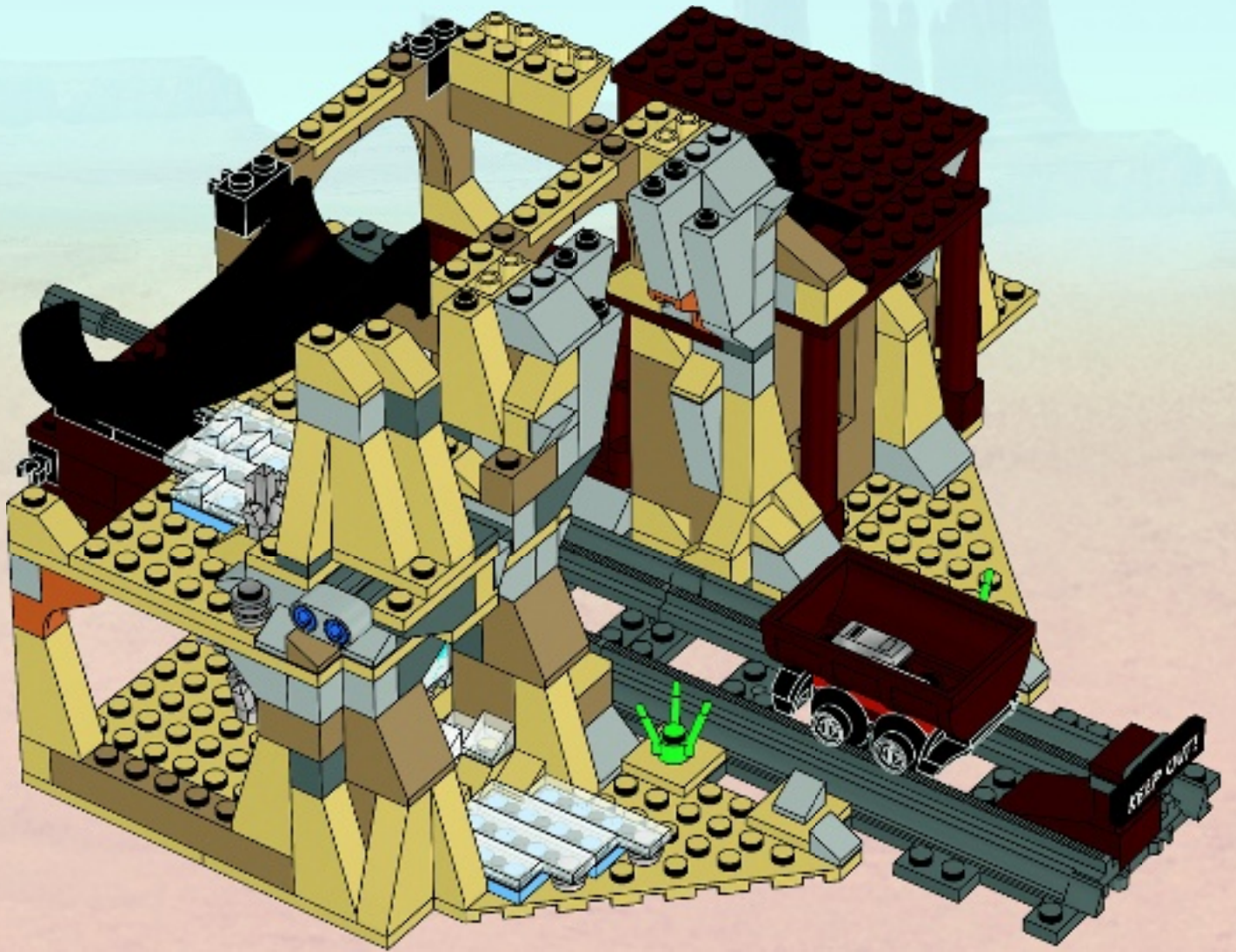

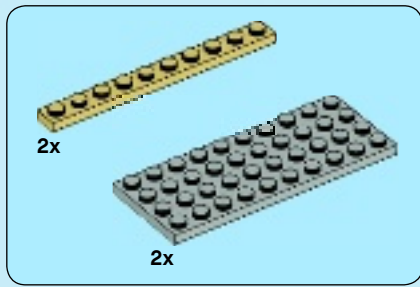



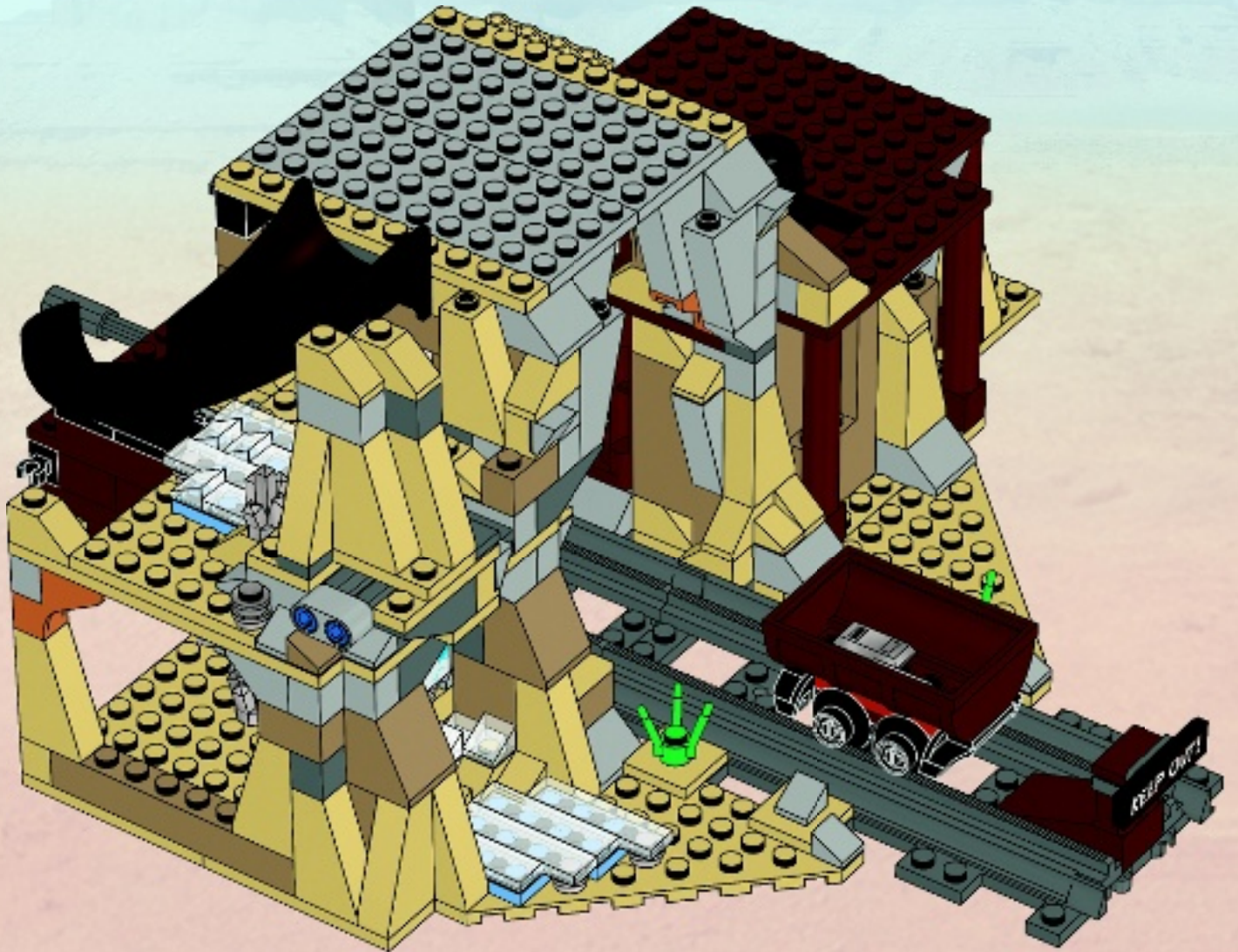

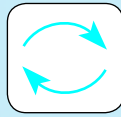
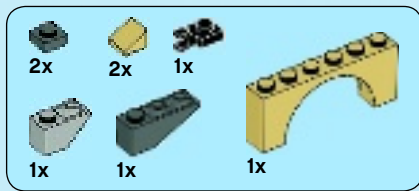
81



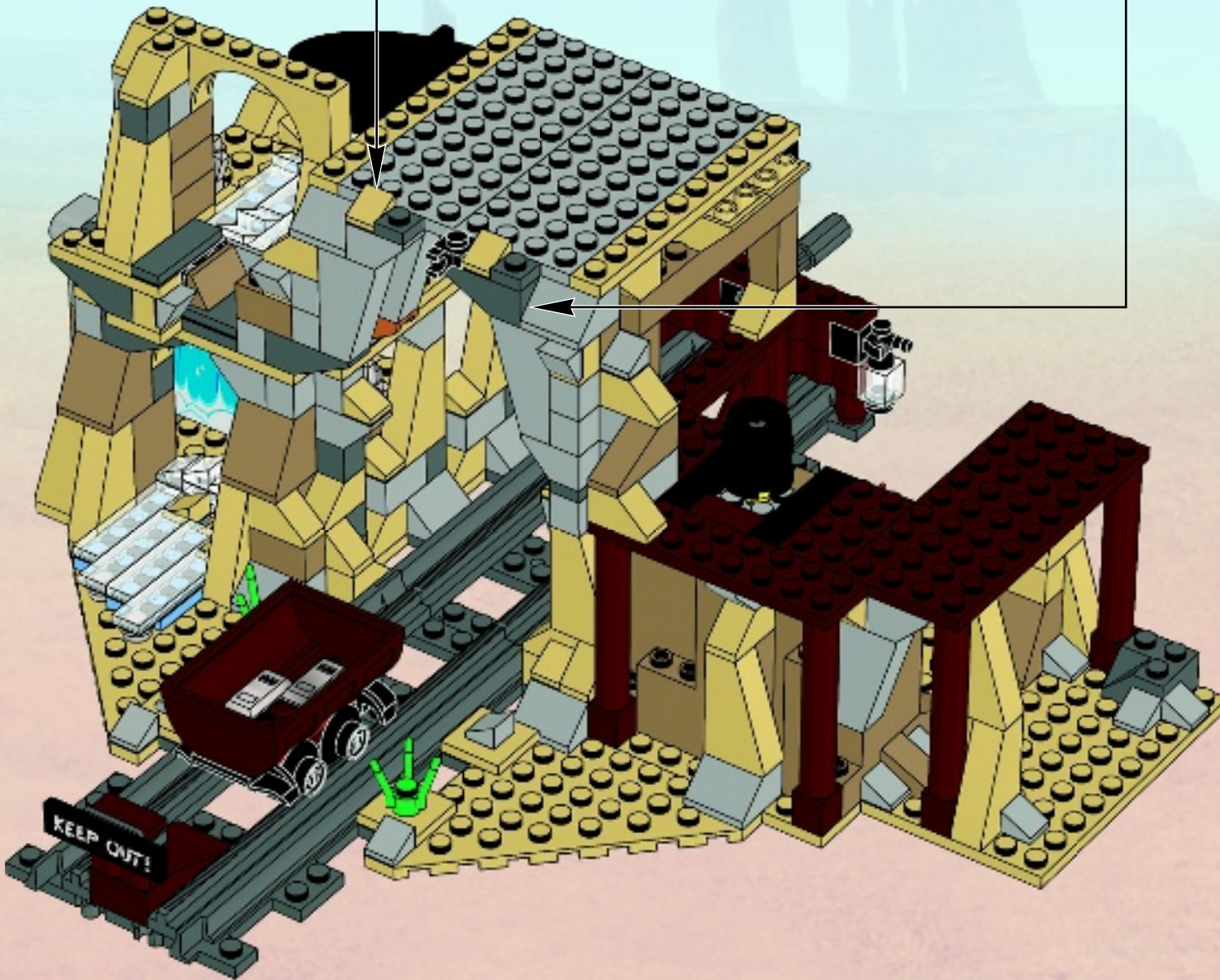
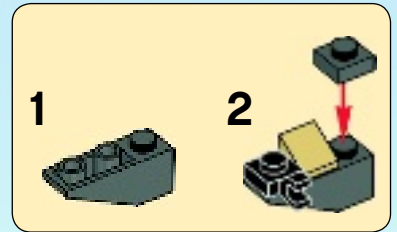
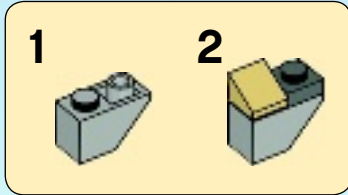

82



			
2x	2x	2x	1x

83



2x

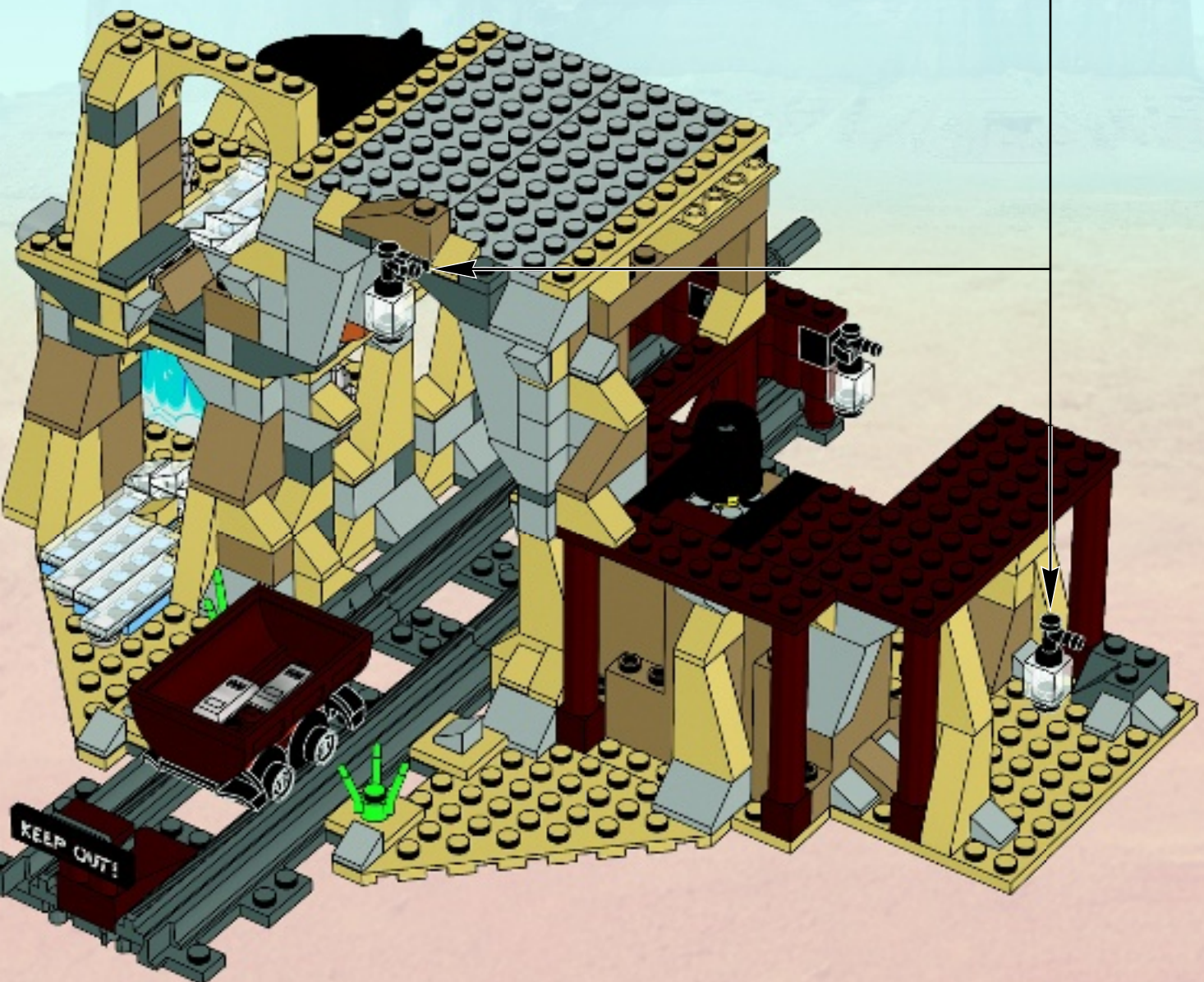

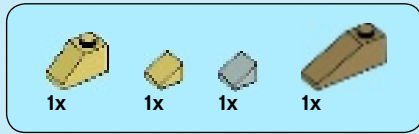

84

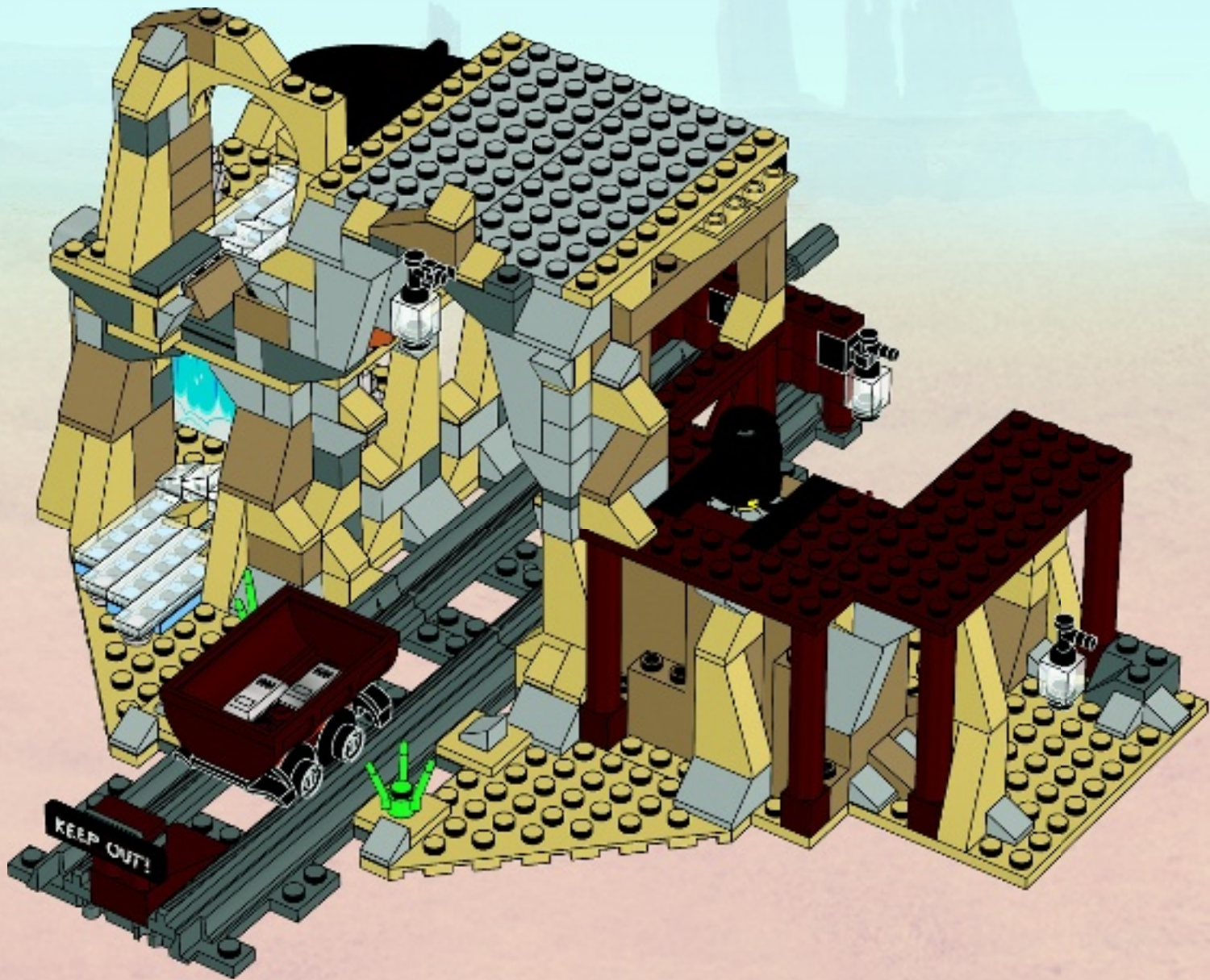



1x



1x

85

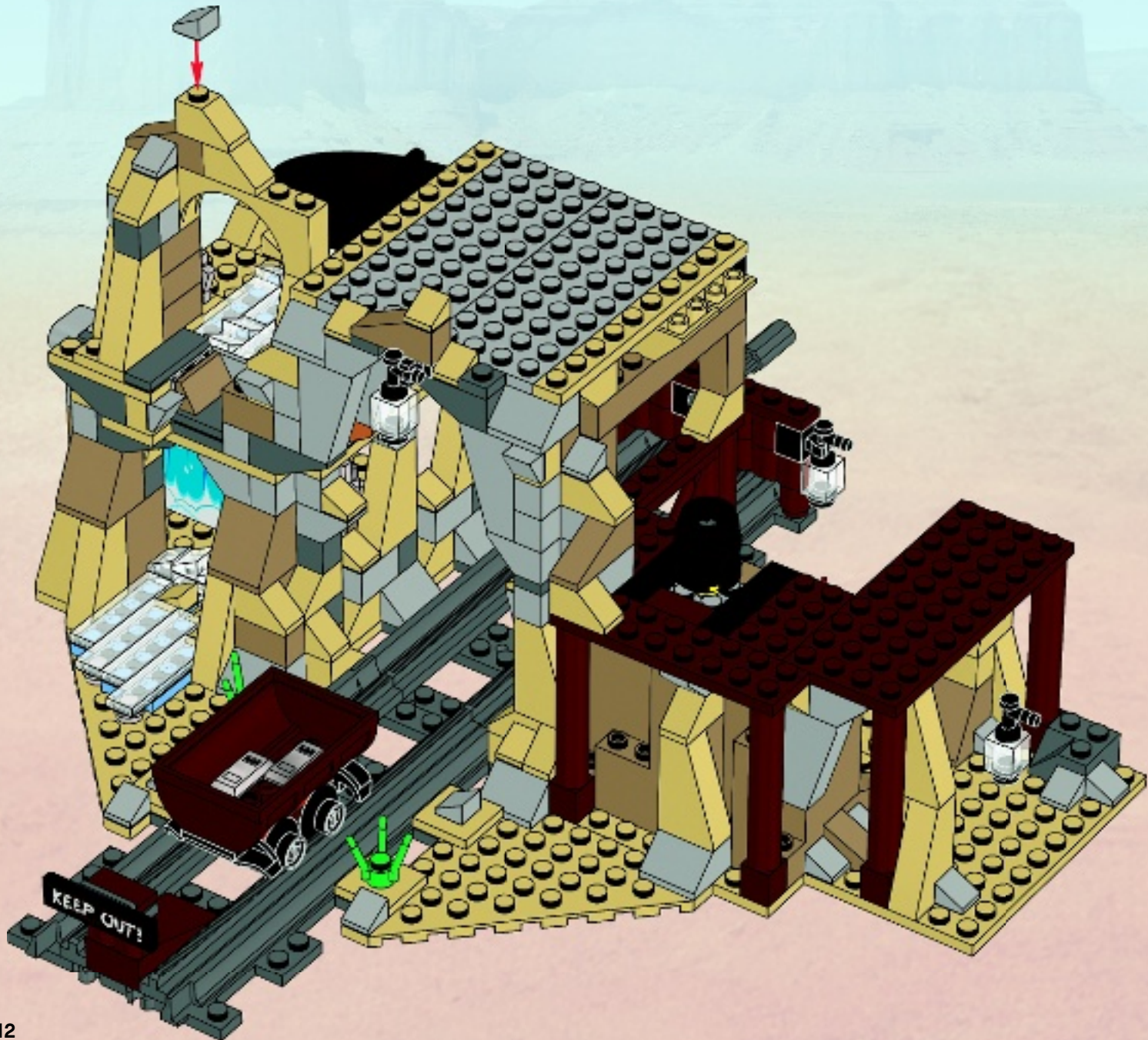

86

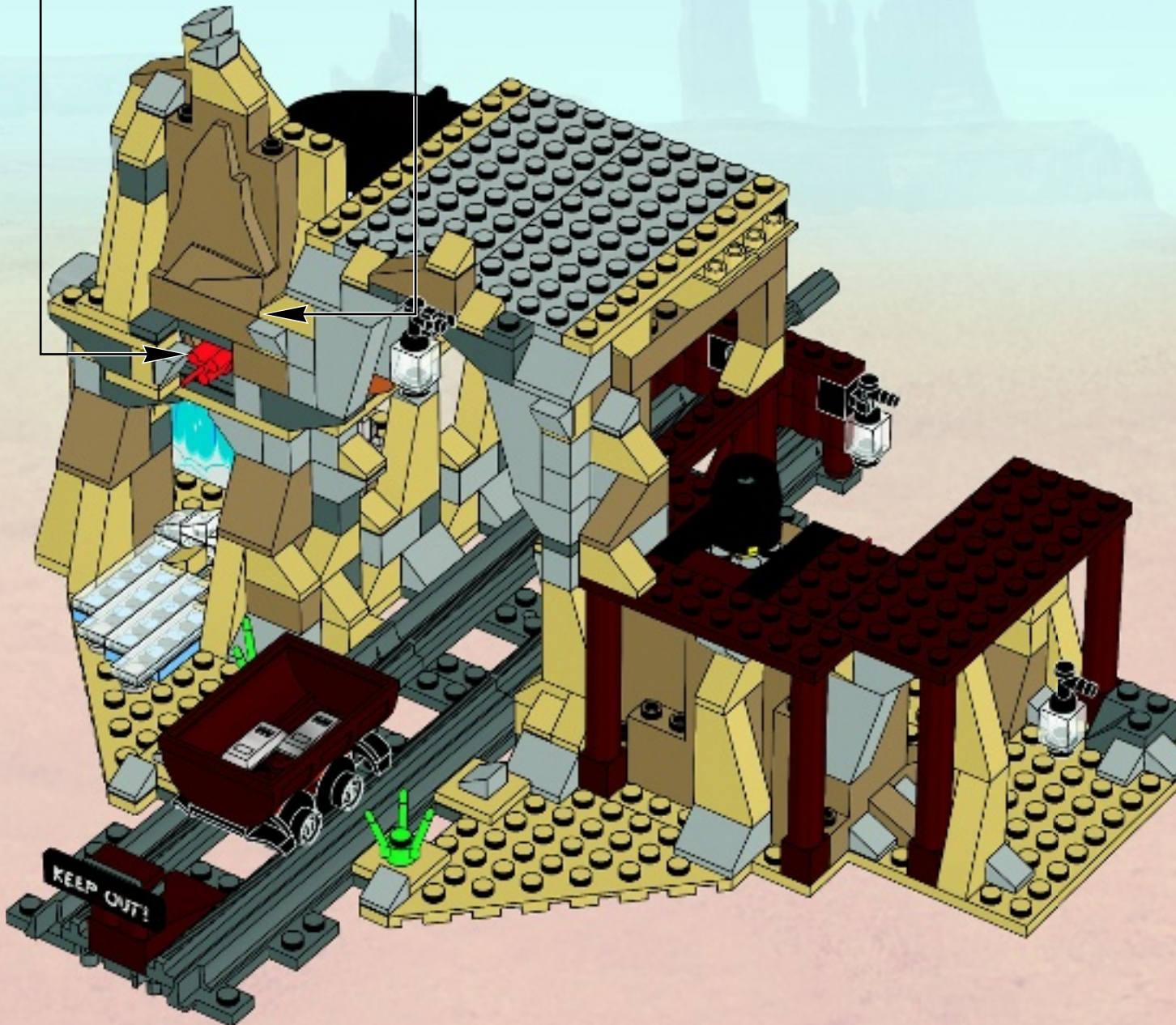
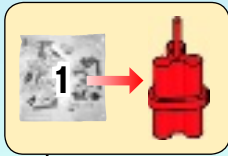
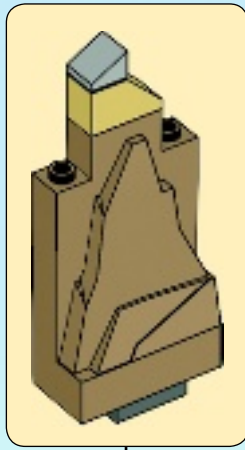

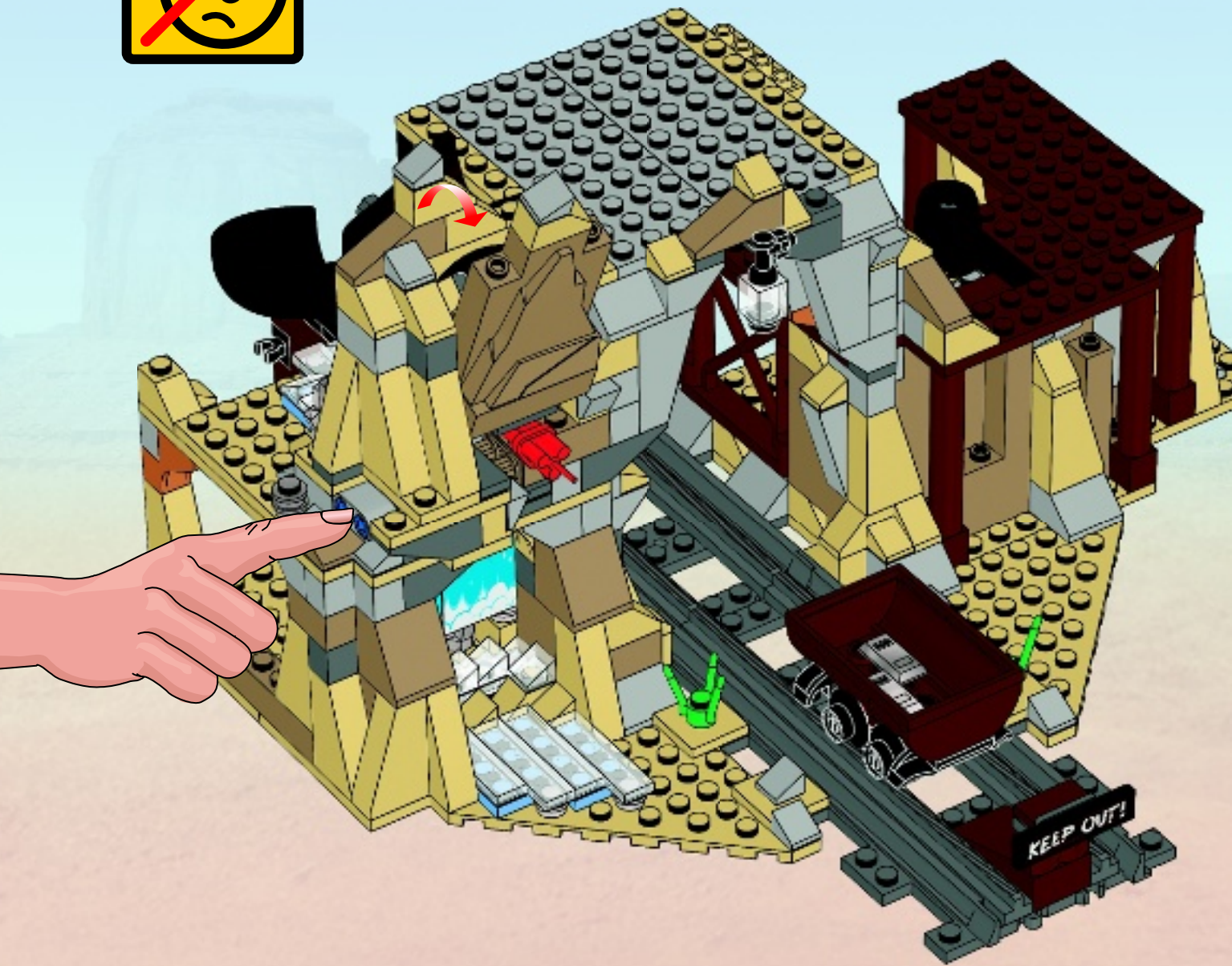

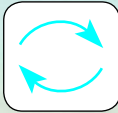
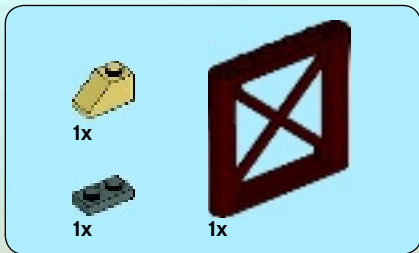
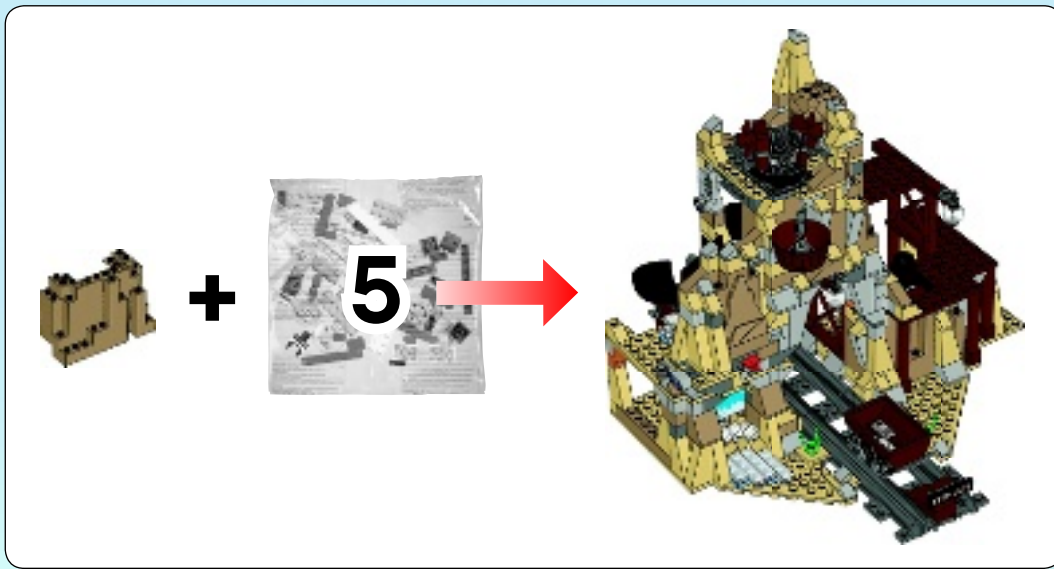

87

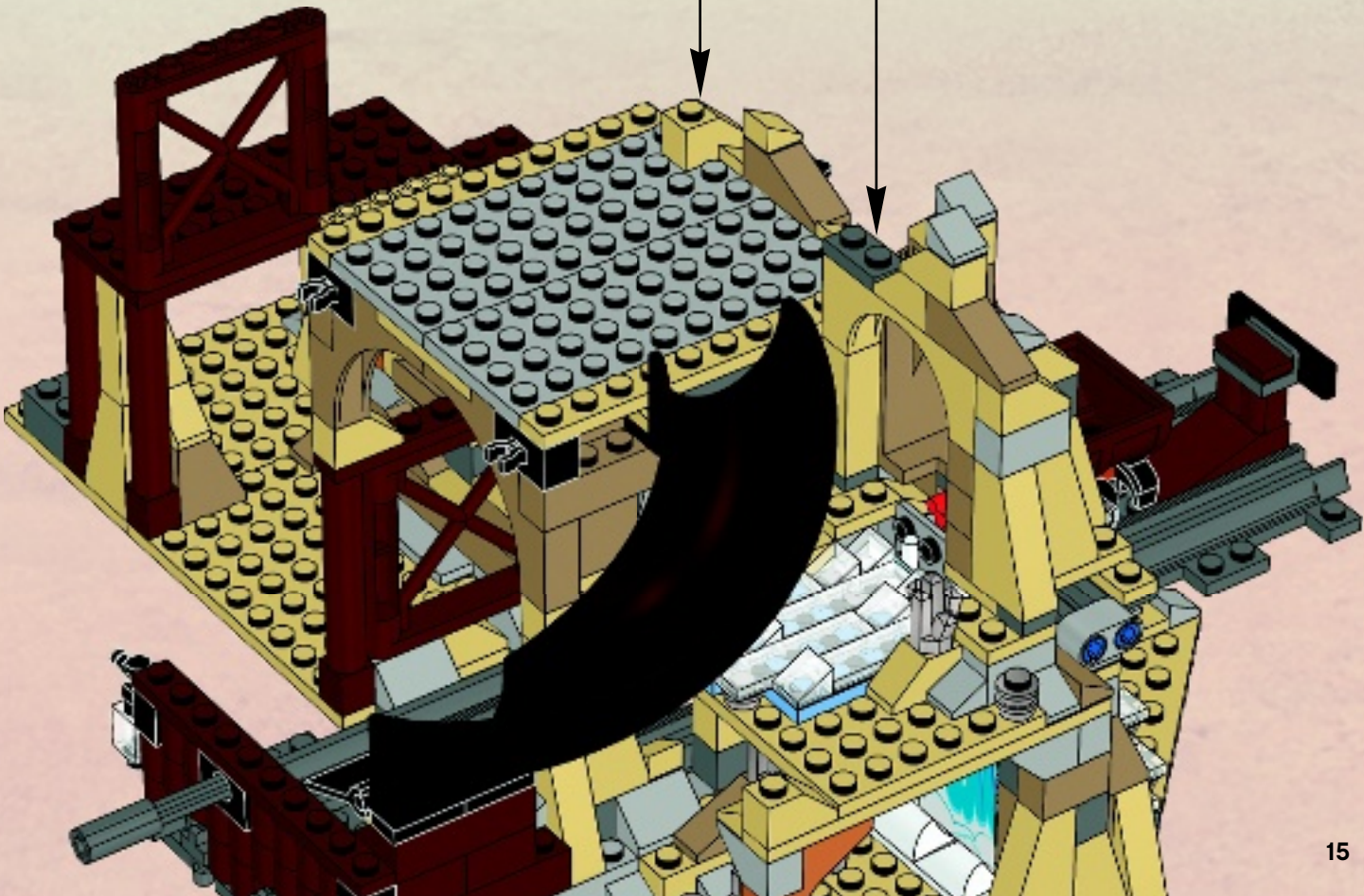

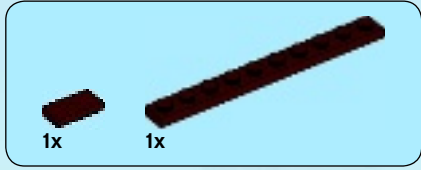
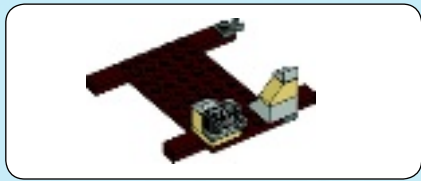

1

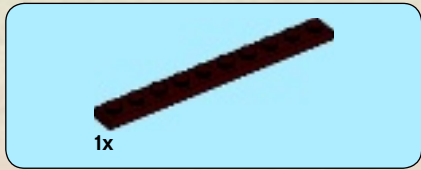

2

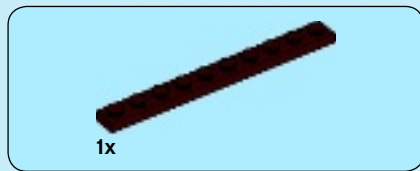

3

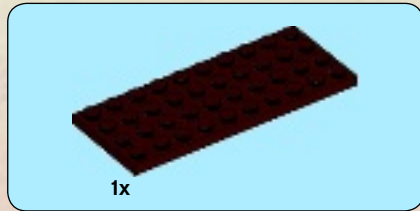
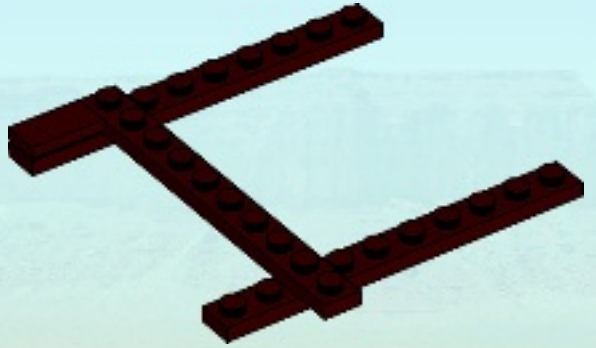

4

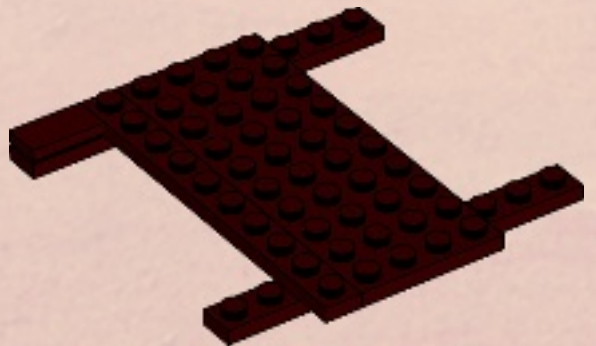

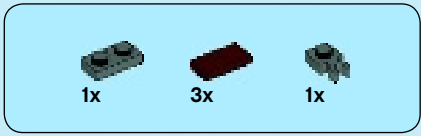

5

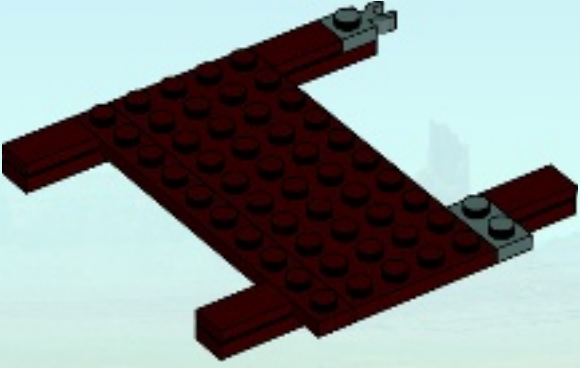

7

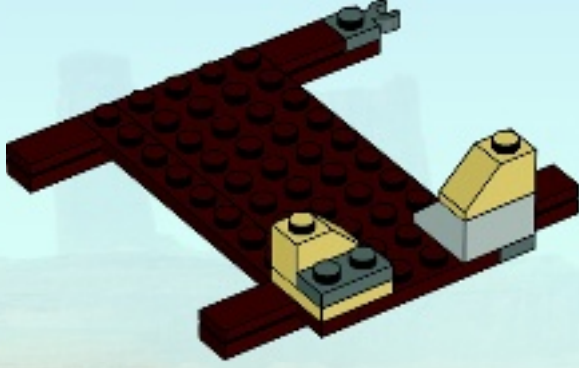

6

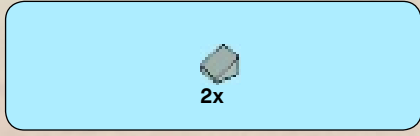
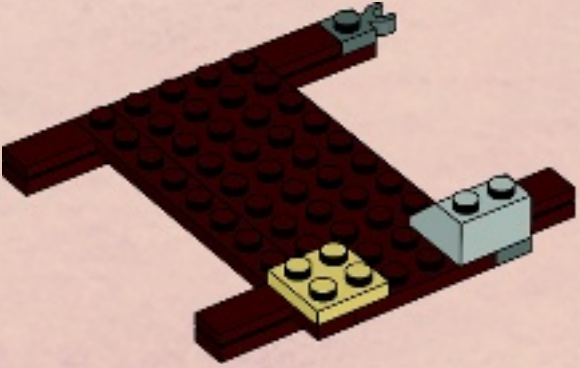

8

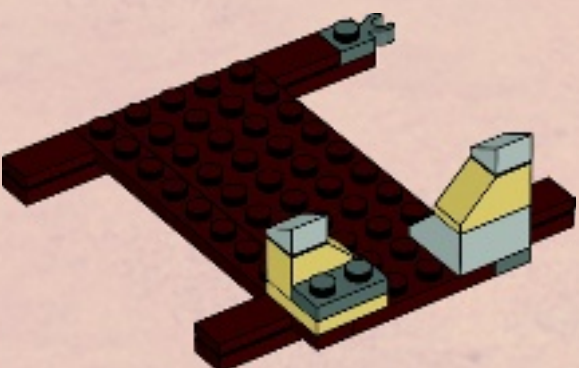





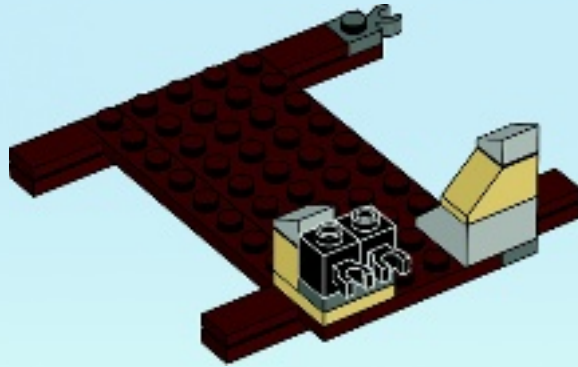

2x

9

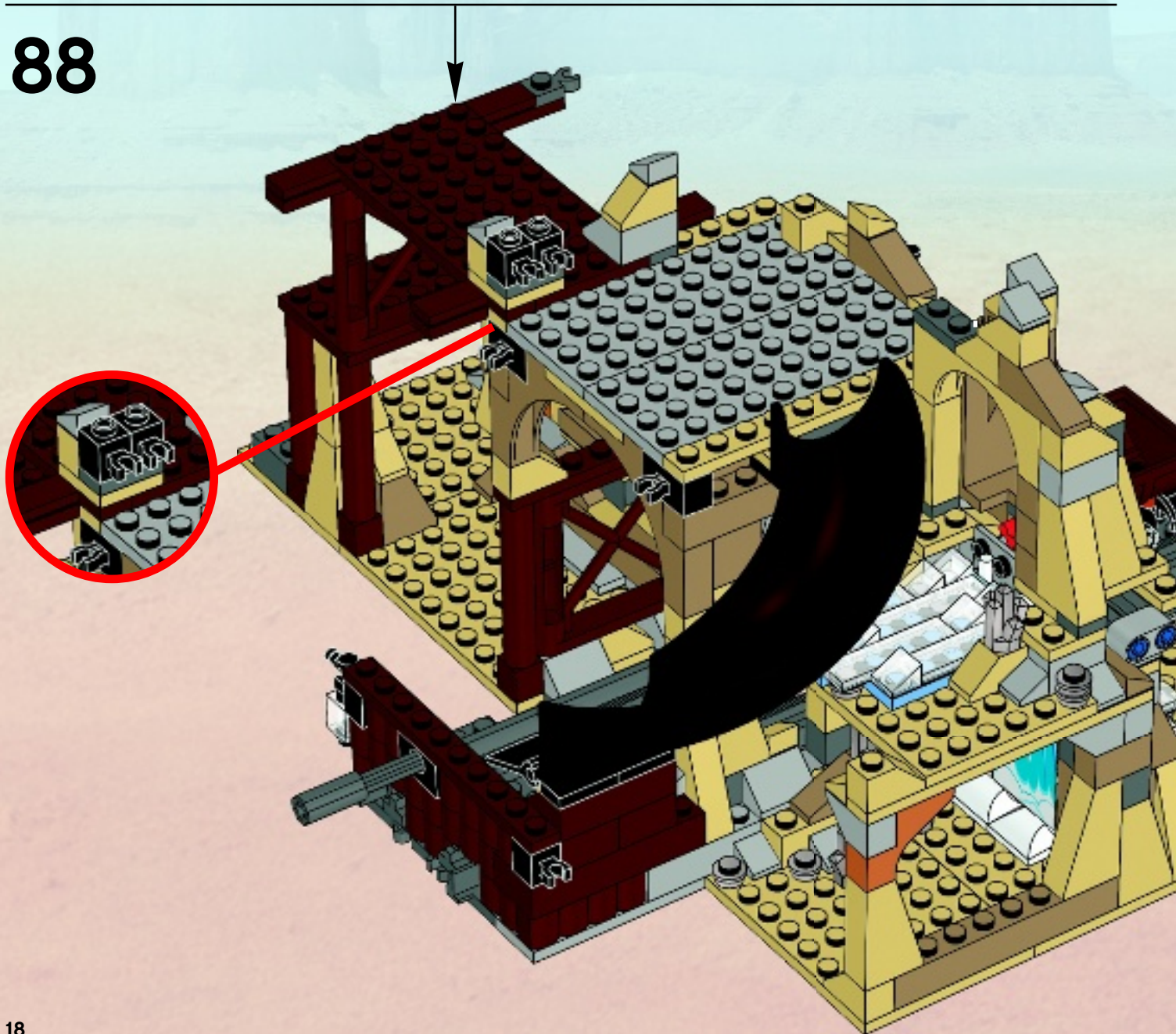

88



- 1x 
- 1x 
- 1x 
- 1x 

89

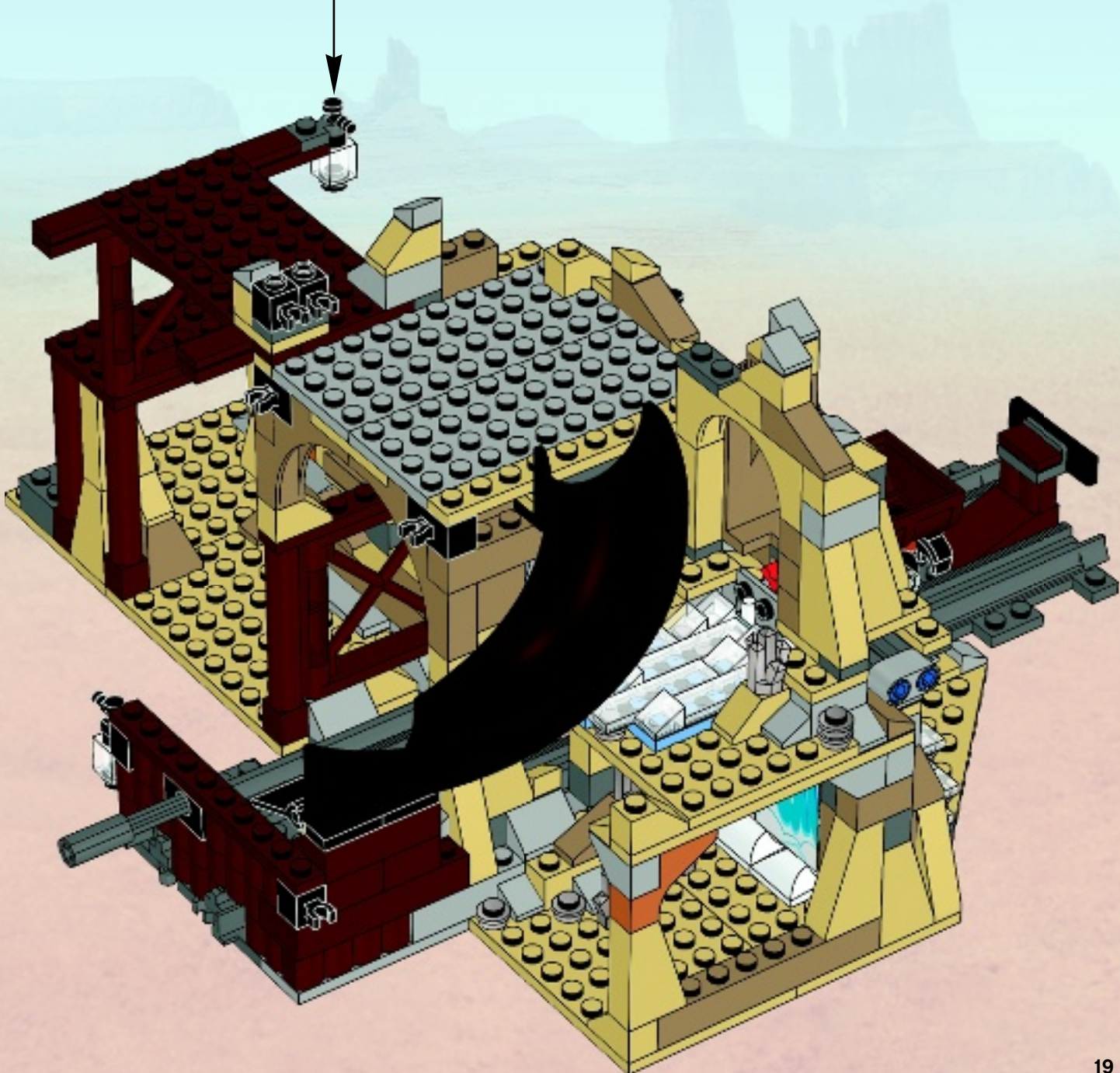
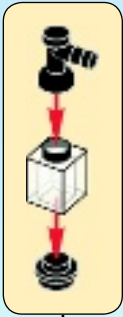



2x

90

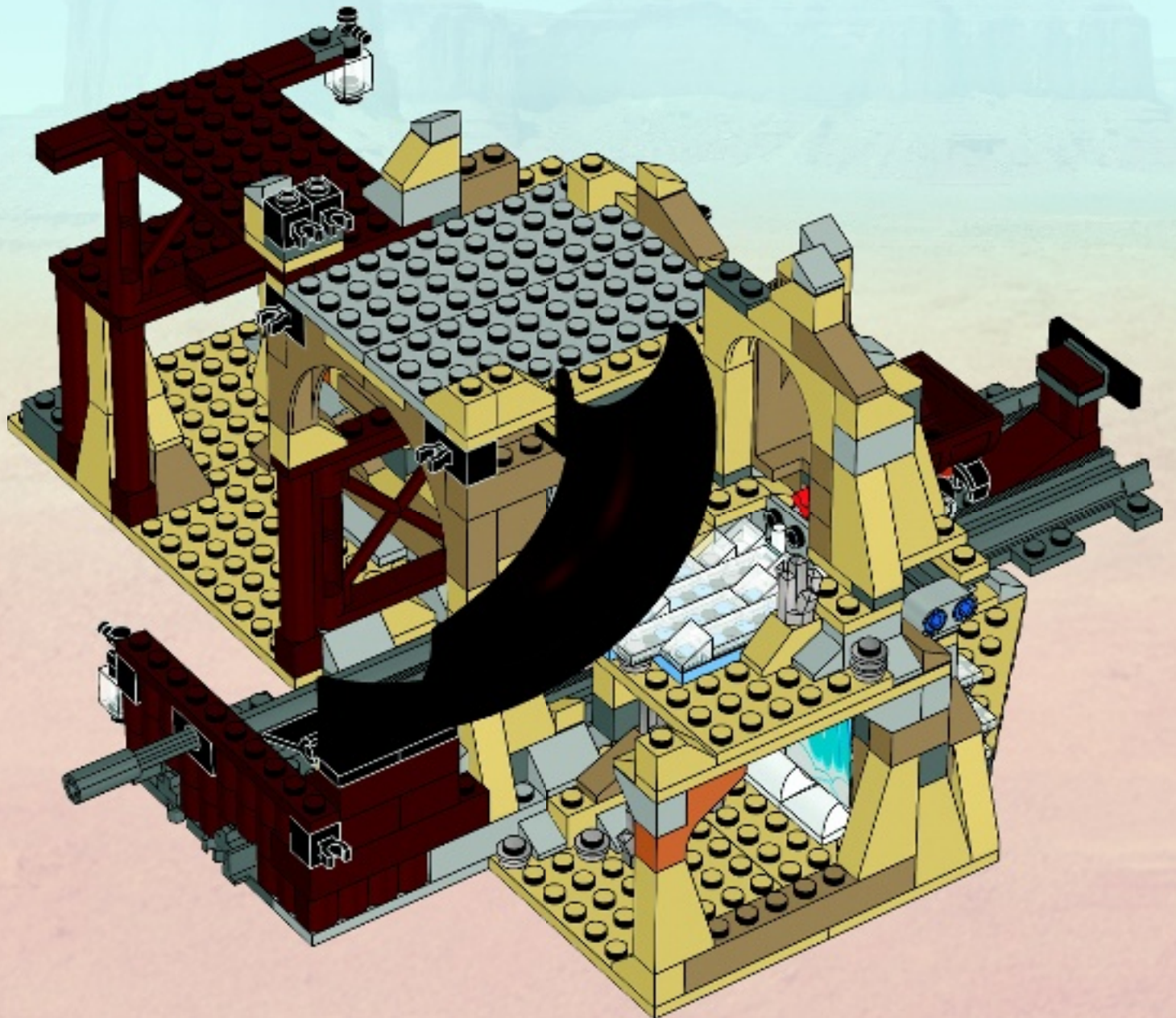



2x

91

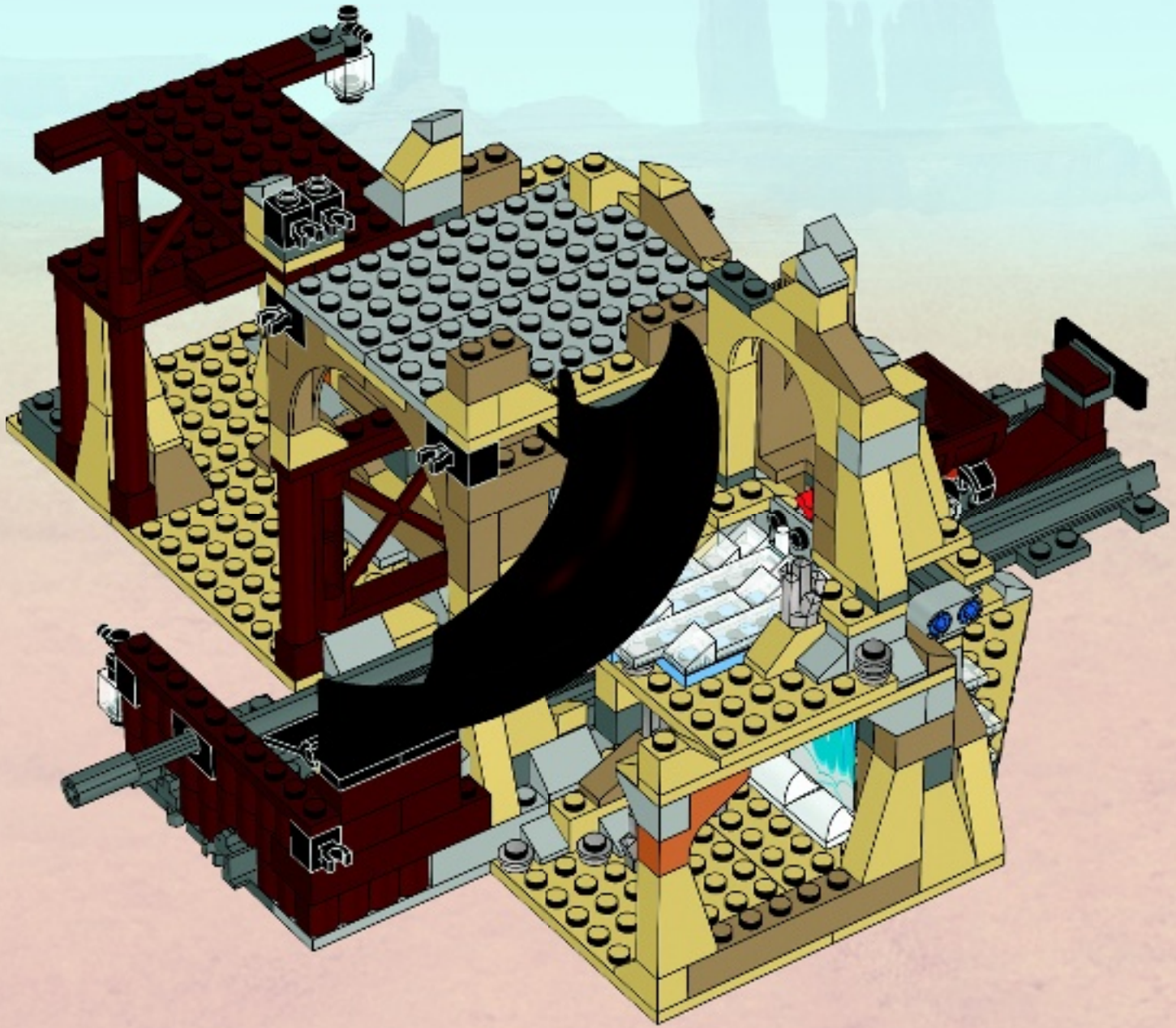

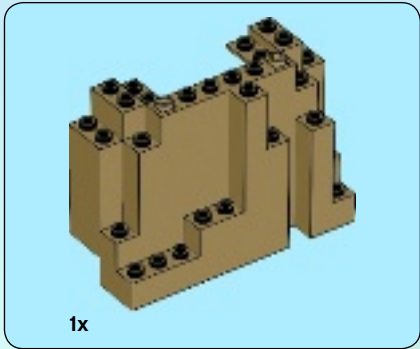
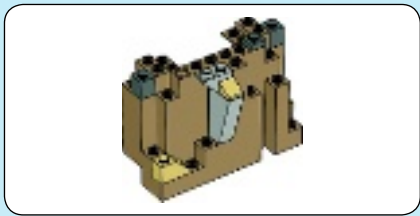

1

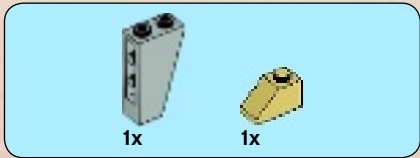
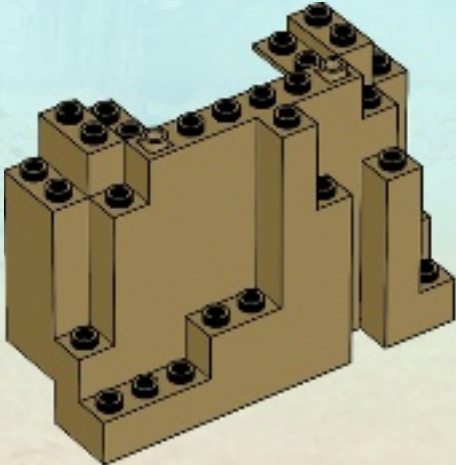

2

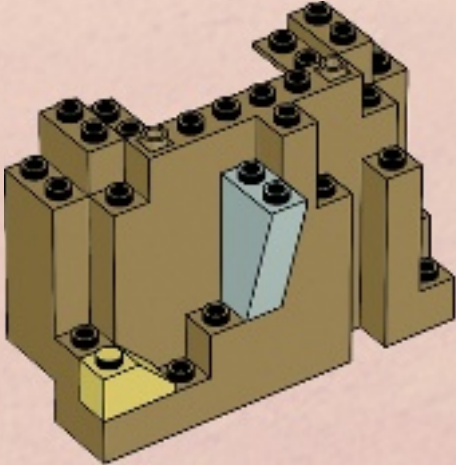



1x



2x

3

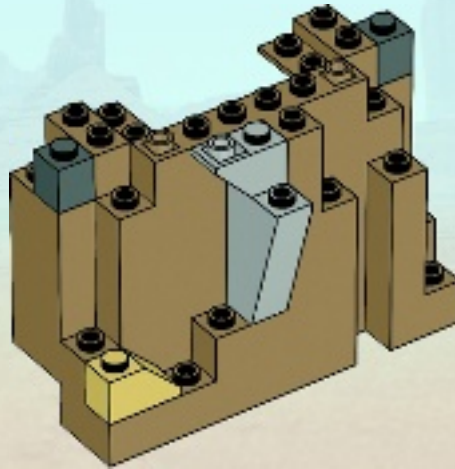

1x



1x

4

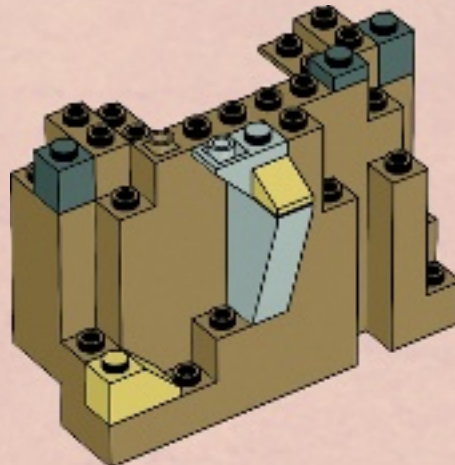

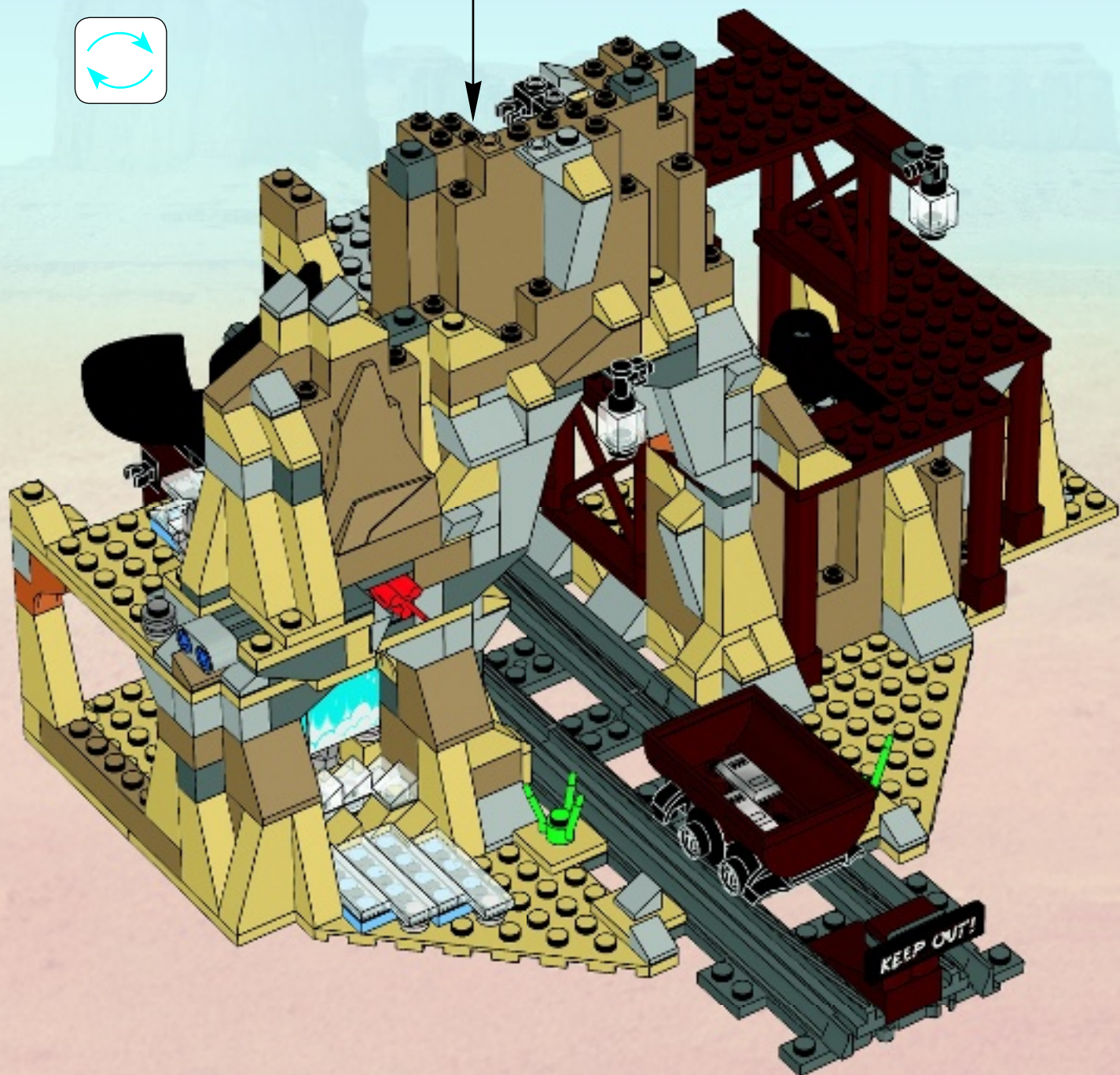
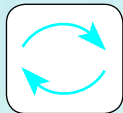



2x



2x

93

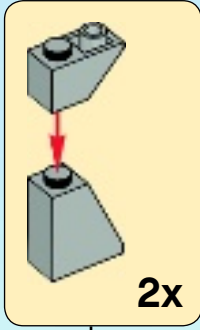

2x

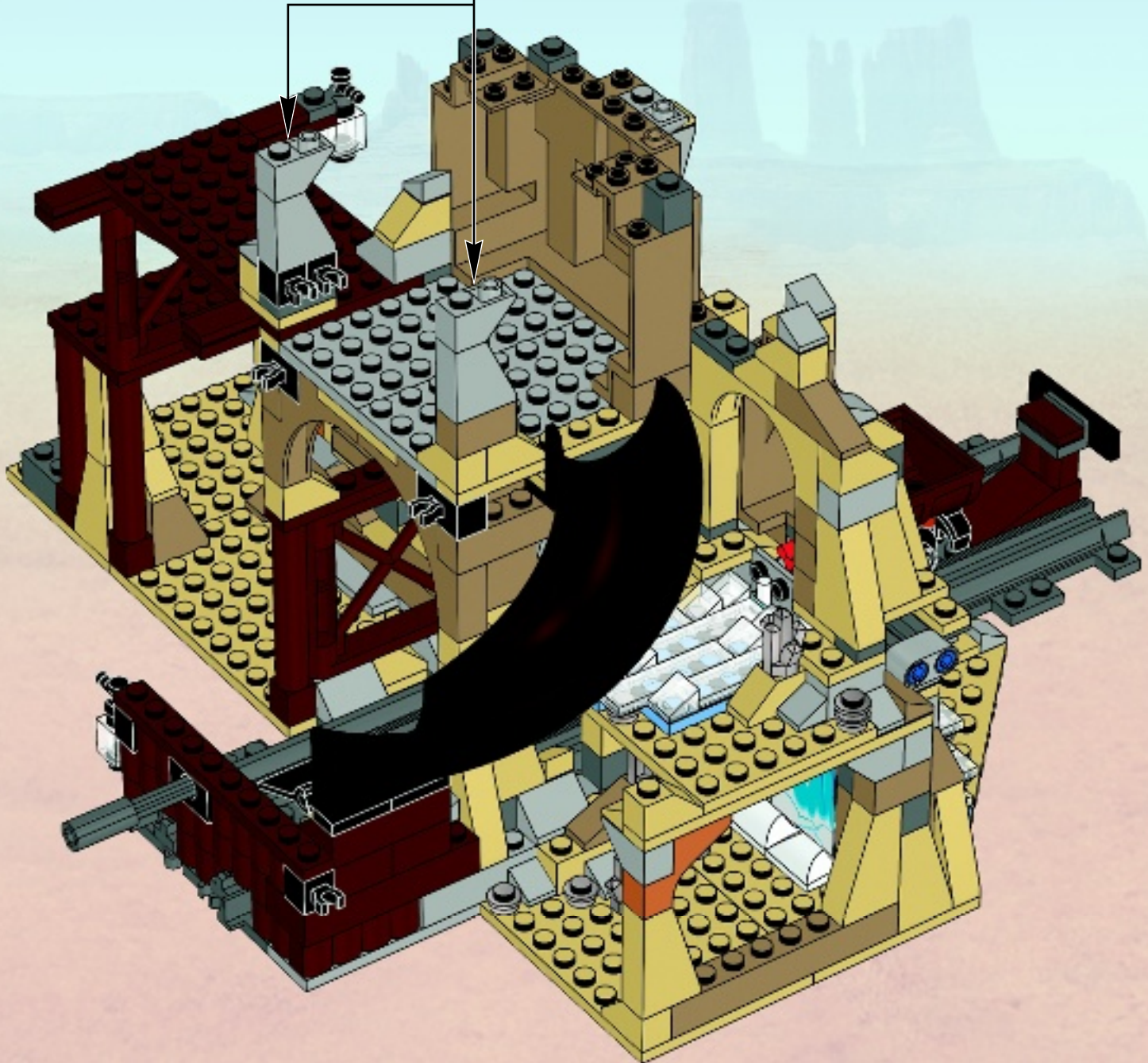

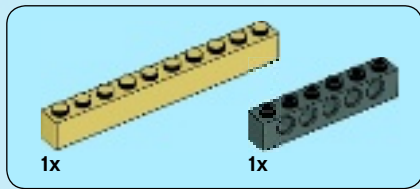

94

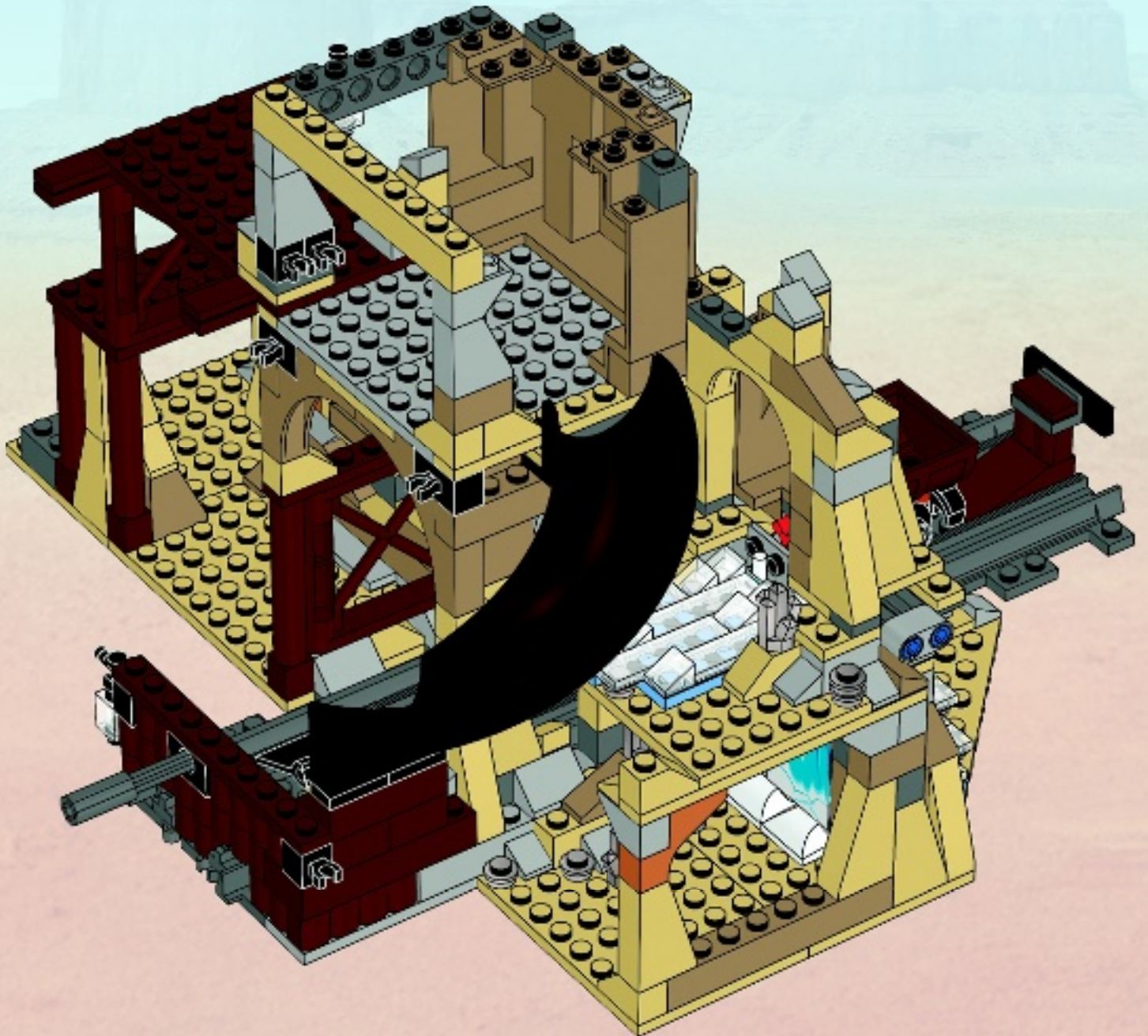

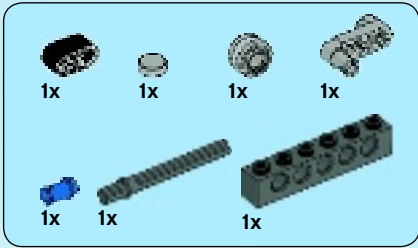

95

1

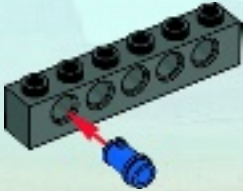

2



3



4

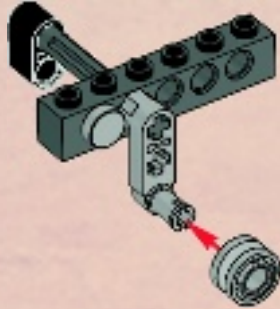

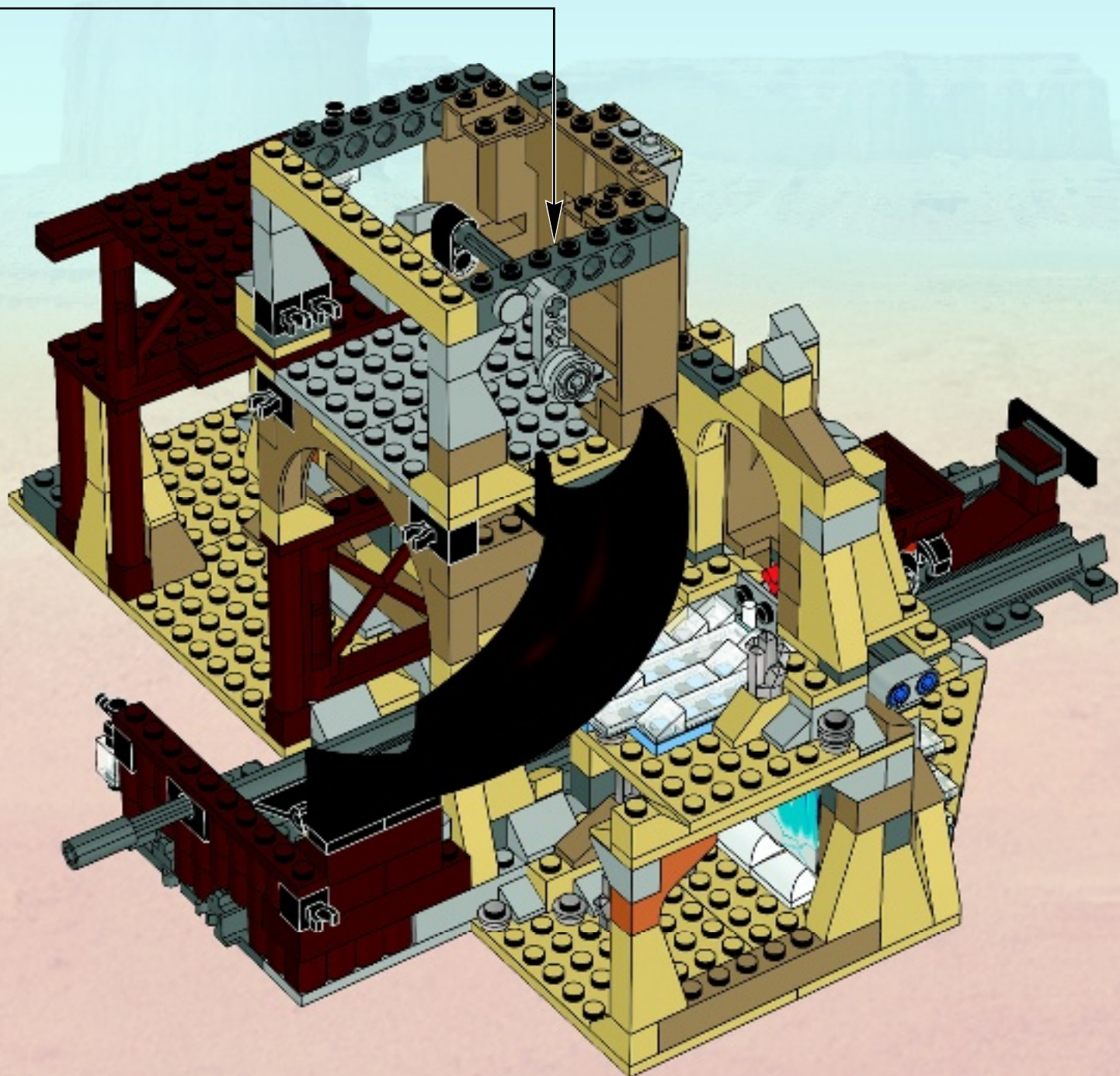



96

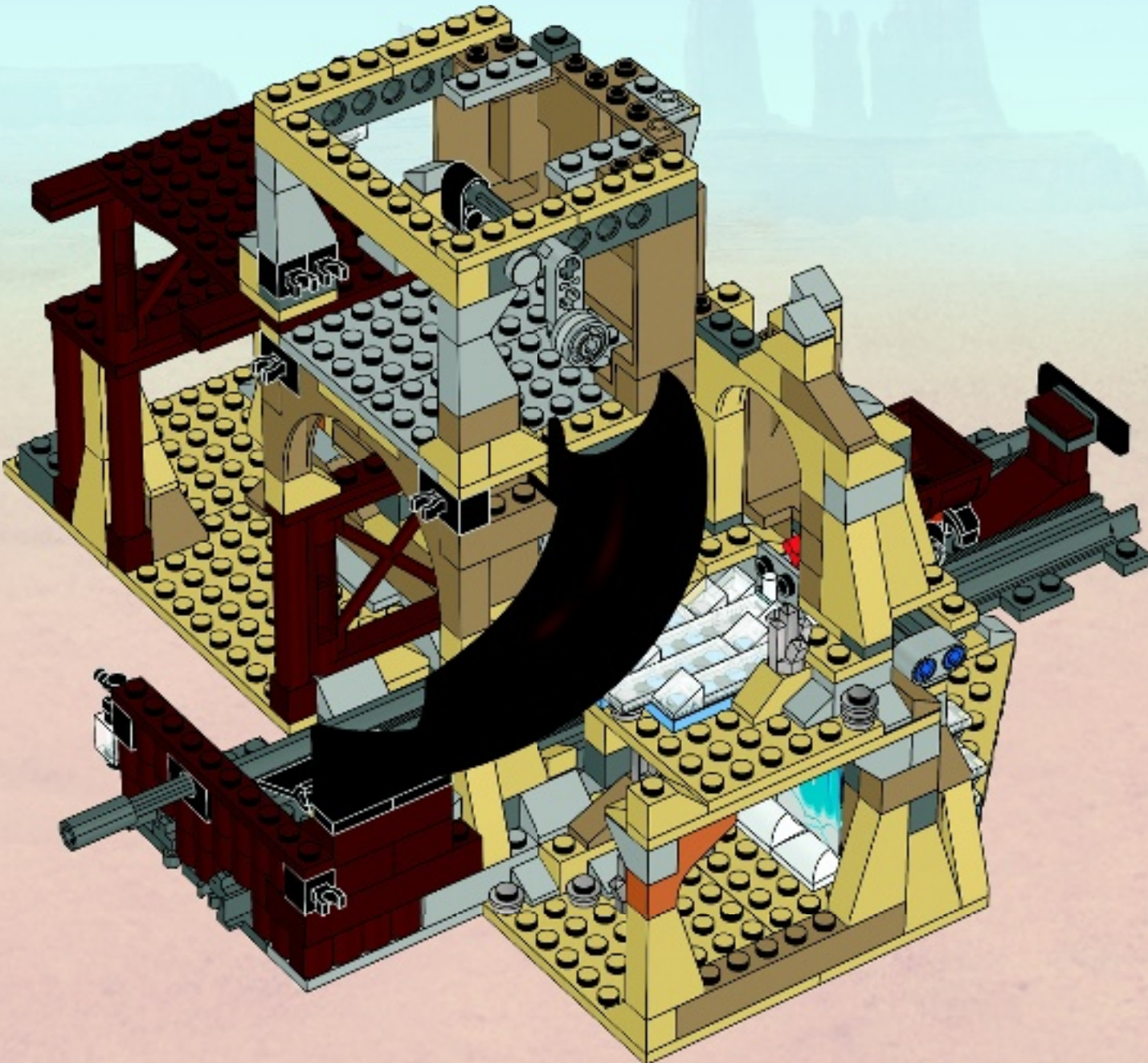

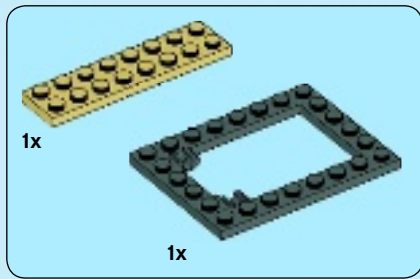

97

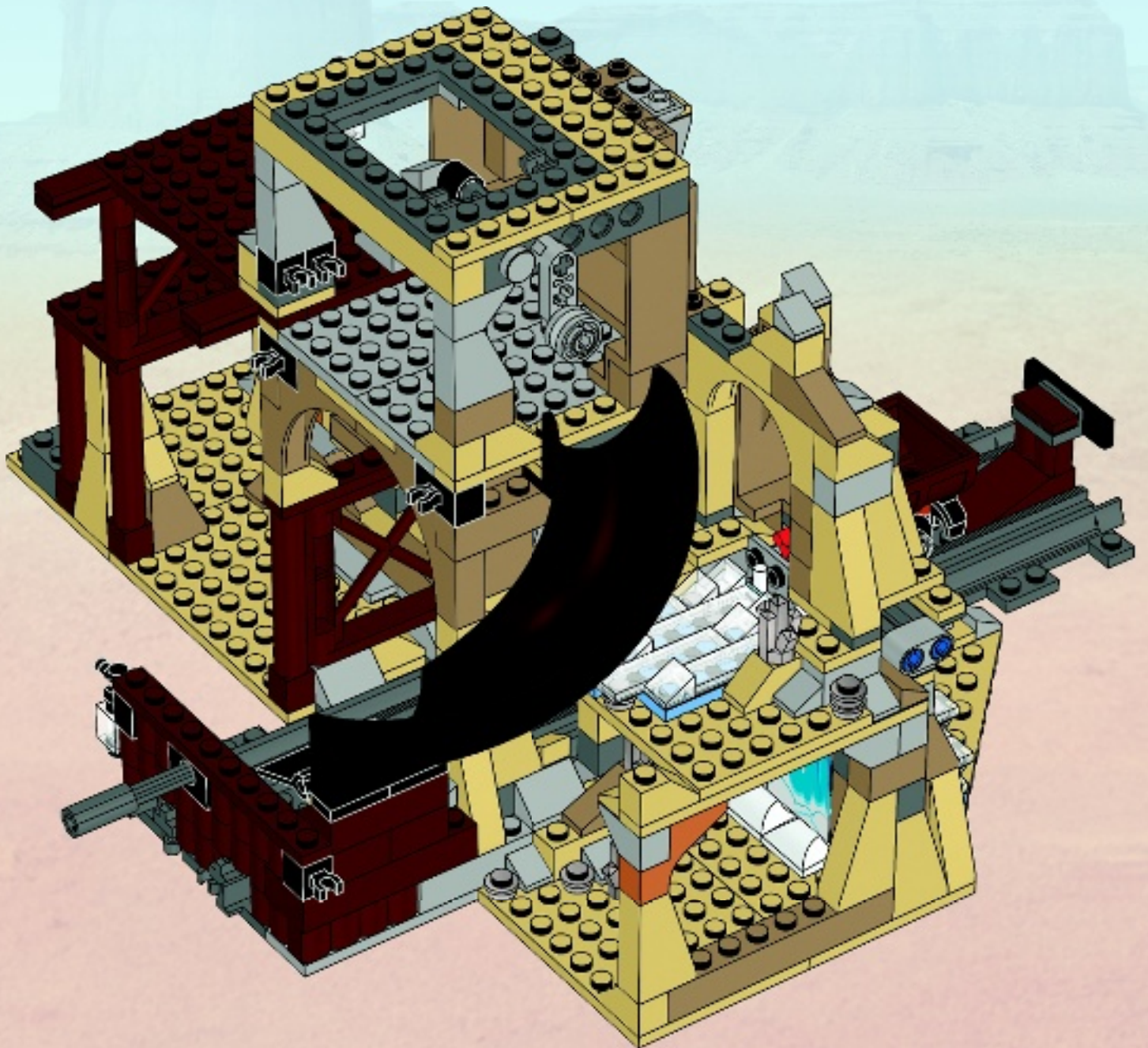

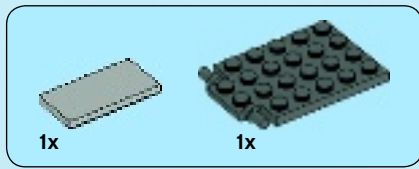

98

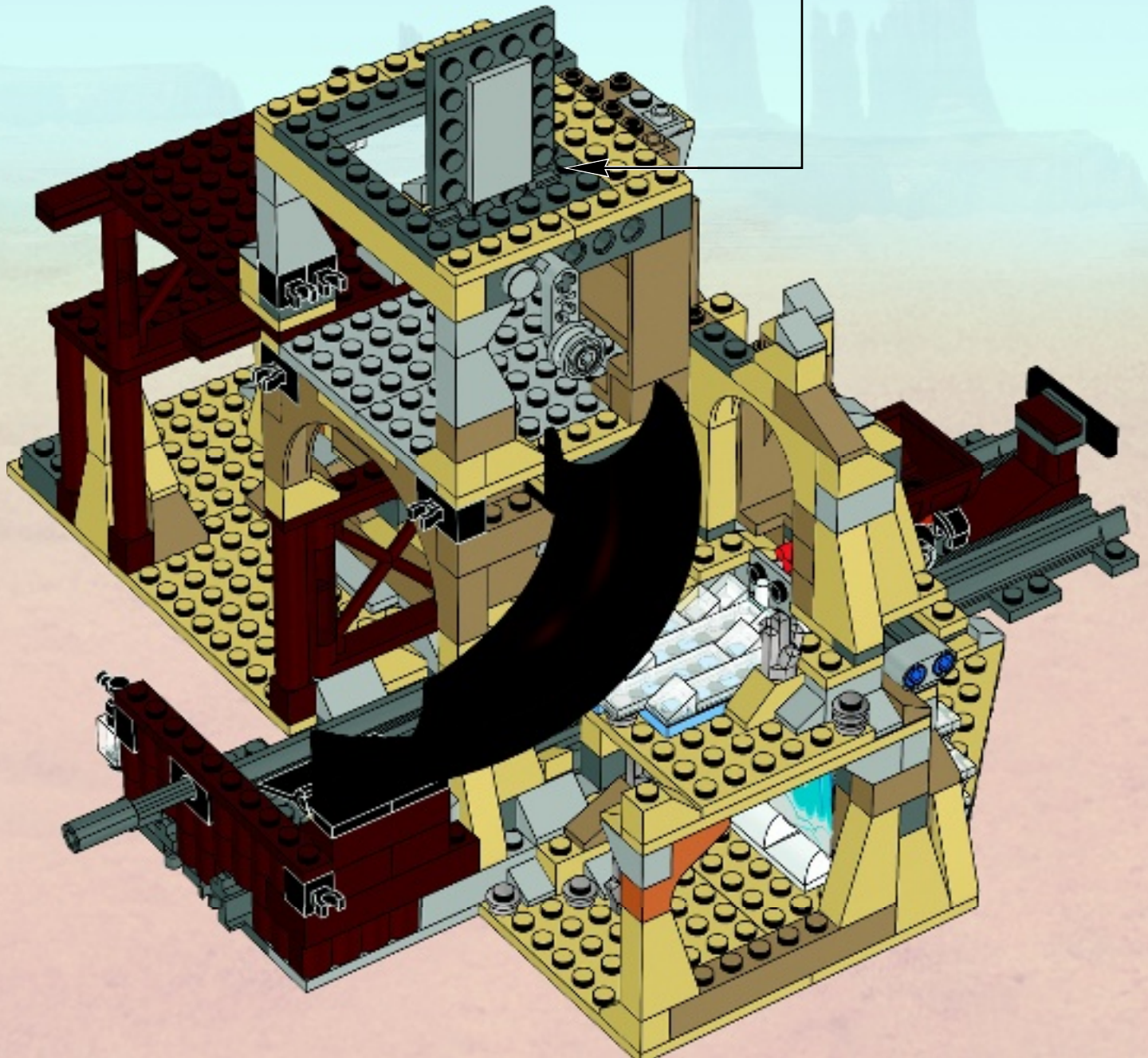
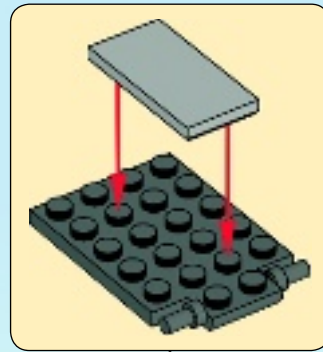

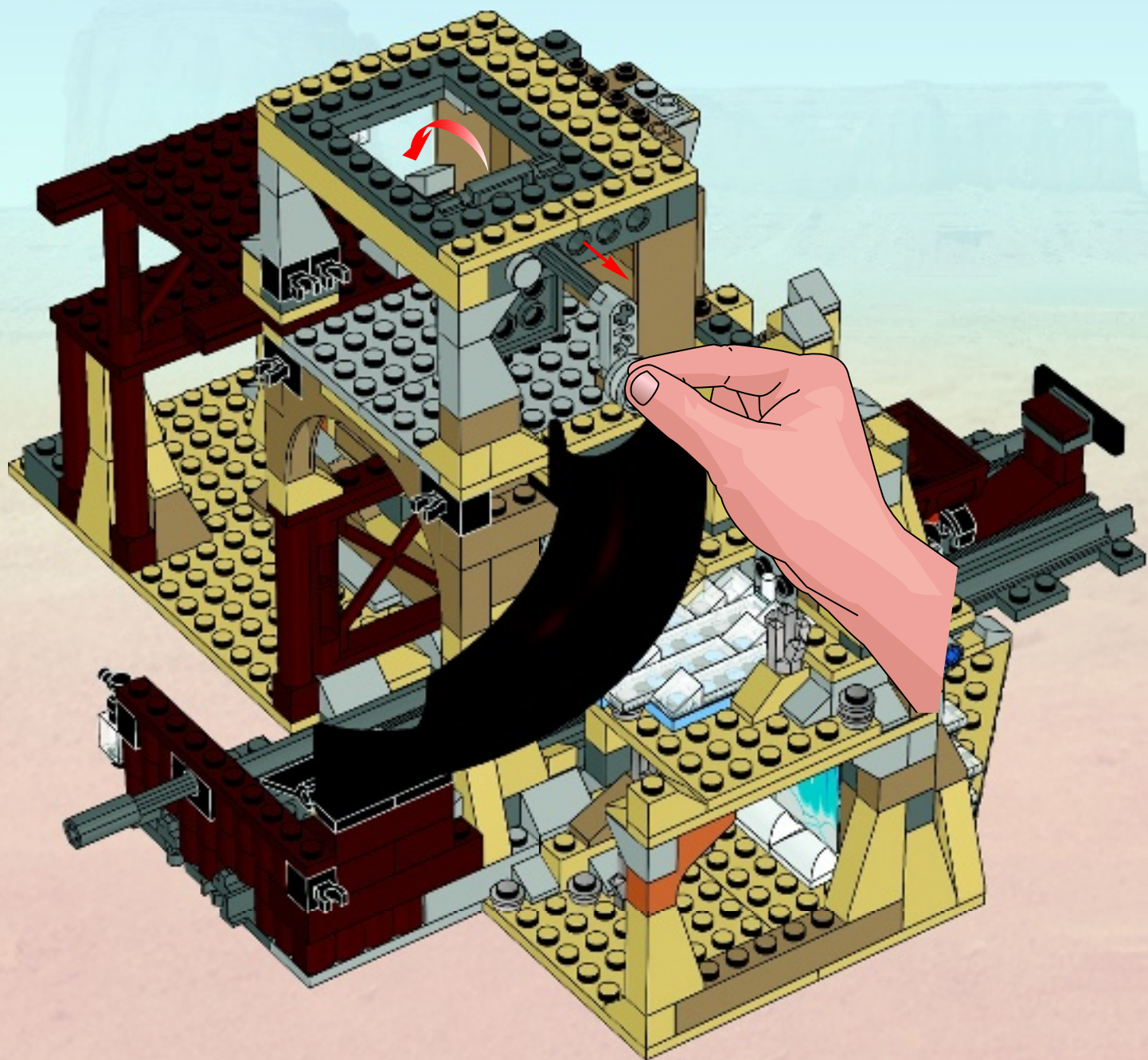



99

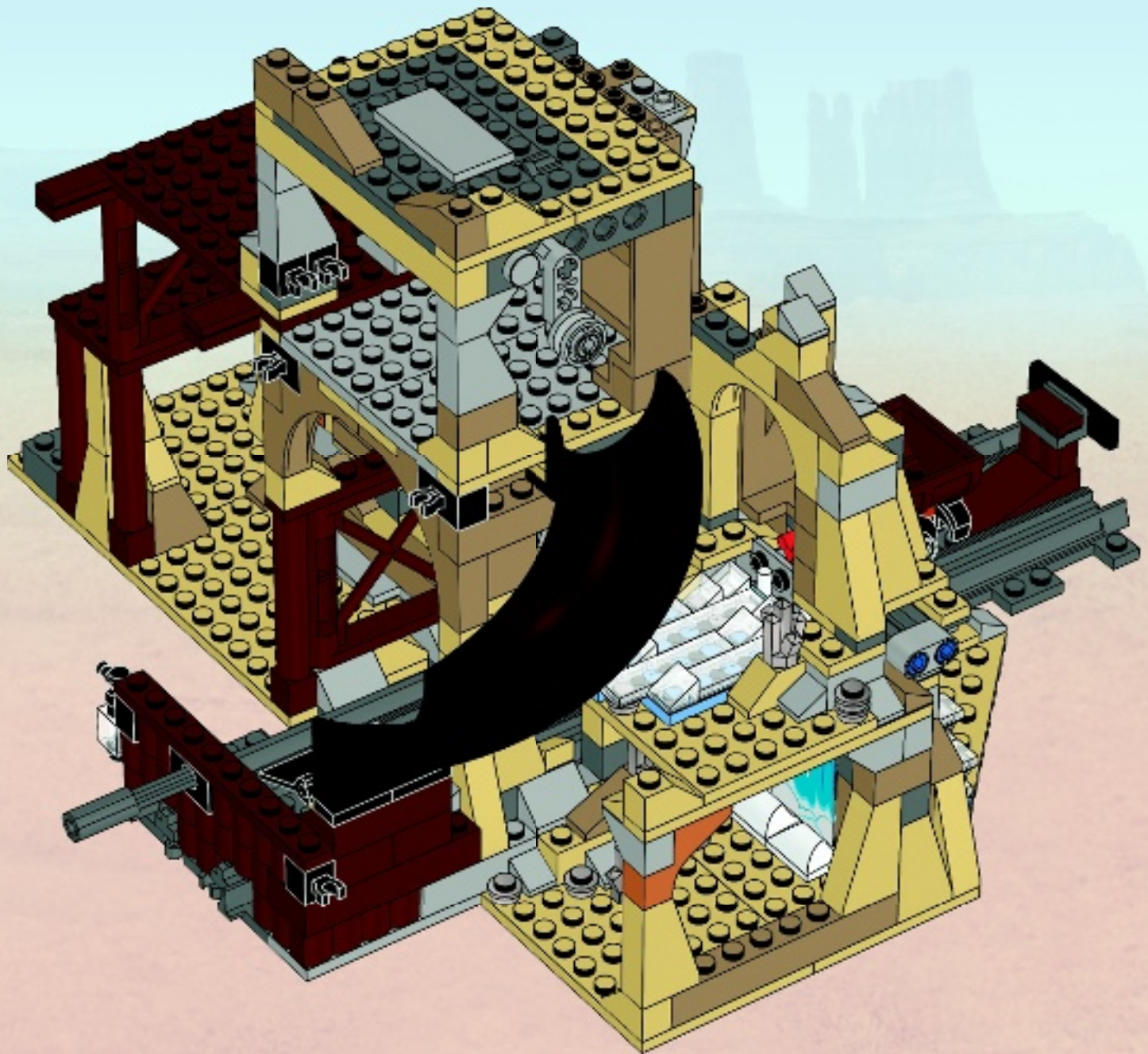

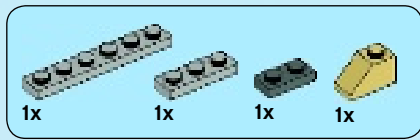

100

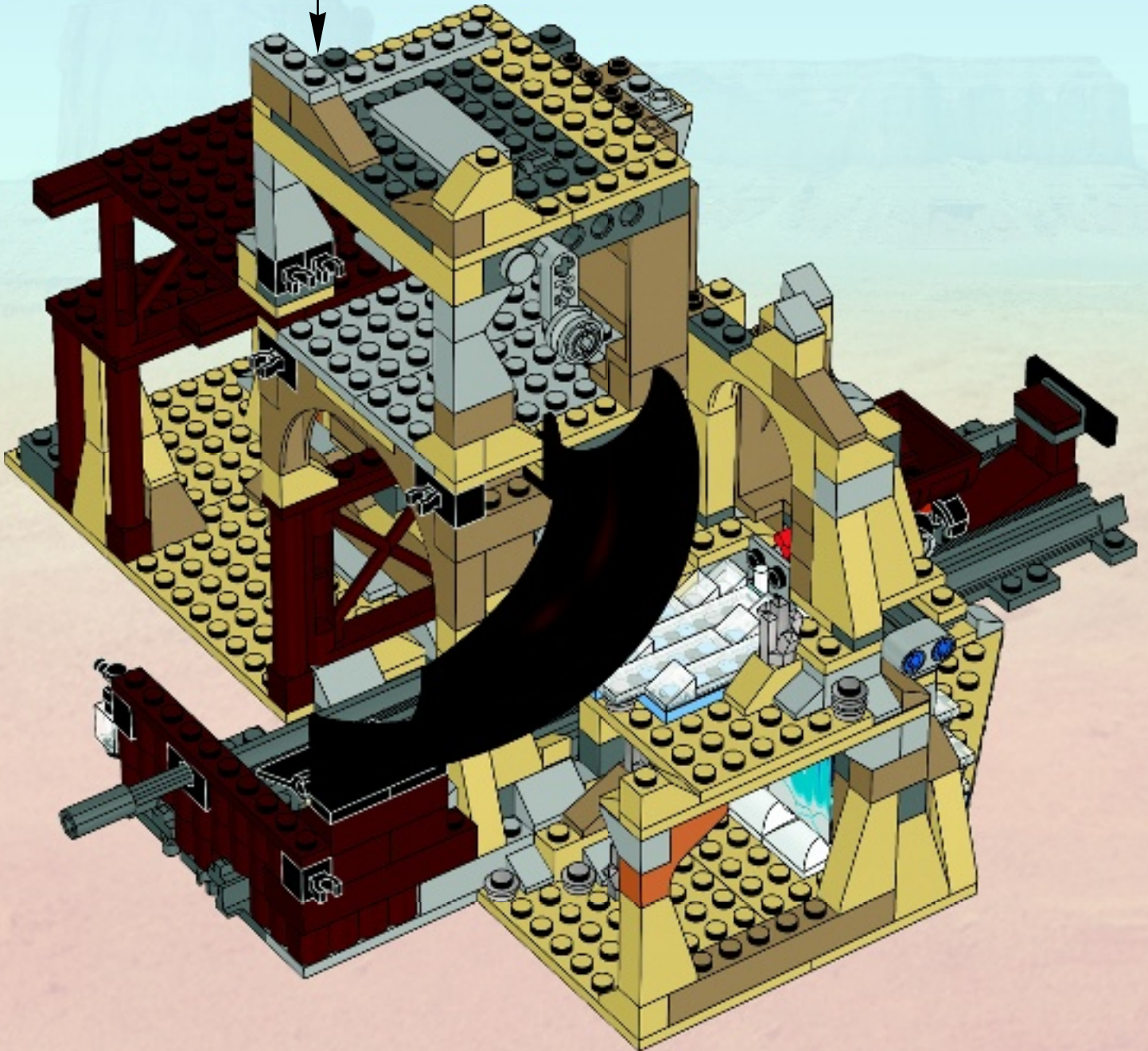

- 1x
- 1x
- 1x
- 1x

101

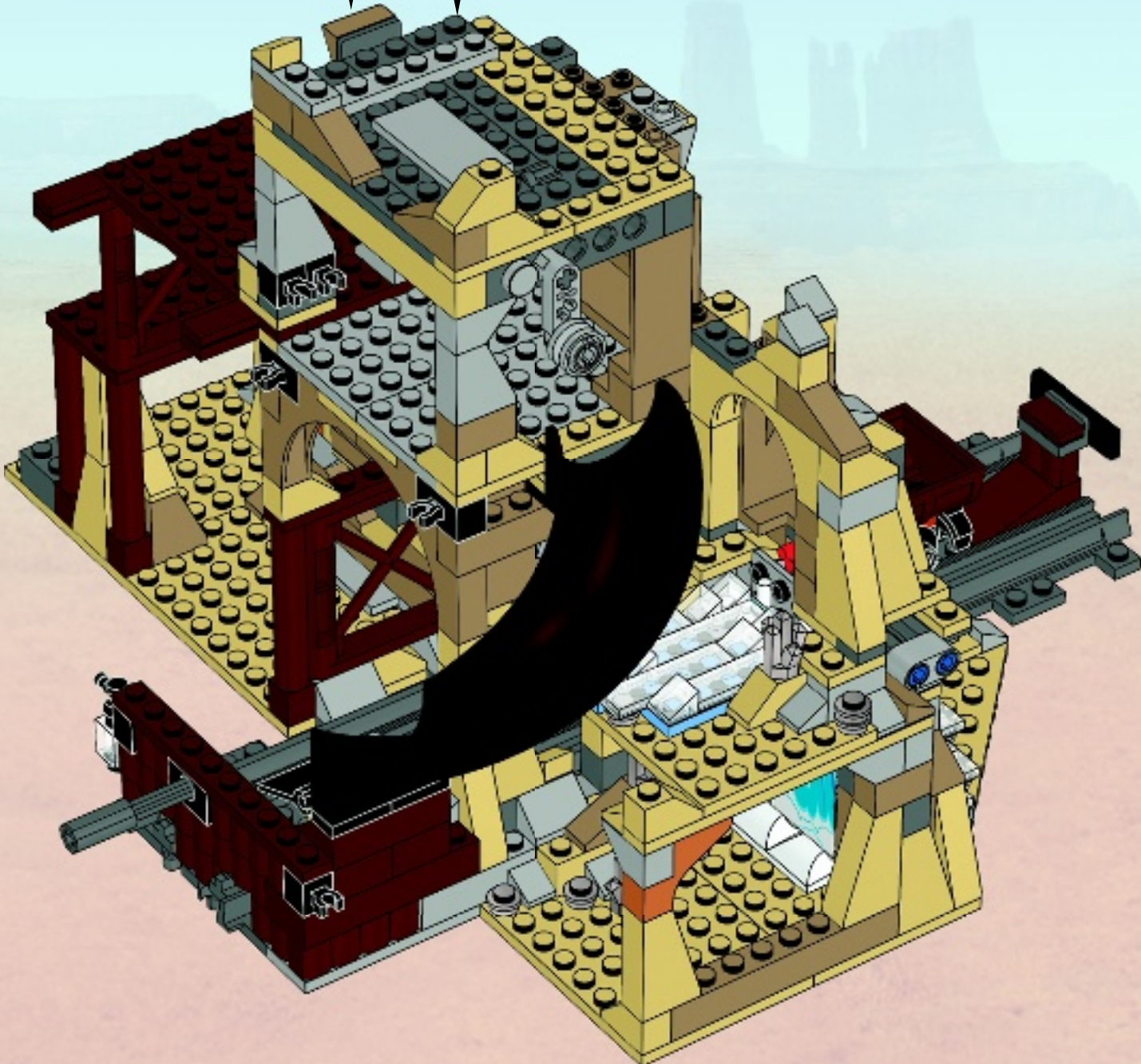
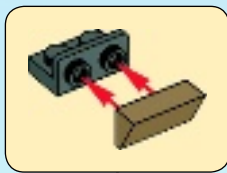

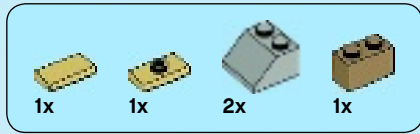

102

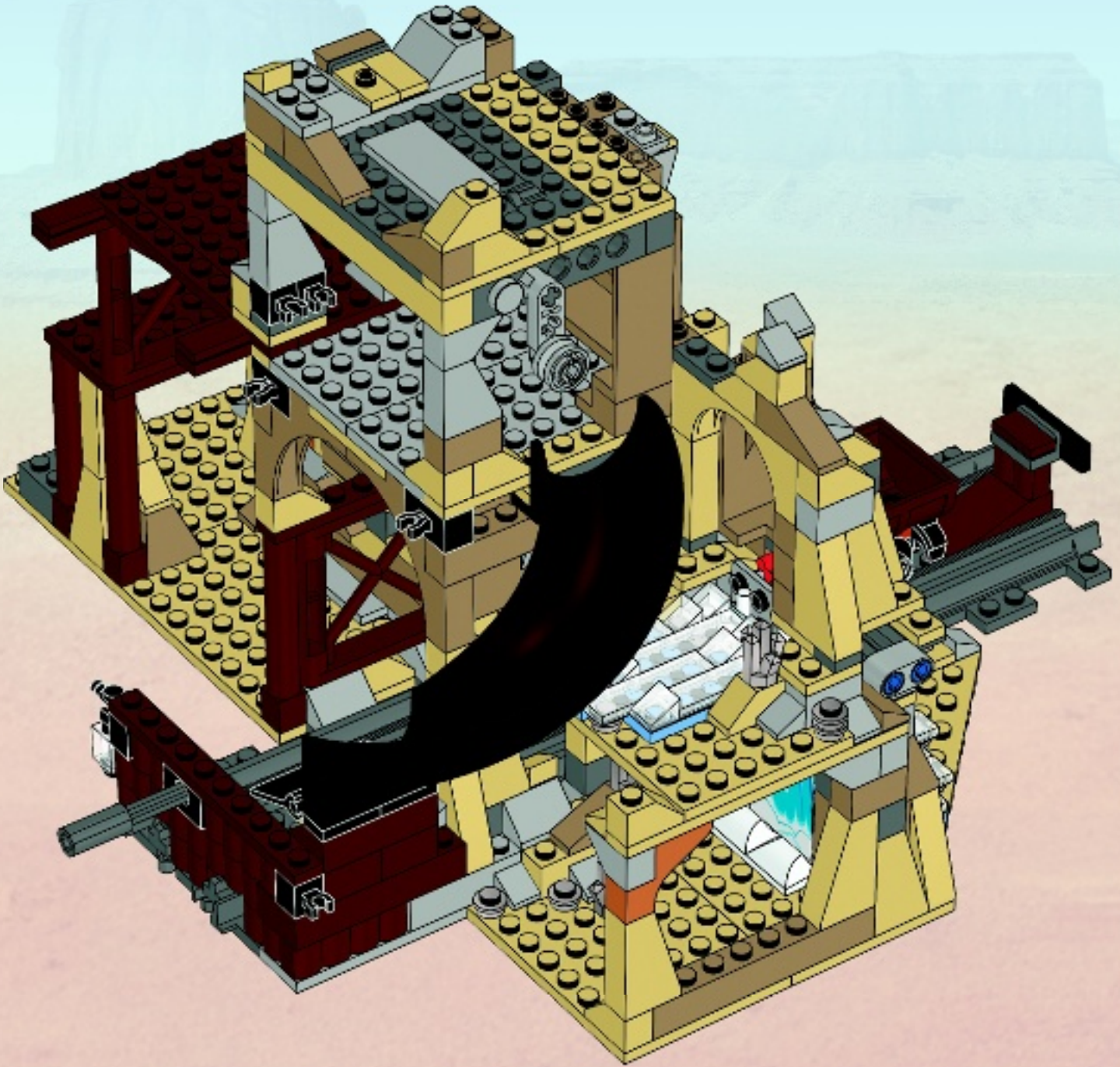



103

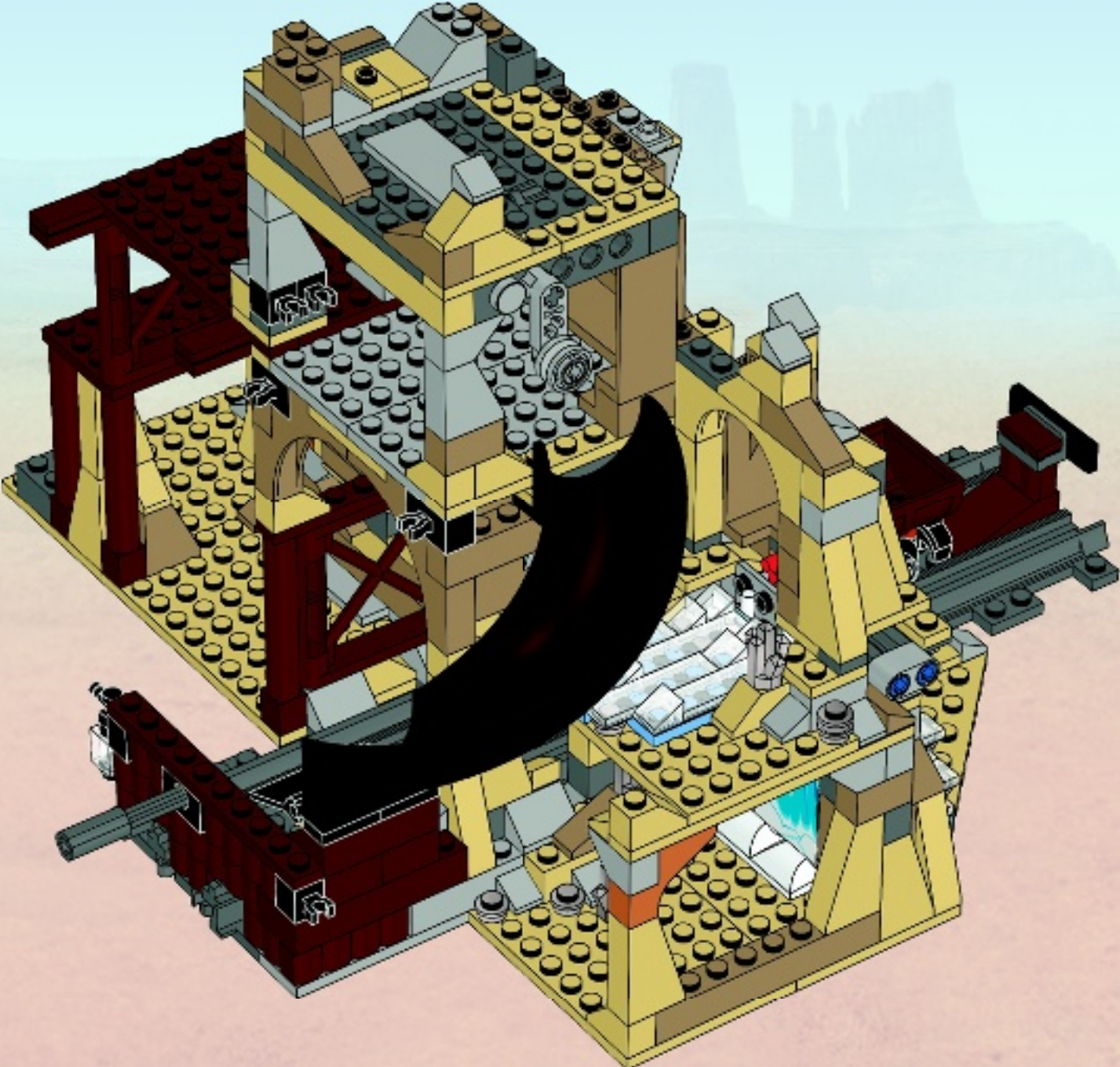



2x

104





1x



1x

105



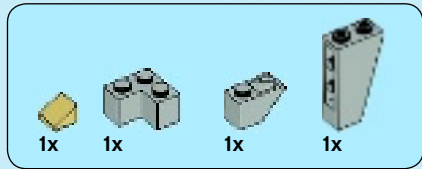

106



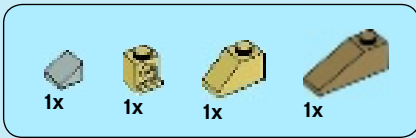

107

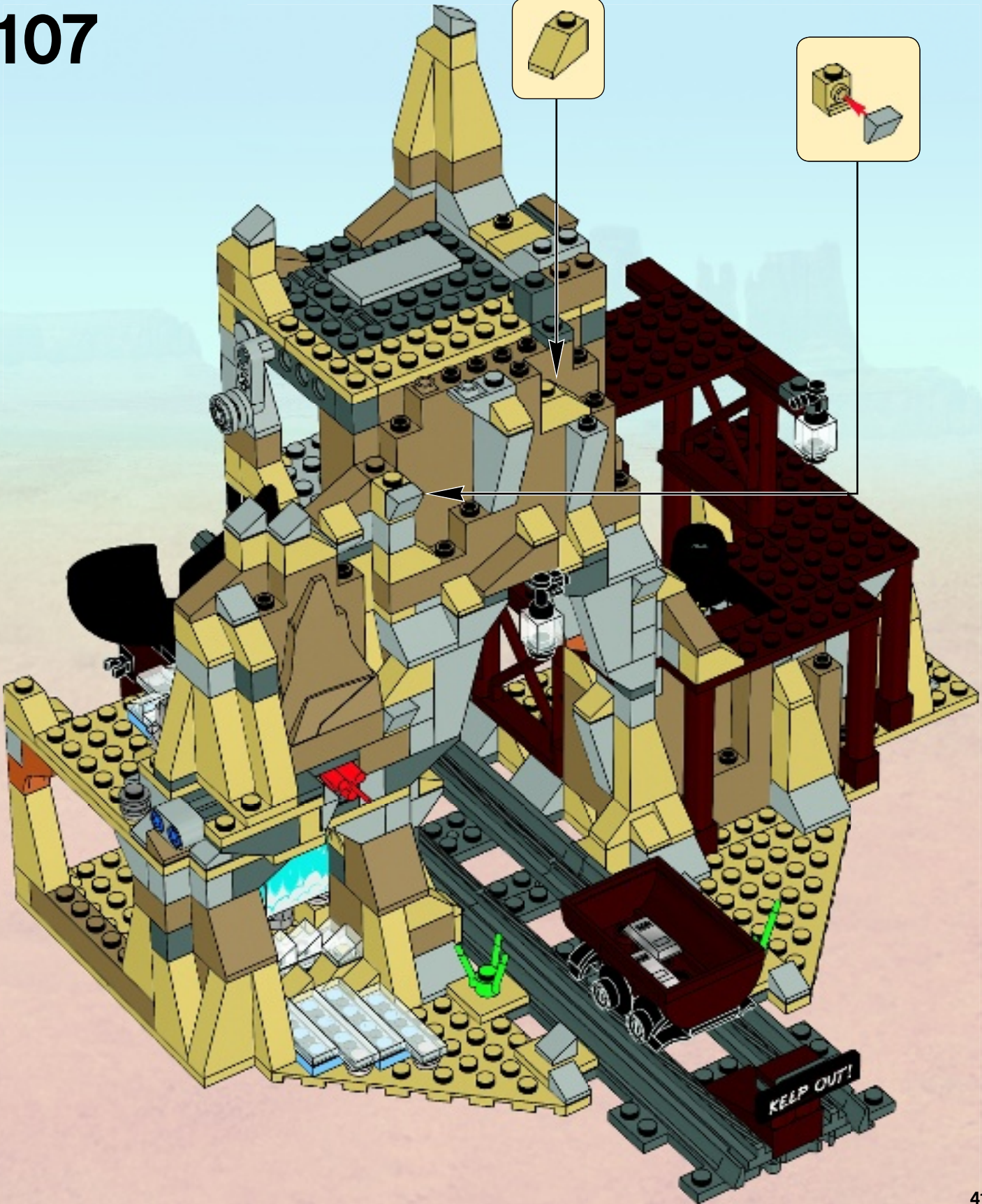
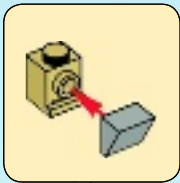
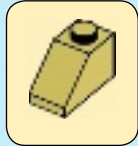



108

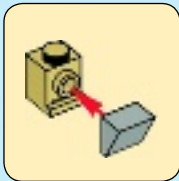



1x



1x

109

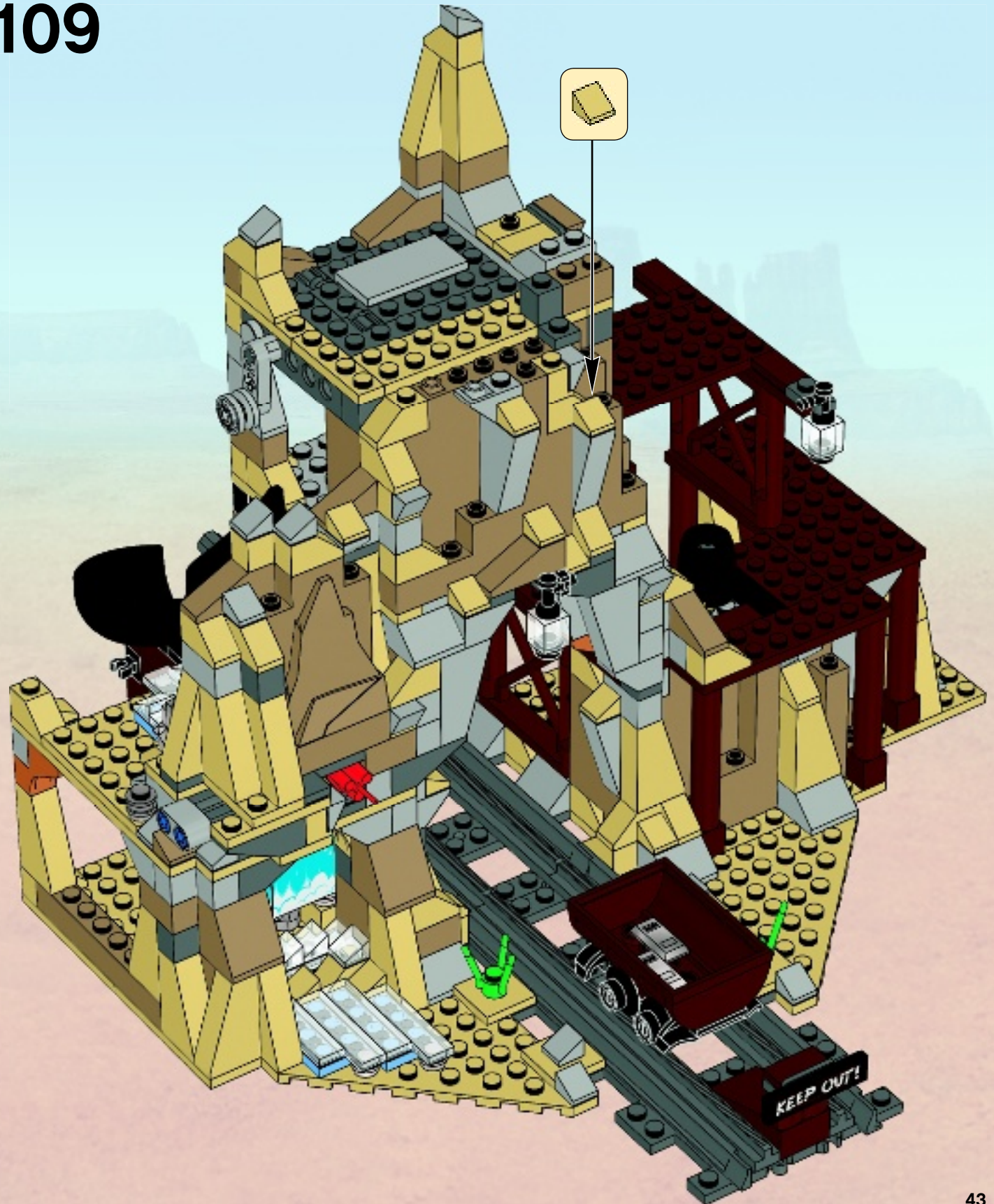



1x



1x

110

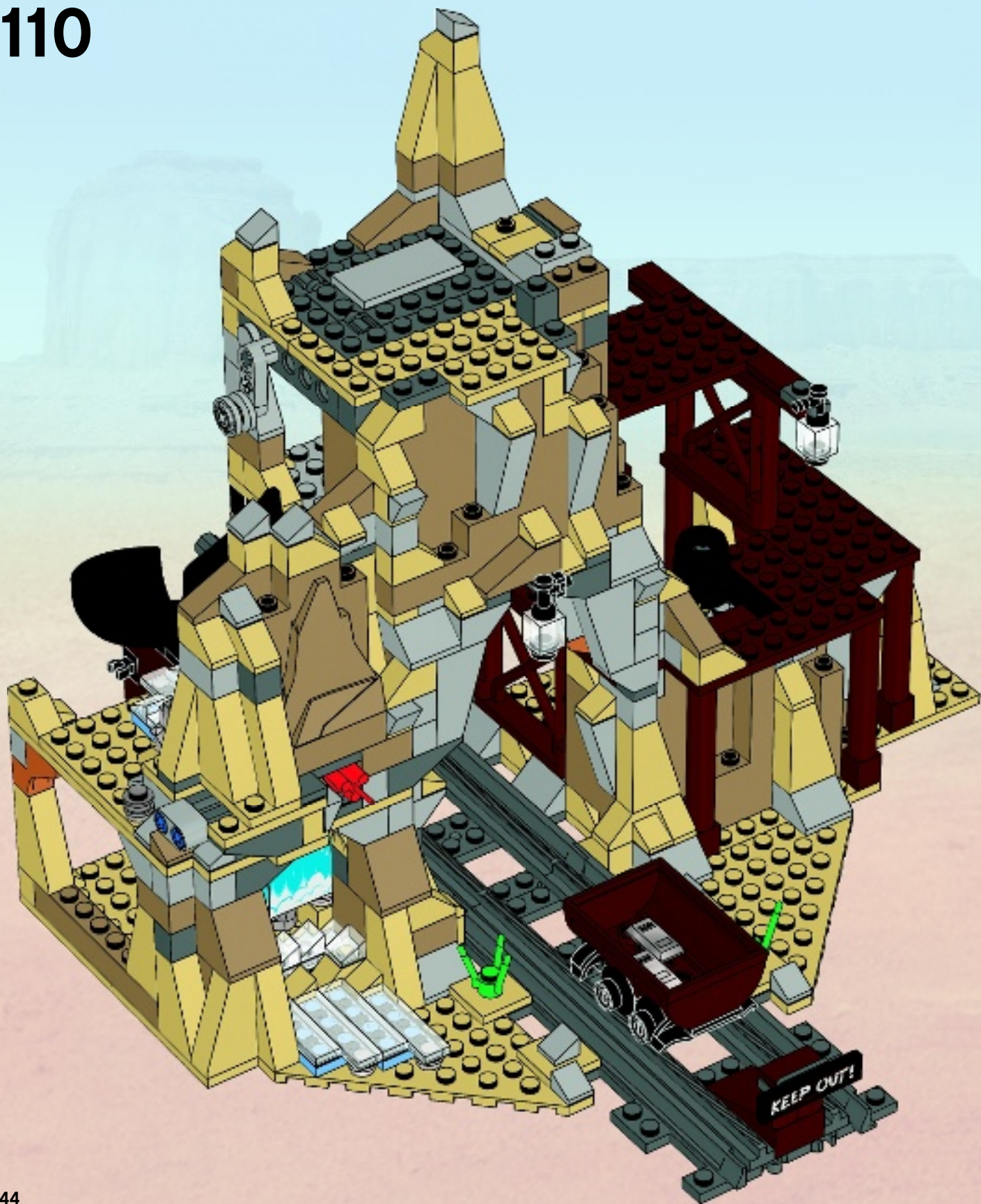

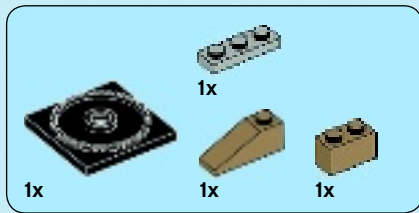

111

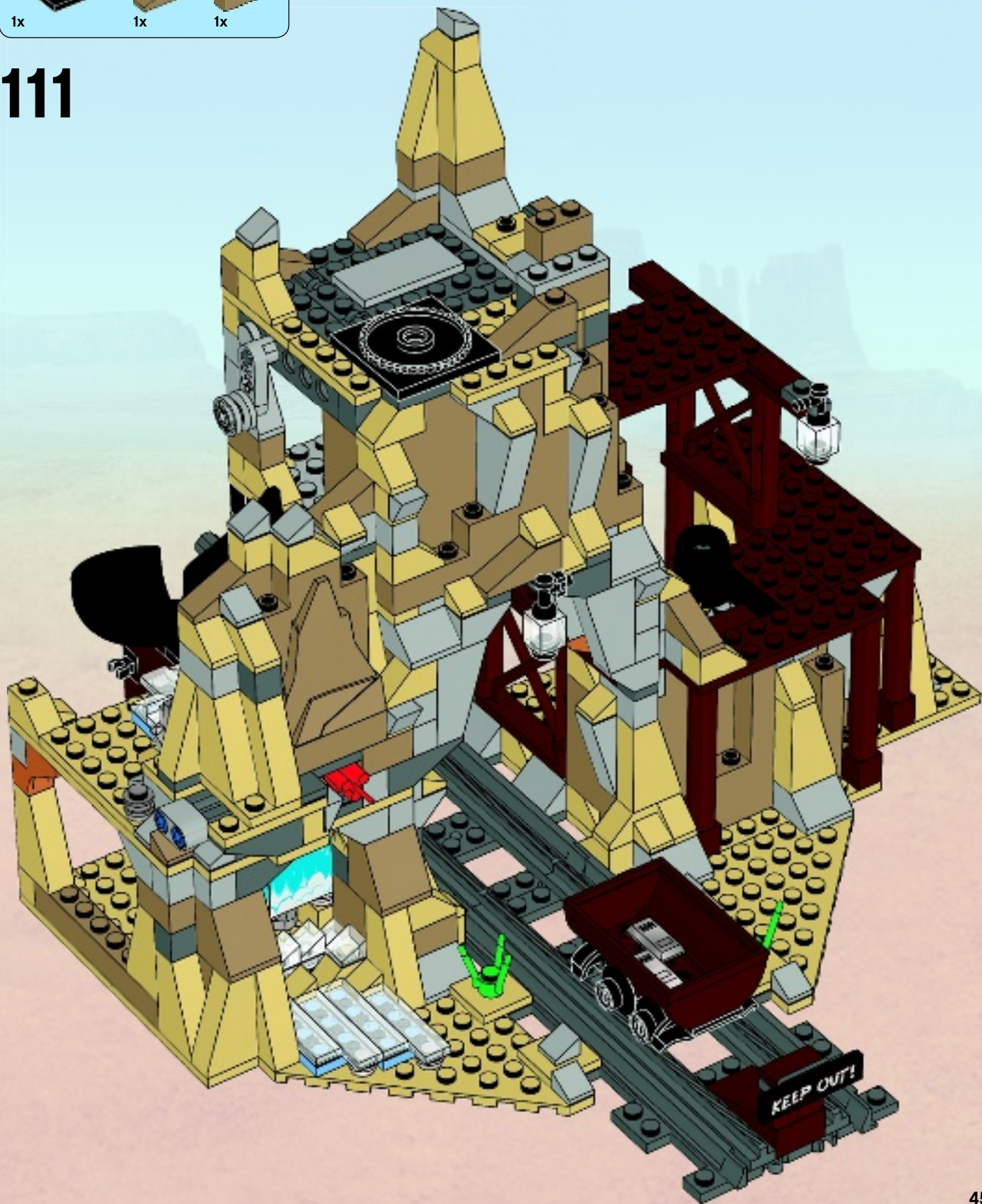

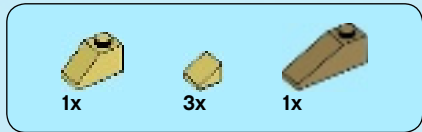

112

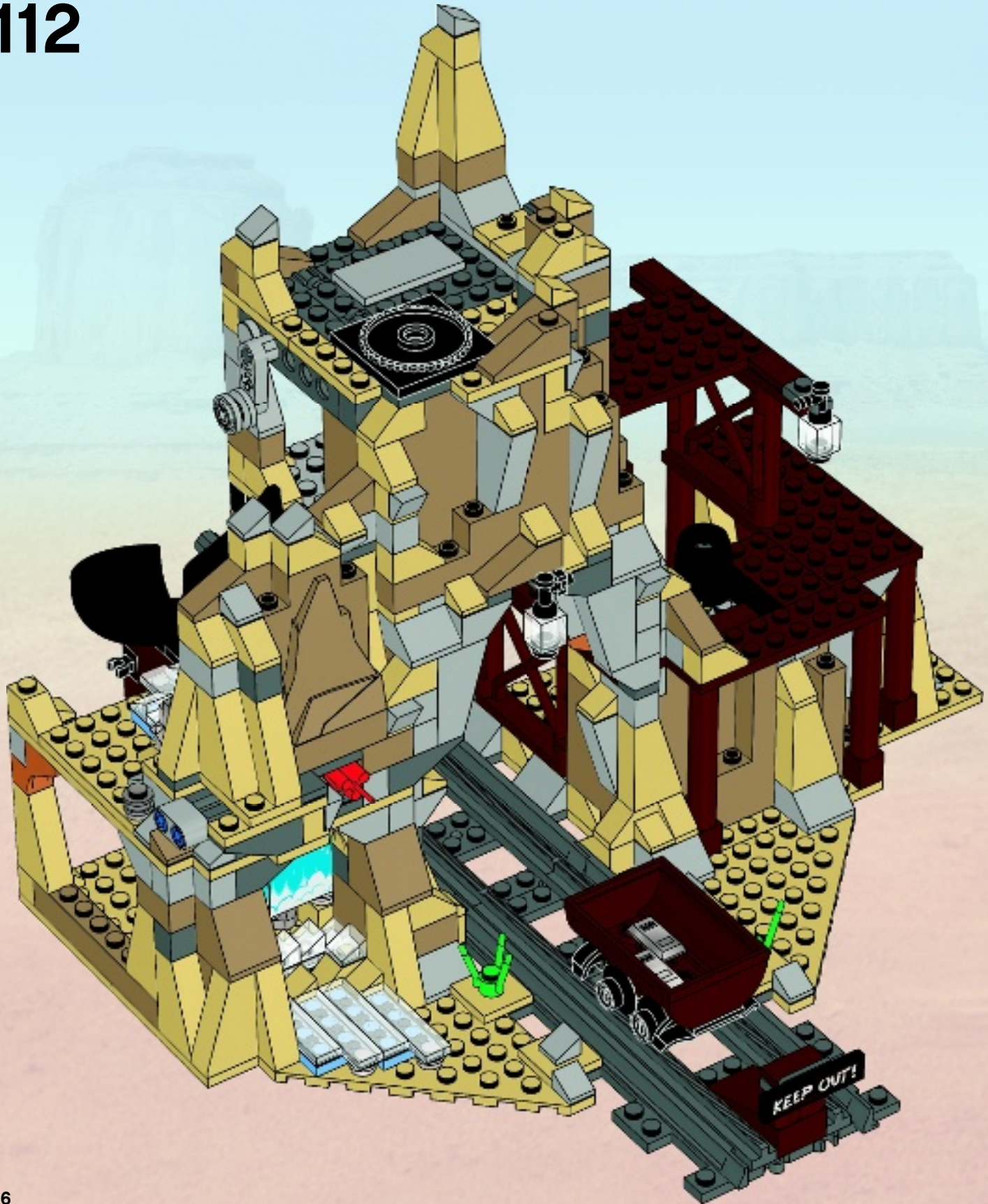

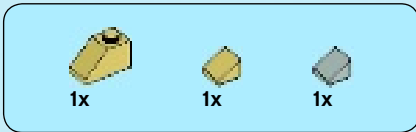

113

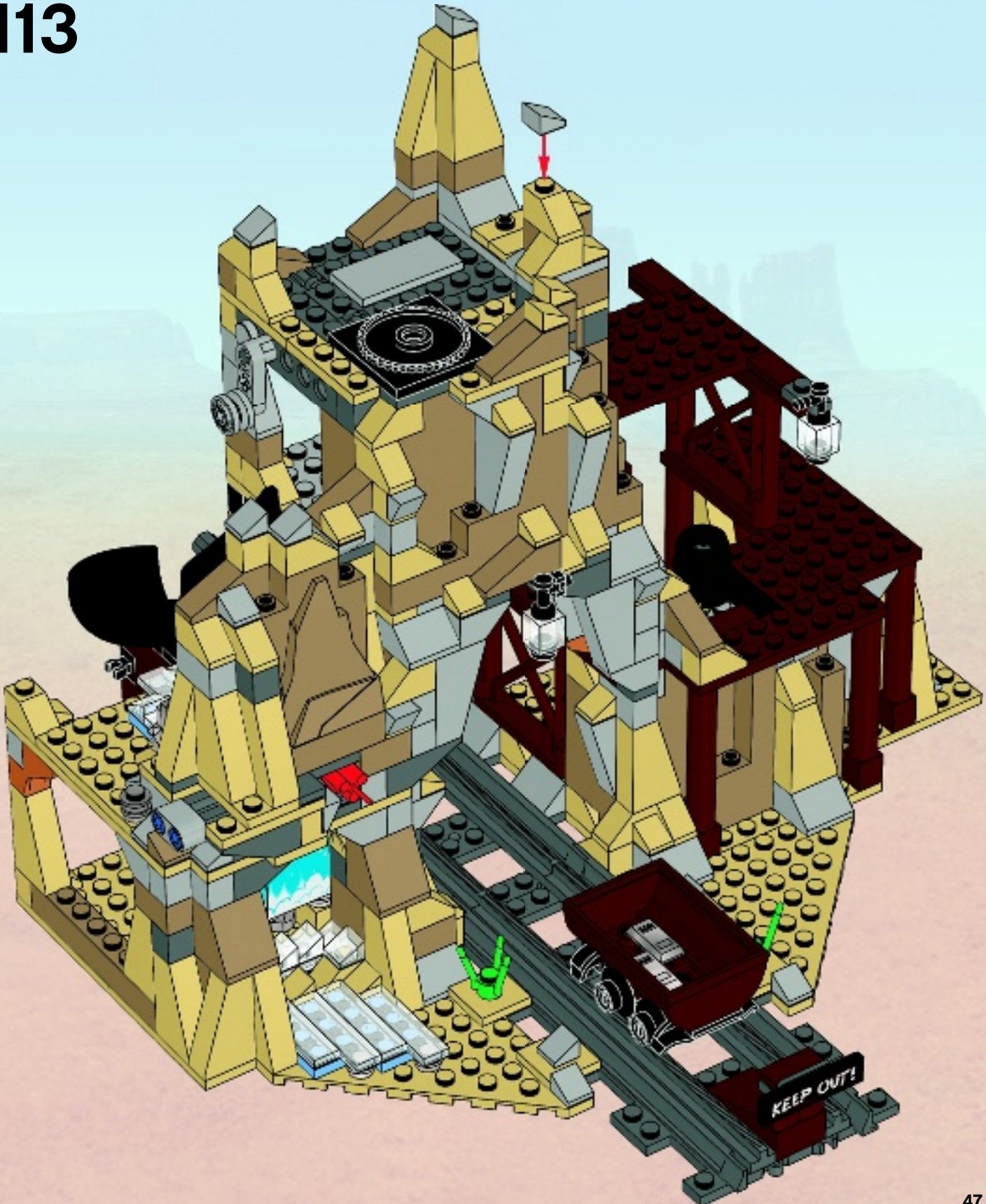

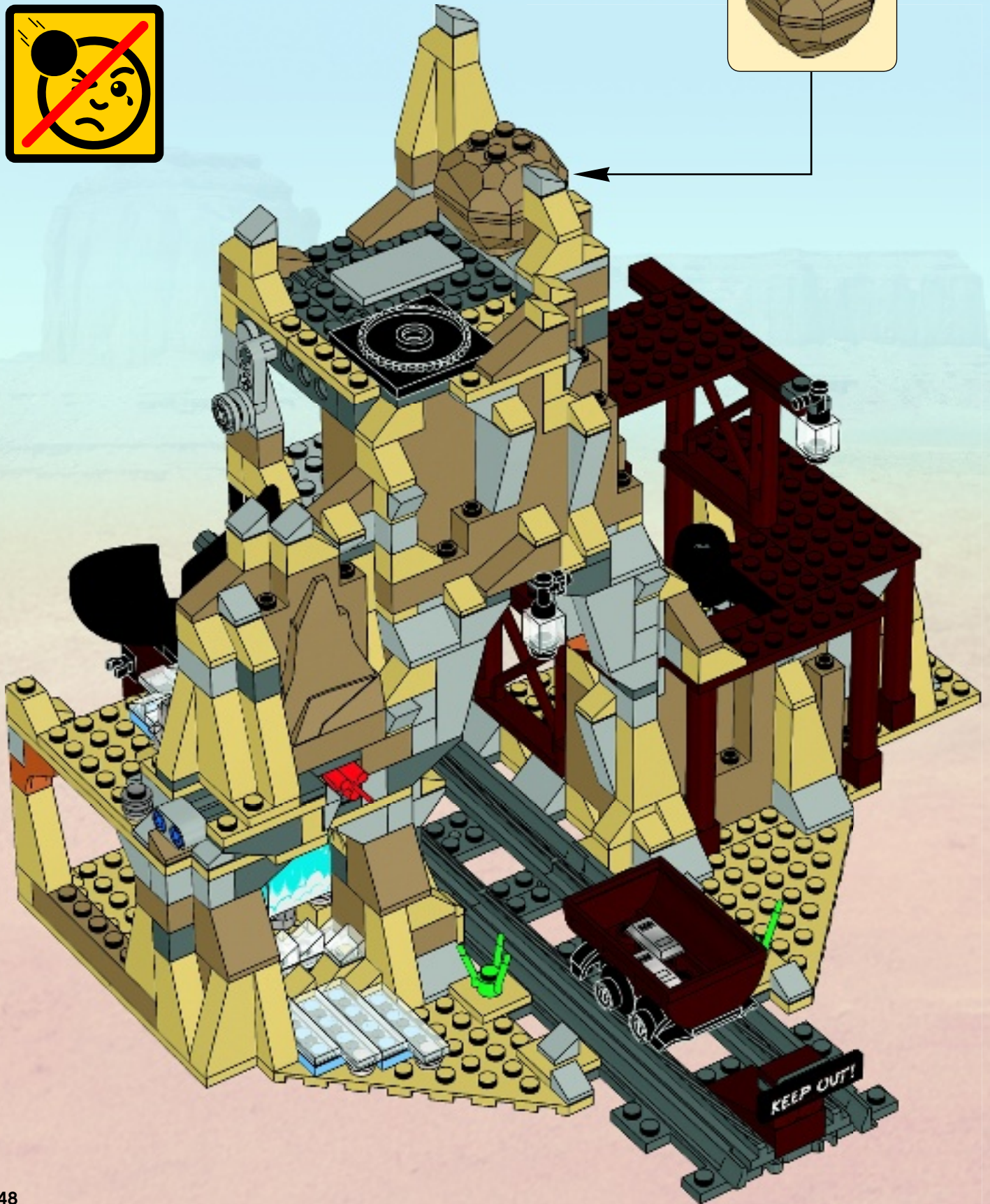

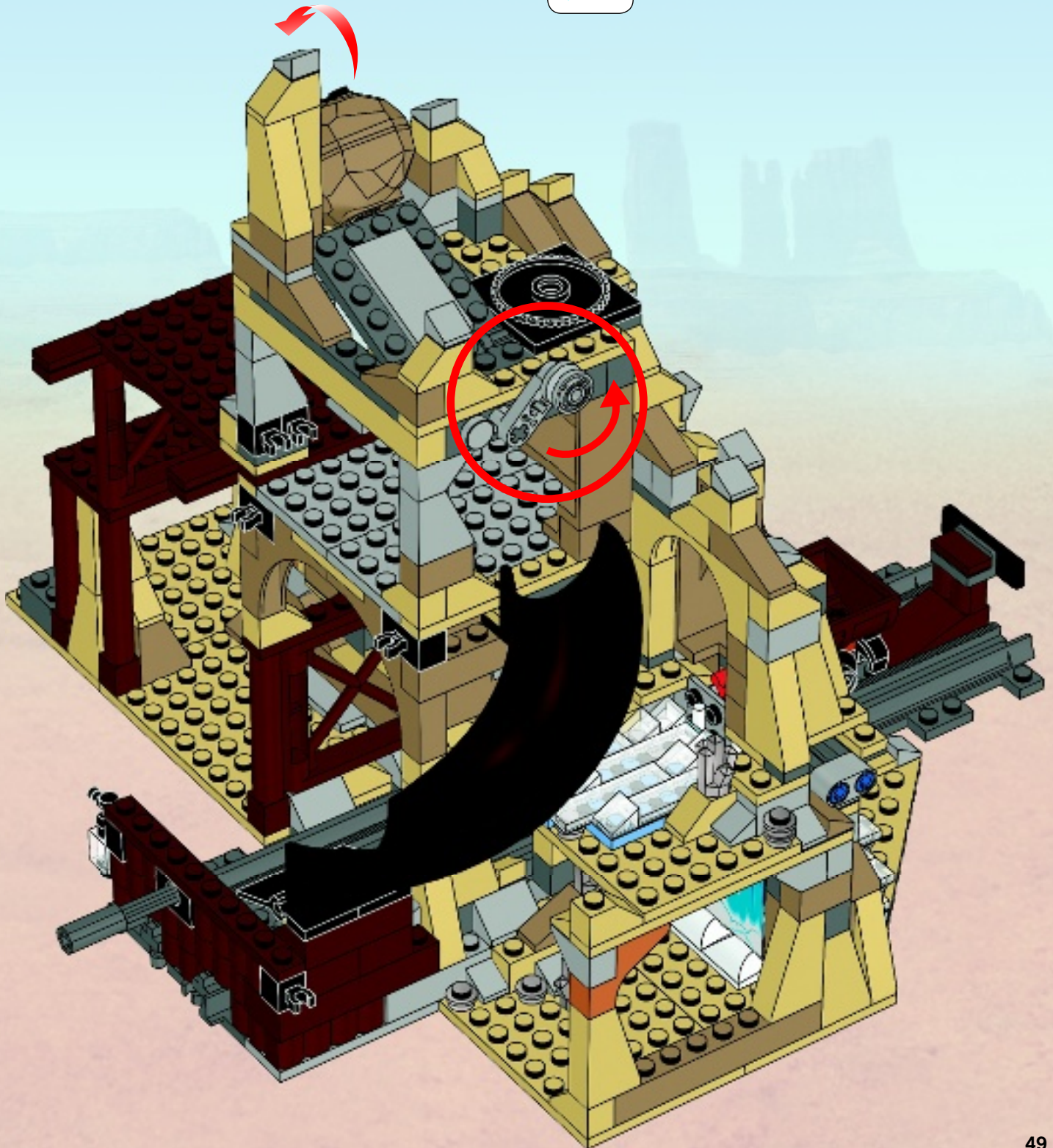
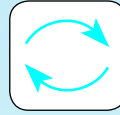

115

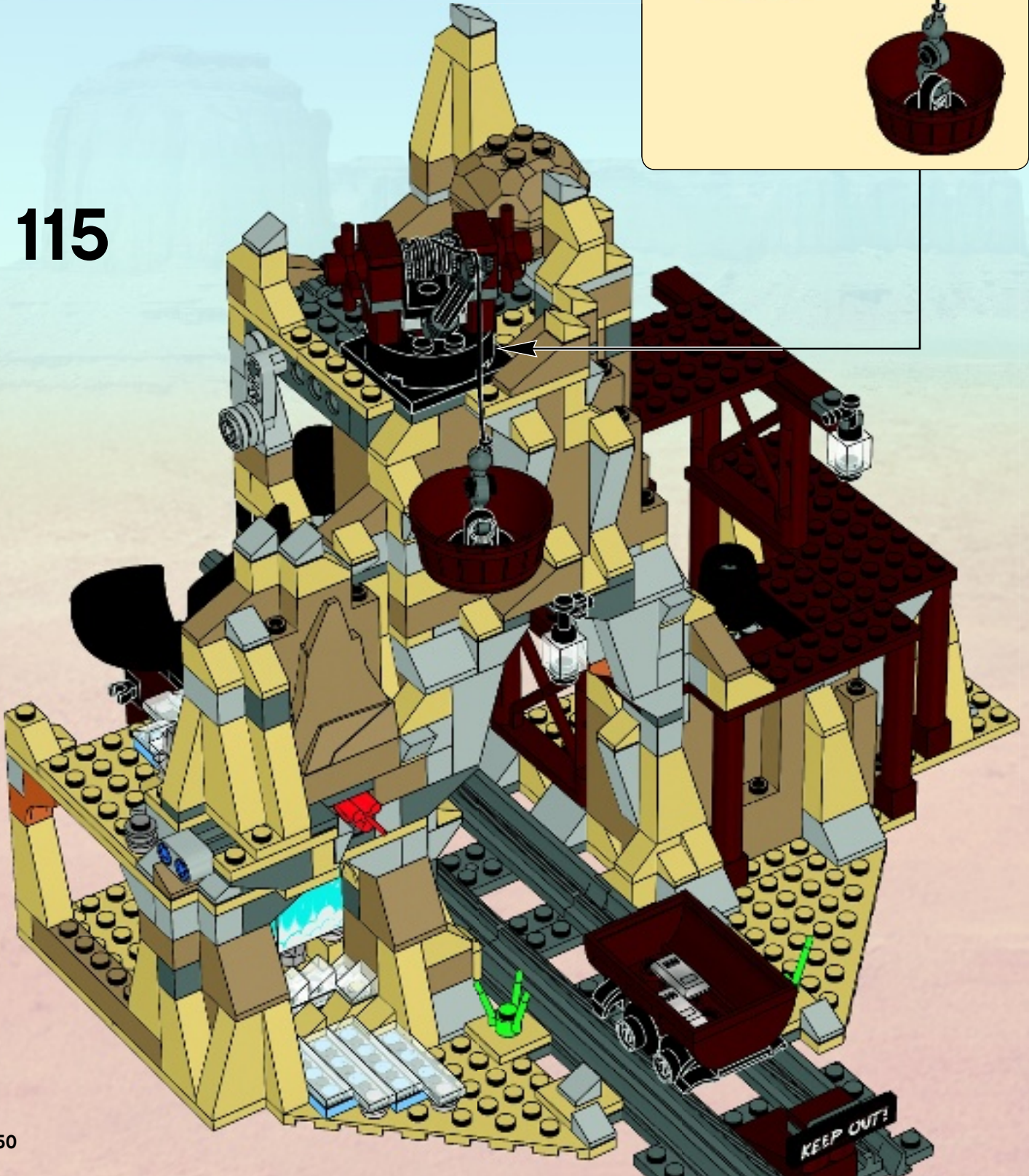
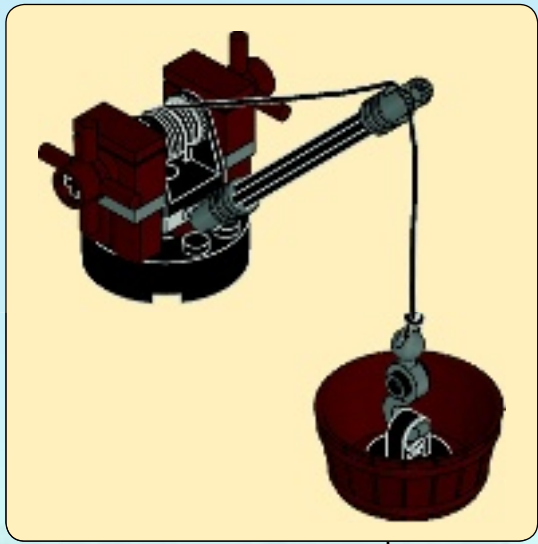

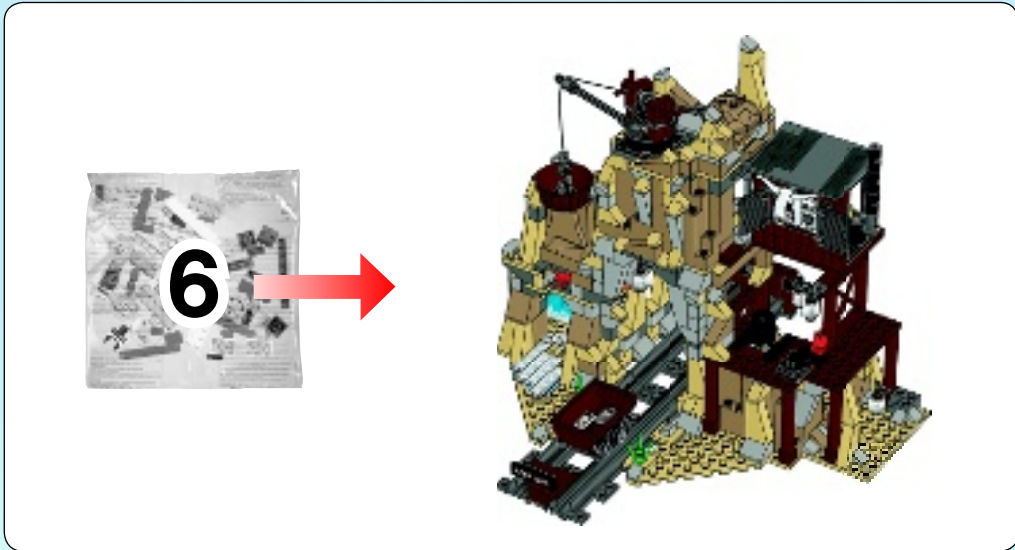

116

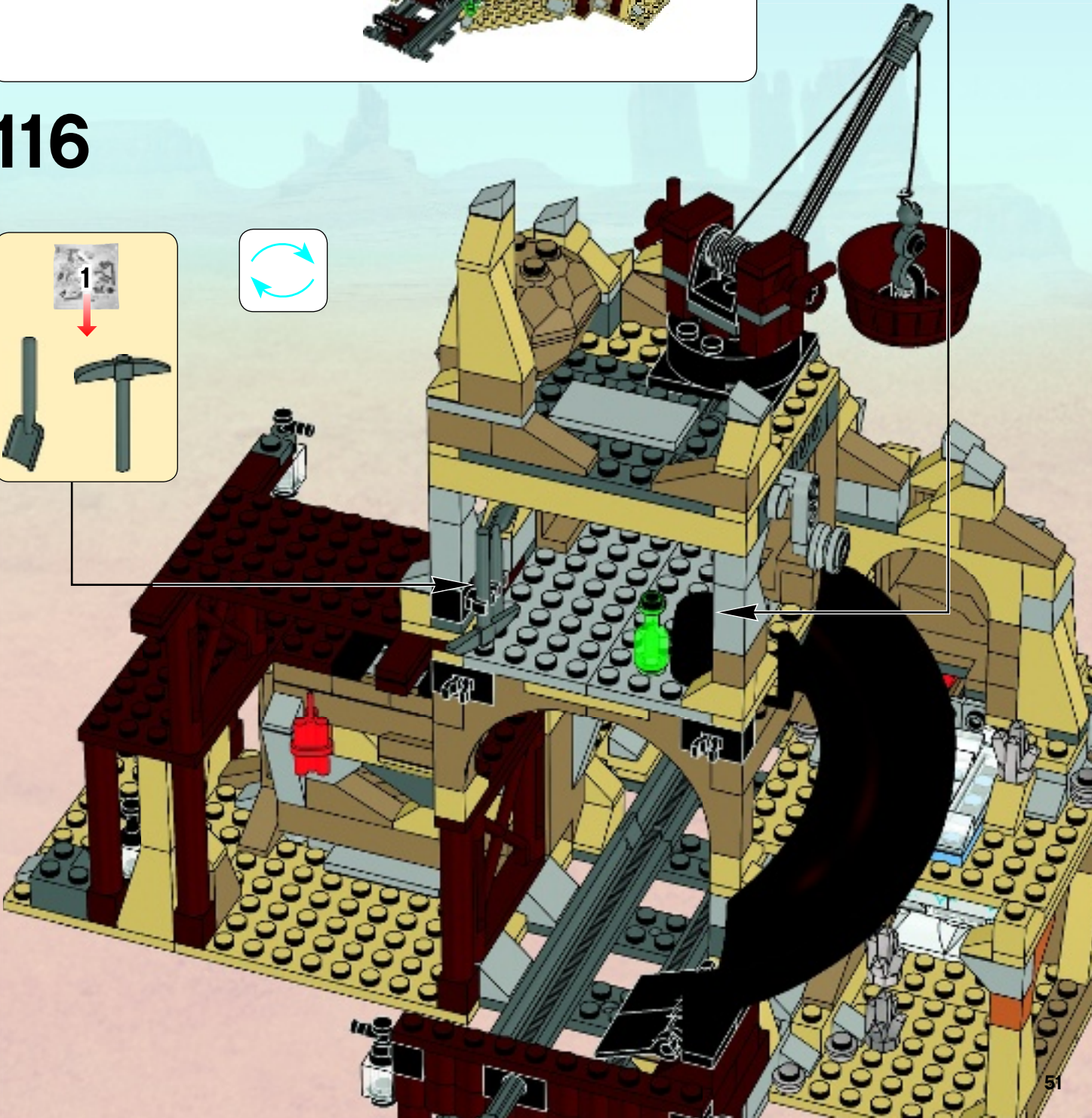
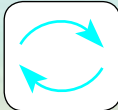
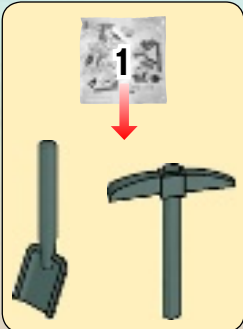





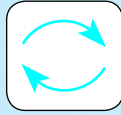

2x

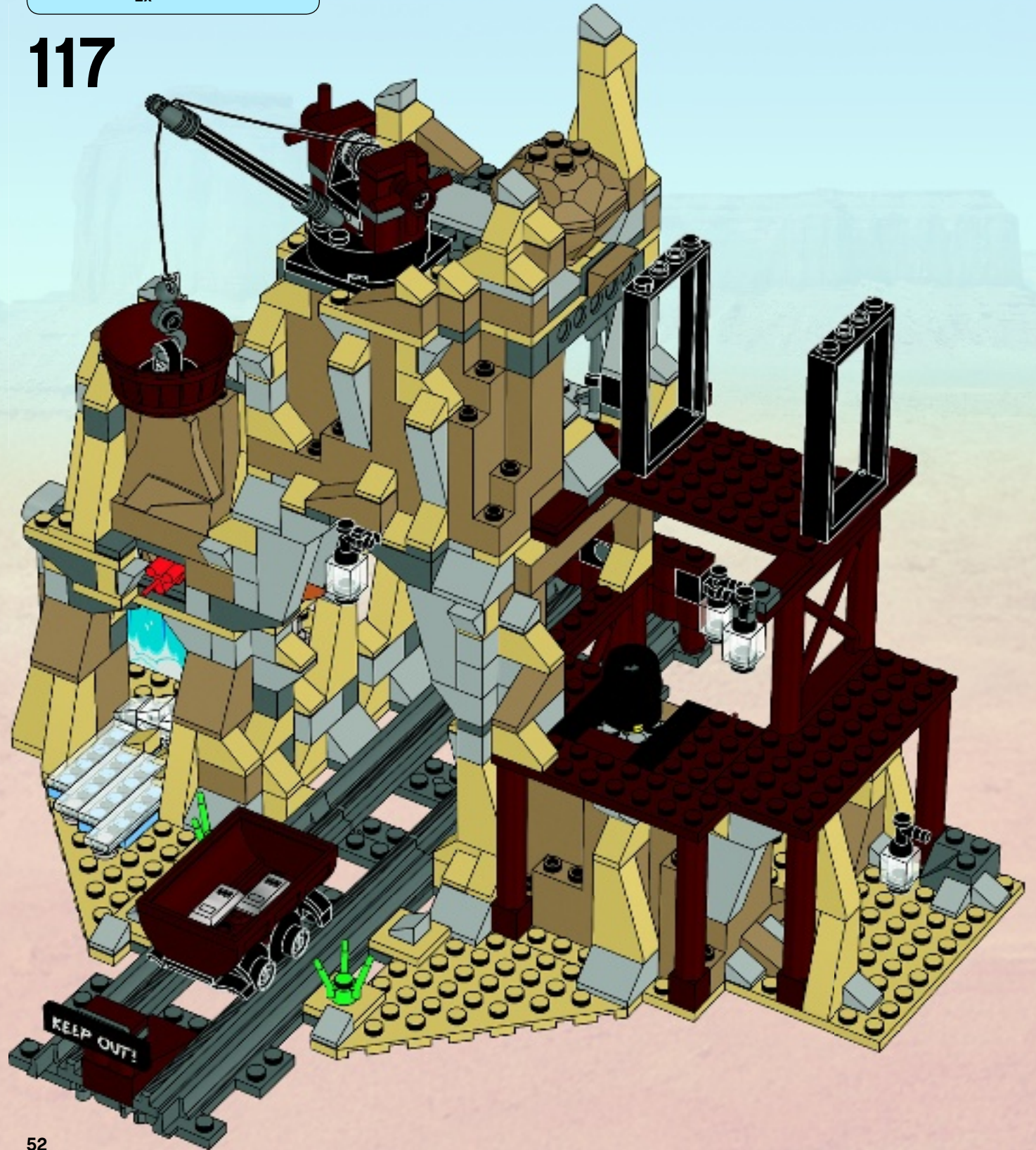

117



		
2x	2x	1x

118

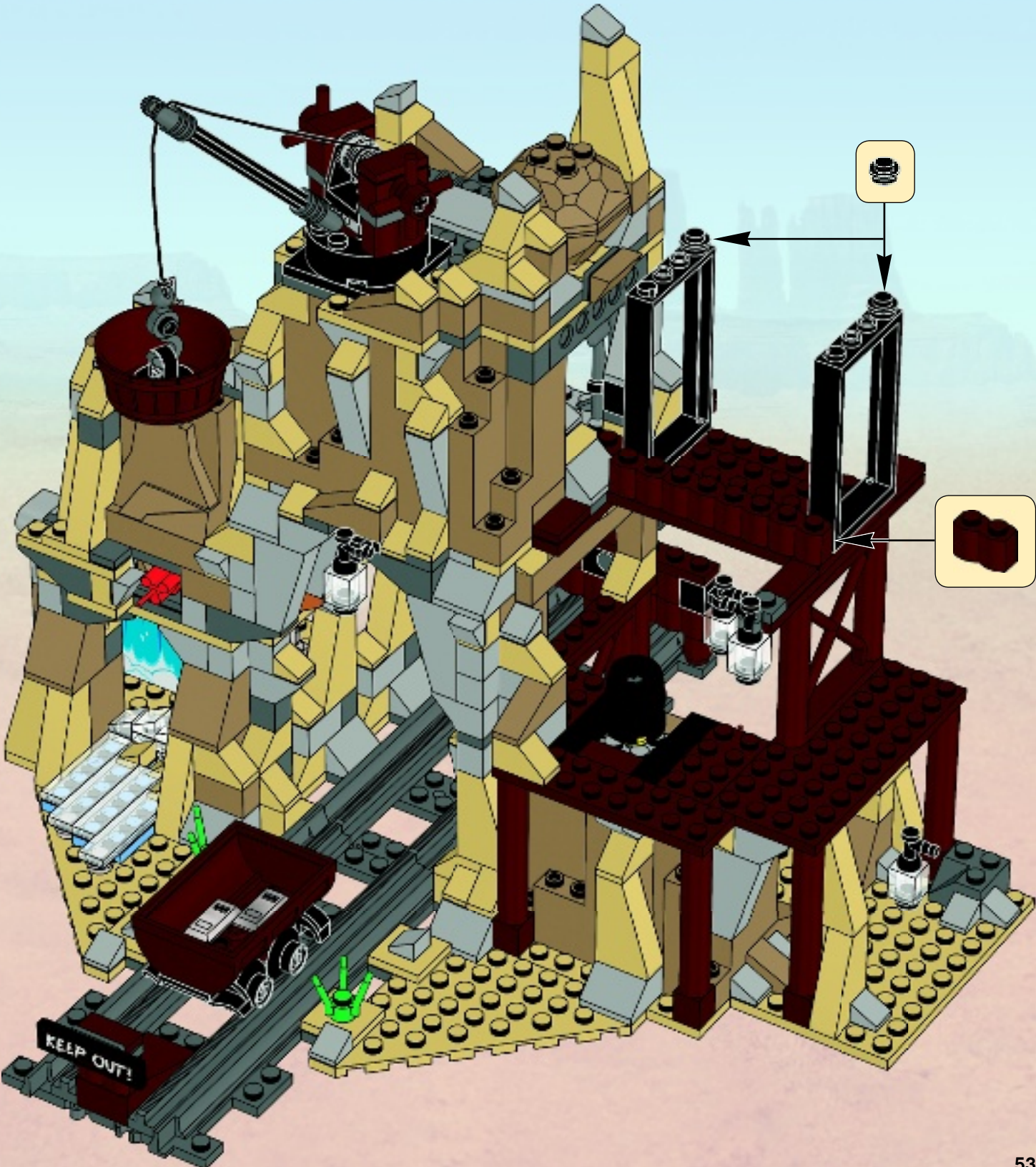

6

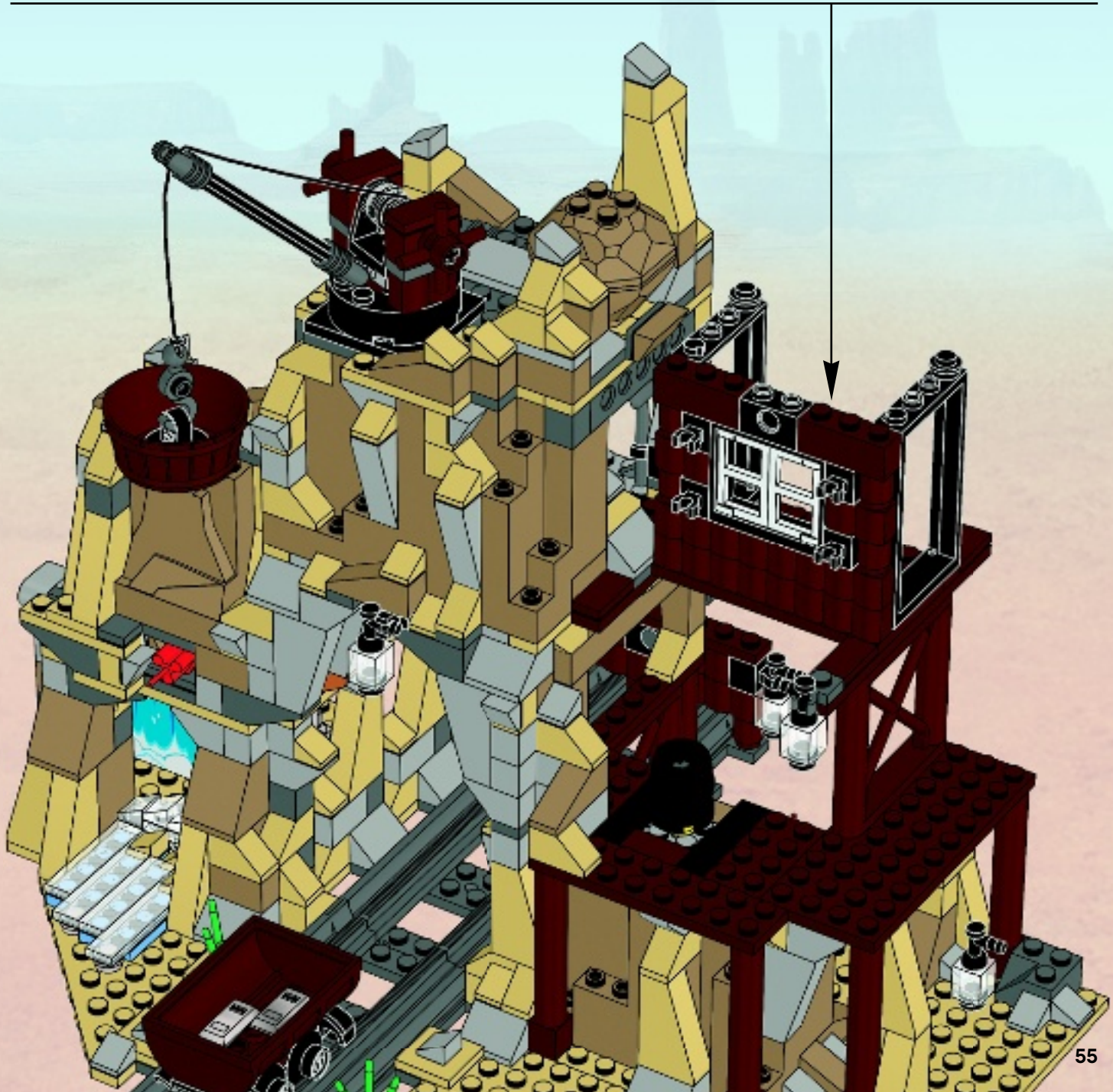
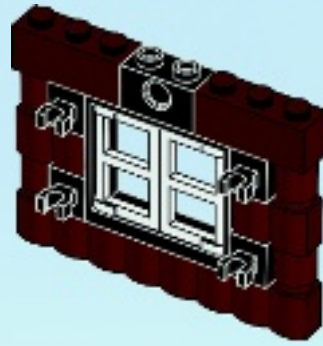

120

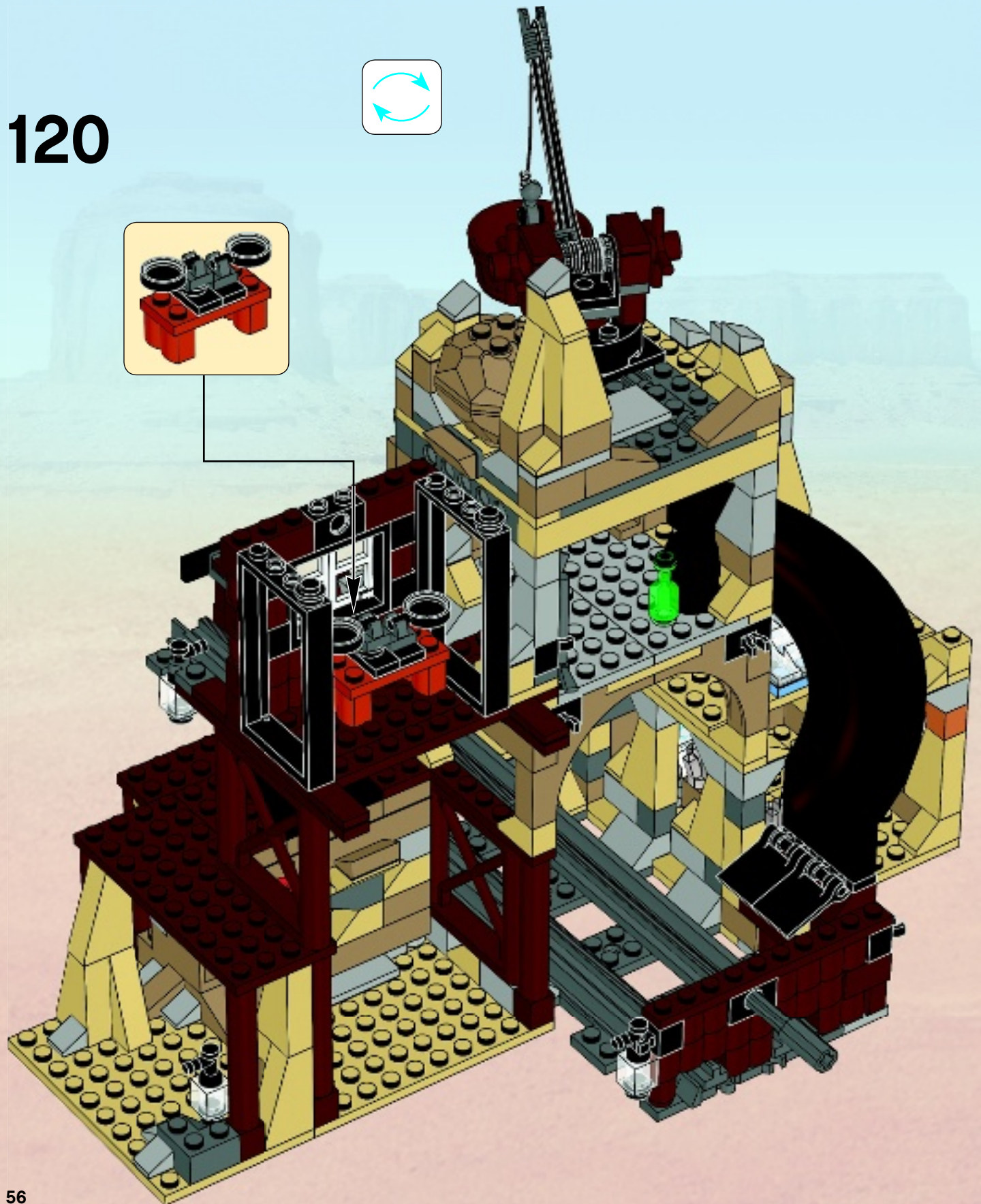
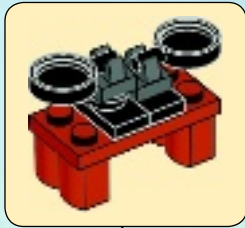
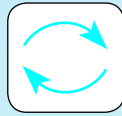

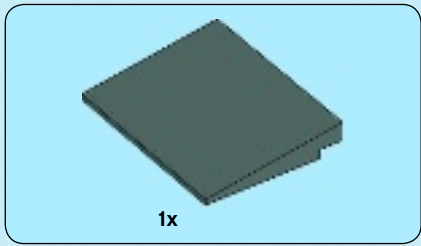

121

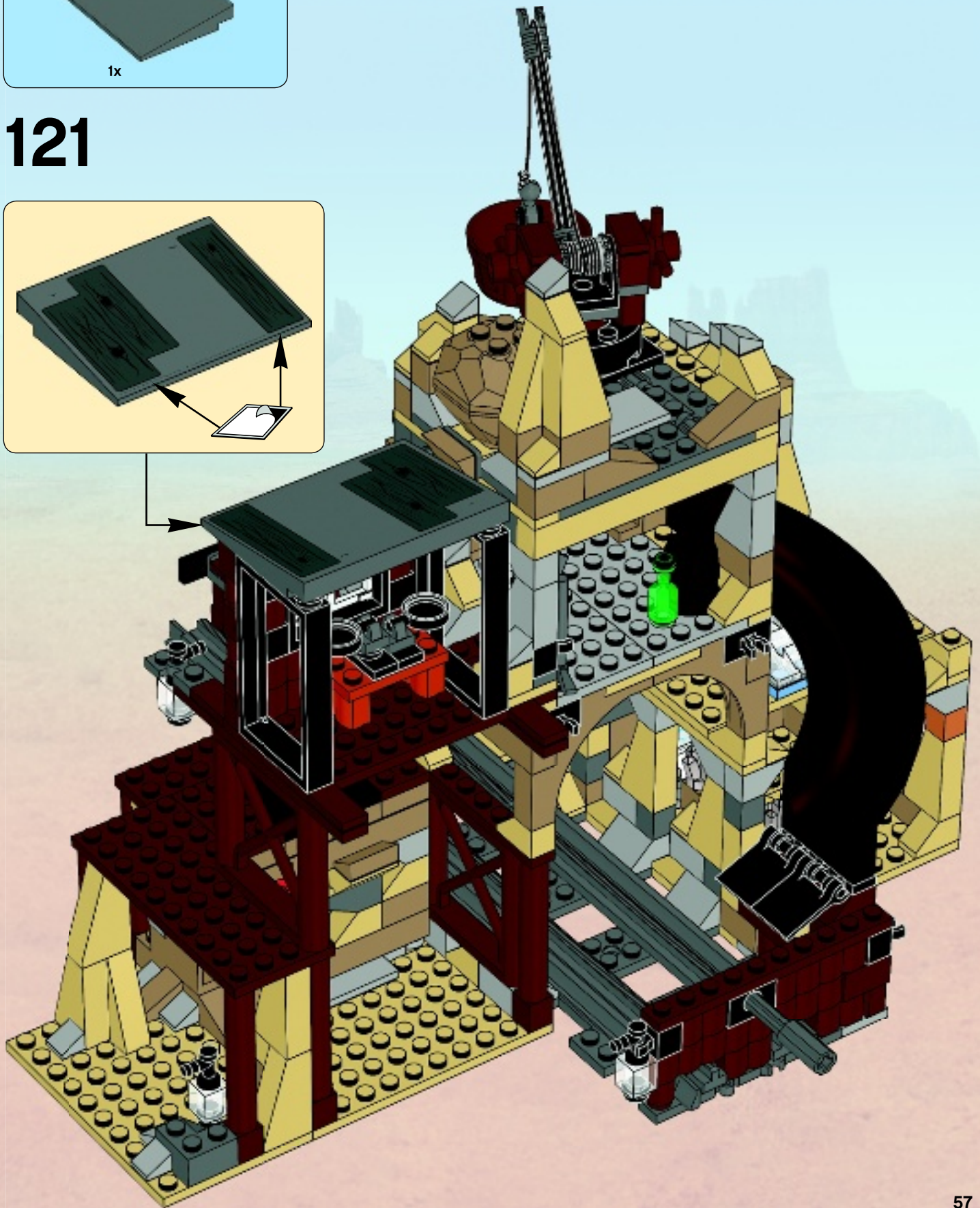
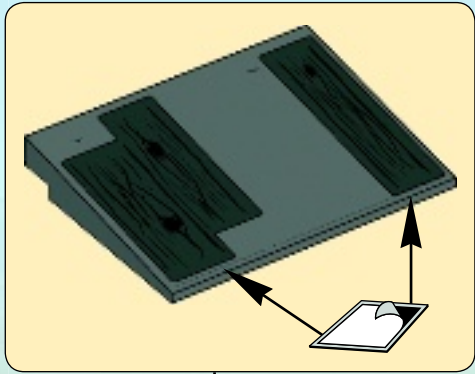



122

1



2



3

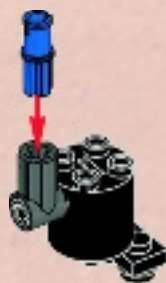

4



5



6



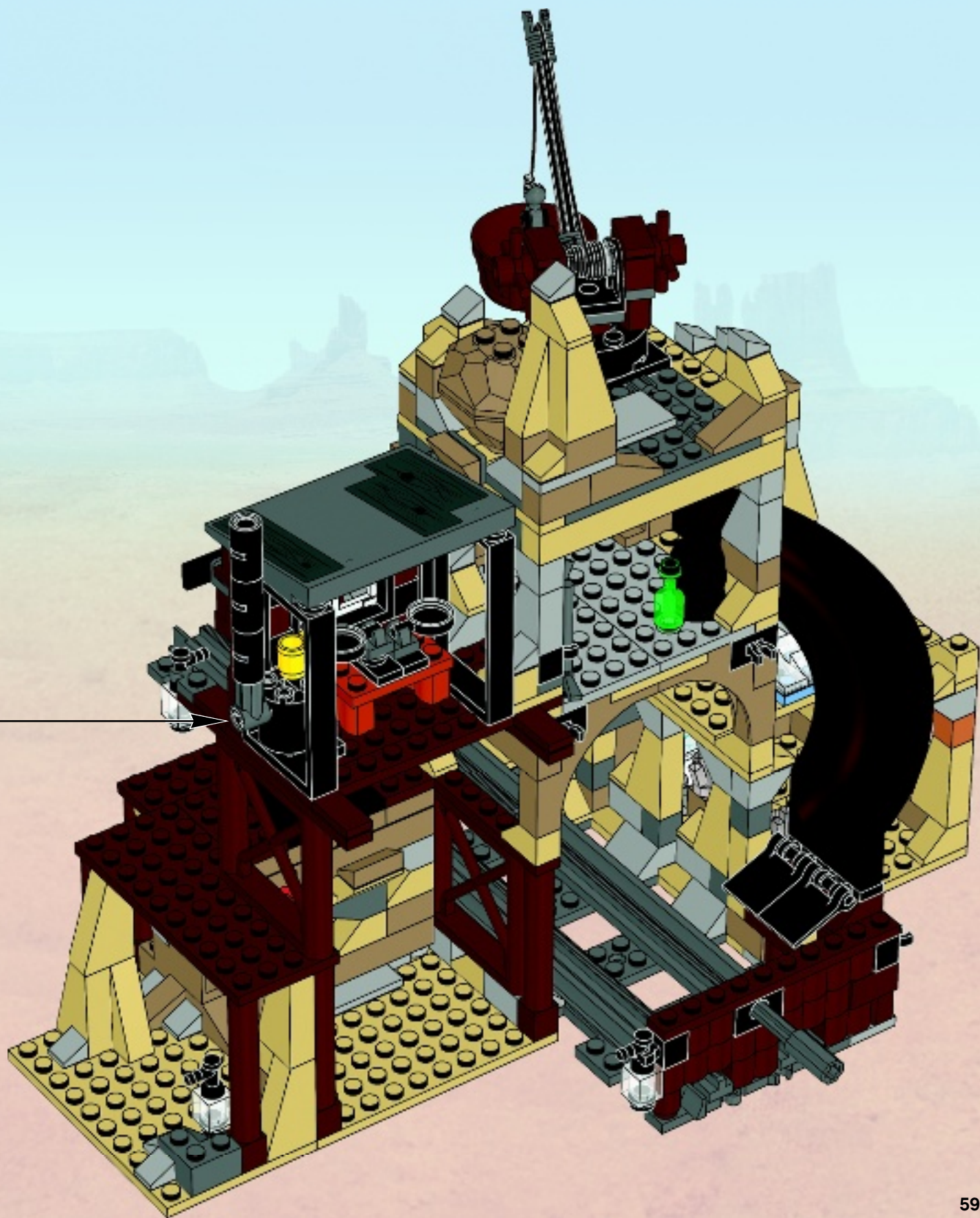

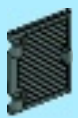

2x

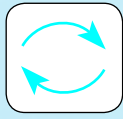

123

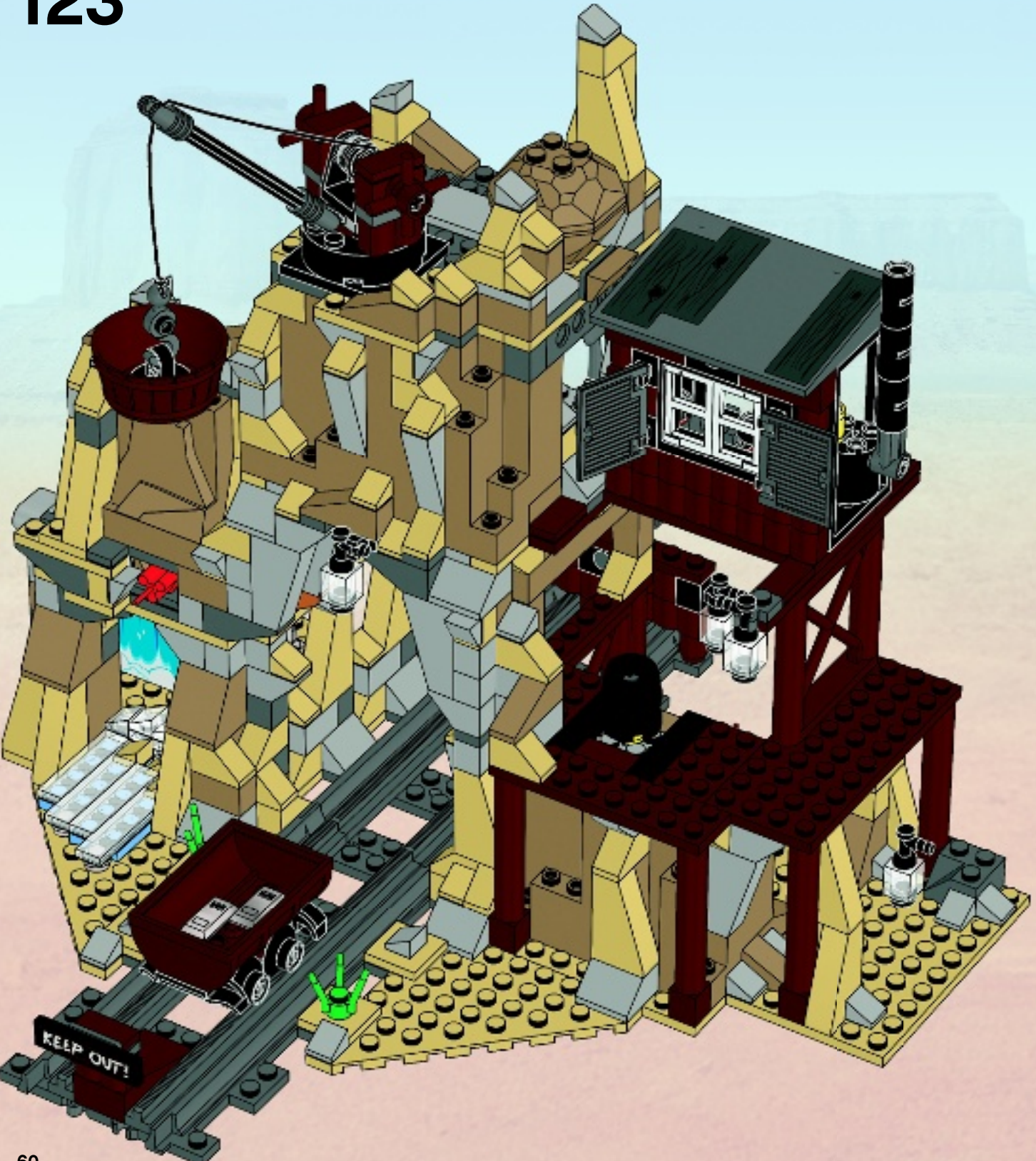

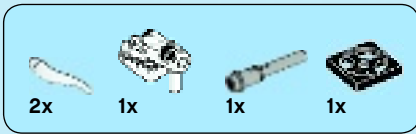

124

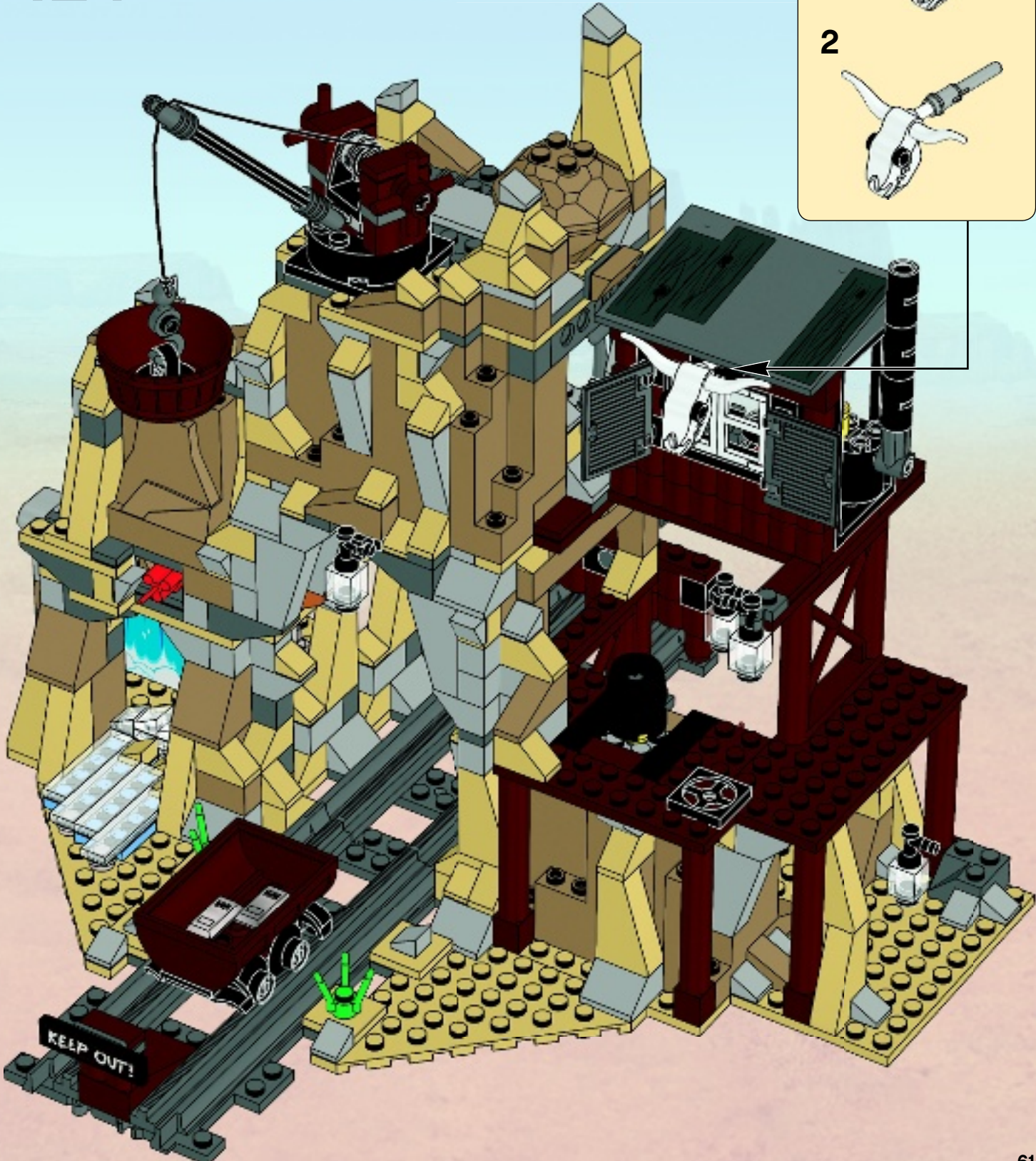
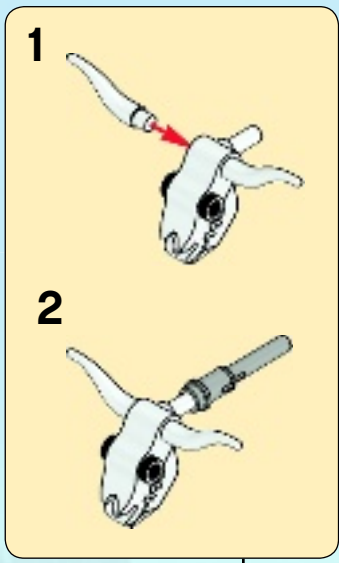

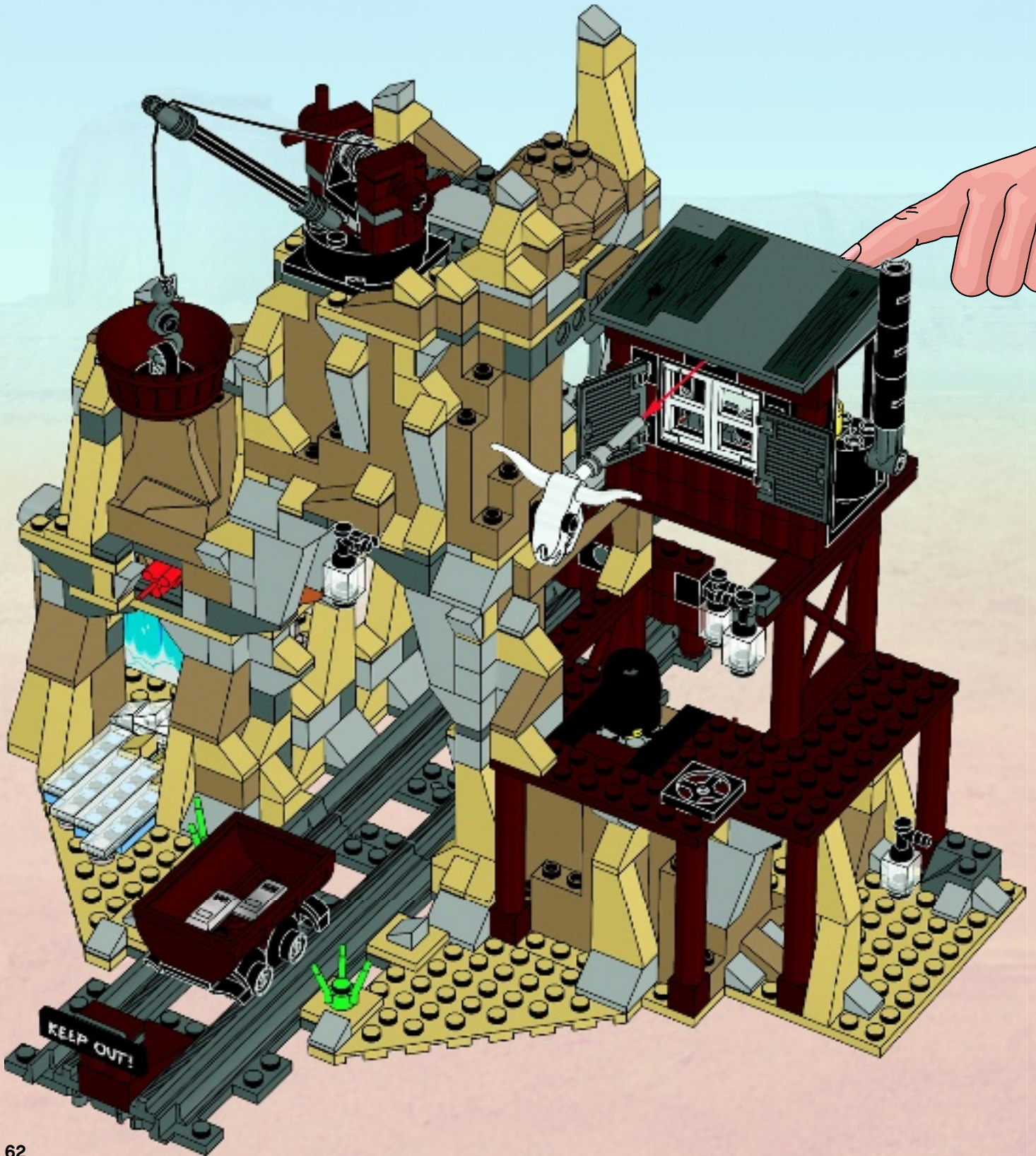



1x

125

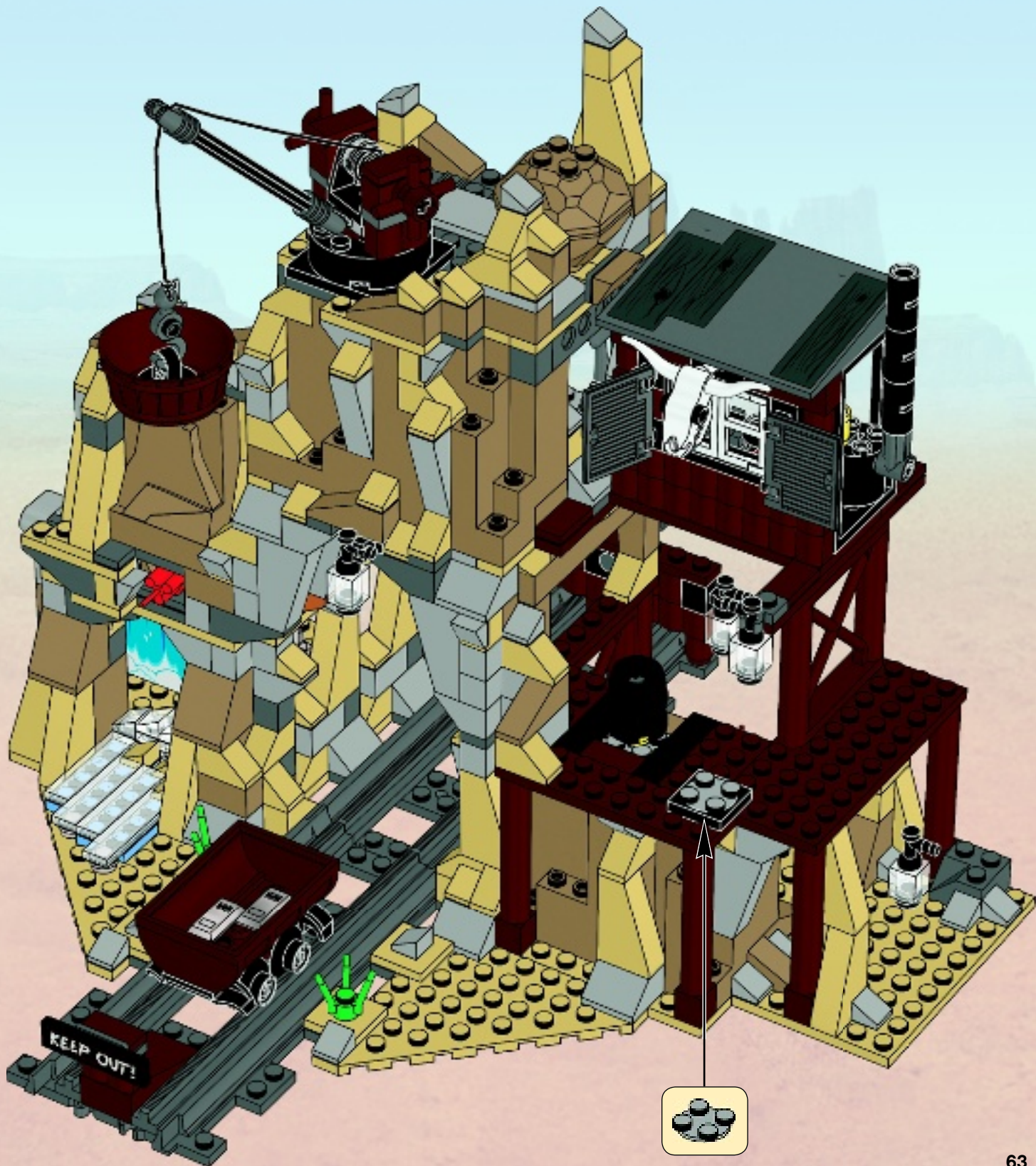



126

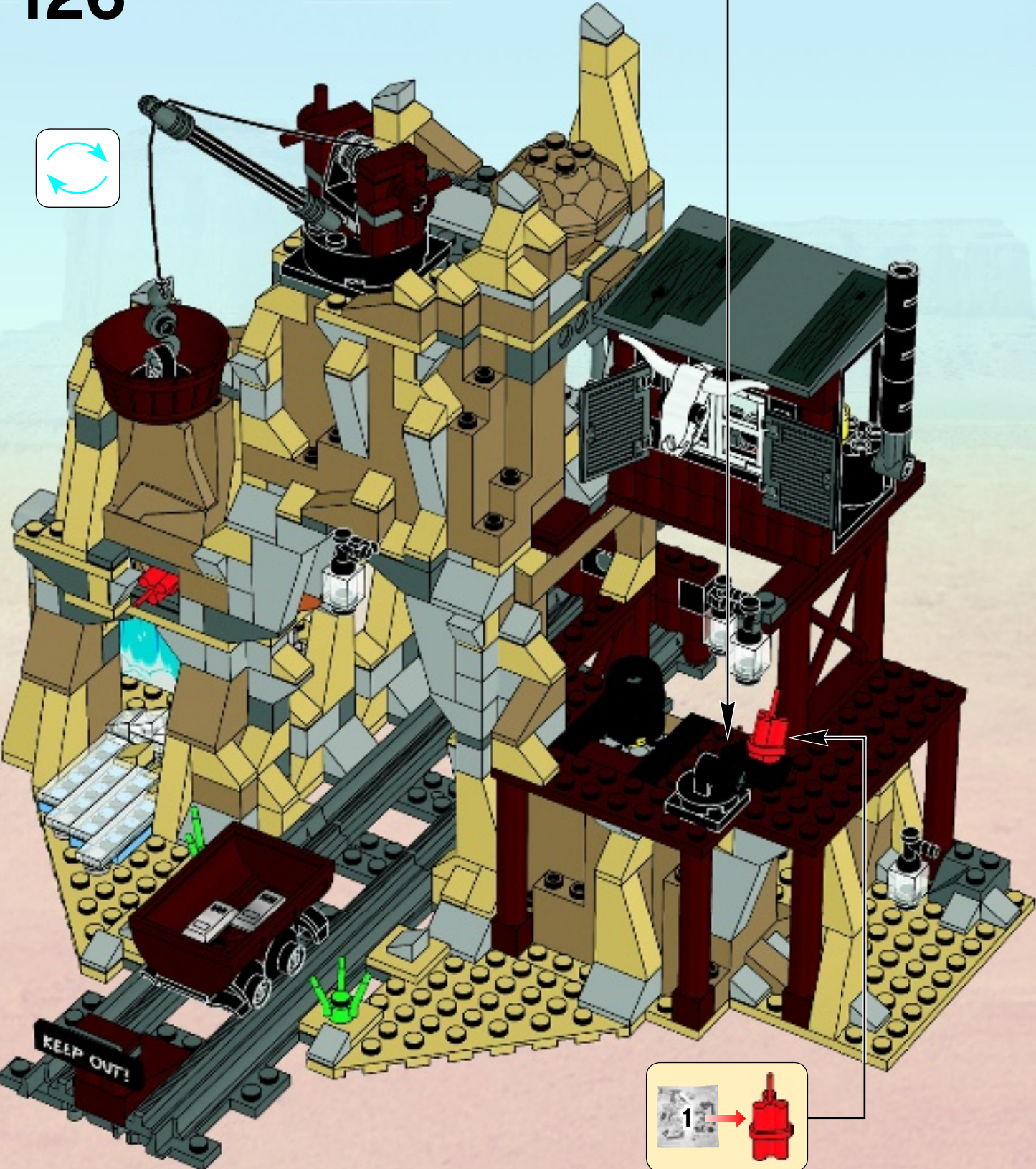
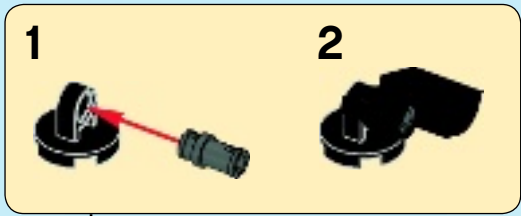
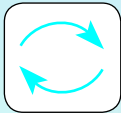

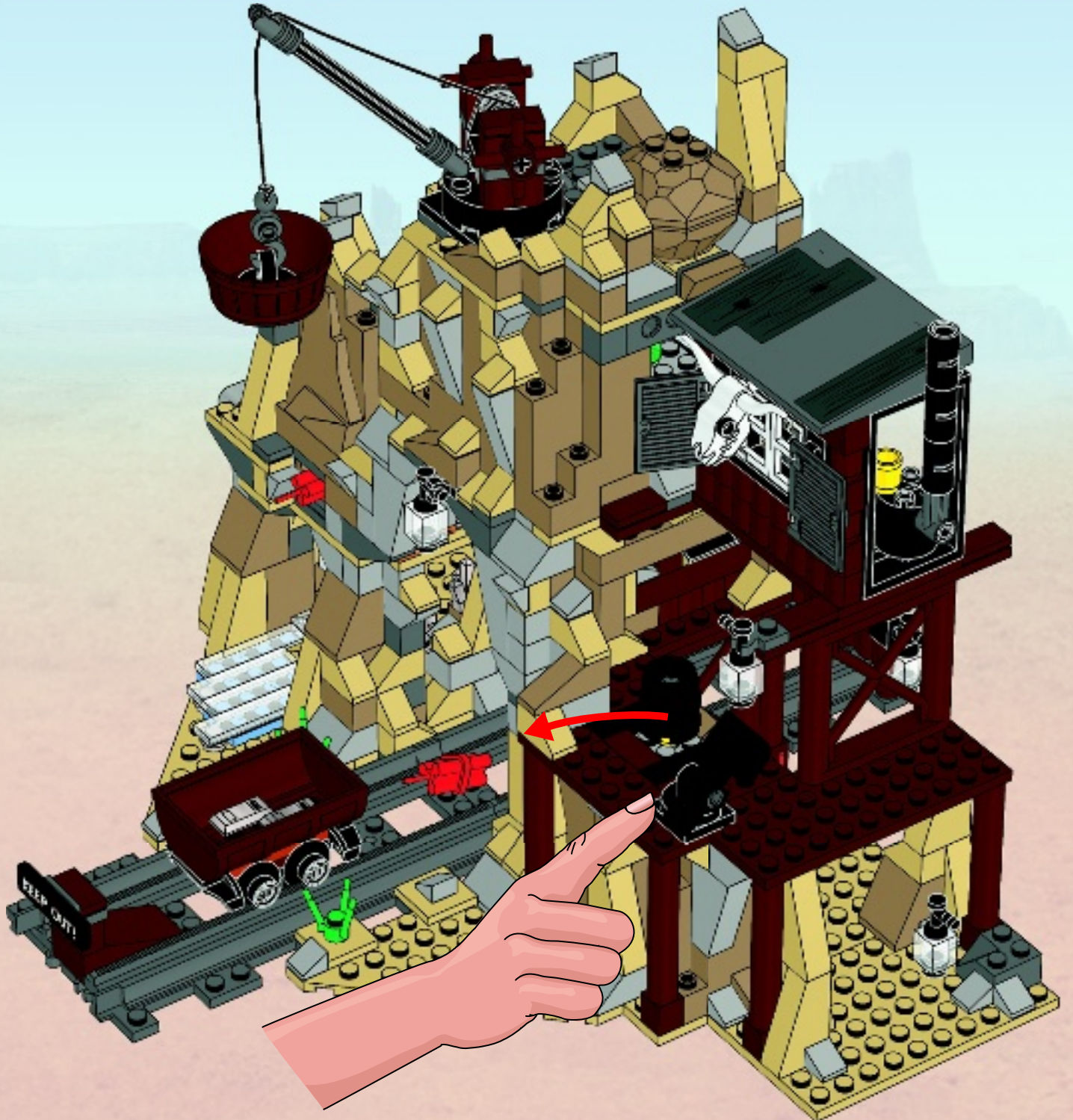

1x 1x

127

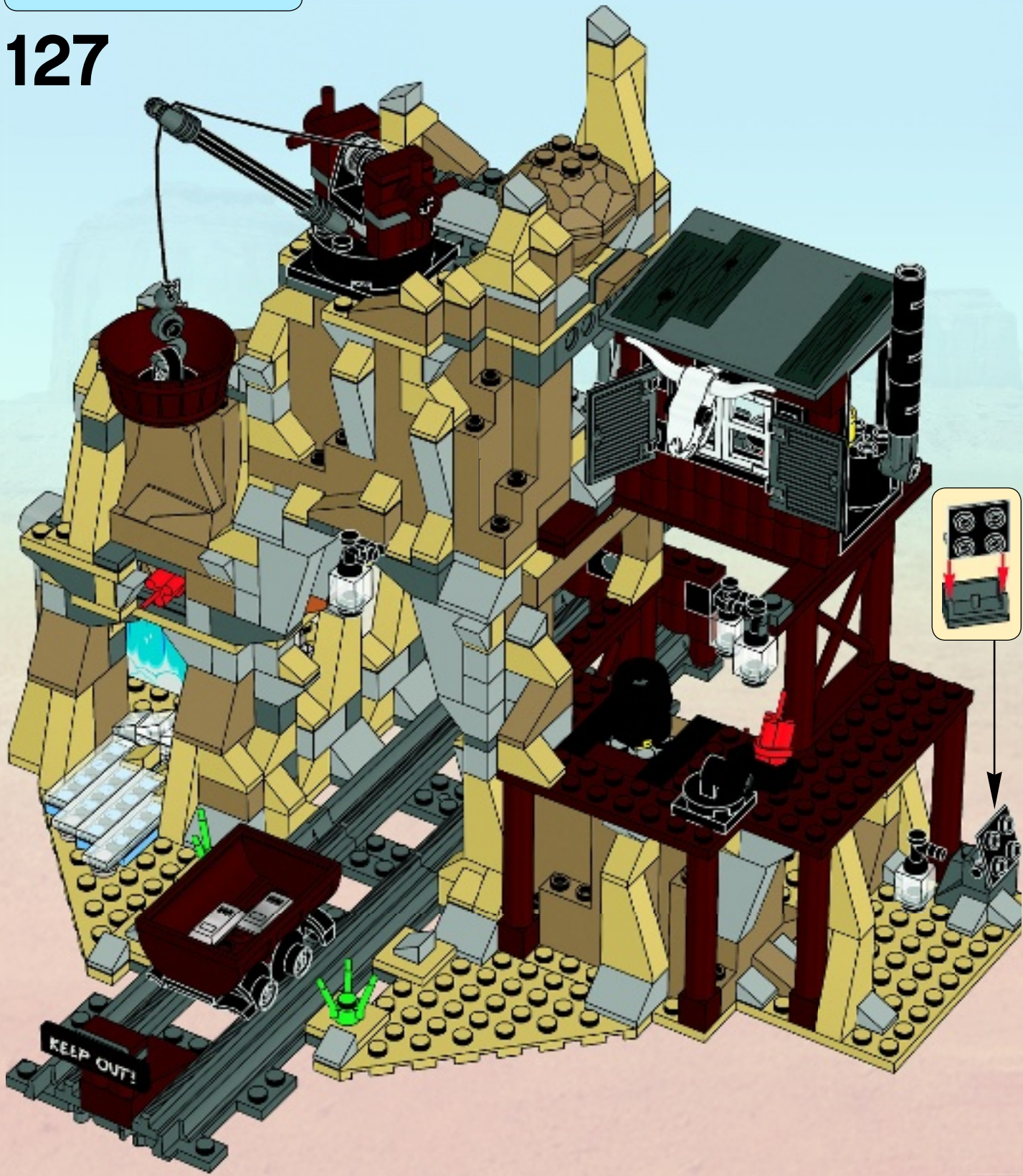

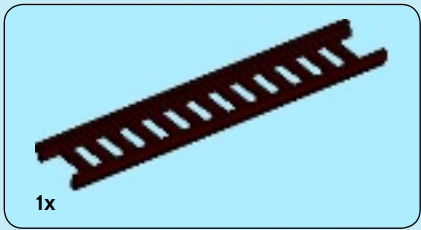

128

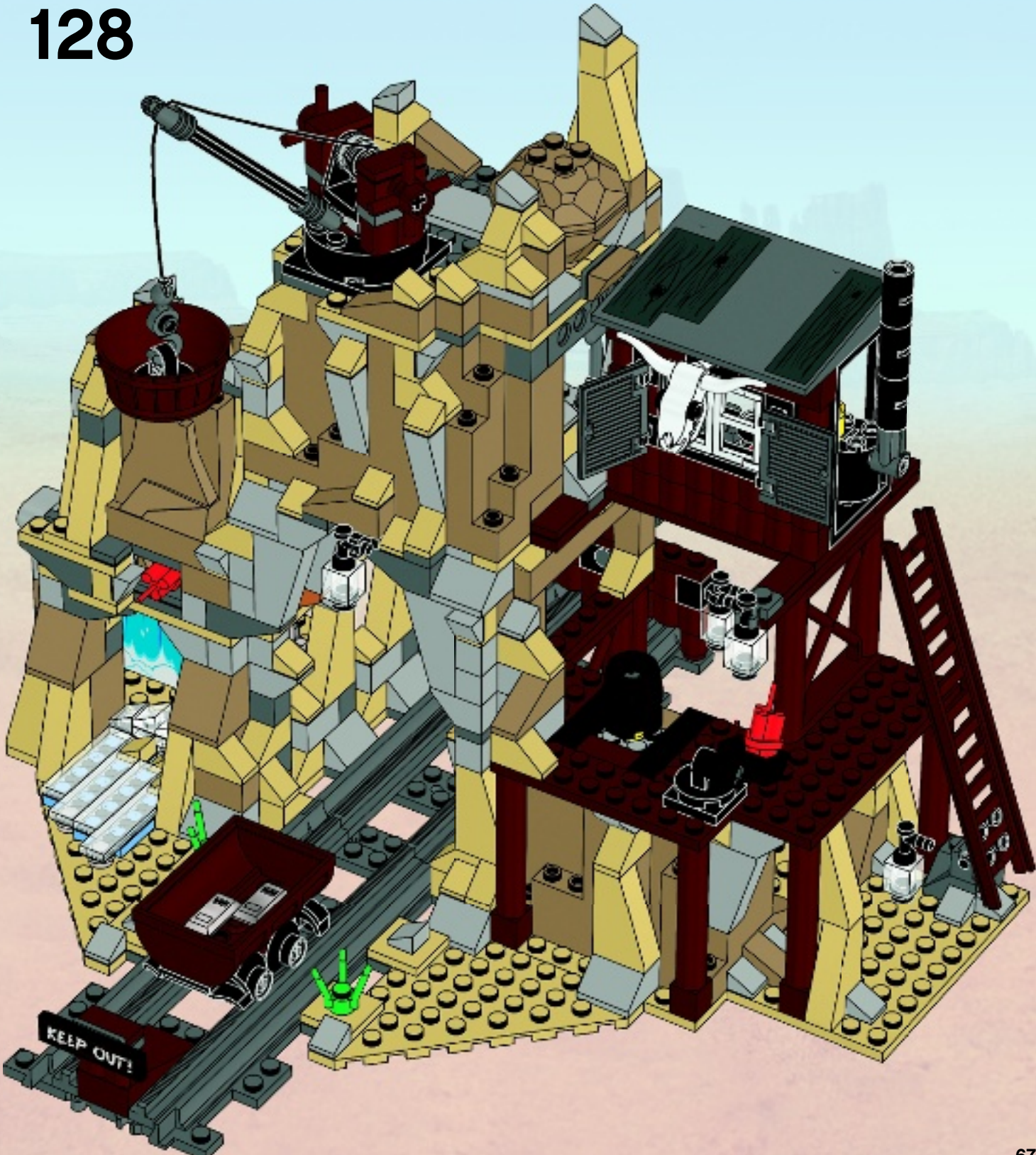



2x 4611700
2x 4520842
1x 6032362
1x 6032363
2x 6032360
2x 4494474
1x 4114026
4x 4114084
8x 4113233
3x 4114309
2x 6052783
1x 4181134
1x 4166138
2x 4113988
4x 4143409
2x 4626948
6x 4624185

5x 4118793
21x 4516055
48x 4121972
1x 4155708
4x 4565387
22x 4129996
8x 4118866
1x 4107623
1x 6037526
3x 4538780
1x 4174747
1x 4143005
3x 4206482
1x 389924
2x 4239601
8x 4533771
2x 4118624
1x 4194008
1x 3200026
1x 4558957

2x 370026
2x 379426
1x 4517925
1x 4569733
2x 4140588
9x 614126
2x 6010831
1x 4530589
2x 4535834
4x 459926
2x 6011815
1x 6042795
1x 6033775
1x 6033811
1x 6042862
1x 6032332
1x 6032373
2x 452826
2x 460026

4x 4295370
2x 4504187
1x 4124096
1x 258426
1x 368026
1x 4517986
1x 4297719
1x 6006140
1x 4143187
3x 4121715
3x 4526982
1x 370626
1x 370726
2x 374128
1x 6037379
1x 4167842
8x 4657537
4x 4645394
12x 4244362
4x 4650970

1x 6020220
1x 6037788
1x 6037792
1x 6042968
2x 6031821
19x 4521914
2x 4663285
10x 6015449
3x 4616593
13x 6015454
4x 6024122
5x 6024124
1x 6037802
2x 6037837

2x 4666352
2x 4535928
2x 4211200
2x 4211220
8x 4211151
10x 4211180
8x 4211181
7x 4211183
6x 4520612
2x 4211252
1x 4211205
1x 4225869
2x 4211186
1x 4211211
5x 4223683
2x 4225715
1x 4211268

- 2x 4211159
- 1x 4541875
- 1x 4216615
- 1x 6043062
- 1x 6042868
- 1x 4507139
- 1x 4211160
- 2x 6002837
- 2x 4252456
- 13x 4211349
- 1x 4211394
- 35x 4521921
- 17x 4211437
- 1x 4211438
- 1x 4211452
- 2x 4211402

- 2x 4515374
- 9x 4216248
- 14x 4211410
- 6x 4211429
- 1x 4211814
- 2x 4654580
- 2x 4560183
- 1x 4211542
- 3x 4650260
- 1x 4211370
- 1x 4540203
- 1x 4520320
- 1x 4211862
- 1x 4563045
- 1x 4211758
- 8x 4211098
- 6x 4210719
- 14x 4211063
- 2x 6030710
- 1x 4587212
- 2x 6000606

- 1x 4210658
- 1x 4211050
- 3x 4516546
- 1x 4212529
- 2x 4210695
- 1x 4211066
- 2x 4211104
- 1x 4210702
- 5x 4211068
- 2x 4211055
- 1x 4568734
- 2x 4210917
- 1x 4654618
- 1x 4595710
- 1x 4595708
- 4x 4638990
- 2x 6037688

- 1x 4211007
- 1x 4211006
- 1x 6035094
- 2x 4560177
- 1x 4508553
- 2x 4552351
- 1x 6042647
- 1x 6032388
- 1x 6033436
- 1x 6042860
- 1x 6033629
- 13x 4249039
- 5x 4519318
- 1x 4654448
- 1x 6038373

- 1x 6037775
- 2x 4536677
- 1x 6042864
- 1x 6038611
- 1x 4568951
- 3x 4536989
- 1x 4569385
- 3x 4568955
- 1x 6043024
- 1x 6043608
- 1x 6043021
- 2x 6034154
- 2x 6034689
- 1x 6035045



Disney **THE LONE RANGER**



LEGO.com/TheLoneRanger





club™

Free*! Gratuit!

* Paid subscription in Australia and New Zealand.
Abonnement payant en Australie et Nouvelle-Zélande



© 2012 The LEGO Group.

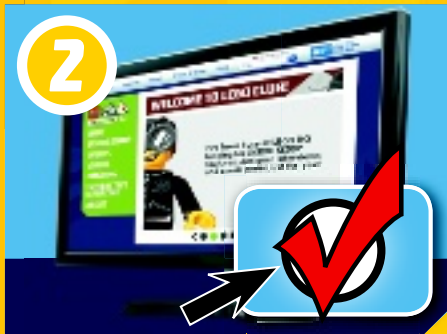

LEGO.com/club



WIN!

Go to www.LEGOsurvey.com/product to fill out a survey for a chance to win a cool LEGO® Product.

No purchase necessary.

Open to all residents where not prohibited.



LEGO.com



www.LEGOsurvey.com/product

GEWINNE!

Nimm an der Umfrage auf www.LEGOsurvey.com/product teil und hab die Chance ein cooles LEGO® Produkt zu gewinnen!

Die Teilnahme am Gewinnspiel führt zu keinerlei Kaufverpflichtungen. Teilnahme in allen nicht ausgeschlossenen Ländern möglich.

WIN!

Ga naar www.LEGOsurvey.com/product, vul een enquêteformulier in en maak kans op een cool LEGO® product.

Geen aankoopverplichting. Iedereen mag deelnemen, uitgezonderd ingezetenden van landen waar een enquêteverbod geldt.

GAGNE!

Visite www.LEGOsurvey.com/product pour répondre à un questionnaire et avoir une chance de gagner un produit LEGO® très cool!

Aucune obligation d'achat. Ouvert à tous les résidents des pays autorisés.

当てよう!

www.LEGOsurvey.com/product にアクセスして、アンケートにご記入ください。当選者にはレゴ®製品を差し上げます。

お買い上げの必要はありません。禁止されていない限り、すべての皆様にご利用いただけます。

