



MARVEL

SUPERHEROES



76021



 LEGO.com/SuperHeroes

MARVEL
**GUARDIANS
OF THE GALAXY**

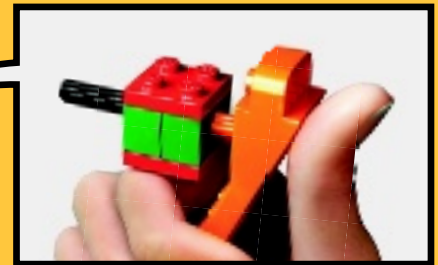
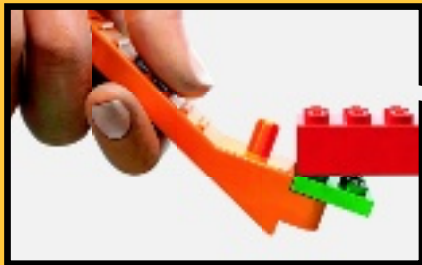

LEGO.com/brickseparator

IMPORTANT: Never modify the elements or use other projectiles than provided with this toy.
 IMPORTANT : Ne jamais modifier les éléments ni utiliser d'autres projectiles que ceux fournis avec ce jouet.
 IMPORTANTE: No modifique los elementos ni utilice otros proyectiles diferentes a los suministrados junto con este juguete.

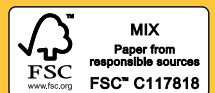

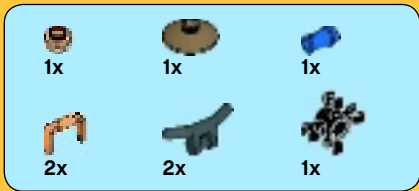
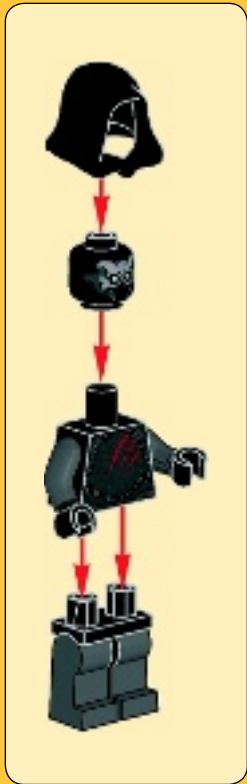
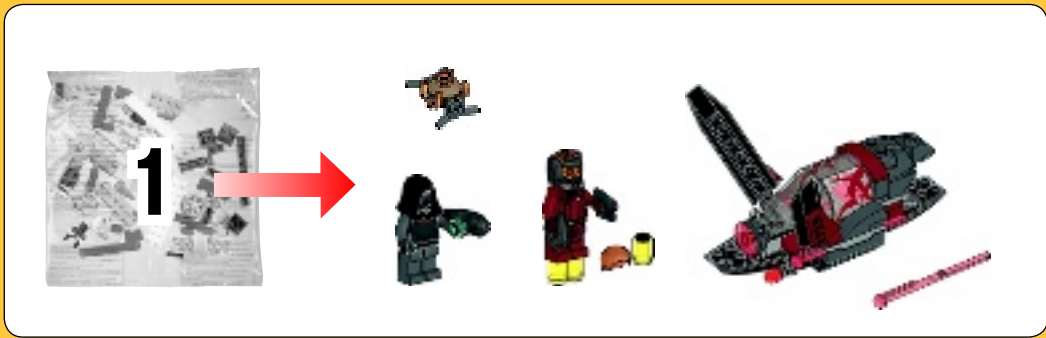

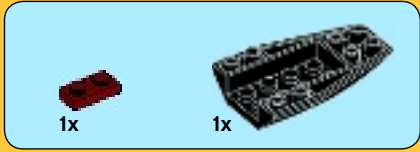

1

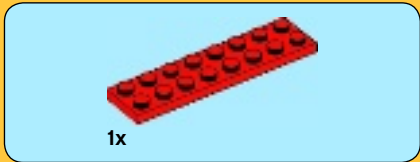

2

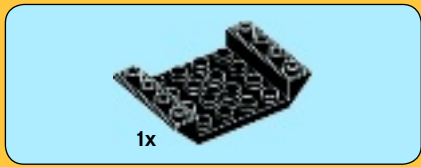
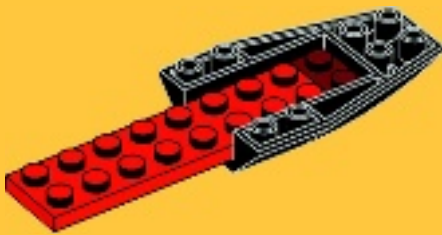

3



4

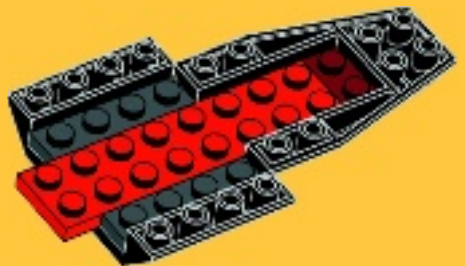

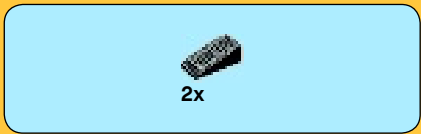

5



7



6



8

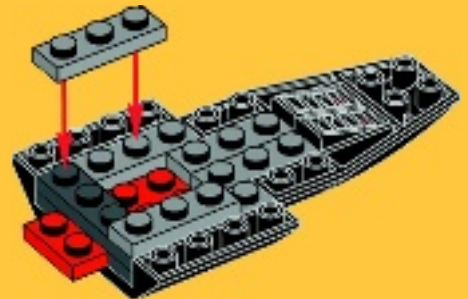



1x

9



2x

10

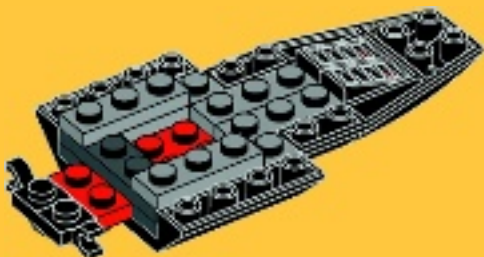

2x



2x

11



2x

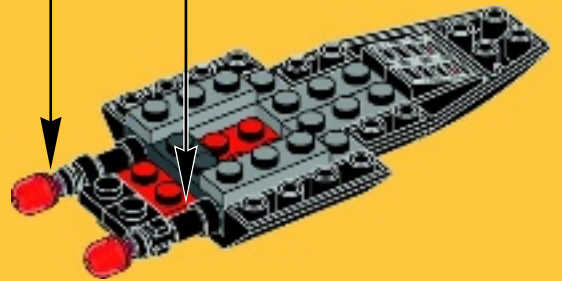

1x

12





13

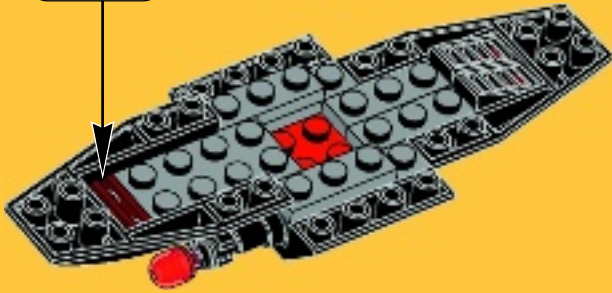

15

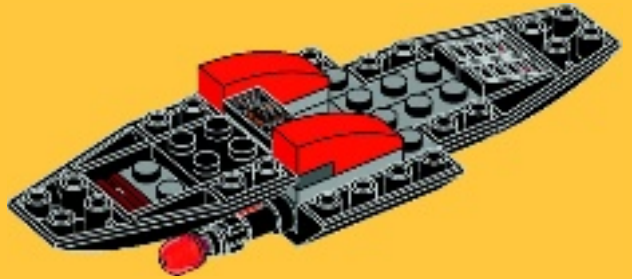

14

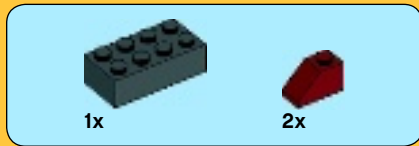

16

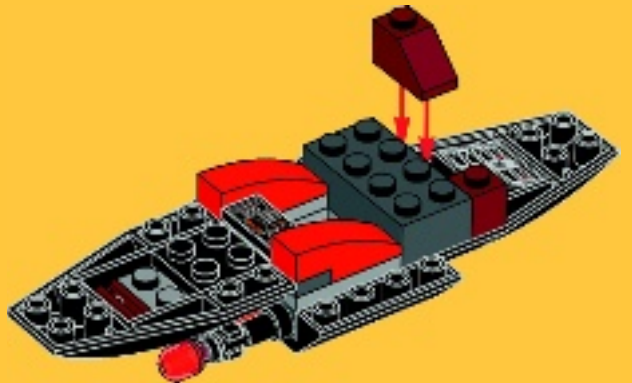



2x



17

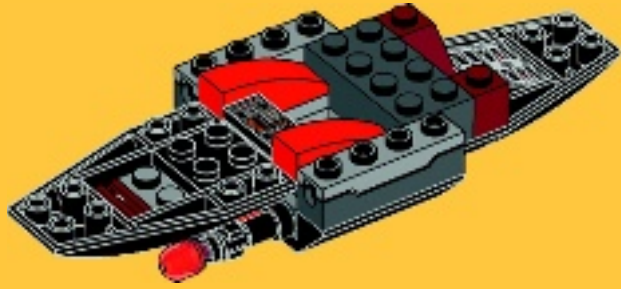

2x



1x

19

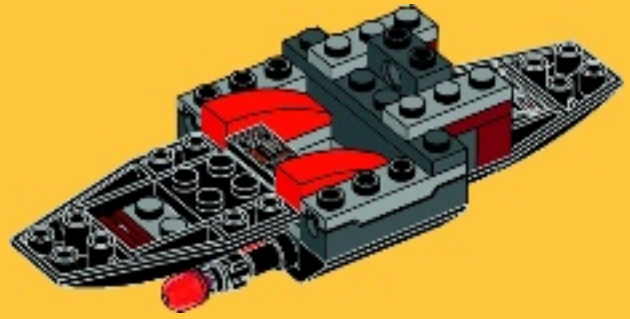

1x



2x

18

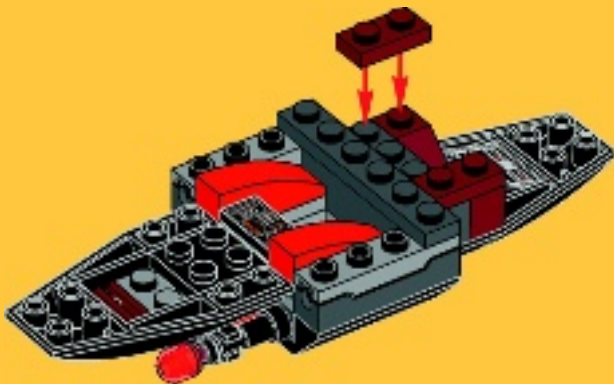

2x



1x

20

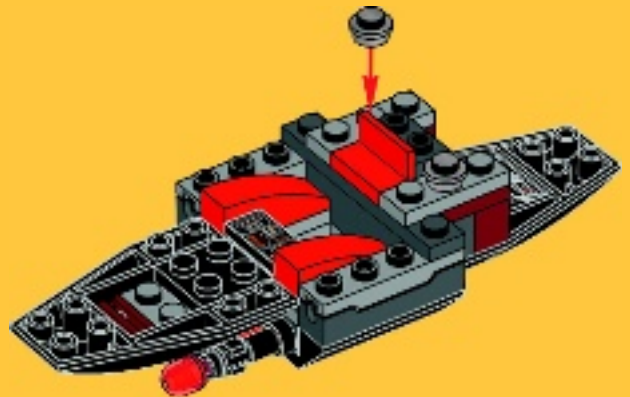

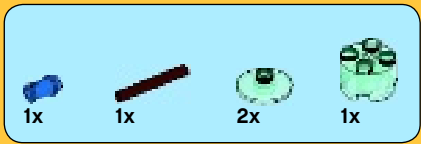

21

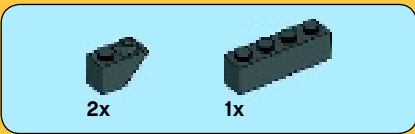
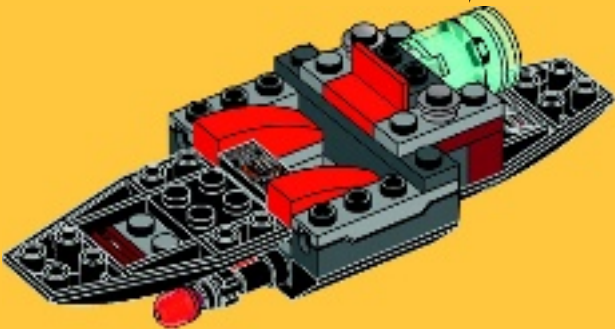
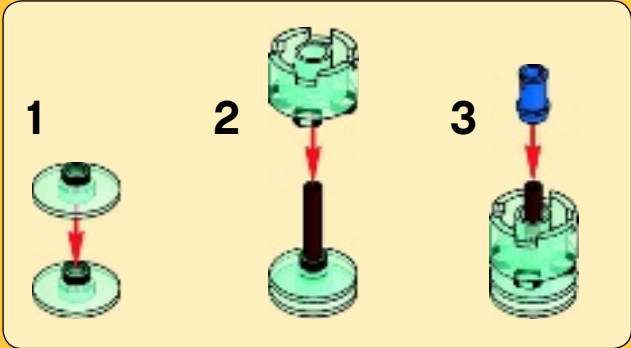

22

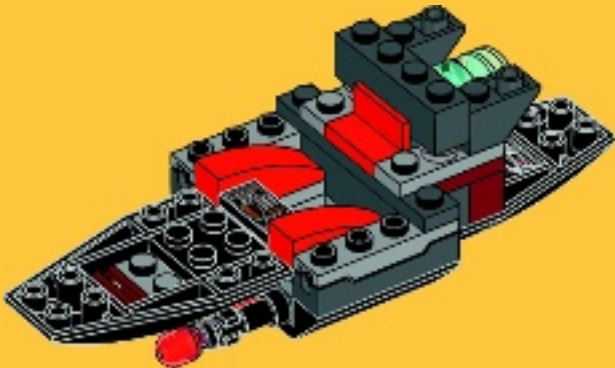



1x

23

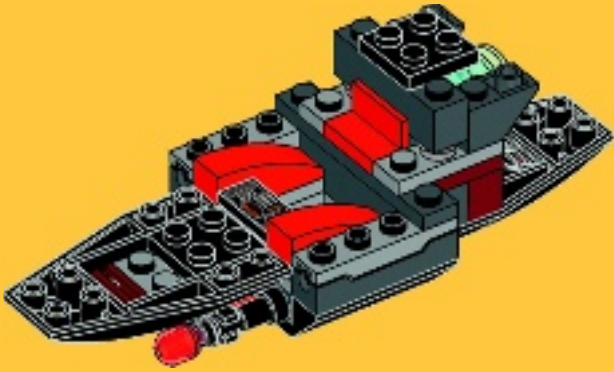

1x

24

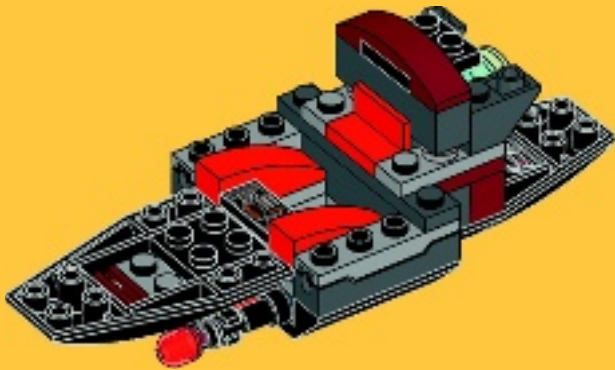

1x

25

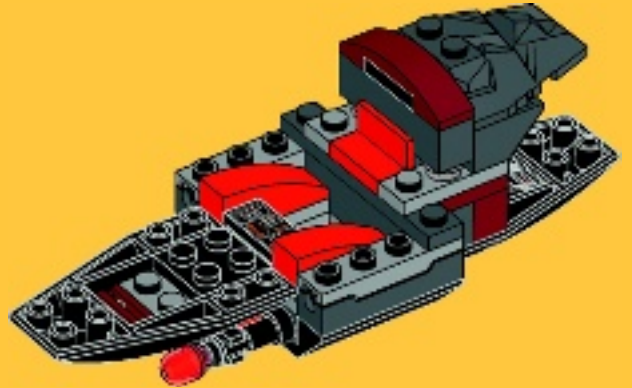



2x

26

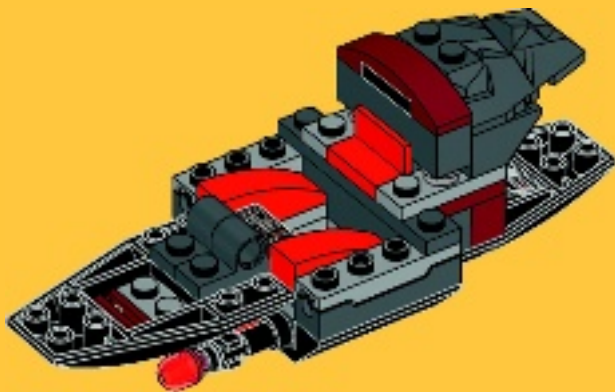

2x



1x

27

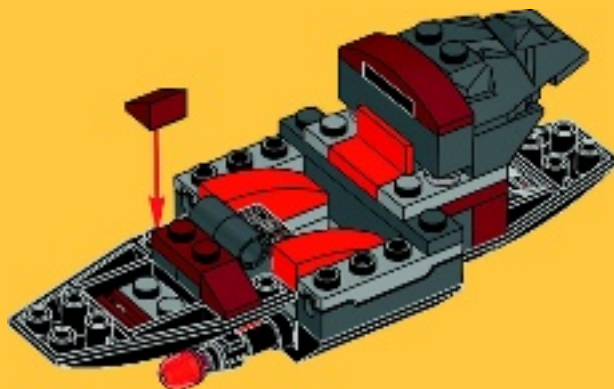

2x



2x

28

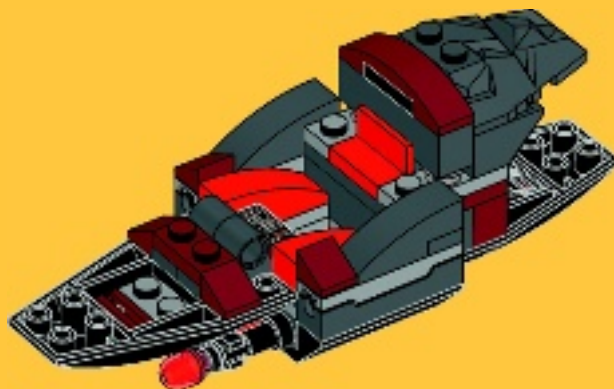



1x

29

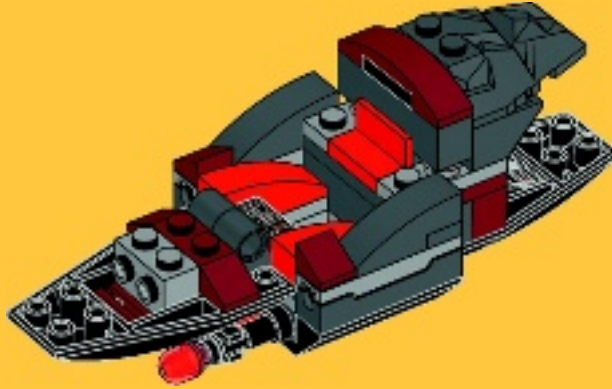

2x



2x

30

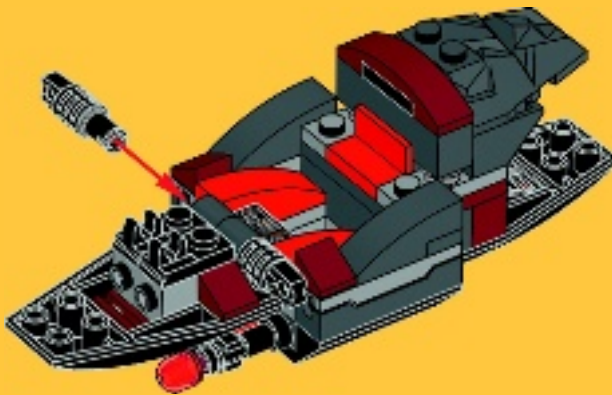

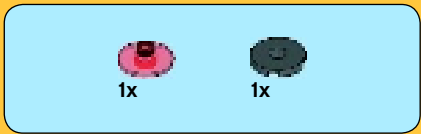

31

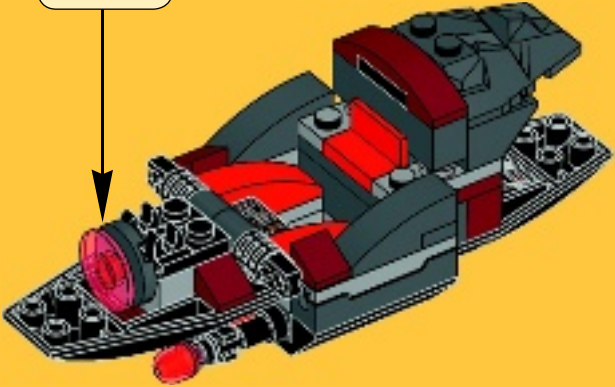

32

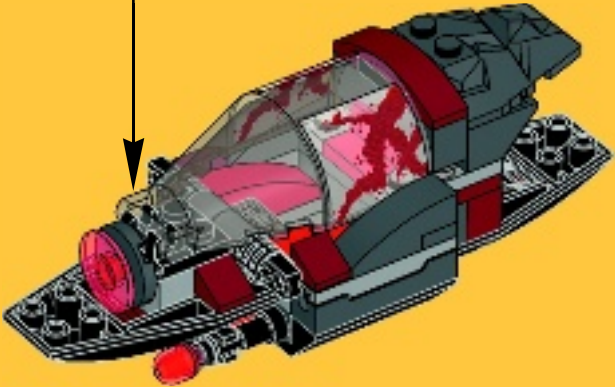
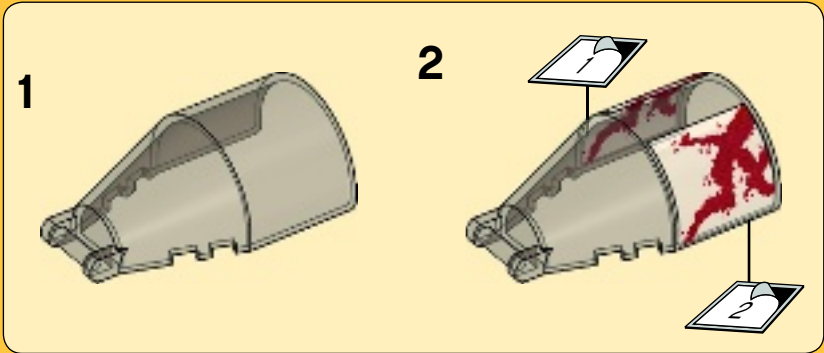

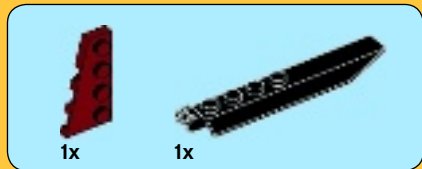

33

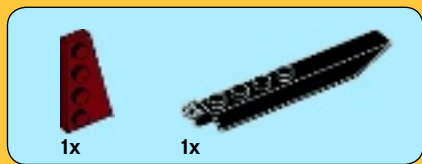
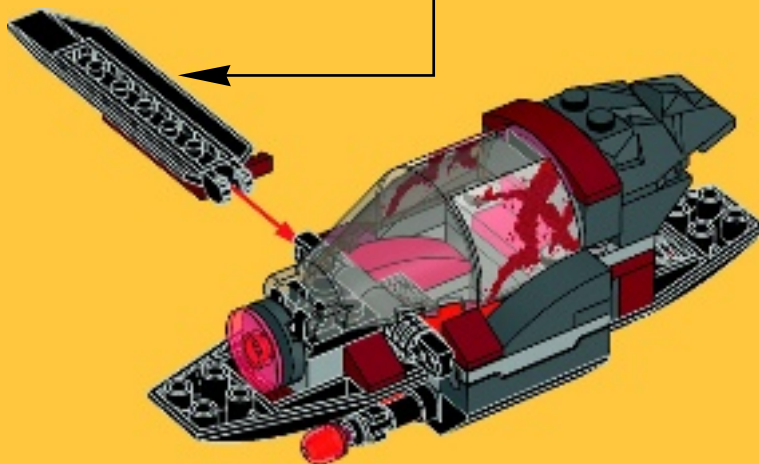
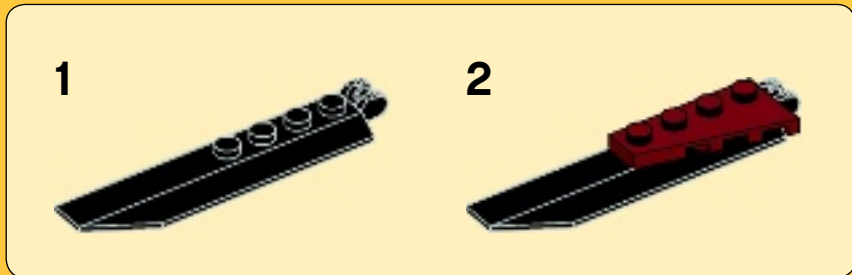

34

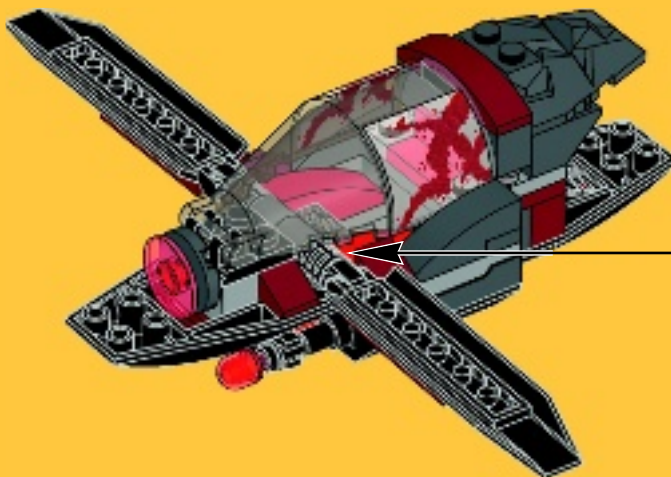
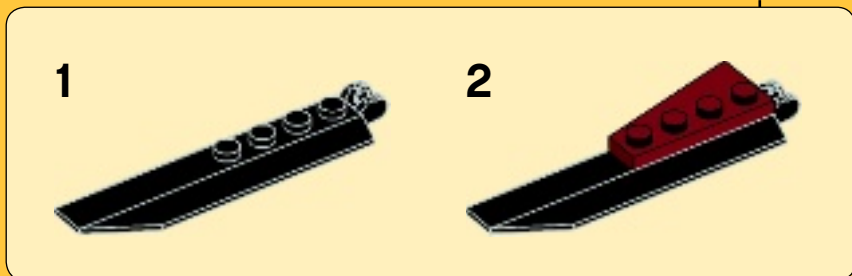

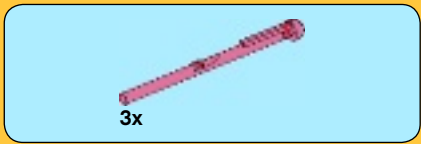

35

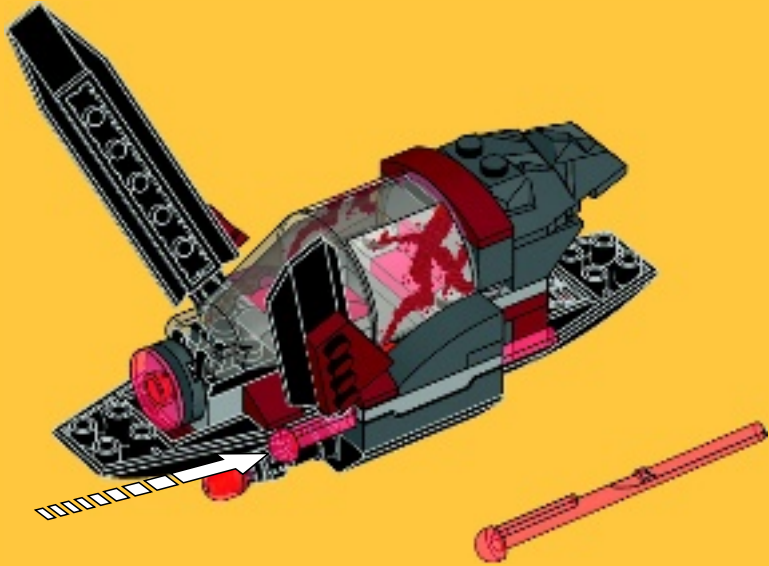

36

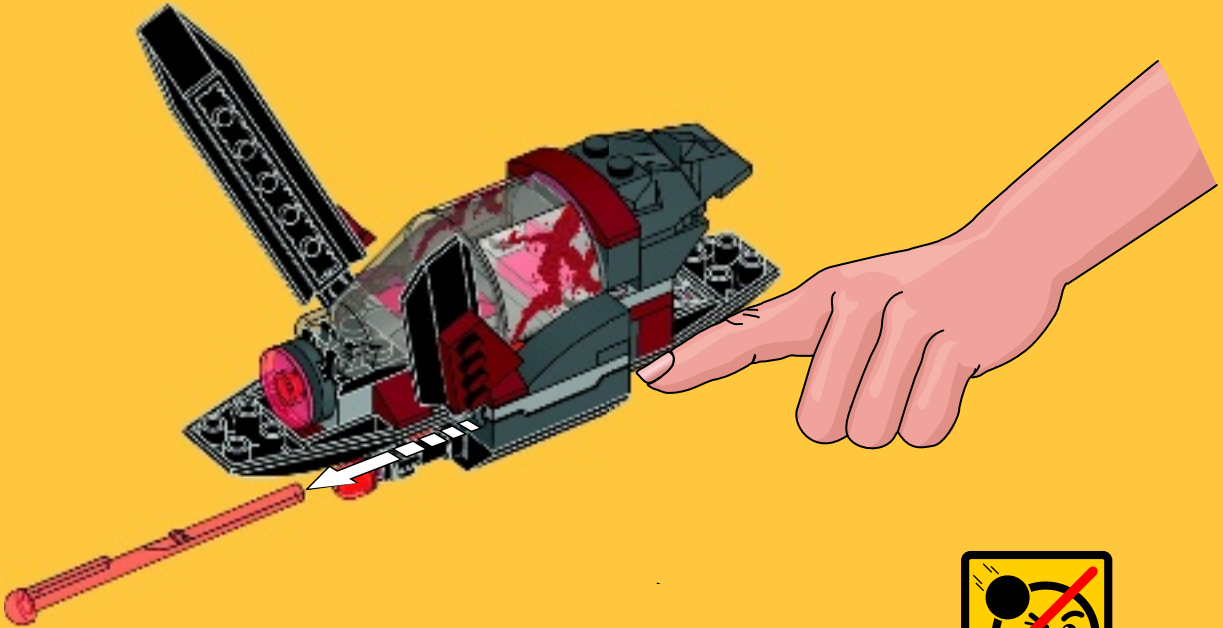

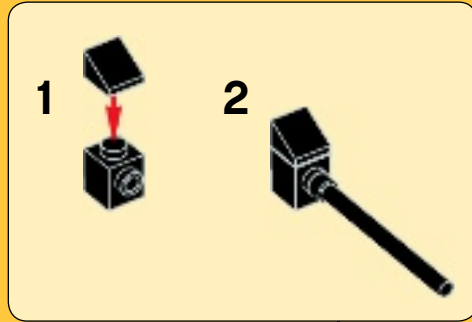
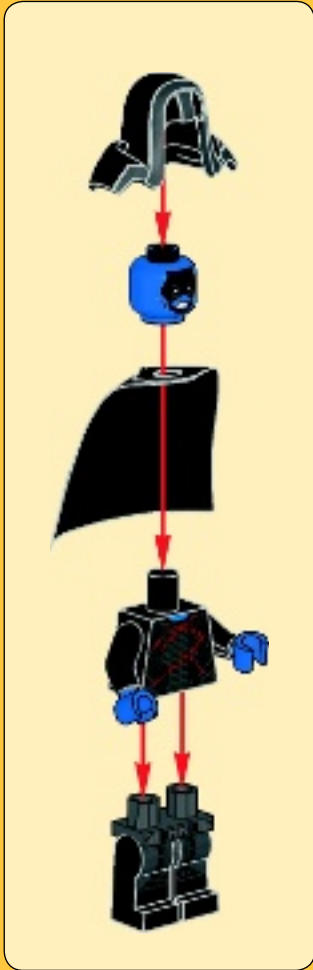
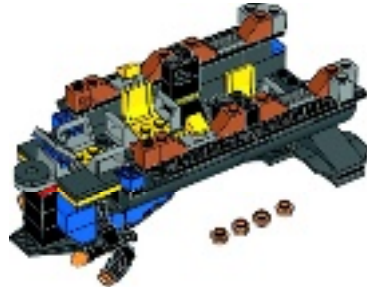

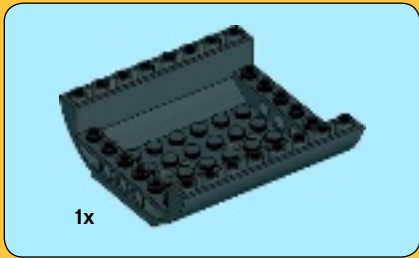

1

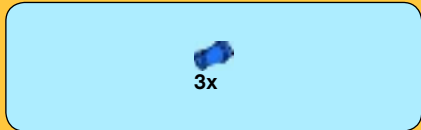
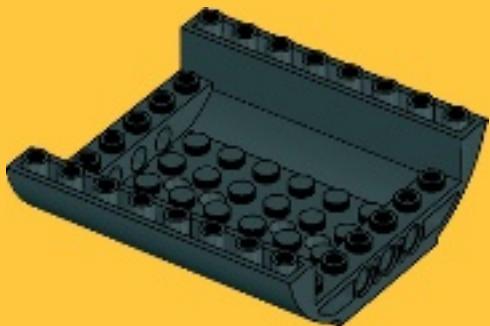

2

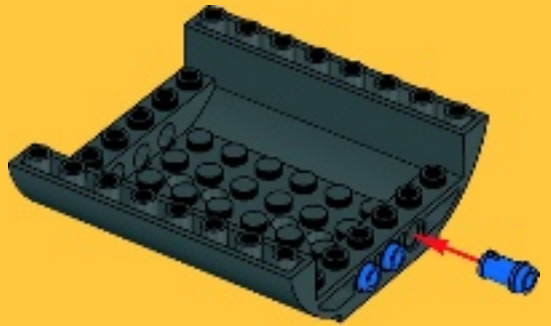

3

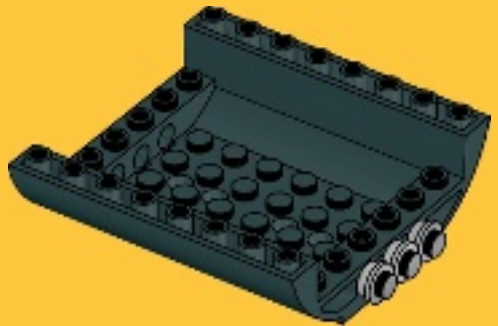



1x



2x

4



1x



2x

5

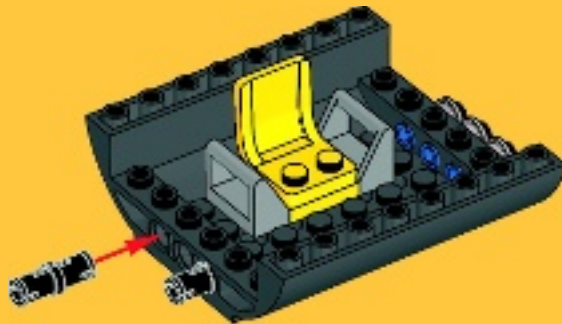

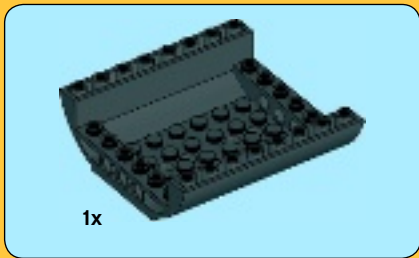

6

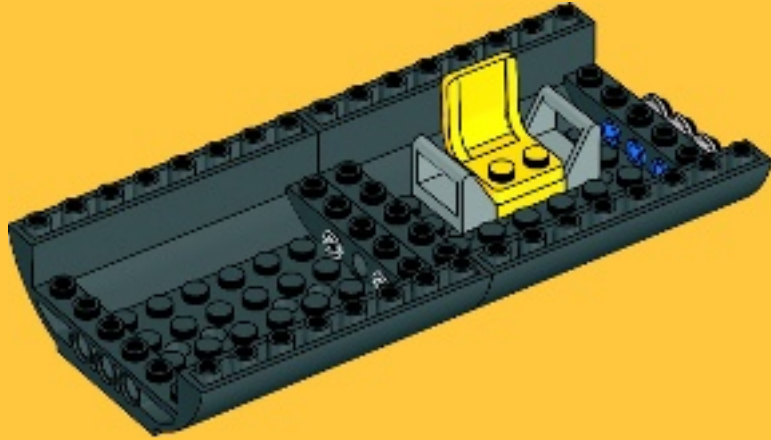

7

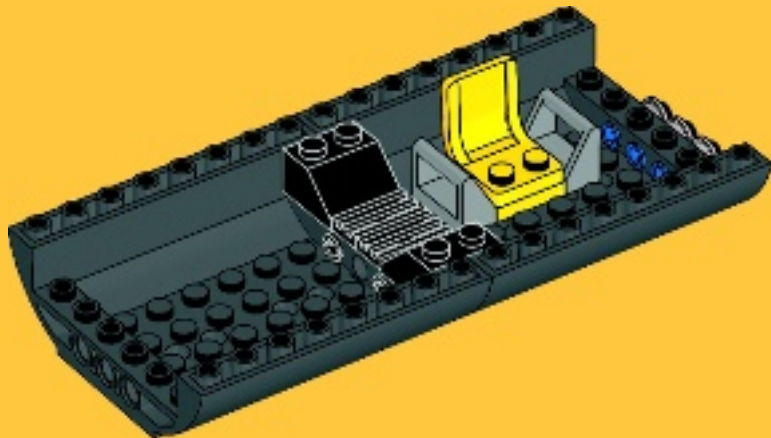



4x

8

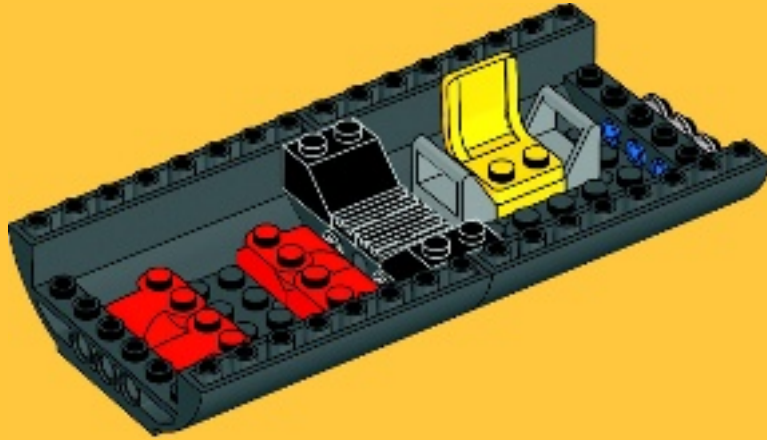

1x



2x

9

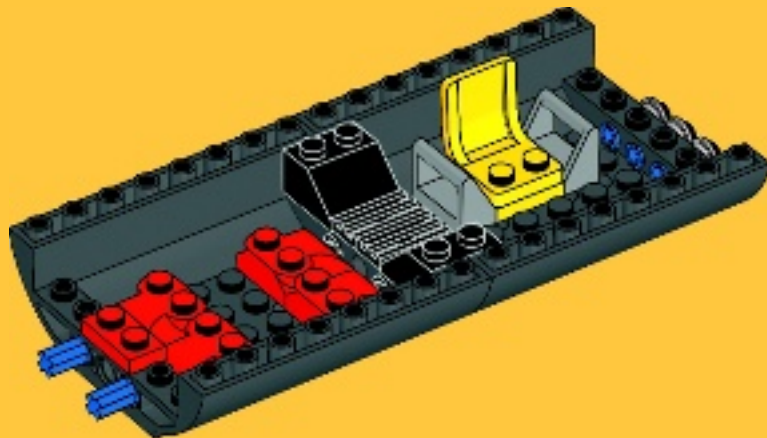

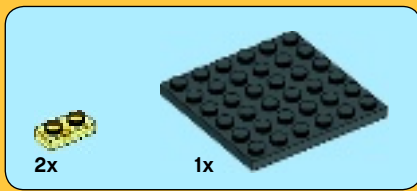

10

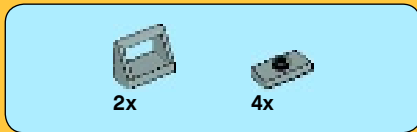
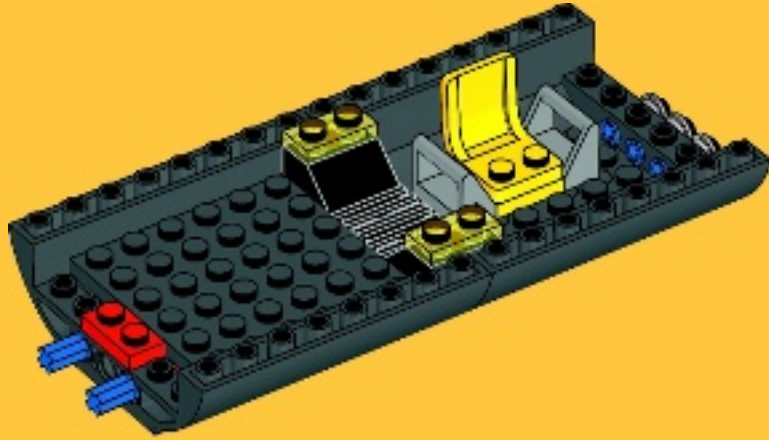

11

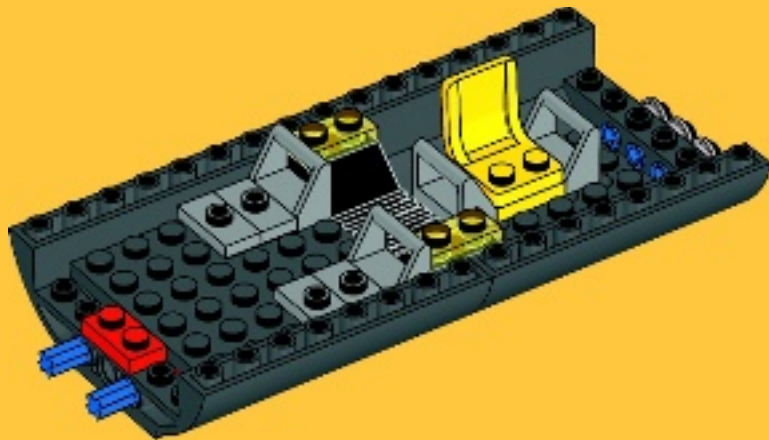



1x



2x

12

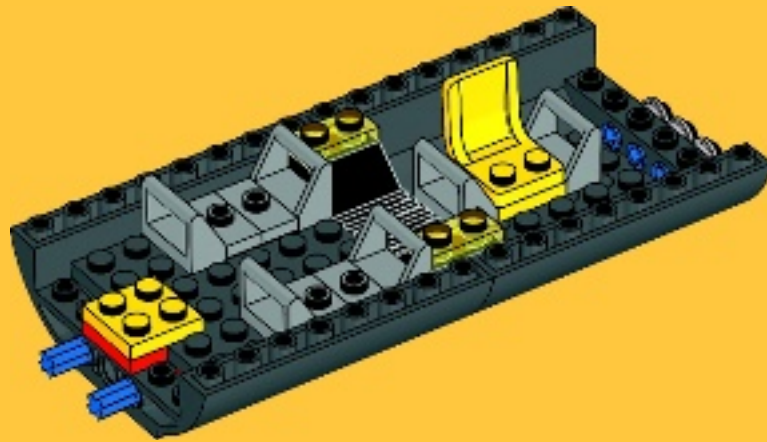

2x



1x

13

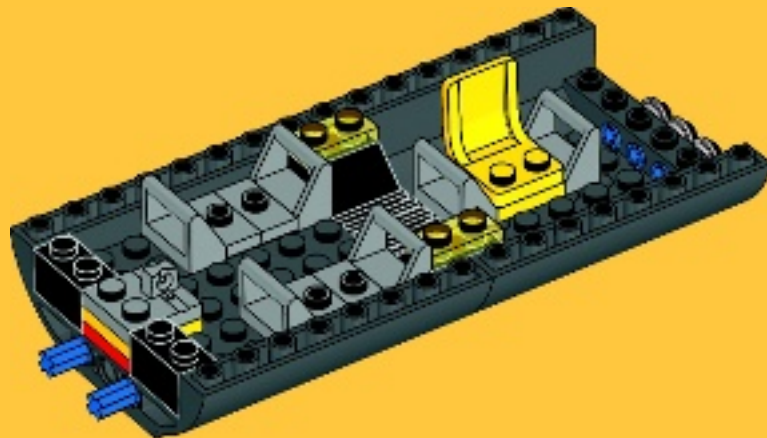



2x

14

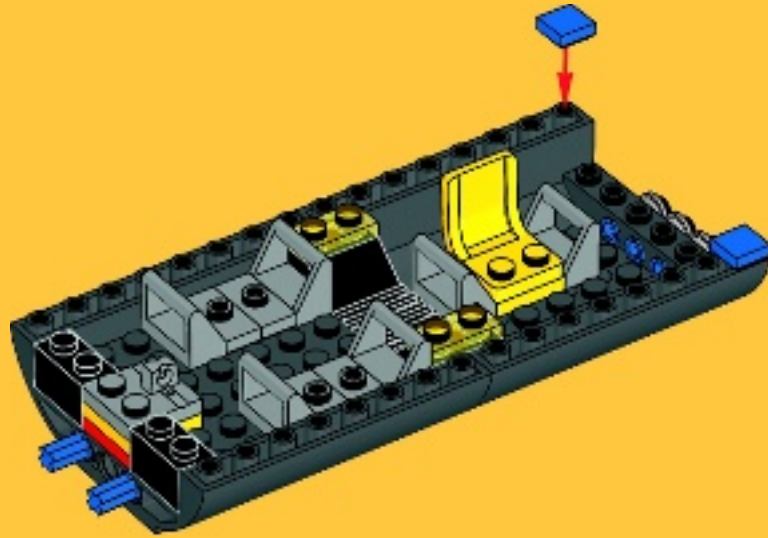

2x



1x

15

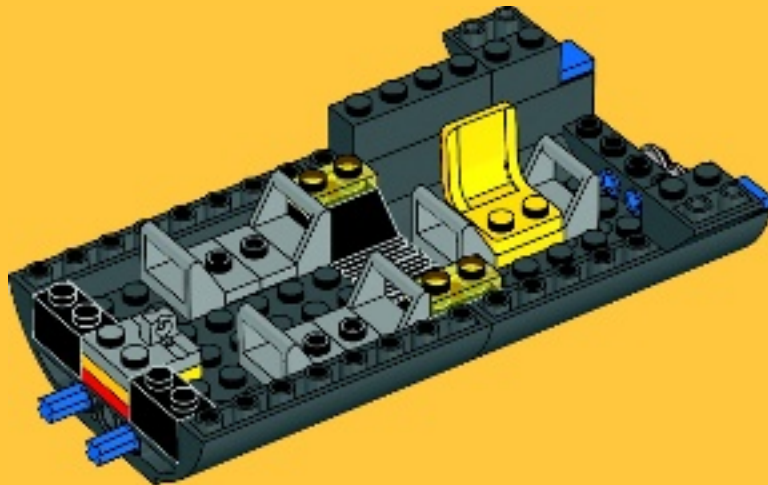



1x

16

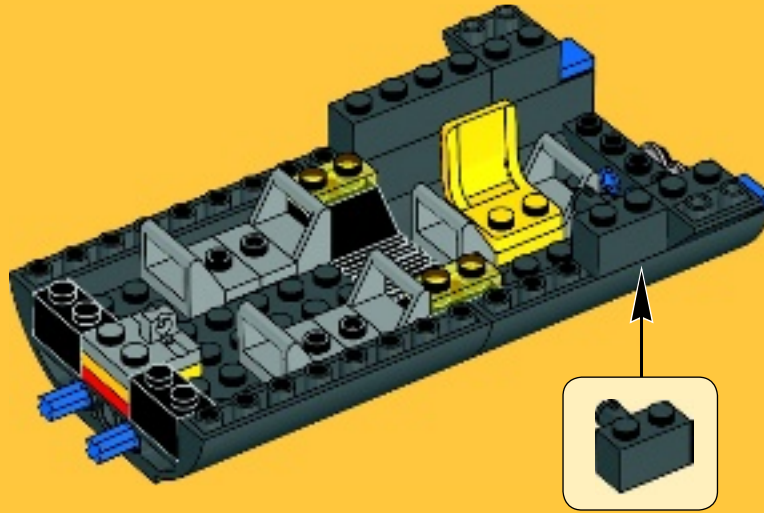

4x



1x



2x

17

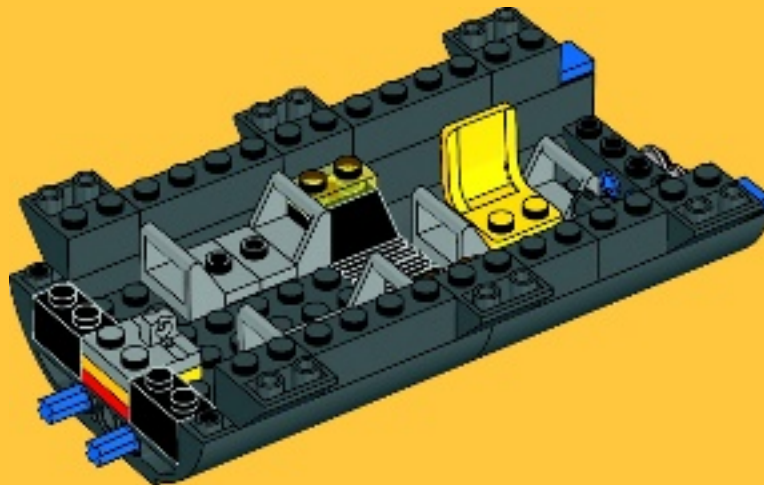



2x

18

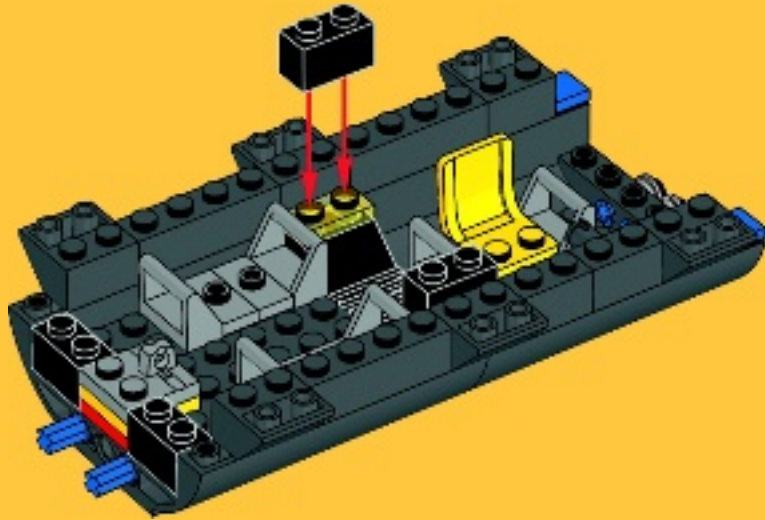

2x

19



2x

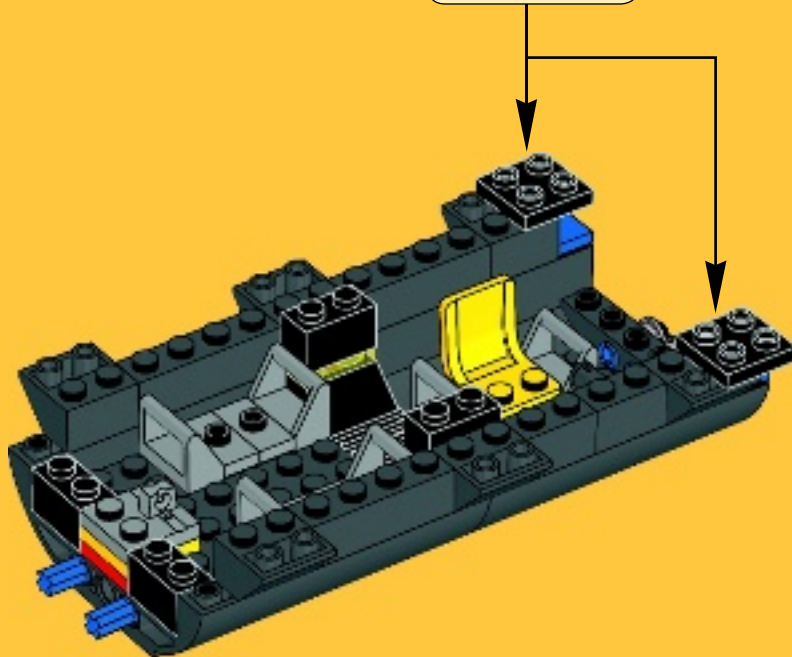



4x

20

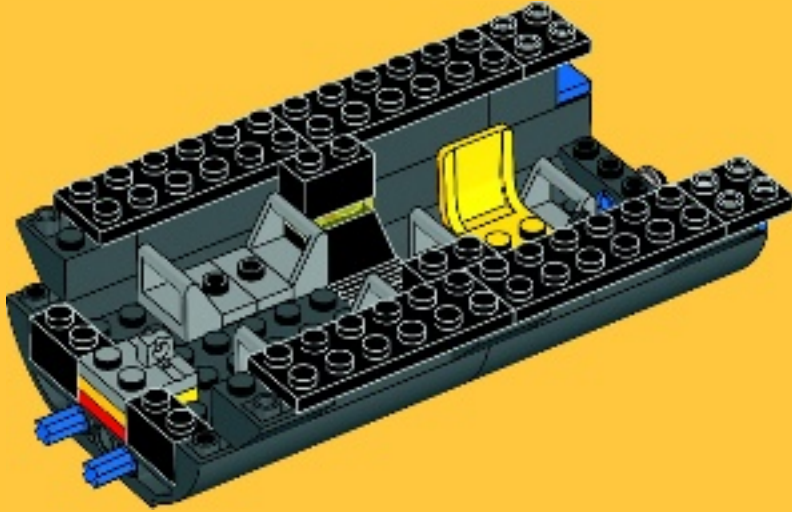

2x

21

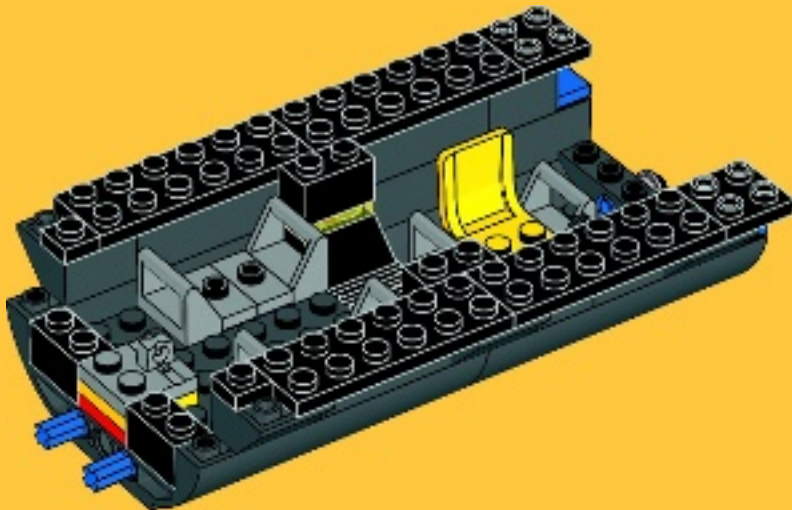

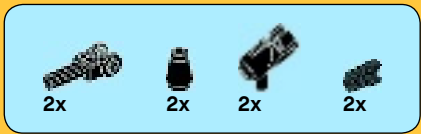

22

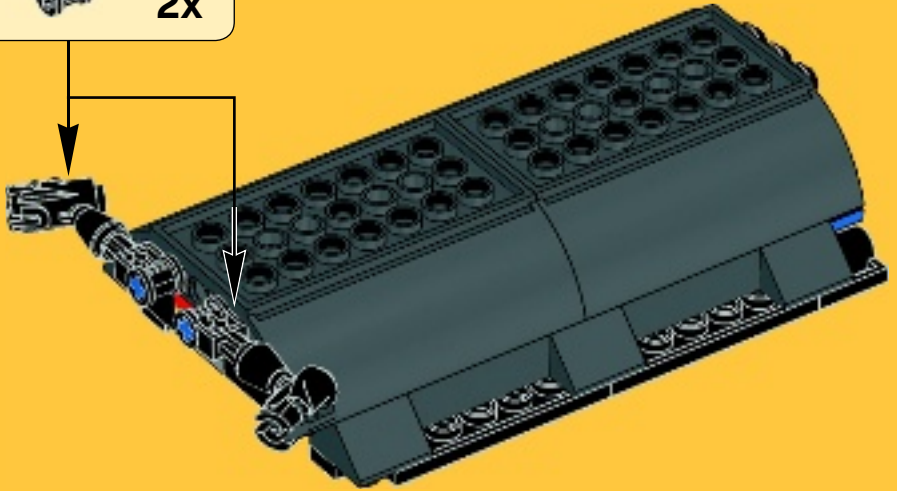
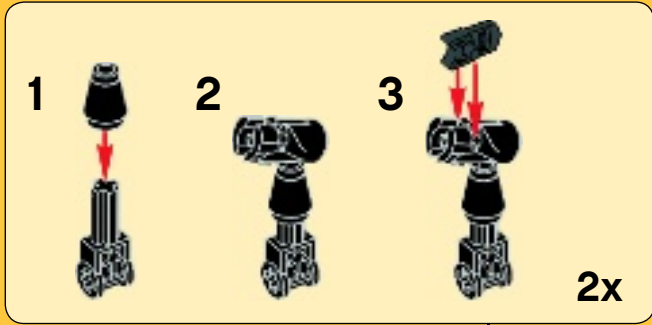

23

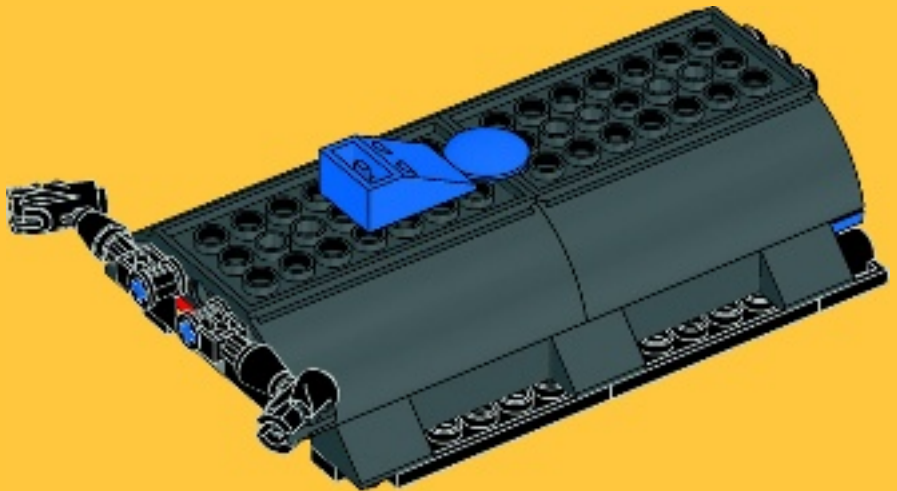

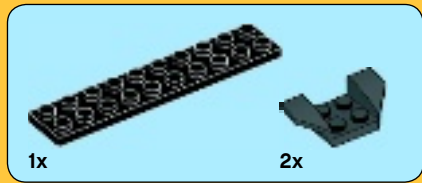

1



2



3



4



5

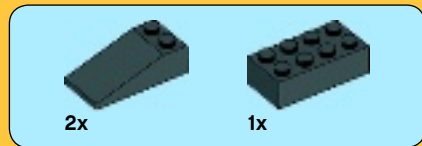

6





1x

7



2x

8



24

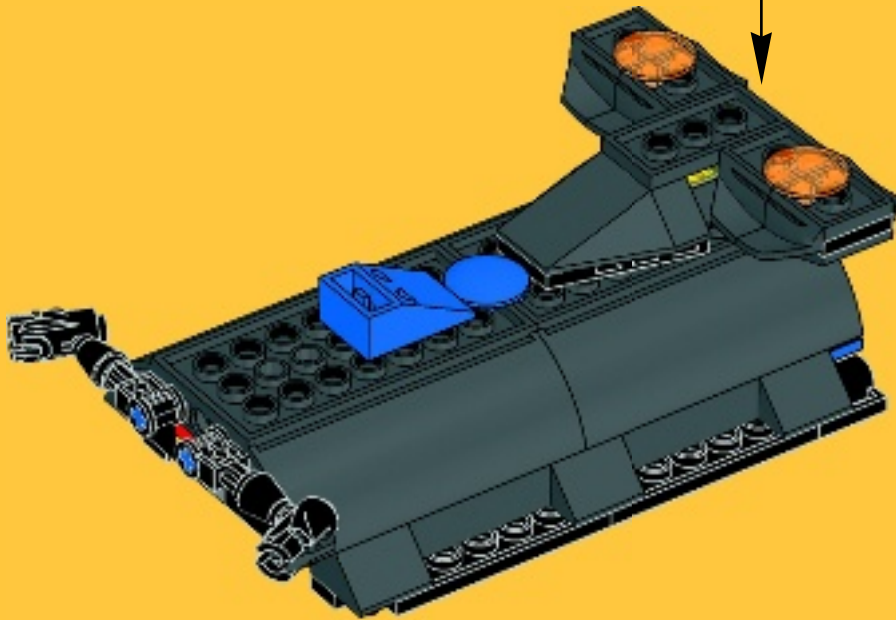



1x

1



2x

2



1x

3



2x

4





5



6



7

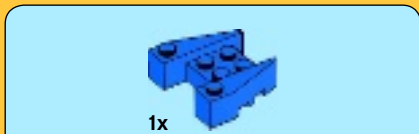
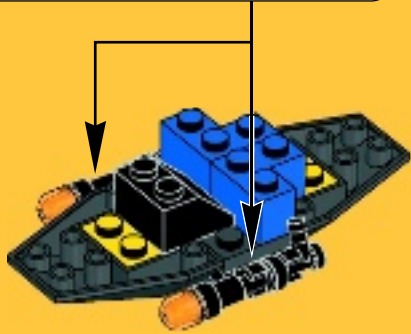
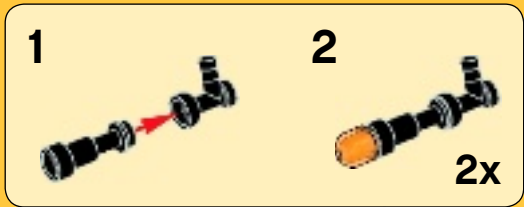

8



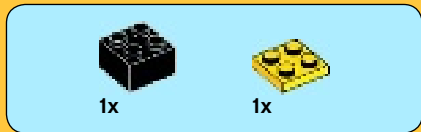

9

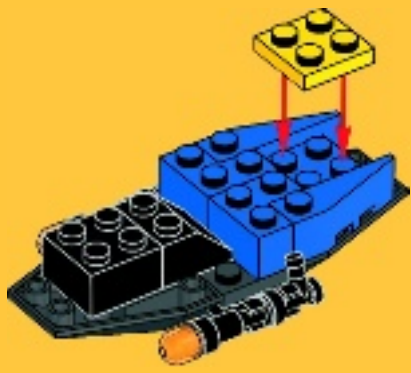

11



10

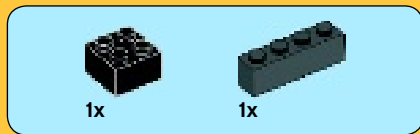

12





2x

13



25

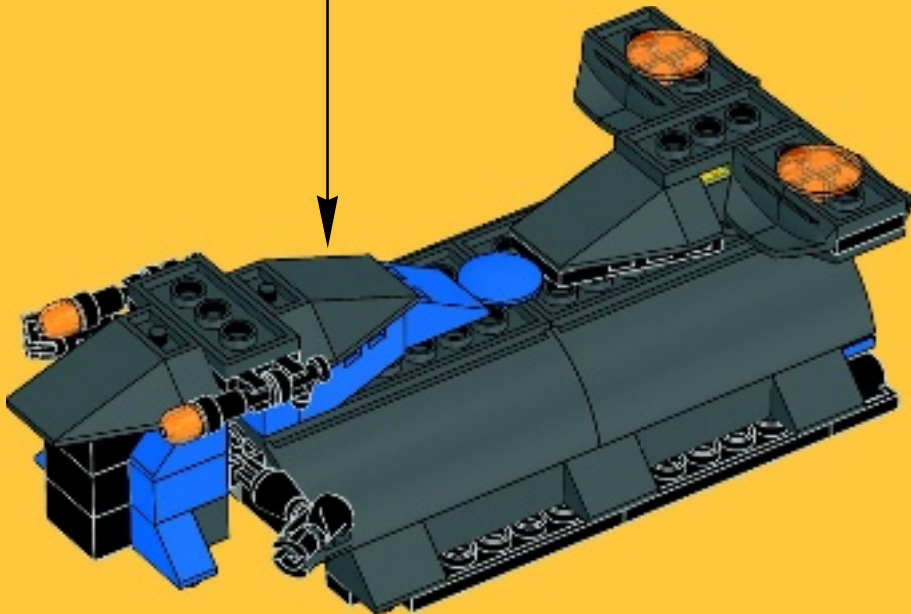



2x

26

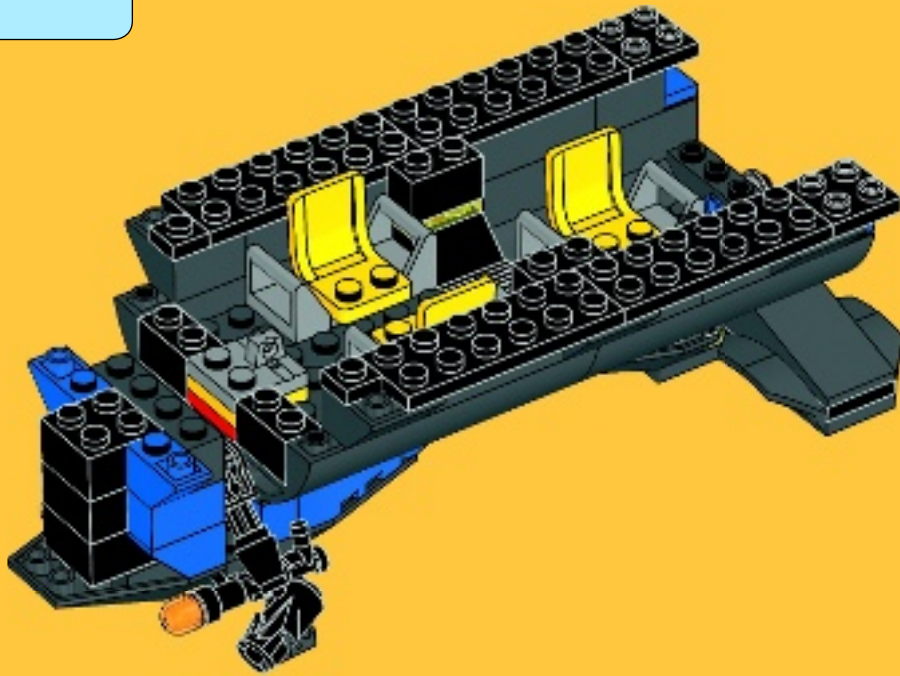

1x



2x



1x

27

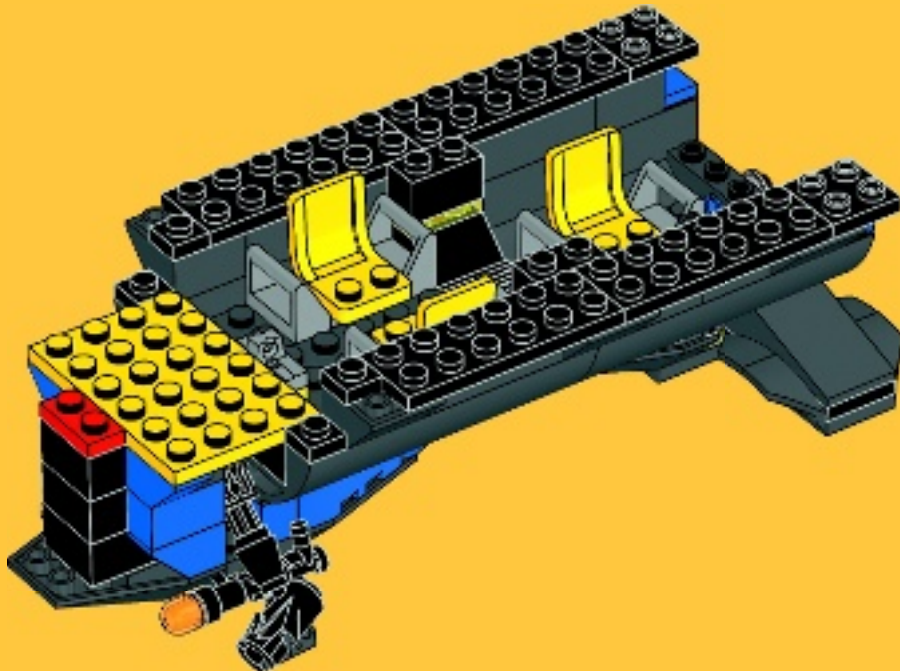

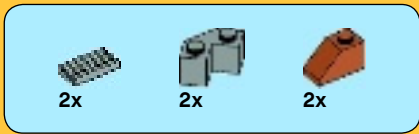

28

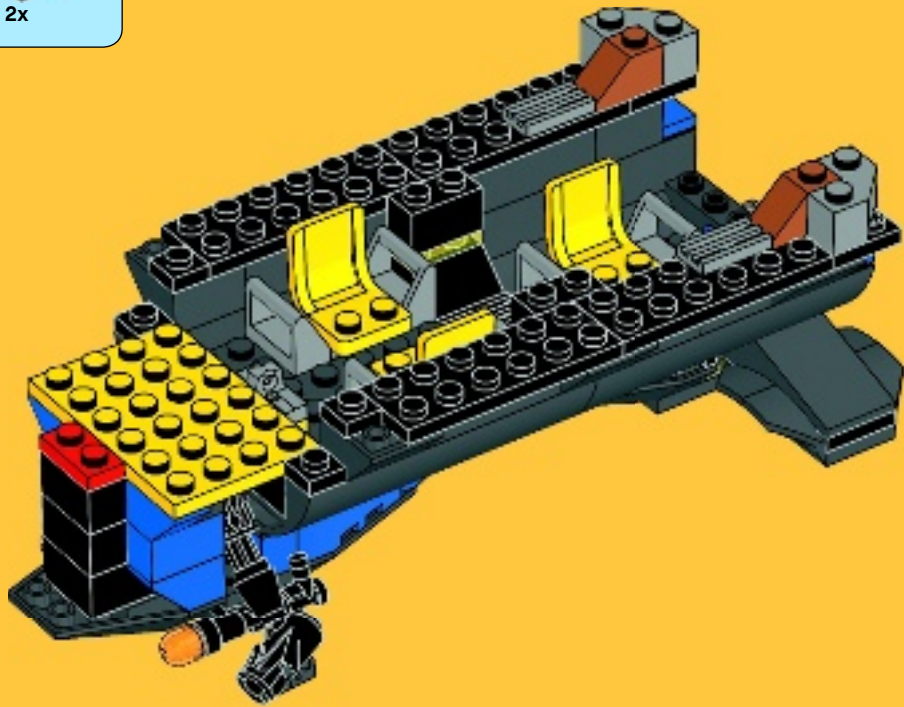

29

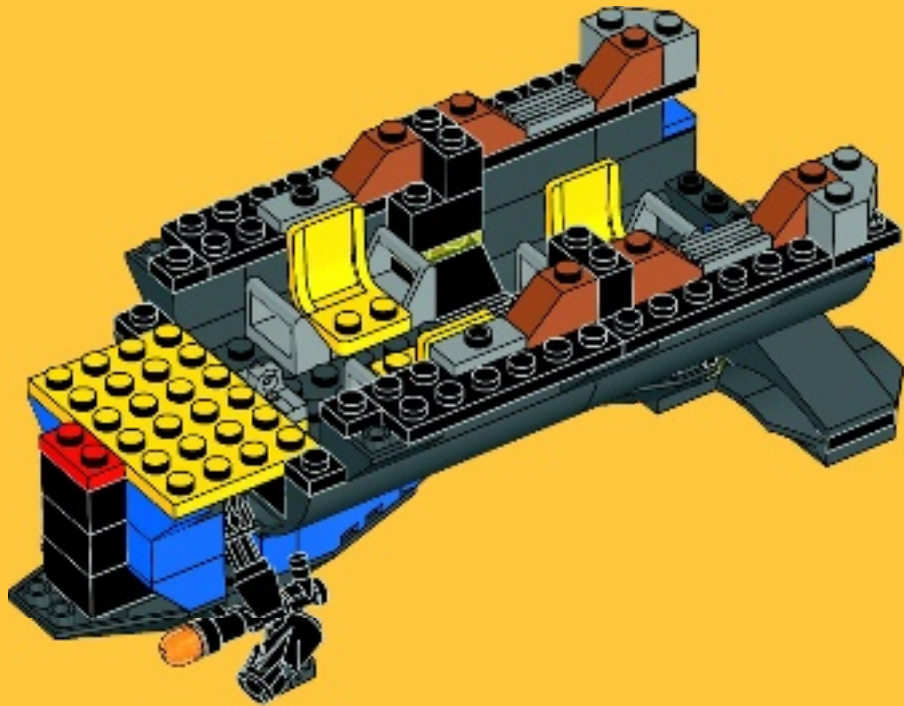



2x



2x

30

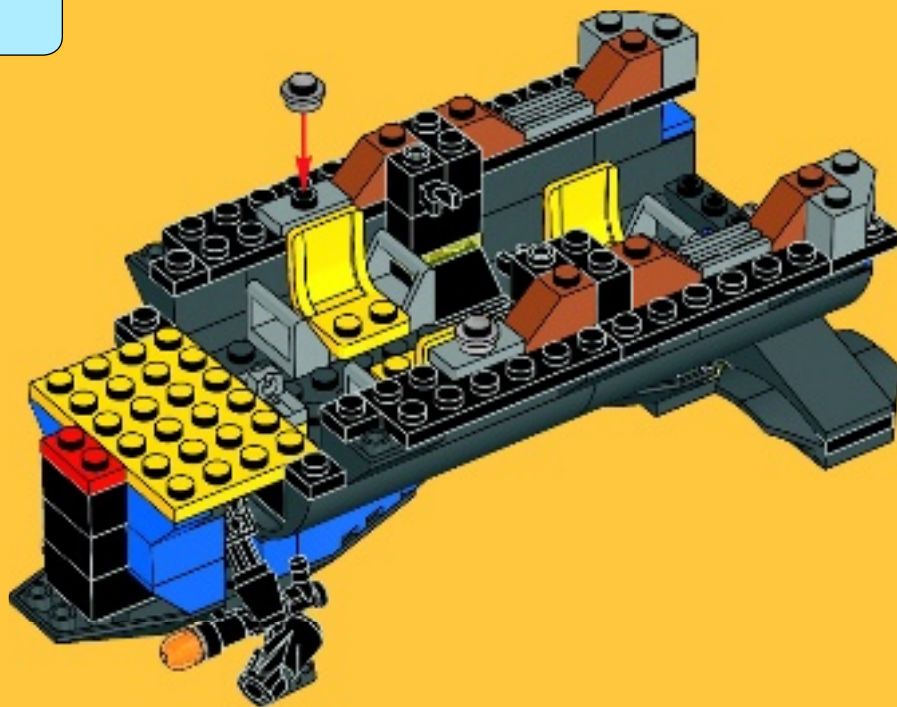

2x



2x



2x

31

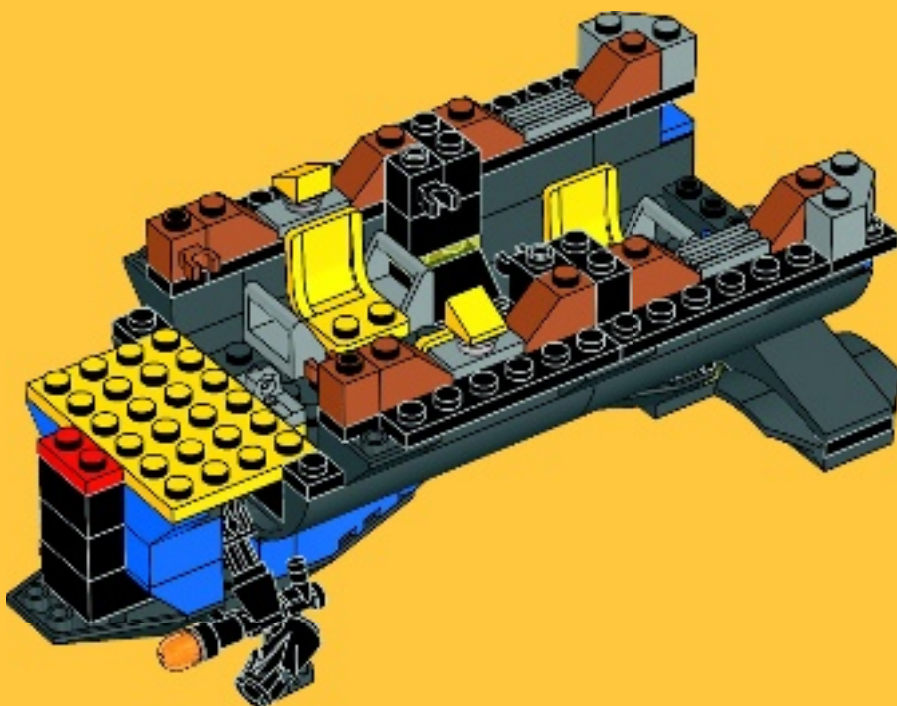



2x



2x

32

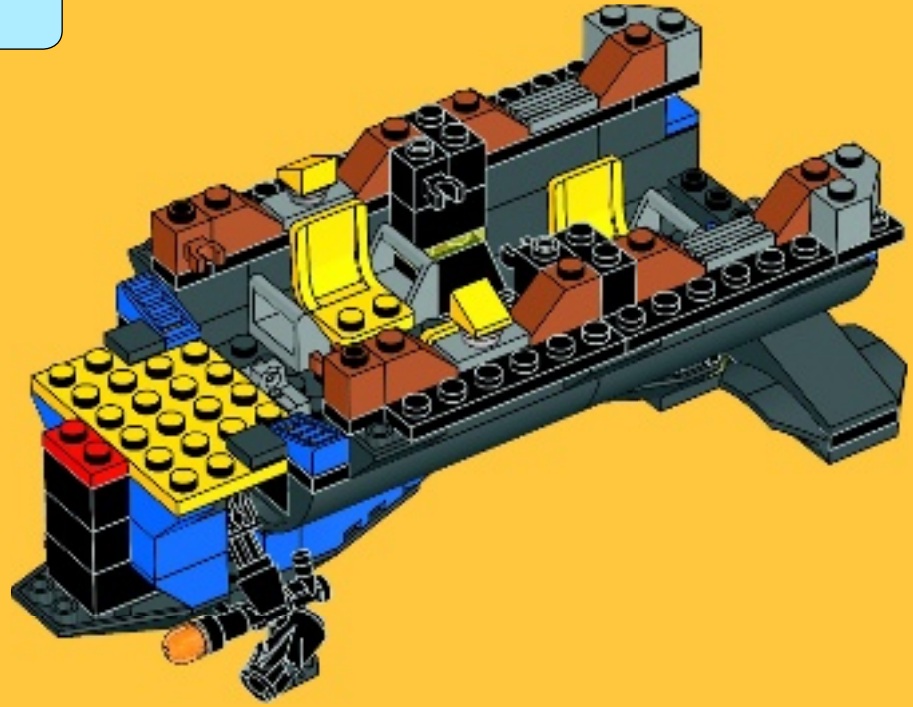

2x



1x



2x

33

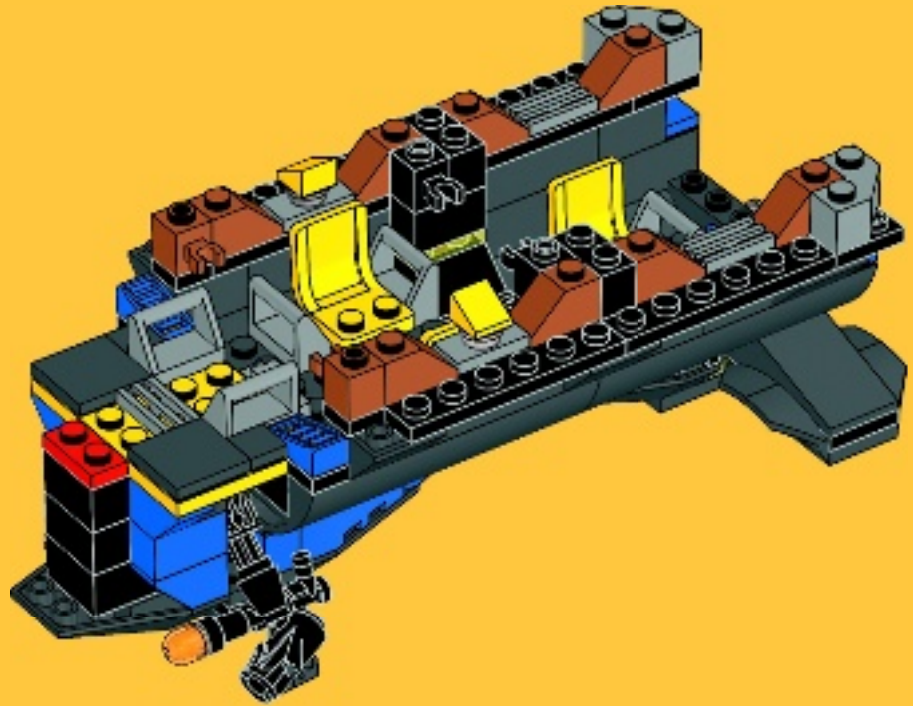

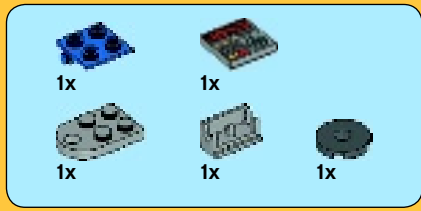

34

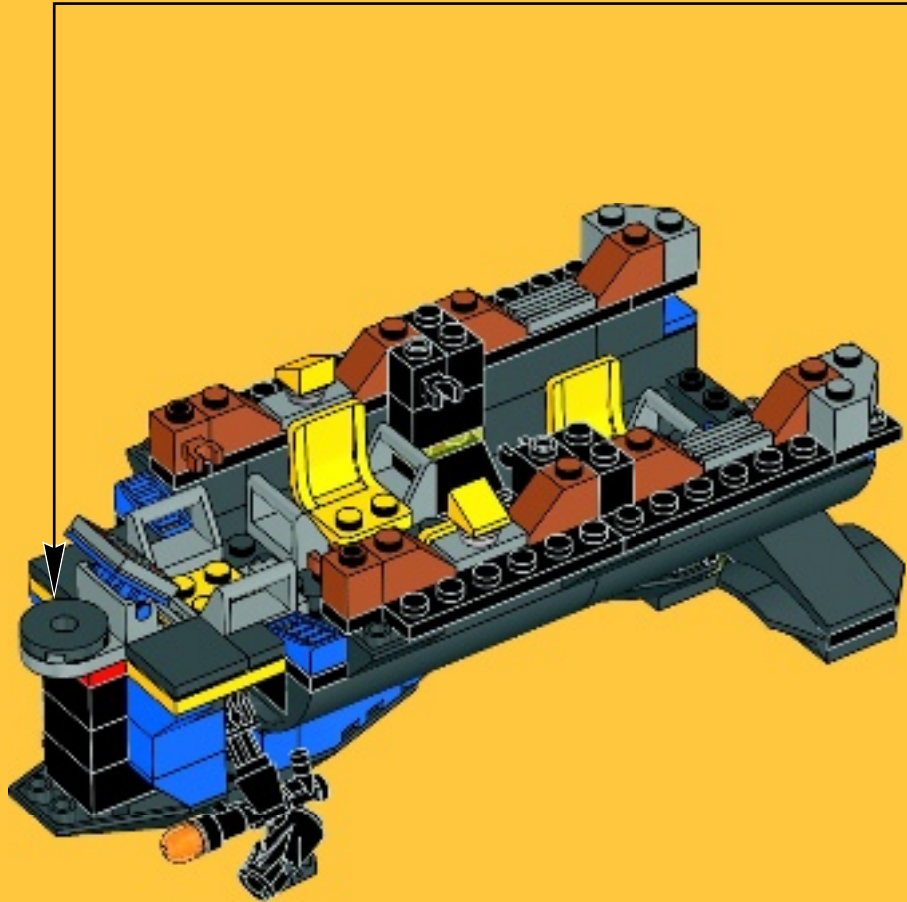



6x

35

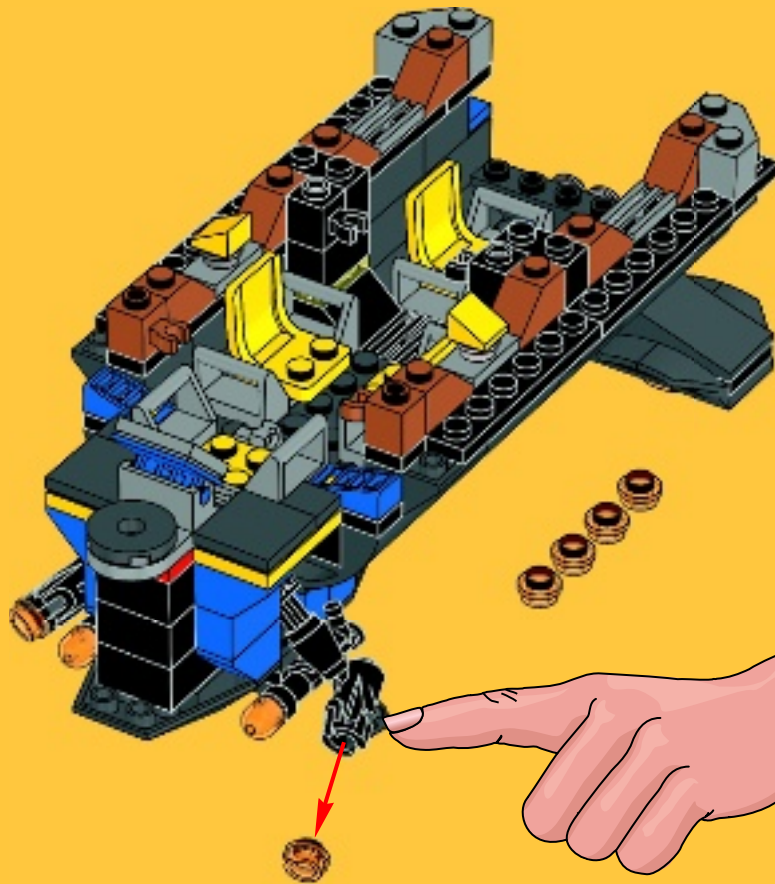
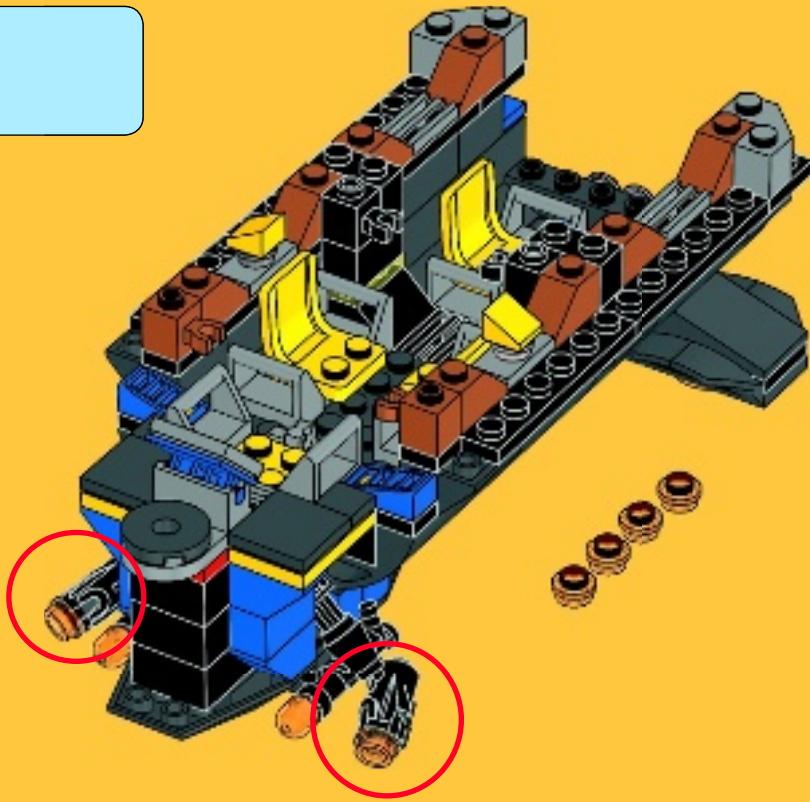

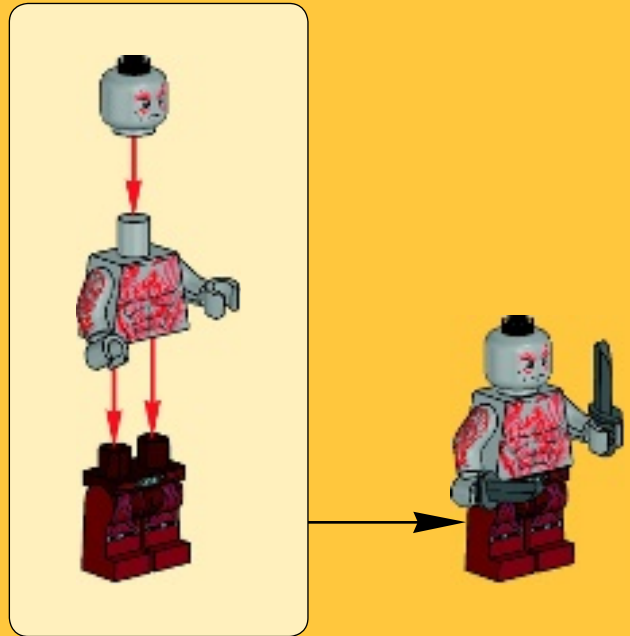

36

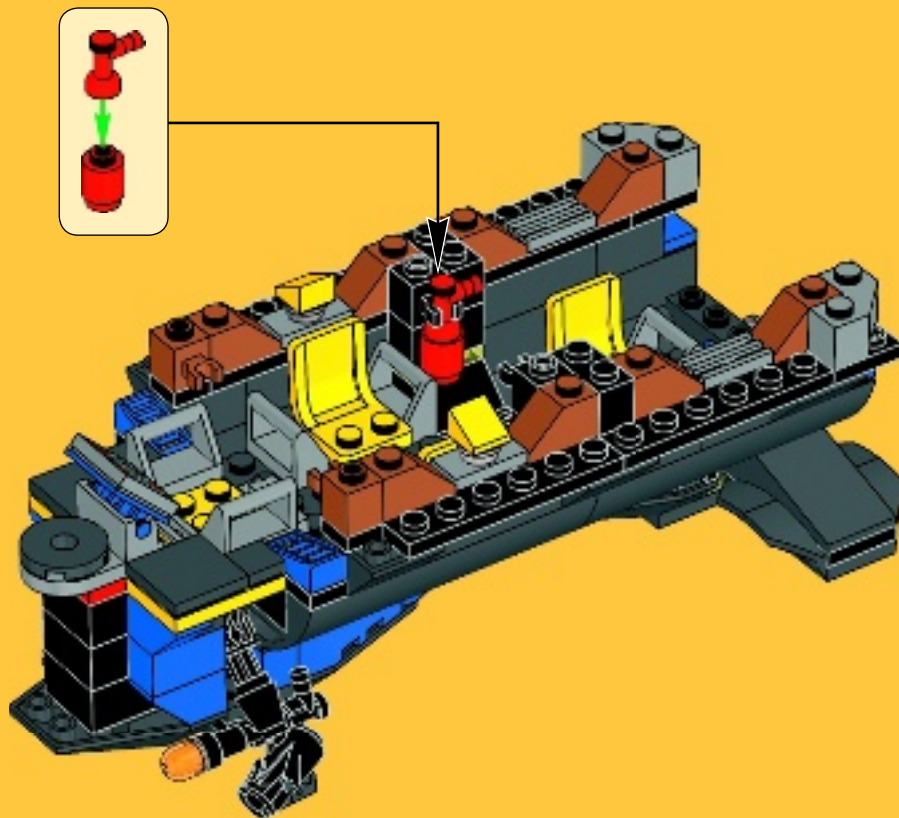



37

1



2



3



4



5

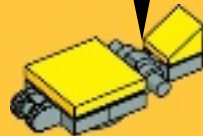

6

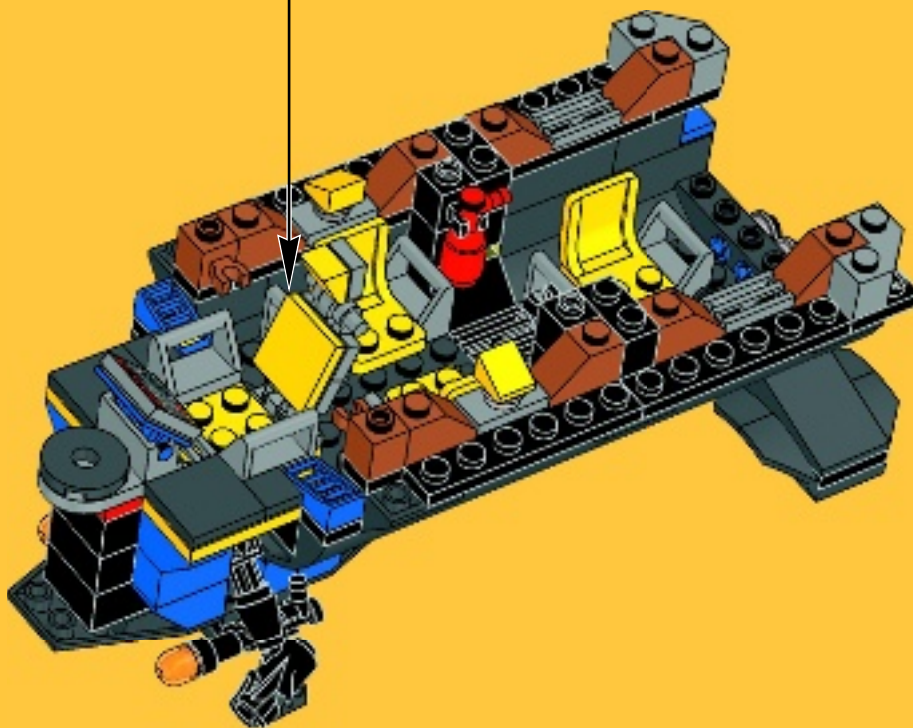
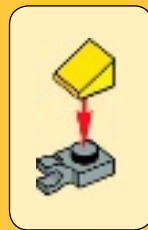

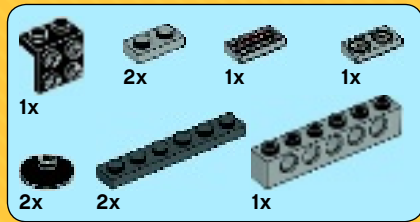

38

1



2



3

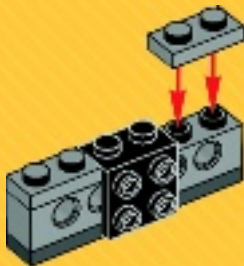

4



5



6

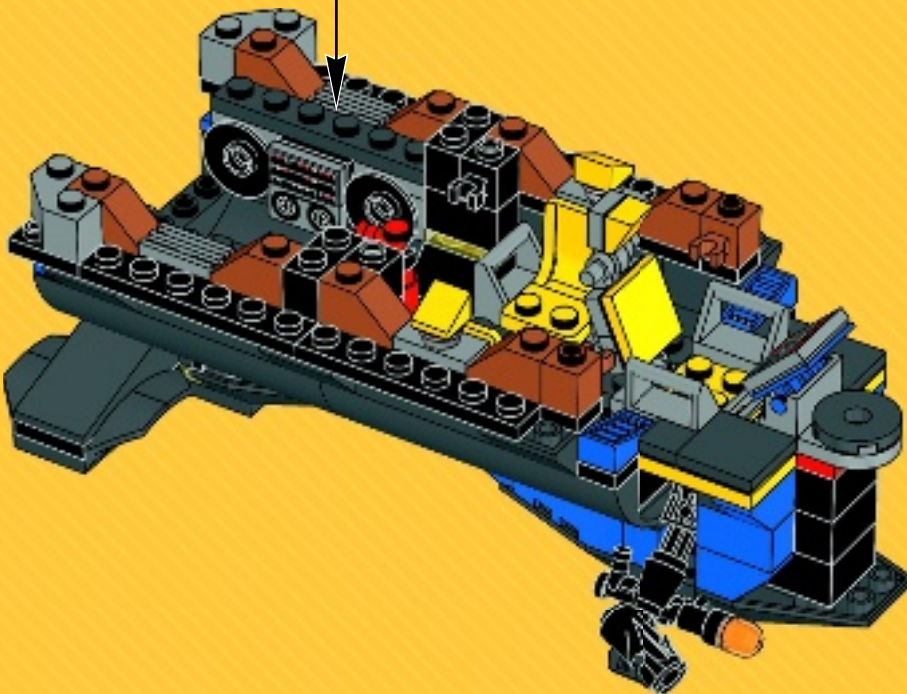

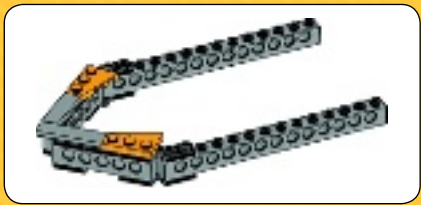

1

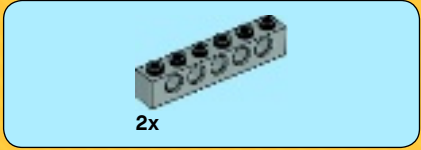

2

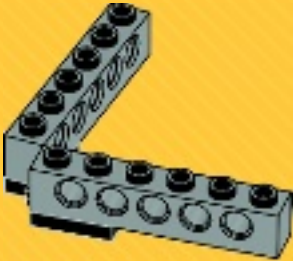

3



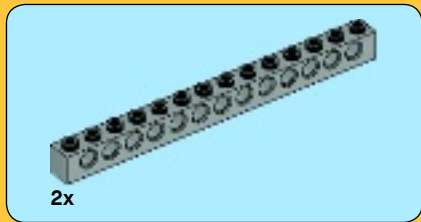

4

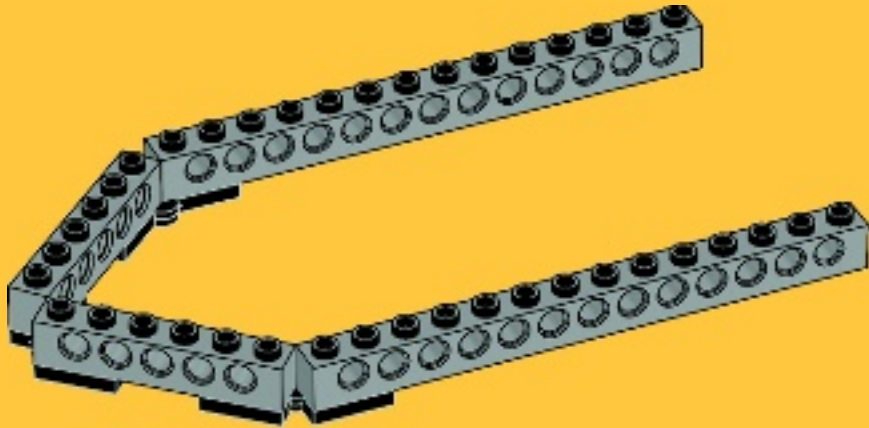

5

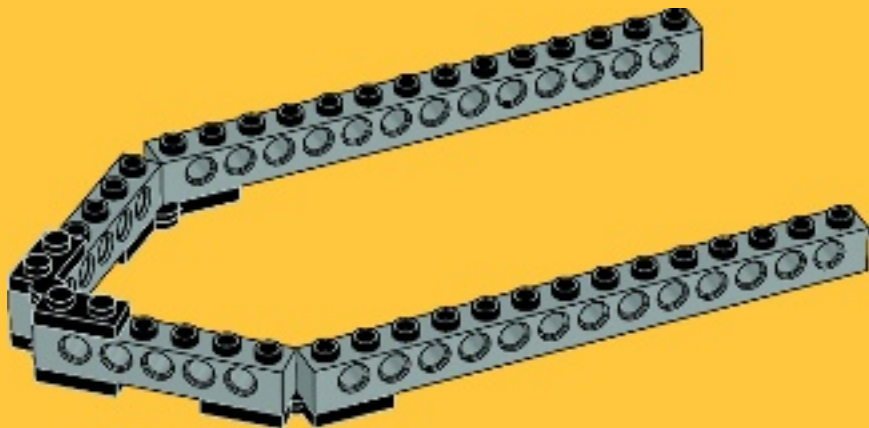



6

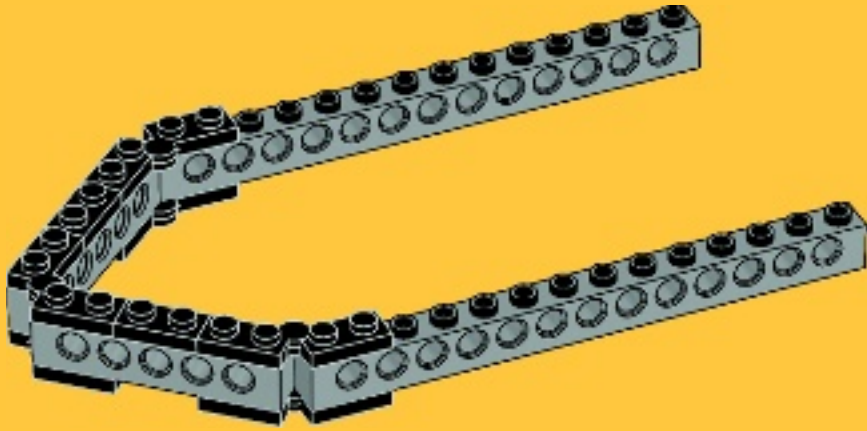

7

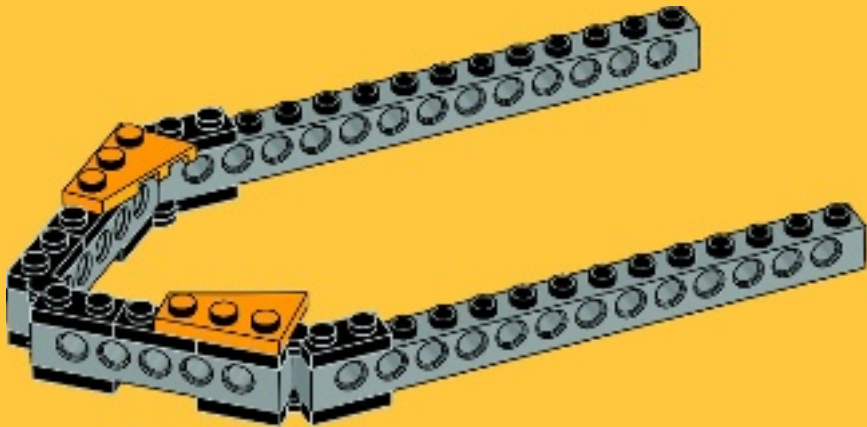



8

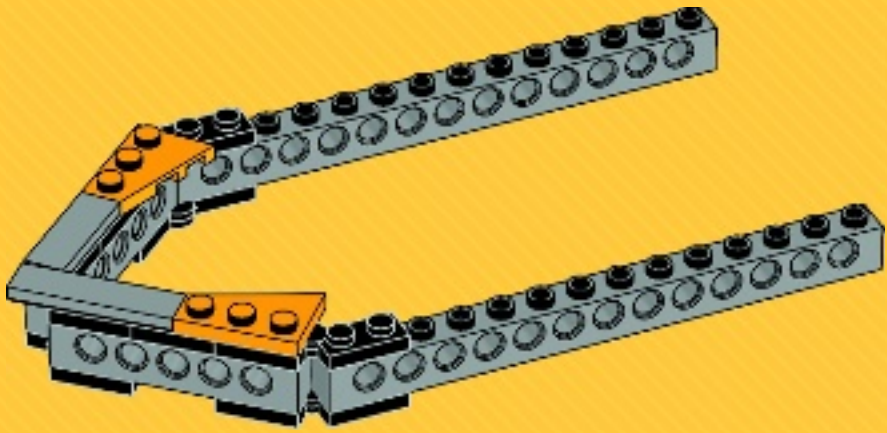

39

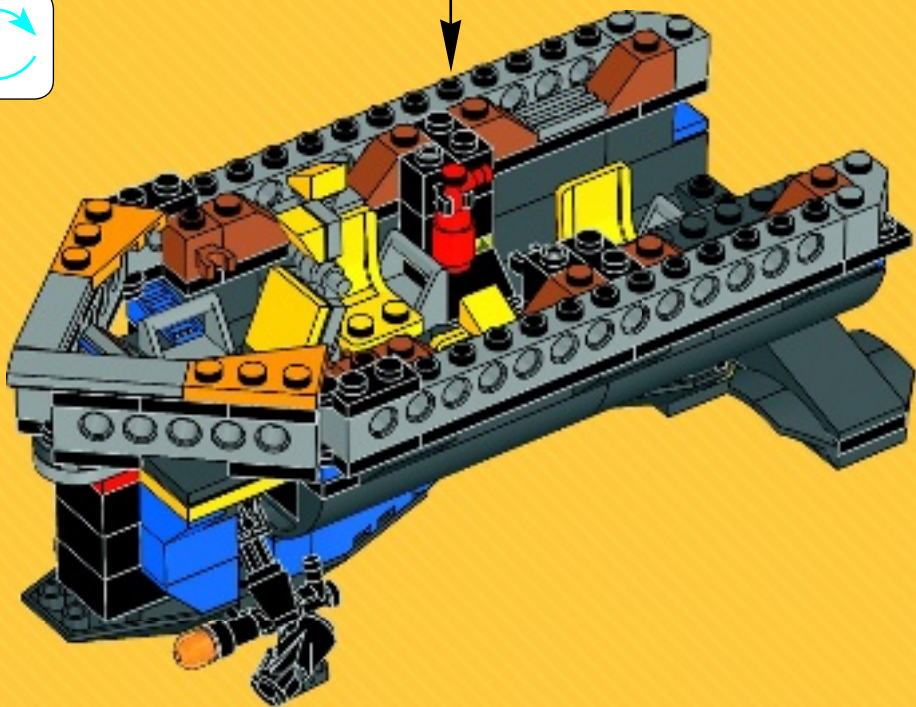

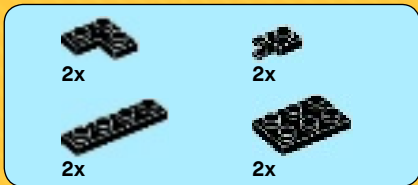

40

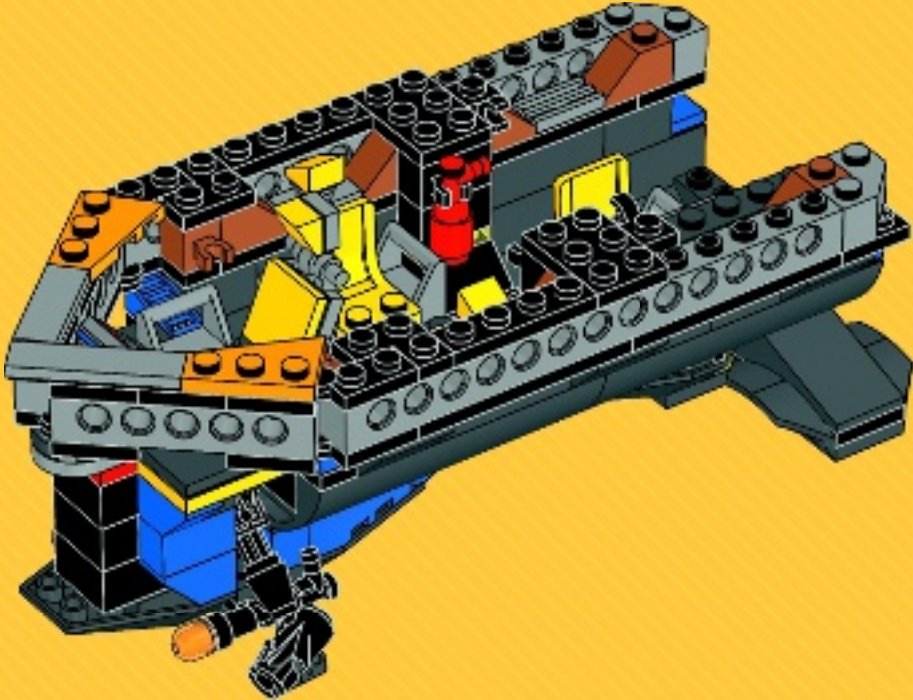



41

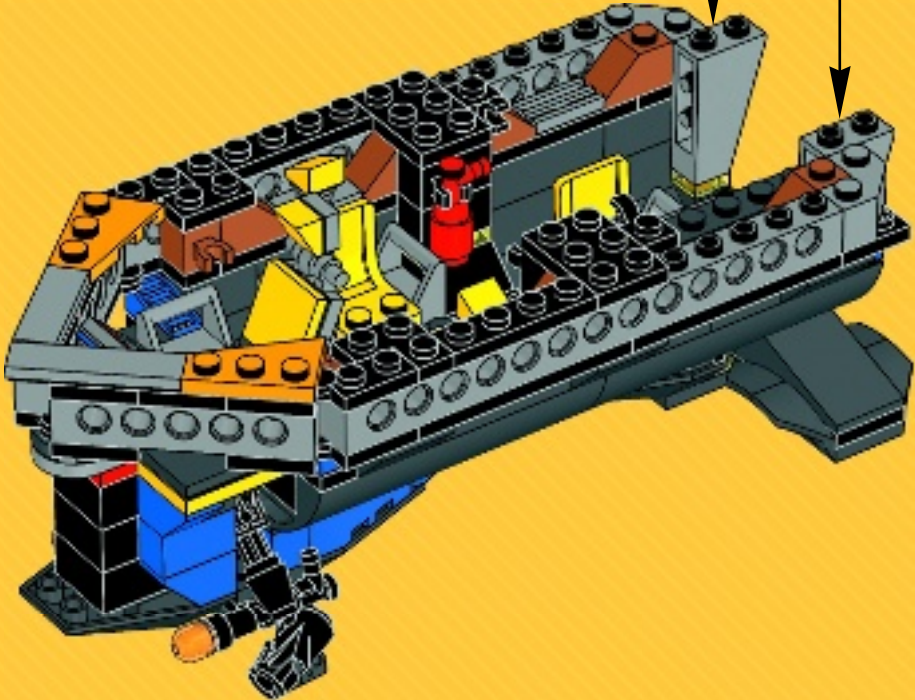
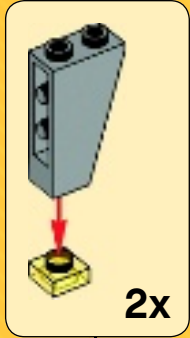



4x



2x

42

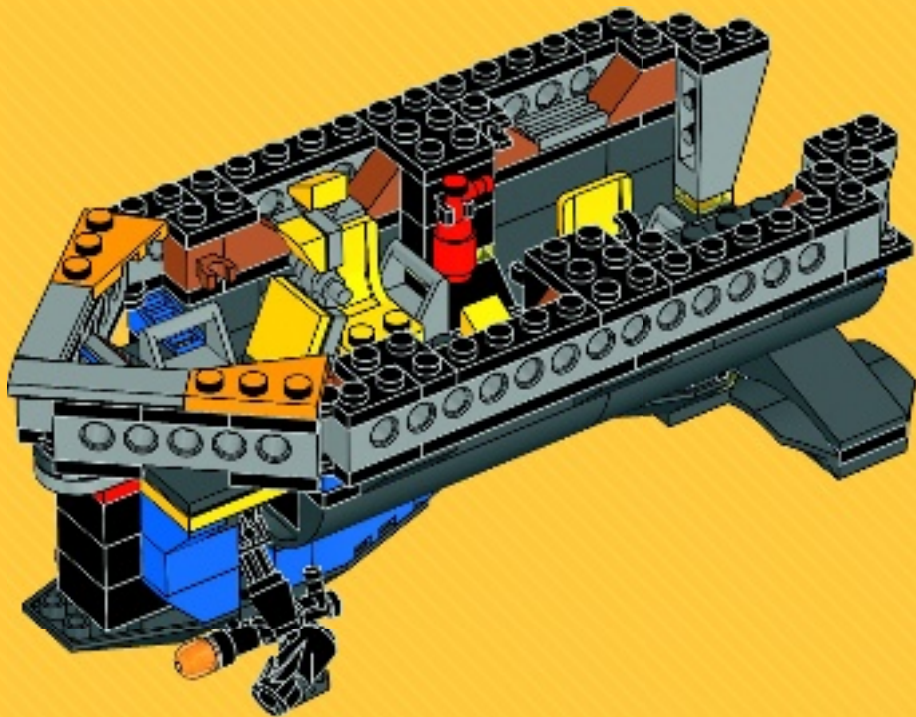

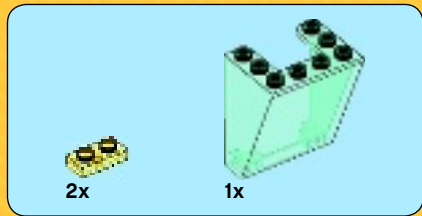

43

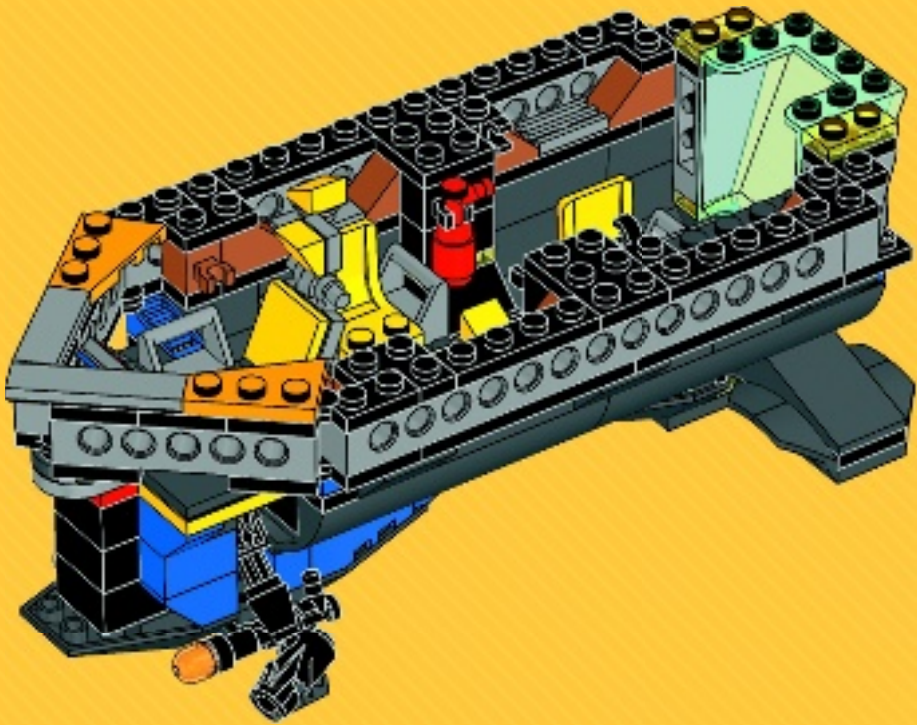



44

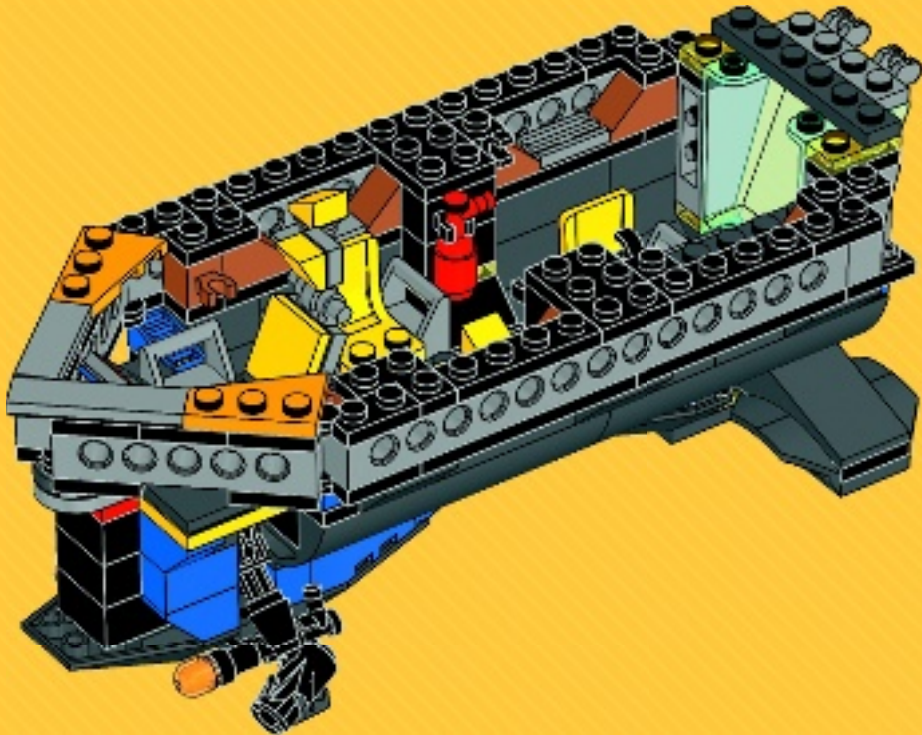



2x

45

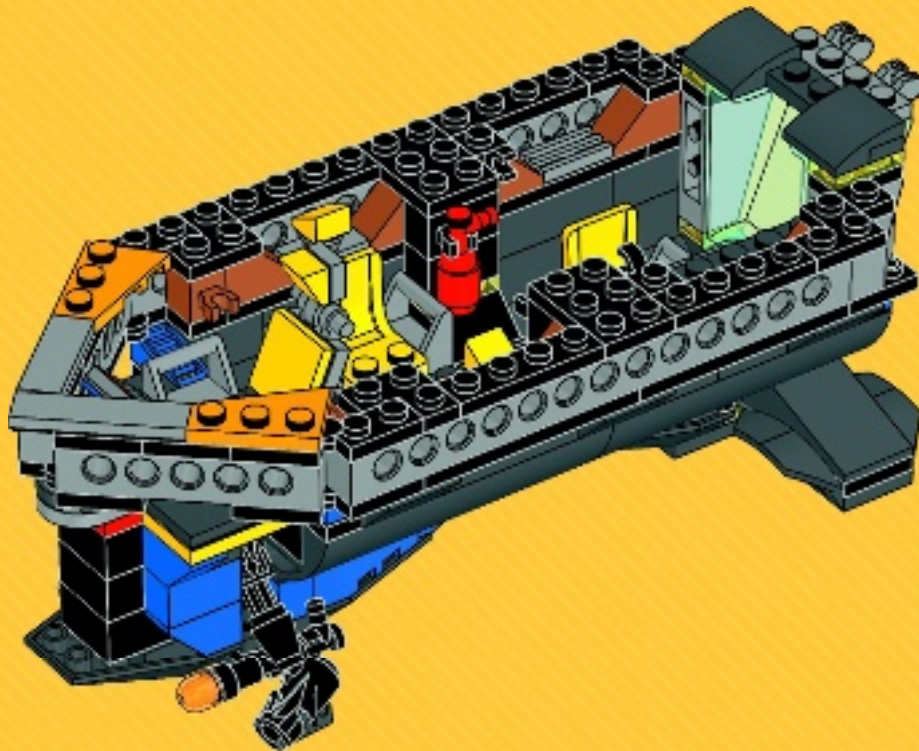

2x



1x

46

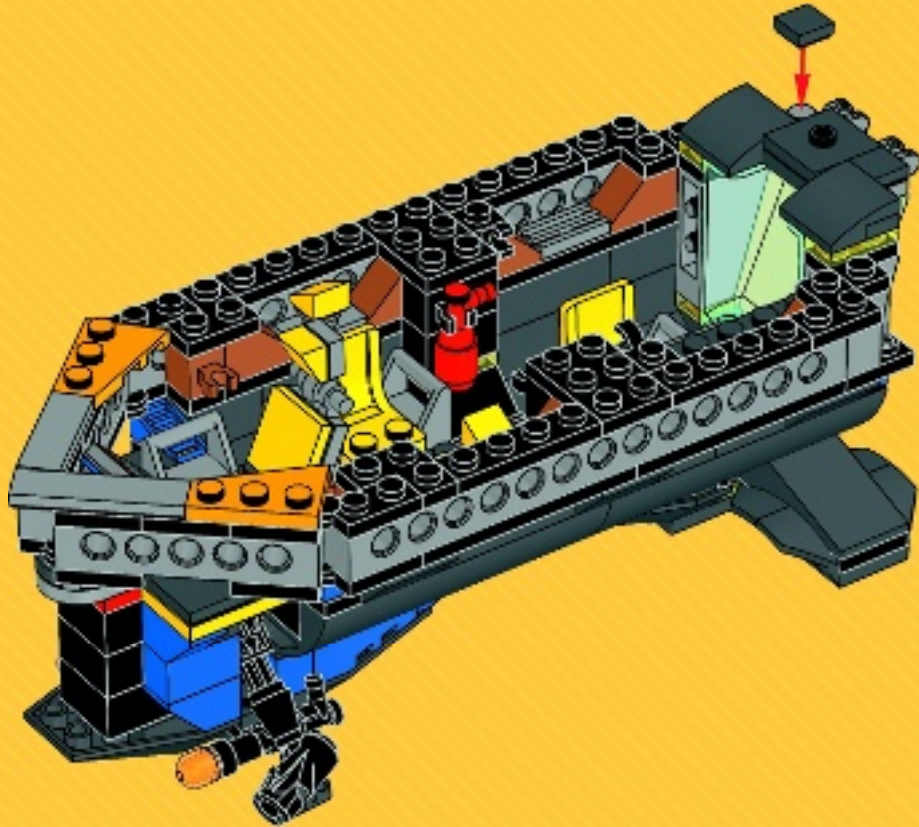

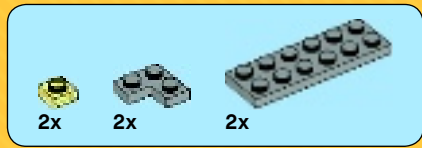

47

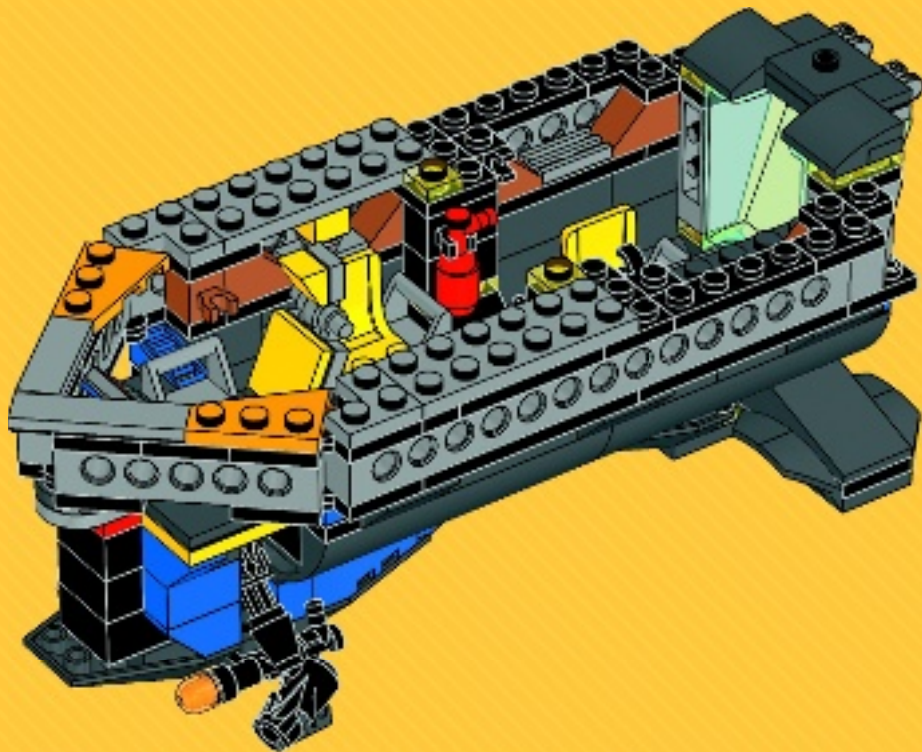



1x

48

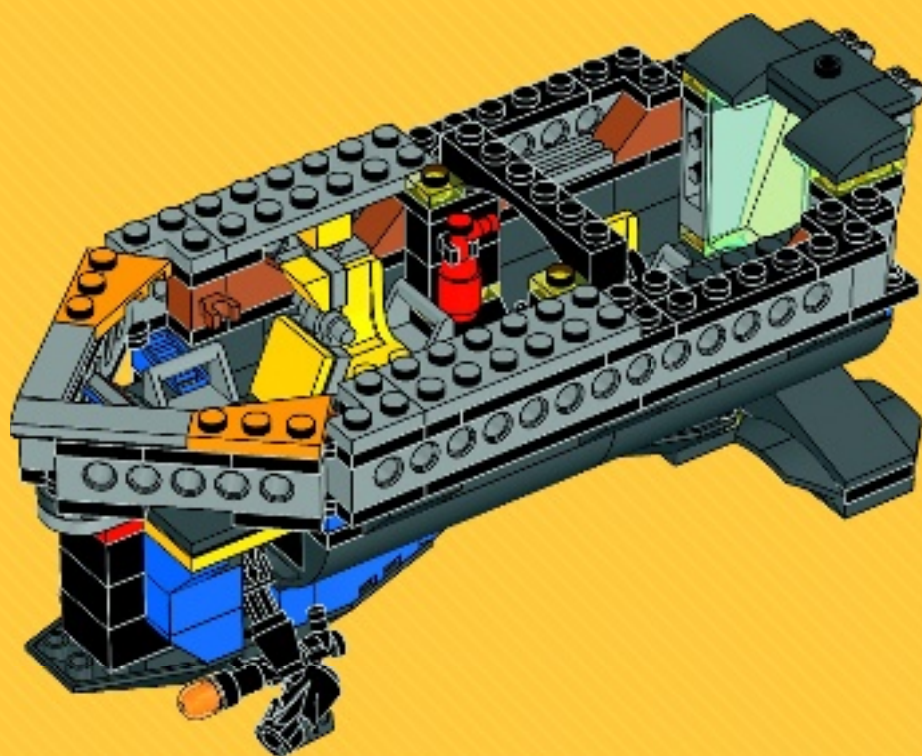

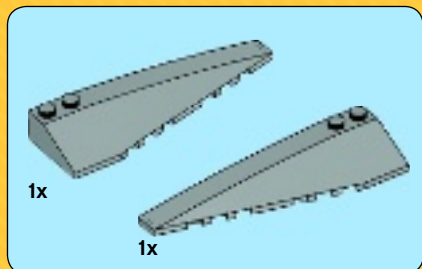

49

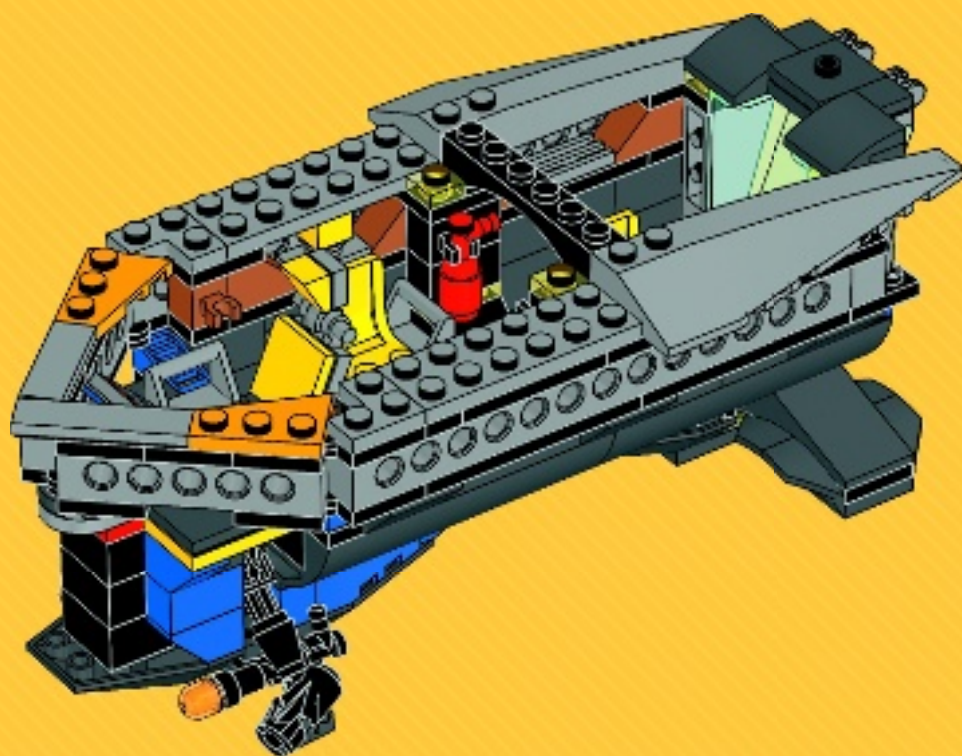

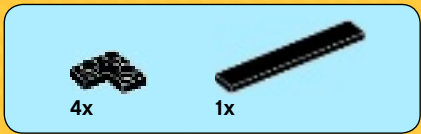

50

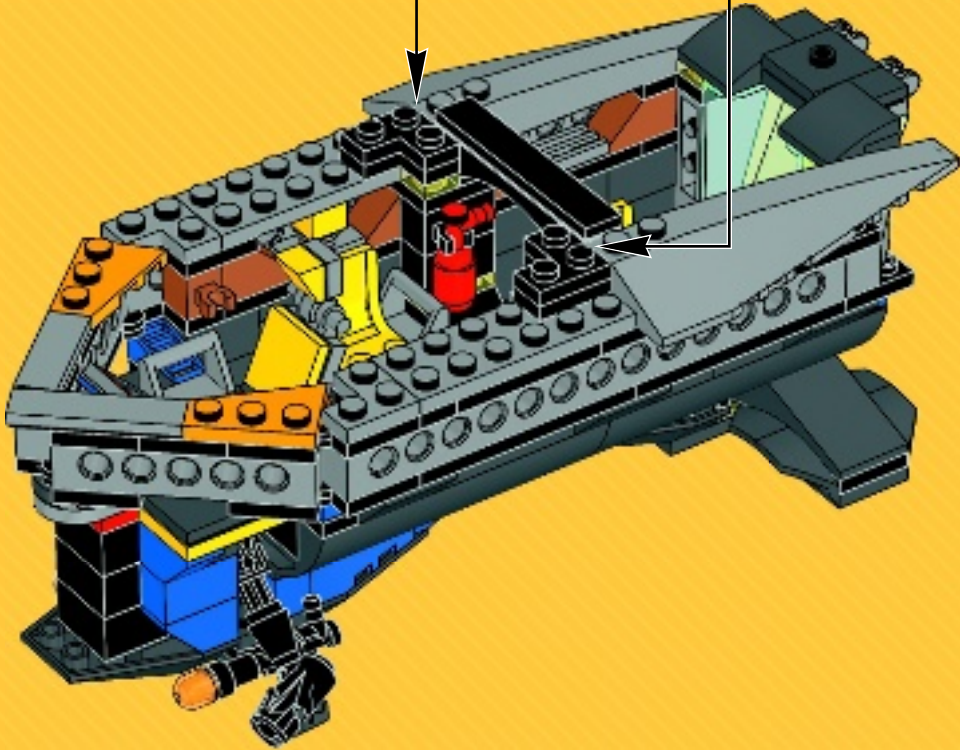
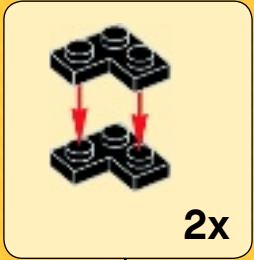

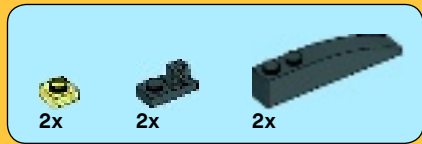

51

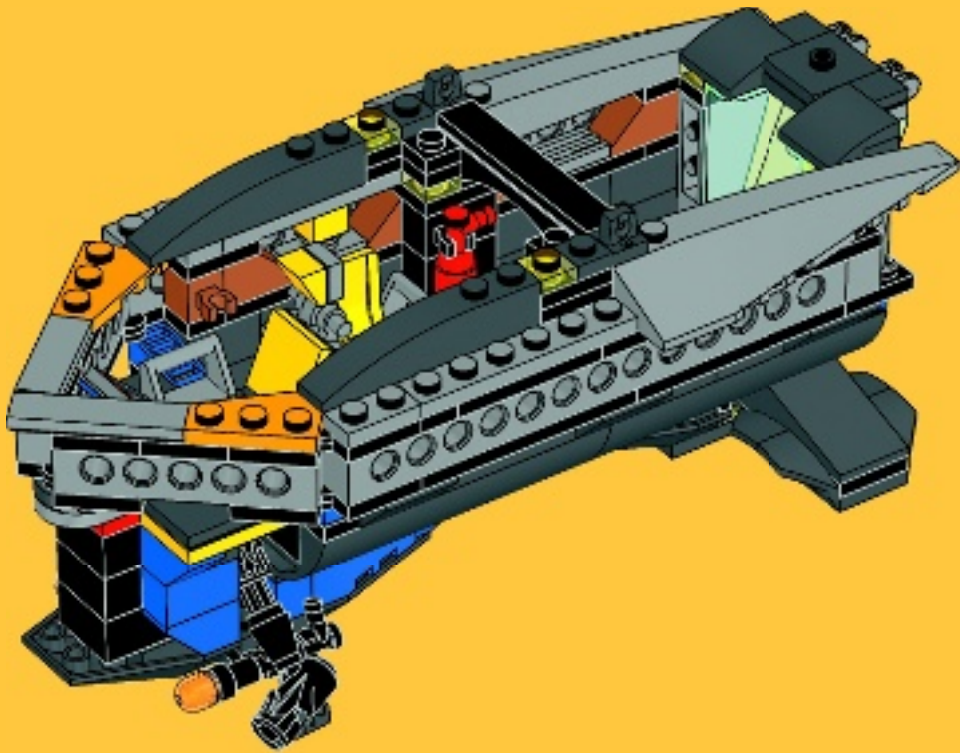



1x

1



2x

2



1x

3



1x

4



1x

5



1x



1x

6

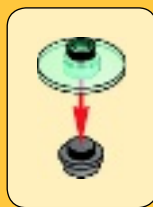



7

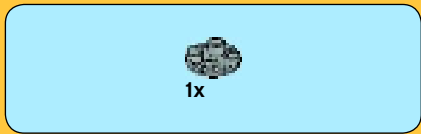

8



52

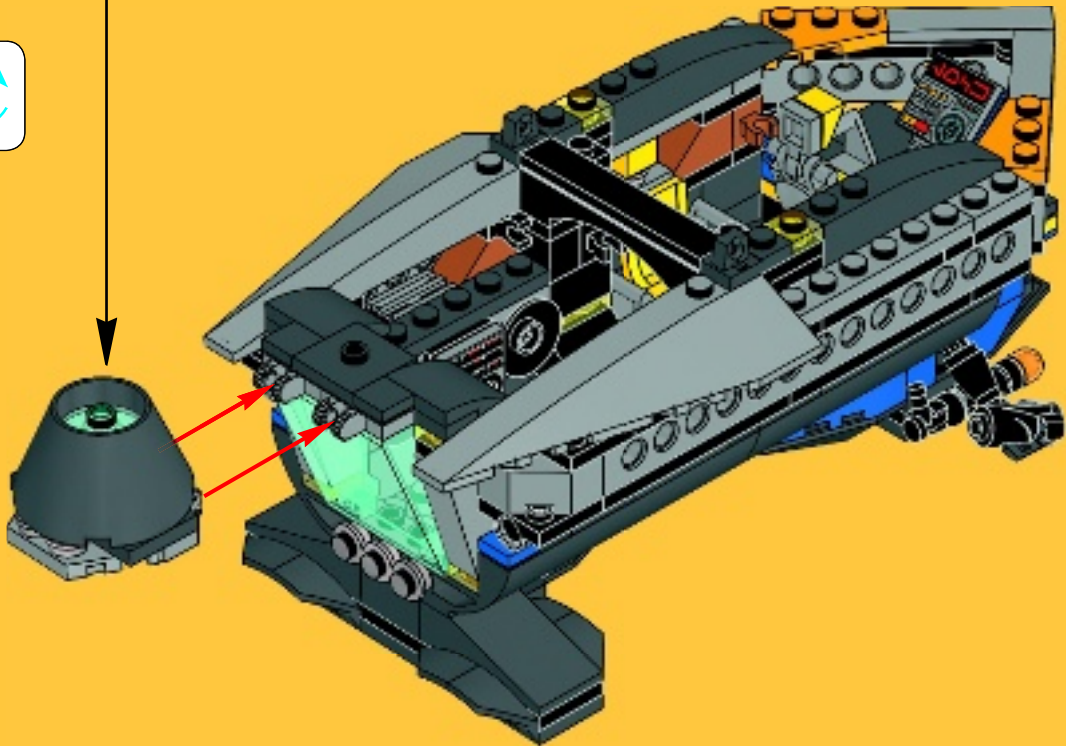



2x



1x

1



1x

2



1x

3



1x

4



6x

5



1x

6



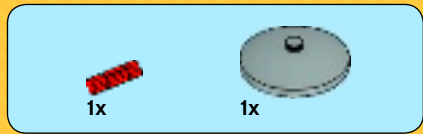

7

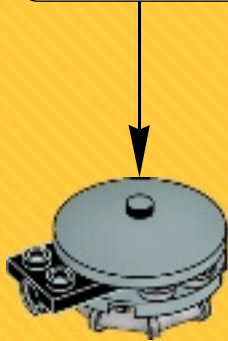
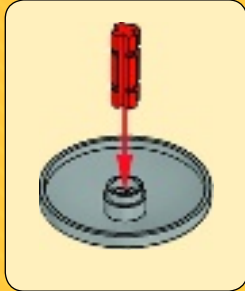

8



9

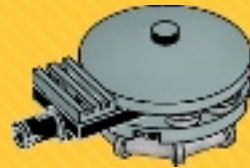
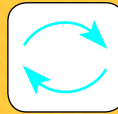

2x

53

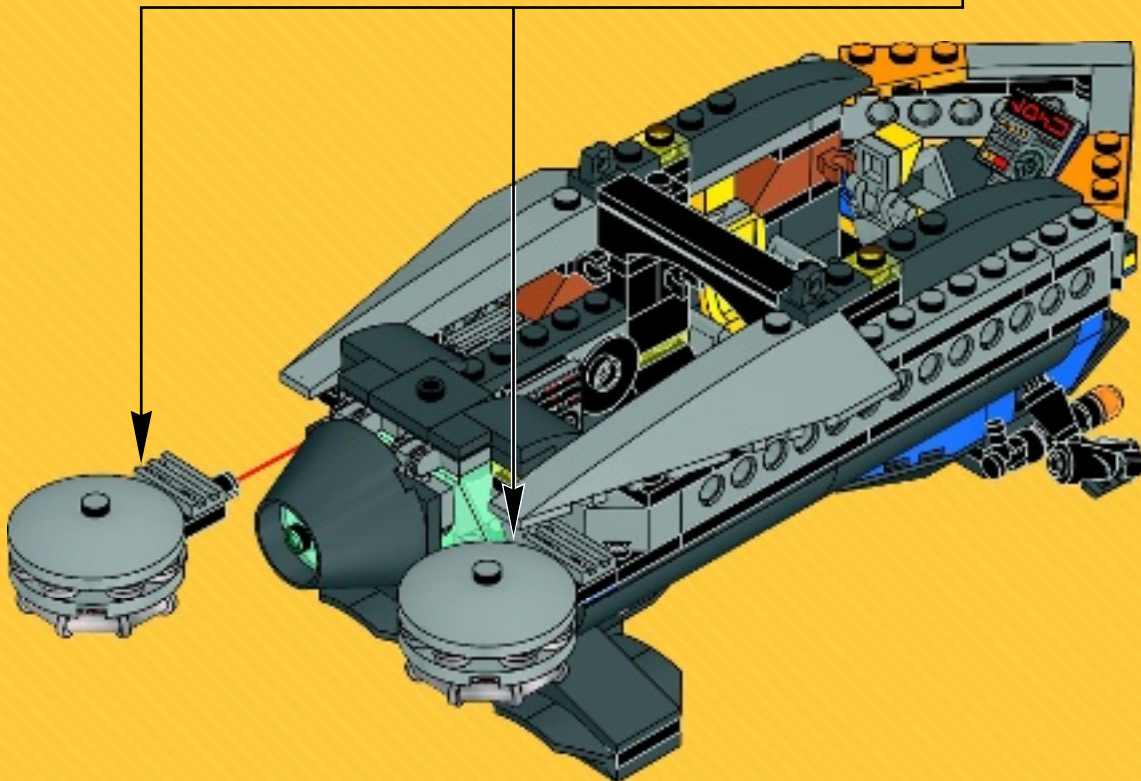



54

