



SCOOBY-DOO!

75901

 [LEGO.com/scoobydoo](https://www.LEGO.com/scoobydoo)



WARNING: CHOKING HAZARD.
Toy contains small parts and a small ball.
Not for children under 3 years.





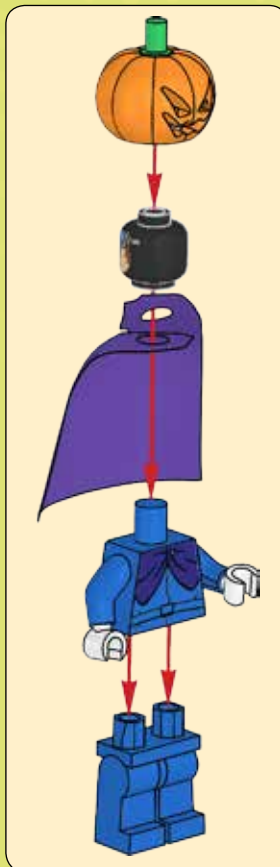
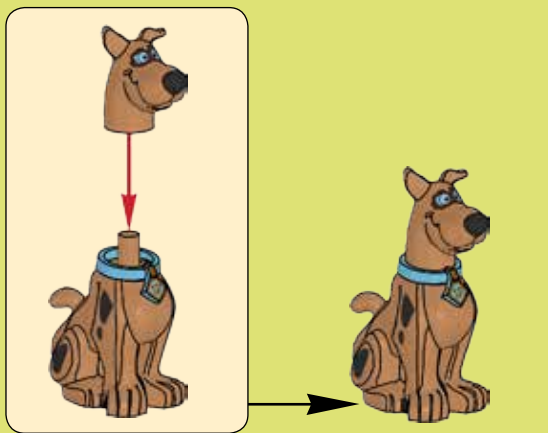
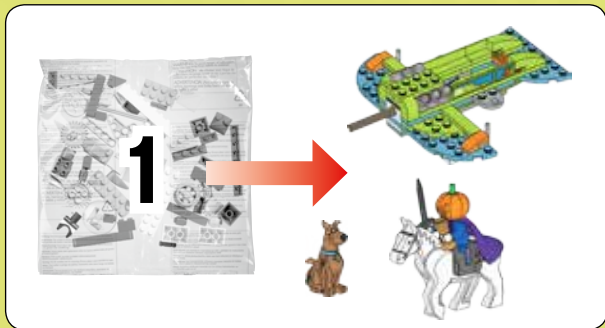

⚠️ AVERTISSEMENT :
RISQUE D'ÉTOUFFEMENT.
Le jouet contient des petites pièces ainsi qu'une petite boule. Il ne convient pas aux enfants de moins de 3 ans.

⚠️ ADVERTENCIA:
PELIGRO DE ASFIXIA.
Juguete que contiene partes pequeñas y una pelota pequeña. No recomendado para niños menores de 3 años.



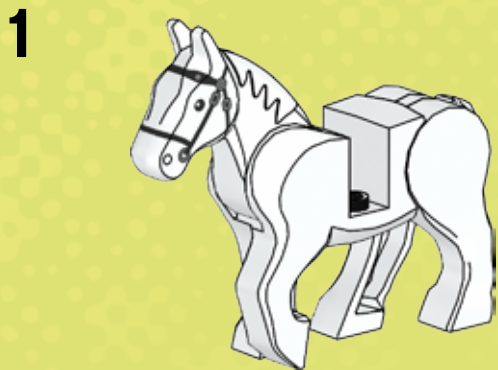
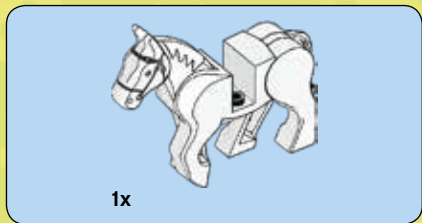

2

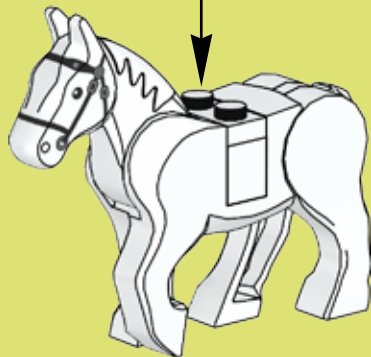
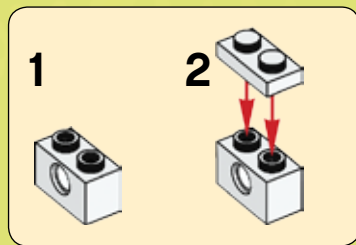

3

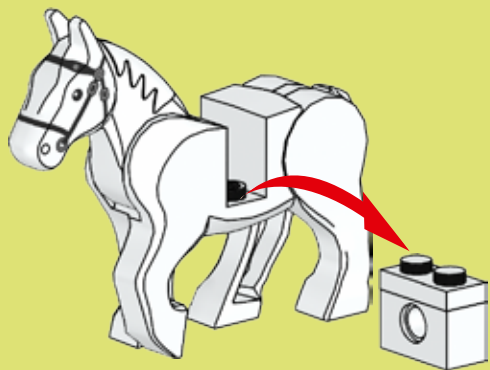

4



5



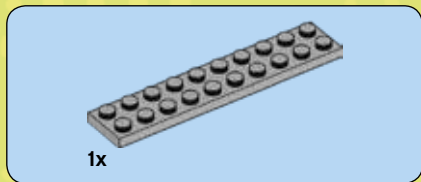
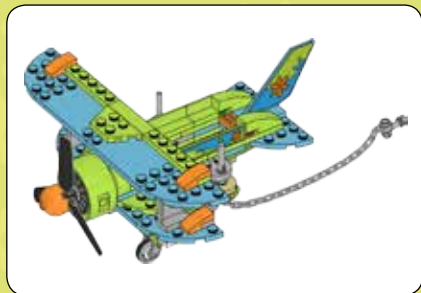

1

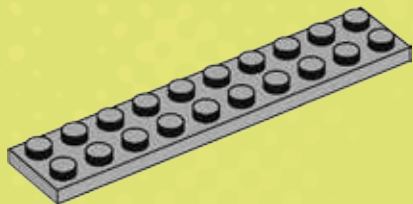

2

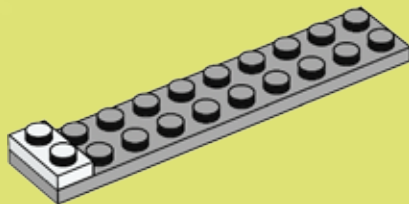

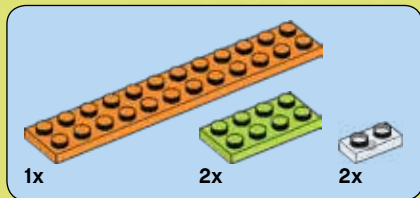

3

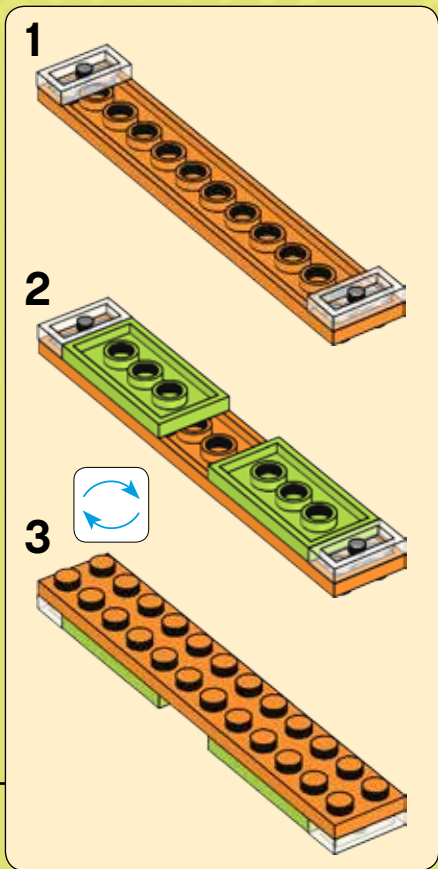
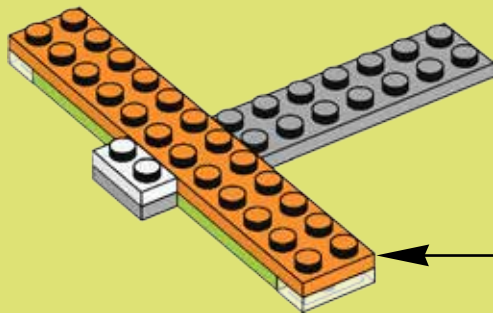



1x

4

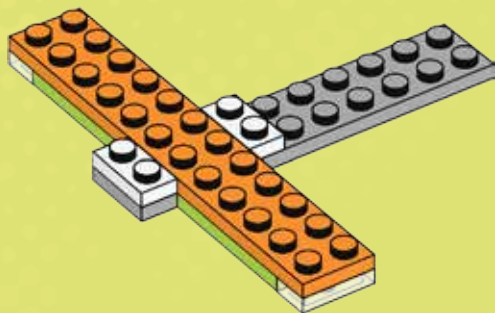

8

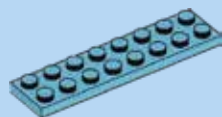

2x

5

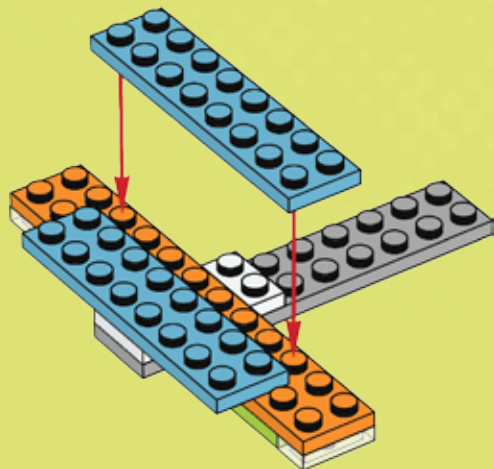



2x

6

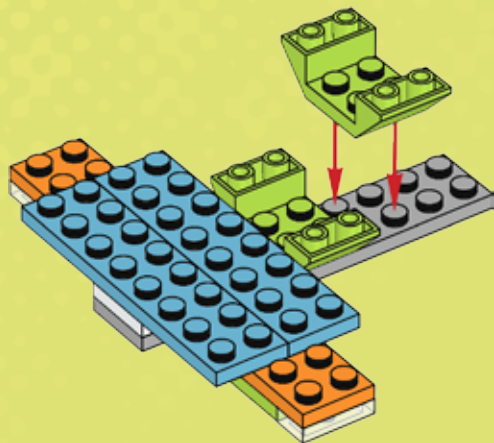



1x

7

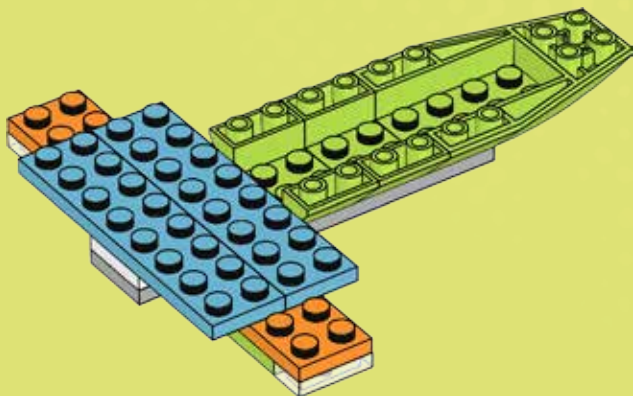



1x

8

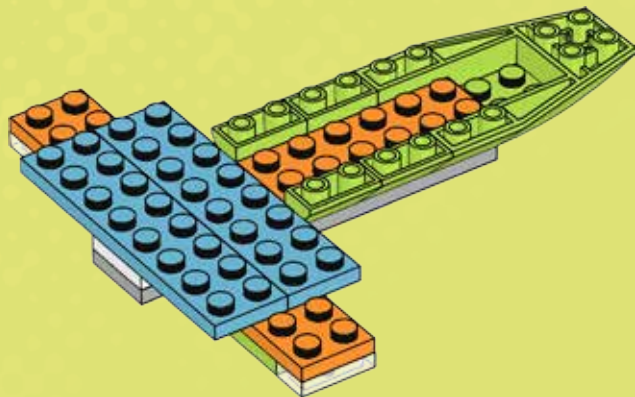



1x

9

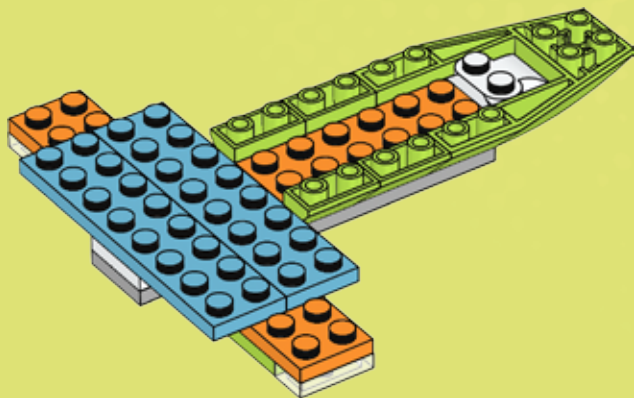



1x

10

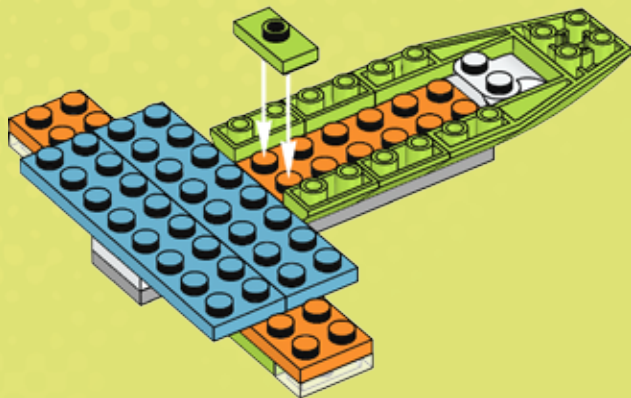



11

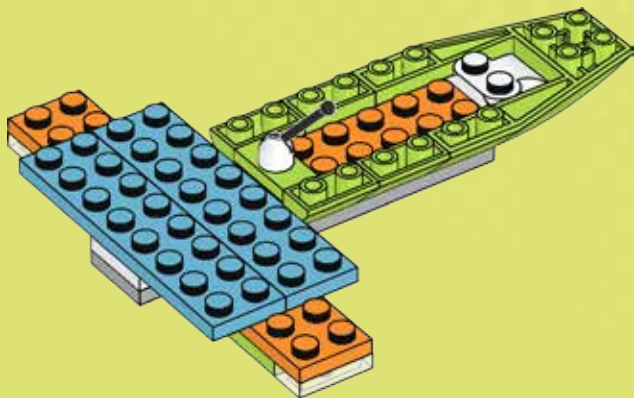



1x

12

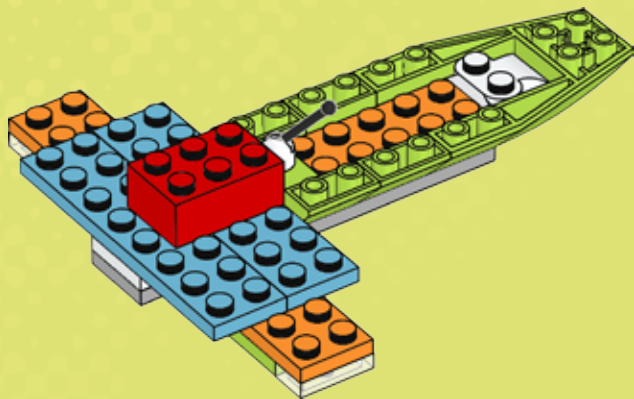

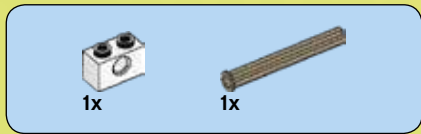

13

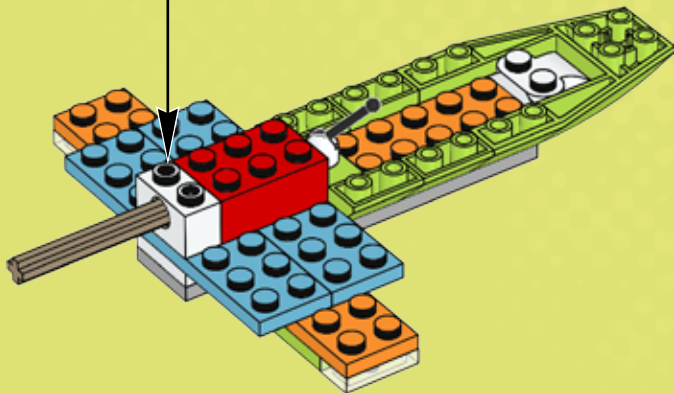
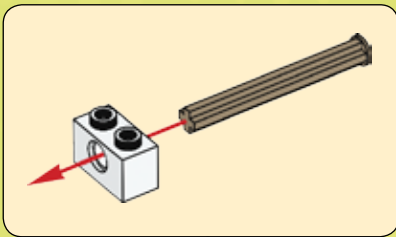



2x

14

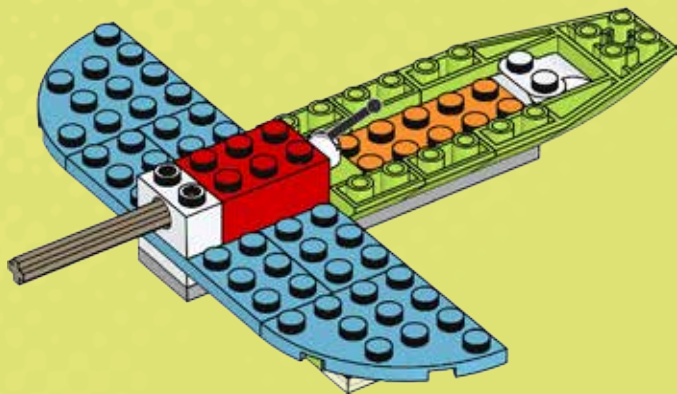



2x

15

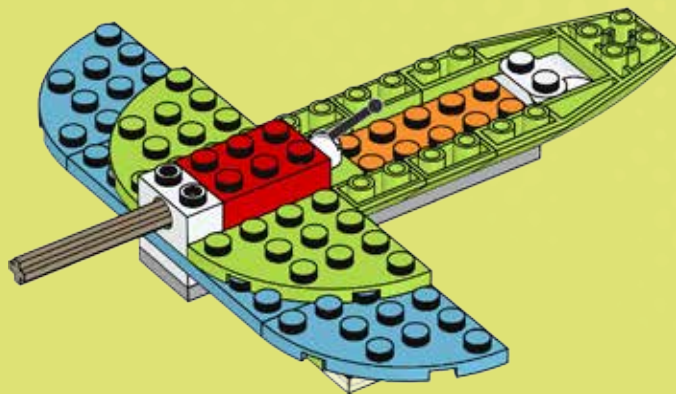



2x

16

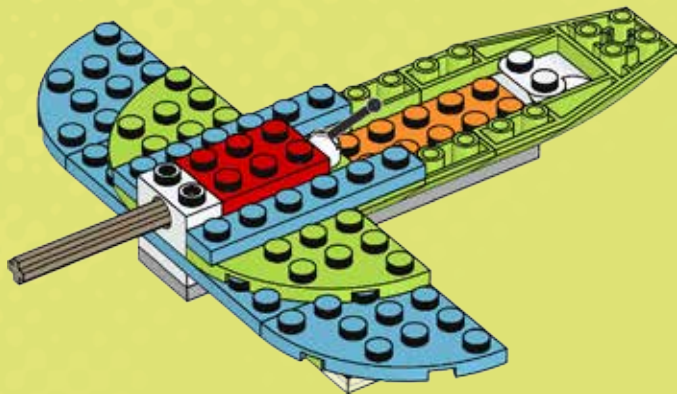



2x

17

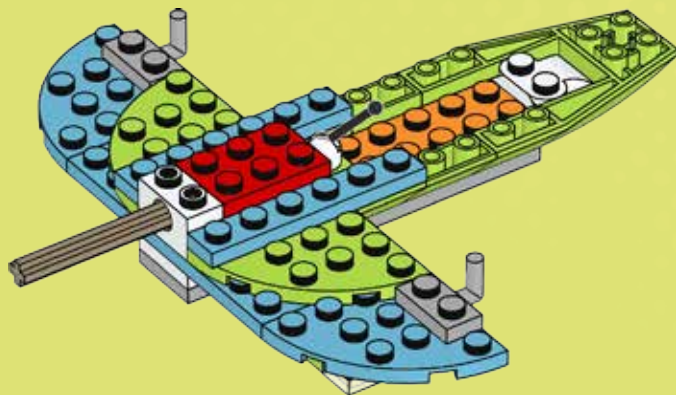



2x

18

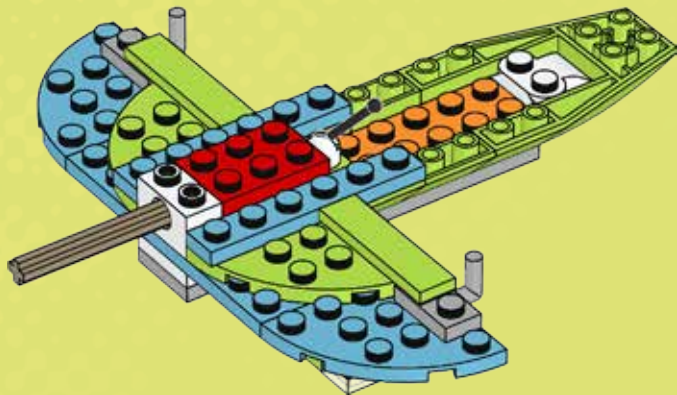



2x

19

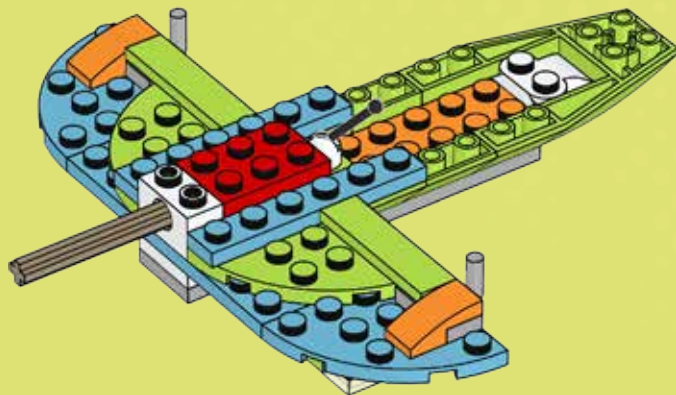



2x

20

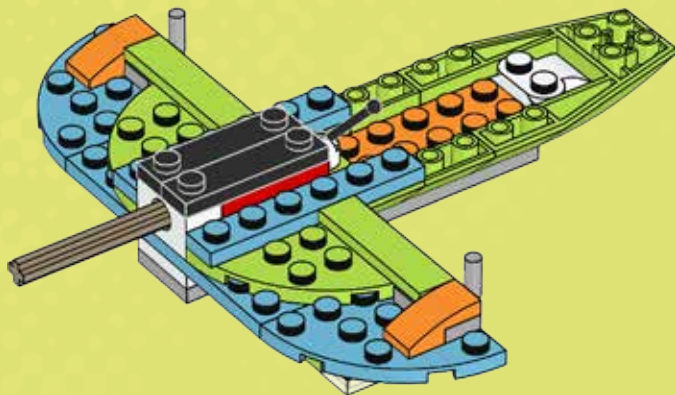



2x

21

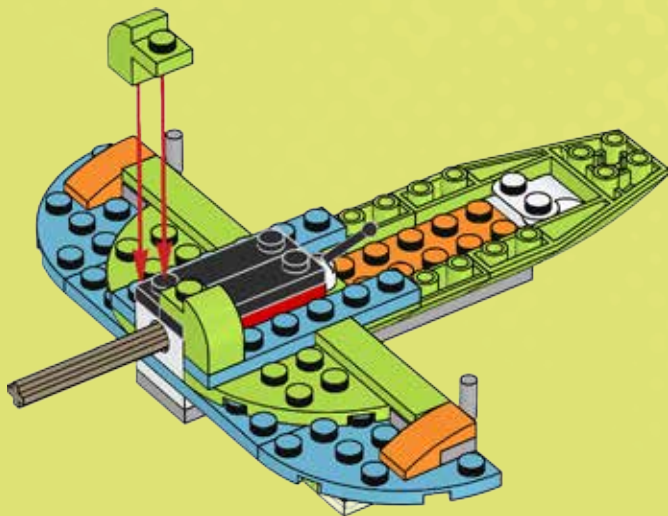



2x



2x

22

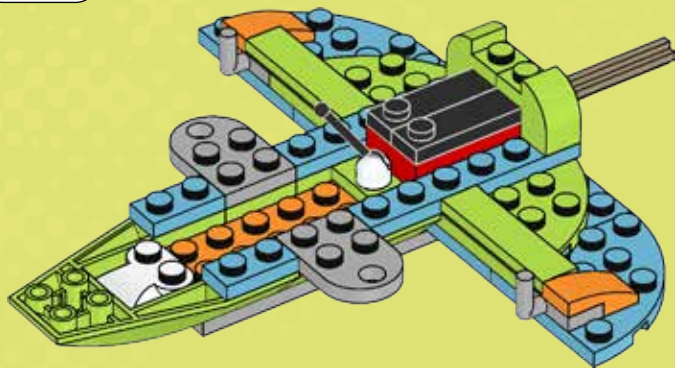
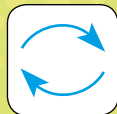



2x

23

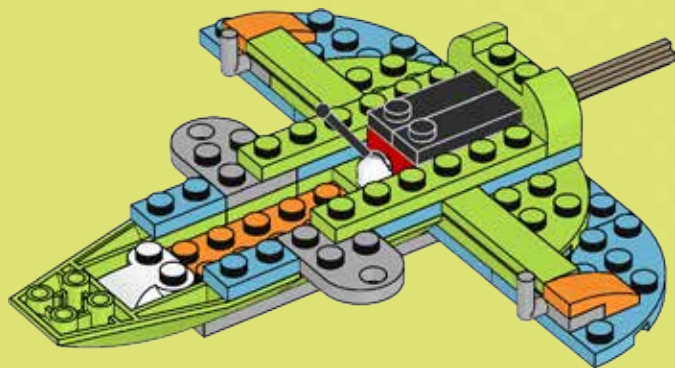



2x

24

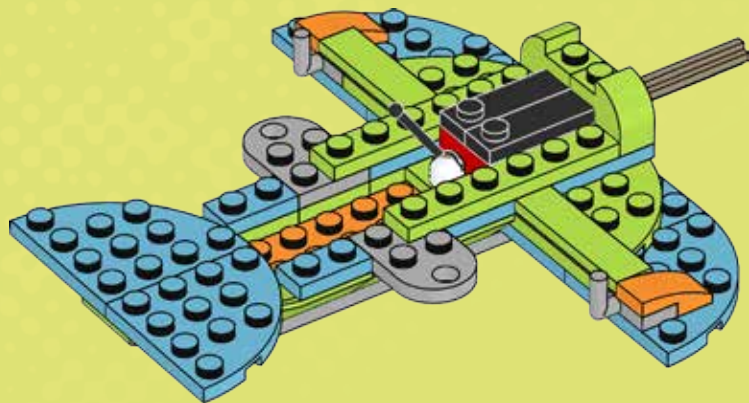



1x

25

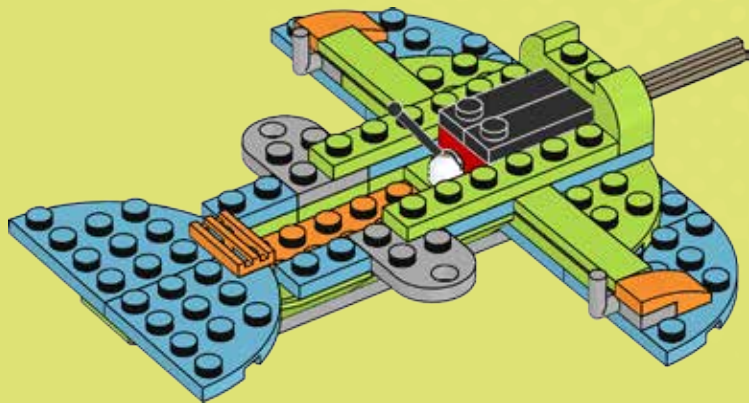



2x

26

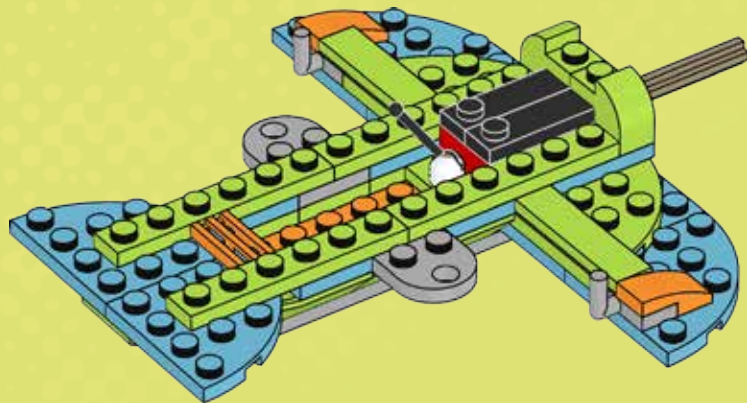



3x

27

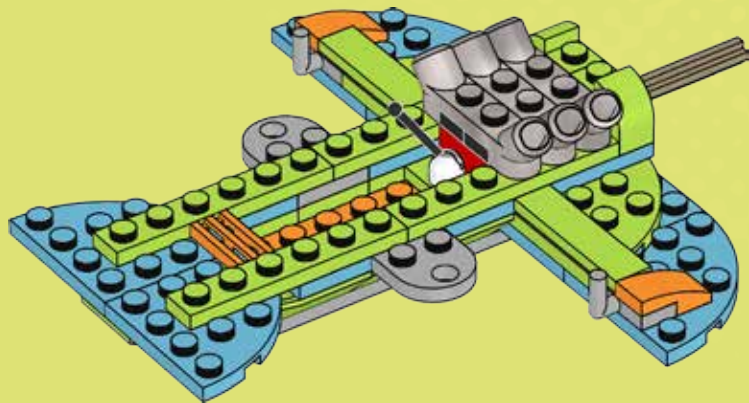



1x

28

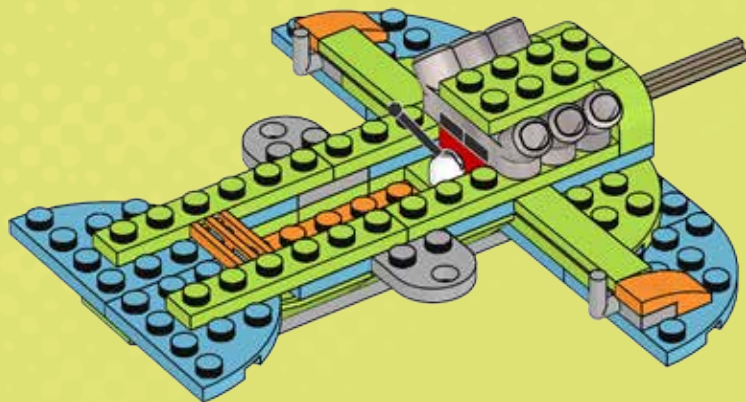



2x

29

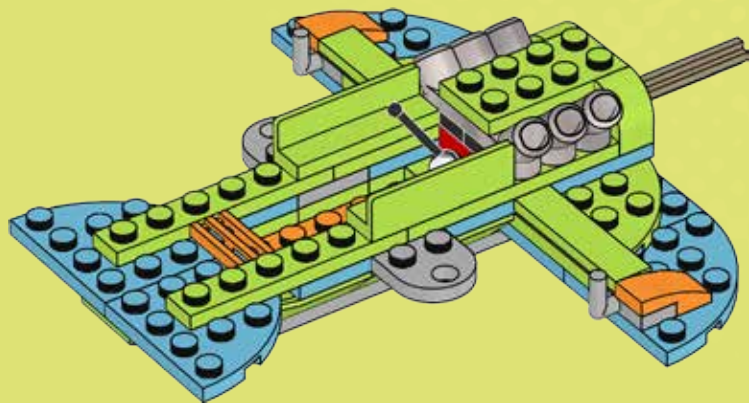



2x

30

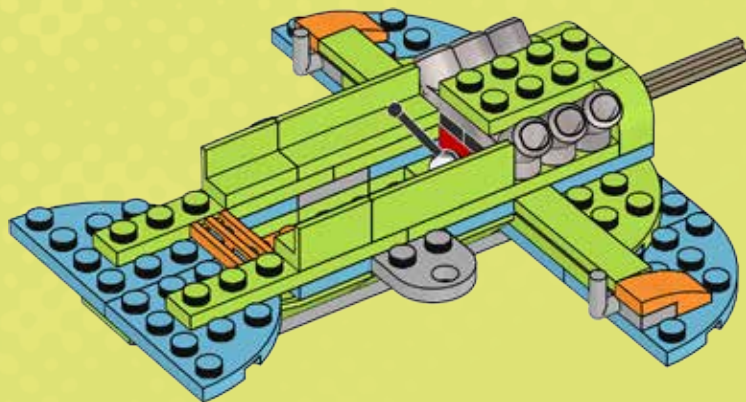

31

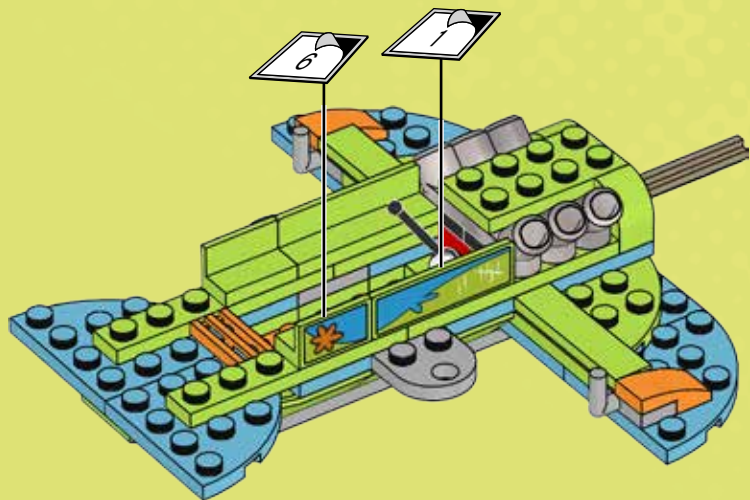

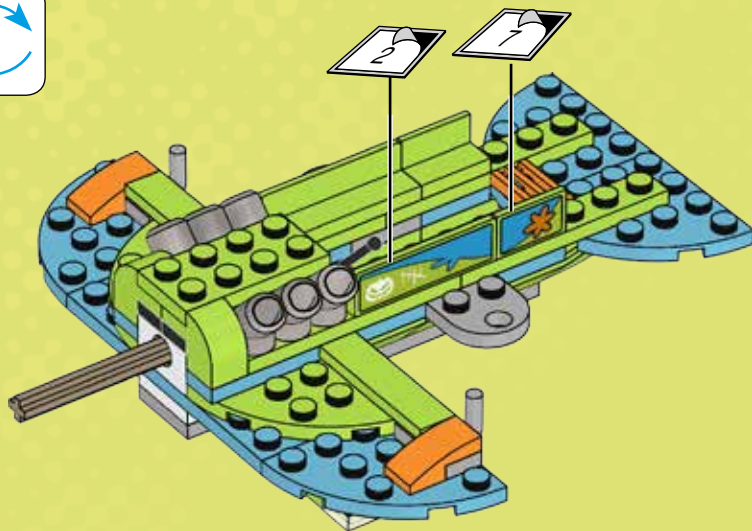



1x



1x

33

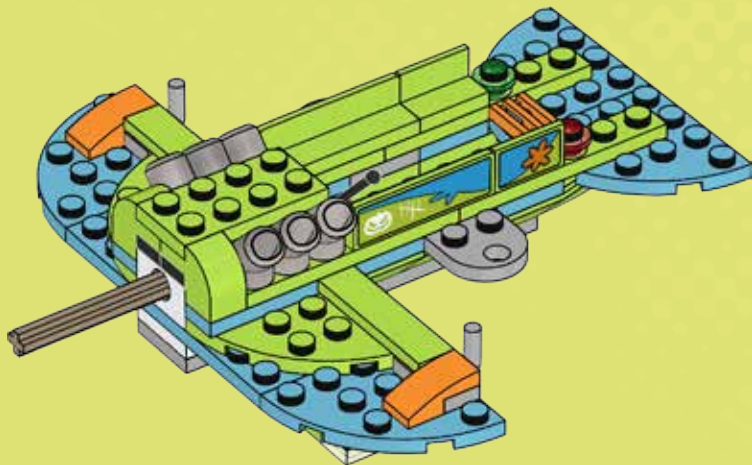



2x

34

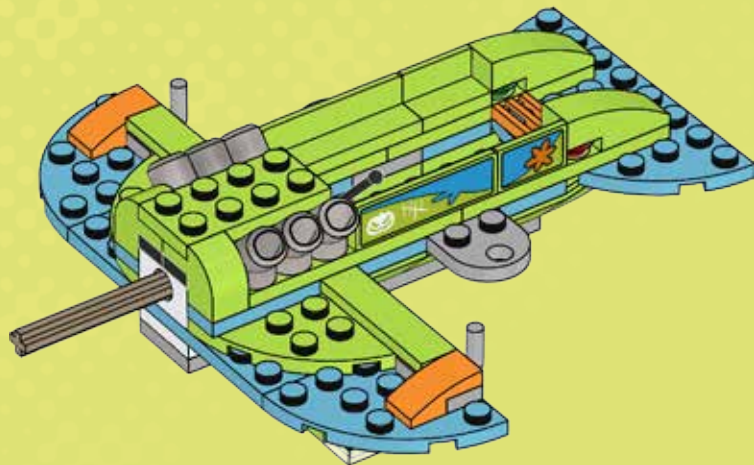

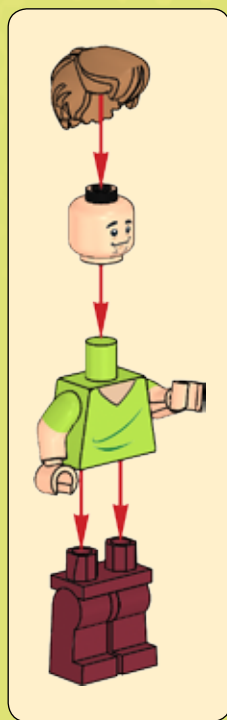
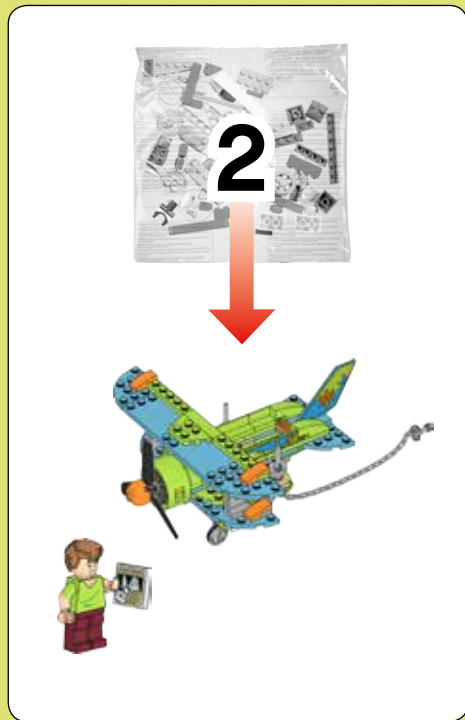



3x

35

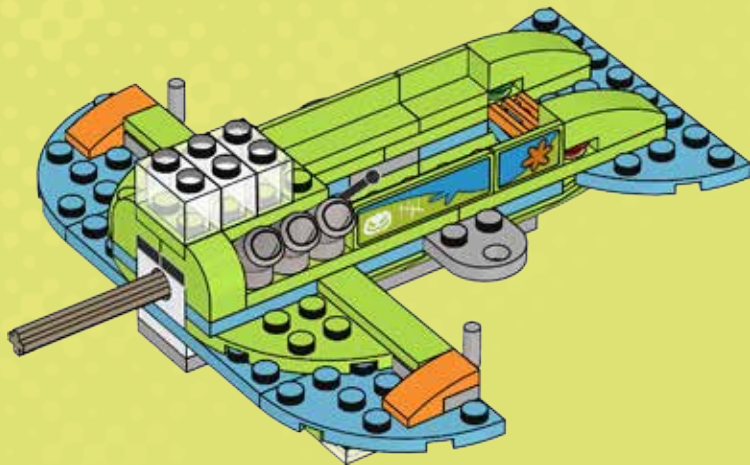



2x

36

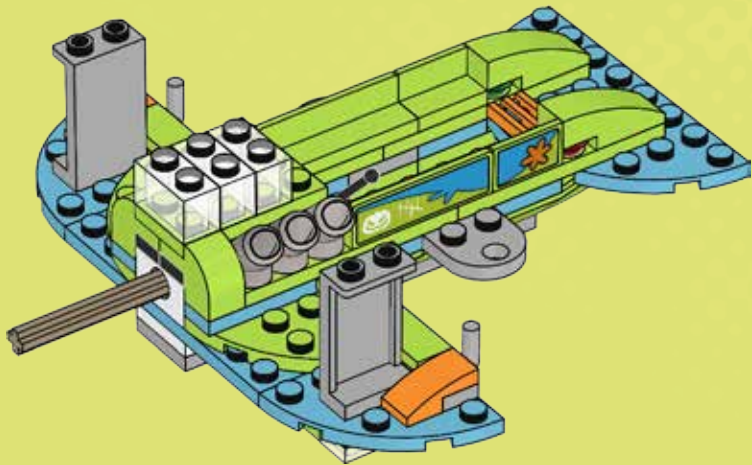



1x



2x

37

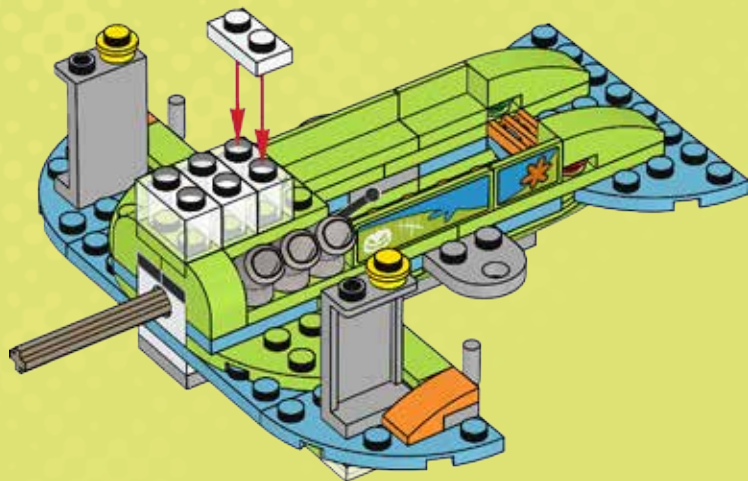

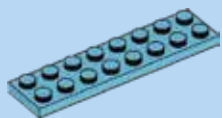

1x

38

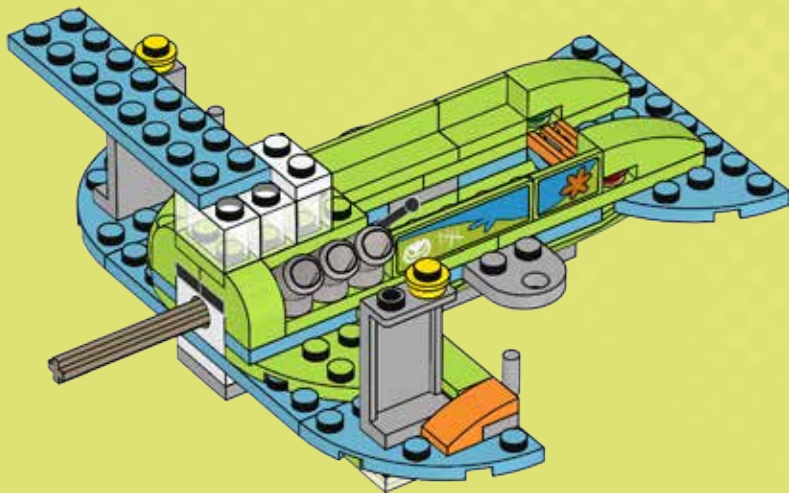

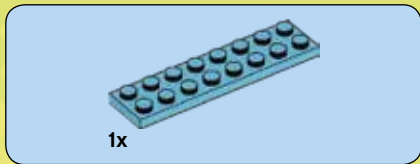

39

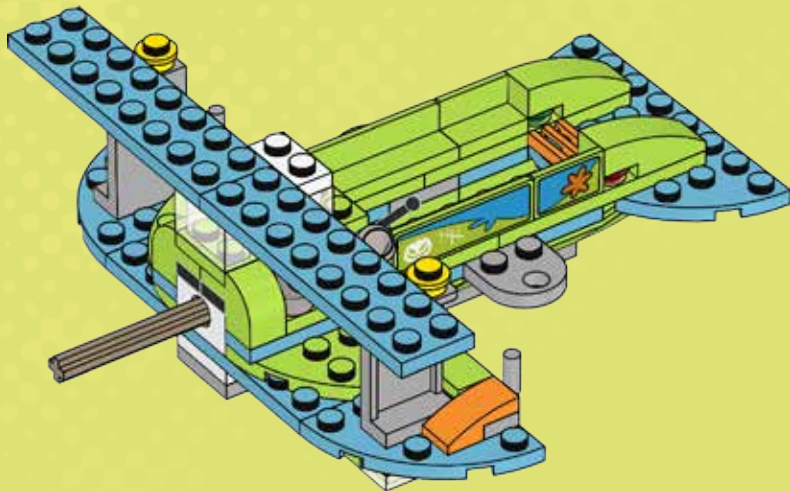

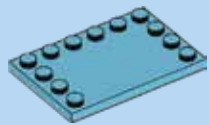

1x

40

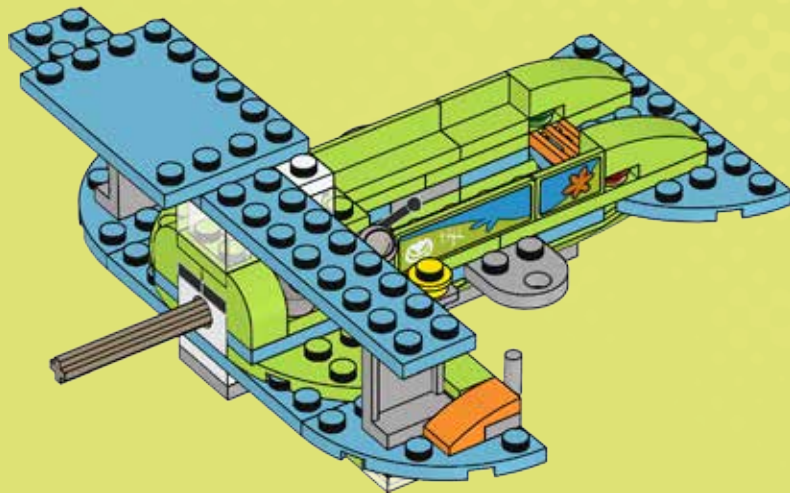

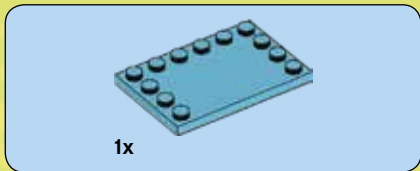

41

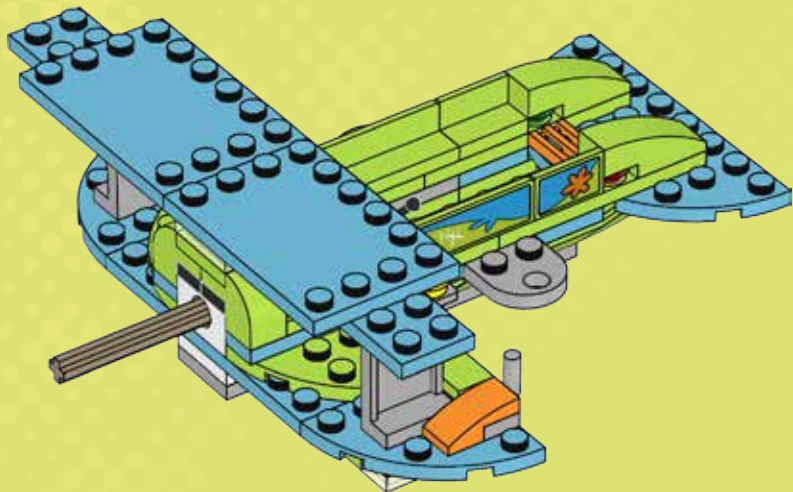



1x

42

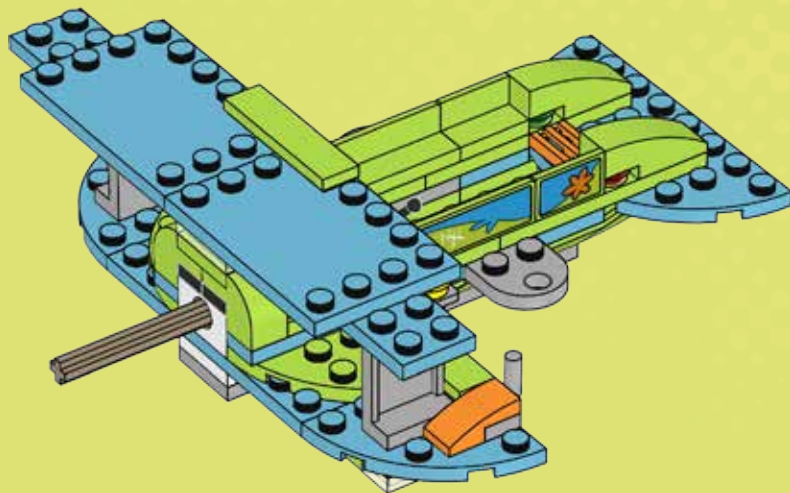



1x

43

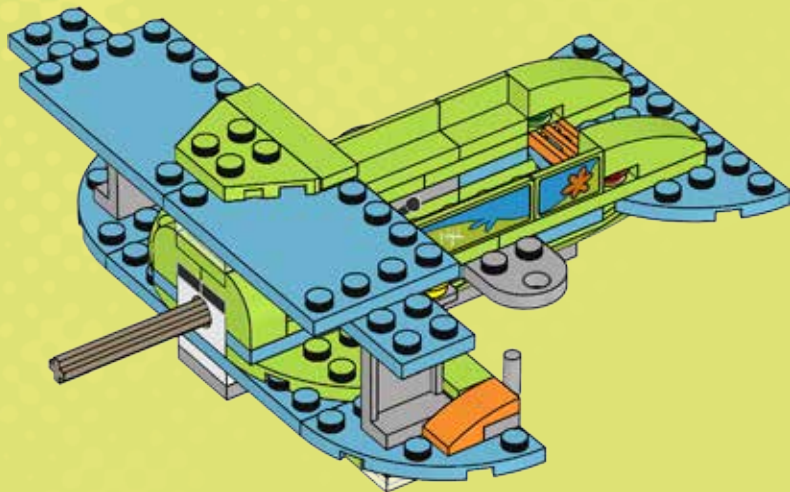



2x

44

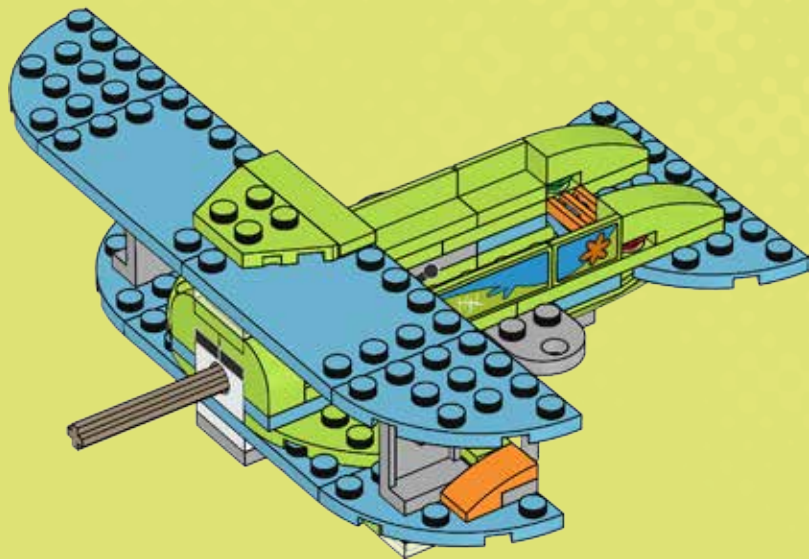



2x

45

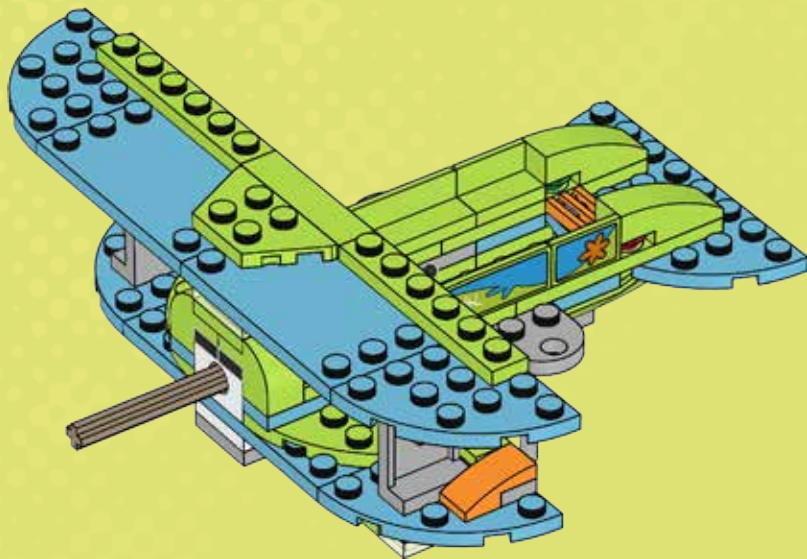



2x

46

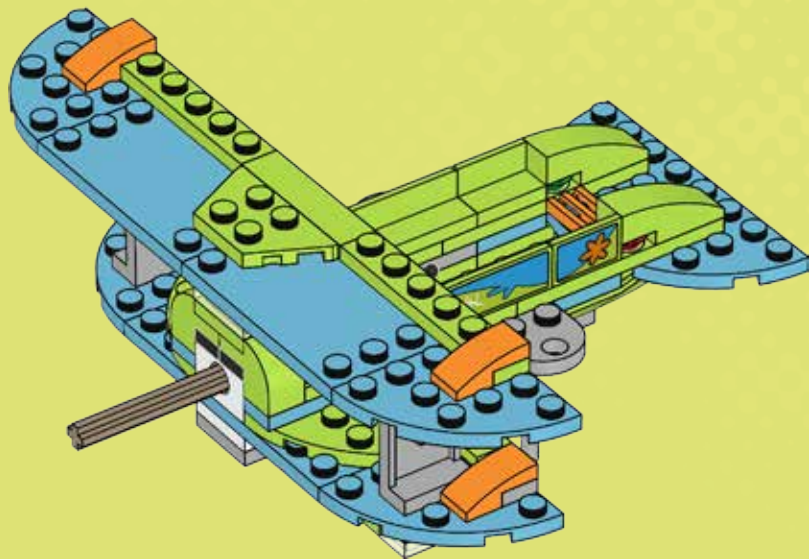



1x

47

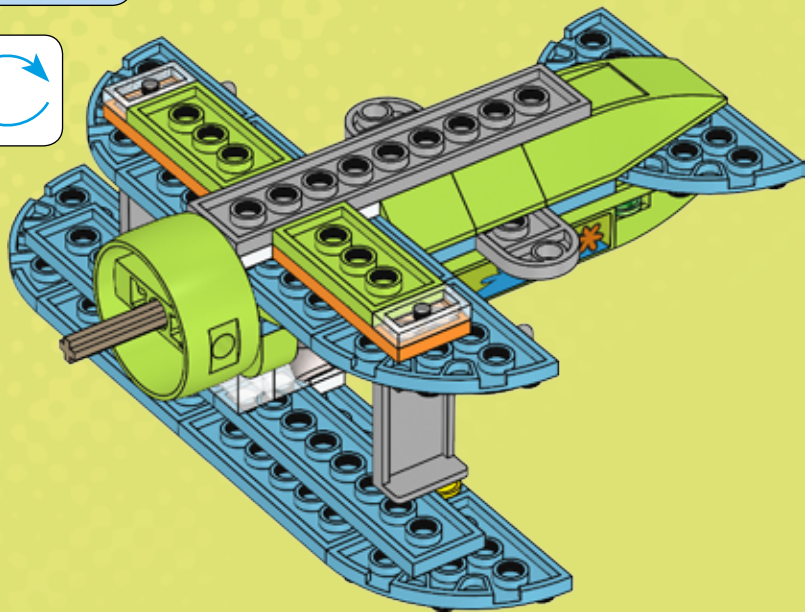

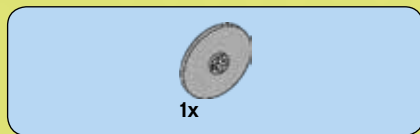

48

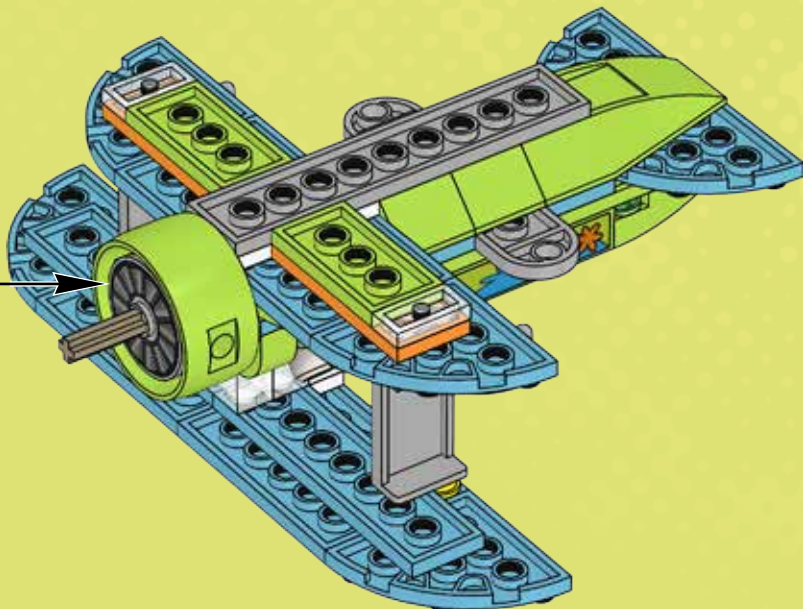
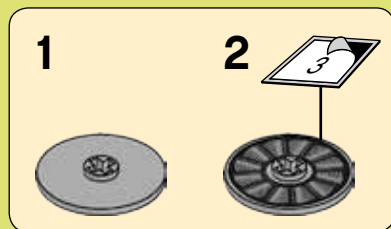

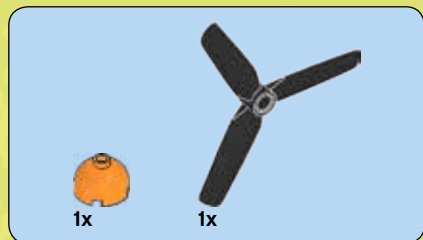

49

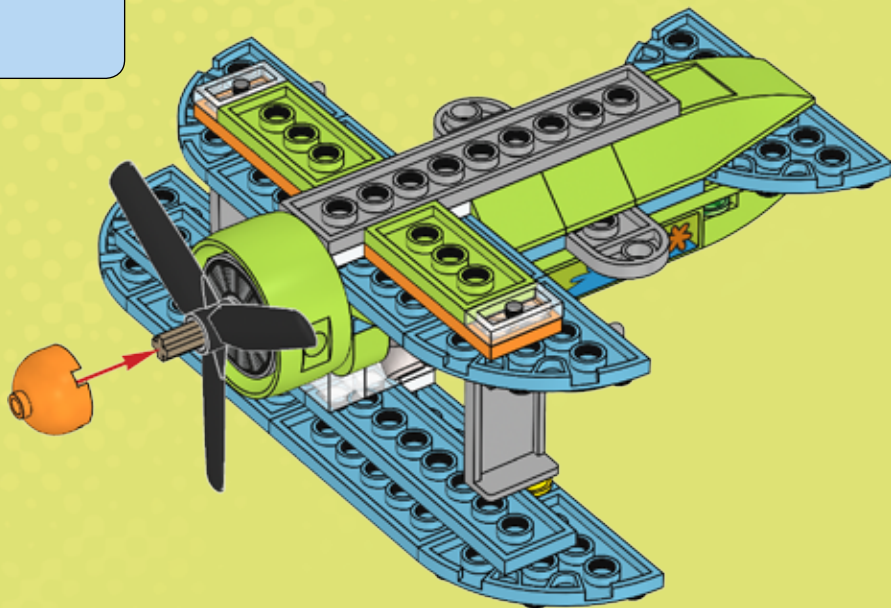



1x

50

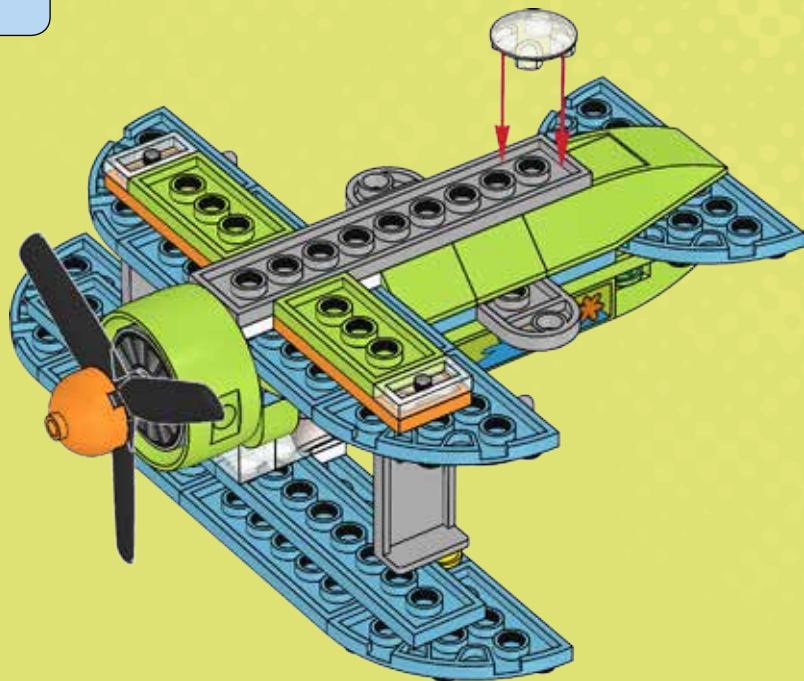



2x

51

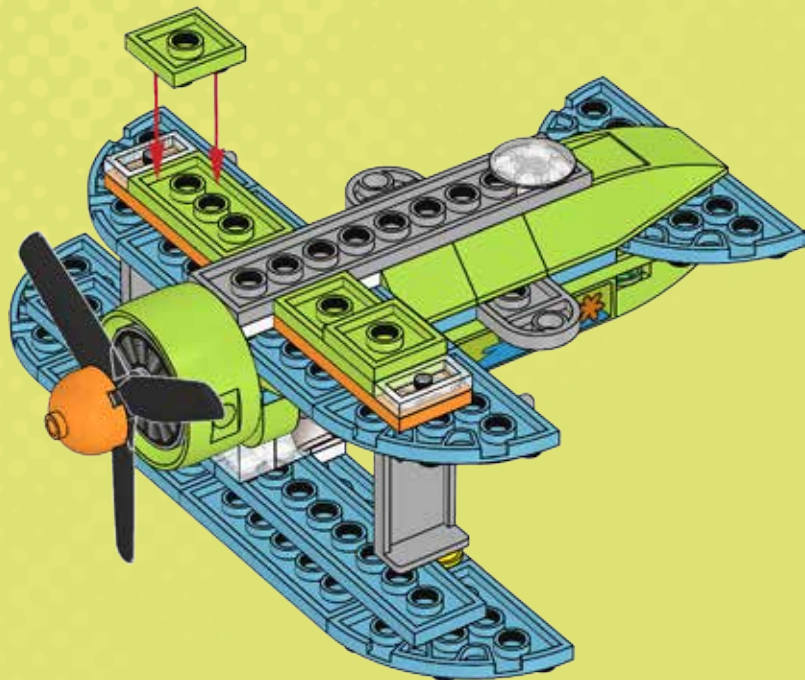



52

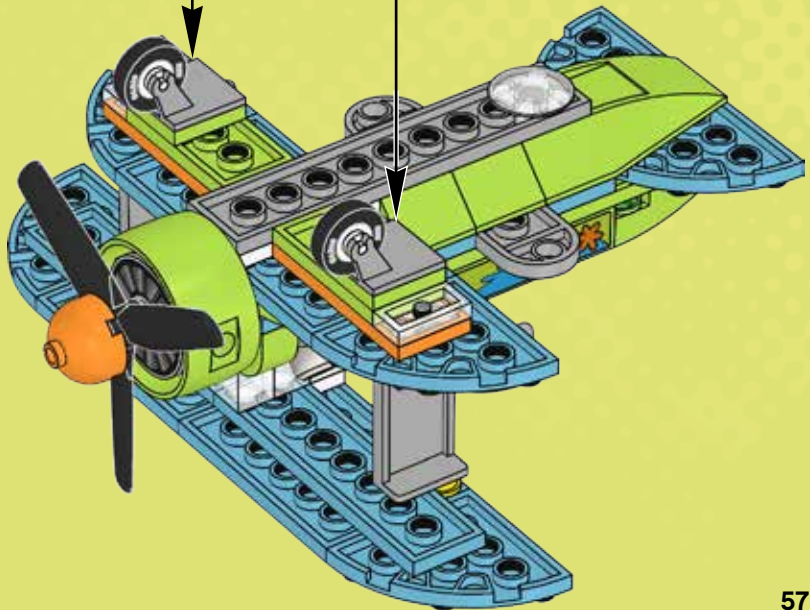
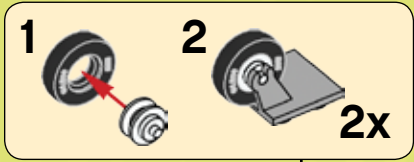

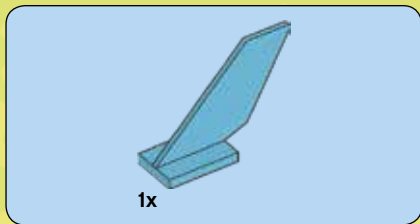

53

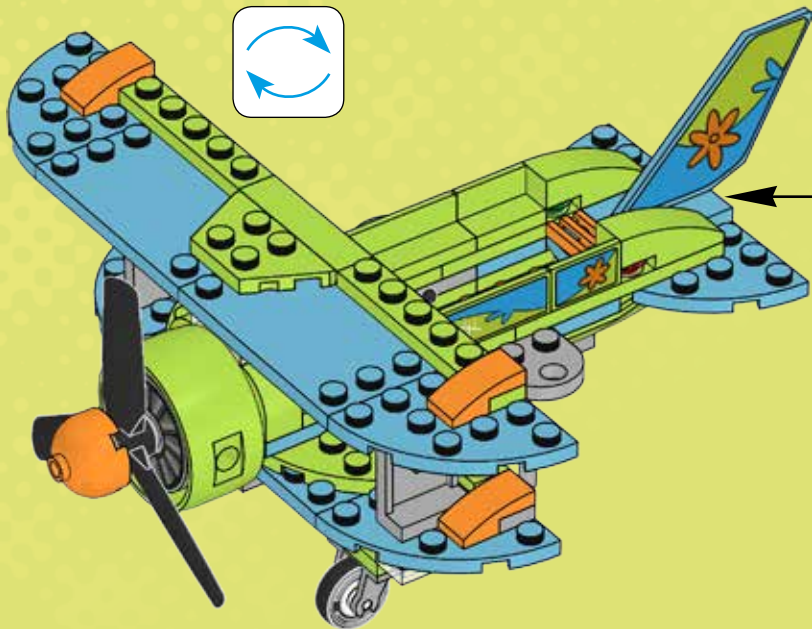

1

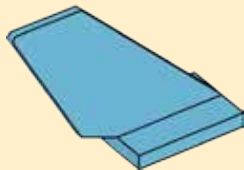

2

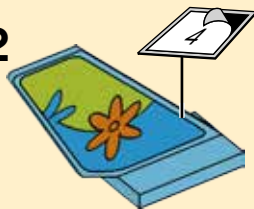

3

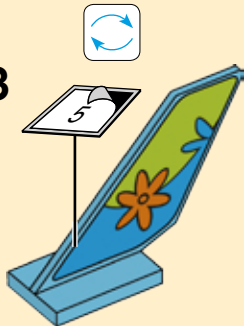



54

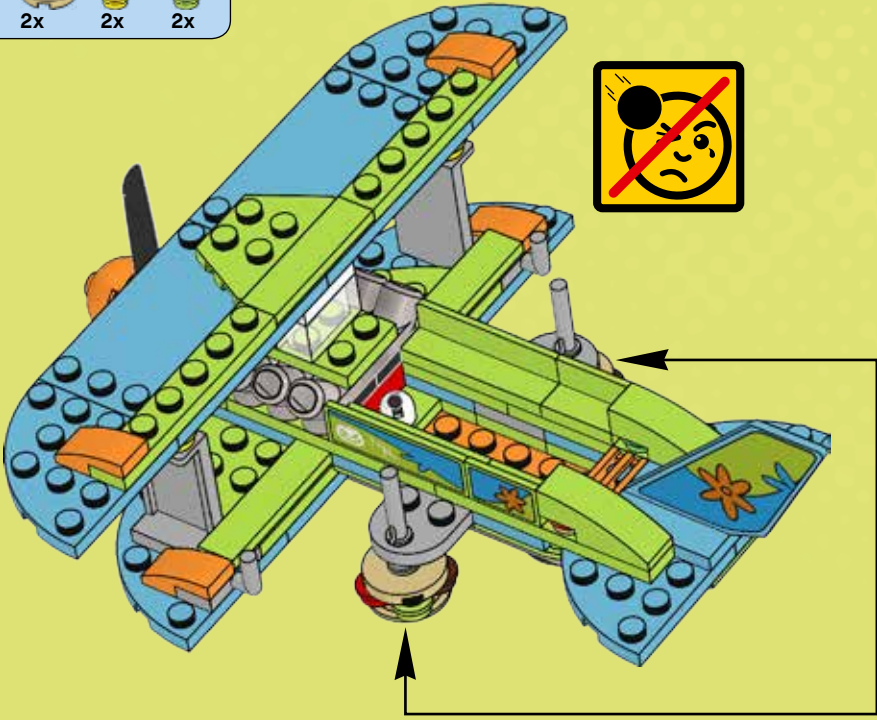

- 1 
 - 2 
 - 3 
 - 4 
- 2x**

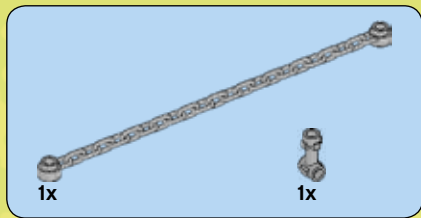

55

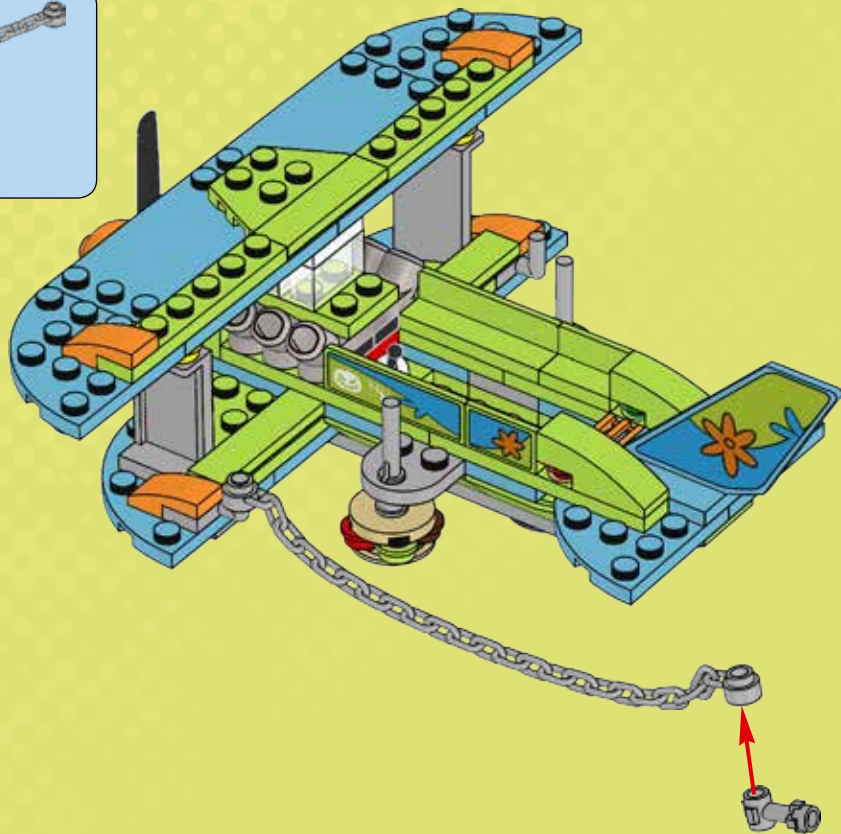





Download Zappar App
Scan the page
Play Activity!

Télécharge l'application Zappar
Scanne la page
Joue à l'activité !

Descarga la app Zappar
Escanea la página
¡Juega!



Apple, the Apple logo, iPad, iPhone and iPod touch are trademarks of Apple Inc. Apple, le logo Apple, iPad, iPhone et iPod touch sont des marques de commerce d'Apple Inc. Apple, el logotipo de Apple, iPad, iPhone e iPod touch son marcas comerciales de Apple Inc. Google Play is a trademark of Google Inc. Google Play est une marque de commerce de Google Inc. Google Play es una marca comercial de Google Inc.



SCOOBY-DOO!

WE'VE GOT A MYSTERY TO SOLVE
NOUS AVONS UN MYSTÈRE À RÉSOUDRE
TENEMOS UN MISTERIO QUE RESOLVER

75900



75901



75902



75903



75904



LEGO.COM/scoobydoo





DC COMICS
**SUPER
HEROES**

76034

**SUPER
JUMPER**



76035



BATMAN and all related characters and elements are trademarks of and © DC Comics./BATMAN et tous les personnages et éléments qui y sont associés sont des marques de commerce et © de DC Comics./BATMAN y todos sus personajes y elementos relacionados son marcas y © de DC Comics.



WB SHIELD: TM/MC & © Warner Bros. Entertainment Inc. (s15)



More spooky fun at
LEGO.com/scoobydoo
Plus d'amusement effrayant sur
LEGO.fr/scoobydoo
Más diversión tenebrosa en
LEGO.com/scoobydoo



SCOOPY-DOO!



Apple, the Apple logo, iPad, iPhone and iPod touch are trademarks of Apple Inc. Apple, le logo Apple, iPad, iPhone et iPod touch sont des marques de commerce d'Apple Inc. Apple, el logotipo de Apple, iPad, iPhone e iPod touch son marcas comerciales de Apple Inc. Google Play is a trademark of Google Inc. Google Play est une marque de commerce de Google Inc. Google Play es una marca comercial de Google Inc.



2x
4537937



3x
4164021



3x
4537936



6x
4529160



1x
6025027



2x
4504705



1x
6092592

66



1x
6013529



2x
6110067



1x
6115243



2x
6121949



2x
6092671



2x
4212446



2x
4537928



1x
6119136



1x
6117778



1x
6117683



1x
4541496



3x
306540



2x
4167842



1x
4278412



1x
3005748



1x
3005741



1x
6055631



1x
6055123



2x
4599499



2x
4516843



2x
4211351

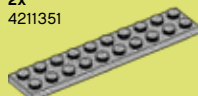

1x
4211462



1x
4512049



2x
4611702



2x
4211419



2x
4585429



1x
4640844



2x
4520320



1x
4667578



1x
6081404



1x
6093534



1x
6122060



1x
6122066



1x
4505990



1x
6122220



1x
6122259



1x
9341



1x
6119246



3x
4632100



1x
6122207



1x
4532970



4x
6055069



1x
4125254



1x
4121741



1x
6056707



2x
6097419



2x
4625036



2x
6115246



4x
6119125



6x
6056271



1x
6121953



1x
6036454



2x
370001



4x
302301



1x
6122523



2x
4296997



1x
4494474



1x
73737



1x
300221



2x
614121



4x
614124



2x
4183133



2x
4216581



2x
6122533



2x
6115248



Customer Service

Kundenservice

Service Consommateurs

Servicio Al Consumidor

LEGO.com/service or dial



: 00800 5346 5555

: 1-800-422-5346