

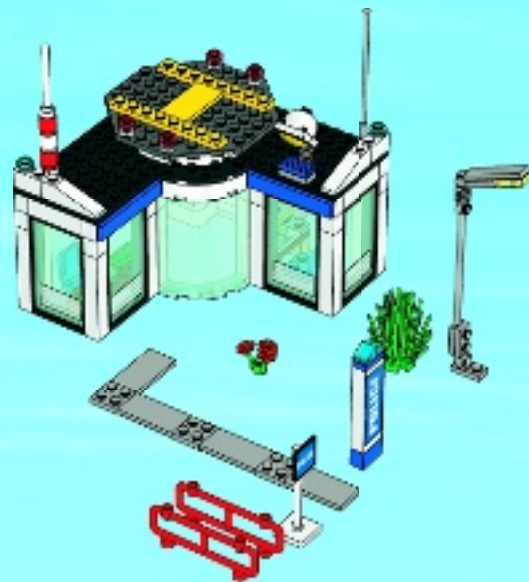

7498

# CITY

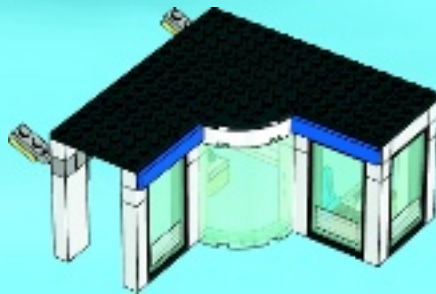





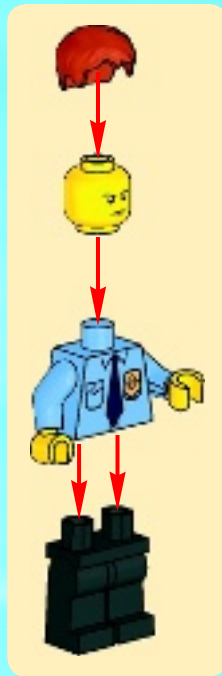

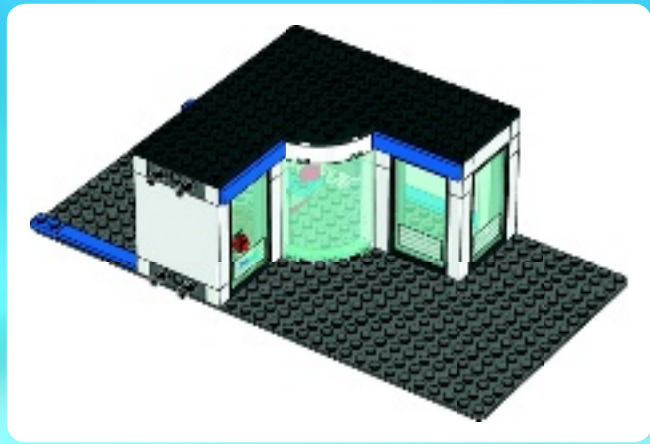

1

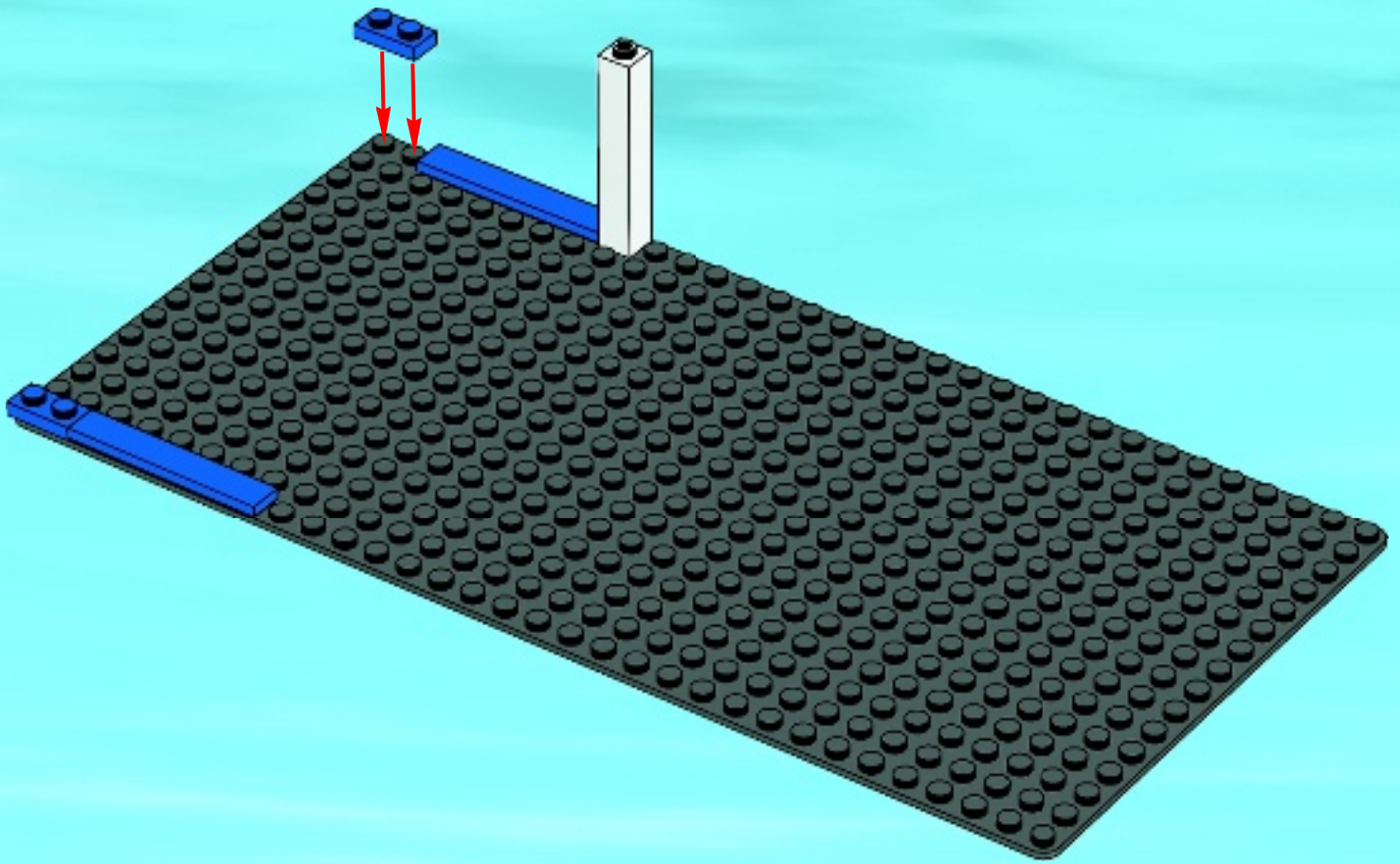



2

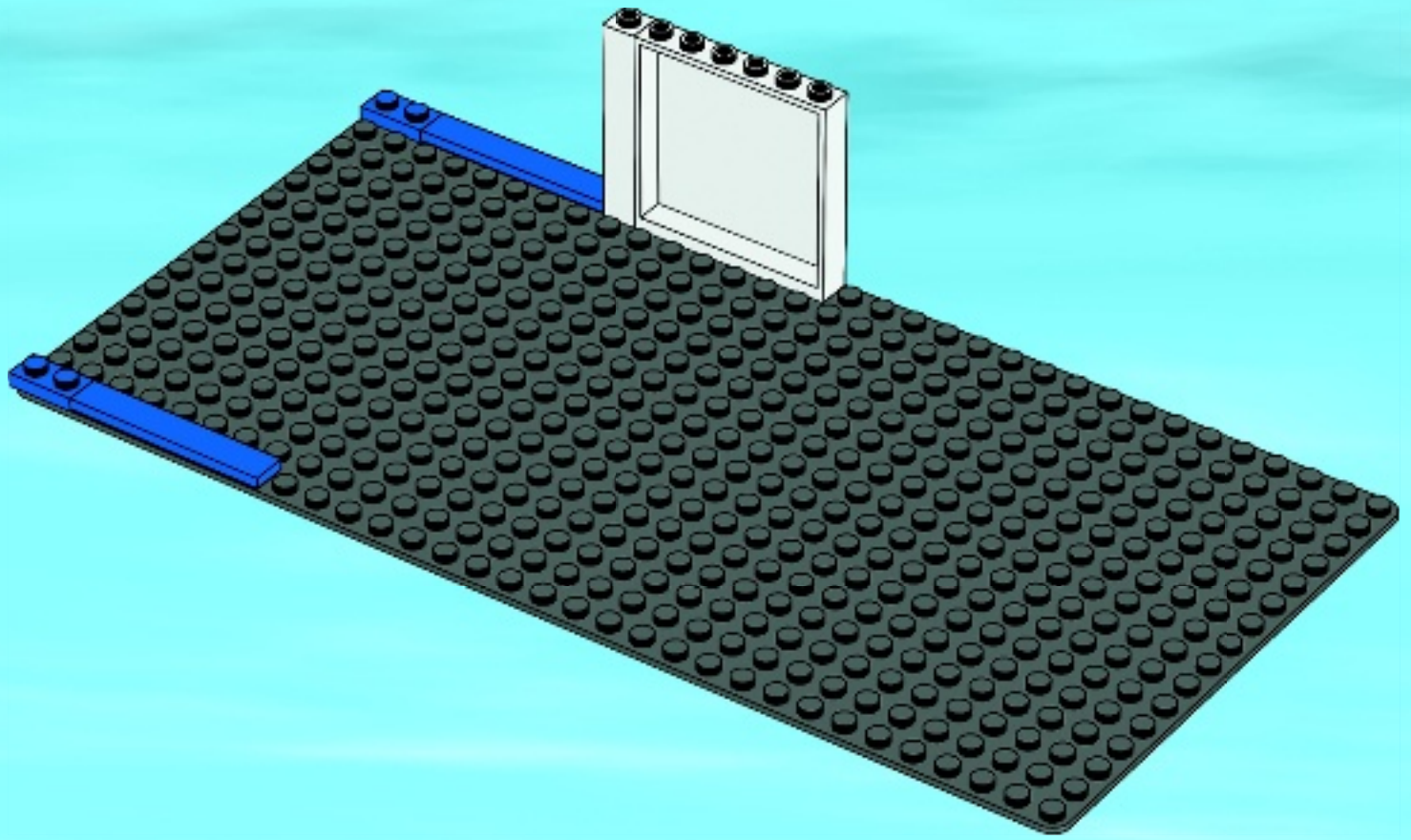

3

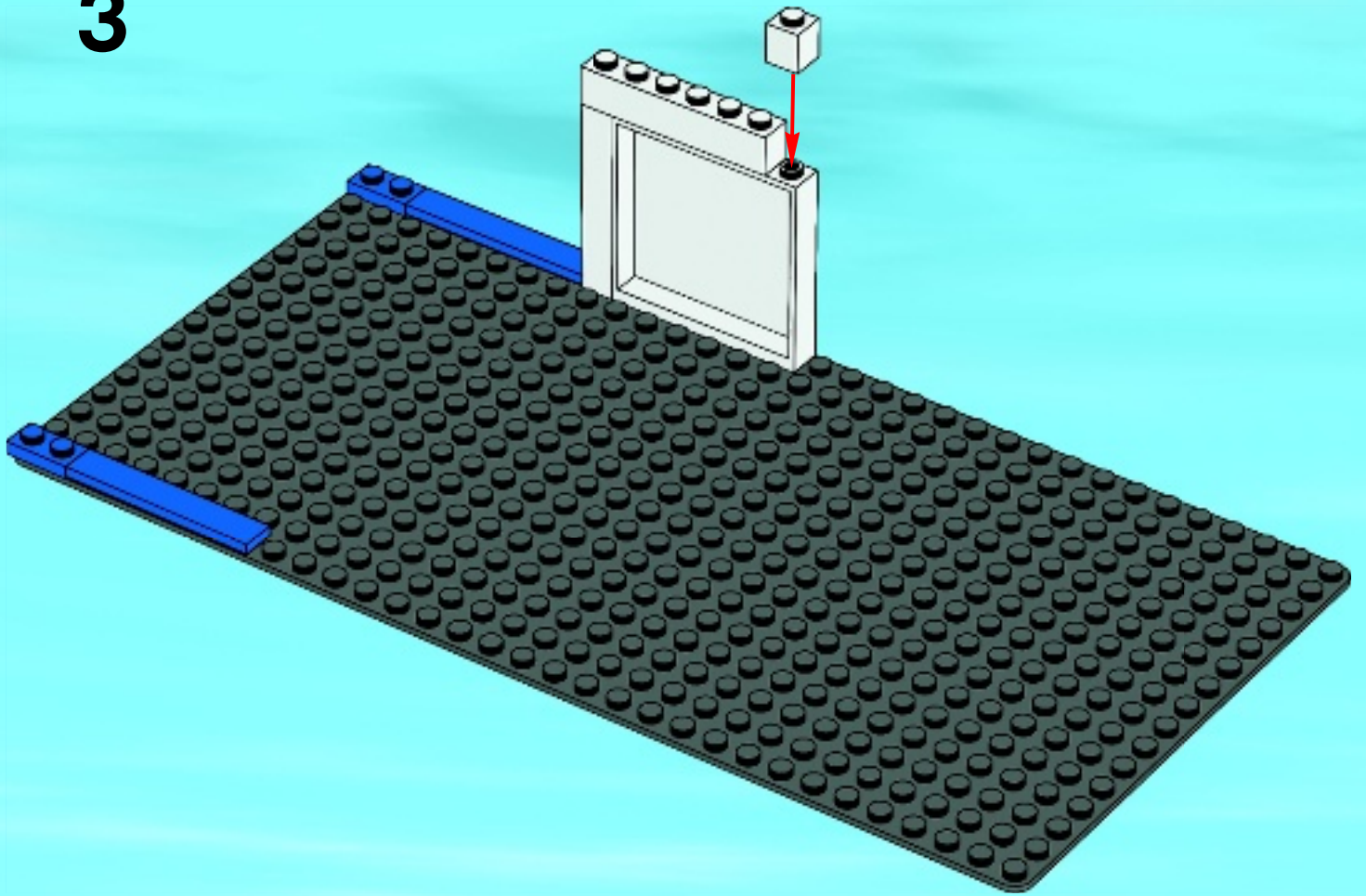



4

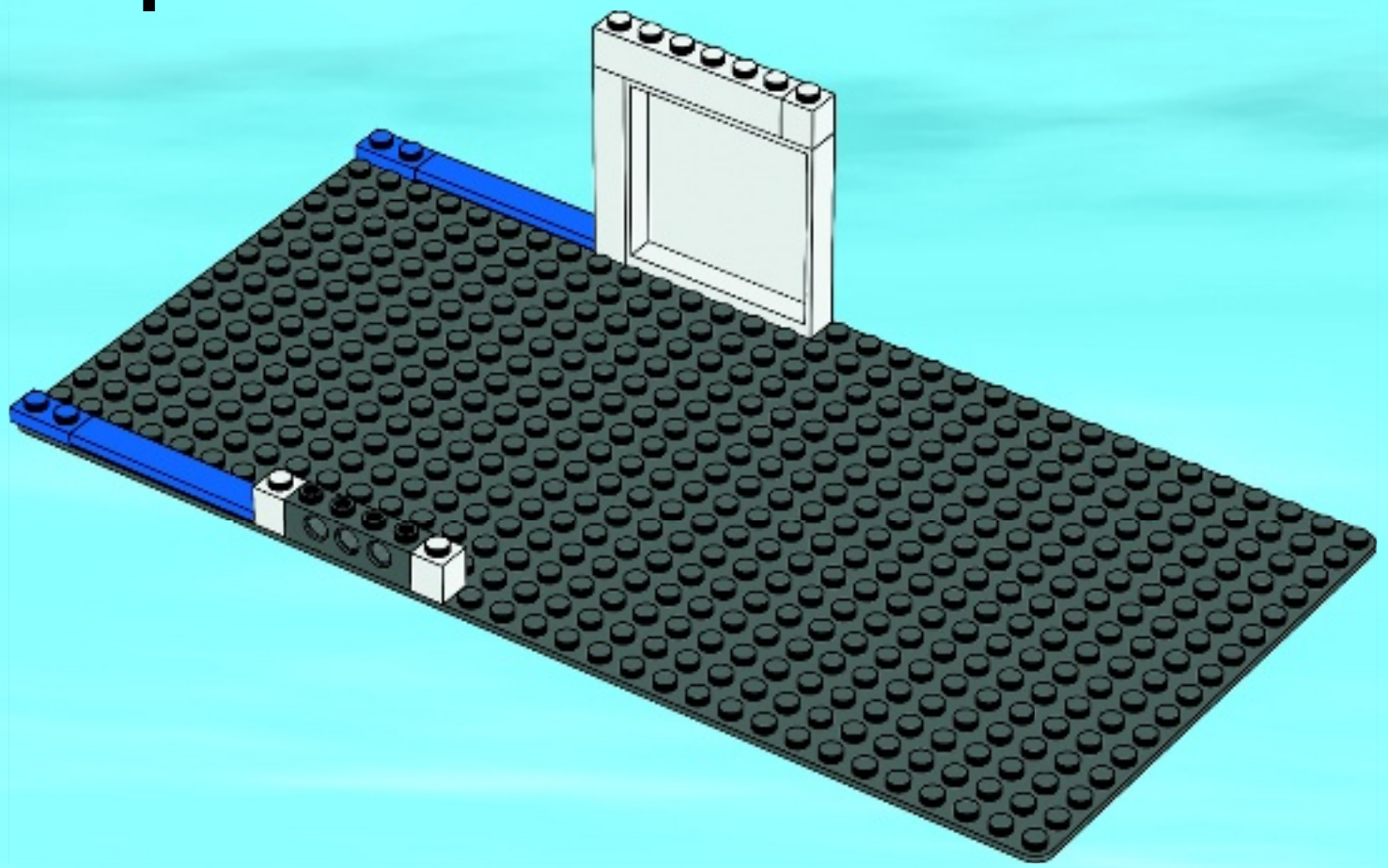

5

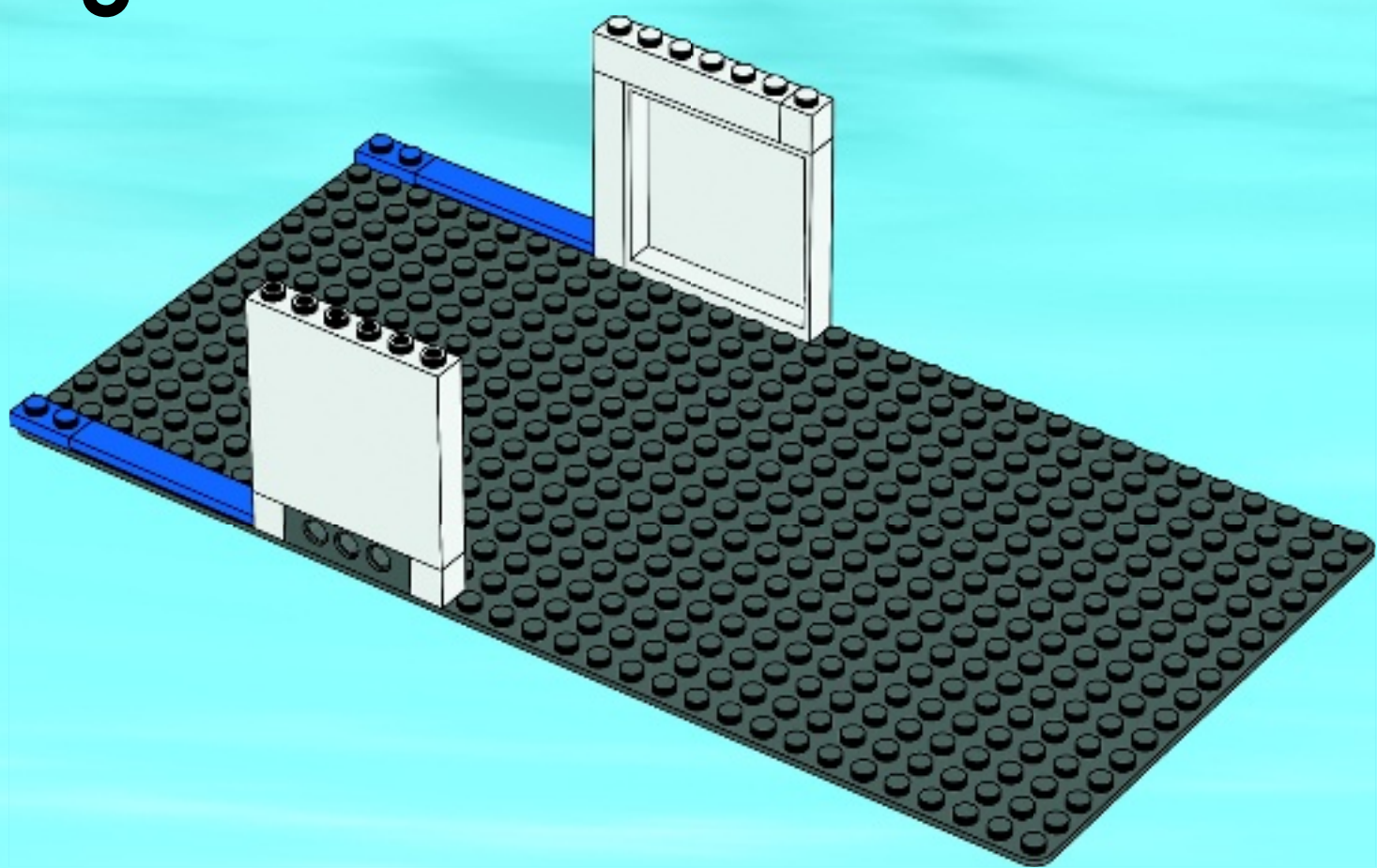



6

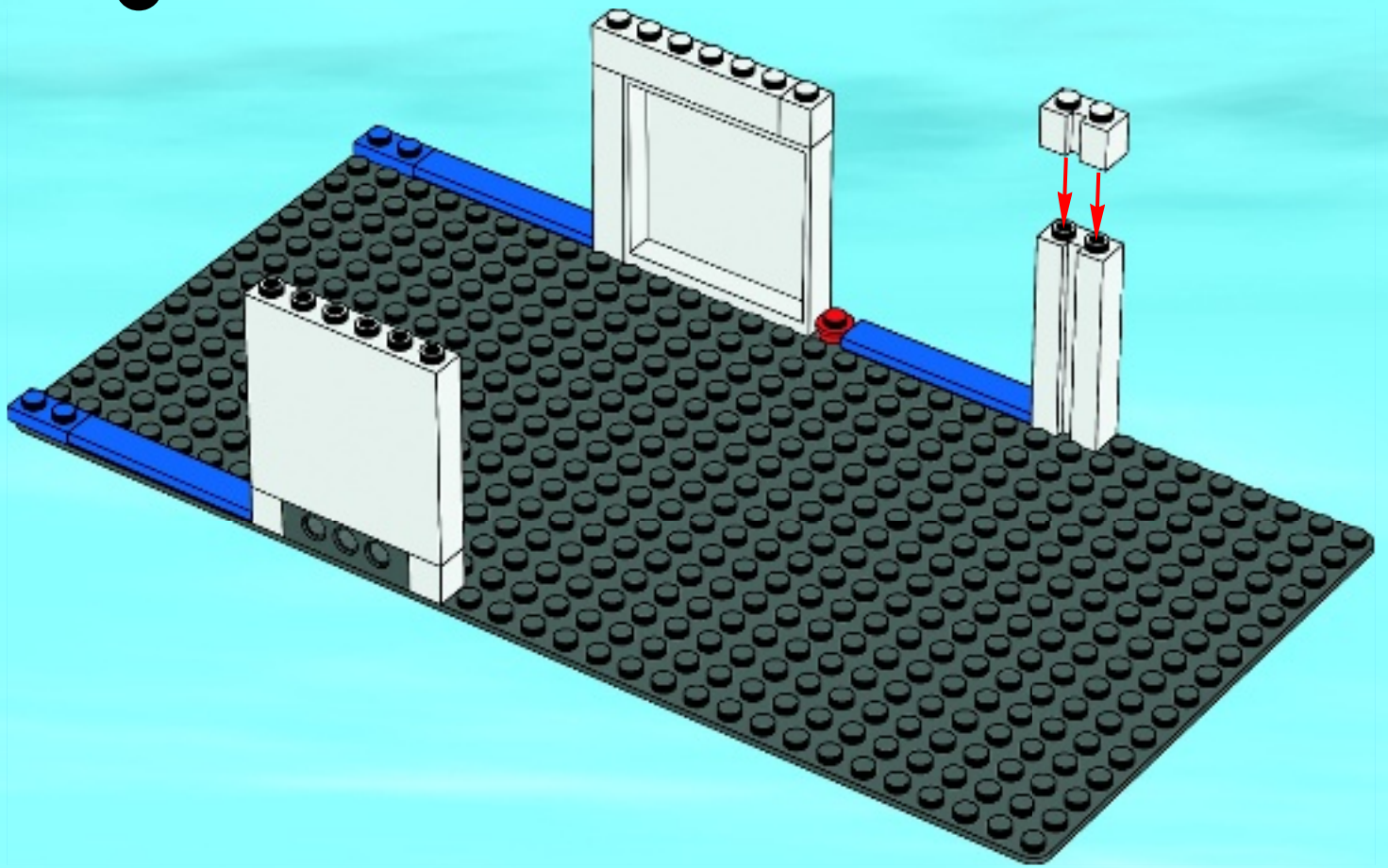

1

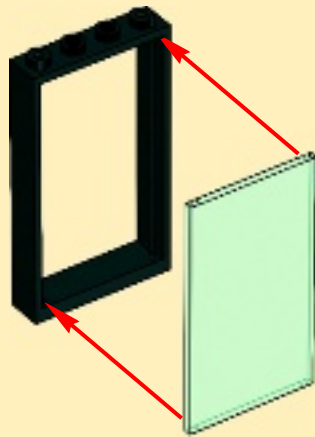

2



7

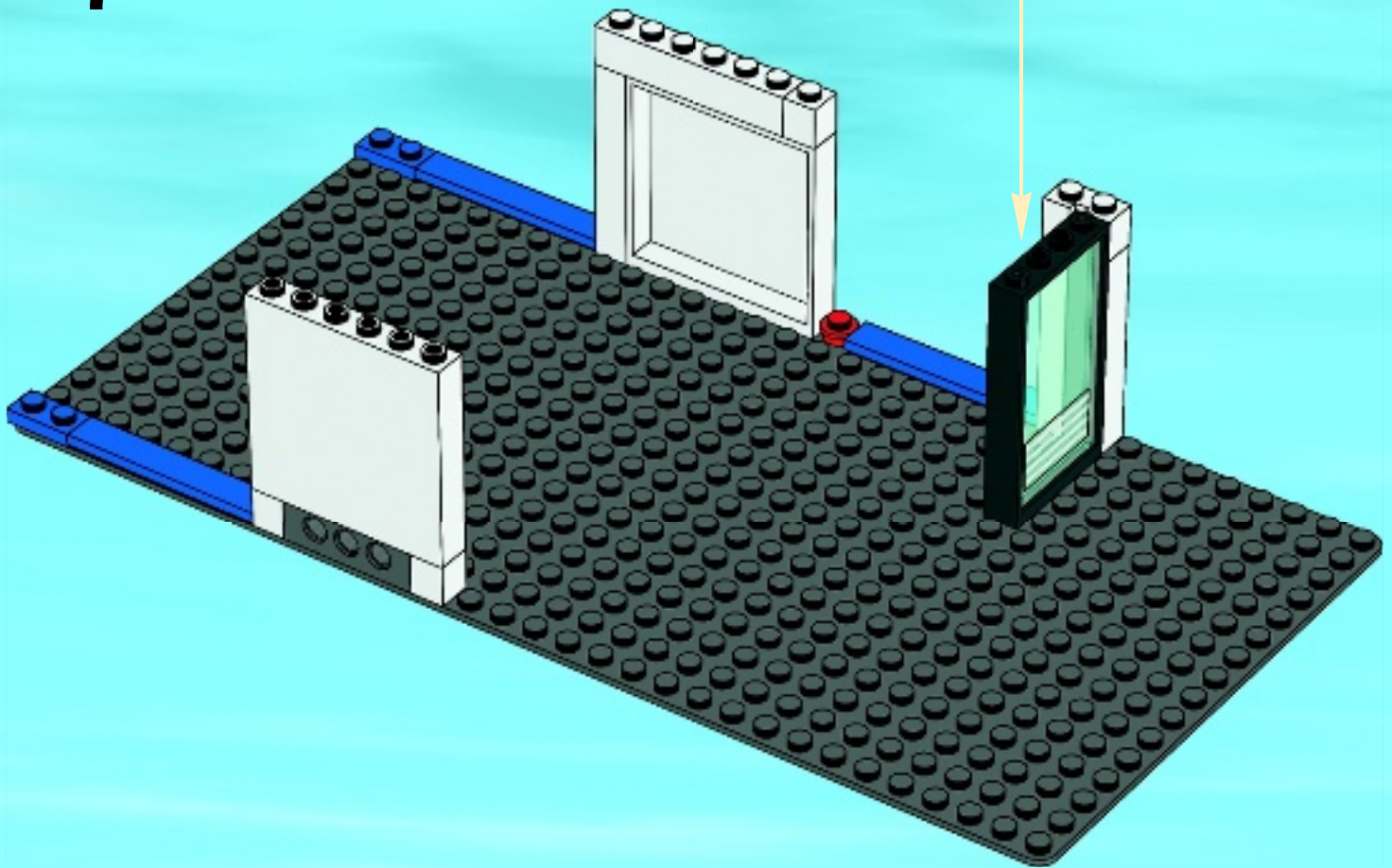



8

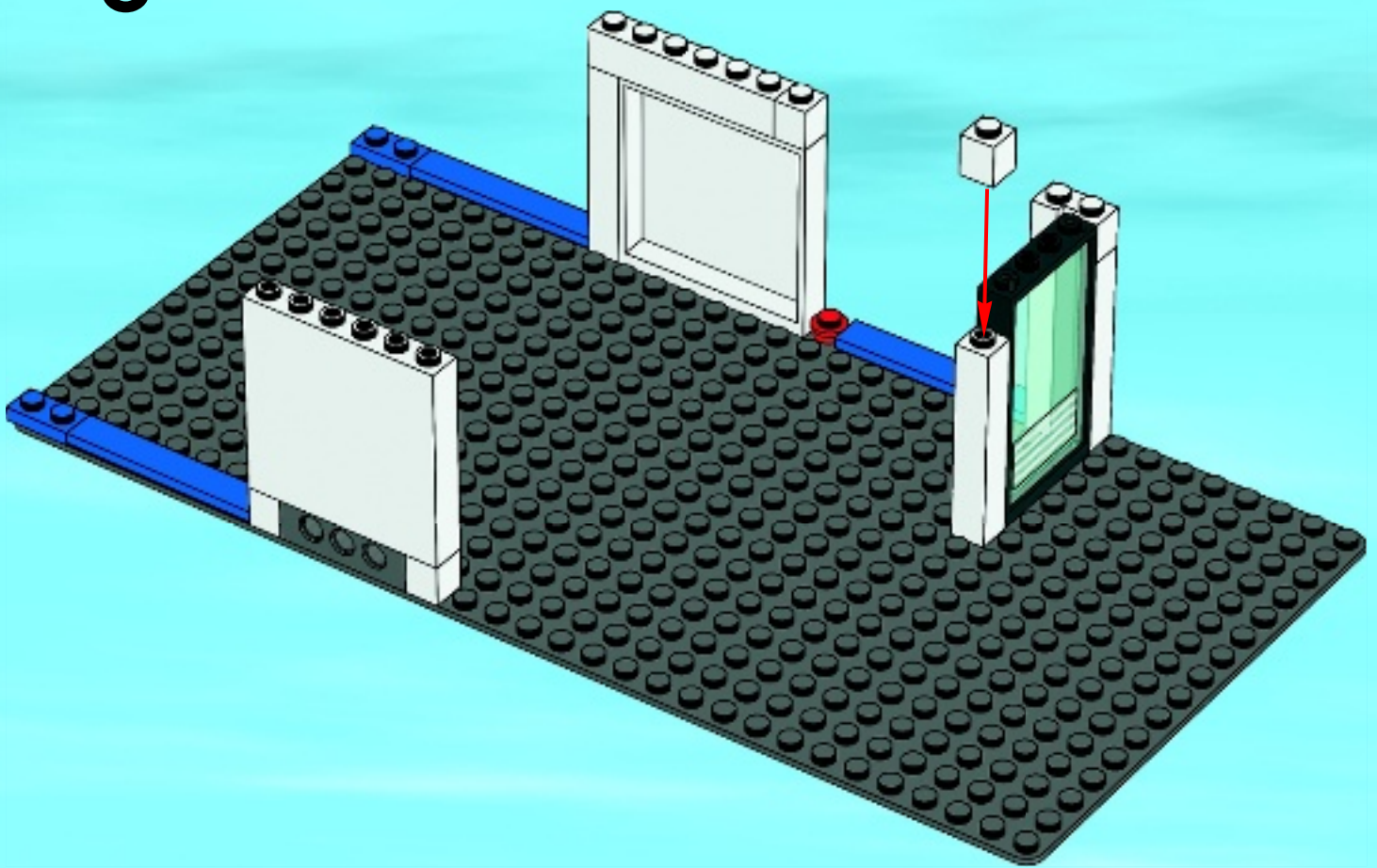

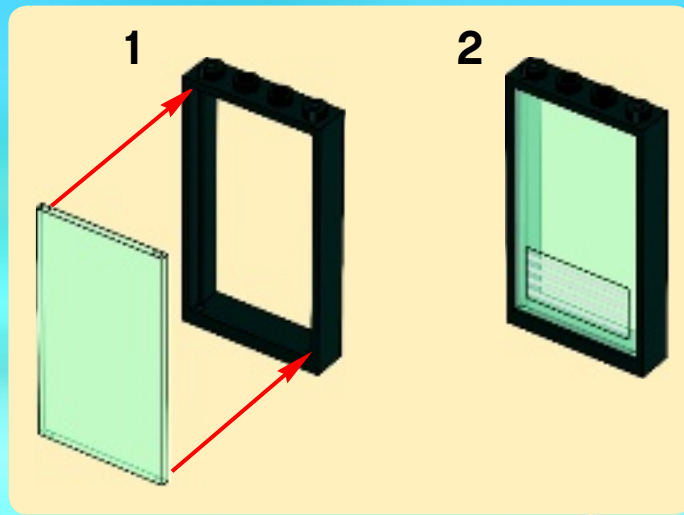

9

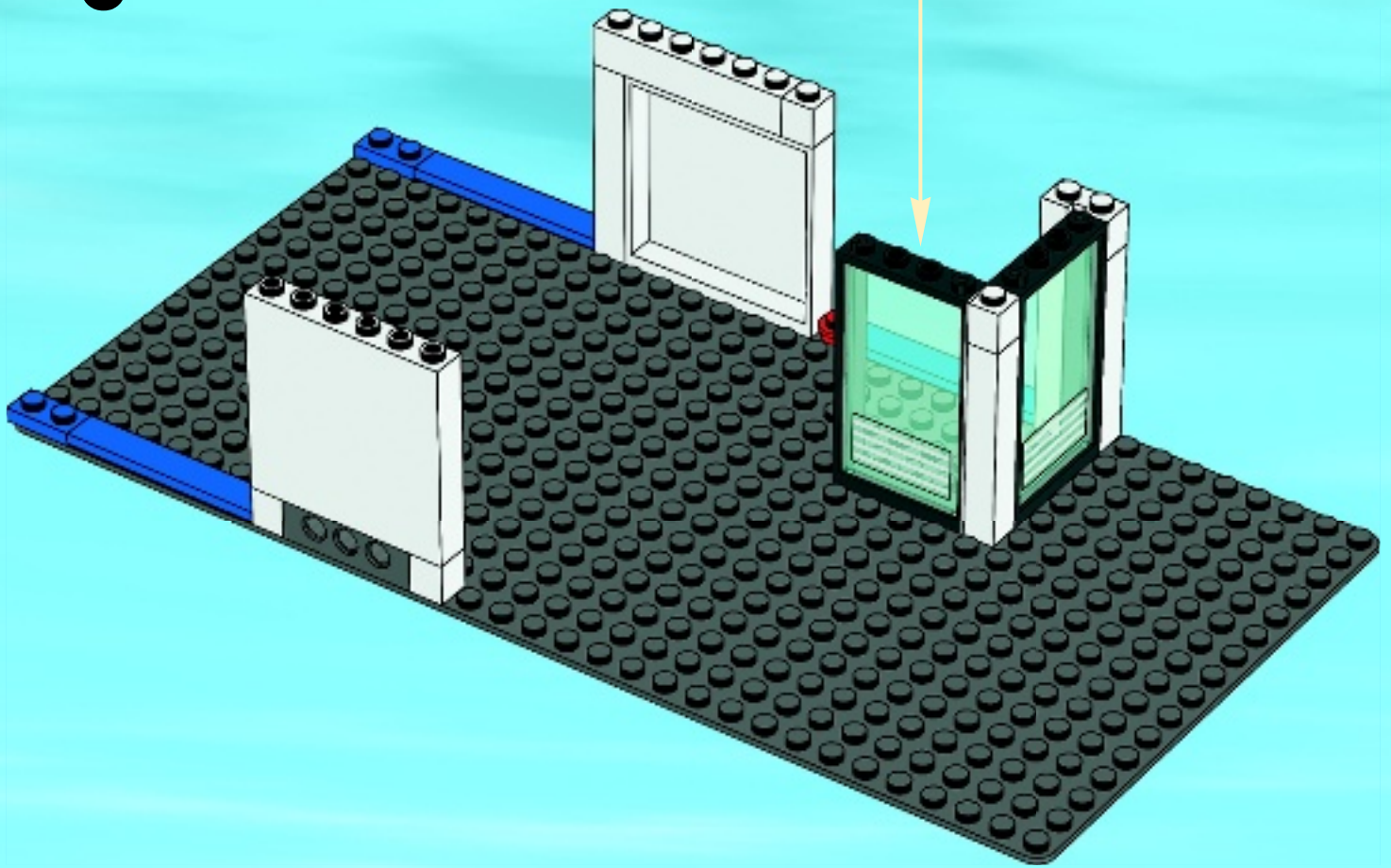

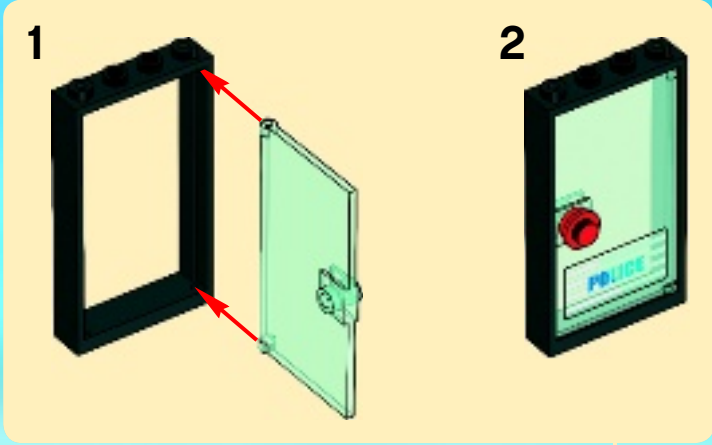

10

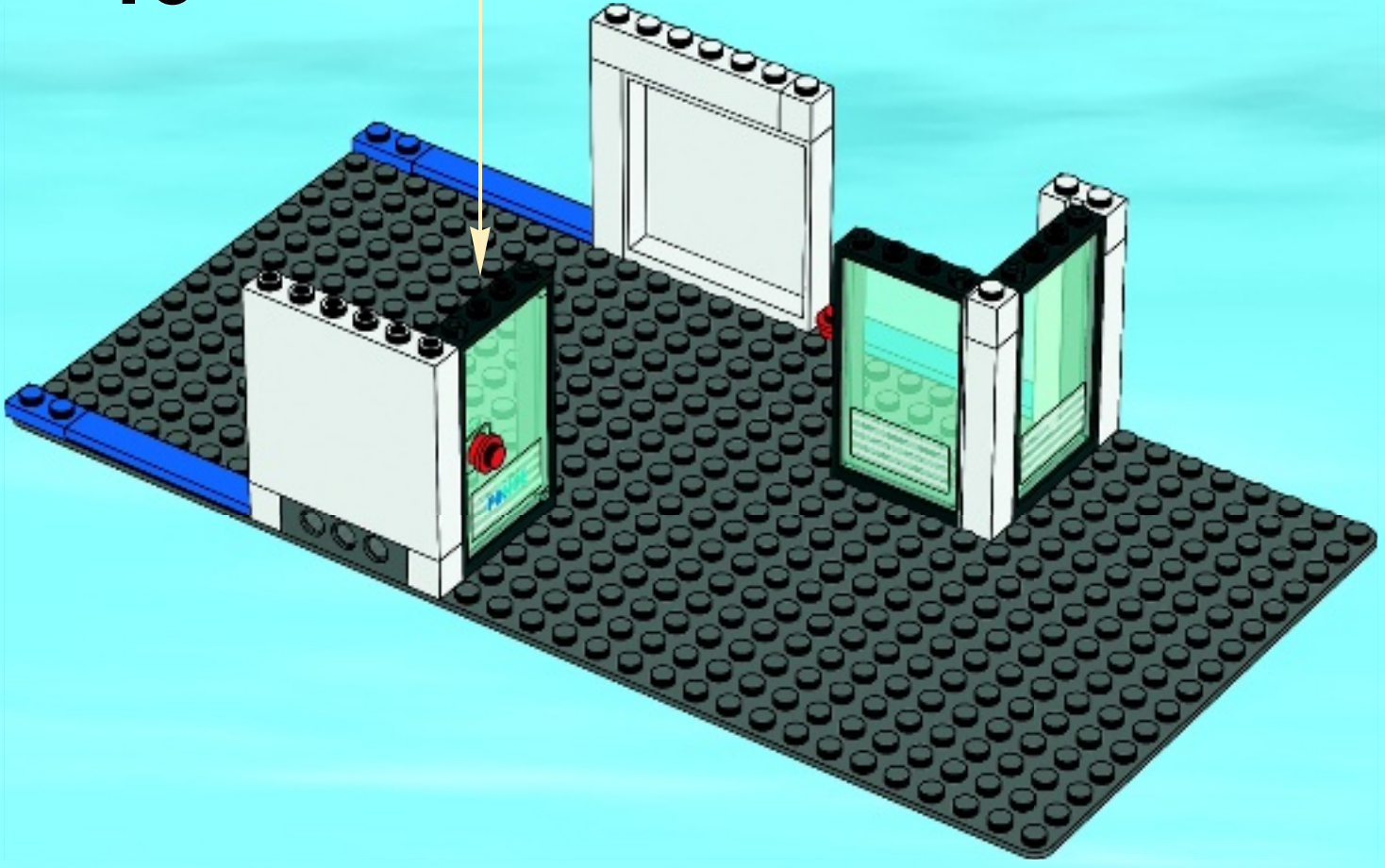



11

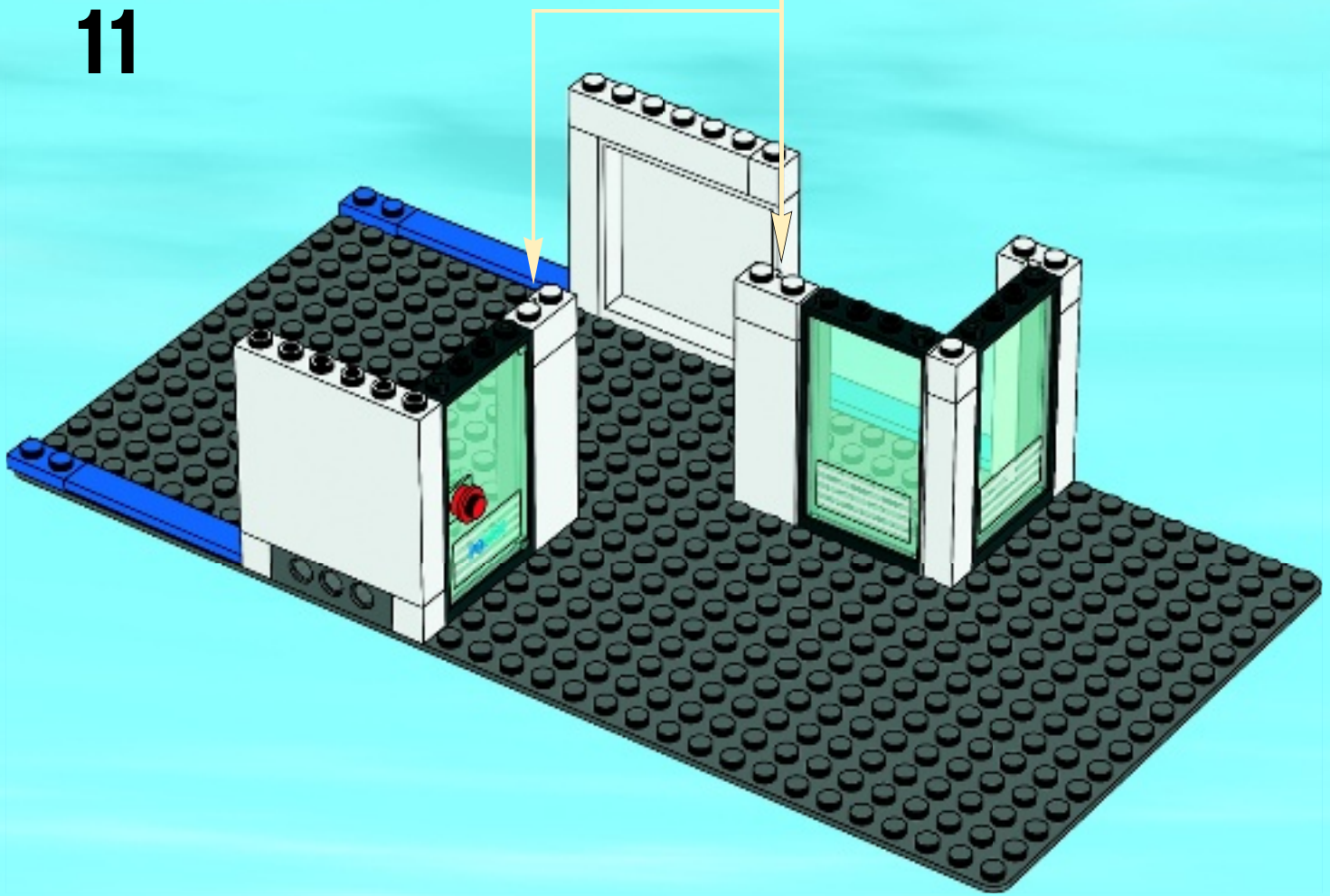
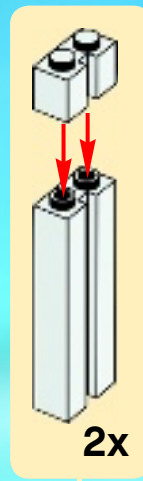

1



2



3

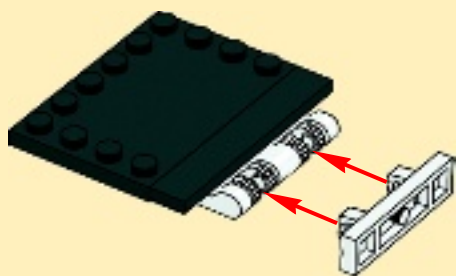

4



12

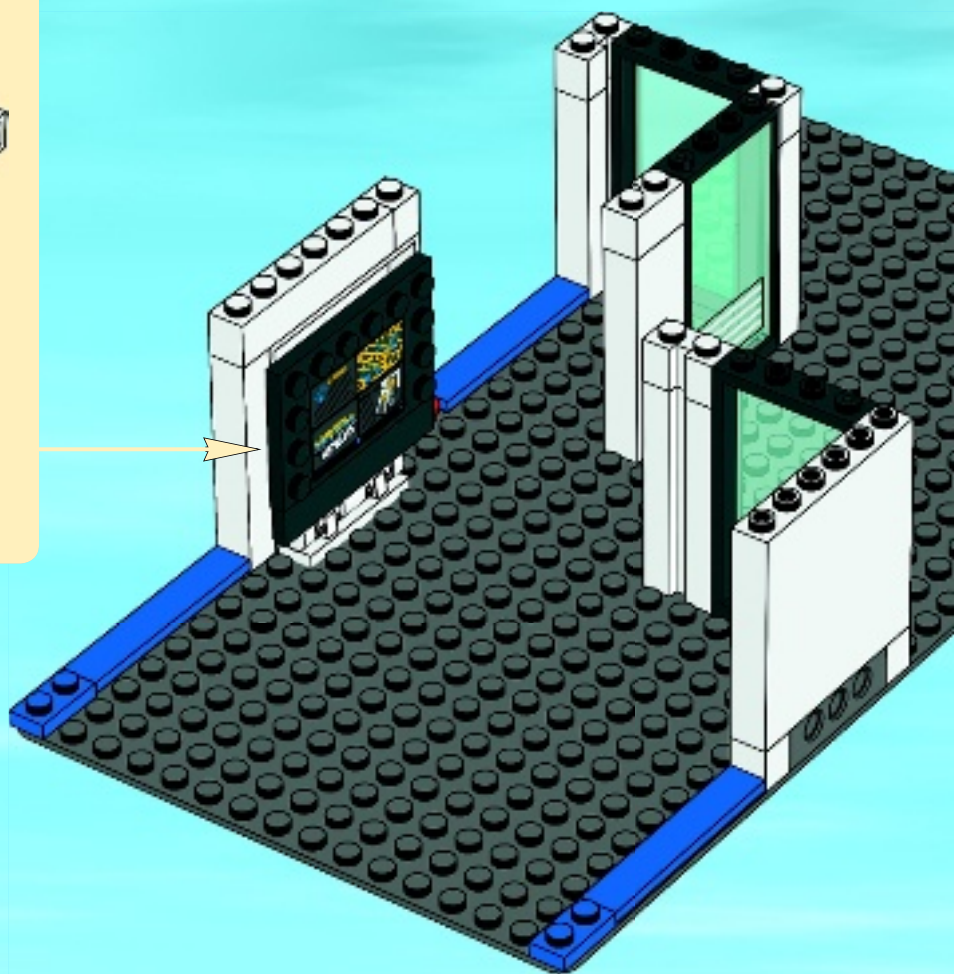

# 13

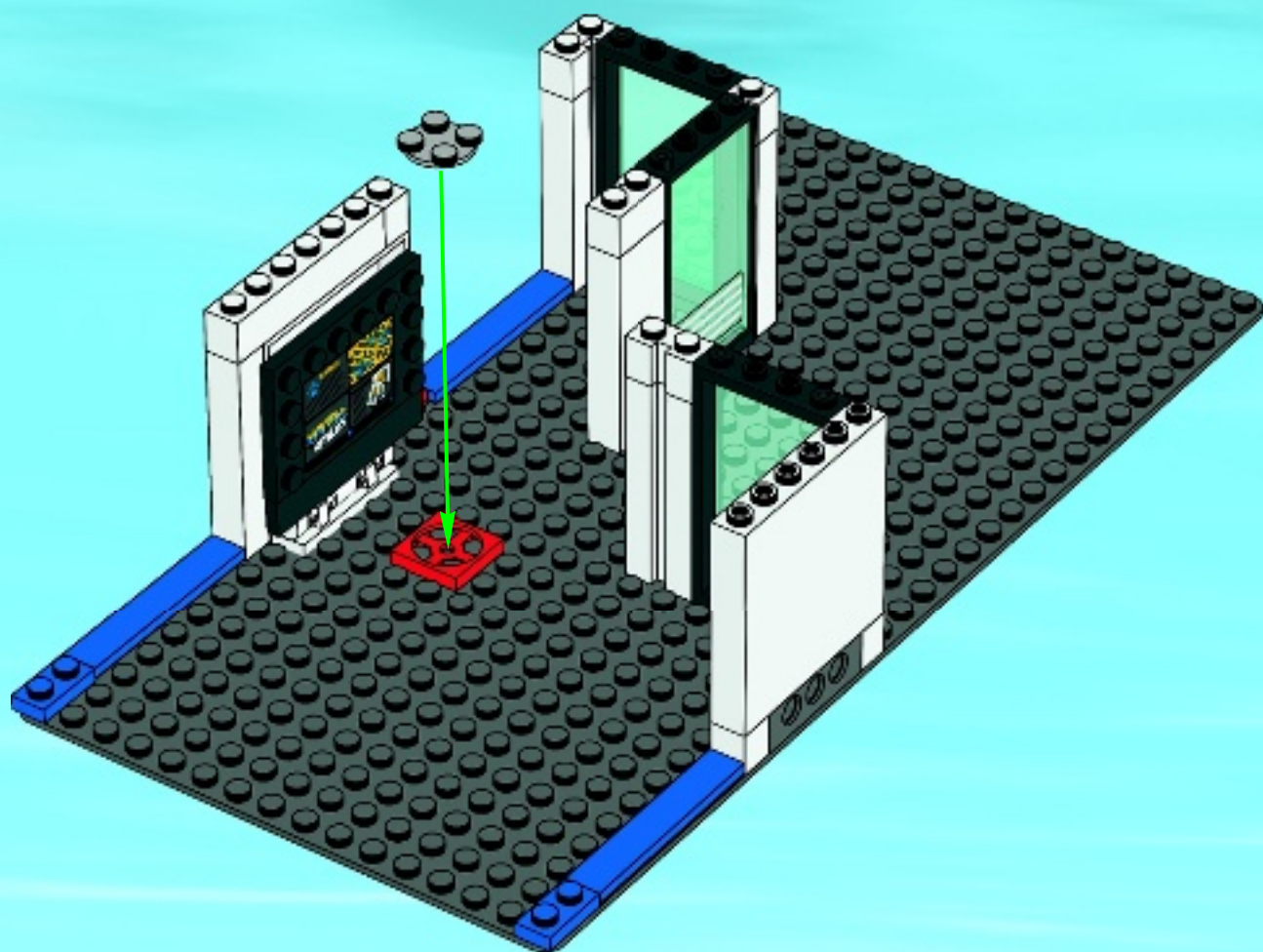



1

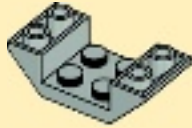

2

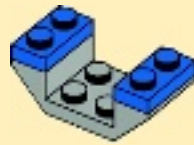

3



14

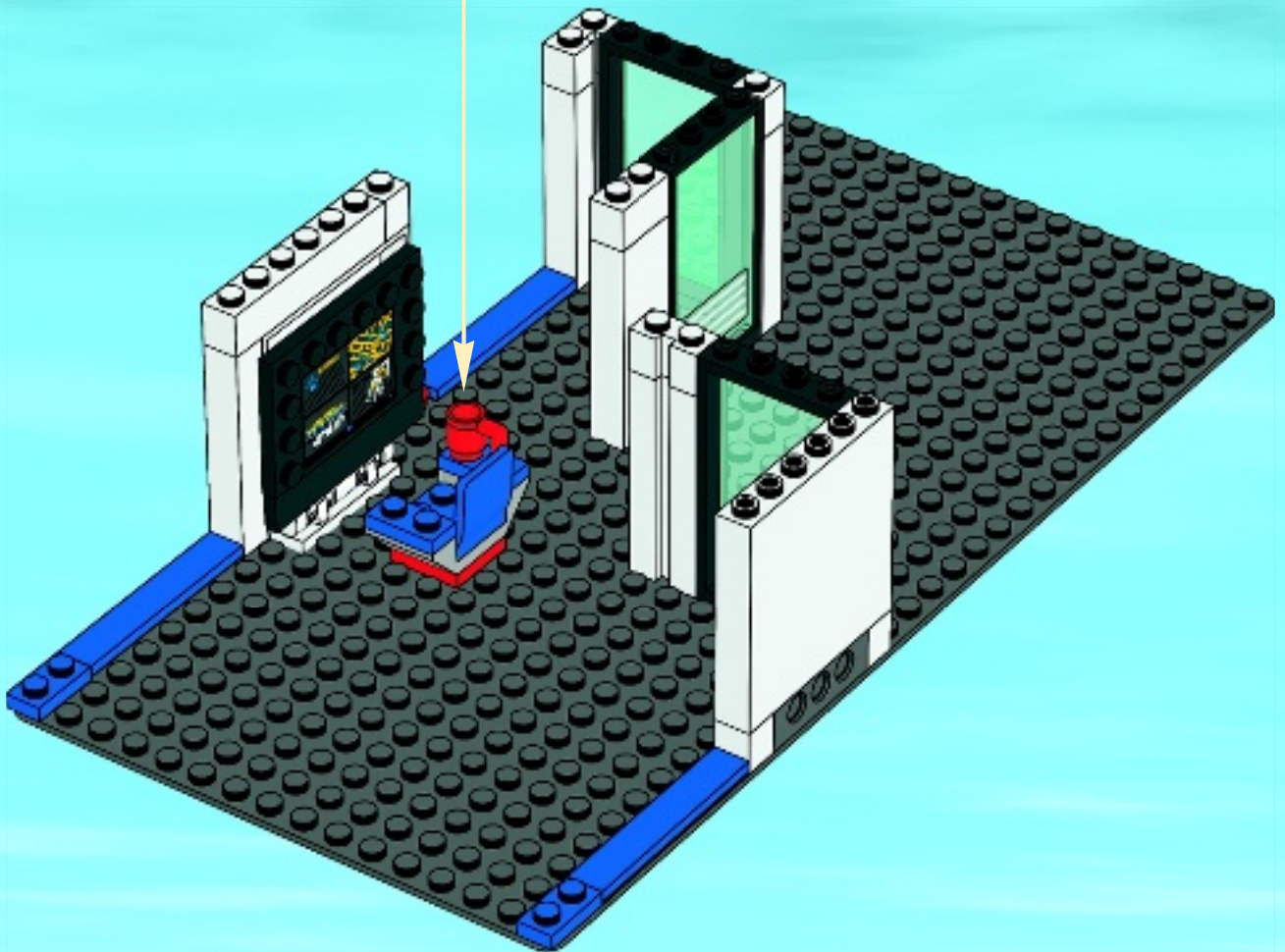

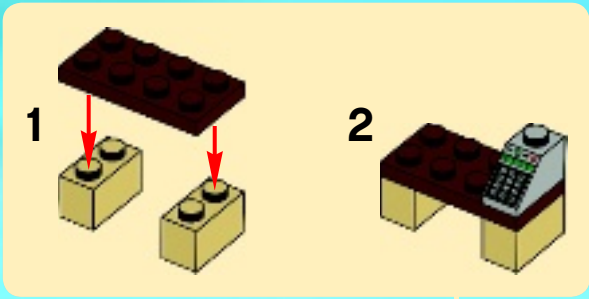

15

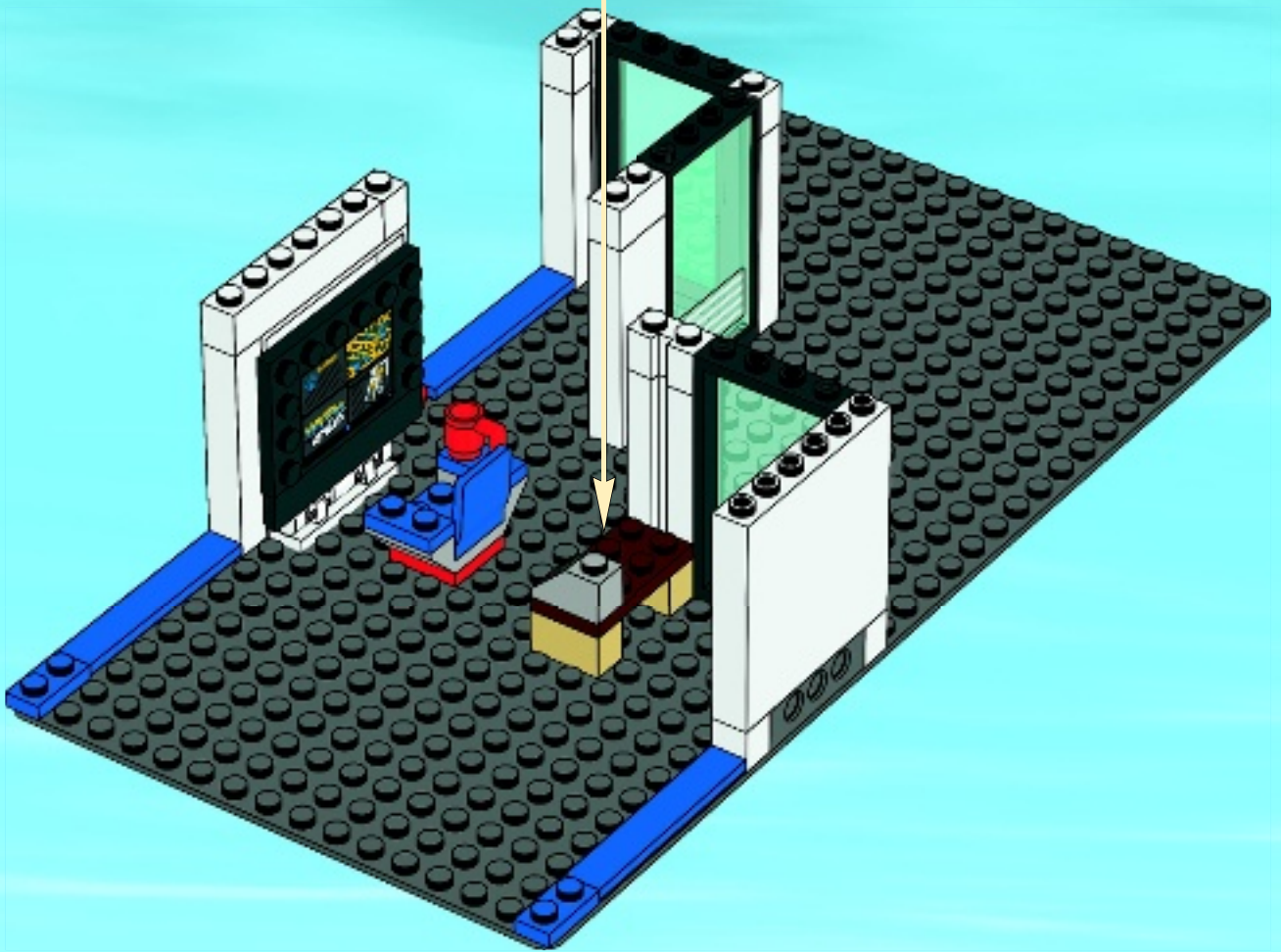

16

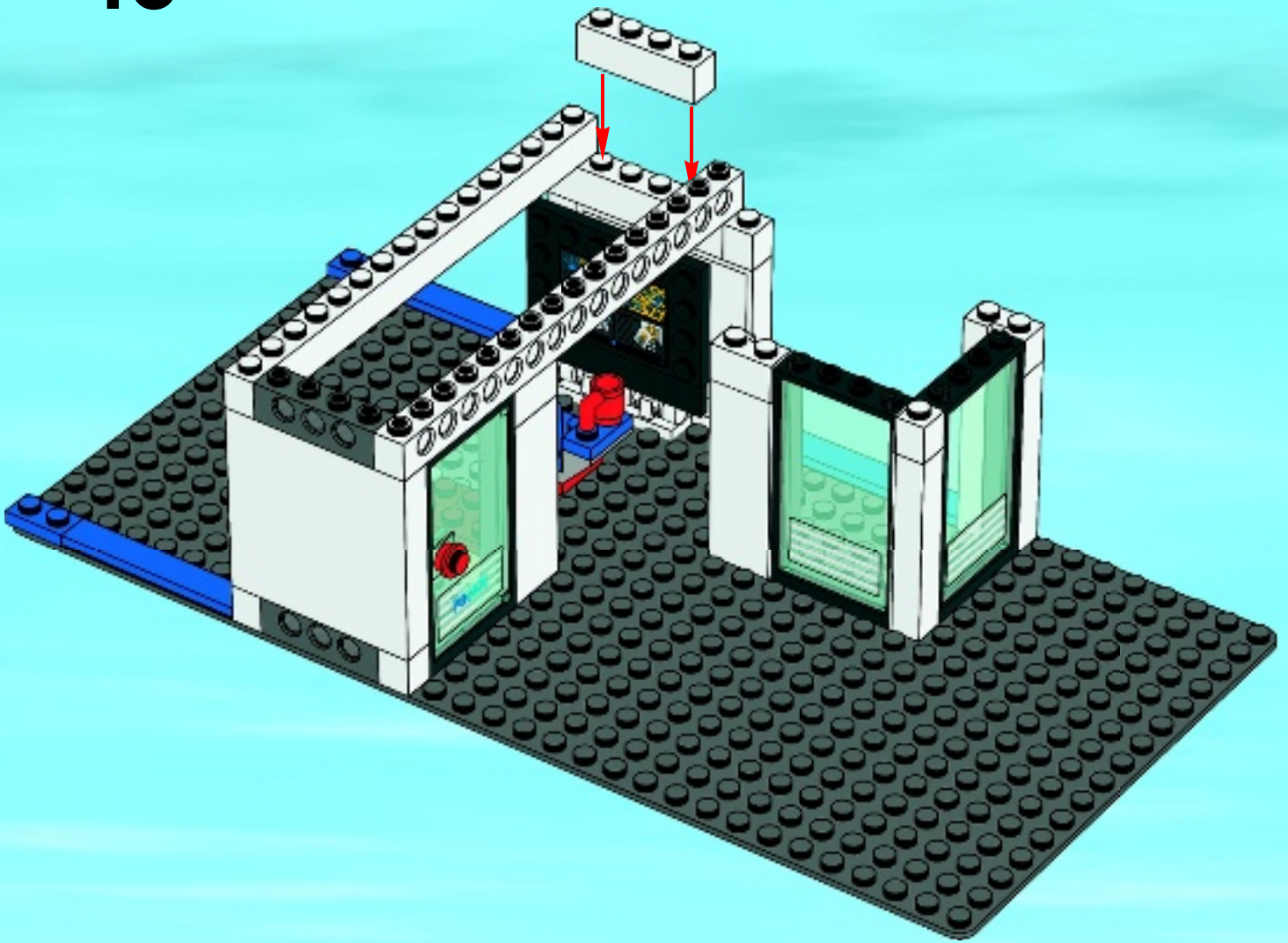



17

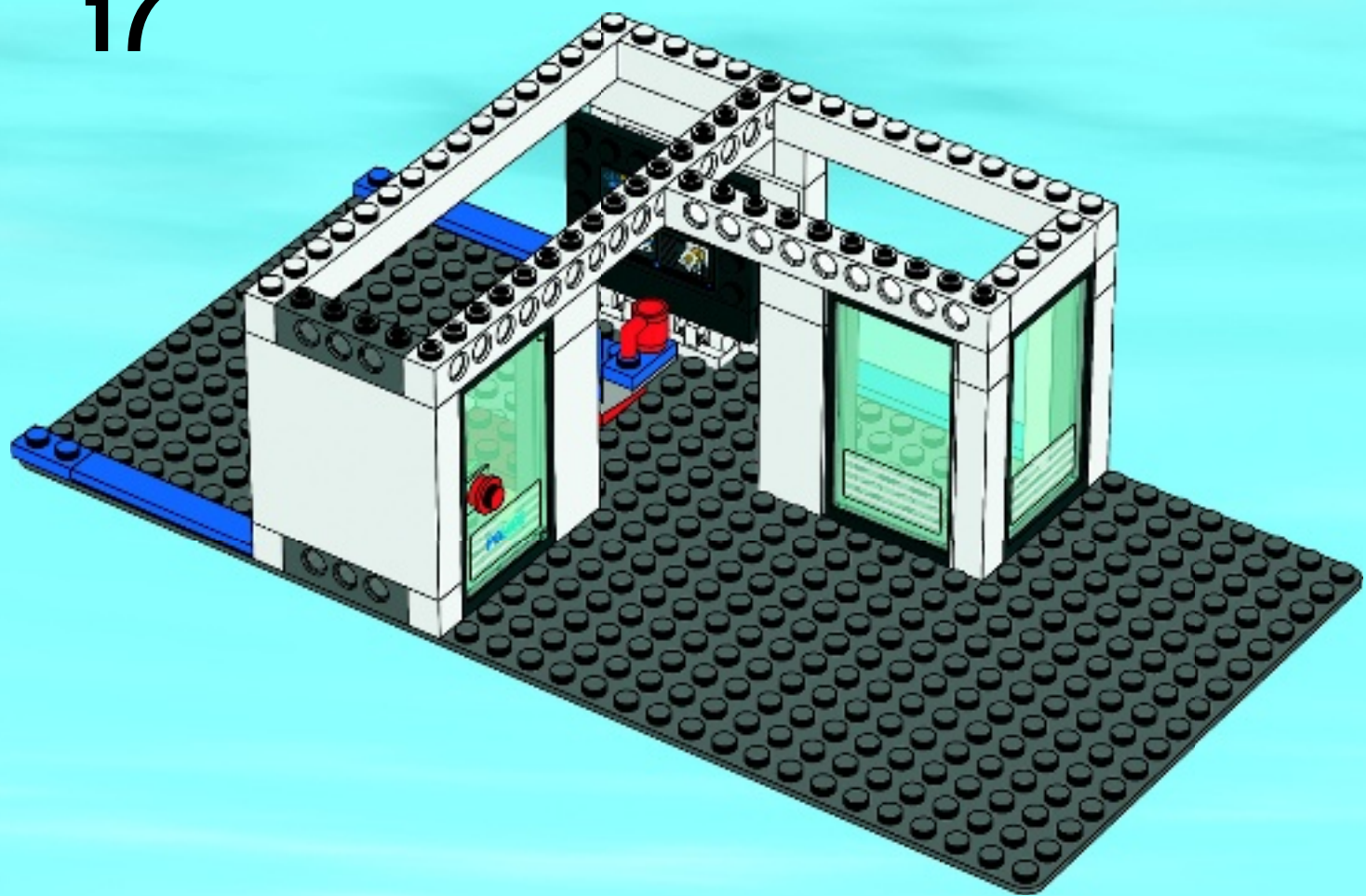

18

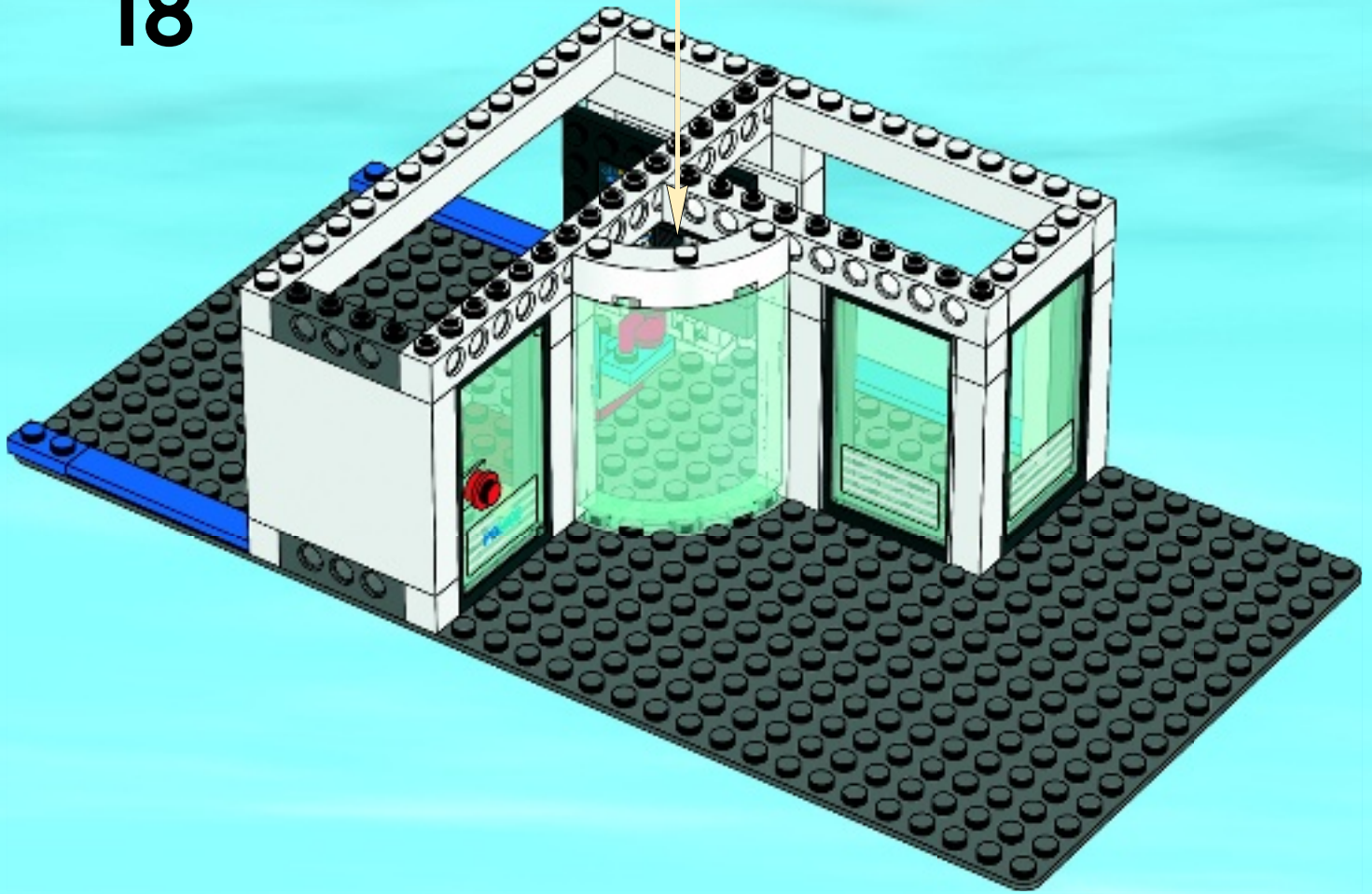
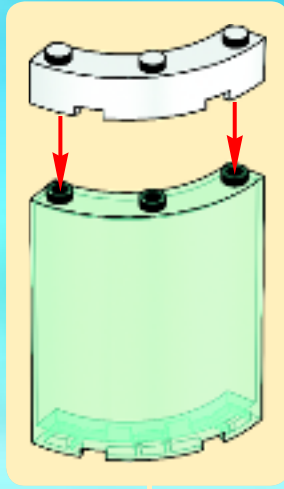

19

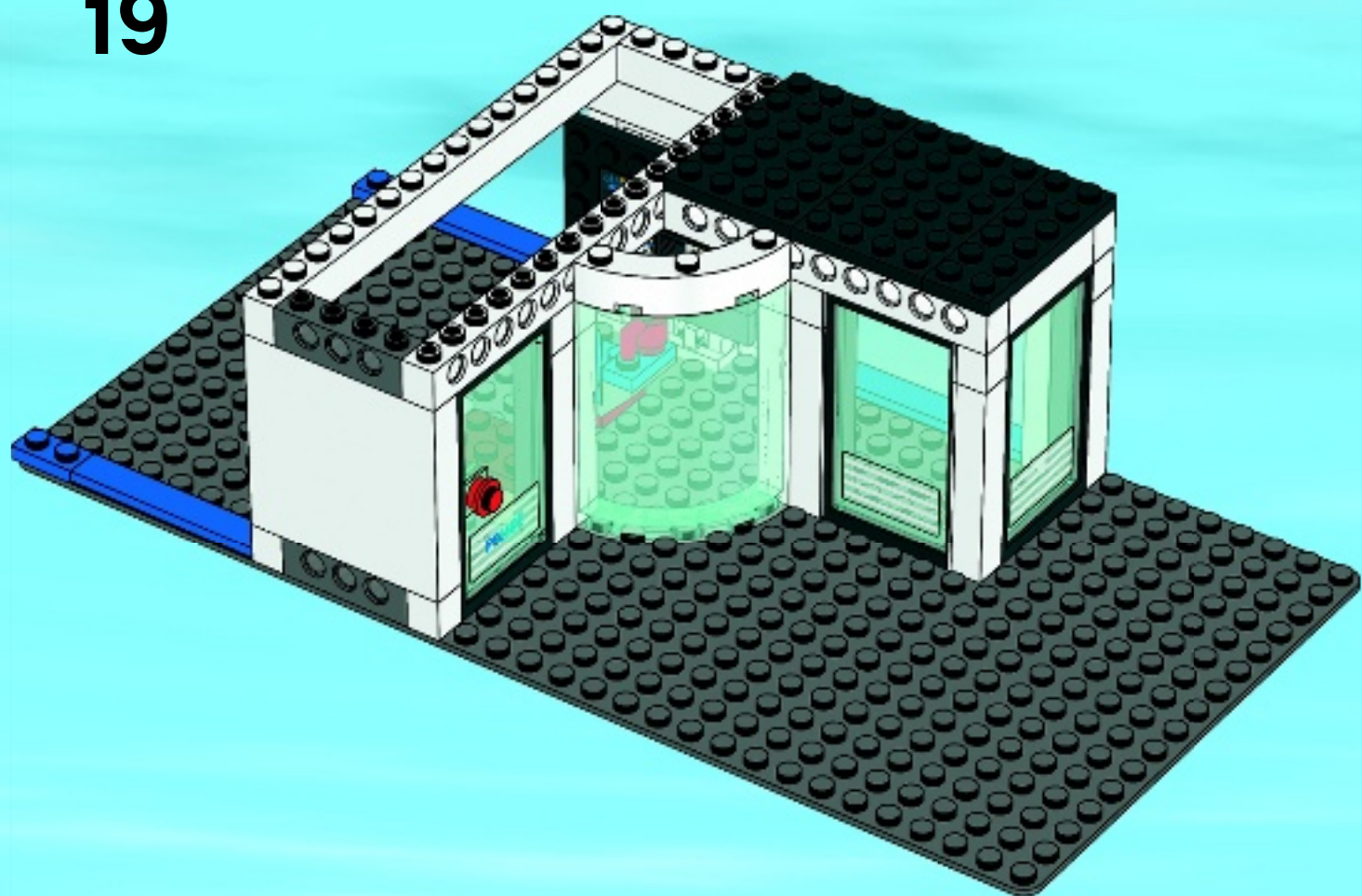



20

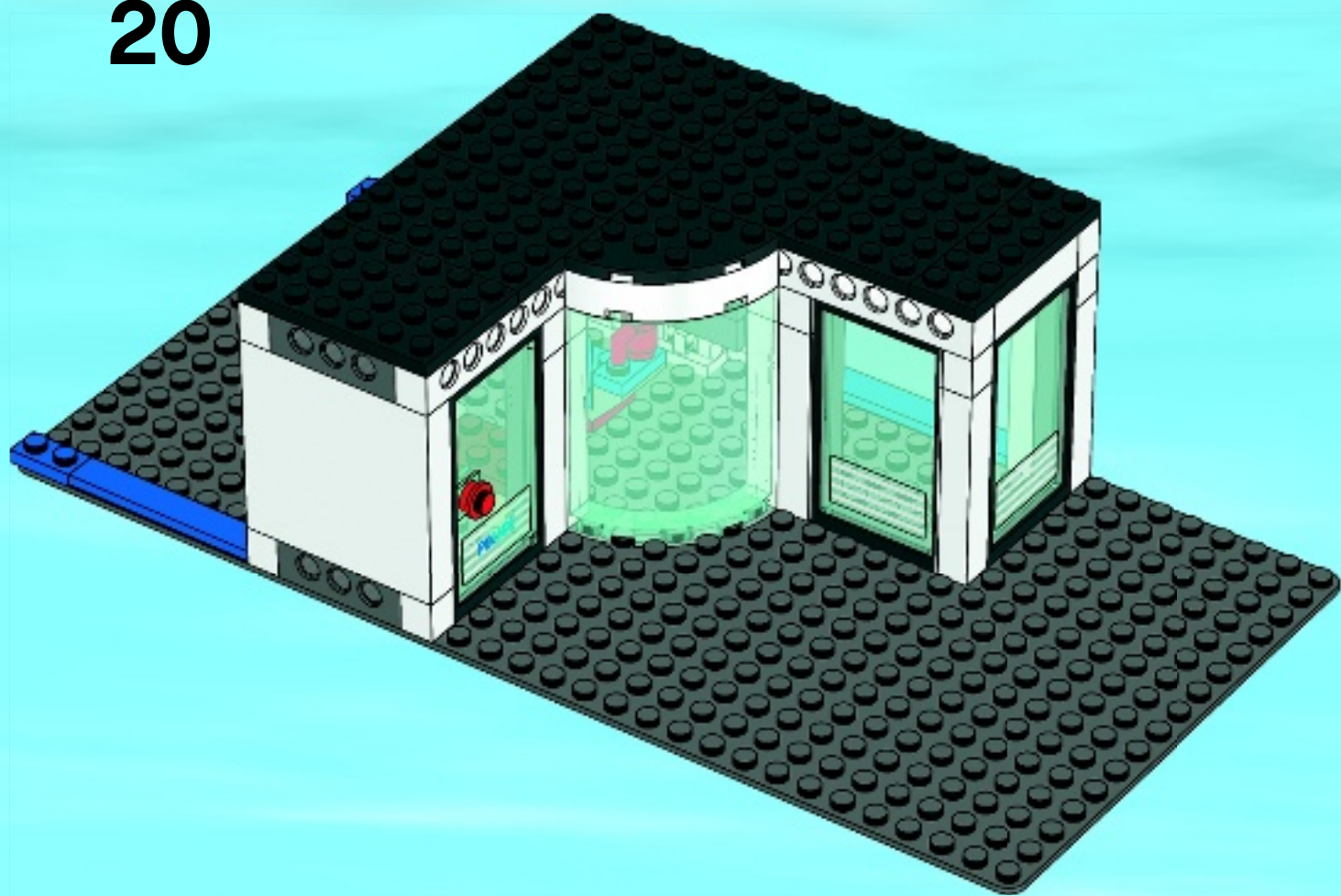

21

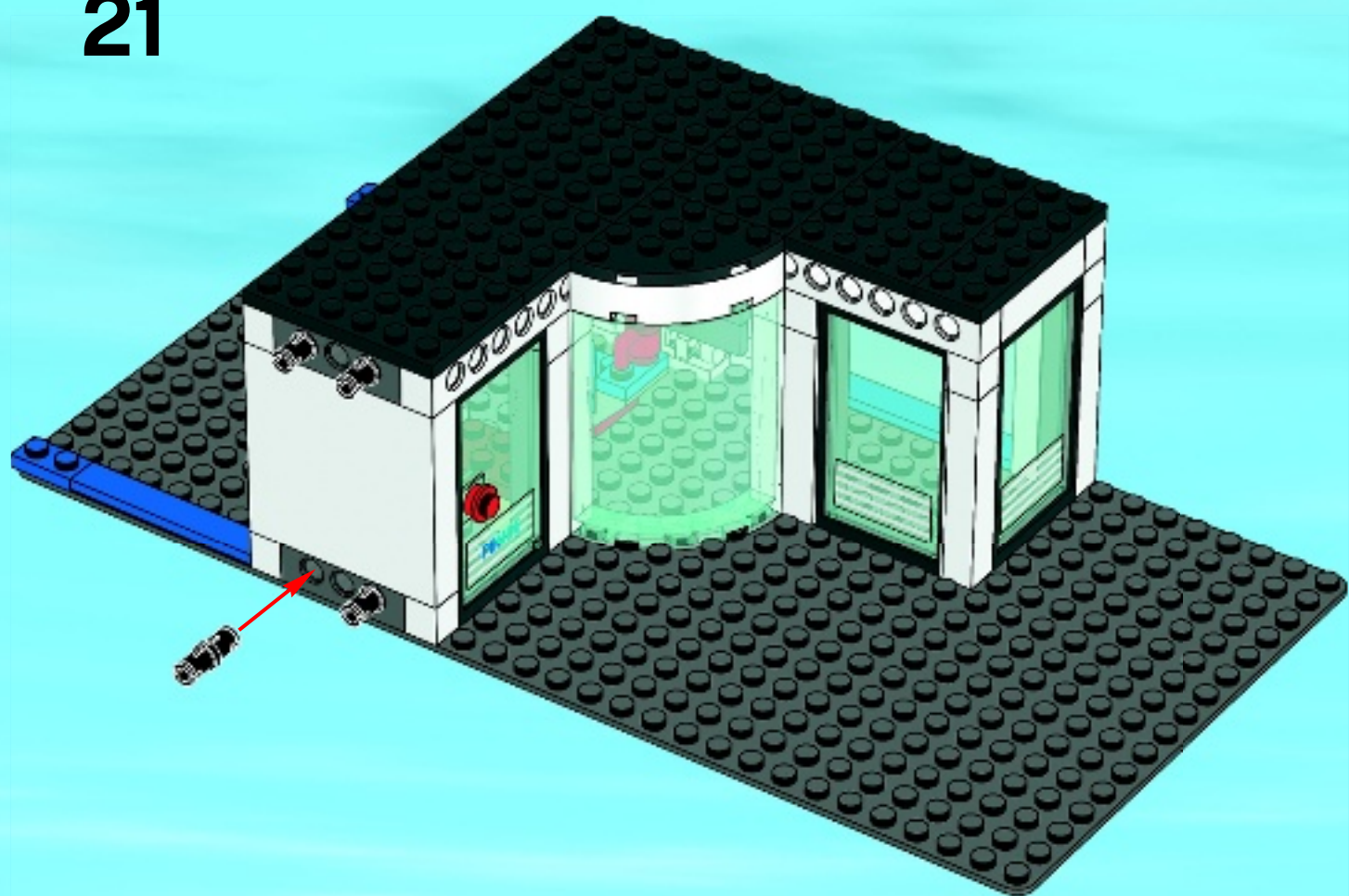

22

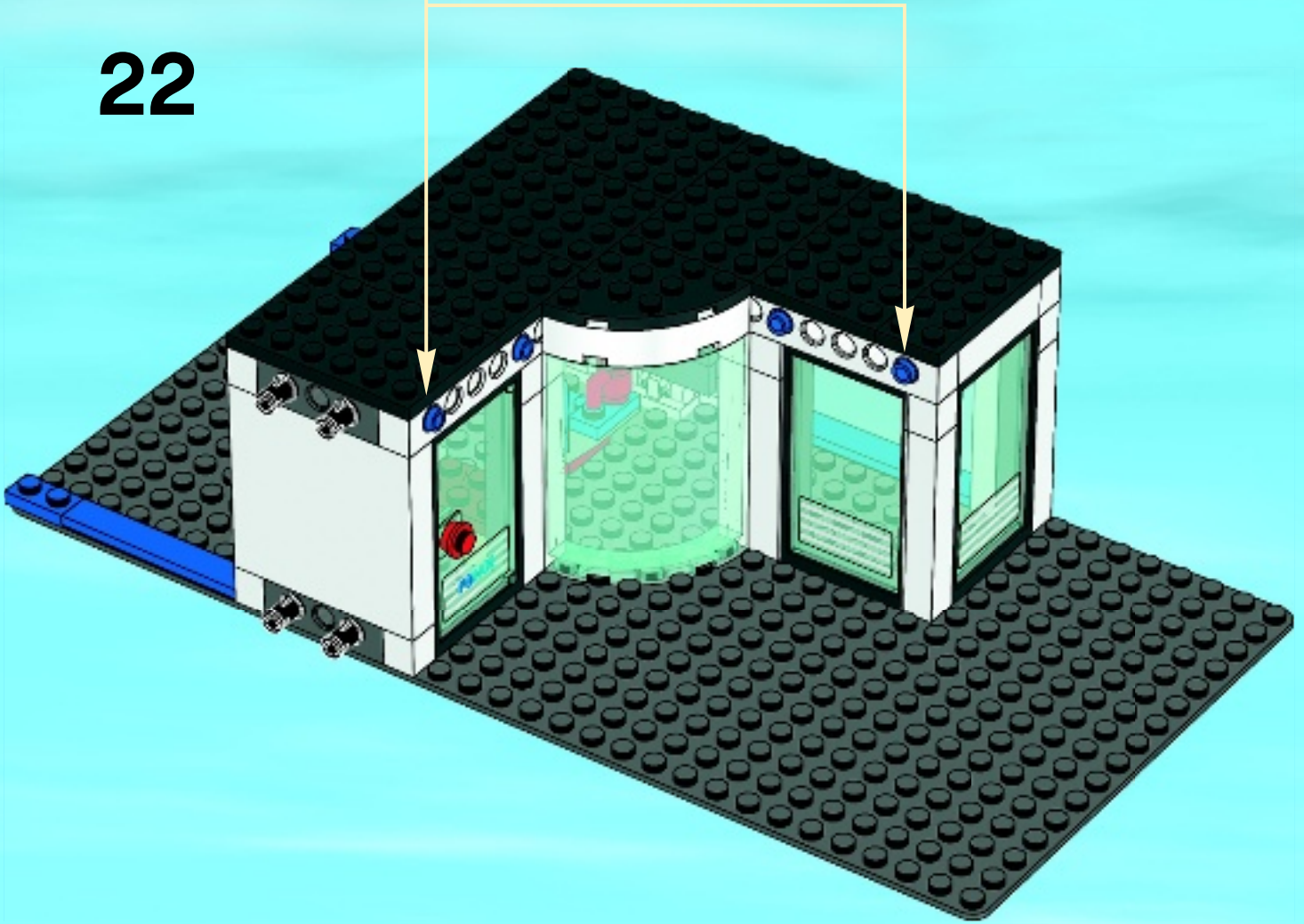



23

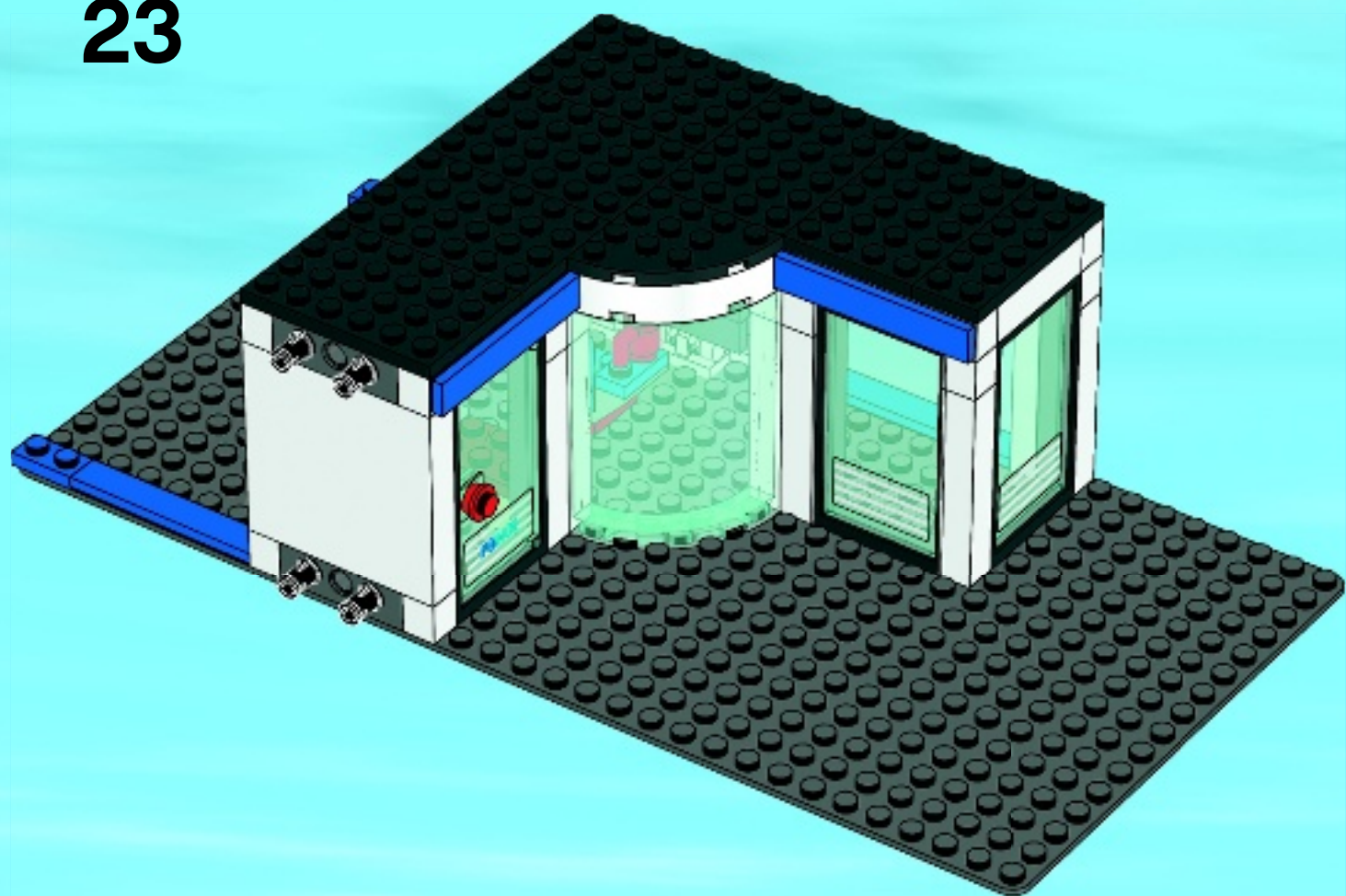



24

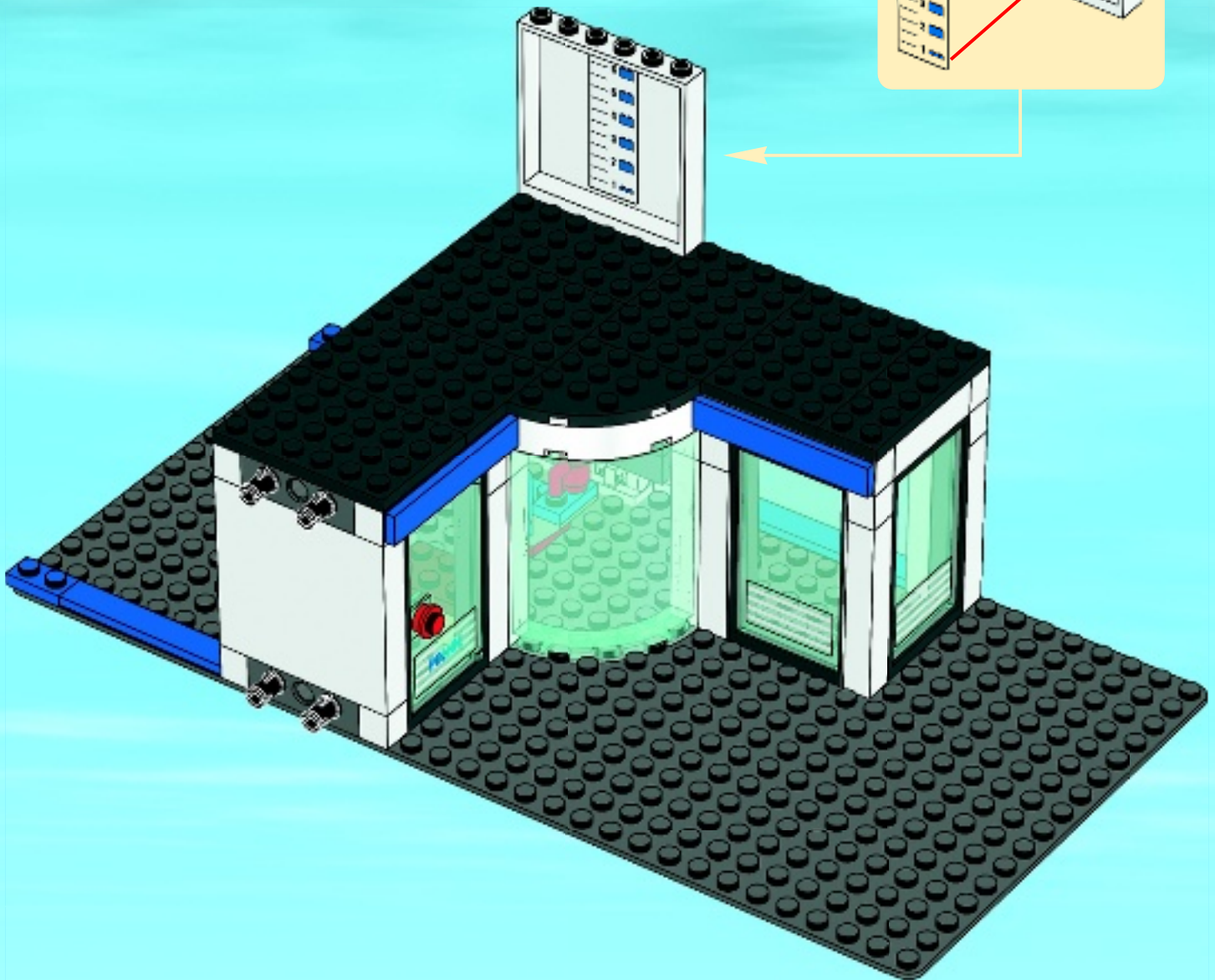
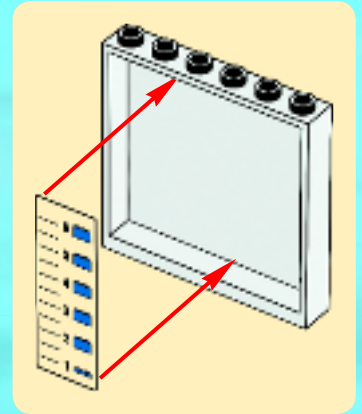

25

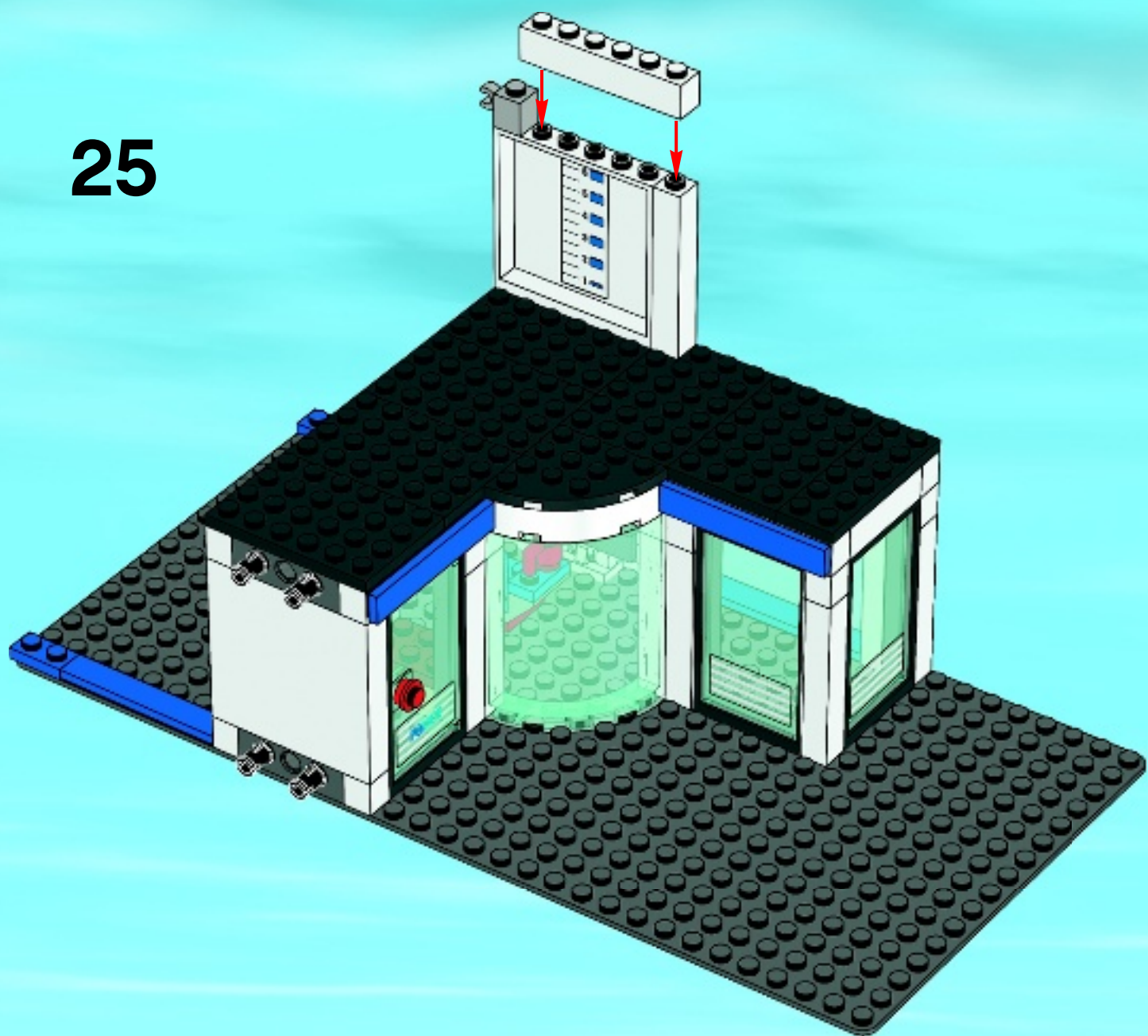





1



2



3



4

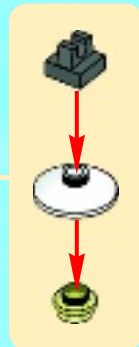

26

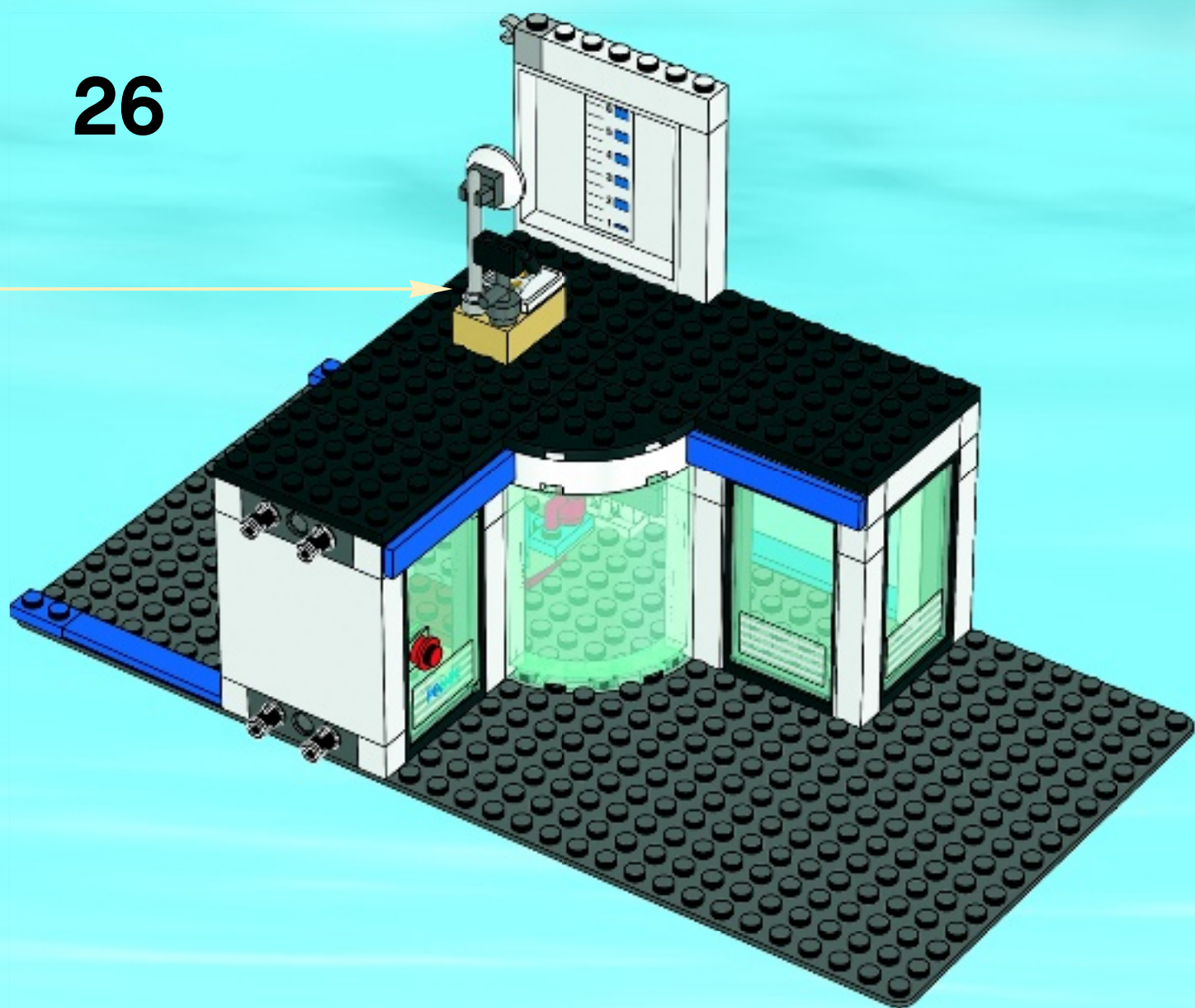

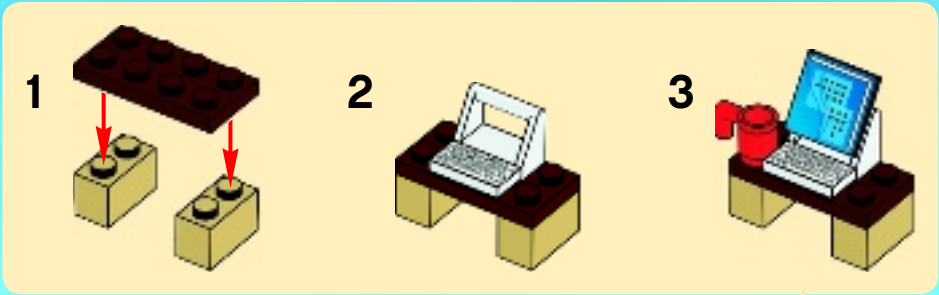

27

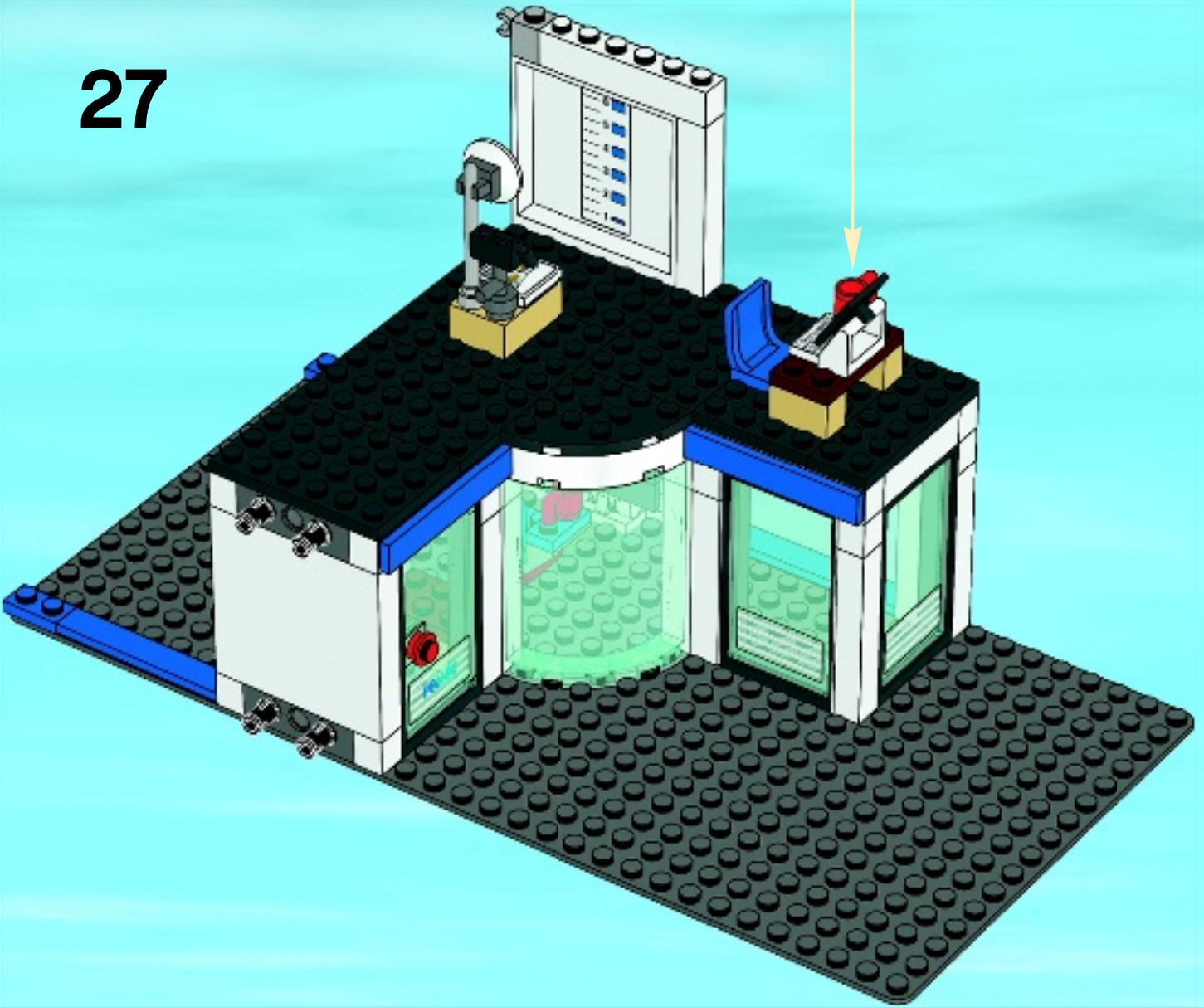



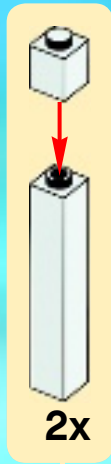

28

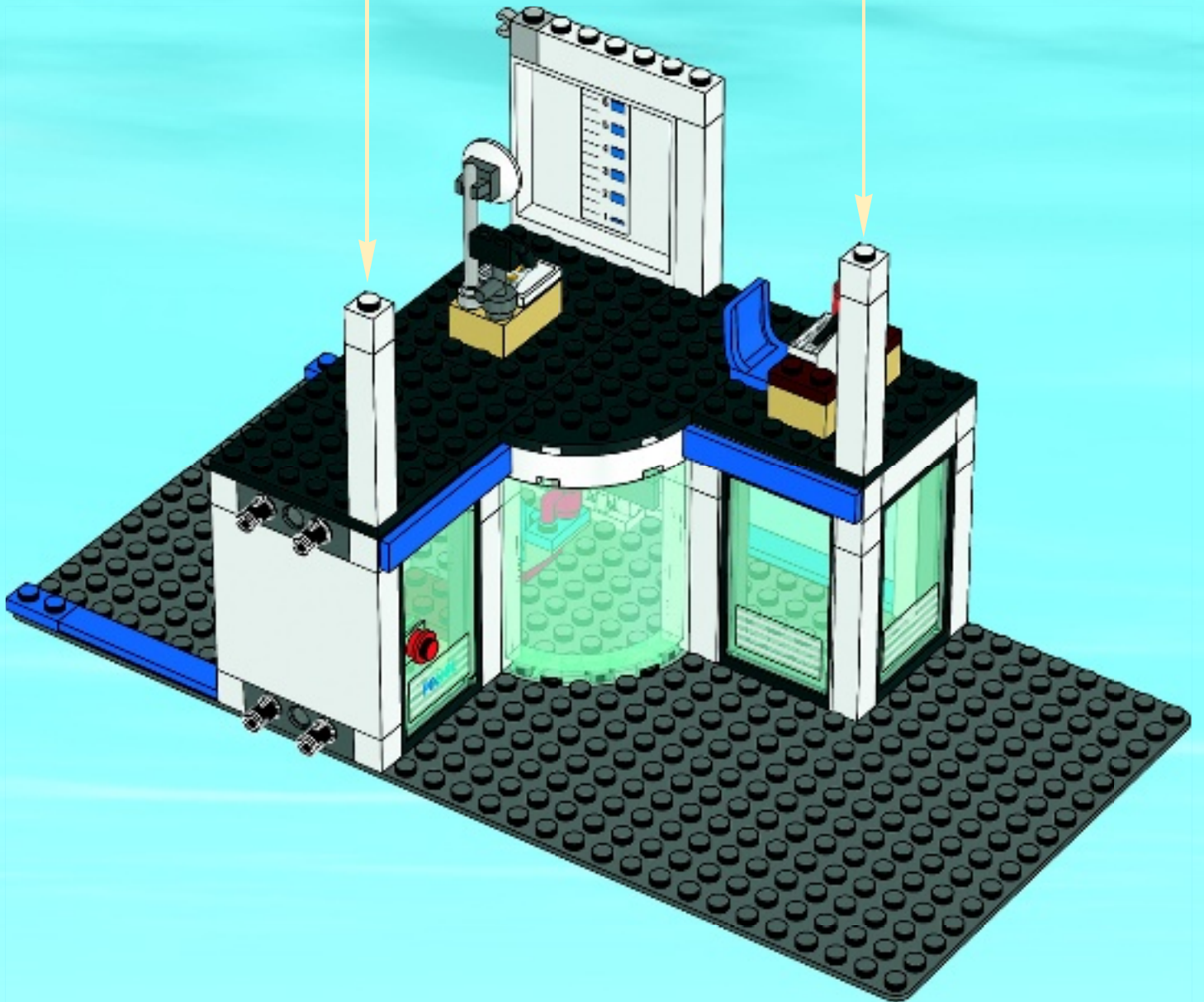

29

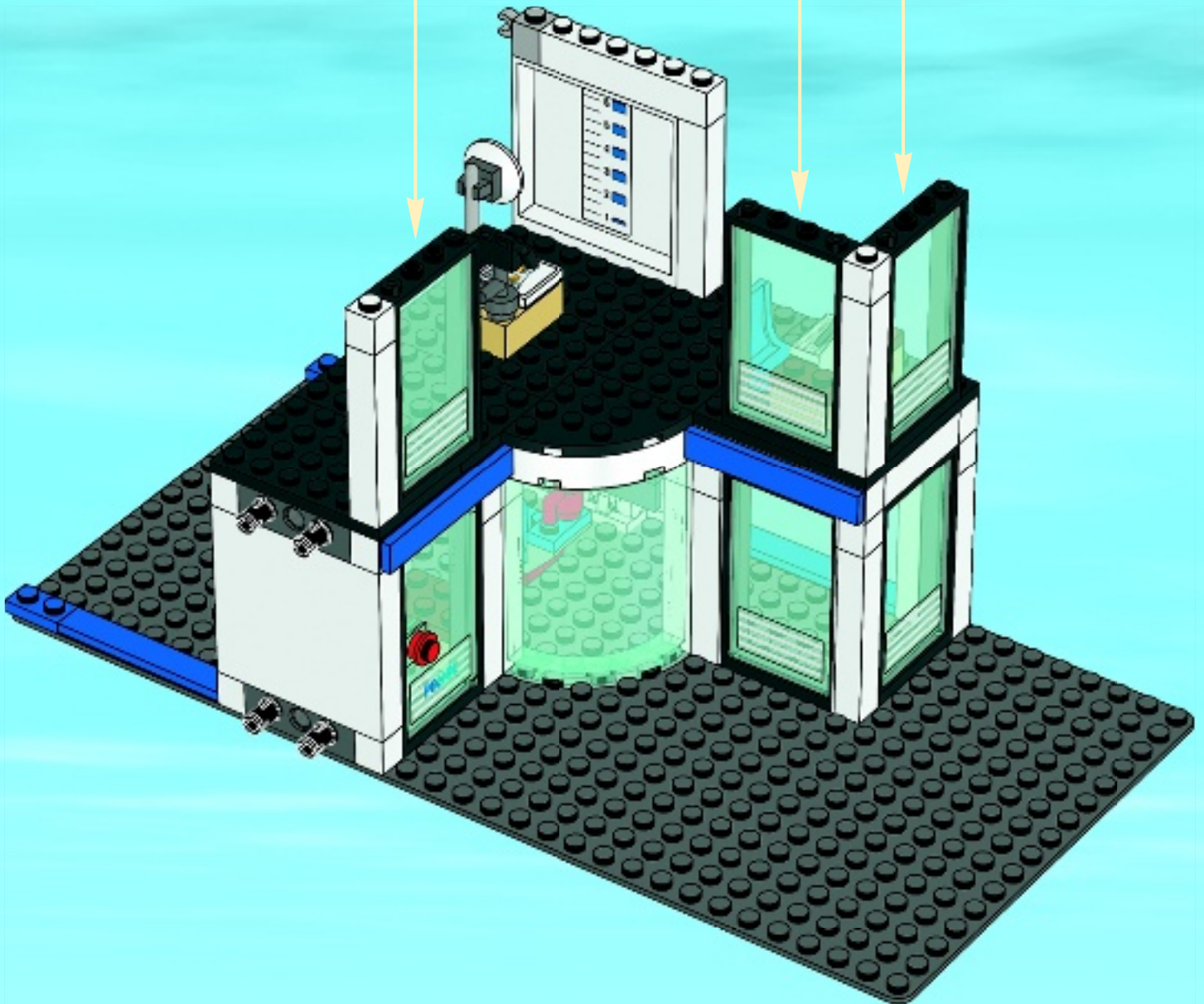
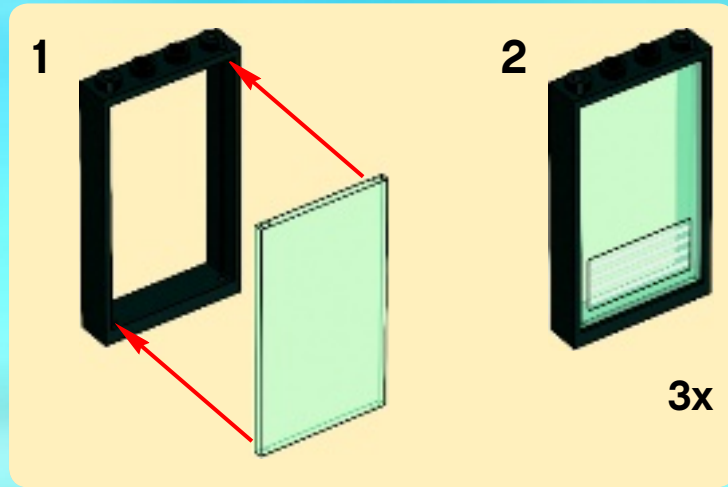



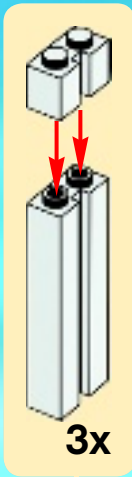

30

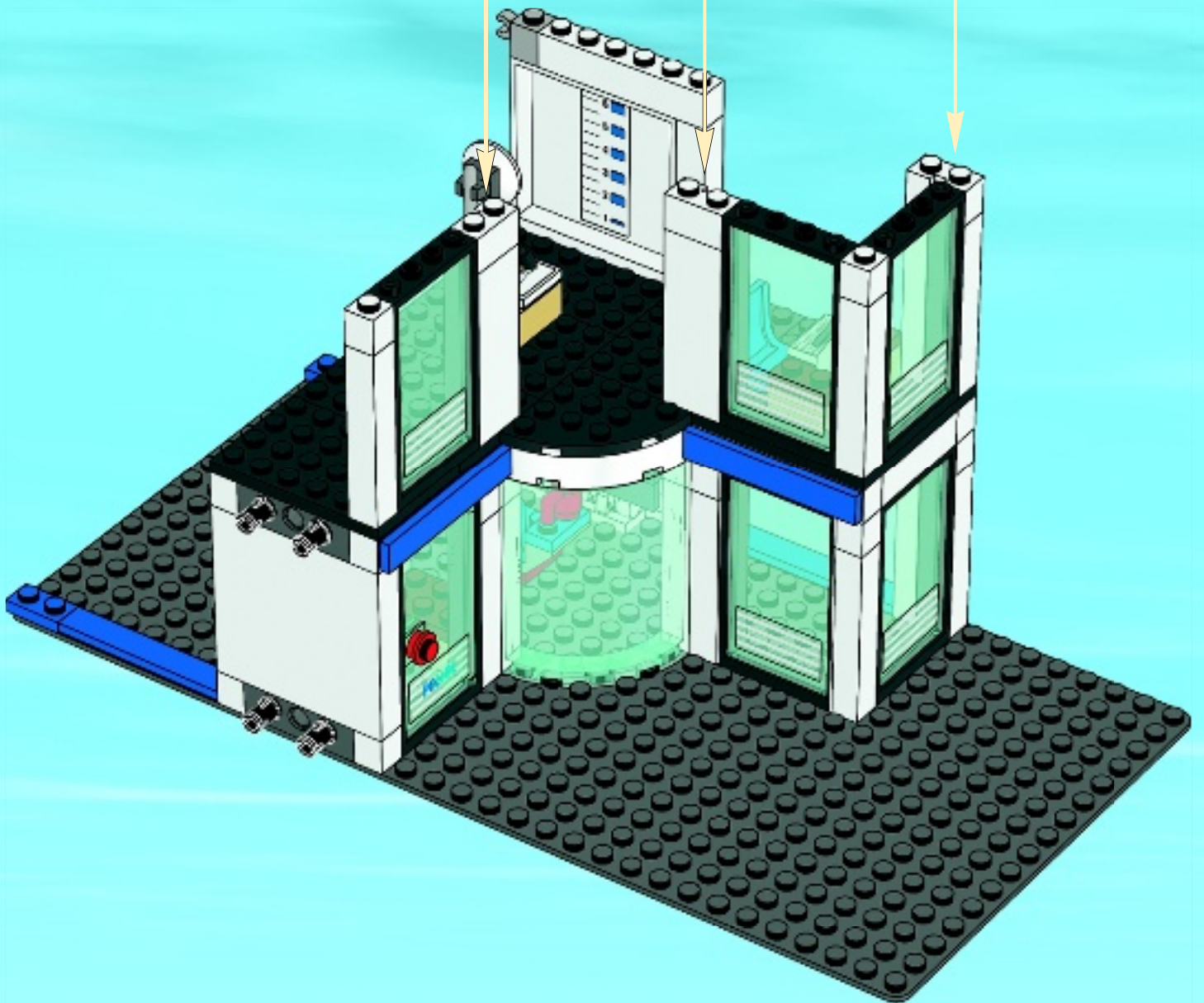



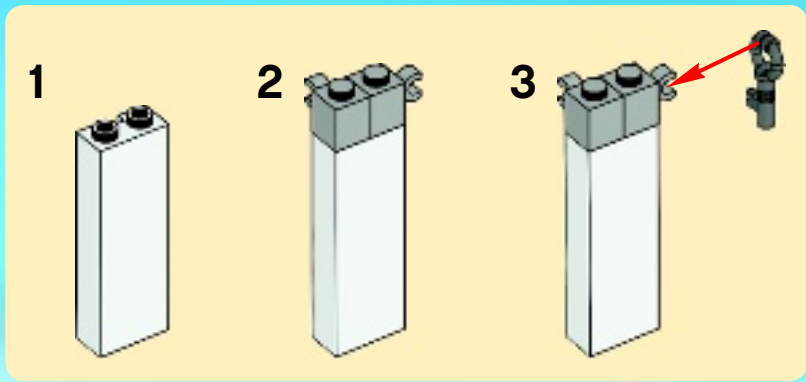

31

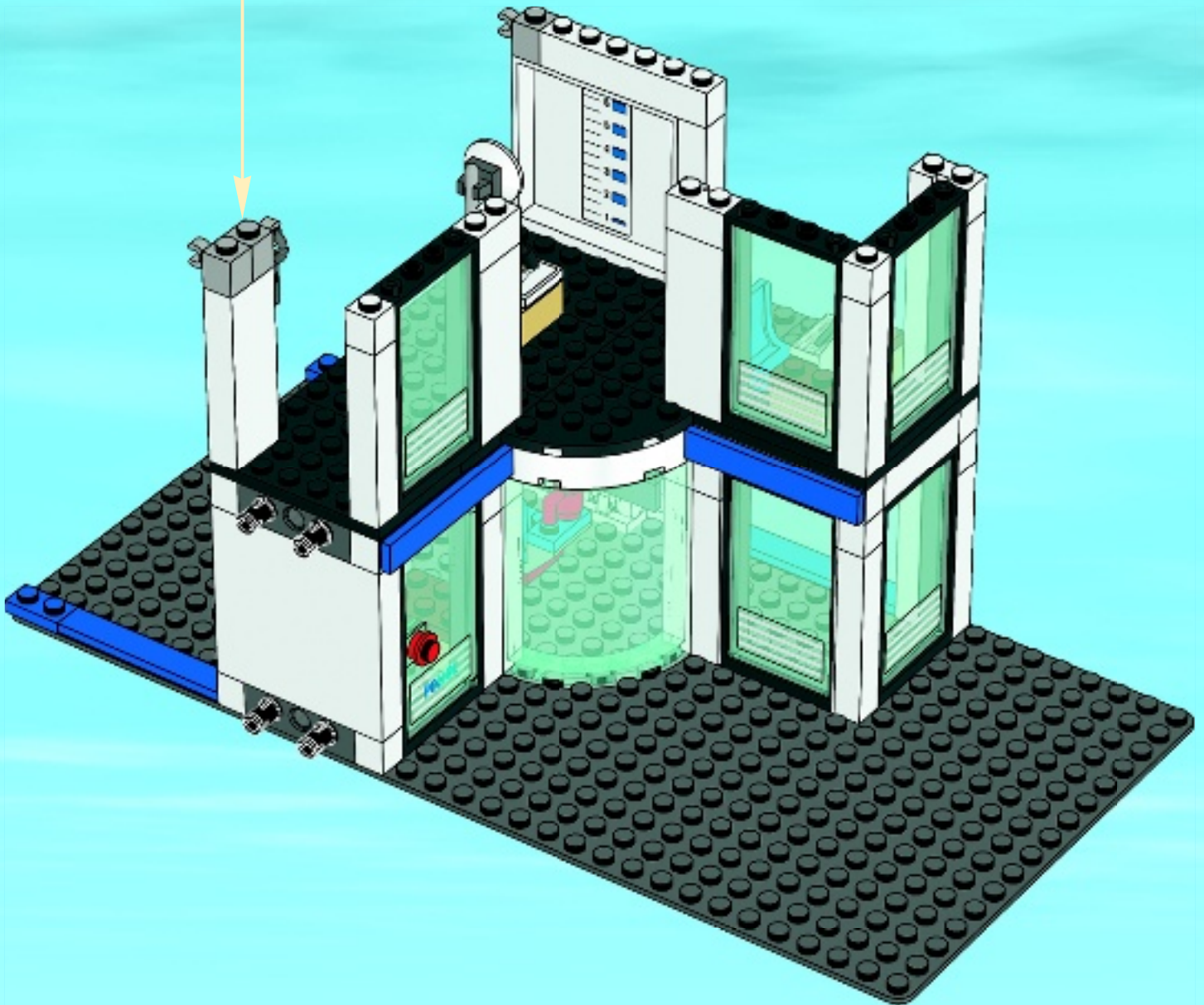

32

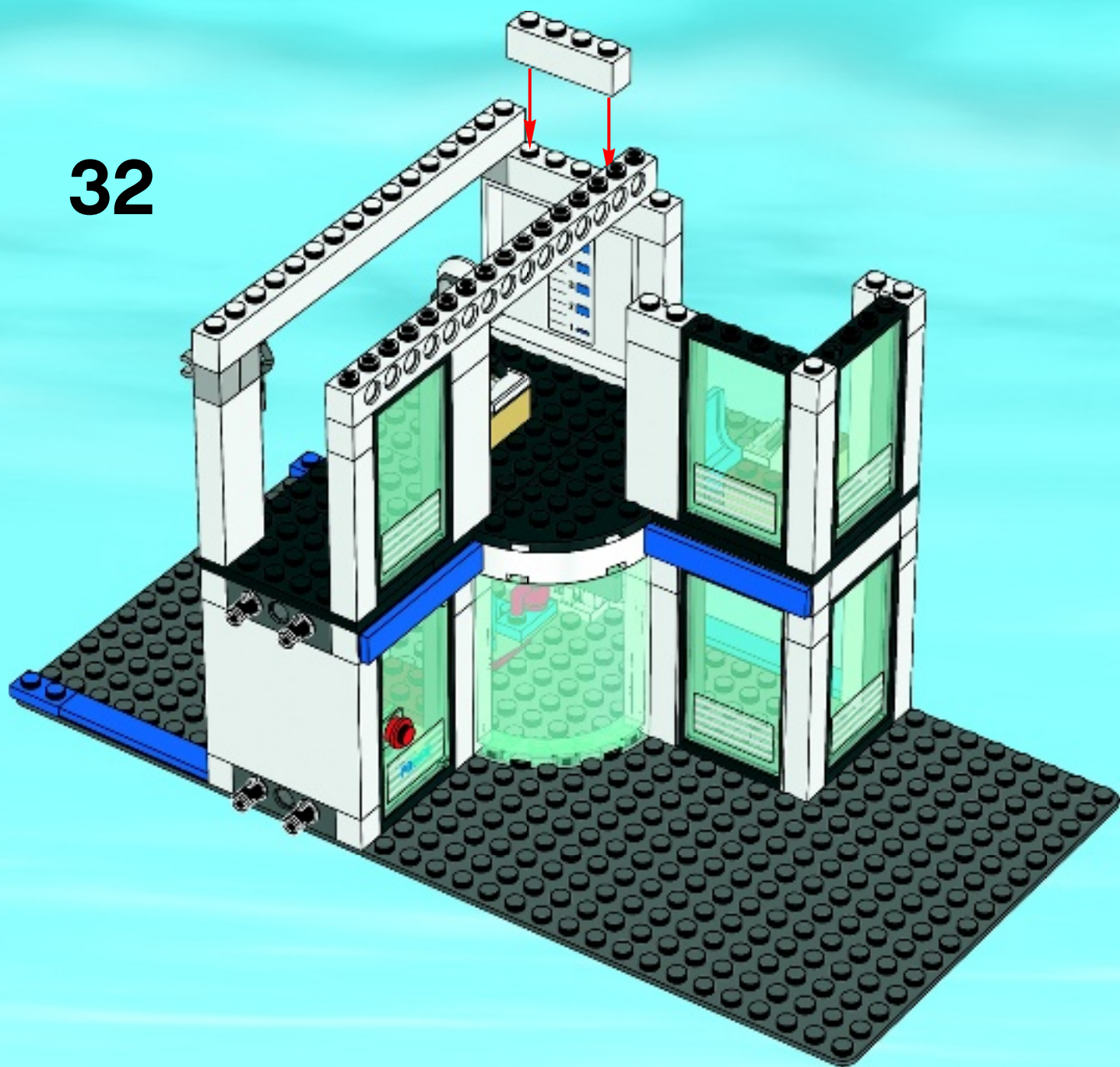



33

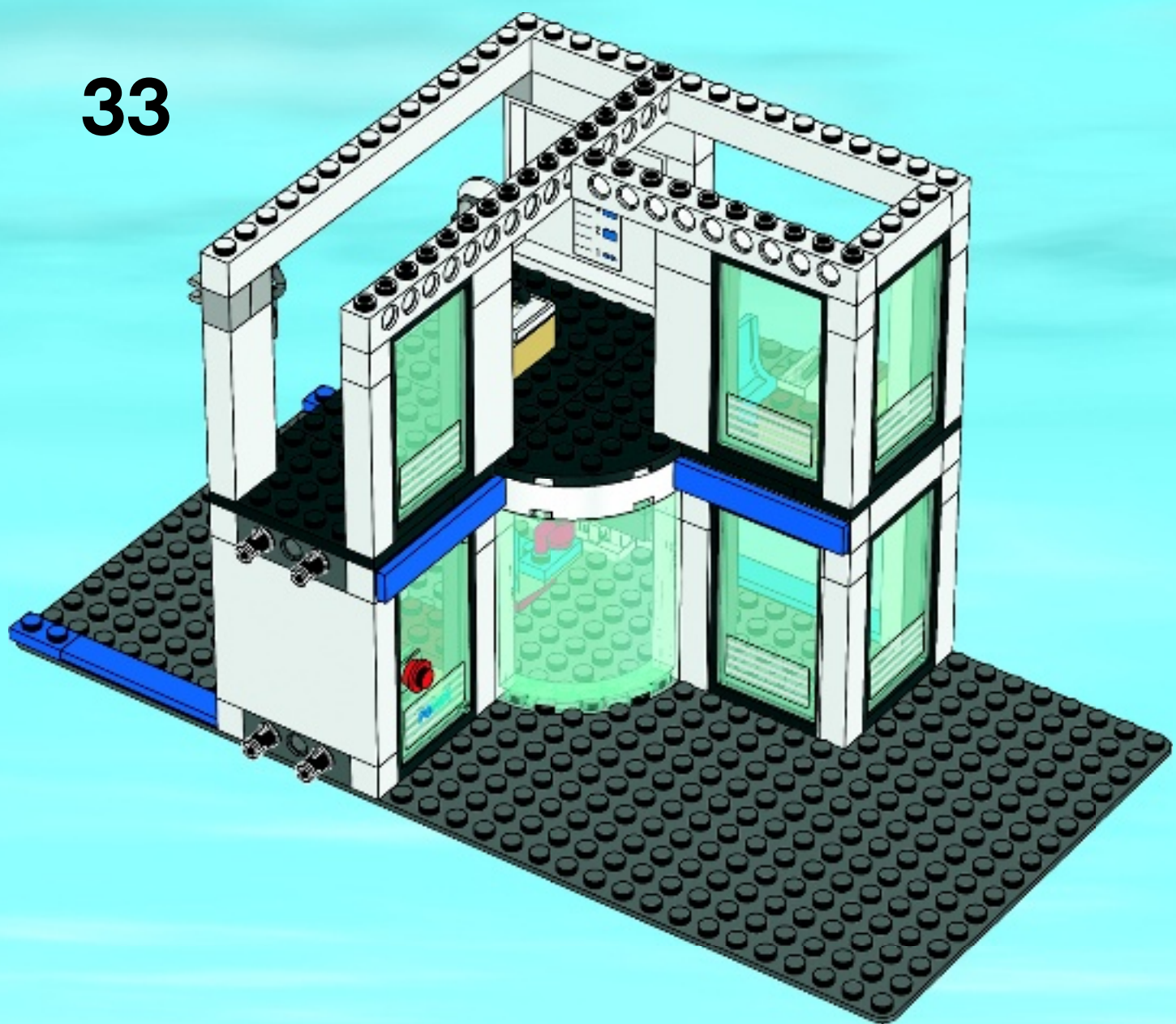



34

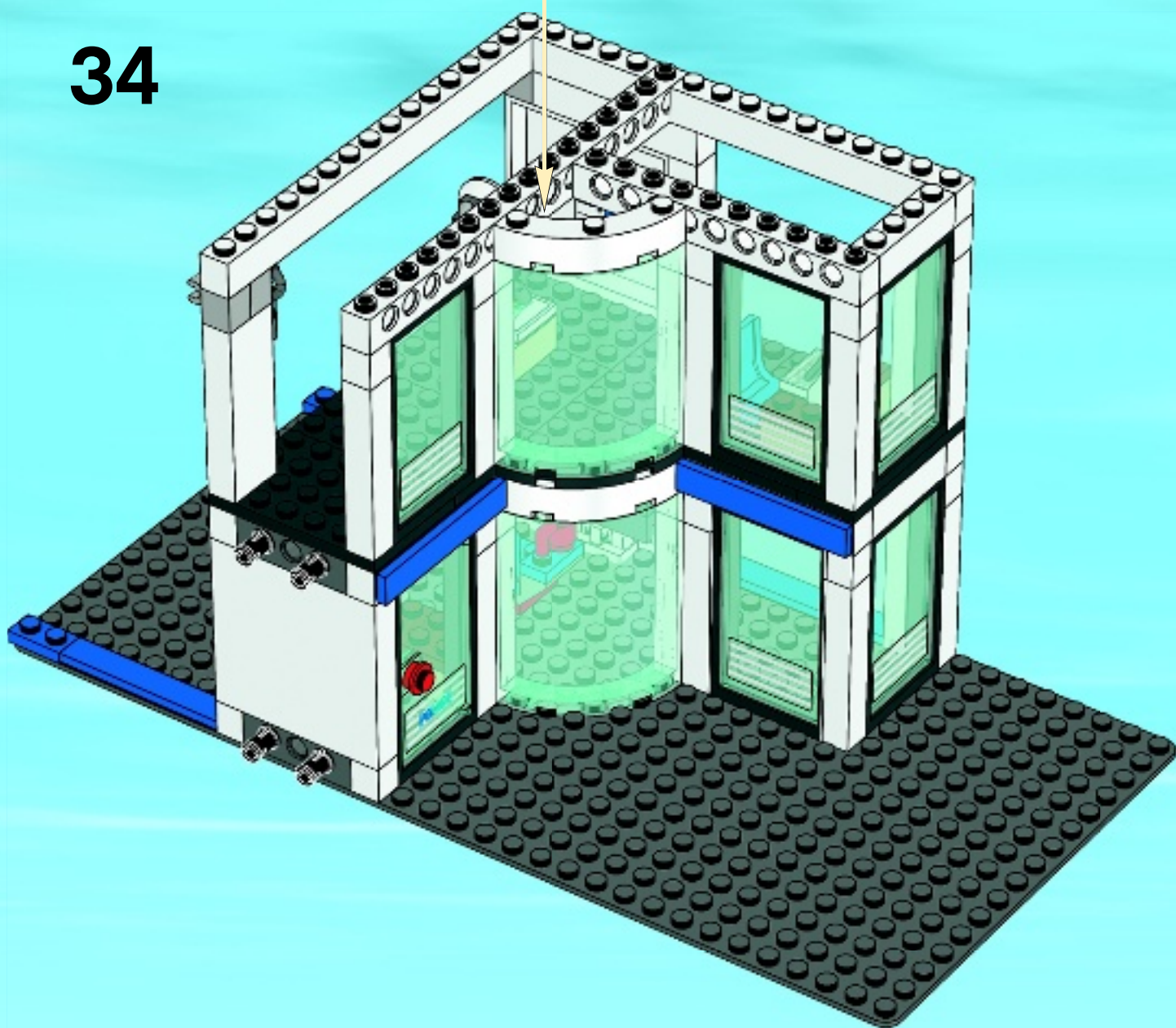
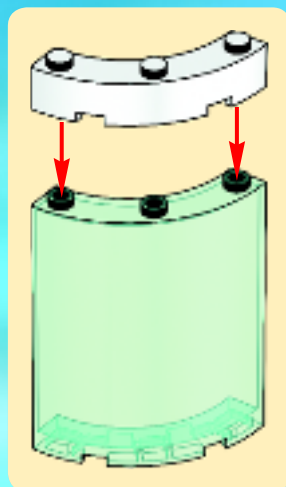

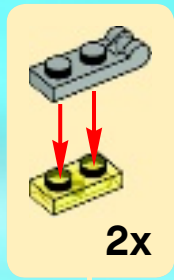

35

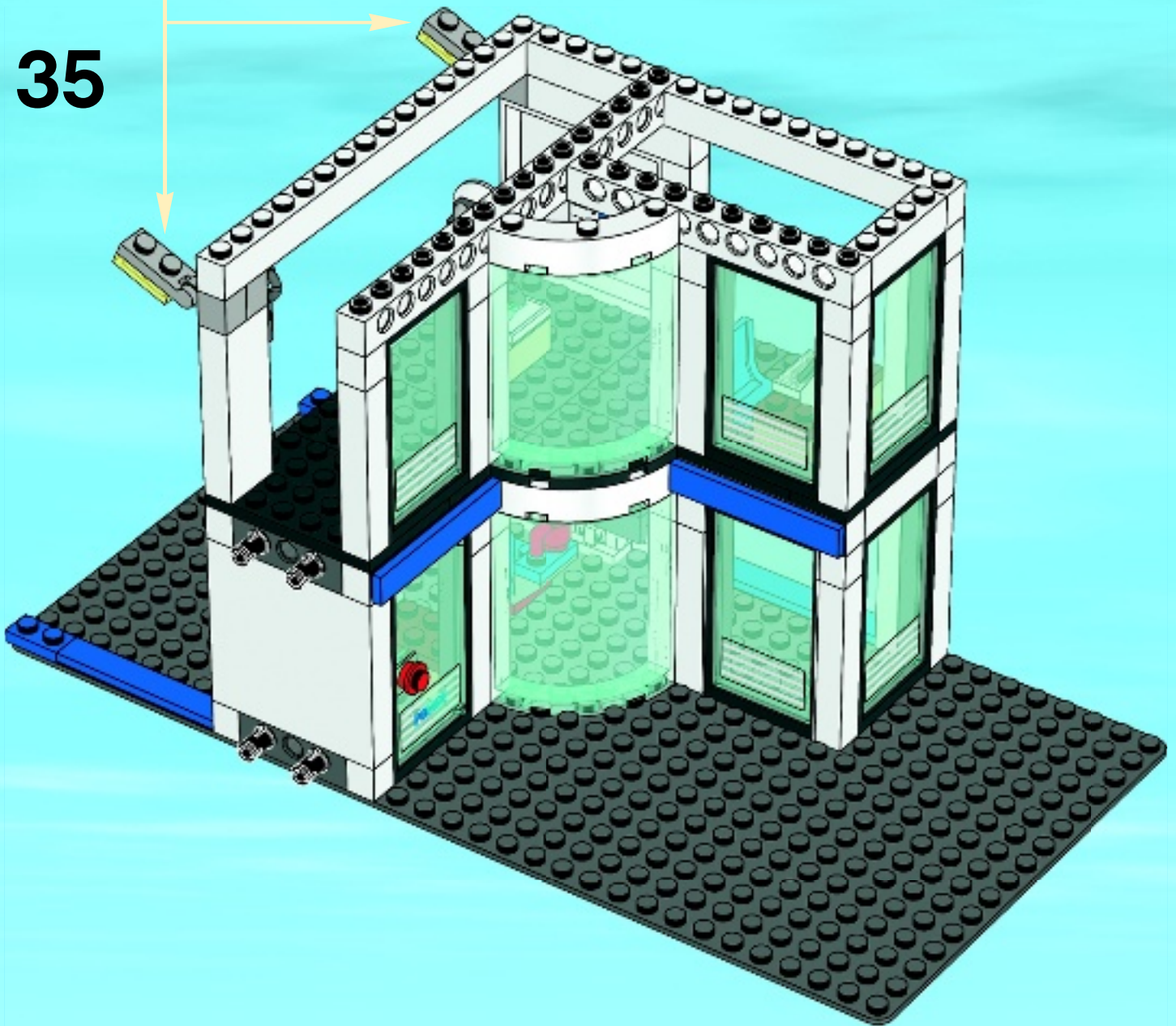



36

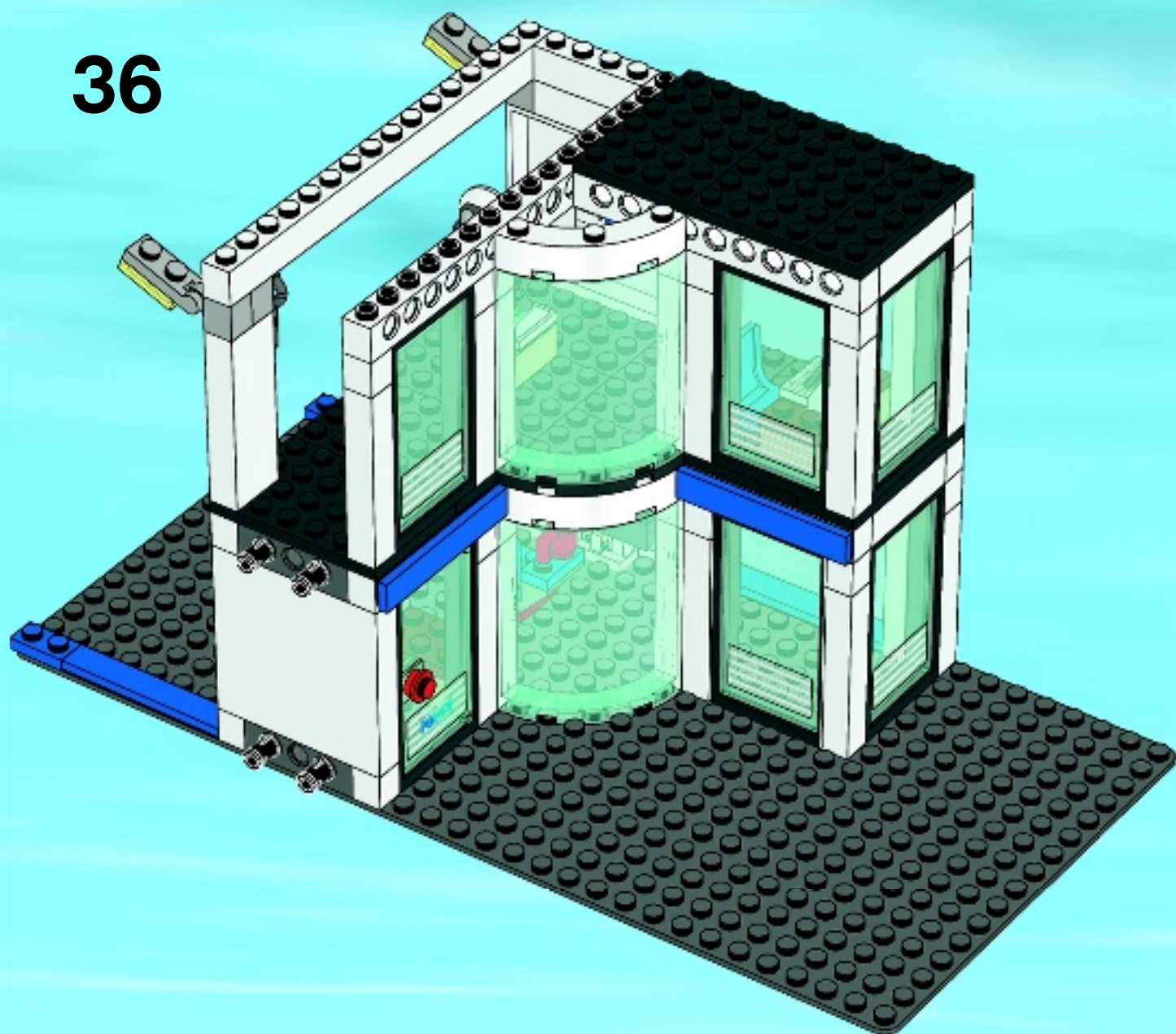



37

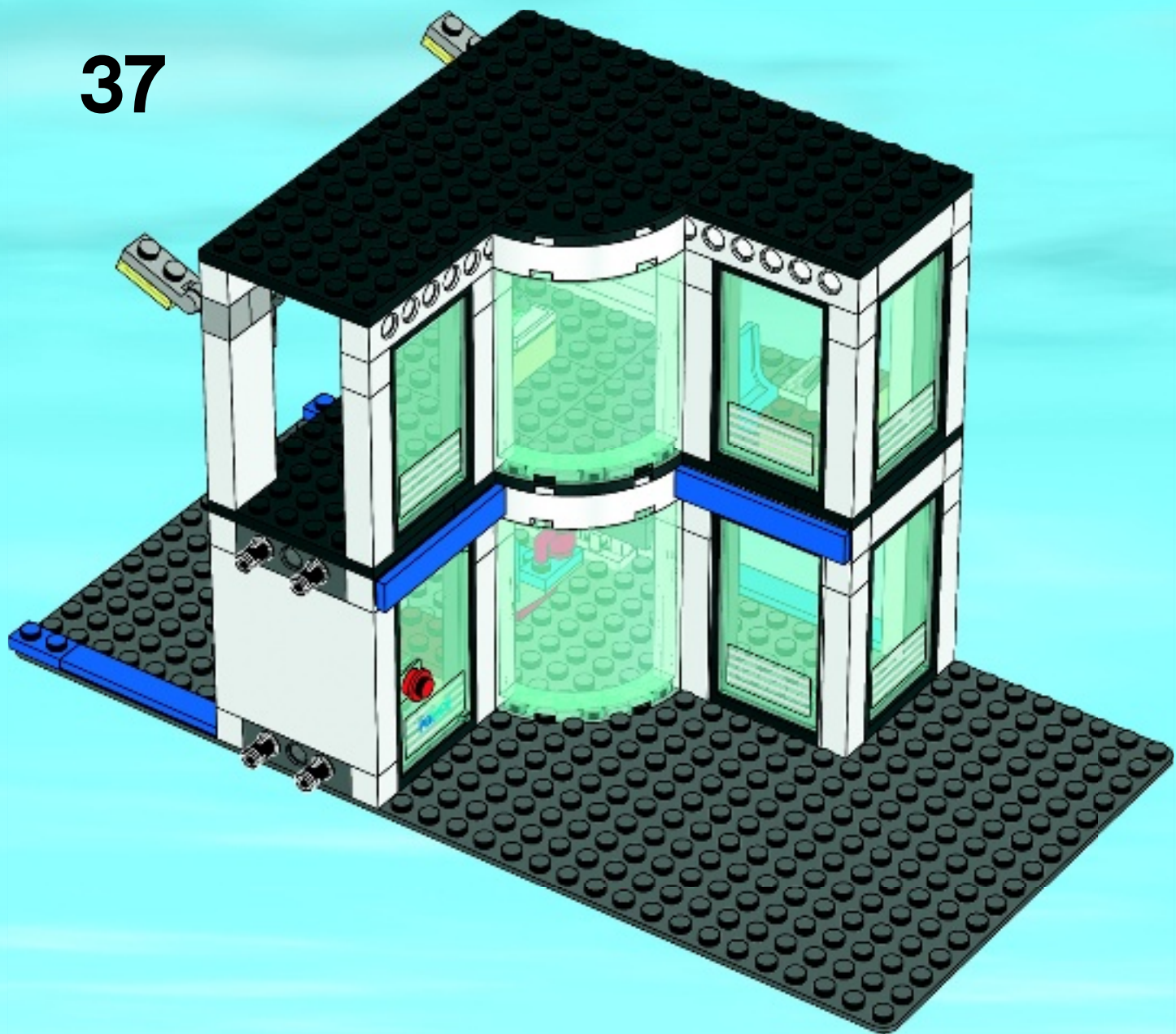

38

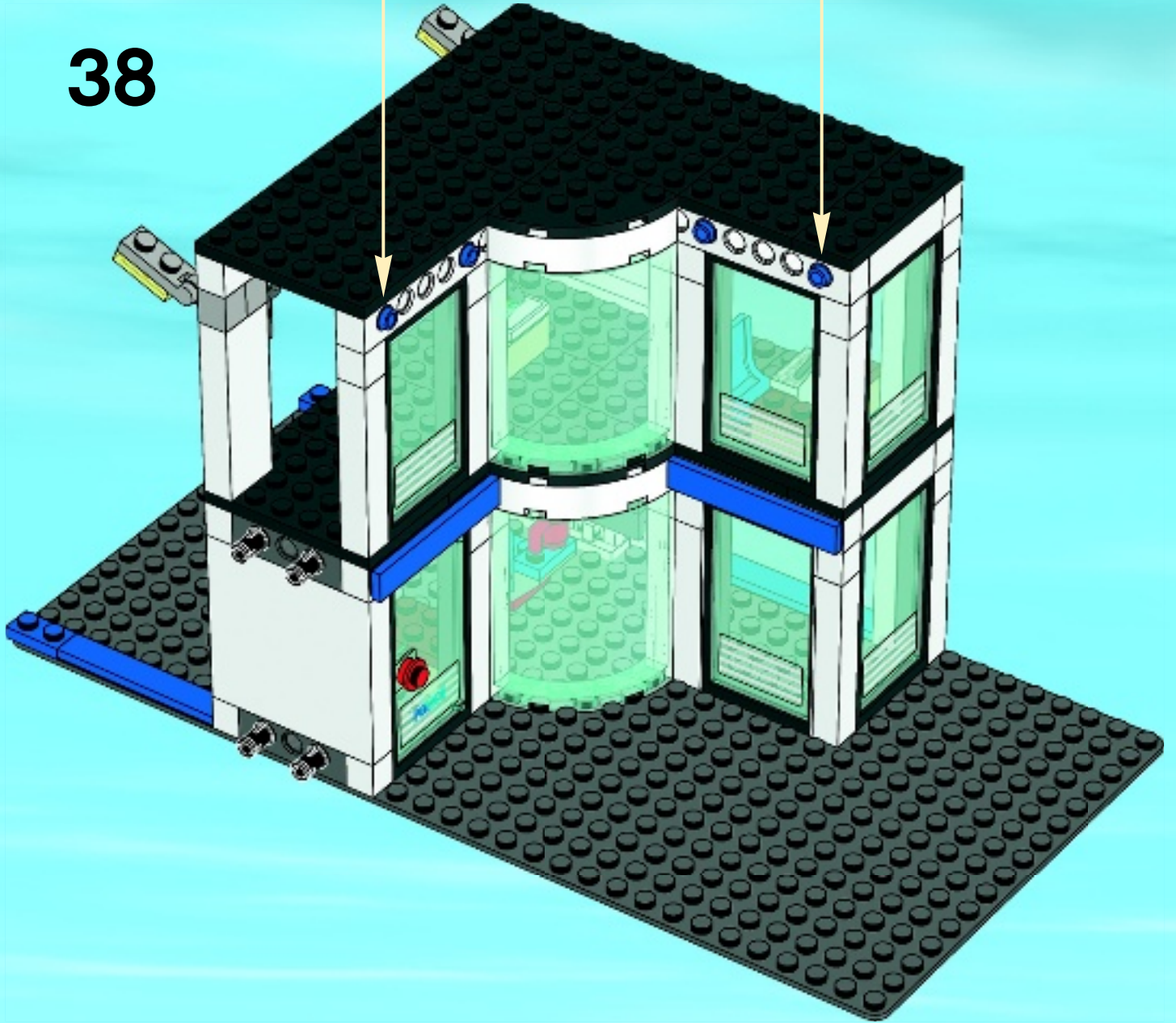



39

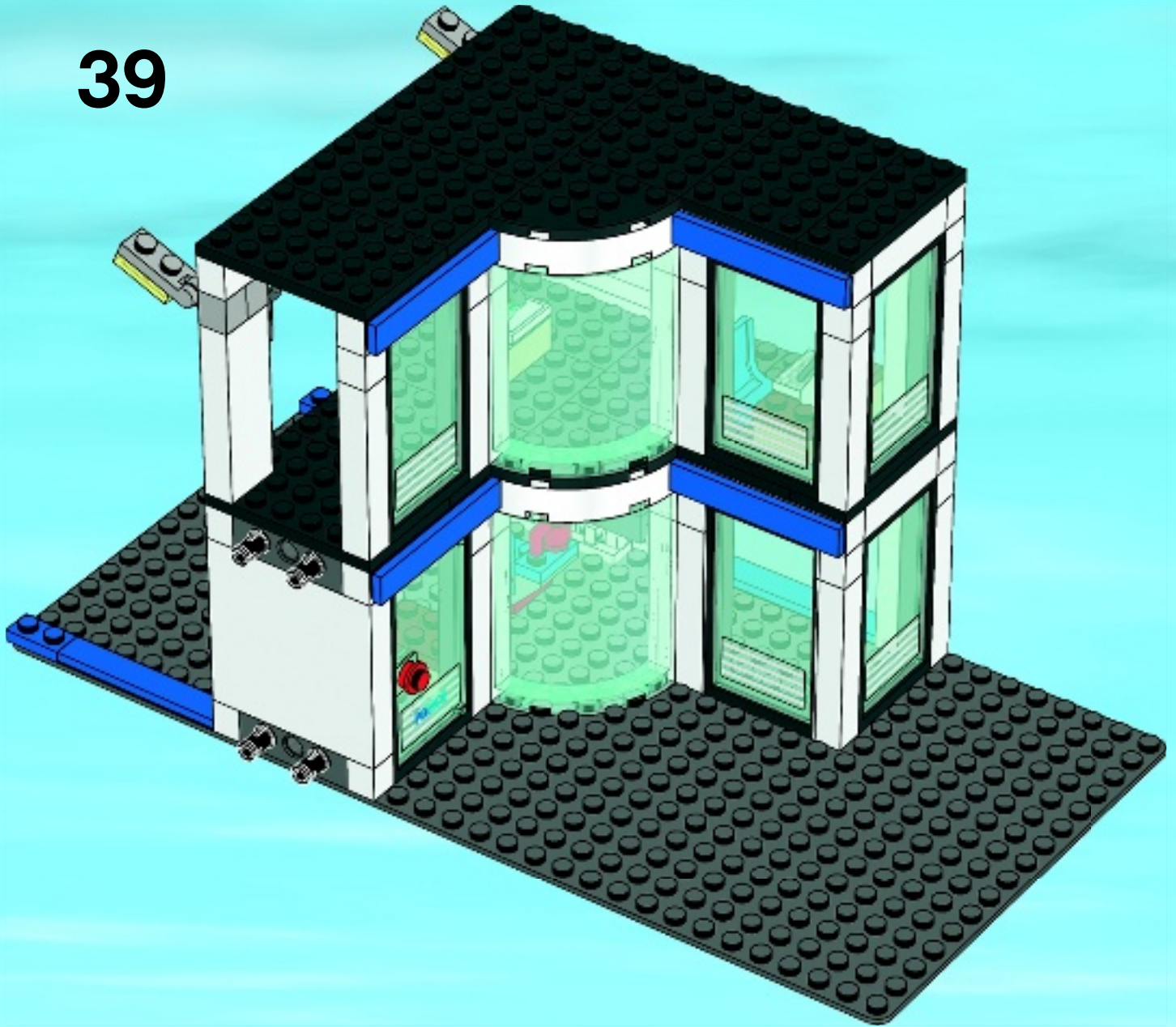





9

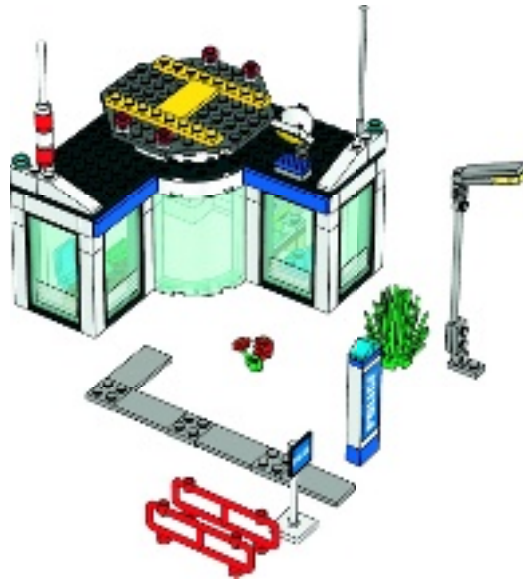

40

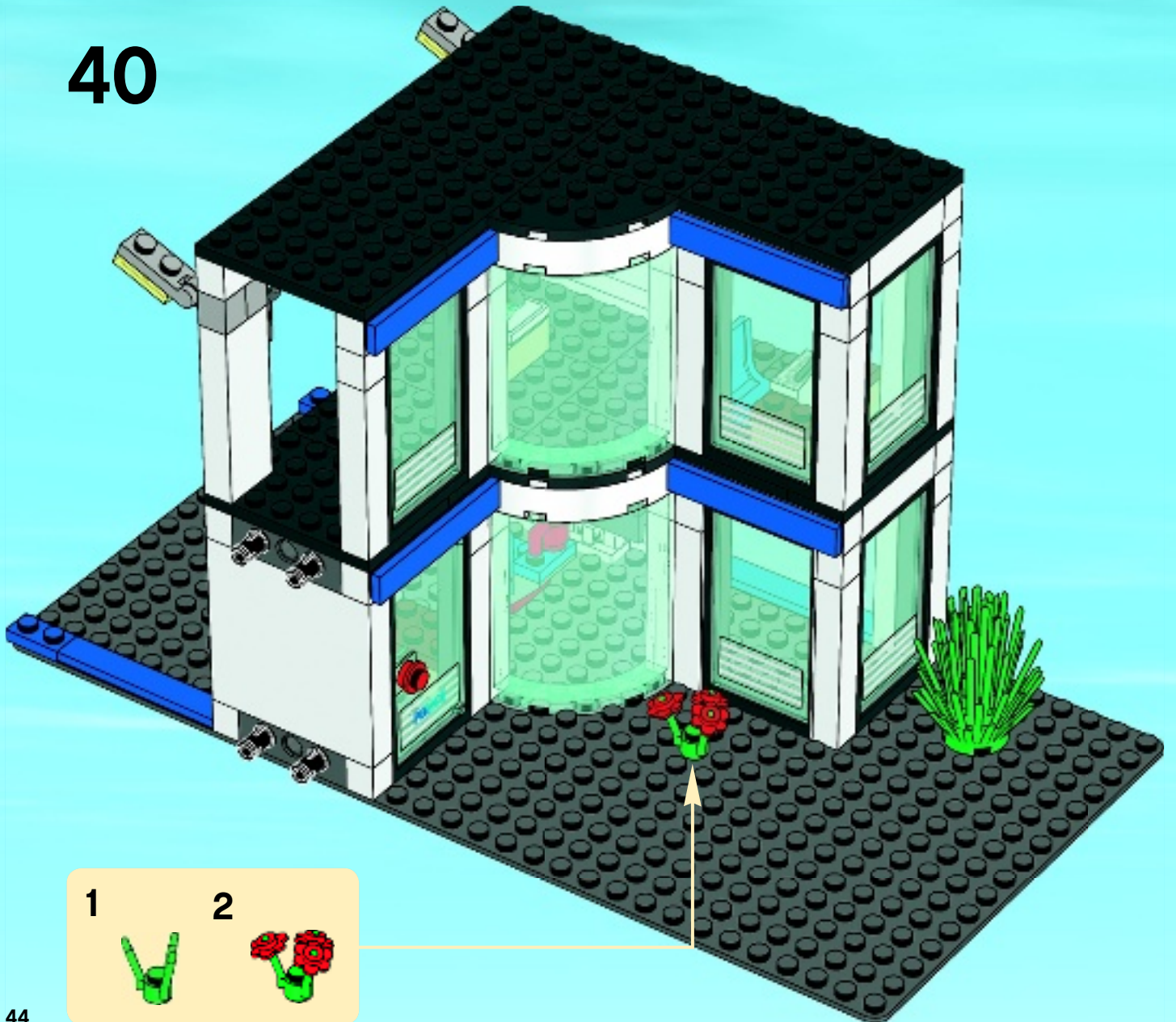

1



2



41

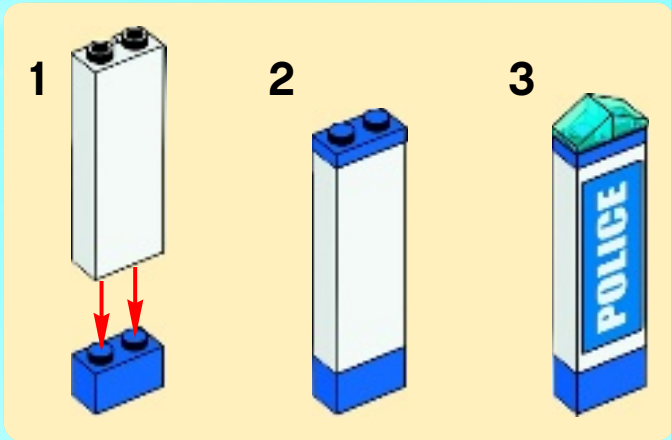
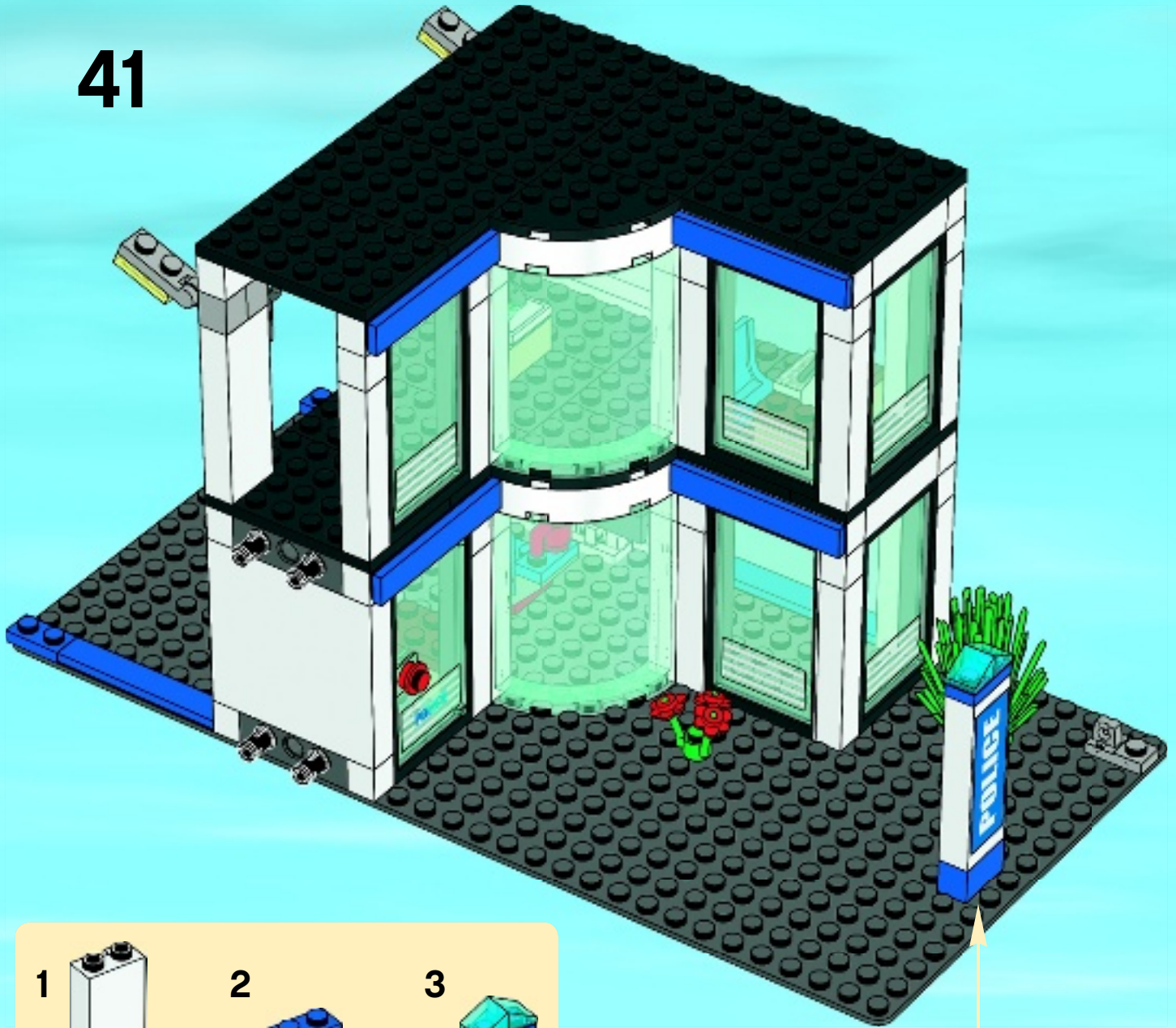



42

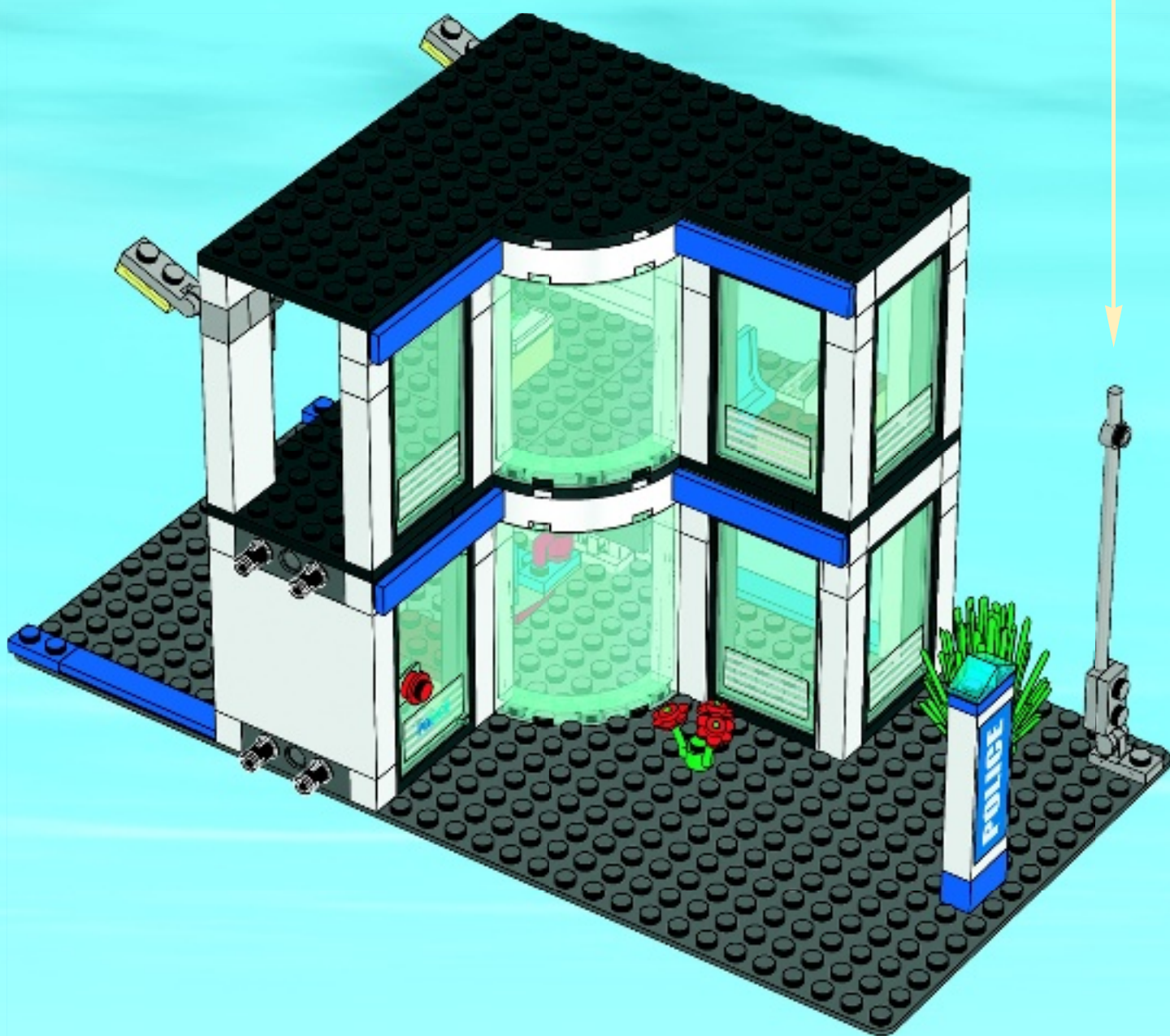
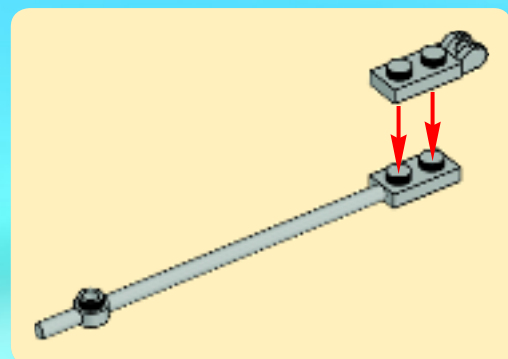



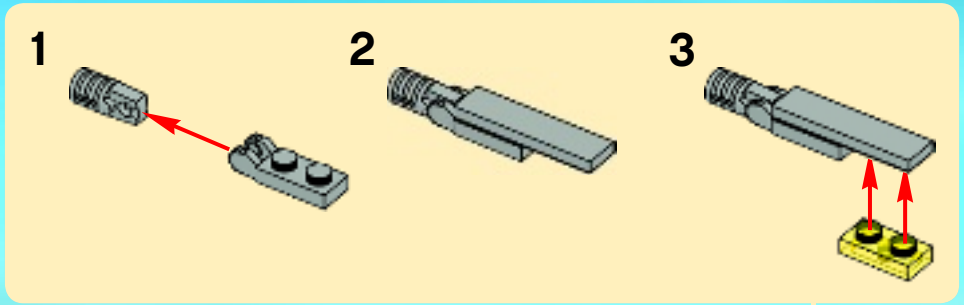

43

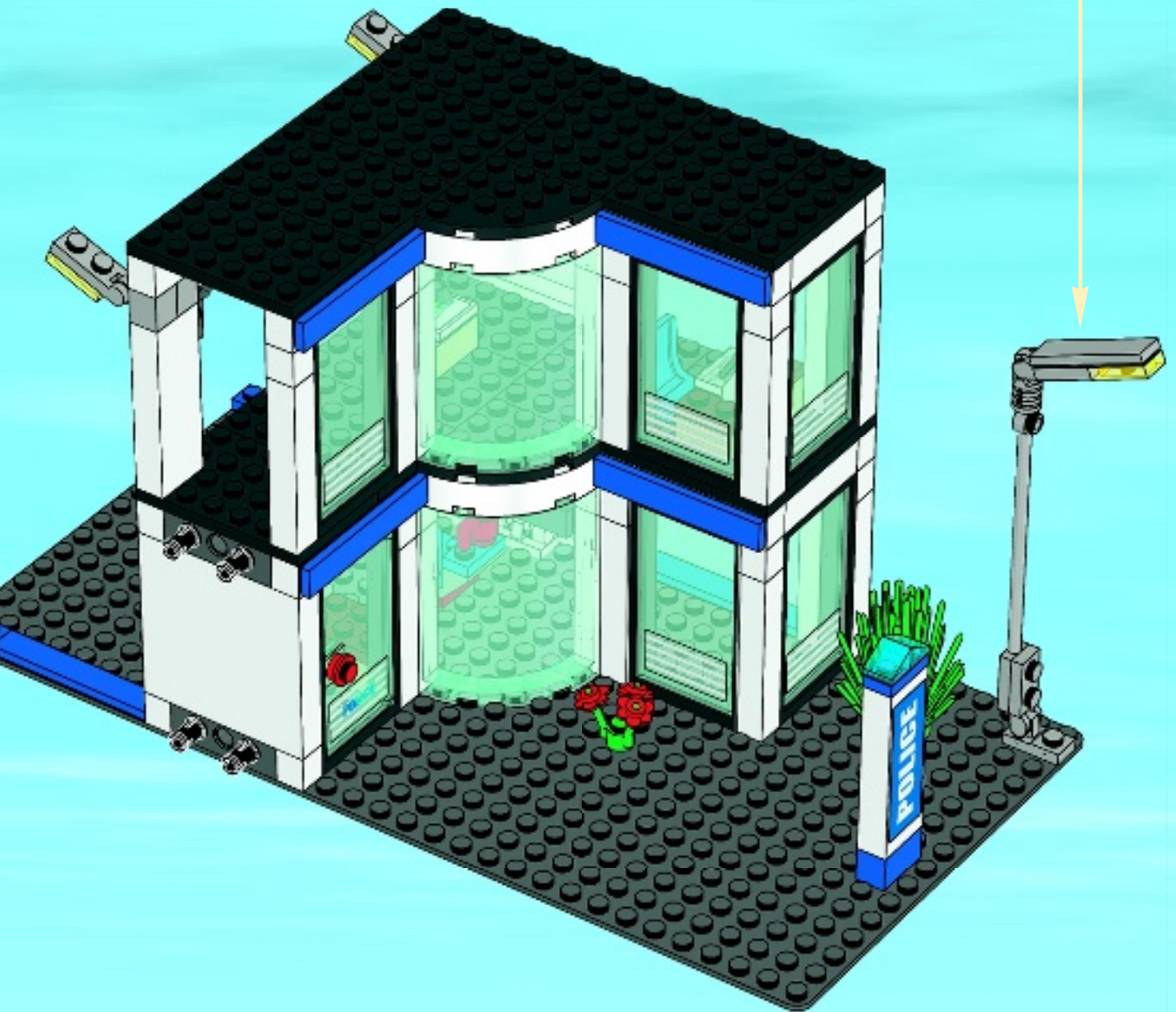

44

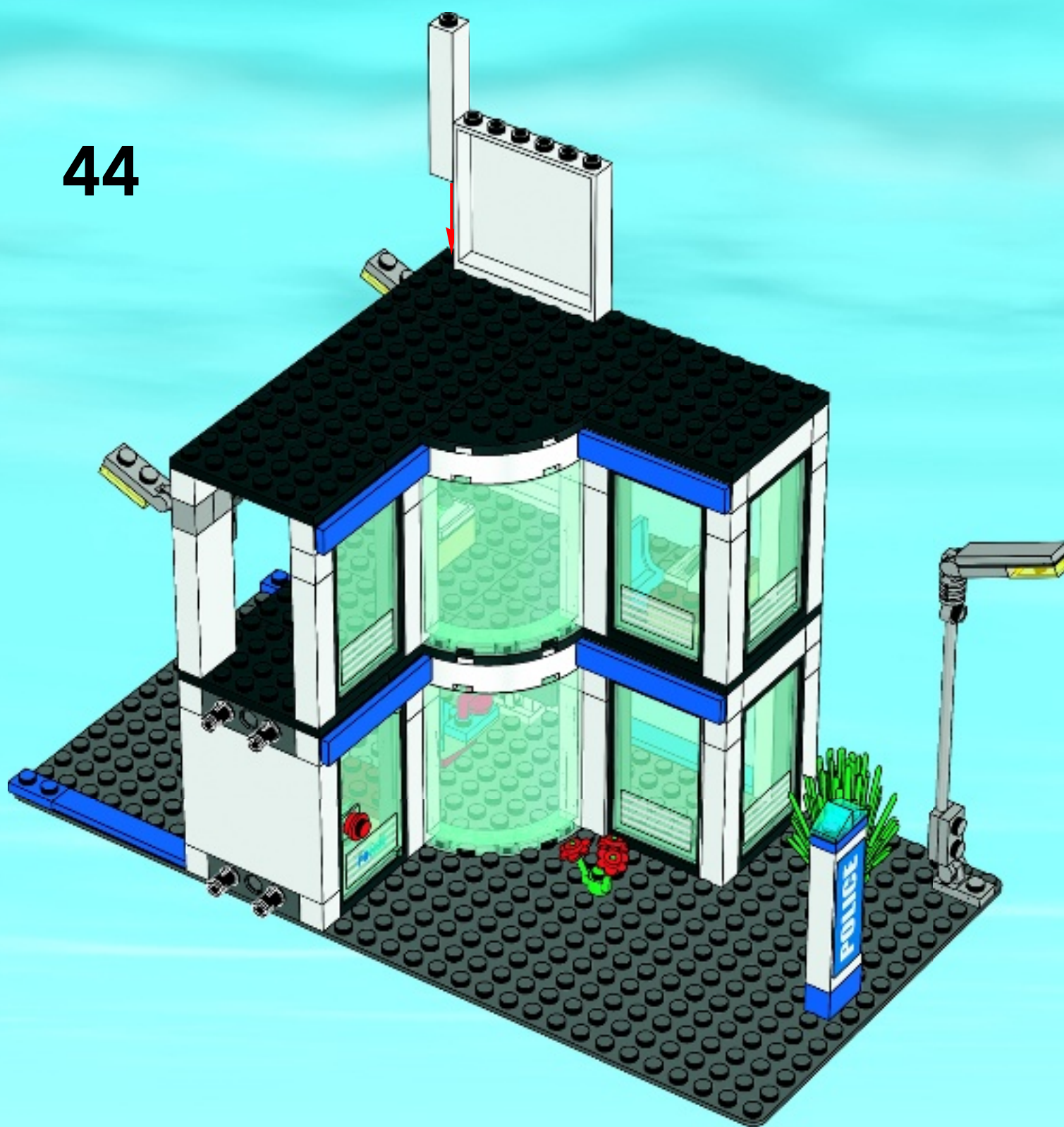



45

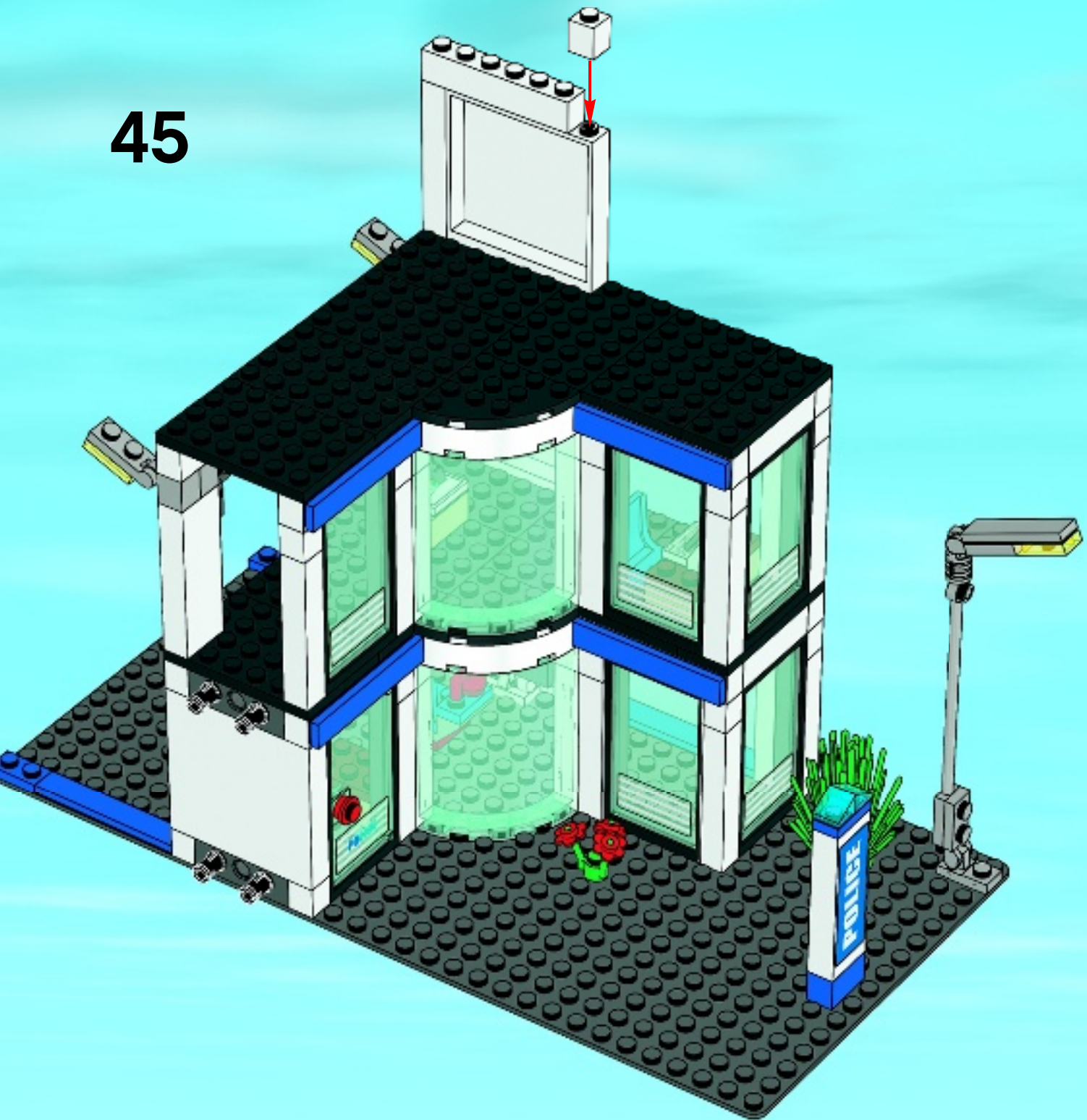





1

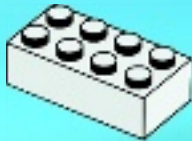

2

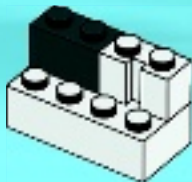

3

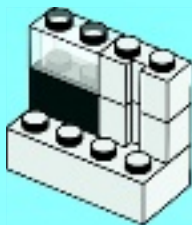

4

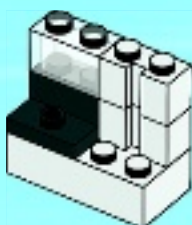

5



6



7



8



46





47

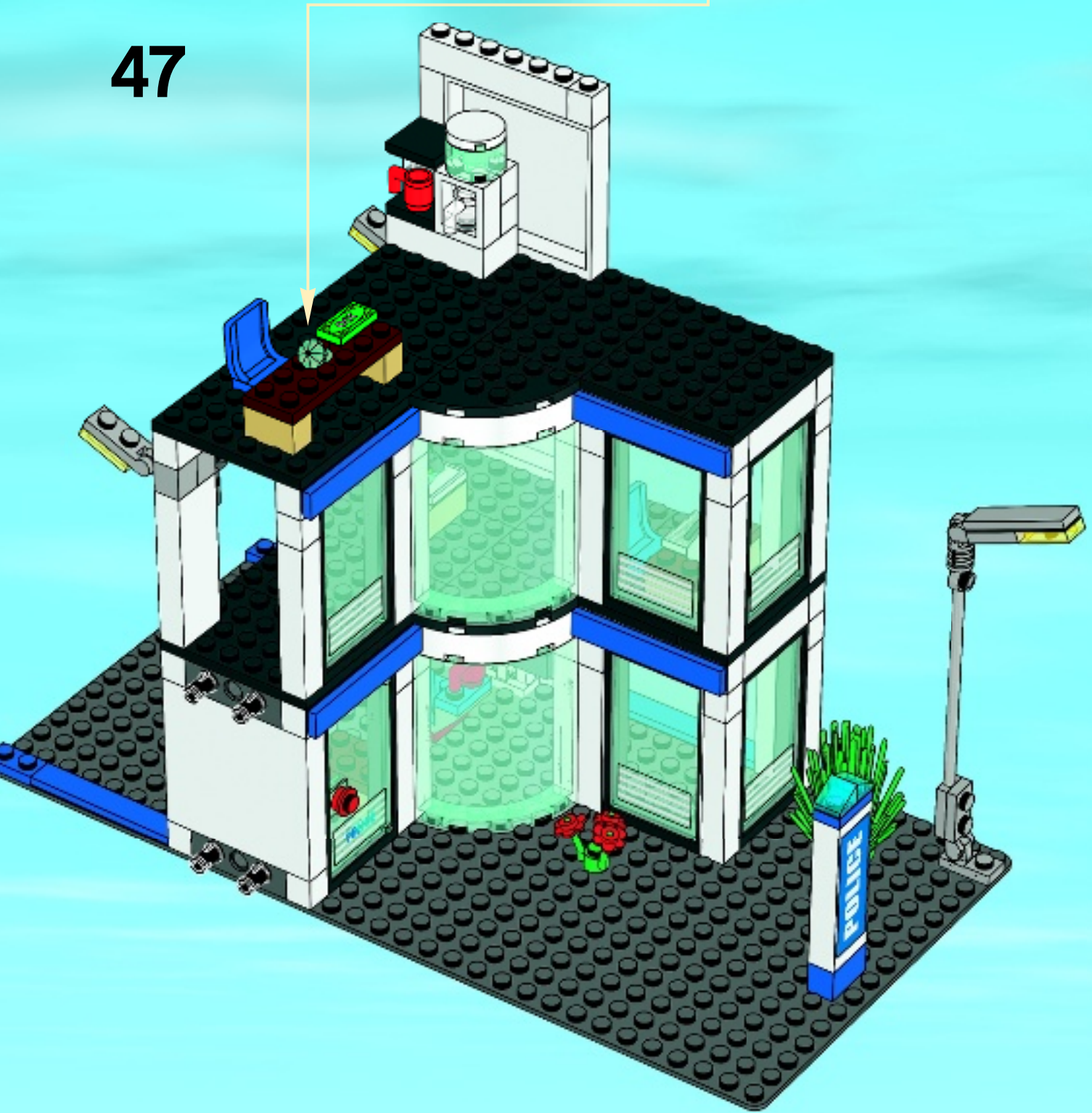
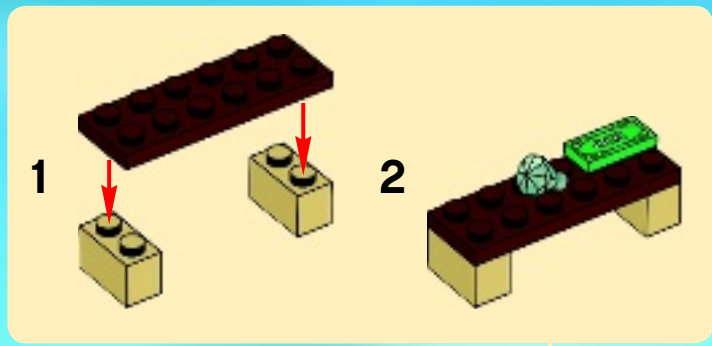



1

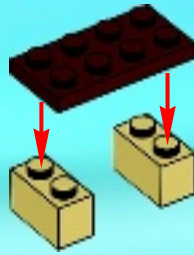

2

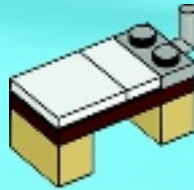

3



4

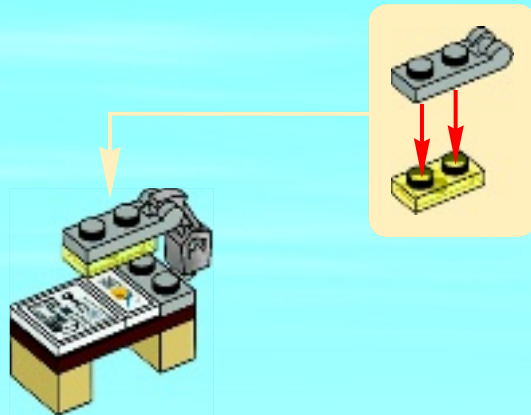

48

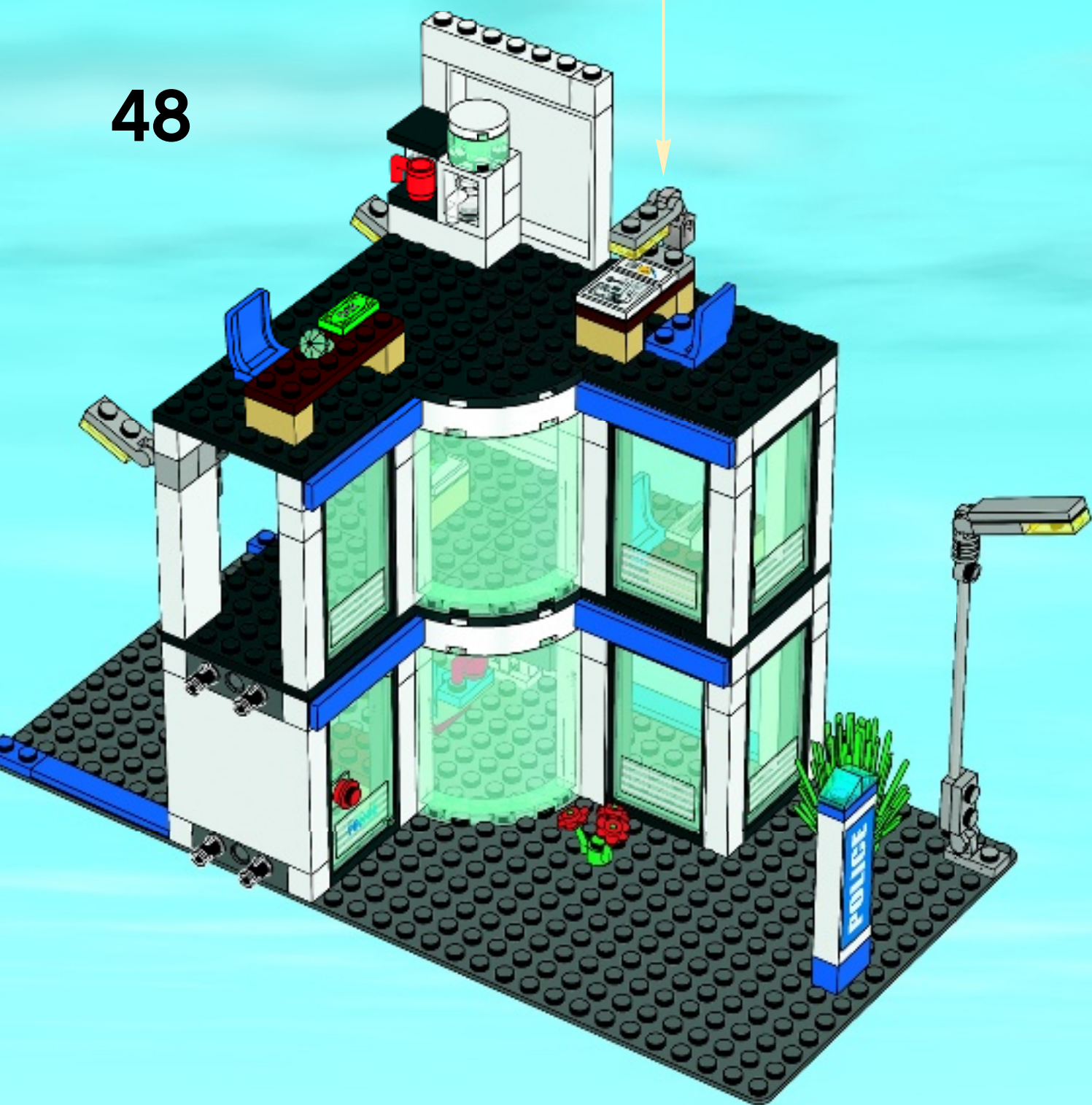



49

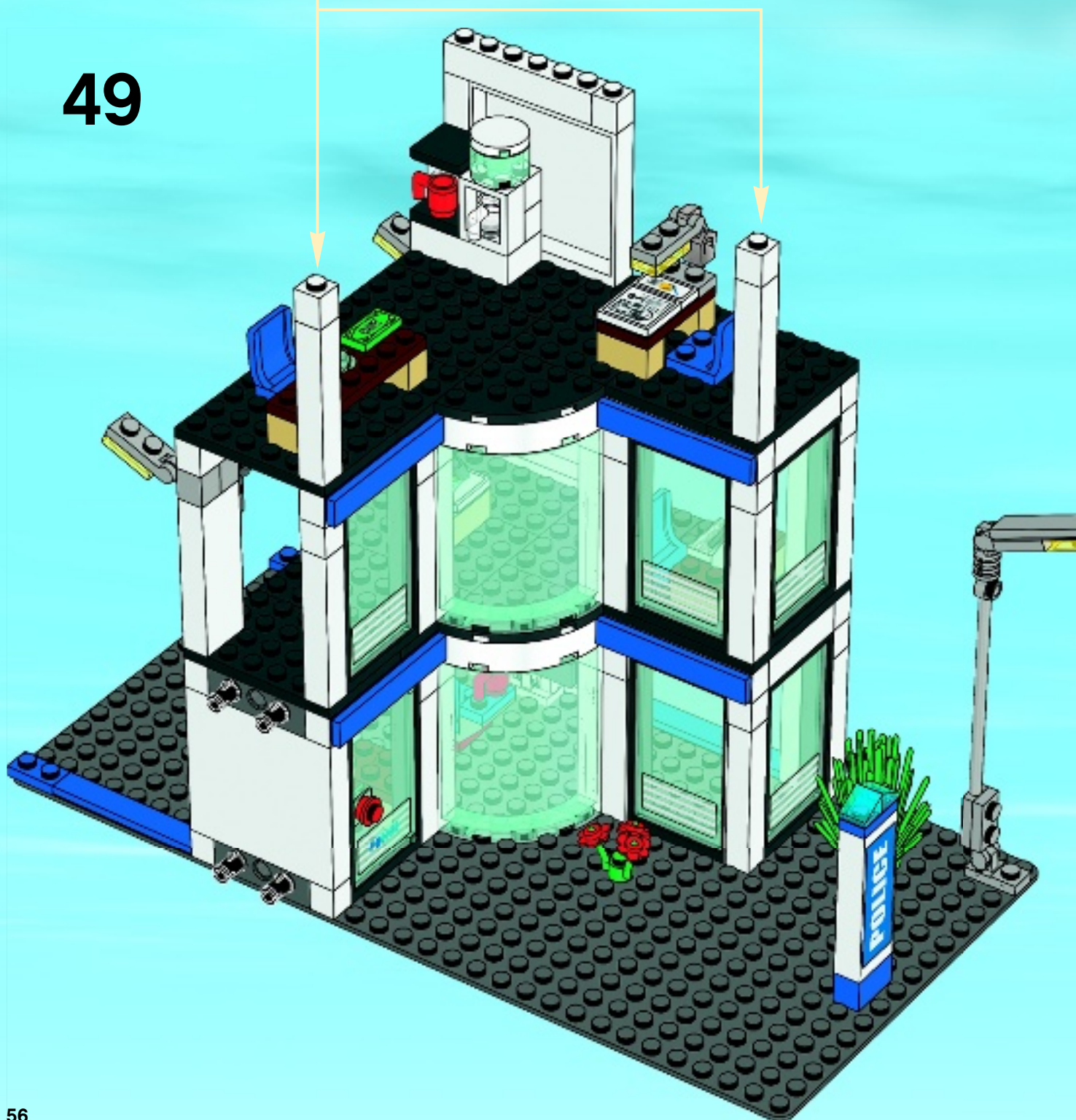
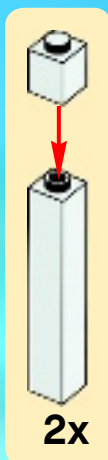

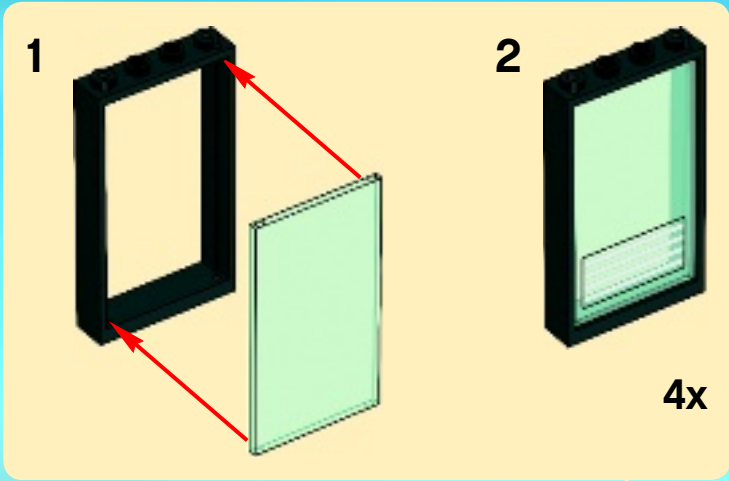

50

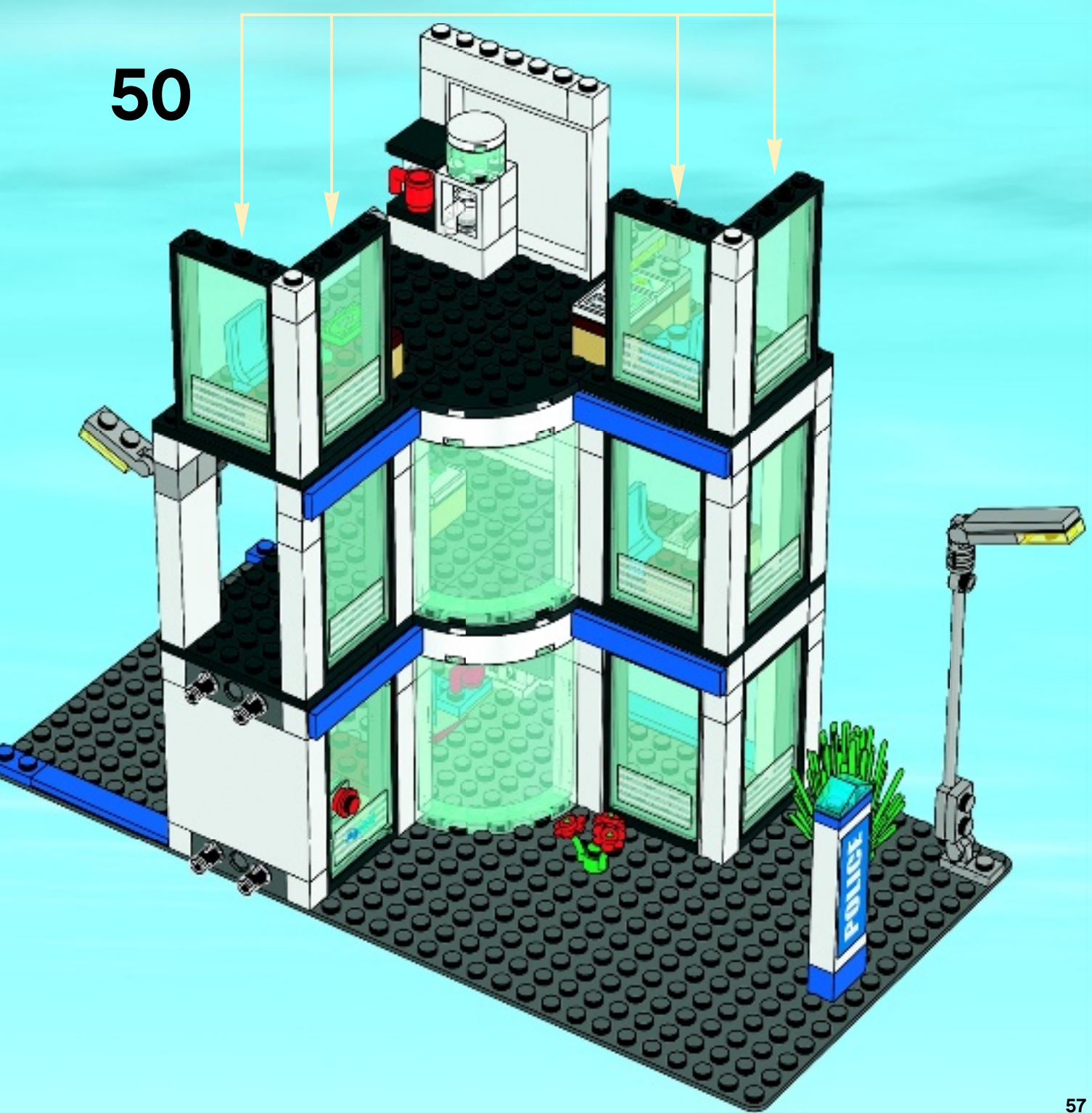



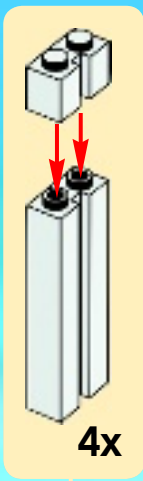

51

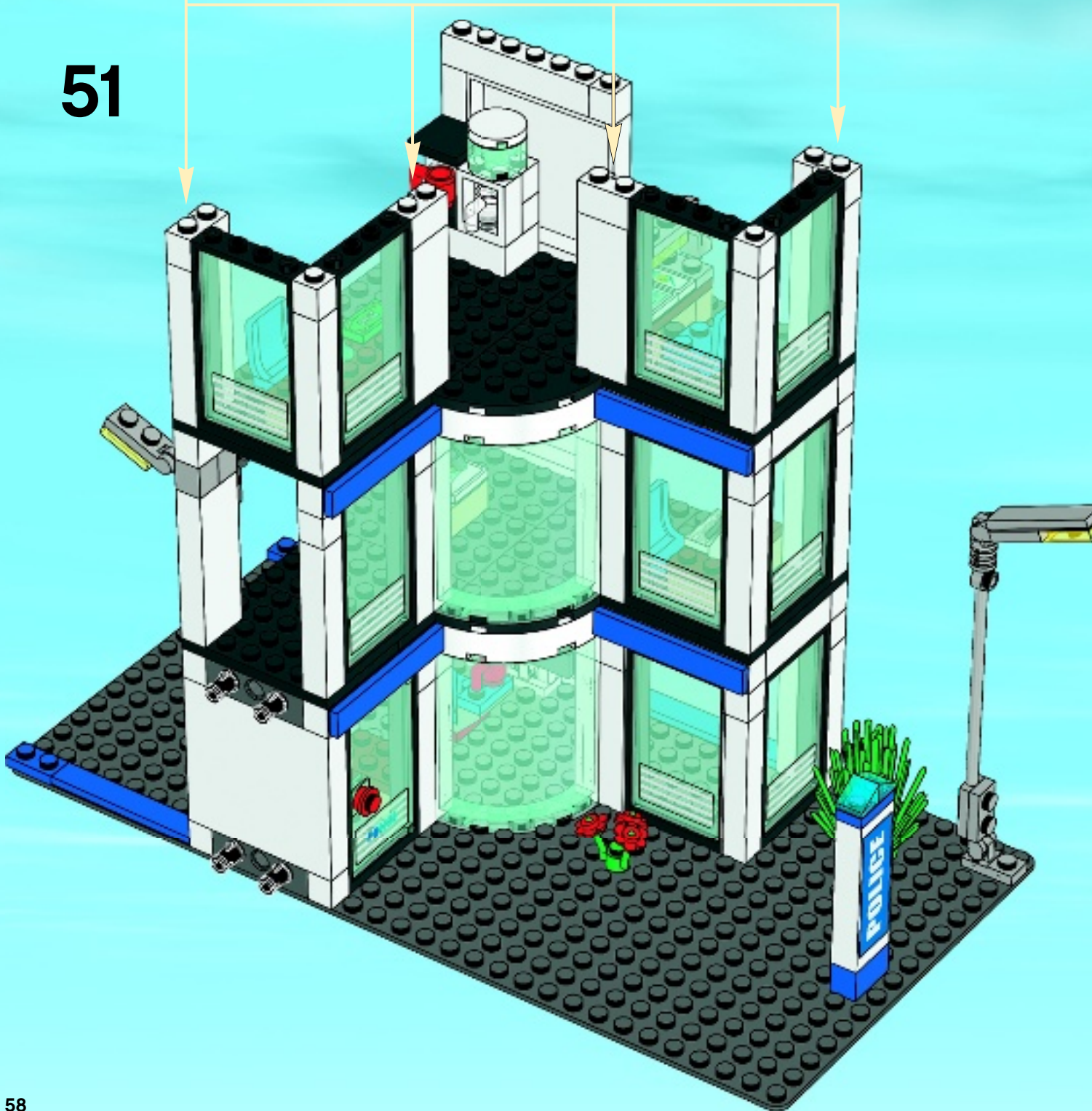



52

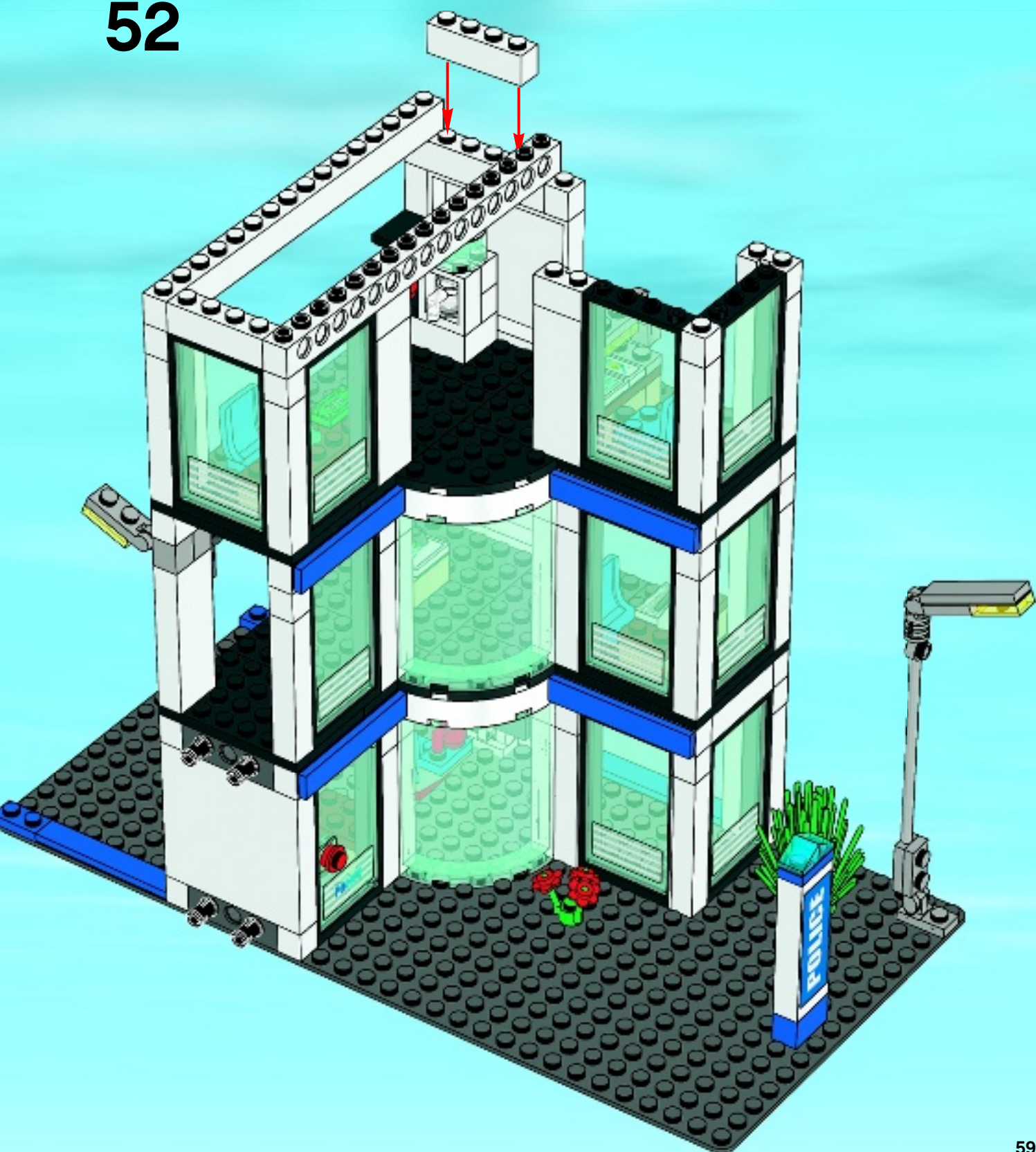

53

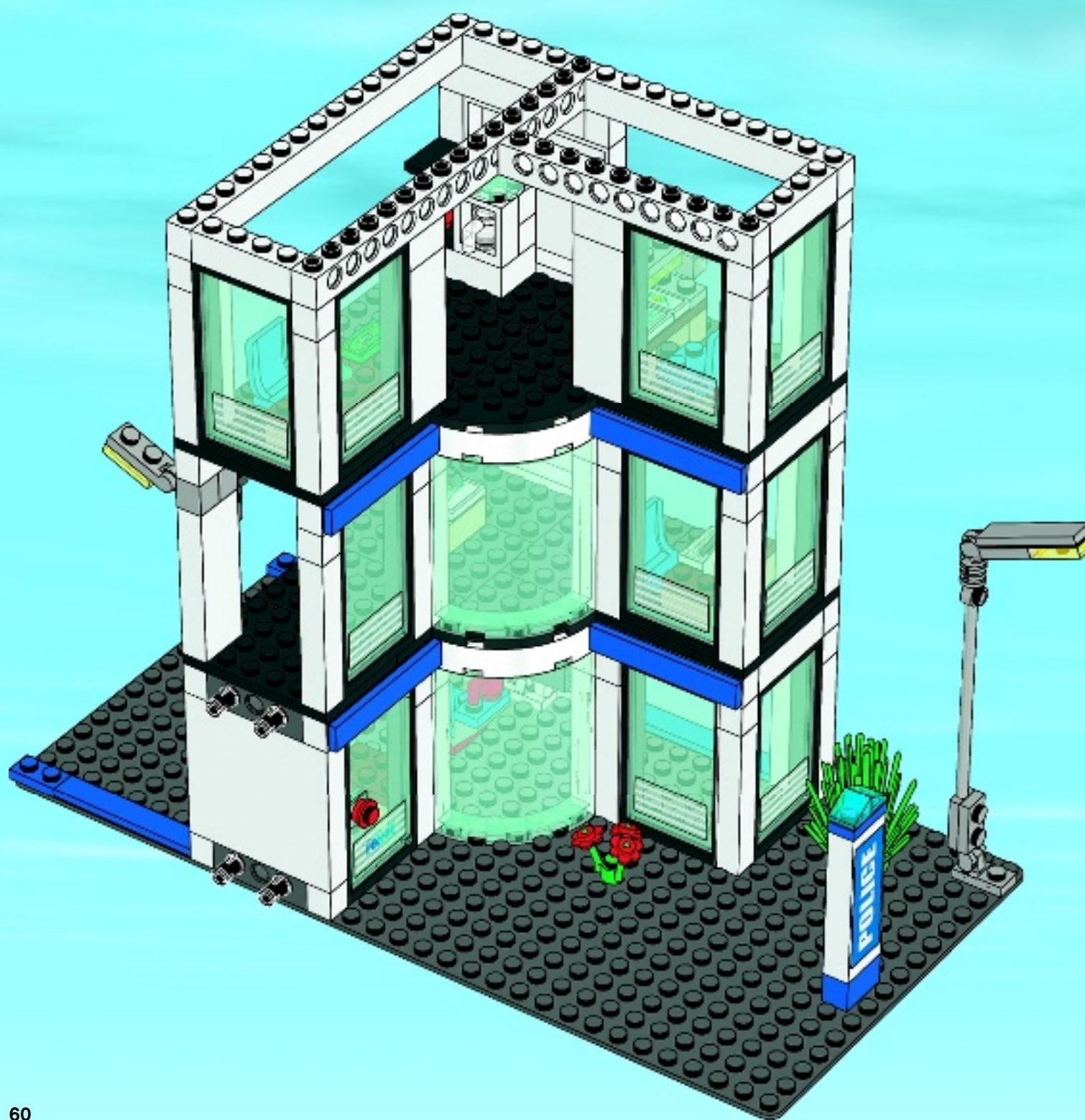



54

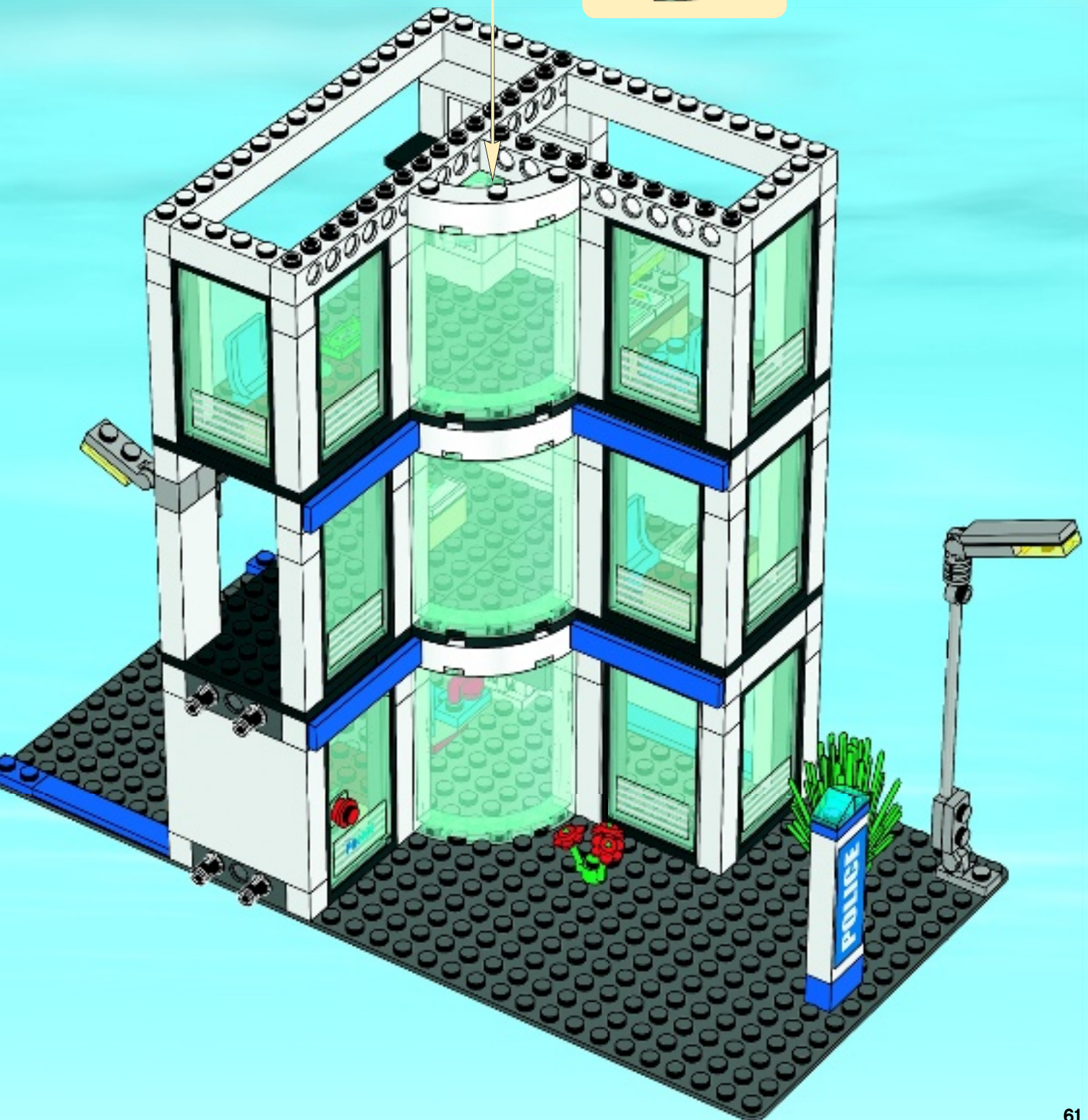
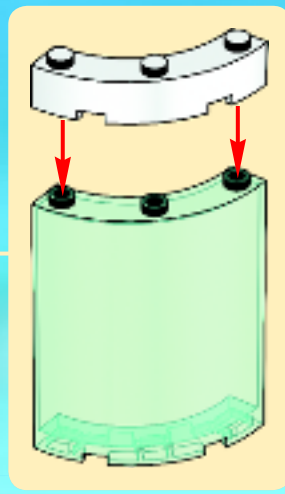



55

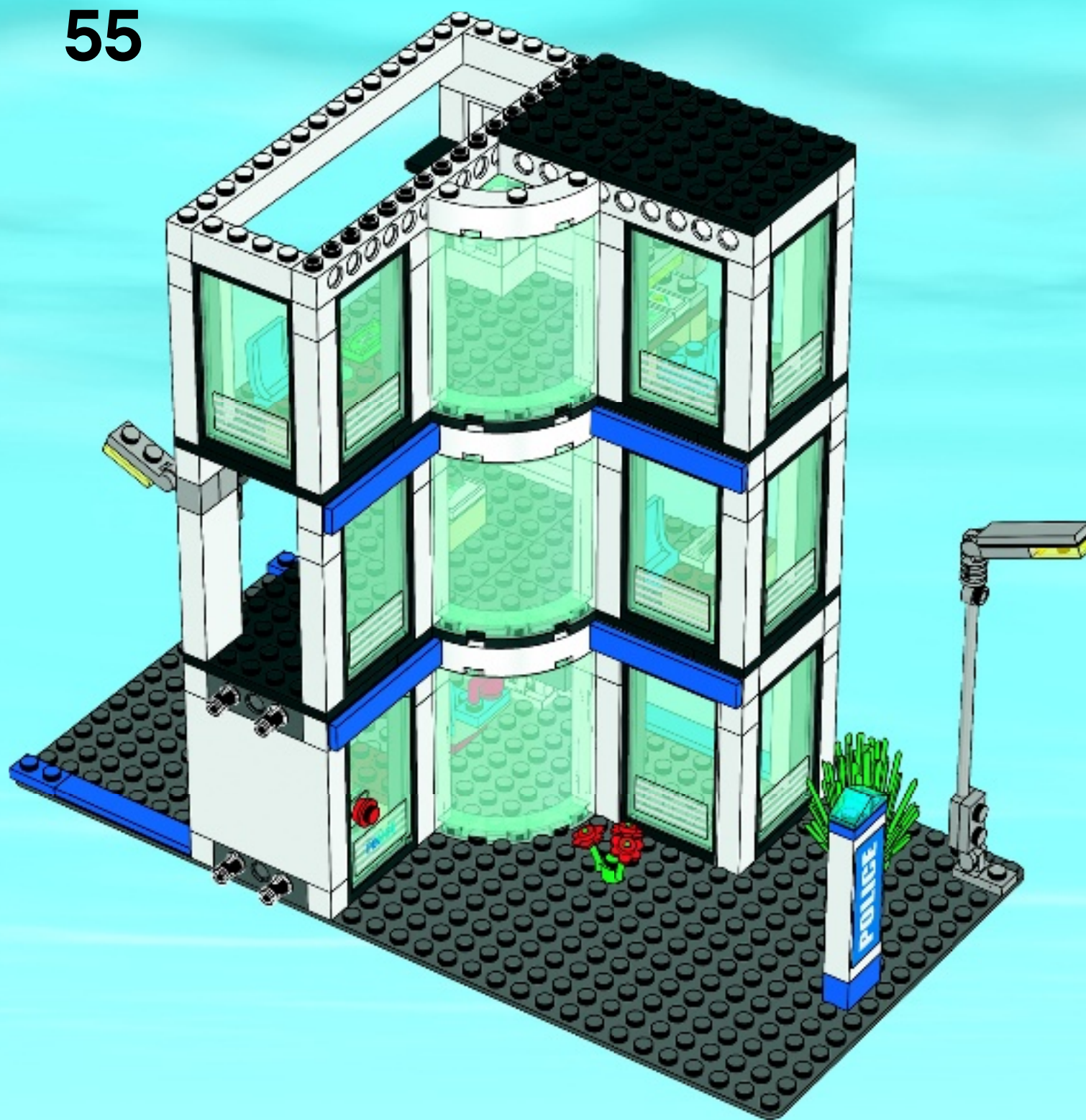

56

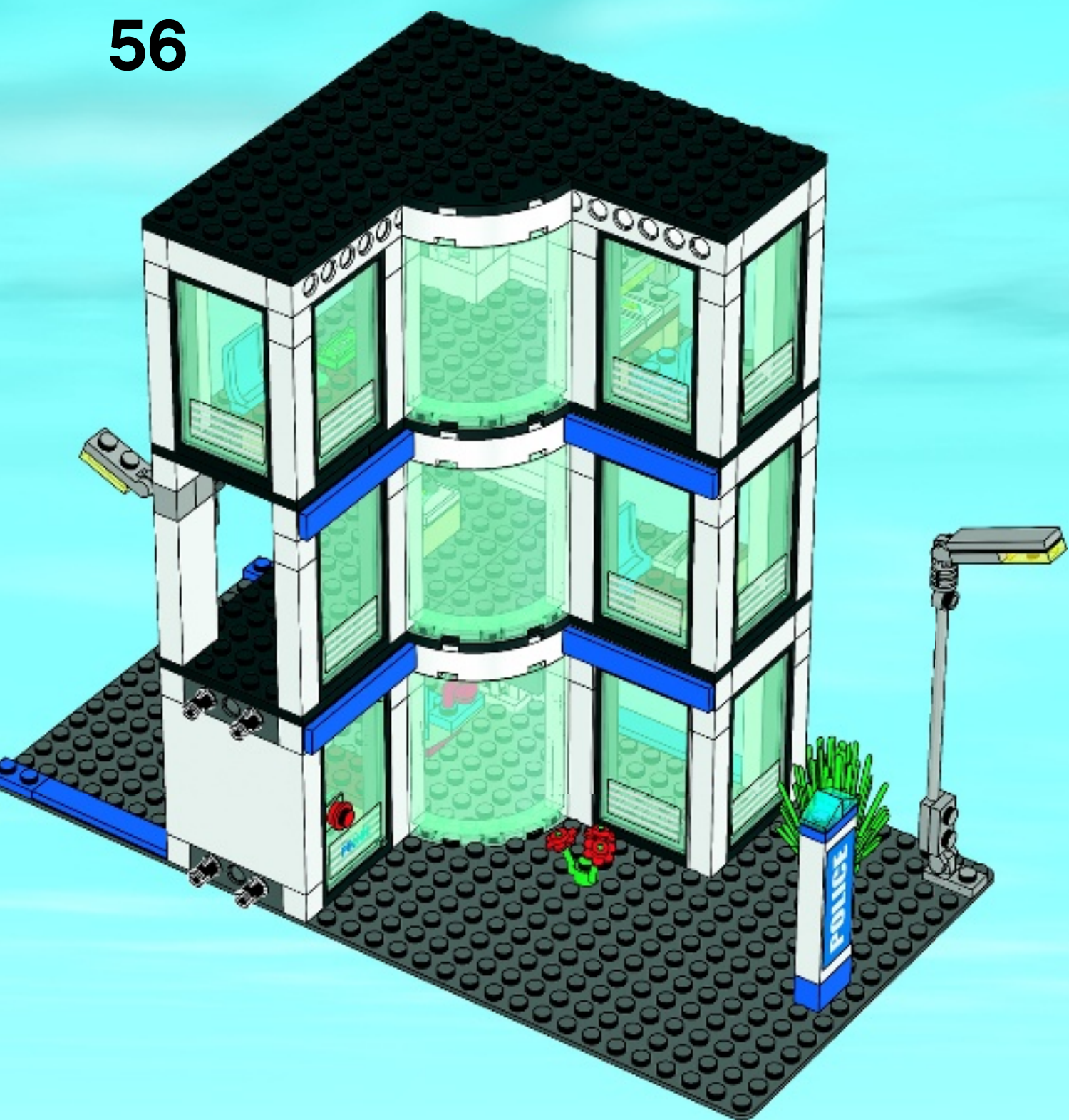





57

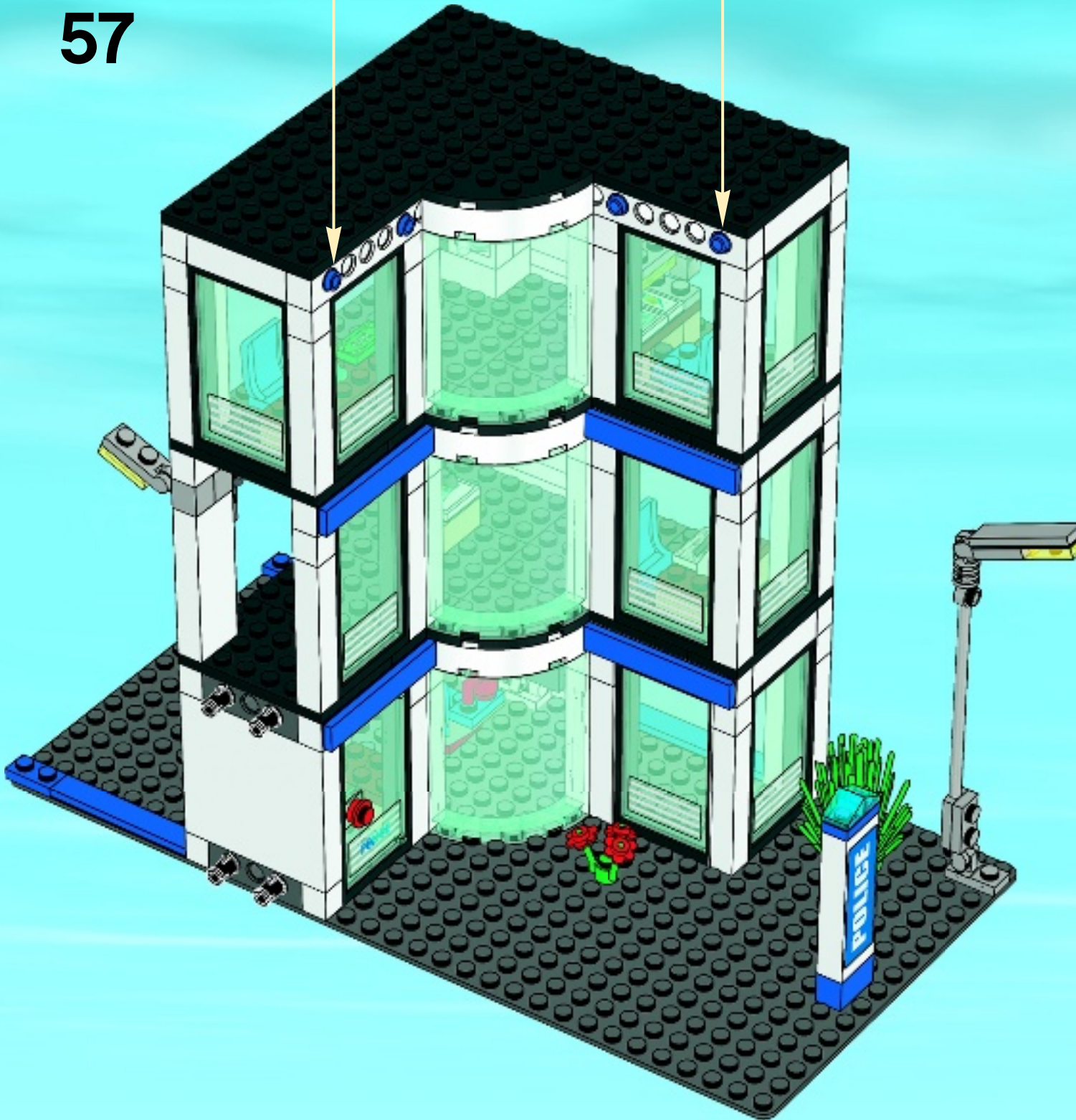

58

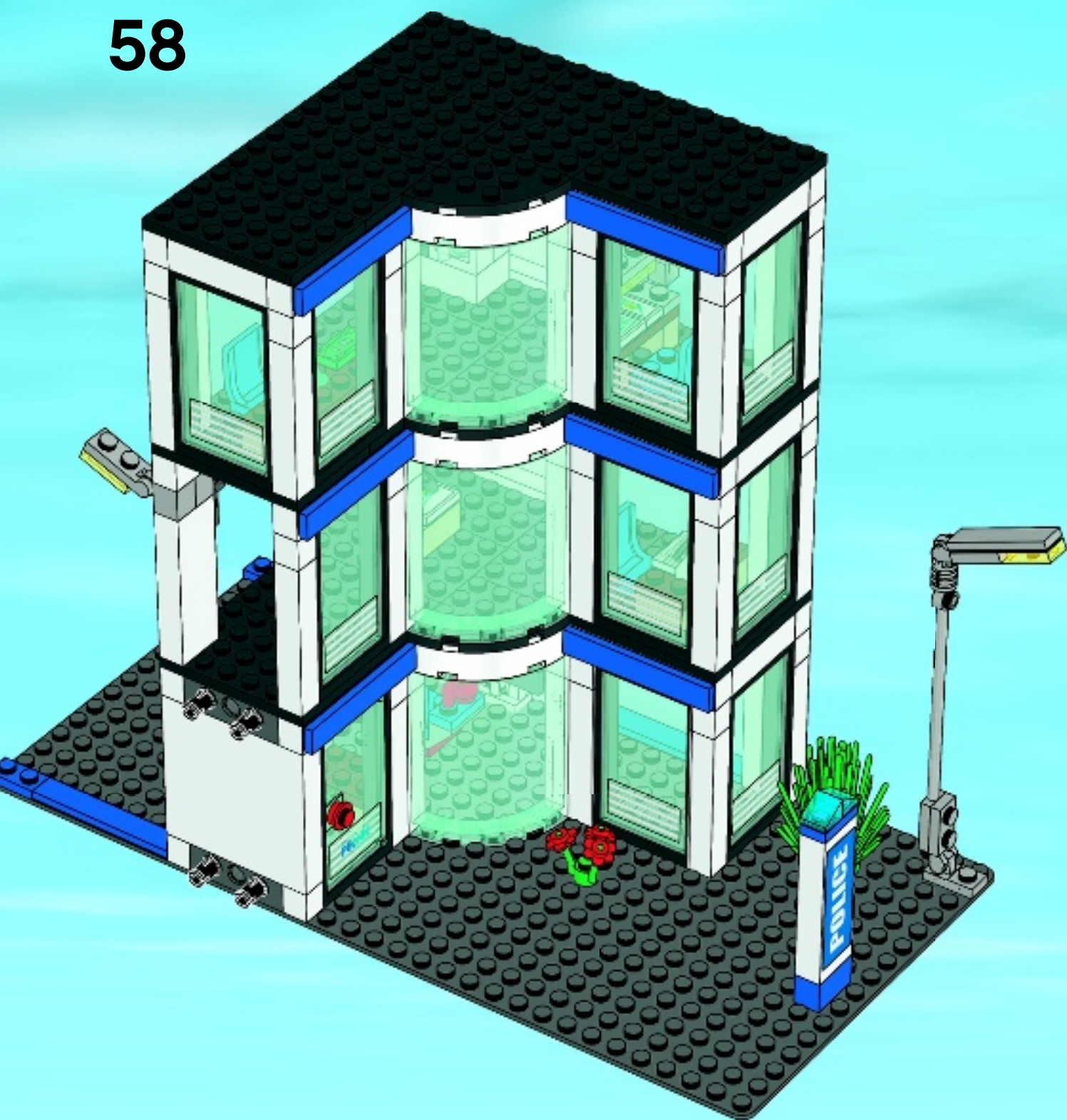



59

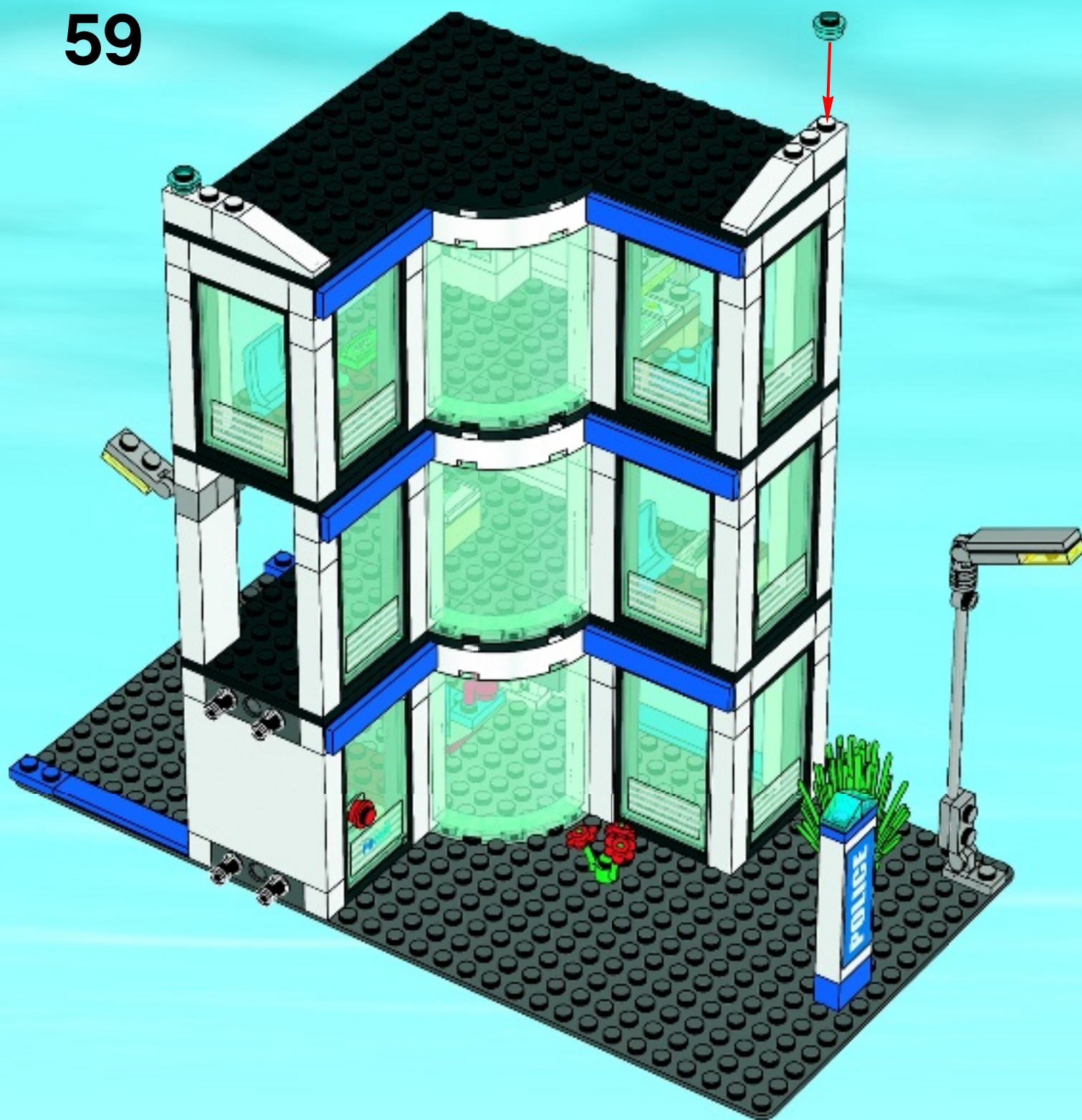

60

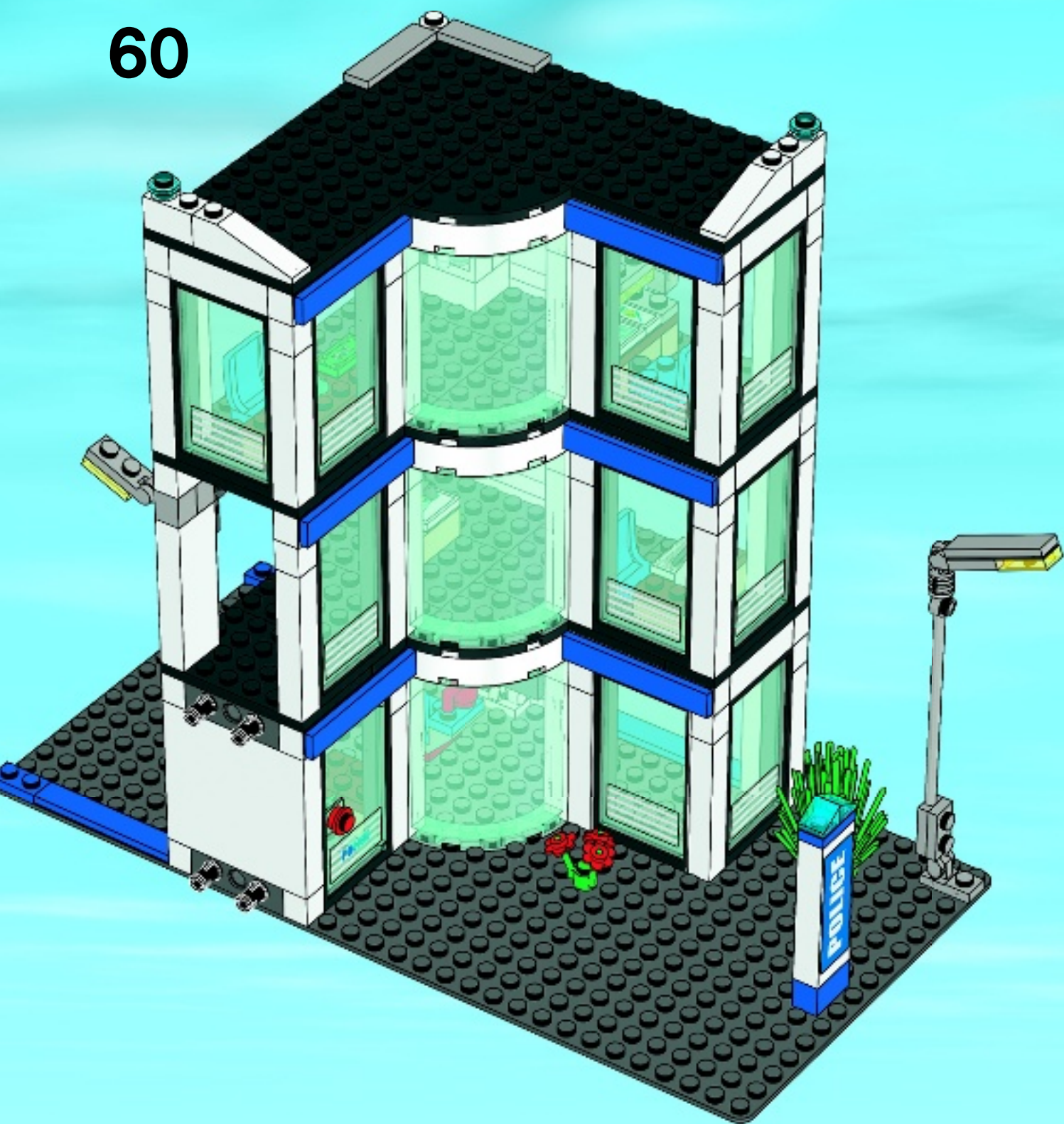



61

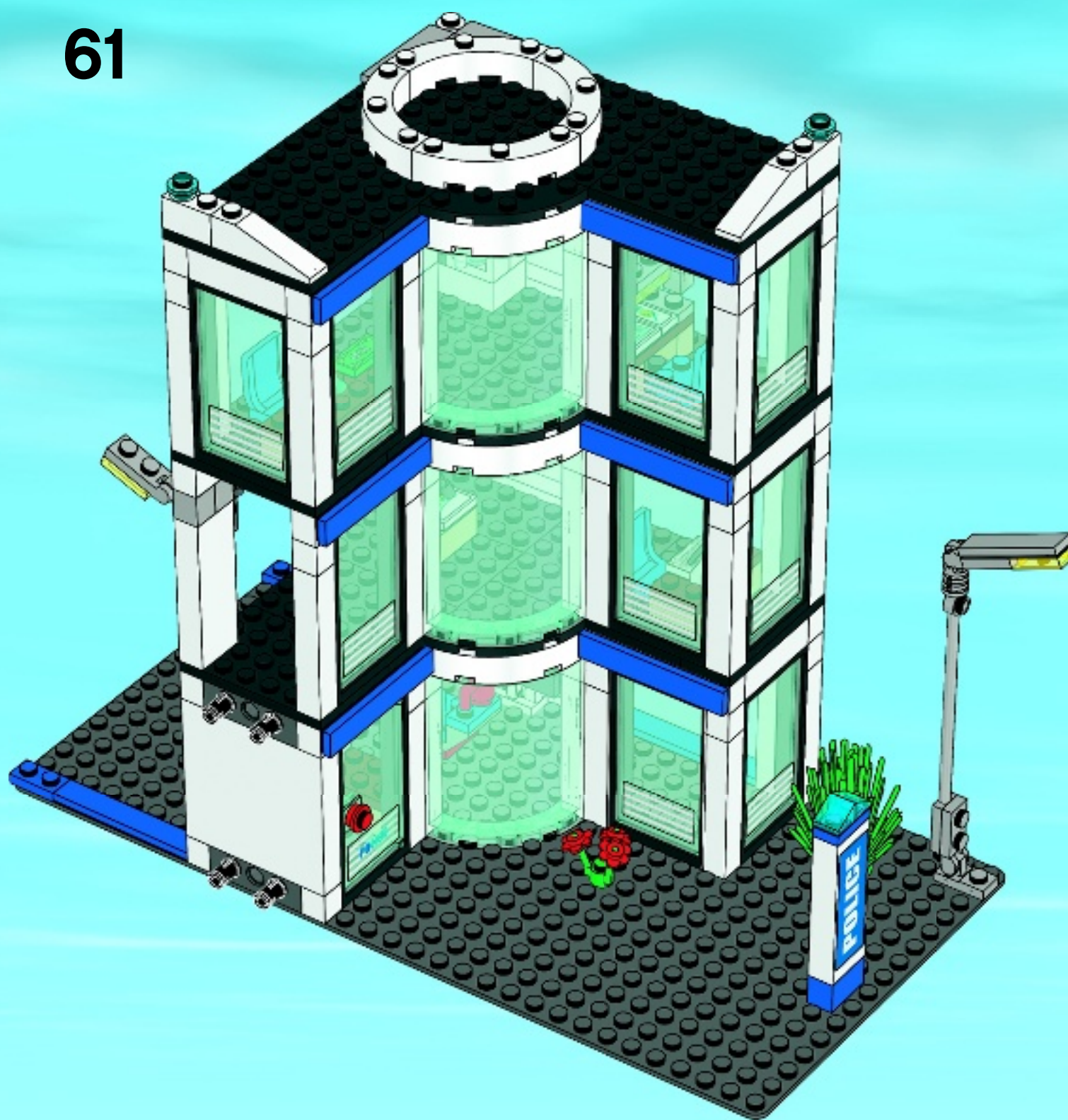



1



2

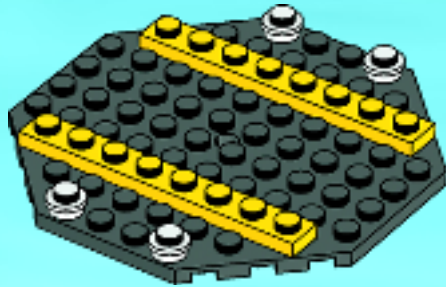

3

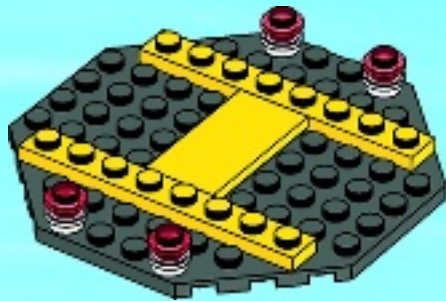



62

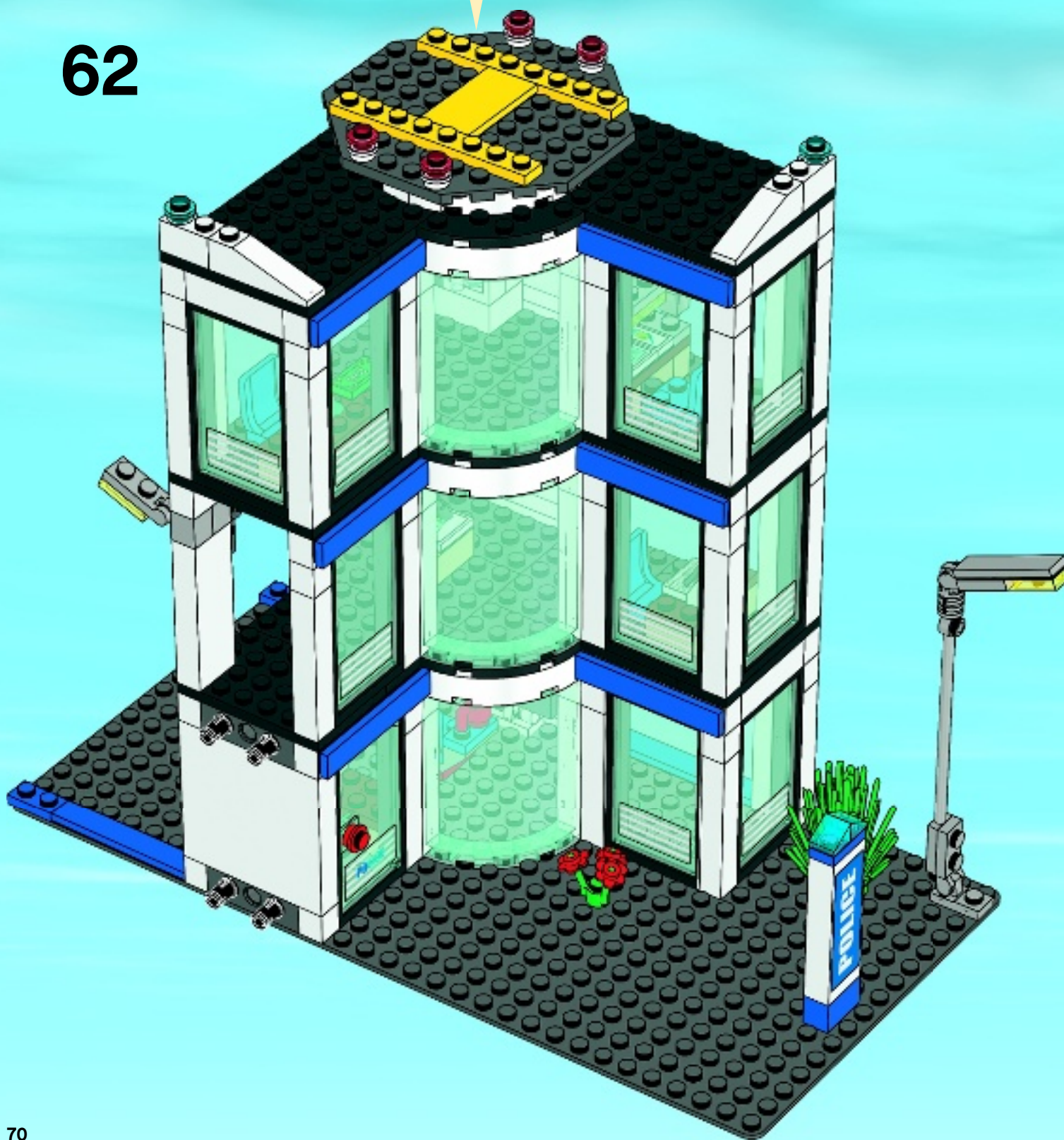

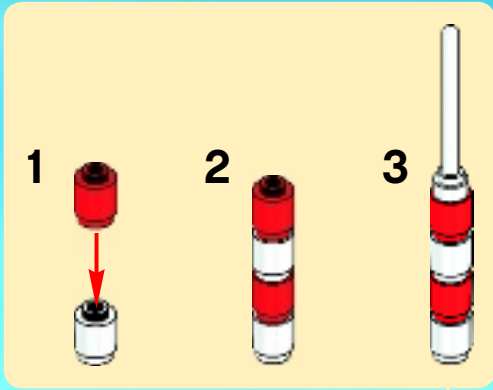

63

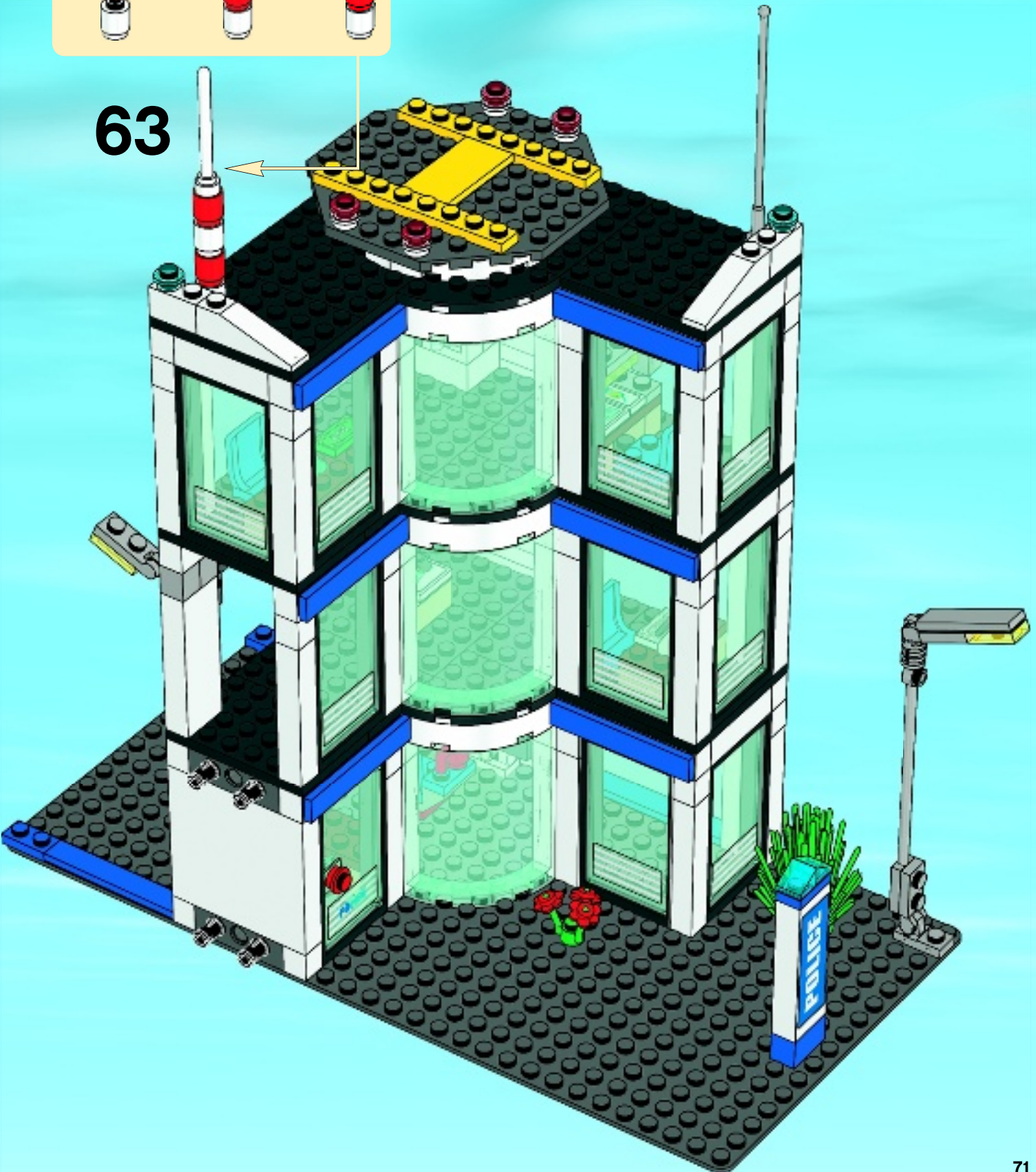



1



2

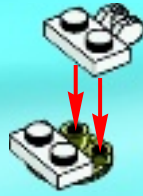

3



4

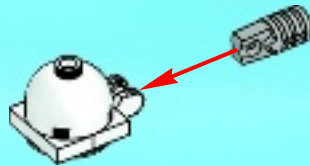

5



6



64

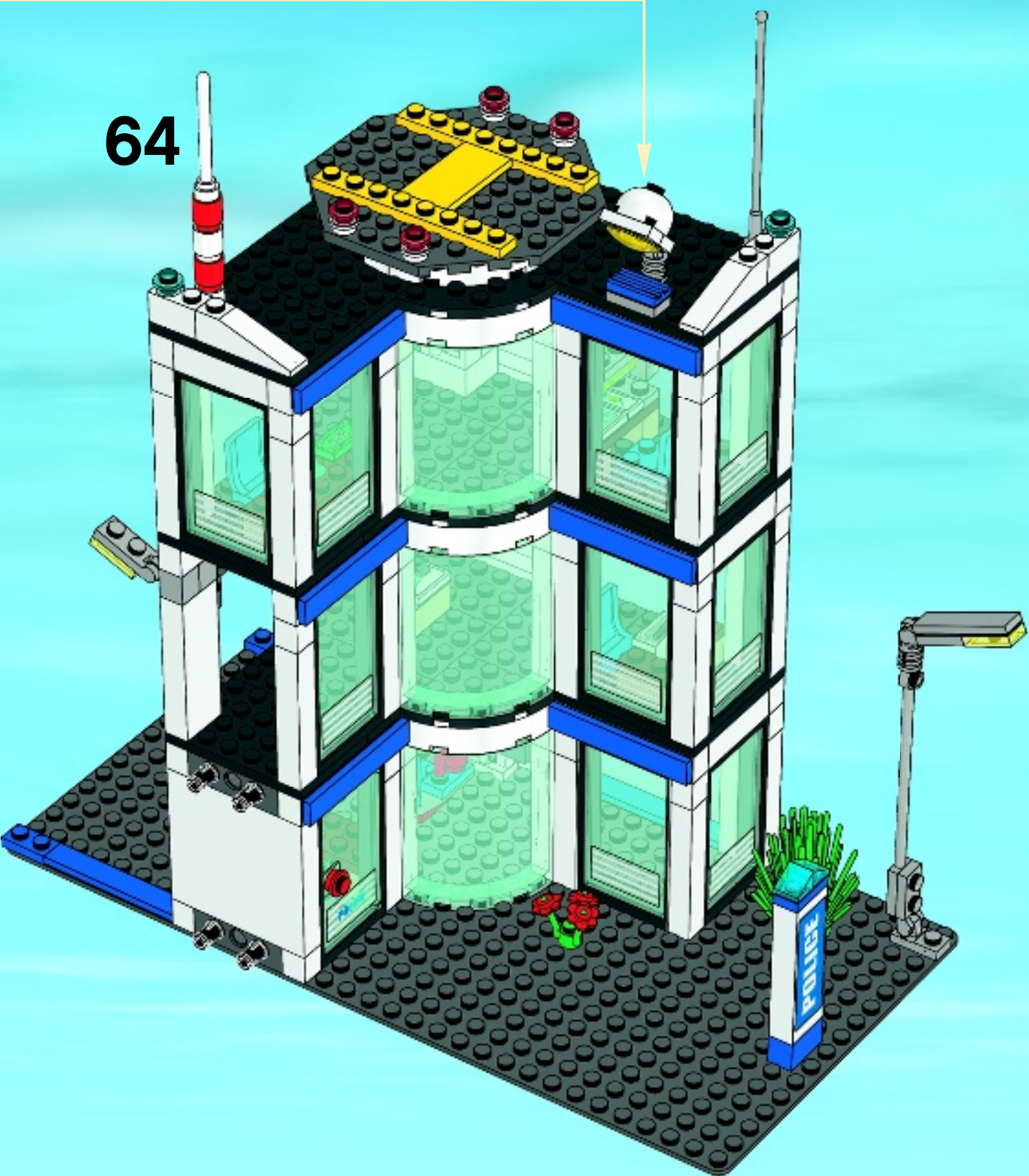



65

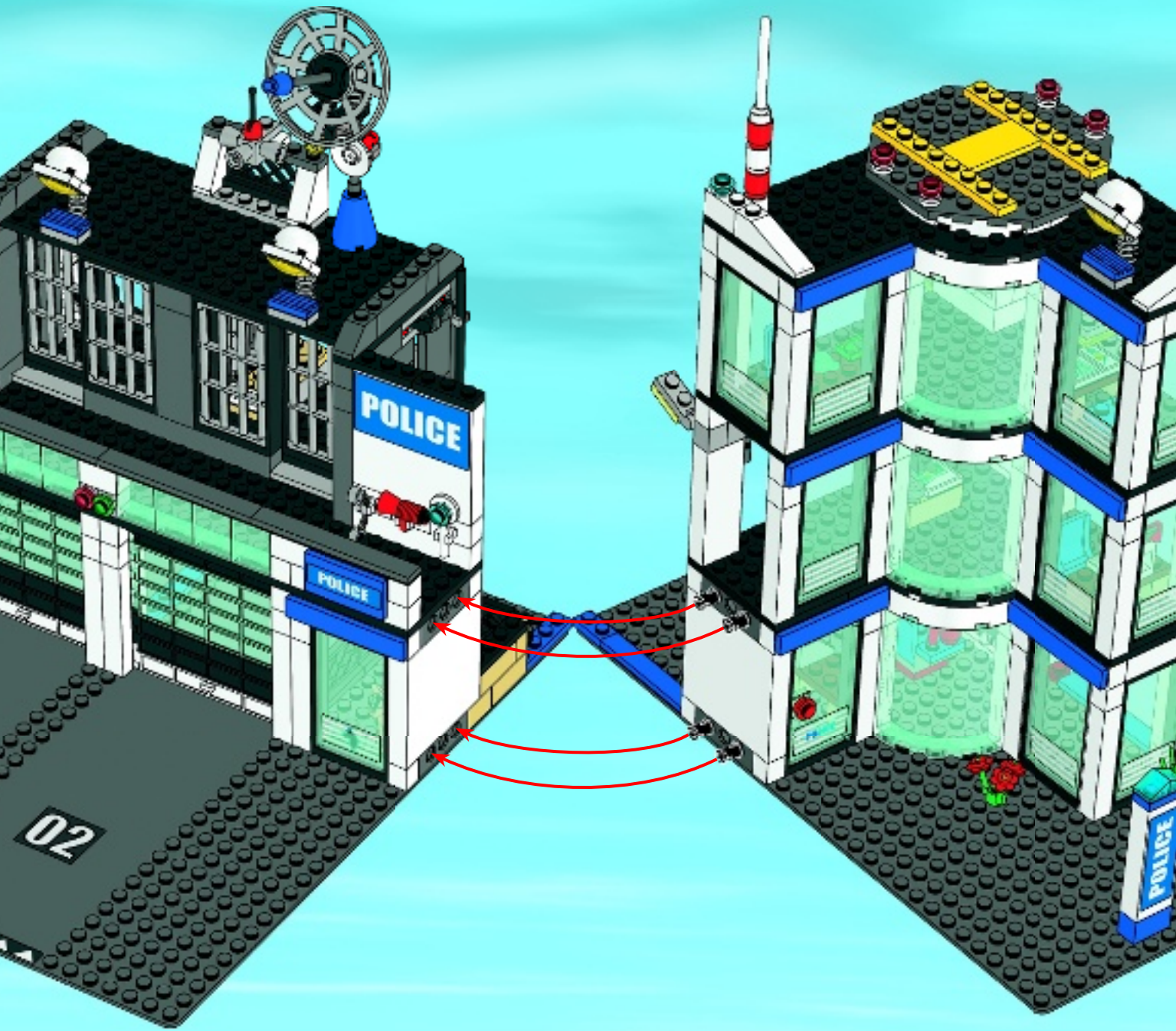



66





67

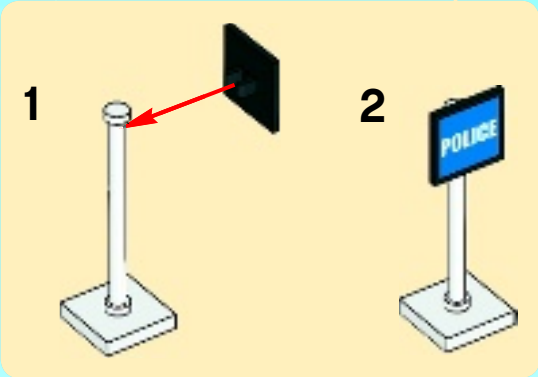



68

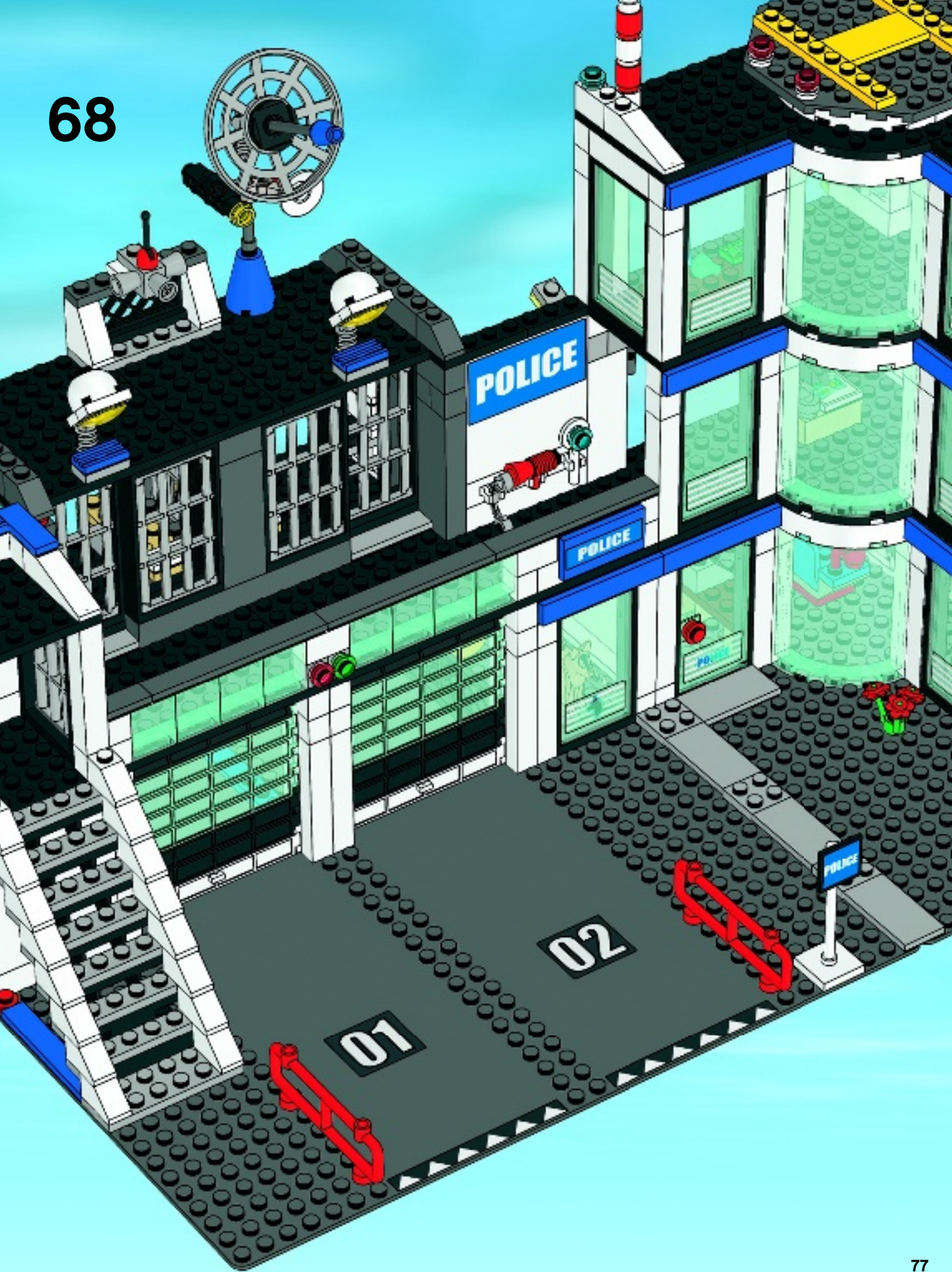





**LEGO CITY**





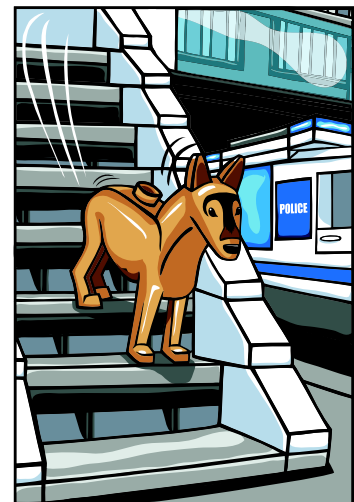
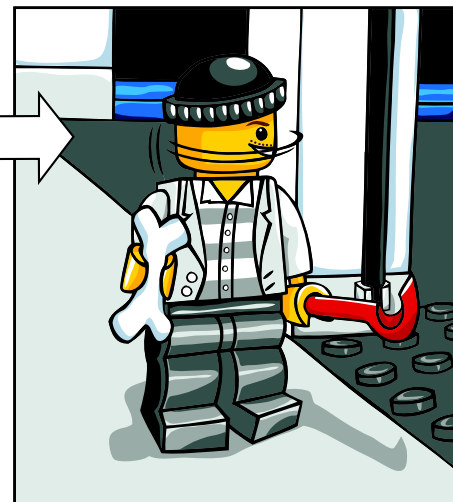
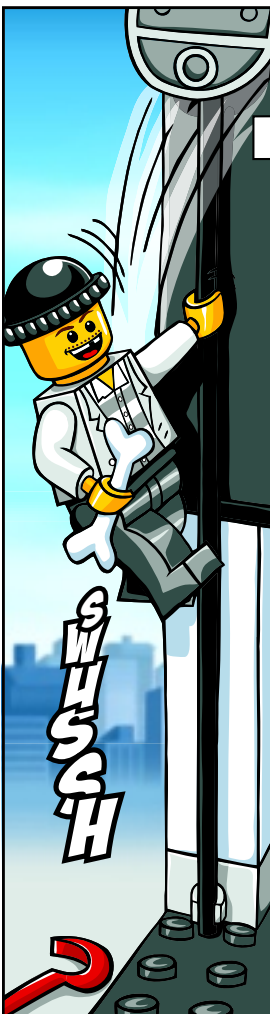
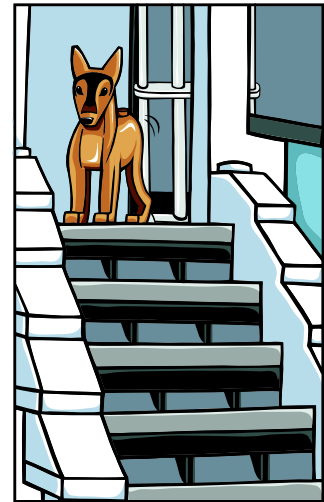



# CITY



[WWW.LEGO.COM](http://WWW.LEGO.COM)

USE THIS KEY TO UNLOCK SECRET CONTENT!  
SCHALTE MIT DIESEM CODE GEHEIMEN INHALT FREI!  
UTILISE CETTE CLÉ POUR DÉBLOQUER LE CONTENU SECRET !

**TL69E4**

¡USA ESTA CLAVE PARA ACCEDER AL CONTENIDO SECRETO!  
USA ESTA CHAVE PARA ABRIRES O CONTEÚDO SECRETO!  
EZZEL A KULCCSAL JUTHATSZ HOZZÁ A TITKOS TARTALOMHOZI!



[CITY.LEGO.COM/COMICBUILDER](http://CITY.LEGO.COM/COMICBUILDER)



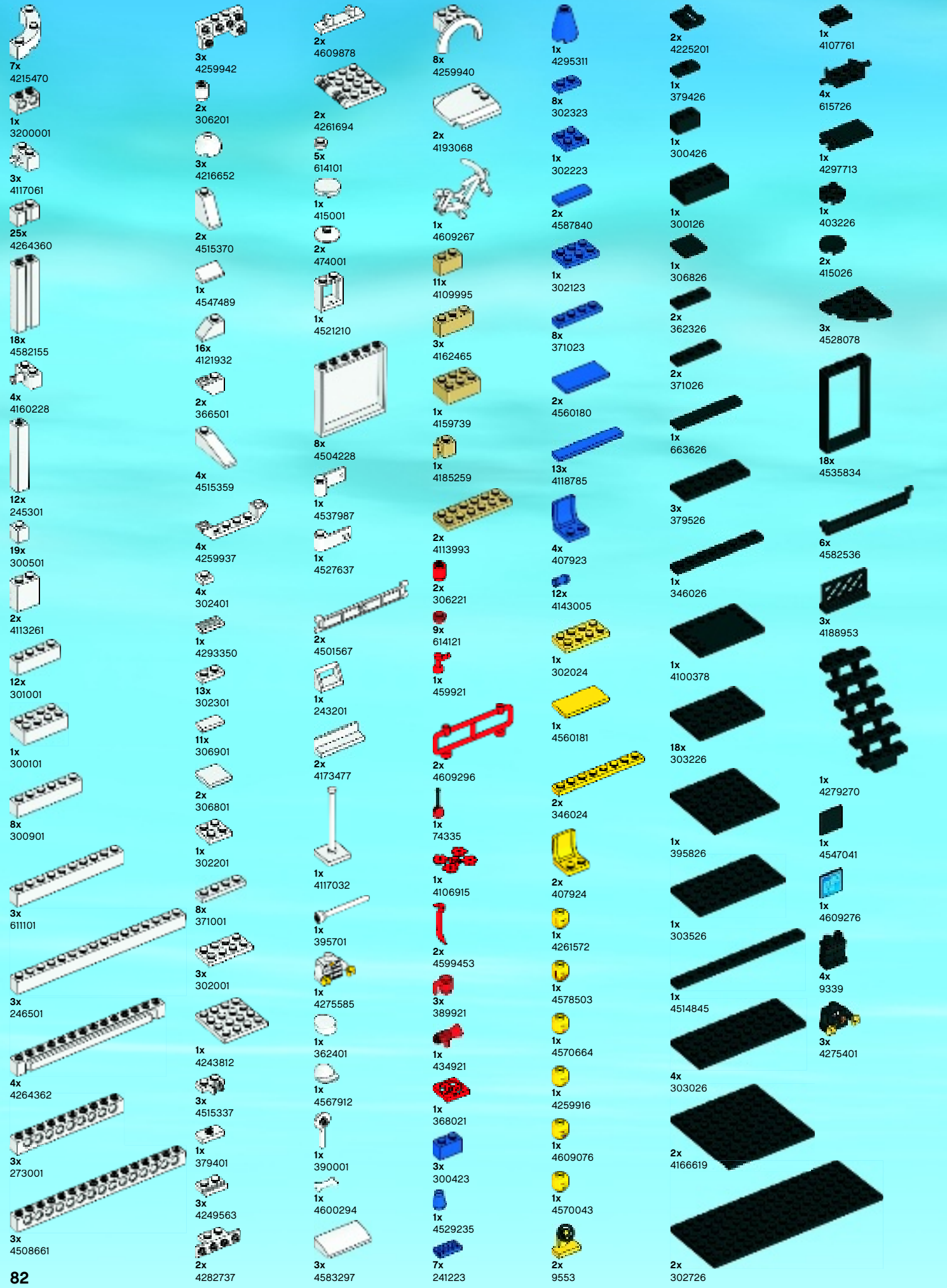

7x 4215470  
 1x 3200001  
 3x 4117061  
 25x 4264360  
 18x 4582155  
 4x 4160228  
 12x 245301  
 19x 300501  
 2x 4113261  
 12x 301001  
 1x 300101  
 8x 300901  
 3x 611101  
 3x 246501  
 4x 4264362  
 3x 273001  
 3x 4508661

3x 4259942  
 2x 306201  
 3x 4216652  
 2x 4515370  
 1x 4547489  
 16x 4121932  
 2x 366501  
 4x 4515359  
 4x 4259937  
 4x 302401  
 1x 4293350  
 13x 302301  
 11x 306901  
 2x 306801  
 1x 302201  
 8x 371001  
 3x 302001  
 1x 4243812  
 3x 4515337  
 1x 379401  
 3x 4249563  
 2x 4282737

2x 4609878  
 2x 4261694  
 5x 614101  
 1x 415001  
 2x 474001  
 1x 4521210  
 8x 4504228  
 1x 4537987  
 1x 4527637  
 2x 4501567  
 1x 243201  
 2x 4173477  
 1x 4117032  
 1x 395701  
 1x 4275585  
 1x 362401  
 1x 4567912  
 1x 390001  
 1x 4600294  
 3x 4583297

8x 4259940  
 2x 4193068  
 1x 4609267  
 11x 4109995  
 3x 4162465  
 1x 4159739  
 1x 4185259  
 2x 4113993  
 2x 306221  
 9x 614121  
 1x 459921  
 2x 4609296  
 1x 74335  
 1x 4106915  
 2x 4599453  
 3x 389921  
 1x 434921  
 1x 368021  
 3x 300423  
 1x 4529235  
 7x 241223

1x 4295311  
 8x 302323  
 1x 302223  
 2x 4587840  
 1x 302123  
 8x 371023  
 2x 4560180  
 13x 4118785  
 4x 407923  
 12x 4143005  
 1x 302024  
 1x 4560181  
 2x 346024  
 2x 407924  
 1x 4261572  
 1x 4578503  
 1x 4570664  
 1x 4259916  
 1x 4609076  
 1x 4570043  
 2x 9553

2x 4225201  
 1x 379426  
 1x 300426  
 1x 300126  
 1x 306826  
 2x 362326  
 2x 371026  
 1x 663626  
 3x 379526  
 1x 346026  
 1x 4100378  
 18x 303226  
 1x 395826  
 1x 303526  
 1x 4514845  
 4x 303026  
 2x 4166619  
 2x 302726

1x 4107761  
 4x 615726  
 1x 4297713  
 1x 403226  
 2x 415026  
 3x 4528078  
 18x 4535834  
 6x 4582536  
 3x 4188953  
 1x 4279270  
 1x 4547041  
 1x 4609276  
 4x 9339  
 3x 4275401

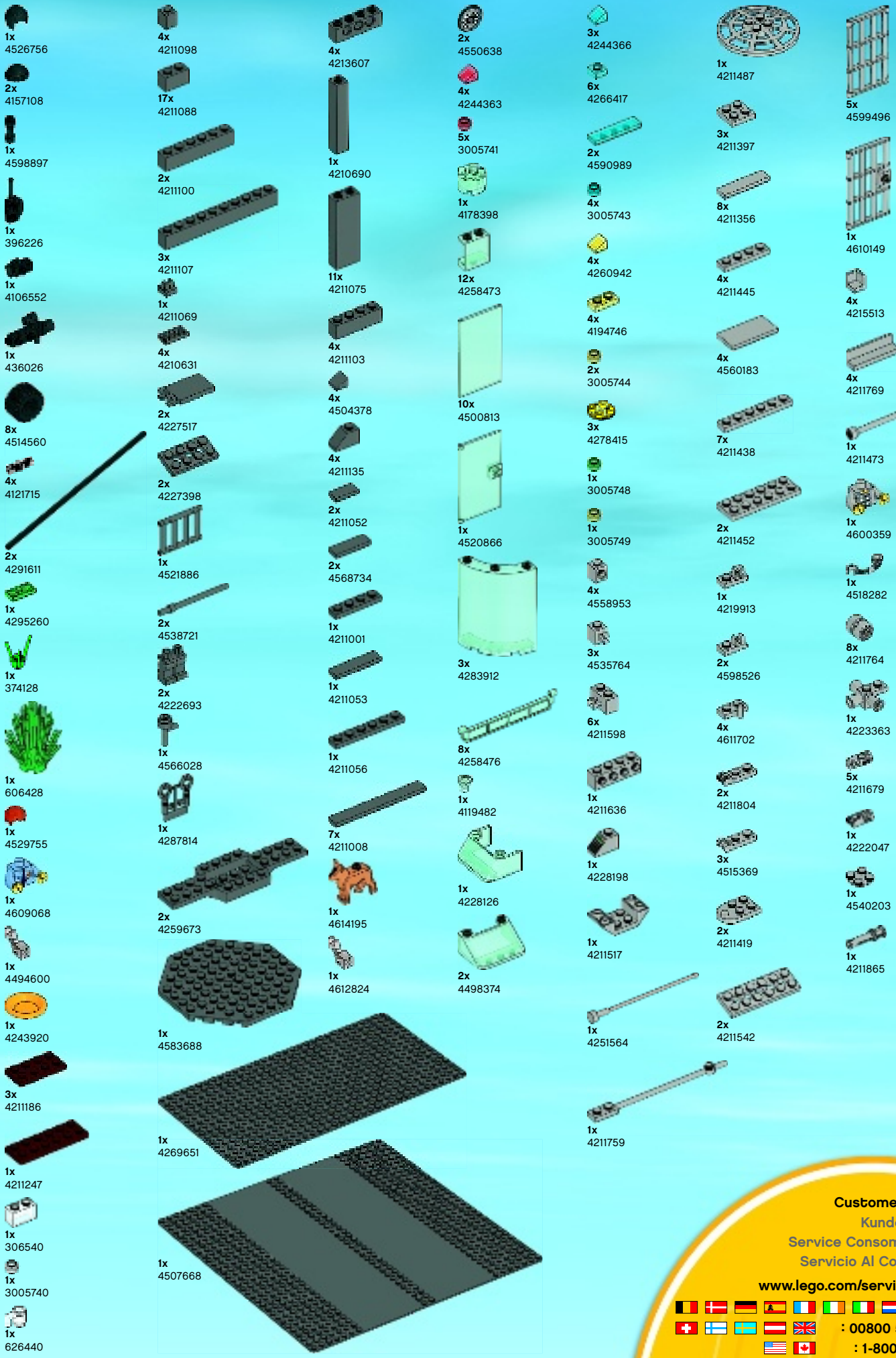

1x 4526756  
 2x 4157108  
 1x 4598897  
 1x 396226  
 1x 4106552  
 1x 436026  
 8x 4514560  
 4x 4121715  
 2x 4291611  
 1x 4295260  
 1x 374128  
 1x 606428  
 1x 4529755  
 1x 4609068  
 1x 4494600  
 1x 4243920  
 3x 421186  
 1x 4211247  
 1x 306540  
 1x 3005740  
 1x 626440

4x 4211098  
 17x 4211088  
 2x 4211100  
 3x 4211107  
 1x 4211069  
 4x 4210631  
 2x 4227517  
 2x 4227398  
 1x 4521886  
 2x 4538721  
 2x 4222693  
 1x 4566028  
 1x 4287814  
 2x 4259673  
 1x 4583688  
 1x 4269651  
 1x 4507668

4x 4213607  
 1x 4210690  
 11x 4211075  
 4x 4211103  
 4x 4504378  
 4x 4211135  
 2x 4211052  
 2x 4568734  
 1x 4211001  
 1x 4211053  
 1x 4211056  
 7x 4211008  
 1x 4614195  
 1x 4612824

2x 4550638  
 4x 4244363  
 5x 3005741  
 1x 4178398  
 12x 4258473  
 10x 4500813  
 1x 4520866  
 3x 4283912  
 8x 4258476  
 1x 4119482  
 1x 4228126  
 2x 4498374

3x 4244366  
 6x 4266417  
 2x 4590989  
 4x 3005743  
 4x 4260942  
 4x 4194746  
 2x 3005744  
 3x 4278415  
 1x 3005748  
 1x 3005749  
 4x 4558953  
 3x 4535764  
 6x 4211598  
 1x 4211636  
 1x 4228198  
 1x 4211517  
 1x 4251564  
 1x 4211759

1x 4211487  
 3x 4211397  
 8x 4211356  
 4x 4211445  
 4x 4560183  
 7x 4211438  
 2x 4211452  
 1x 4219913  
 2x 4598526  
 4x 4611702  
 2x 4211804  
 3x 4515369  
 2x 4211419  
 2x 4211542

5x 4599496  
 1x 4610149  
 4x 4215513  
 4x 4211769  
 1x 4211473  
 1x 4600359  
 1x 4518282  
 8x 4211764  
 1x 4223363  
 5x 4211679  
 1x 4222047  
 1x 4540203  
 1x 4211865

Customer Service  
 Kundenservice  
 Service Consommateurs  
 Servicio Al Consumidor

[www.lego.com/service](http://www.lego.com/service) or dial



: 00800 5346 5555  
 : 1-800-422-5346





# WIN!



Go to [www.LEGOsurvey.com/product](http://www.LEGOsurvey.com/product) to fill out a survey for a chance to win a cool LEGO® Product. No purchase necessary. Open to all residents where not prohibited.

 [www.LEGO.com](http://www.LEGO.com)

# [www.LEGOsurvey.com/product](http://www.LEGOsurvey.com/product)

## GEWINNE!

Nimm an der Umfrage auf [www.LEGOsurvey.com/product](http://www.LEGOsurvey.com/product) teil und hab die Chance ein cooles LEGO® Produkt zu gewinnen!  
Die Teilnahme am Gewinnspiel führt zu keinerlei Kaufverpflichtungen. Teilnahme in allen nicht ausgeschlossenen Ländern möglich.

6003717 / 6003723

## WIN!

Ga naar [www.LEGOsurvey.com/product](http://www.LEGOsurvey.com/product), vul een enquêteformulier in en maak kans op een cool LEGO® product.  
Geen aankoopverplichting.  
Iedereen mag deelnemen, uitgezonderd ingezetenden van landen waar een enquêteverbod geldt.

## GAGNE !

Visite [www.LEGOsurvey.com/product](http://www.LEGOsurvey.com/product) pour répondre à un questionnaire et avoir une chance de gagner un produit LEGO® très cool !  
Aucune obligation d'achat.  
Ouvert à tous les résidents des pays autorisés.

## 当てよう!

[www.LEGOsurvey.com/product](http://www.LEGOsurvey.com/product) にアクセスして、アンケートにご記入ください。当選者にはレゴ®製品を差し上げます。  
お買い上げの必要はありません。  
禁止されていない限り、すべての皆様にご利用いただけます。