



NINJAGO

Masters of Spinjitzu



70505



**GOLDEN NINJA
INCLUDED**



1

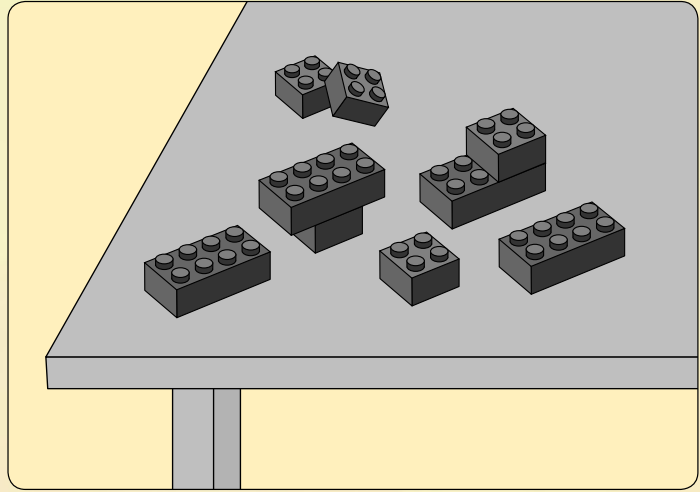
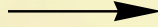
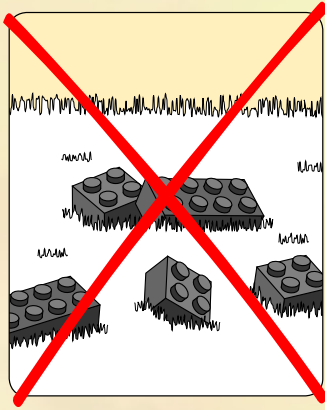

2



<http://lego.com/brickseparator>

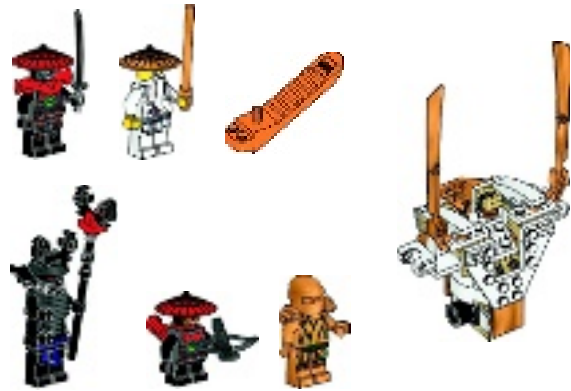

**GOLDEN NINJA INCLUDED
GOLDENER NINJA ENTHALTEN
NINJA D'OR INCLUS
INCLUYE AL NINJA DORADO
NINJA DOURADO INCLUIDO
ARANY NINZSA A DOBOZBAN**



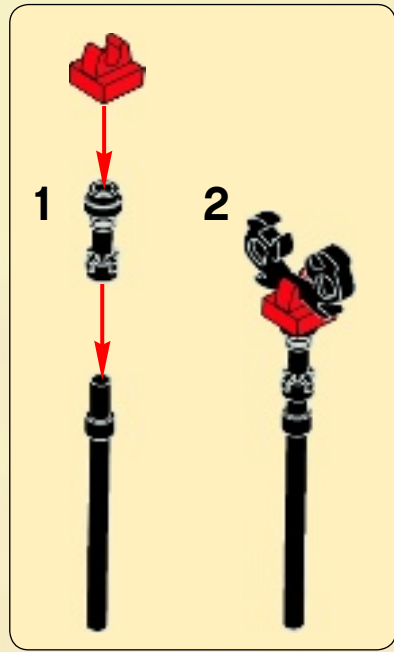
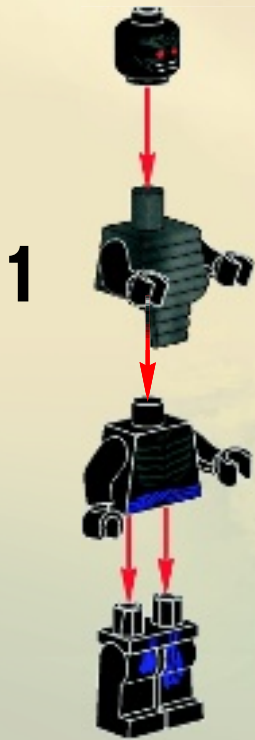

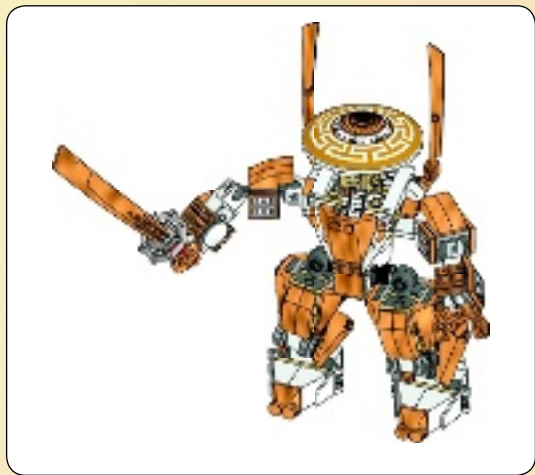

1

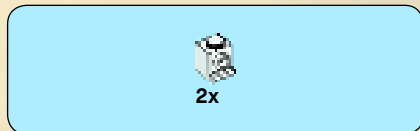

2





2x



1x

3



4x

4



1x



2x

5





1x

6



2x

7

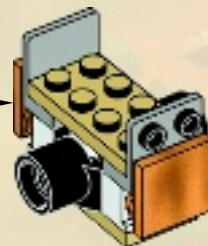
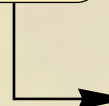

1x

8





1x

9



1x

10





2x



4x

11



2x

12

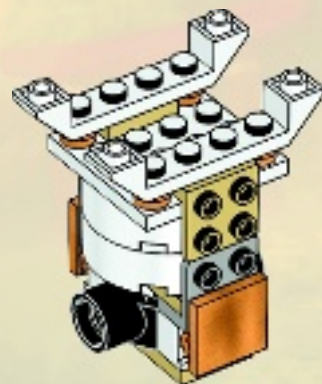



13

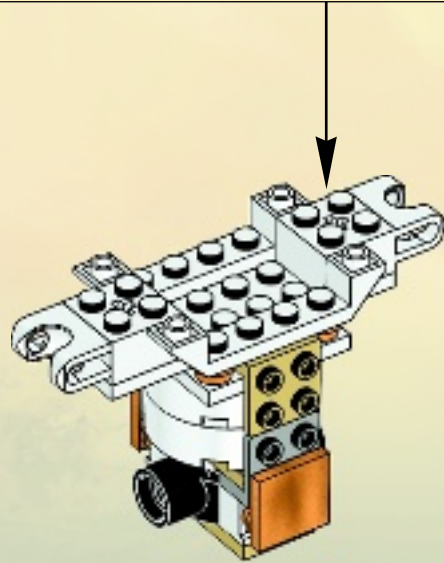
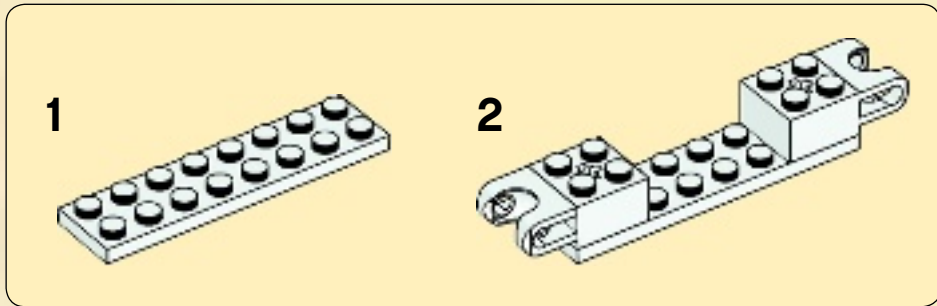



8x

14

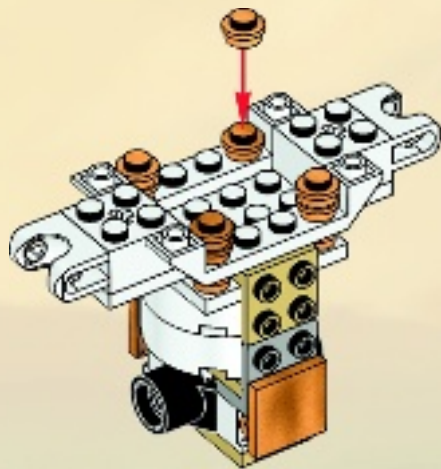

2x



4x

15

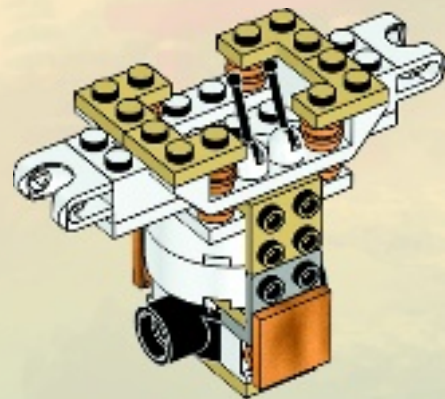



2x

18

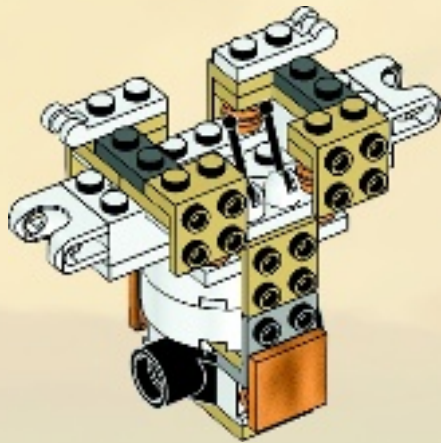

2x

19

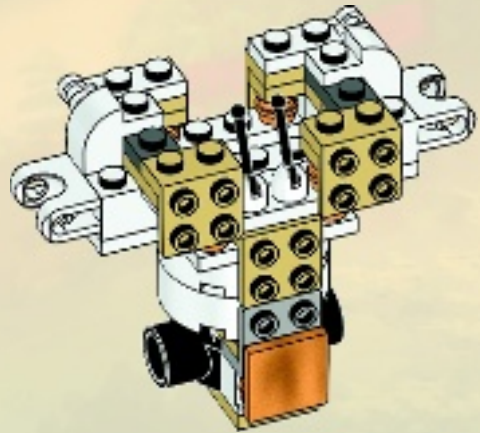



2x



2x

20

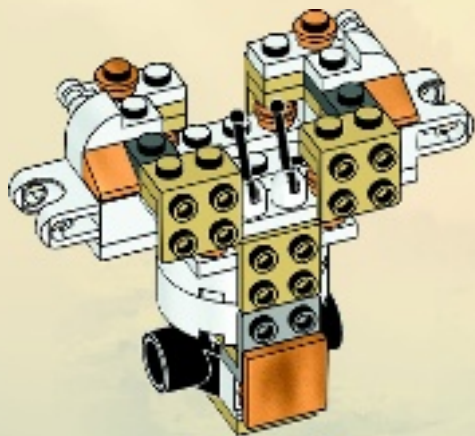

2x

21

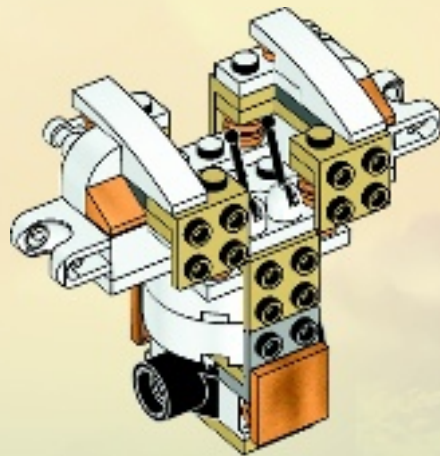



1x

22

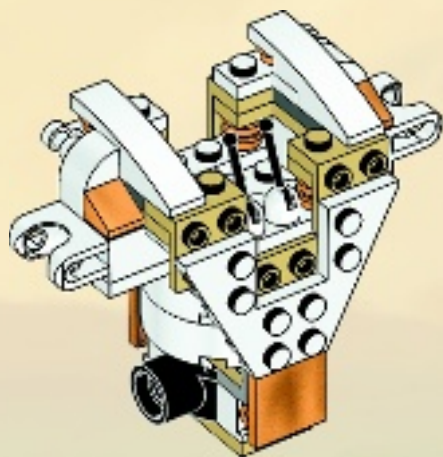

1x



2x

23

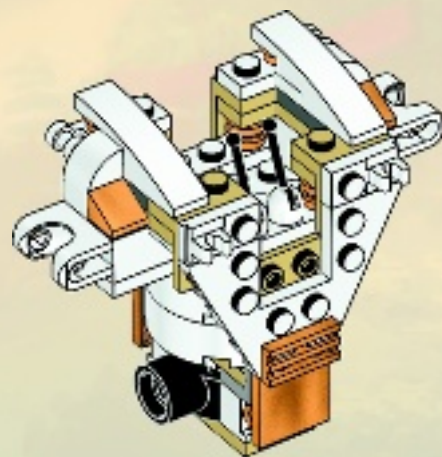

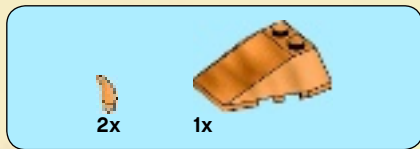

24

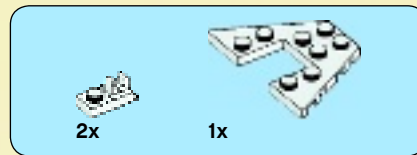
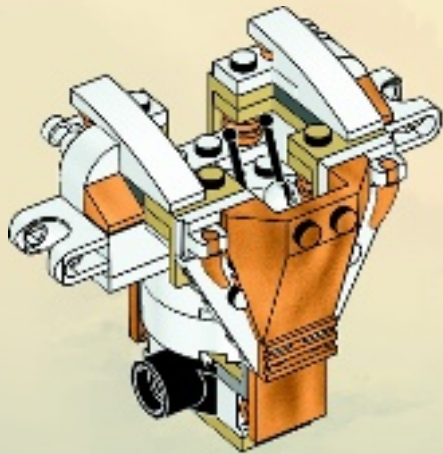

25

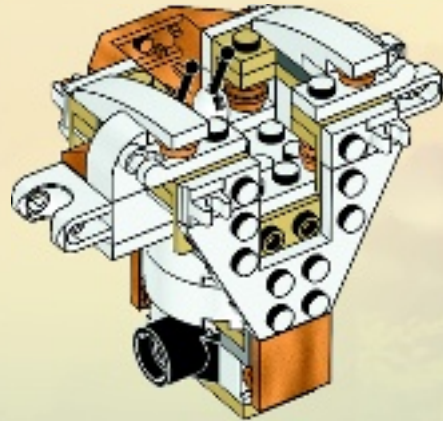
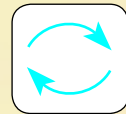



26

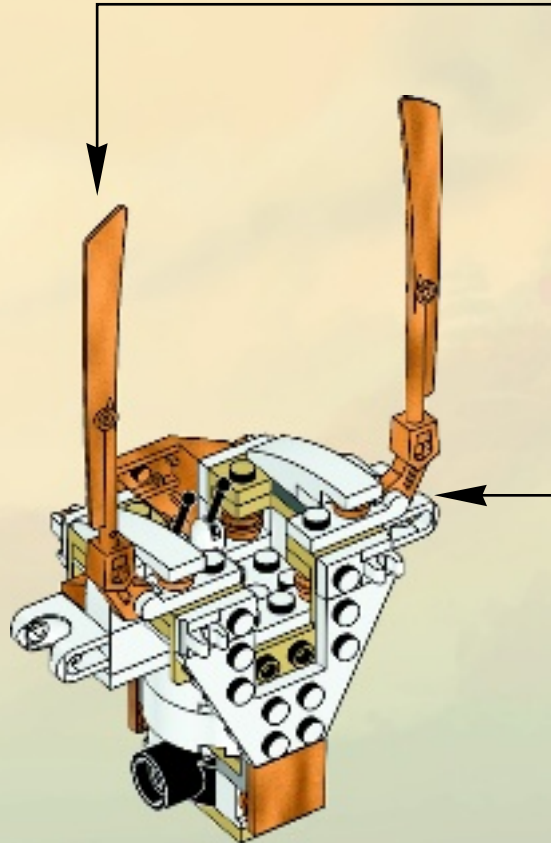
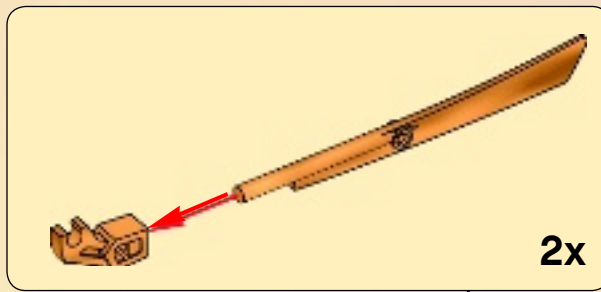

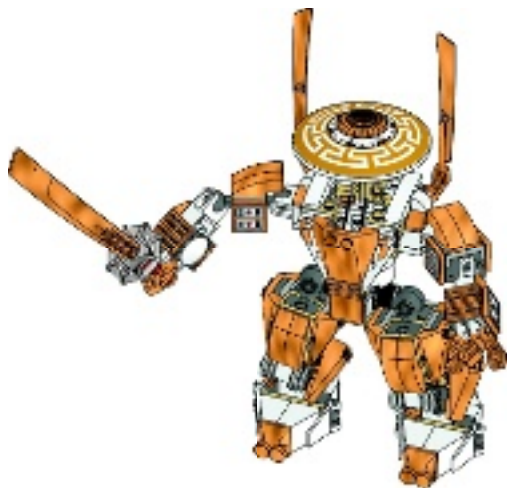

2x



2x

1

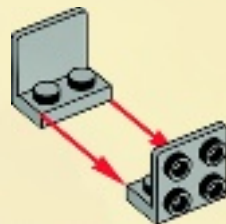

1x

2

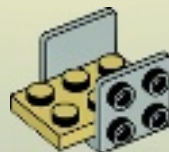



3

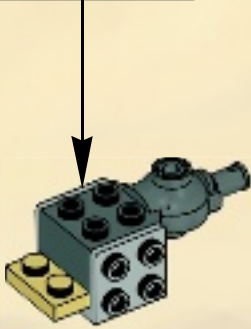
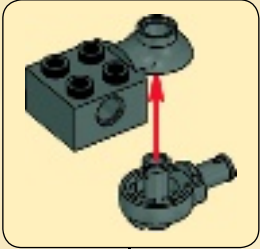

4



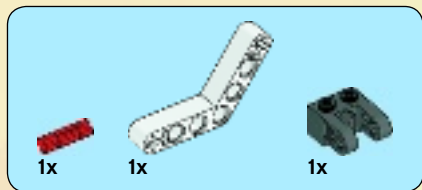

5

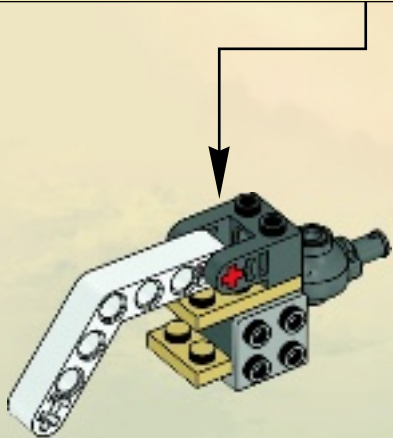
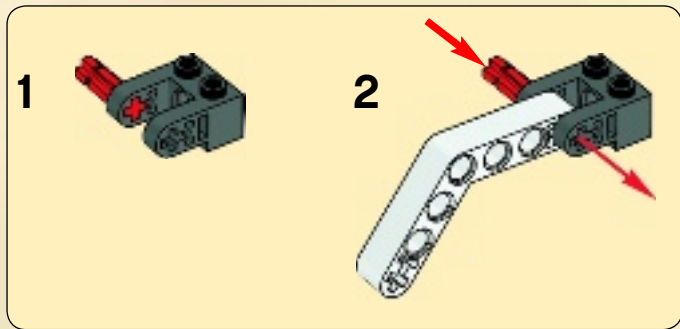

6

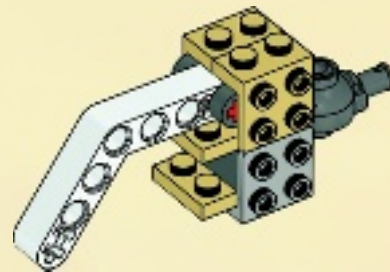

7

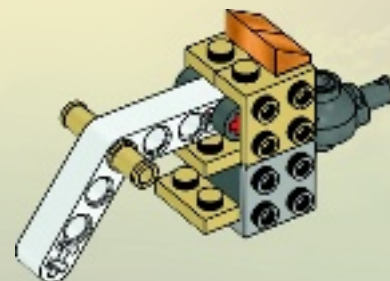

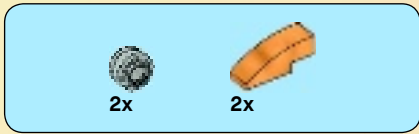

8

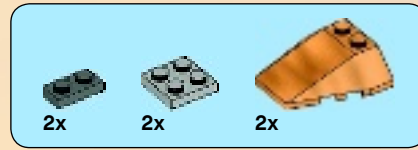
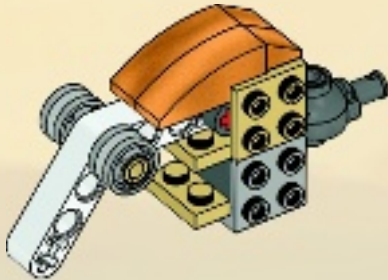

9

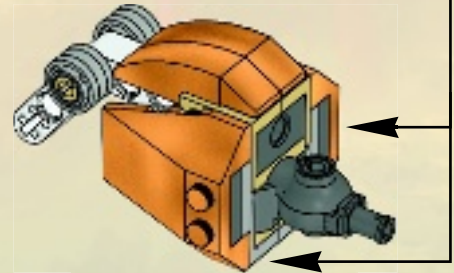



2x

1

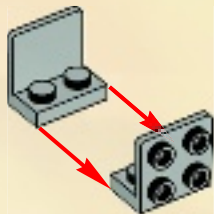

1x

2



1x

3

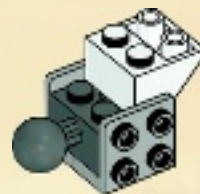



1x

4



1x

5





1x

6

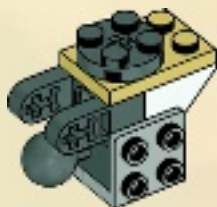

2x

7





1x



1x

8

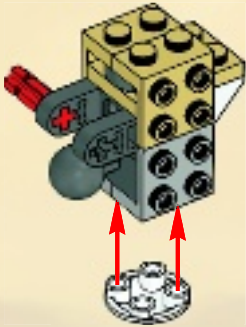

9

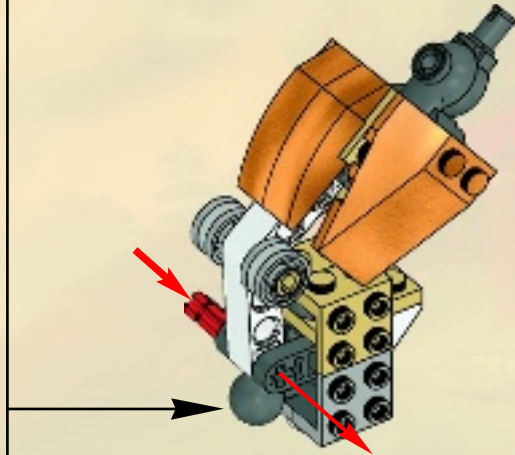



2x

1

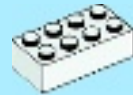
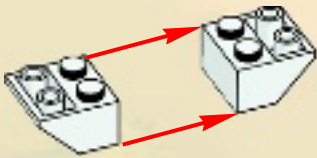

1x

2

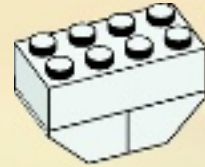

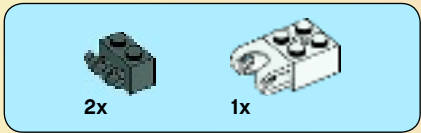

3



4





2x

5

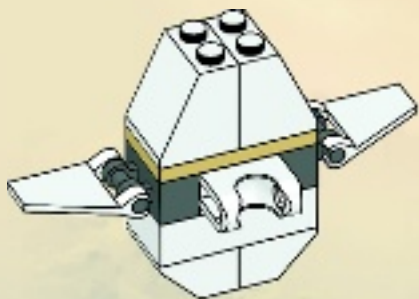

1x

6

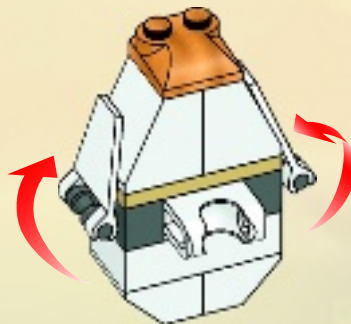



1x



2x

7

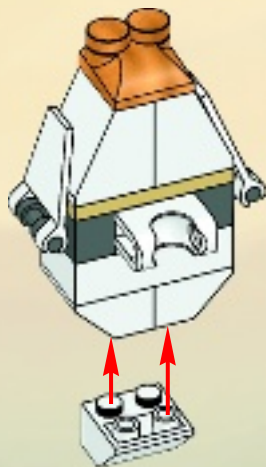

8

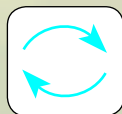
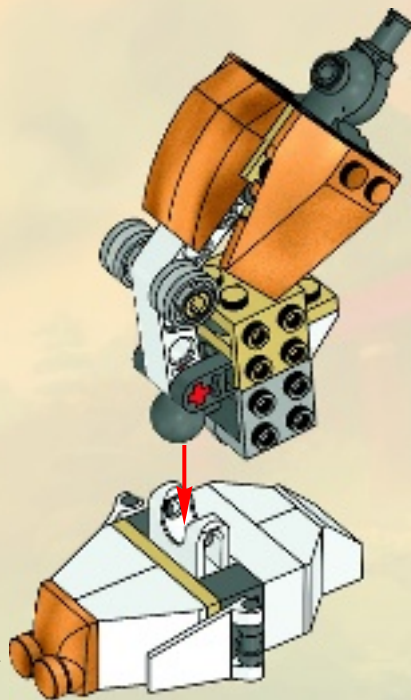



2x

9

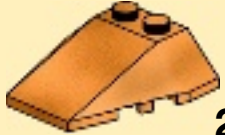

2x

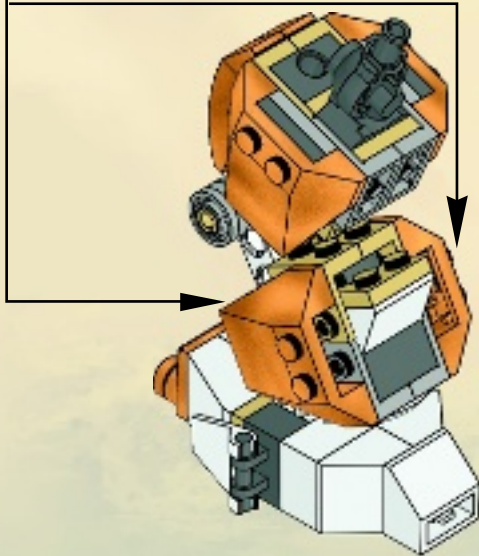

10

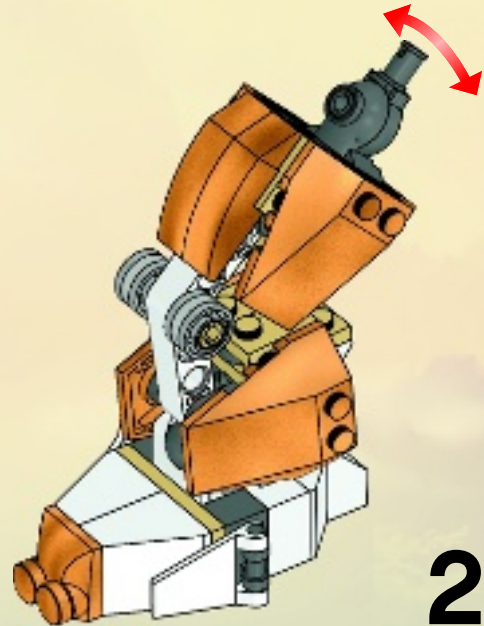

2x

11

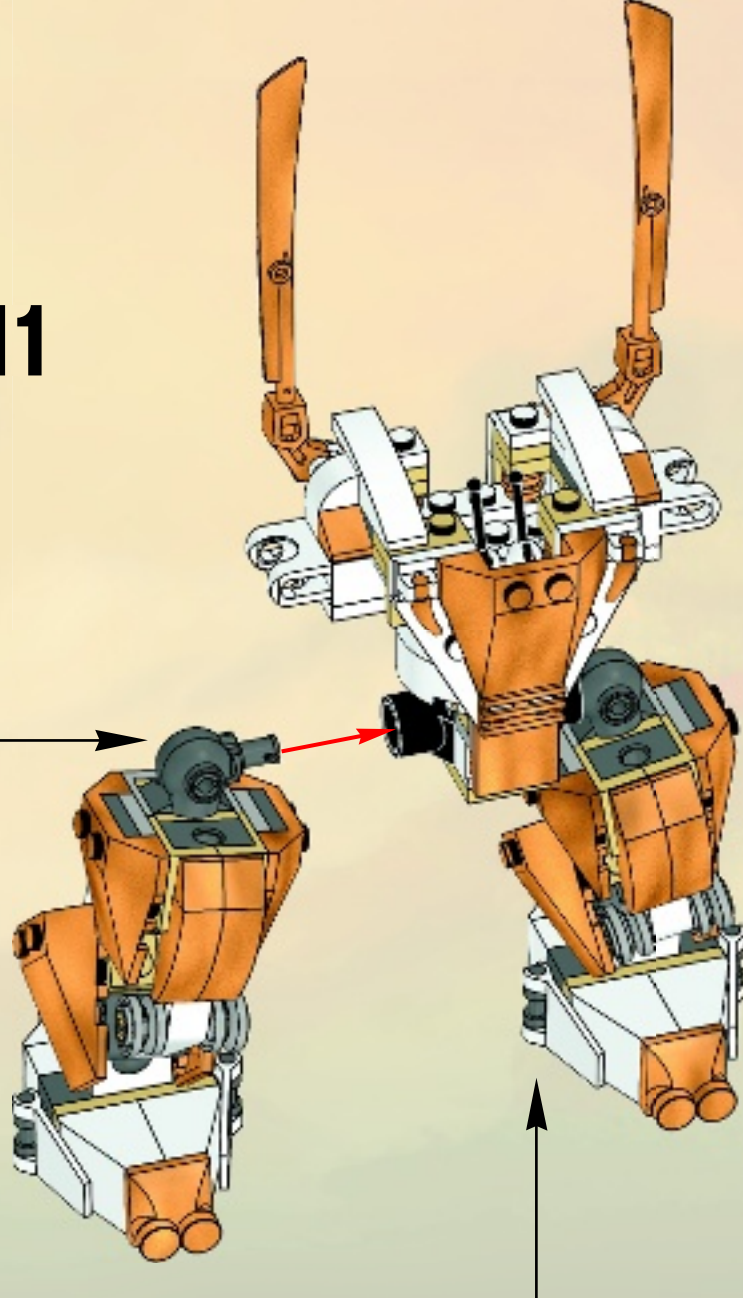

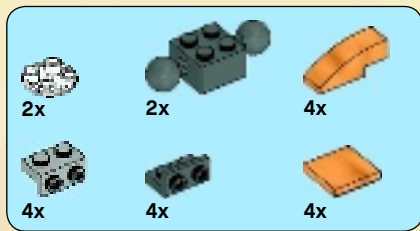

12

1

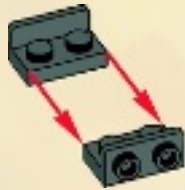

2



3



4



5



2x

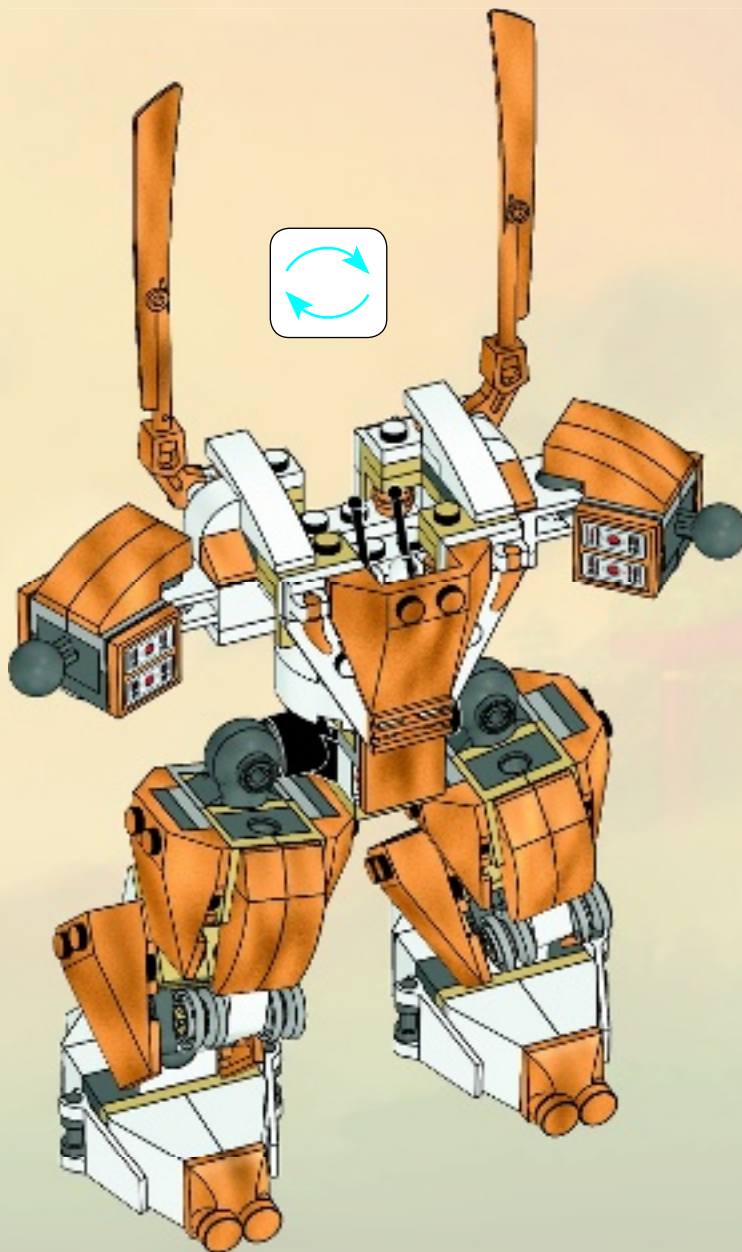
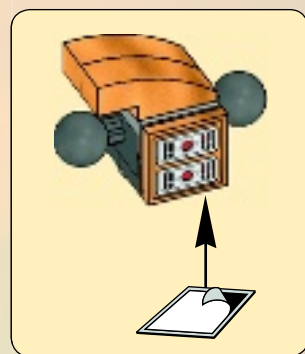
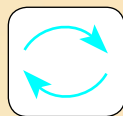
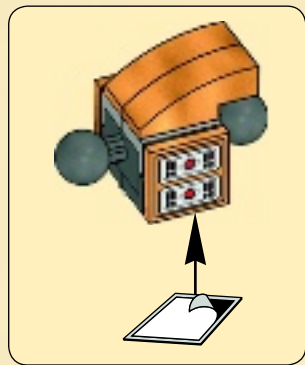



2x



1x

1



2x

2

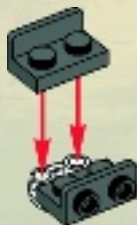

1x

3

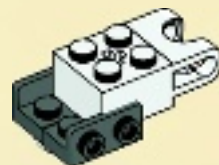

1x



2x

4

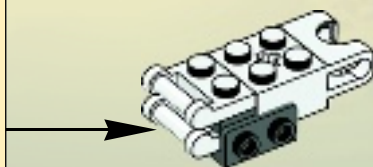
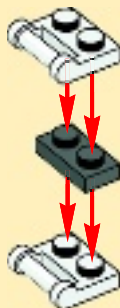



2x

5



2x

6



4x

7

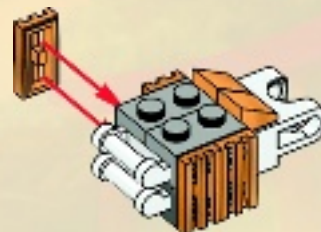



1x

8



3x

9



10

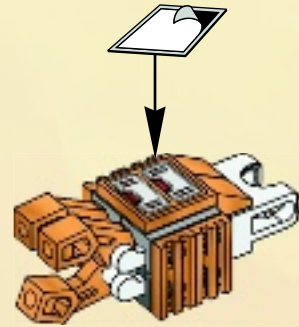

2x

11

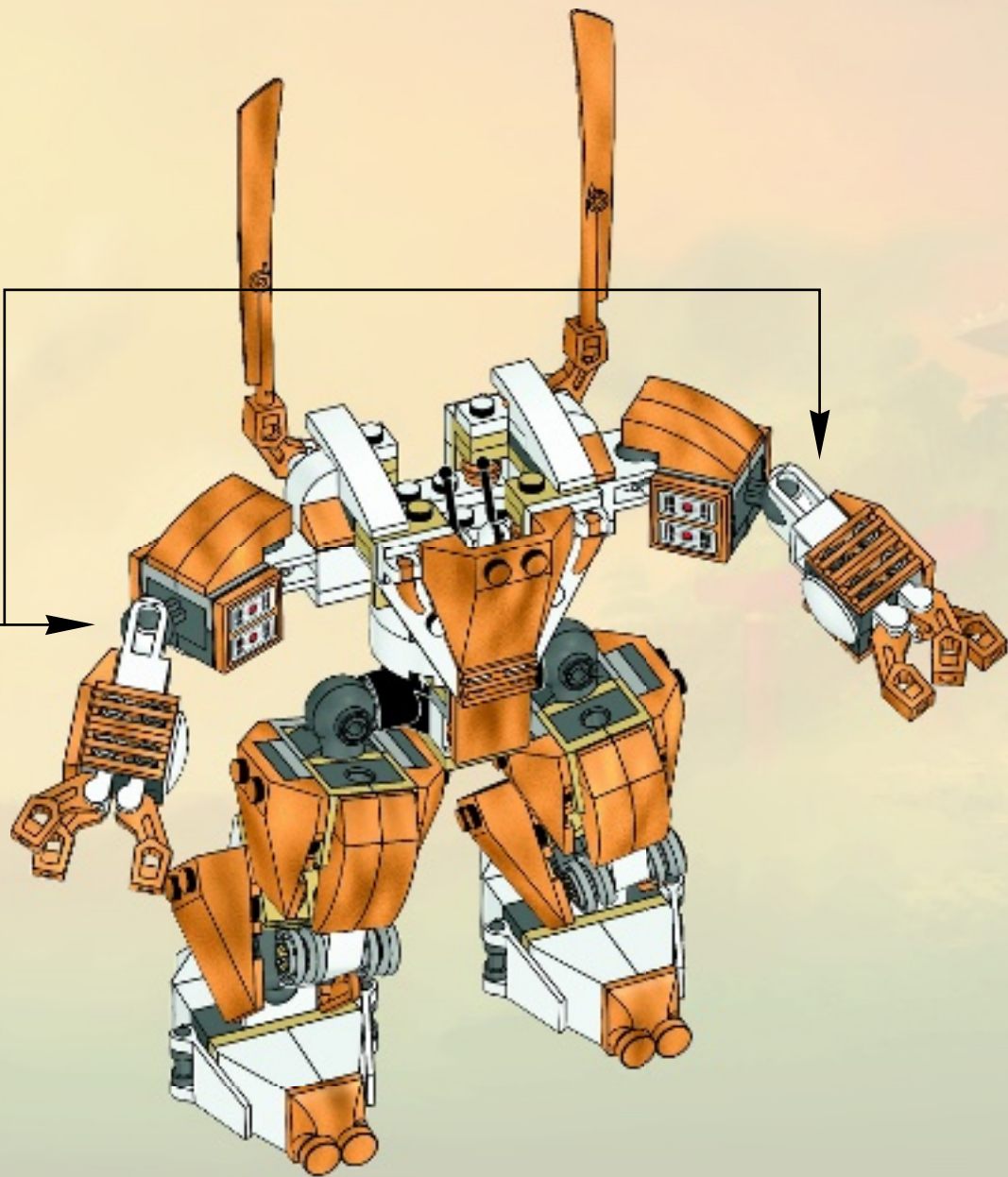

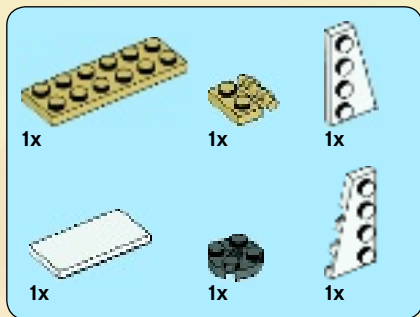

12

1



2

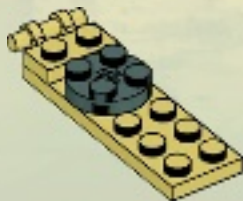

3



4



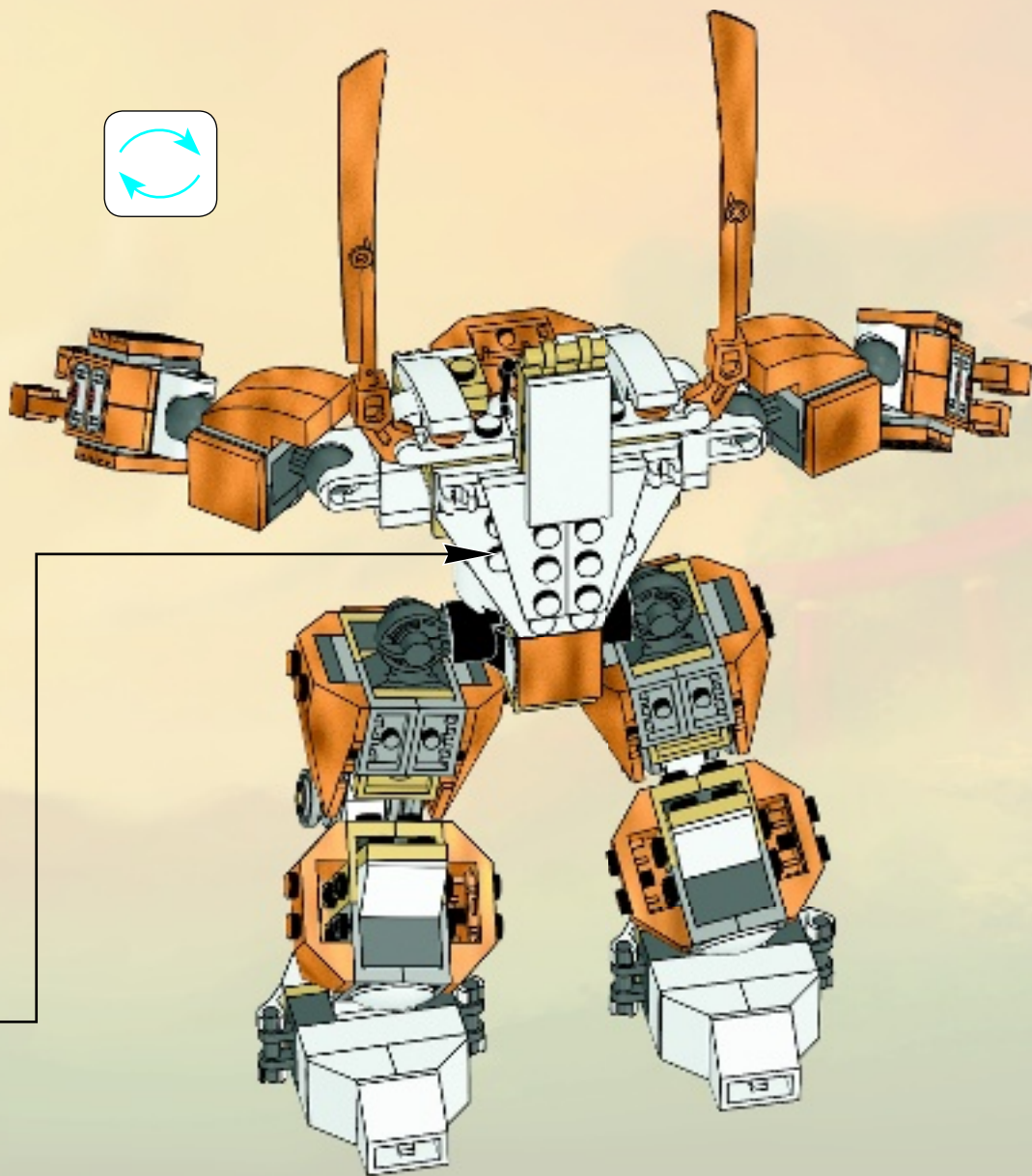

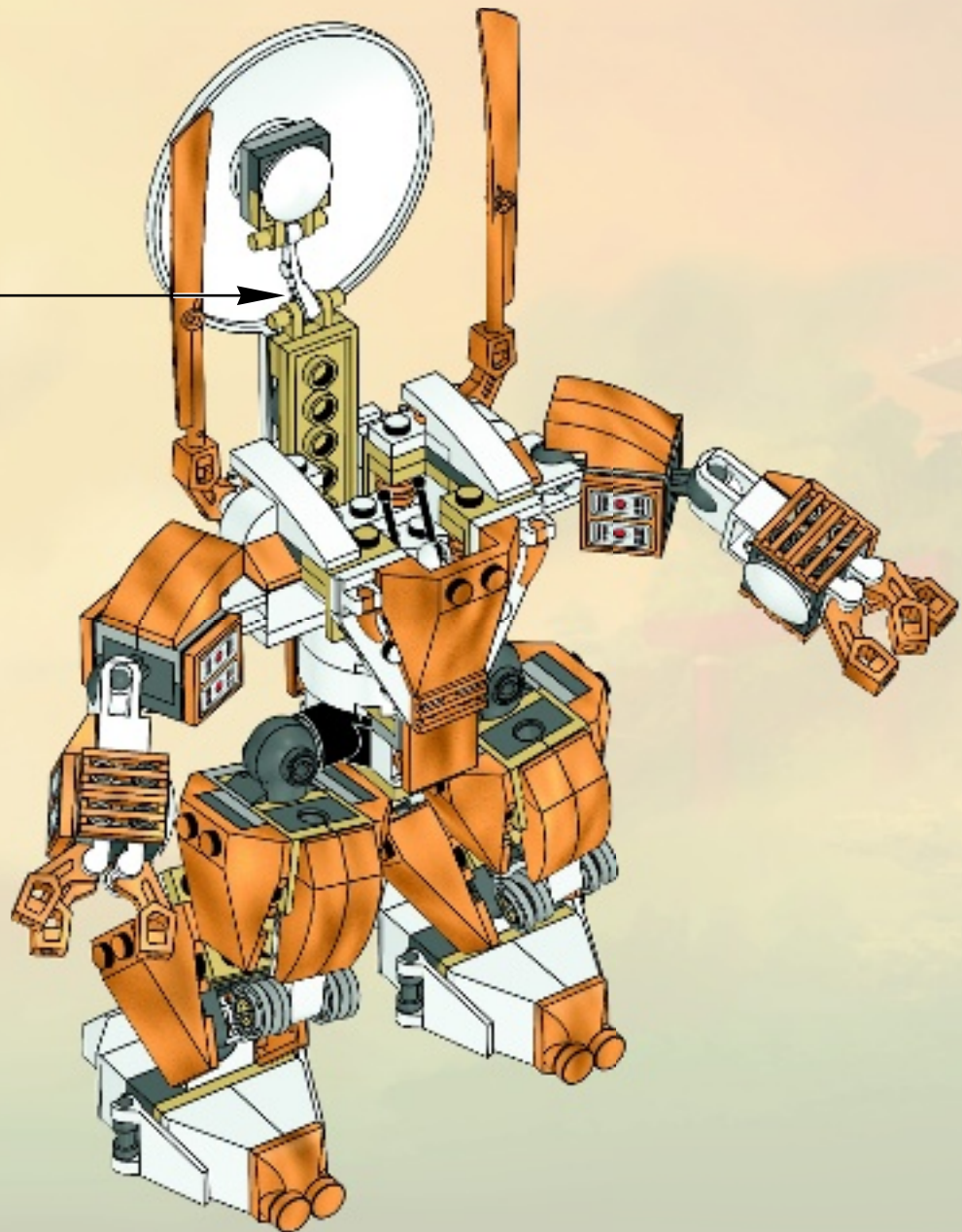
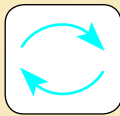

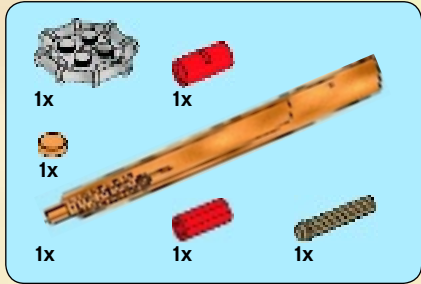

14

1

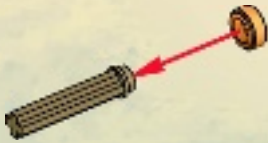

2



3



4

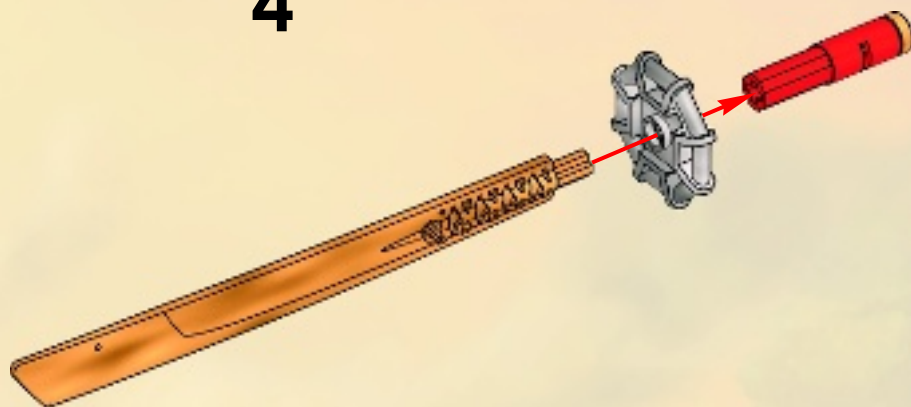

5

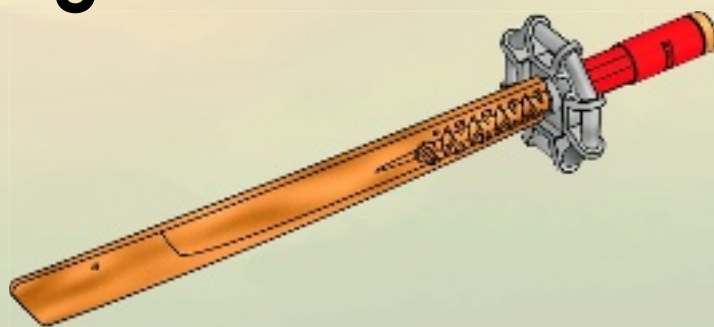

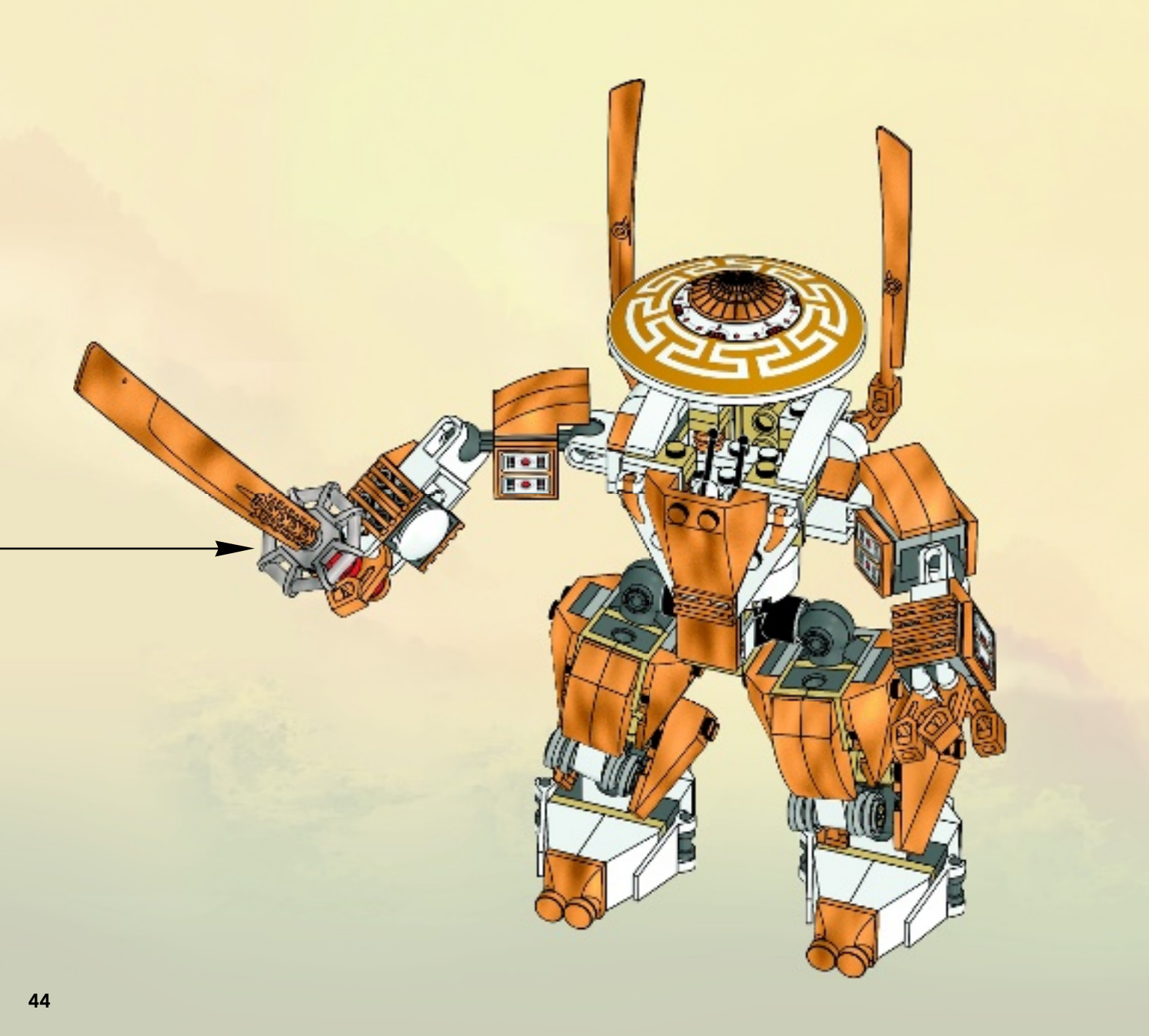



NINJAGO

Masters of Spinjitzu



LEGO

NINJAGO

Masters of Spinjitzu



AS SEEN ON TV



GET THE APP



LEGO.COM/NINJAGO



1



2



3

www.LEGOclub.com/Max

www.LEGOclub.com/Max



club™

FREE*! GRATIS! GRATUIT!

*Paid subscription in Australia and New Zealand.
*Abonnement payant en Australie et Nouvelle-Zélande.



WIN!

Go to www.LEGOsurvey.com/product to fill out a survey for a chance to win a cool LEGO® Product. No purchase necessary. Open to all residents where not prohibited.

 LEGO.com

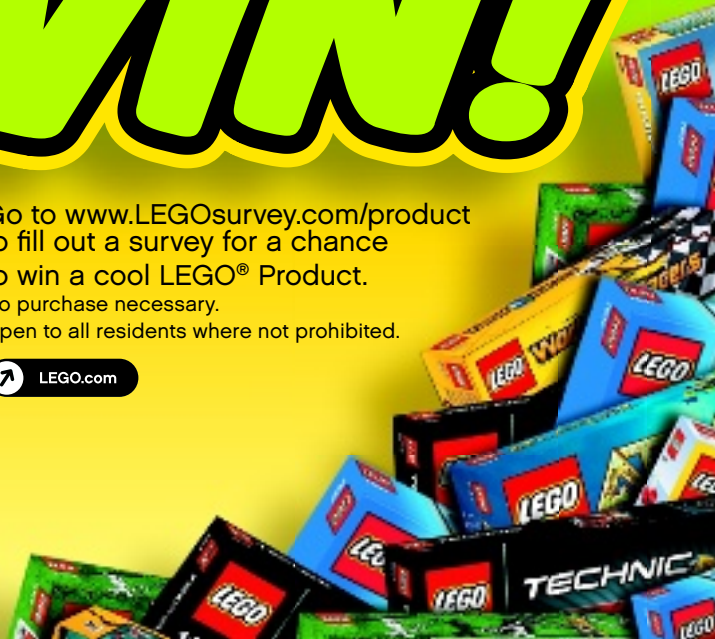

www.LEGOsurvey.com/product

GEWINNE! WIN!

Nimm an der Umfrage auf www.LEGOsurvey.com/product teil und hab die Chance ein cooles LEGO® Produkt zu gewinnen!

Die Teilnahme am Gewinnspiel führt zu keinerlei Kaufverpflichtungen. Teilnahme in allen nicht ausgeschlossenen Ländern möglich.

Ga naar www.LEGOsurvey.com/product, vul een enquêteformulier in en maak kans op een cool LEGO® product.

Geen aankoopverplichting. Iedereen mag deelnemen, uitgezonderd ingezetenden van landen waar een enquêteverbod geldt.

GAGNE! 当てよう!

Visite www.LEGOsurvey.com/product pour répondre à un questionnaire et avoir une chance de gagner un produit LEGO® très cool!

Aucune obligation d'achat. Ouvert à tous les résidents des pays autorisés.

www.LEGOsurvey.com/product にアクセスして、アンケートにご記入ください。当選者にはレゴ®製品を差し上げます。

お買い上げの必要はありません

禁止されていない限り、すべての皆様にご利用いただけます。