



LEGENDS OF

# CHIMA

TM

70220



1



2



3



4





**1**



**2**

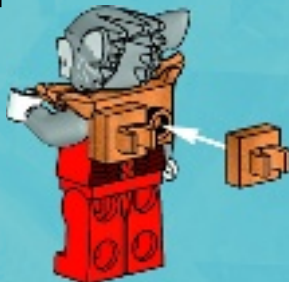

**3**

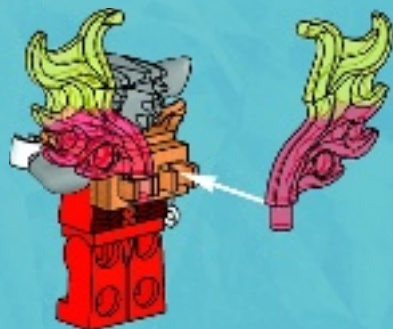

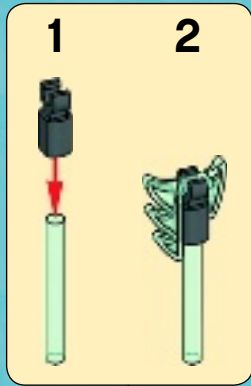
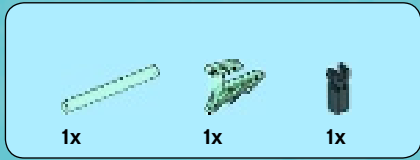
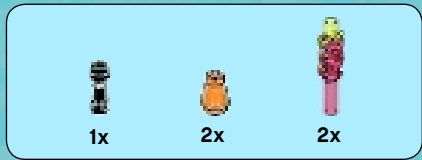

4

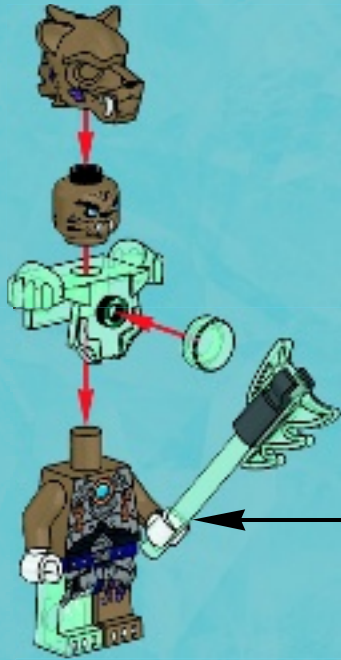

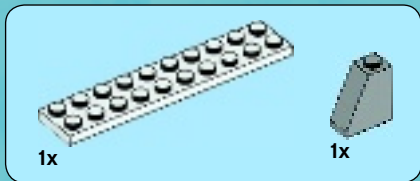
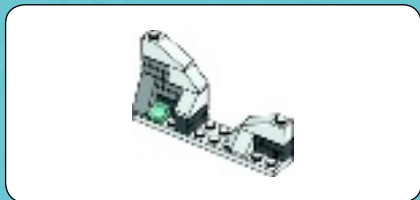

1

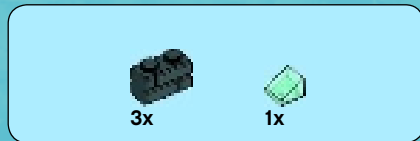
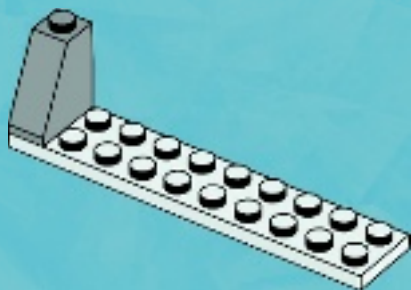

2





1x



1x



1x

3

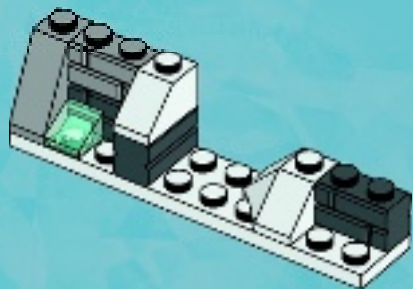

1x



1x

4

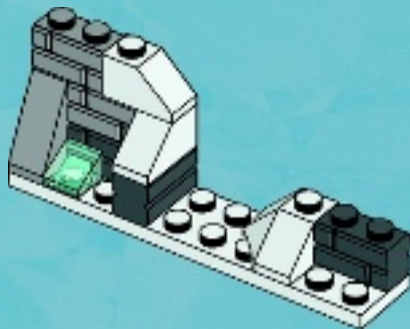



2x

5

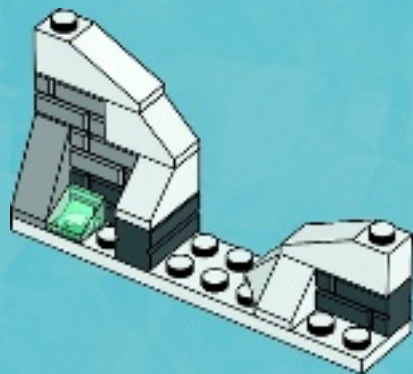

6



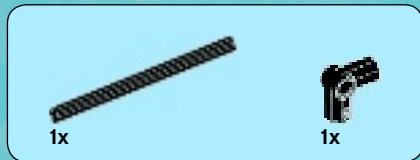
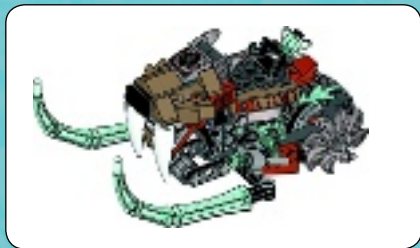

**1**

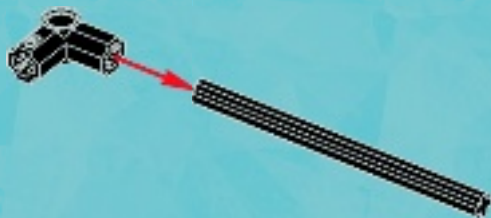
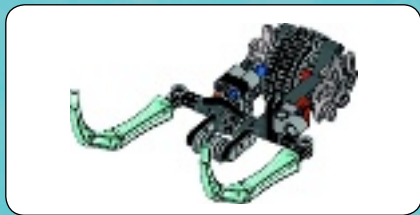





2

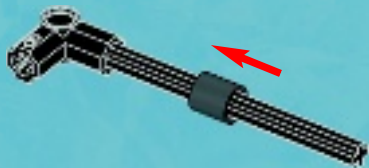

3

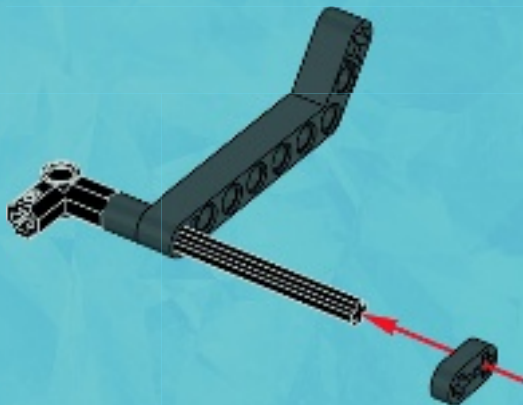



1x

4

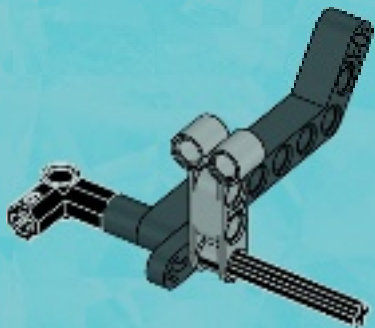

1x



1x

5

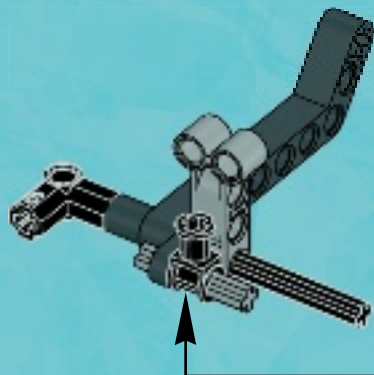

1



2





1x

6

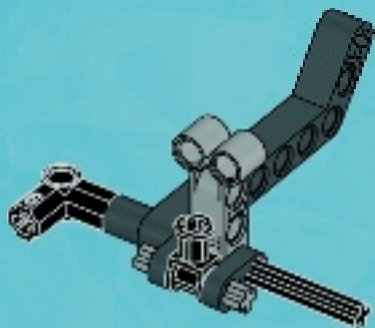

1x

7

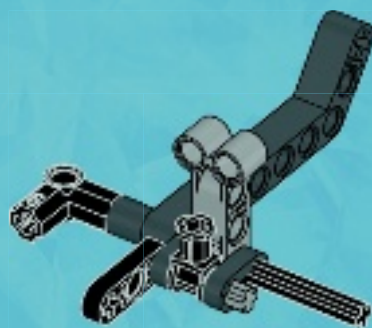



1x

8

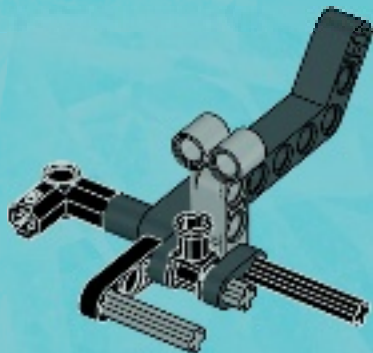

2x



1x

9

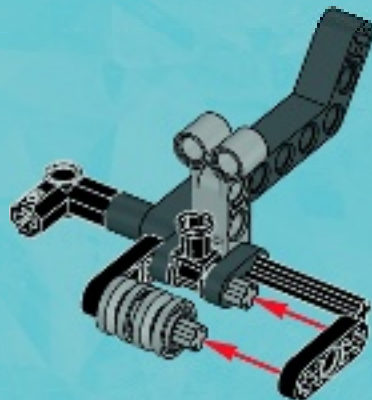

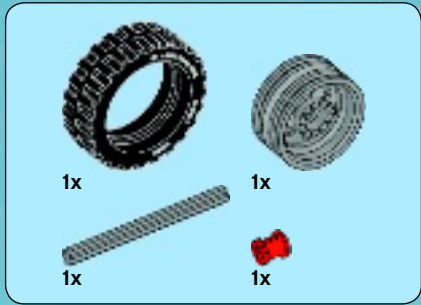

10

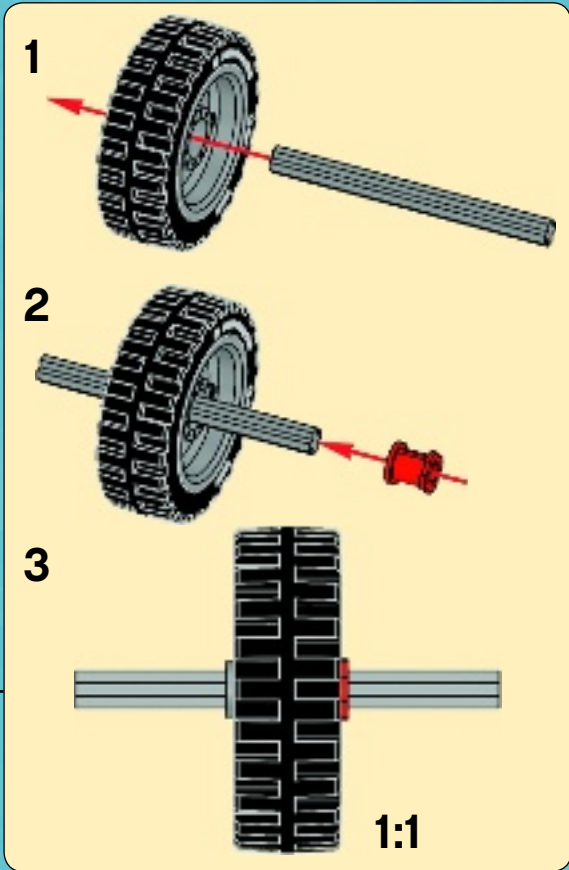
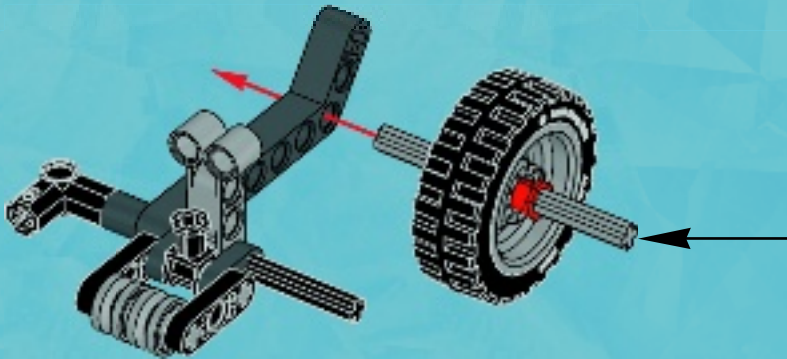



11

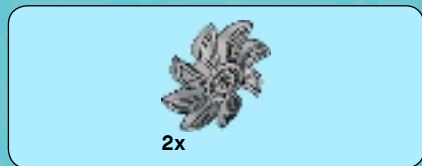
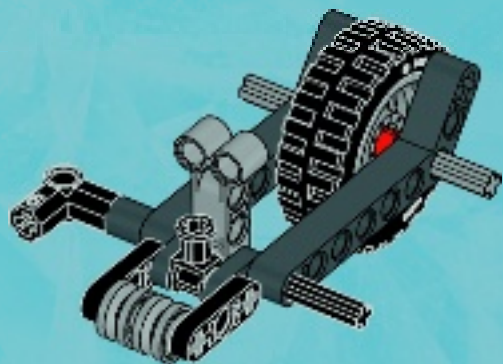

12

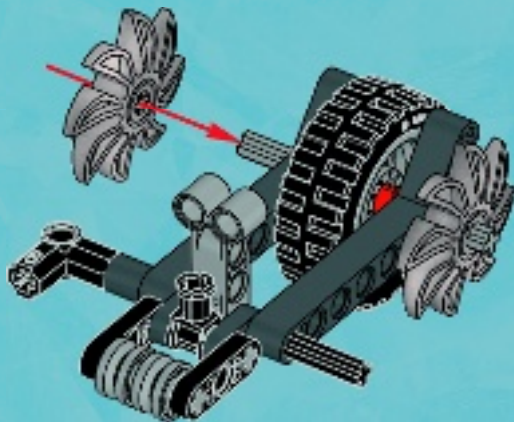



# 13

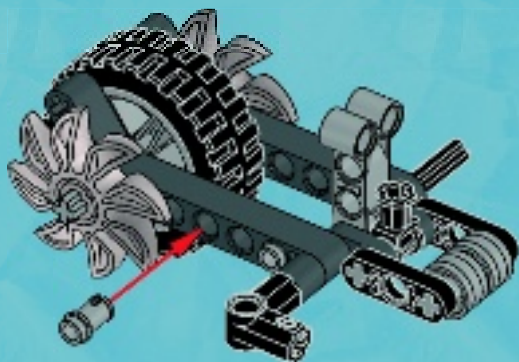

# 14

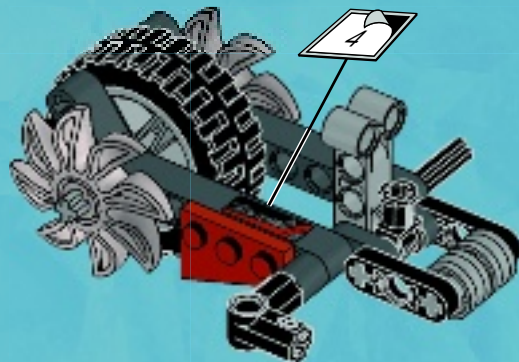



2x

# 15

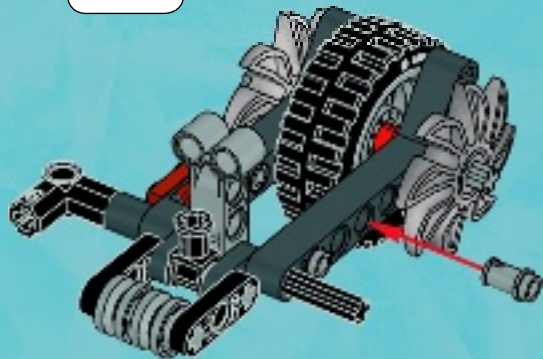
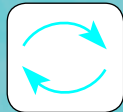

16



1x

# 16

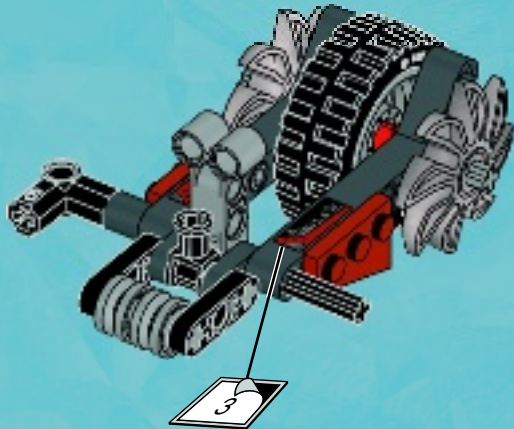





2x



1x

# 17

1

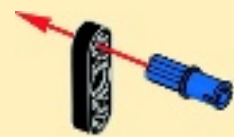

2

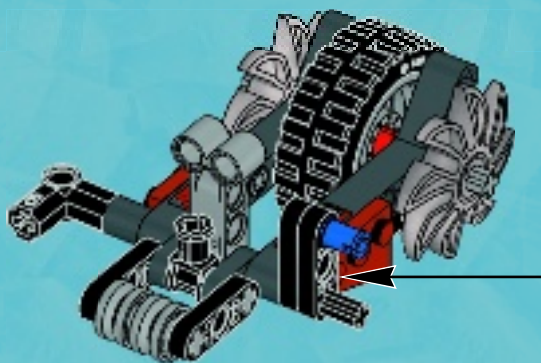
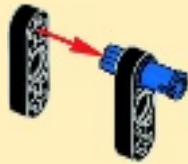

1x

# 18

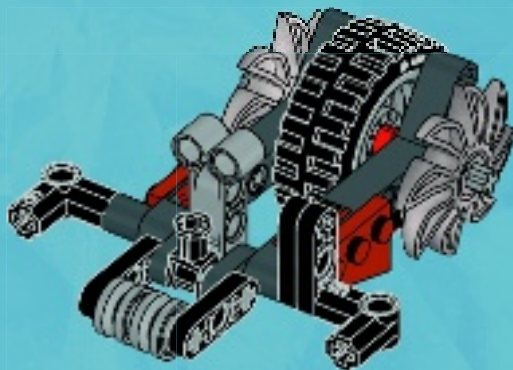



1x



1x

# 19

1



2

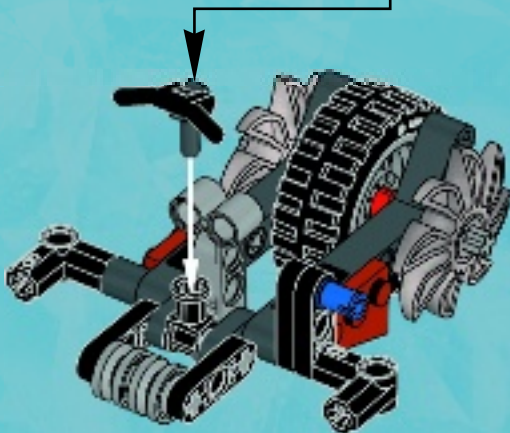

1x



1x

# 20

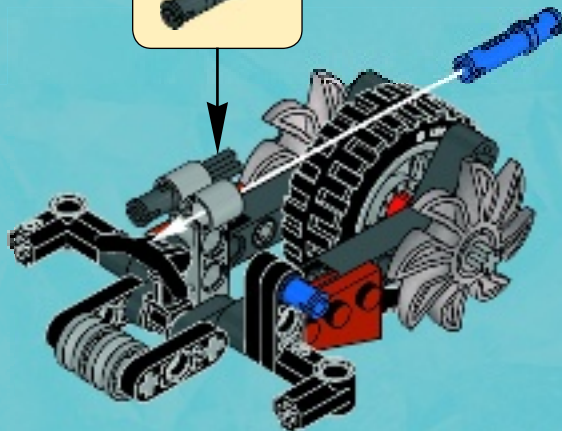



1x

# 21

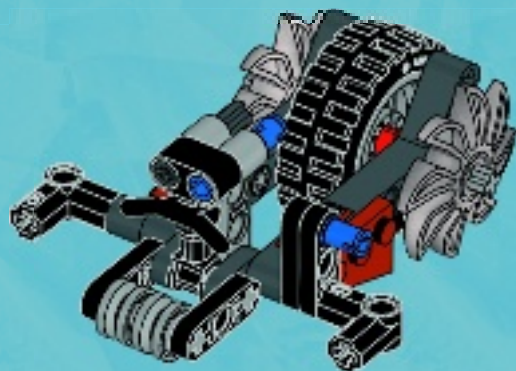

1x

# 22

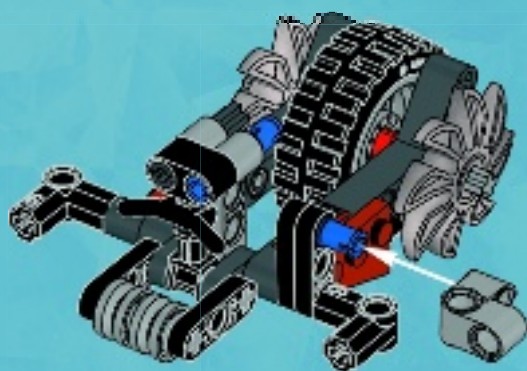



2x

23

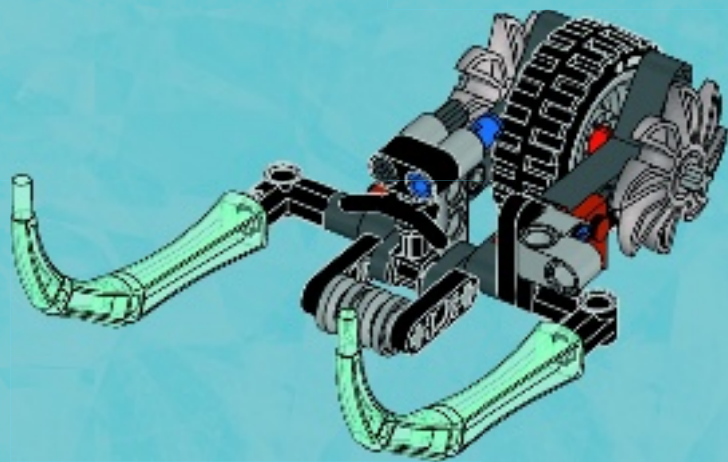



1



2





1x



1x

# 3

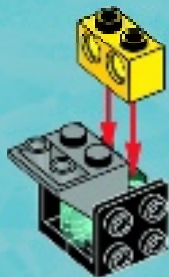

1x

# 4





1x

5



1x

6





4x

7

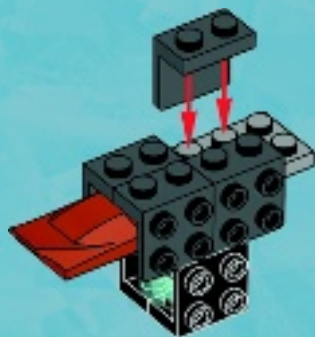

1x

8

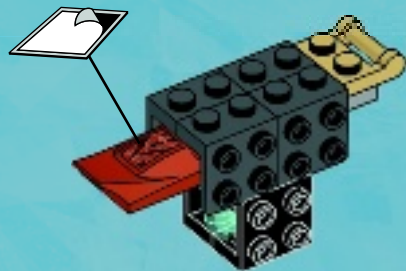





9

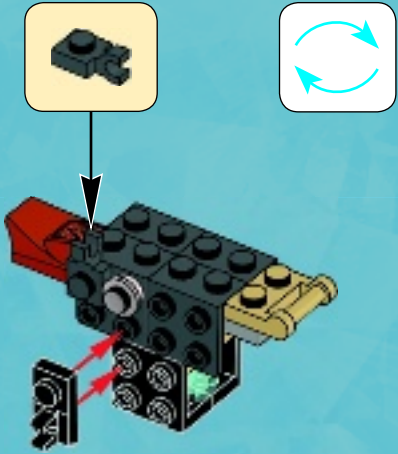

10

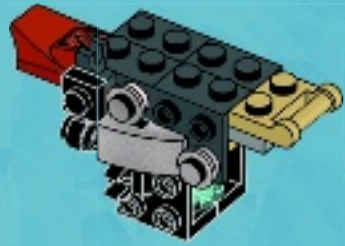



1x

# 11

1

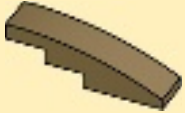

2

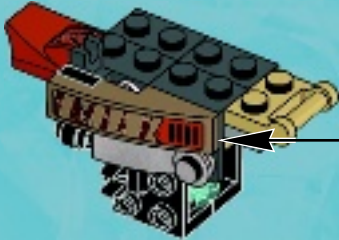
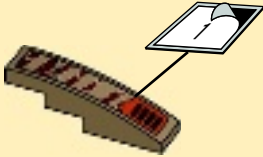

1x



1x

# 12





1x



1x



1x

# 13

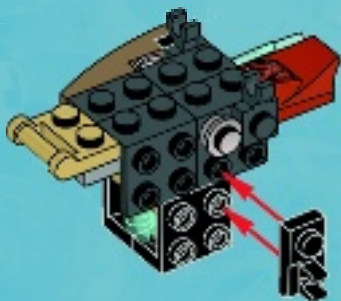

1x



1x



1x

# 14

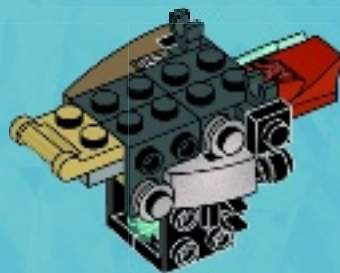



1x

# 15

1

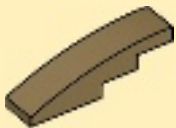

2

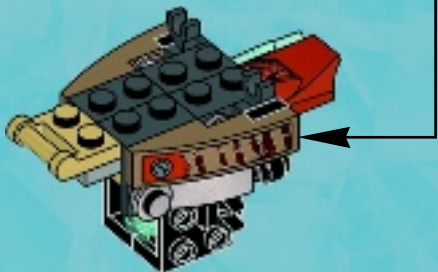
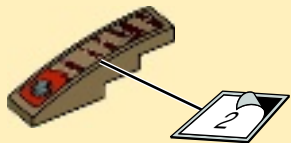

1x



1x

# 16





1x



2x

# 17



1x



1x

# 18

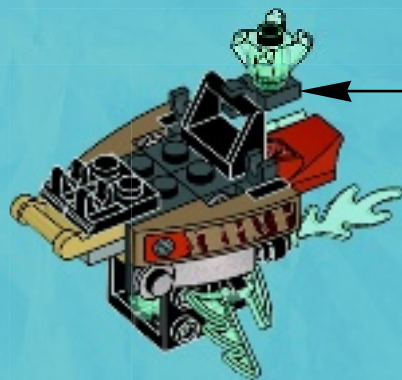
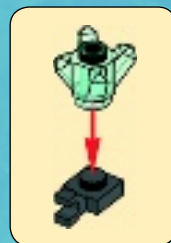



# 19

1



2

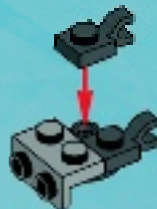

3





4

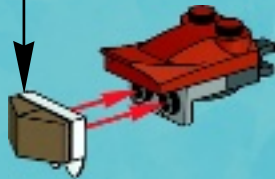

5

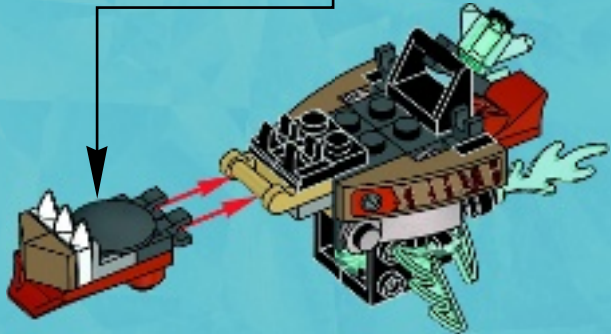



1x

1x

1

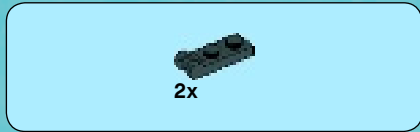

2x

2



2x

3







1x

4



2x



2x

5

1



2



2x

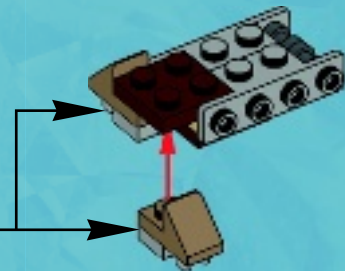



1x



2x



1x

# 6

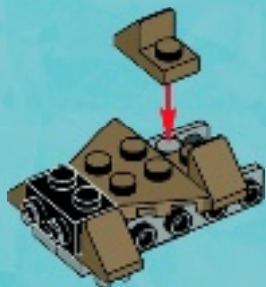

2x



1x



2x

# 7





2x

8



1x

9





1x

10

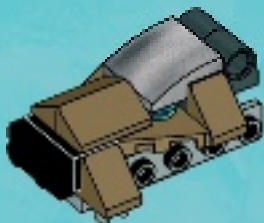

1x

11

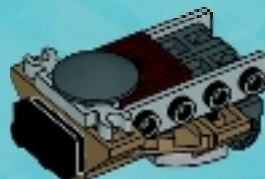



12

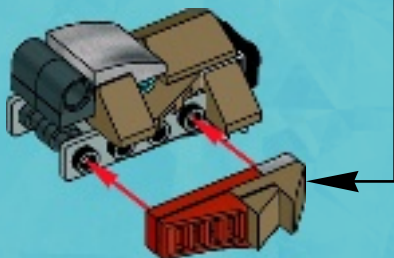
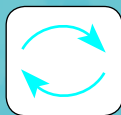
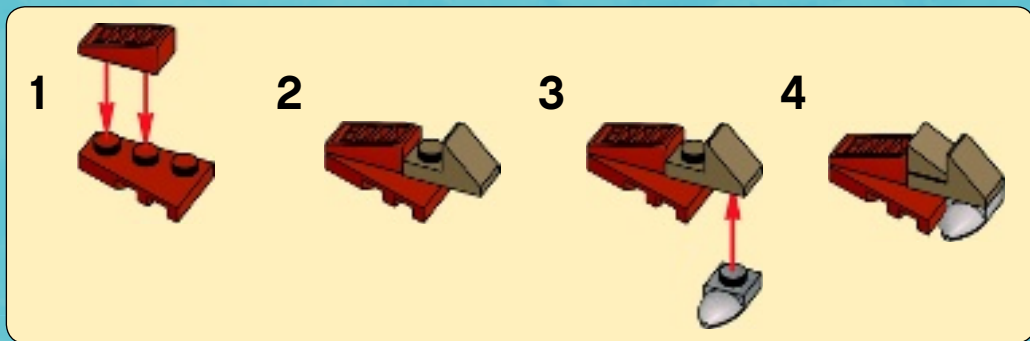



13

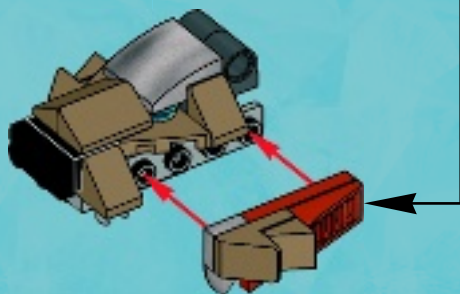
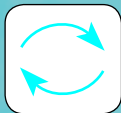
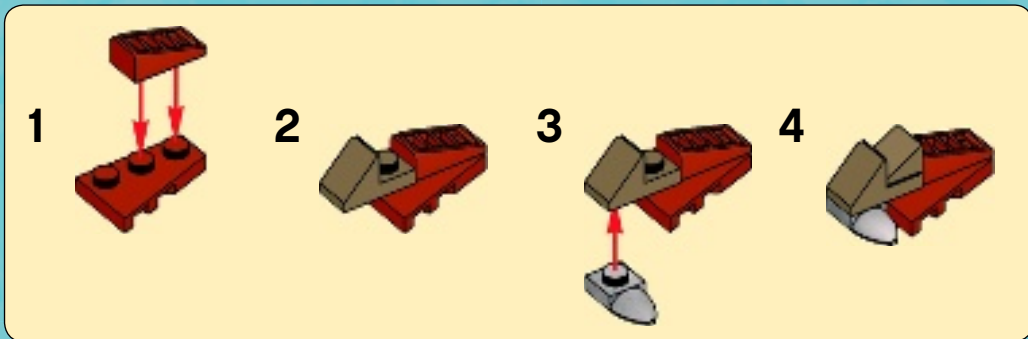



2x

14

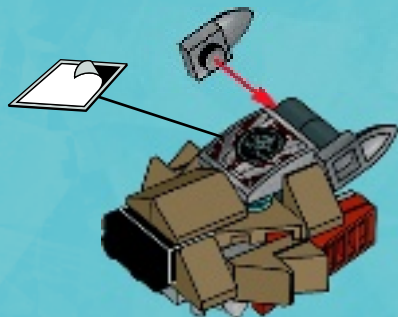

2x

15



20

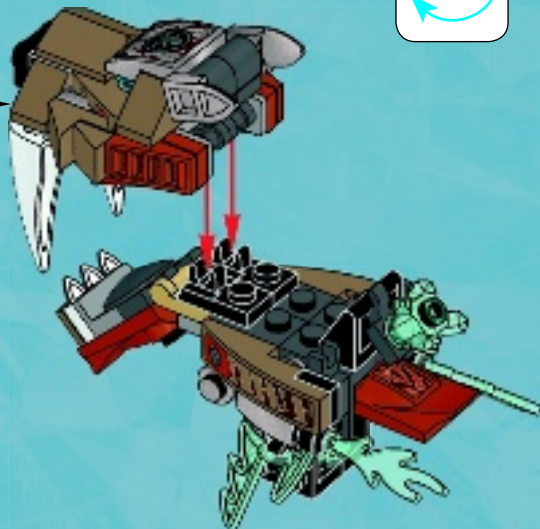
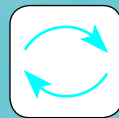



21

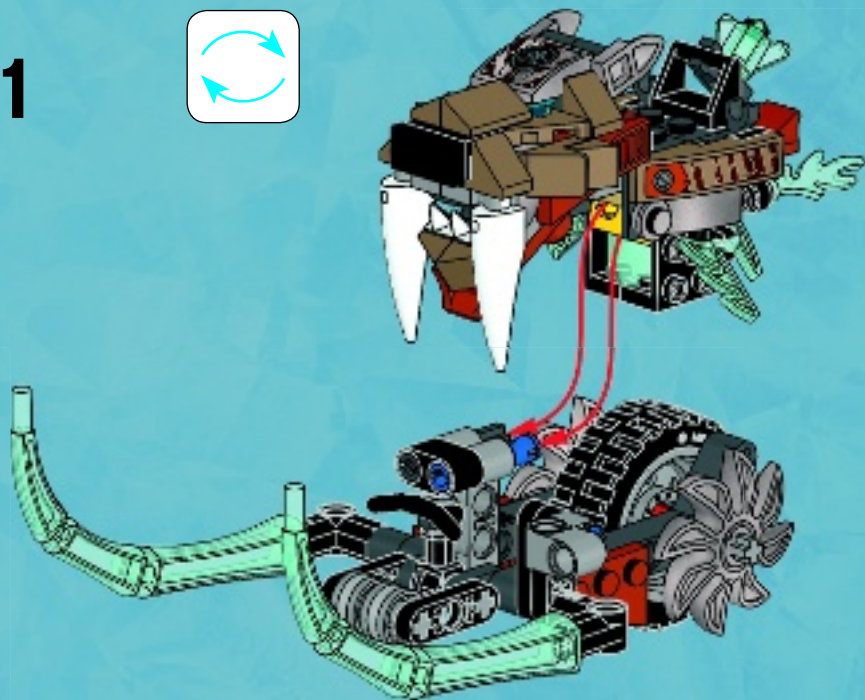
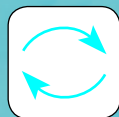



1x



1x



# 22

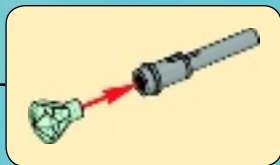
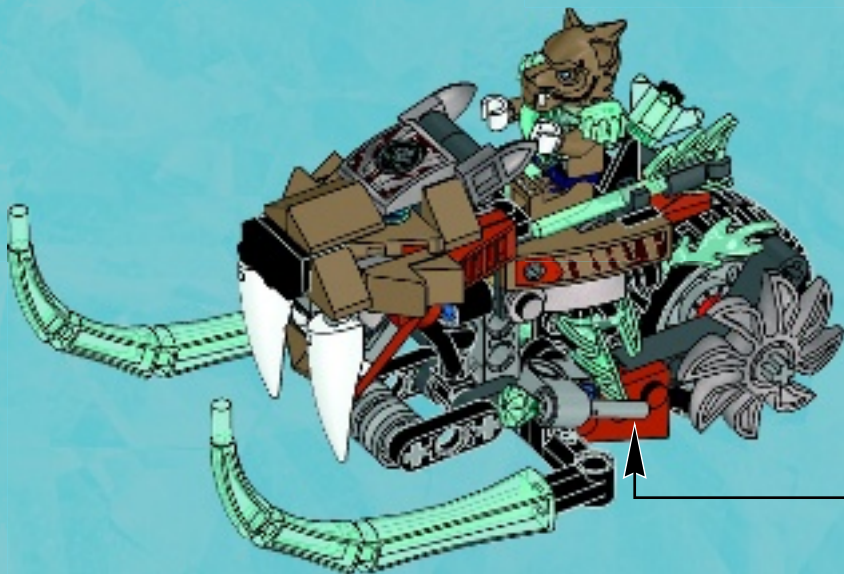

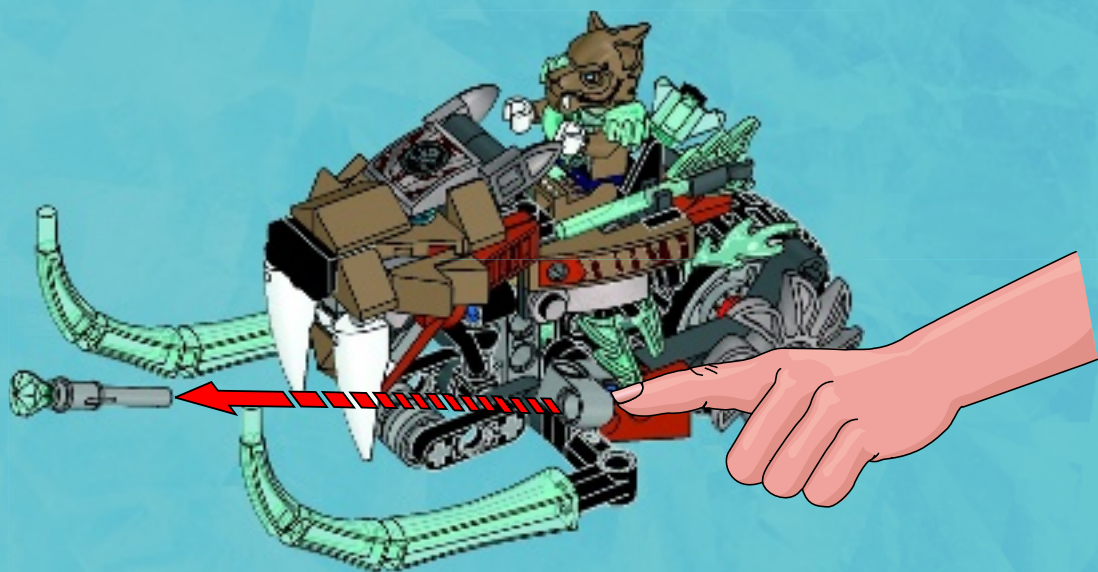

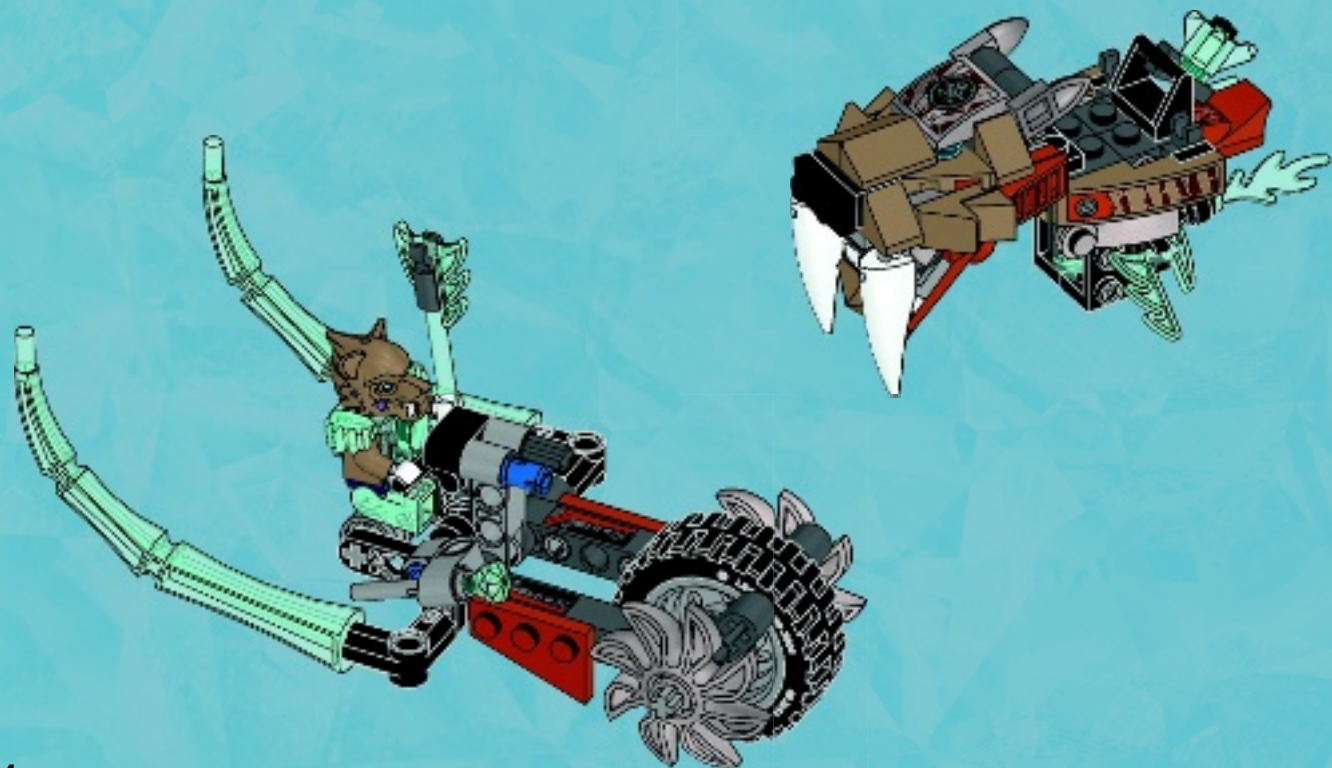



**Customer Service**  
**Kundenservice**  
**Service Consommateurs**  
**Servicio Al Consumidor**

[LEGO.com/service](http://LEGO.com/service) or dial

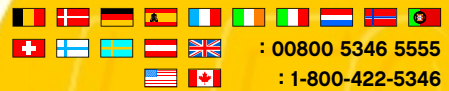

: 00800 5346 5555  
 : 1-800-422-5346



# club

TM

**JOIN FREE TODAY!**



## **MAGAZINE INCLUDES:**

- ▶ Building Ideas and Game Tips
- ▶ Kids' Creations
- ▶ Comic Adventures

**JOIGNEZ-VOUS GRATUITEMENT !**



## **LE MAGAZINE COMPREND :**

- ▶ Des idées de construction
- ▶ Des créations super cool
- ▶ Des bandes dessinées

**LEGO.com/club | 1-877-518-5346**





LEGENDS OF

# CHIMA™

TM



70223



70224

THE ULTIMATE  
BATTLE  
FOR CHIMA  
LA BATAILLE  
SUPREME  
POUR CHIMA  
LA BATALLA  
DEFINITIVA  
POR CHIMA



LEGENDS OF  
**CHIMA**™



**WARZ**

70220



**GURZAN**

70222



**CROCKENBURG**

70231



**TAZAR**

70224



**FLINX**

70221



**RAZAR**

70223



**ERIS**

70224



**L'ELLA**

70229



**TRAKKAR**

70224



**TORMAK**

70222





**REEZOR**

70224



**ULKAR**

70223



**SIR FANGAR**

70224



**SIBRESS**

70224



**ICEBITE**

70223



**ICECLOT**

70230



**SIROX**

70232



**ICEPAW**

70223



**STRAINOR**

70220



**VOOMVOOM**

70221



**SYKOR**

70222



# LEGENDS OF CHIMA™

70231



70224



70229



70223



70232



70230

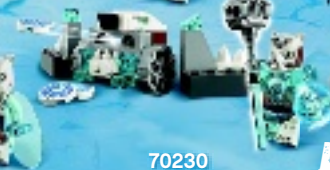

70229



70230



70231



70232

[LEGO.COM/CHIMA](http://LEGO.COM/CHIMA)



# LEGENDS OF CHIMA™

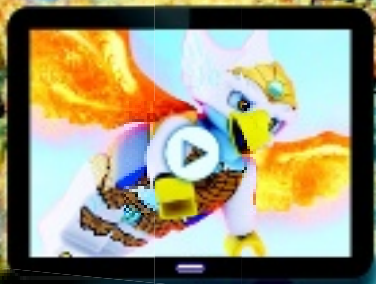

...Or visit: - Ou visitez : - O visita:

# LEGO.COM/CHIMA



Apple, the Apple logo, iPad, iPhone and iPod touch are trademarks of Apple Inc., registered in the U.S. and other countries. App Store is a service mark of Apple Inc./Apple, le logo Apple, iPad, iPhone et iPod touch sont des marques de commerce d'Apple Inc., déposées aux États-Unis et dans d'autres pays. App Store est une marque de service d'Apple Inc./Apple, el logotipo de Apple, iPad, iPhone e iPod touch son marcas comerciales de Apple Inc. registradas en EE. UU. y otros países. App Store es una marca de servicio de Apple Inc. Google Play is a trademark of Google Inc./Google Play est une marque de commerce de Google Inc./Google Play es una marca comercial de Google Inc.