



DC UNIVERSE™

SUPERHEROES



6864



TM

1

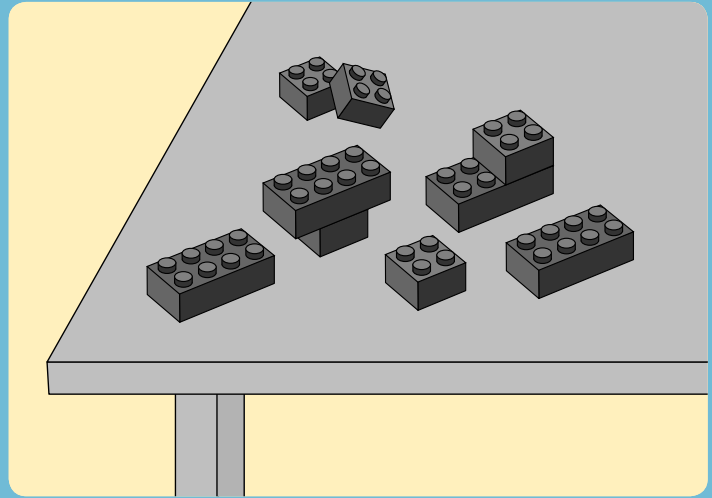
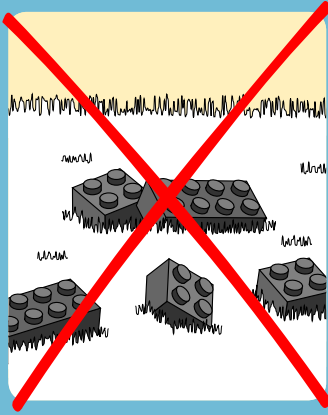

2

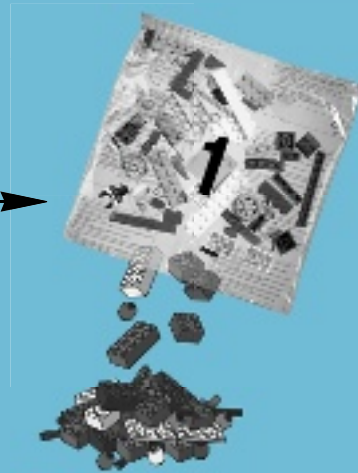

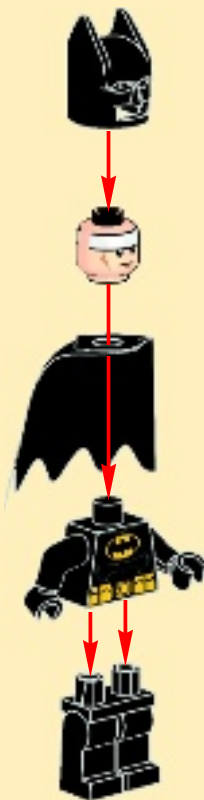



1

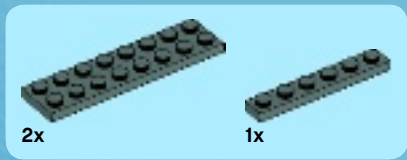
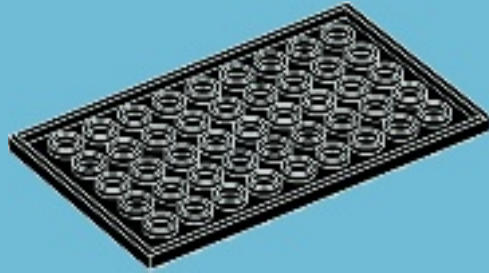

2

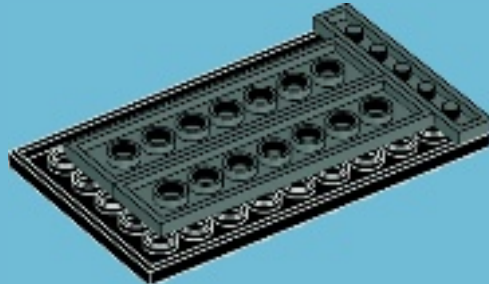



1x

3

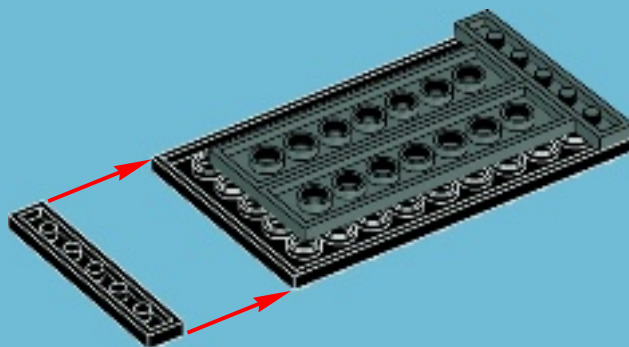

2x

4

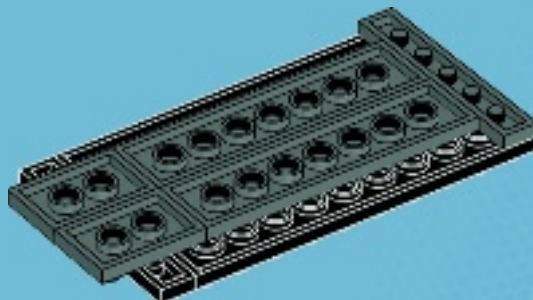



5

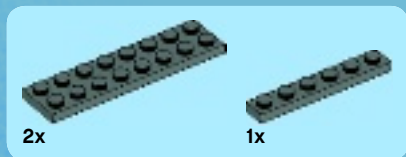
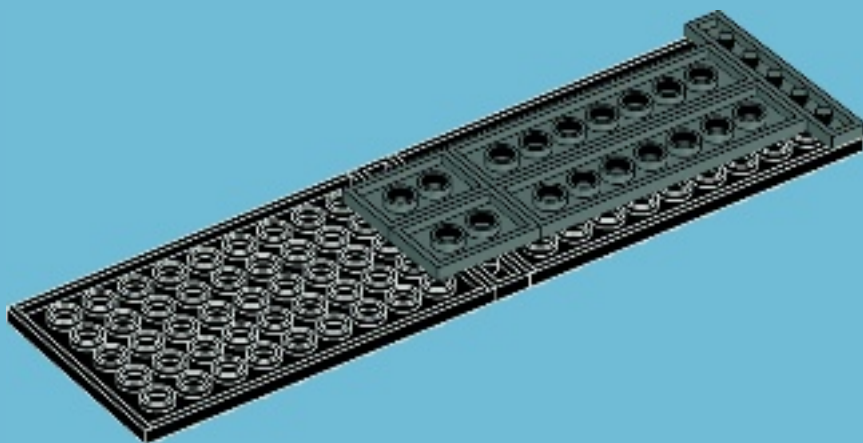

6

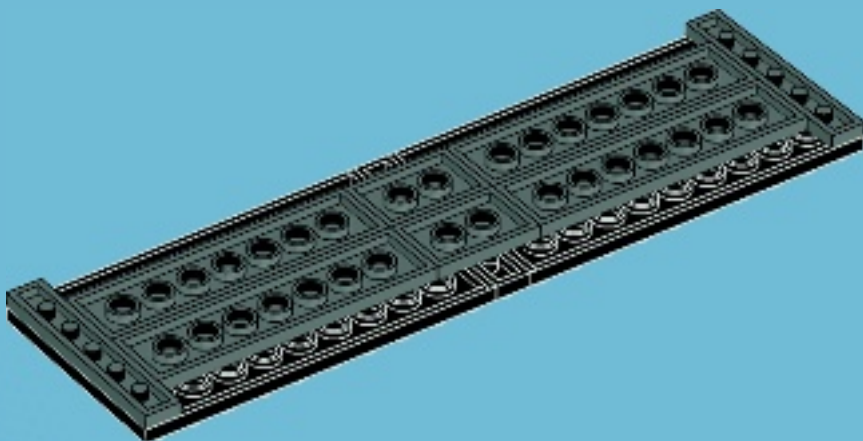



7

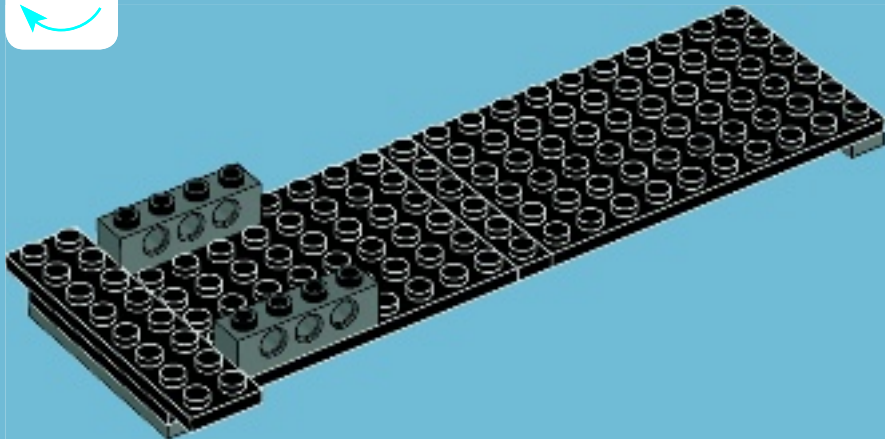

8

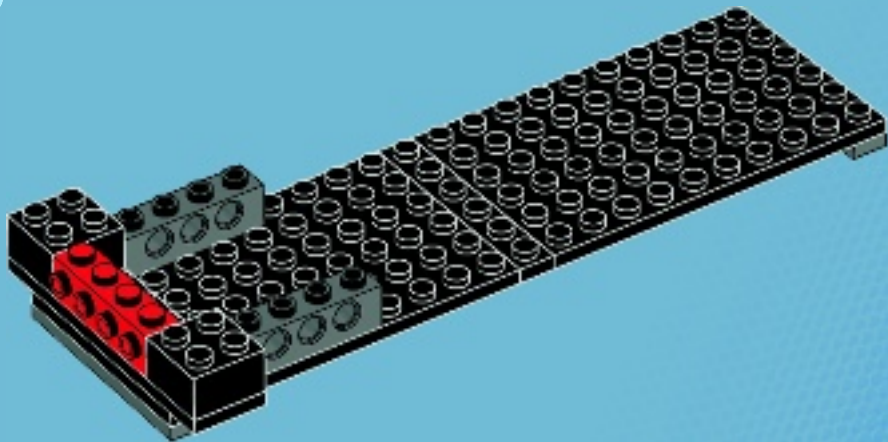

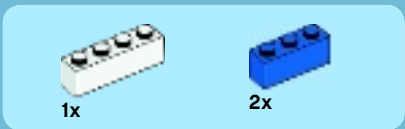

9

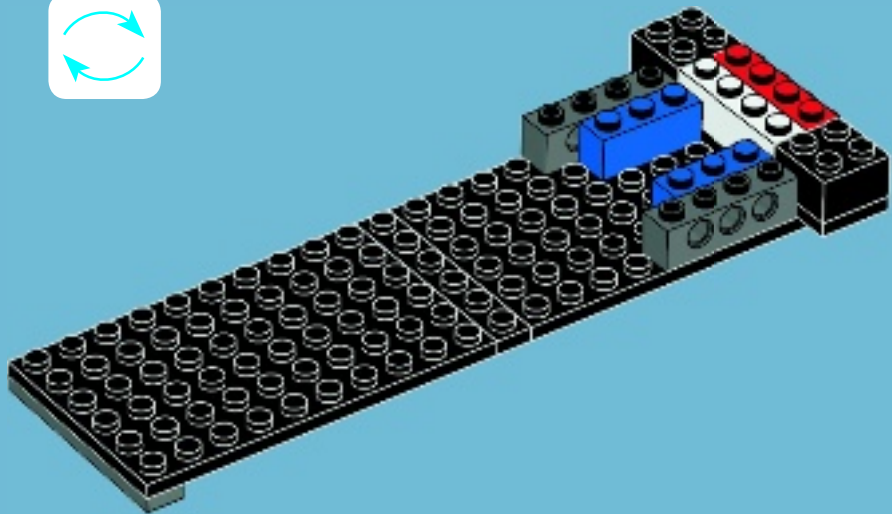

10

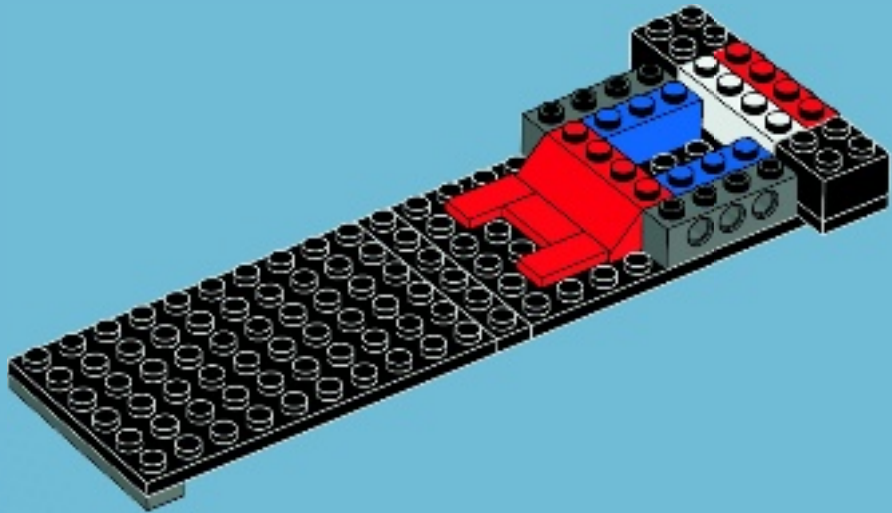



1x



1x

11

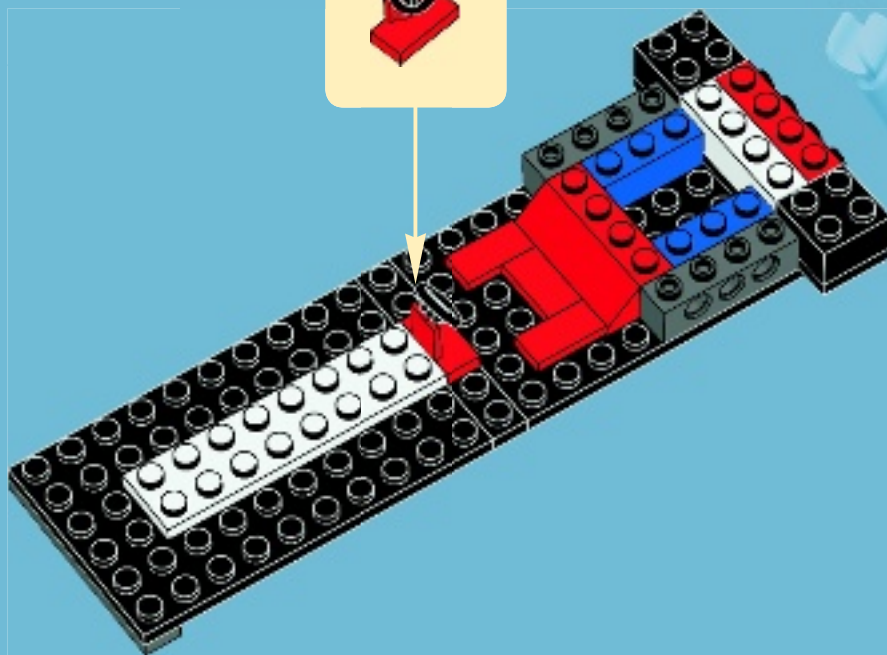

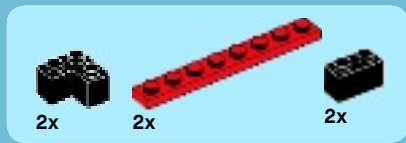

12

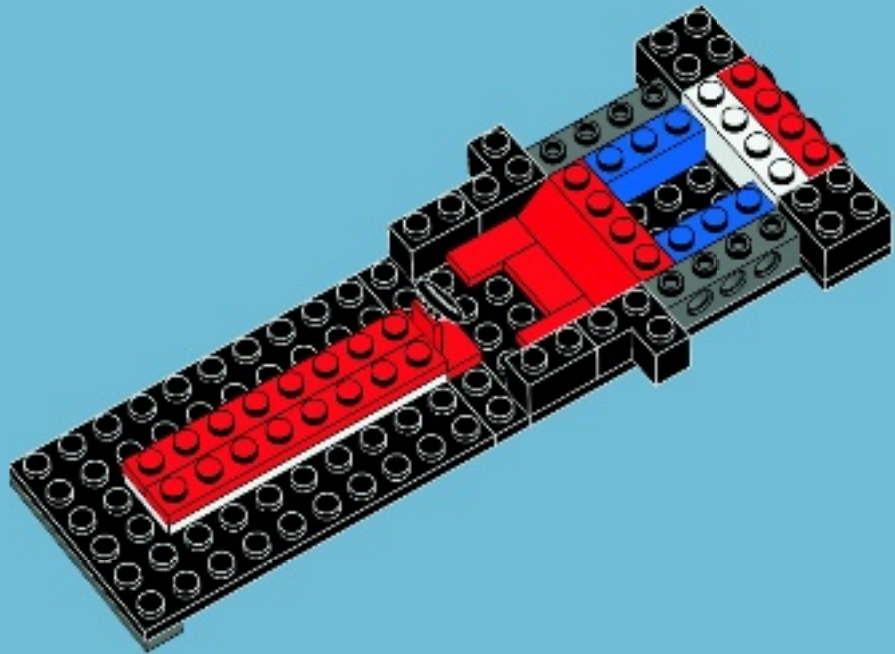

13

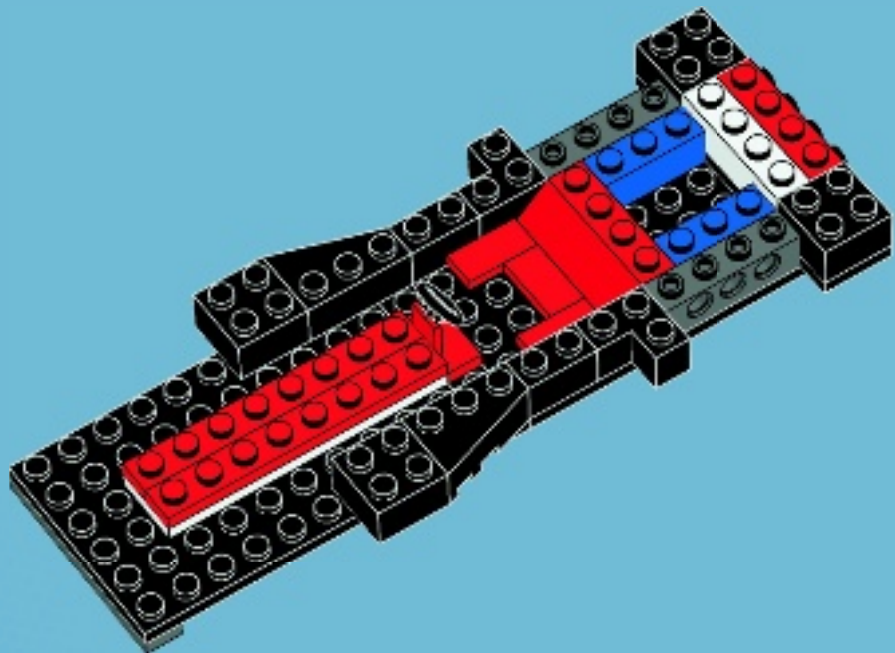

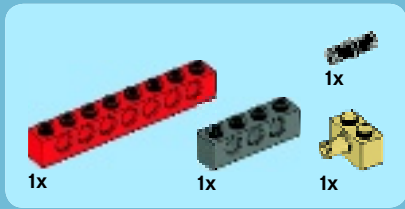

14

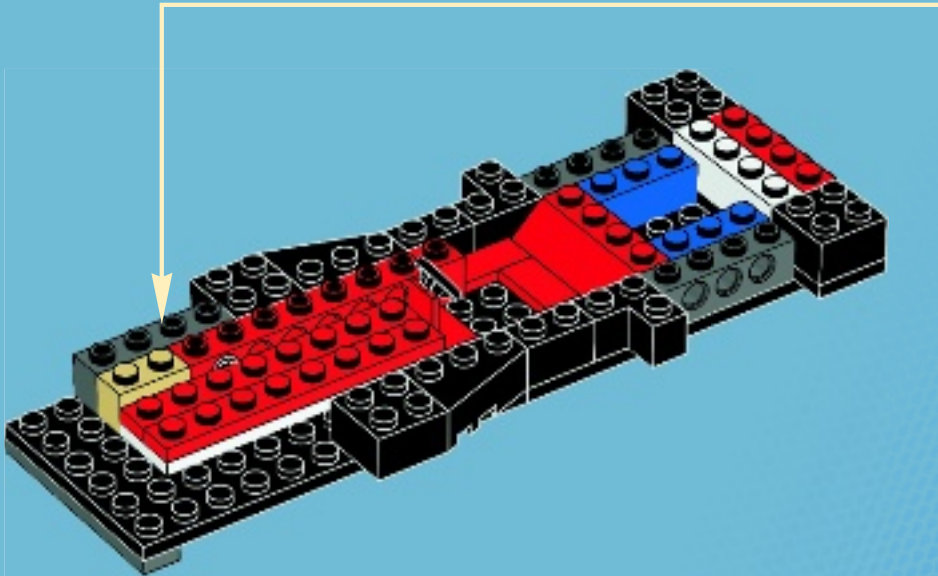
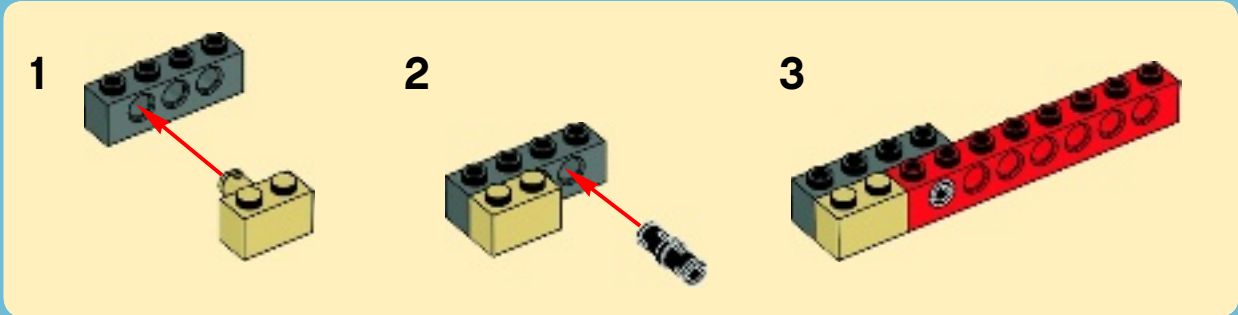

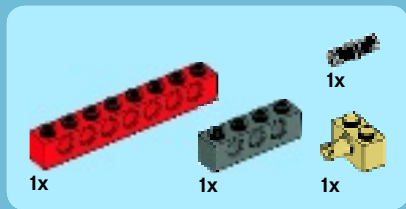

15

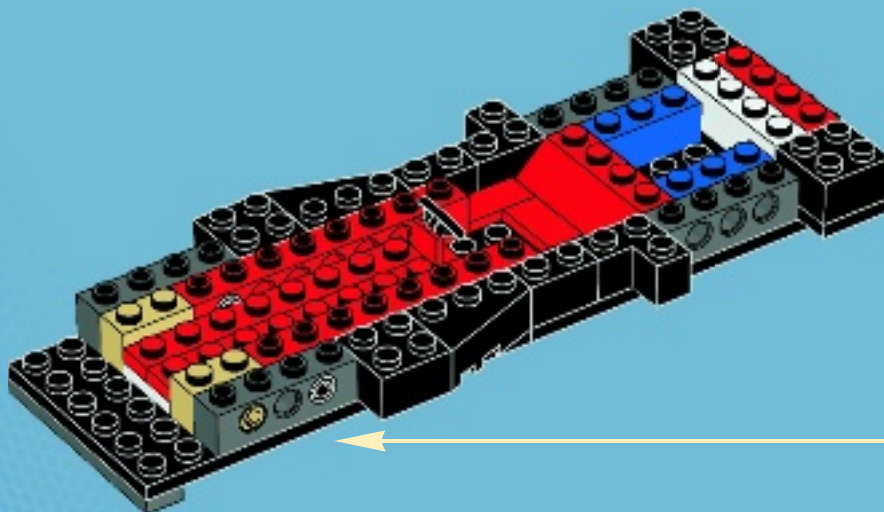
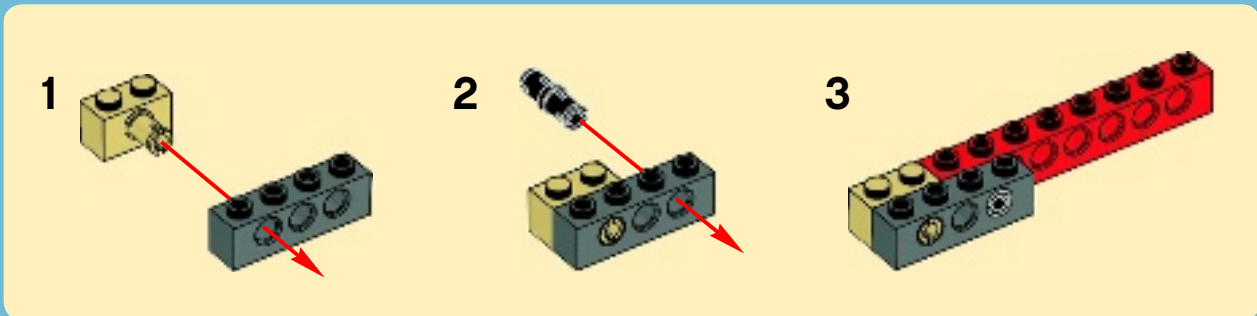



1x

16

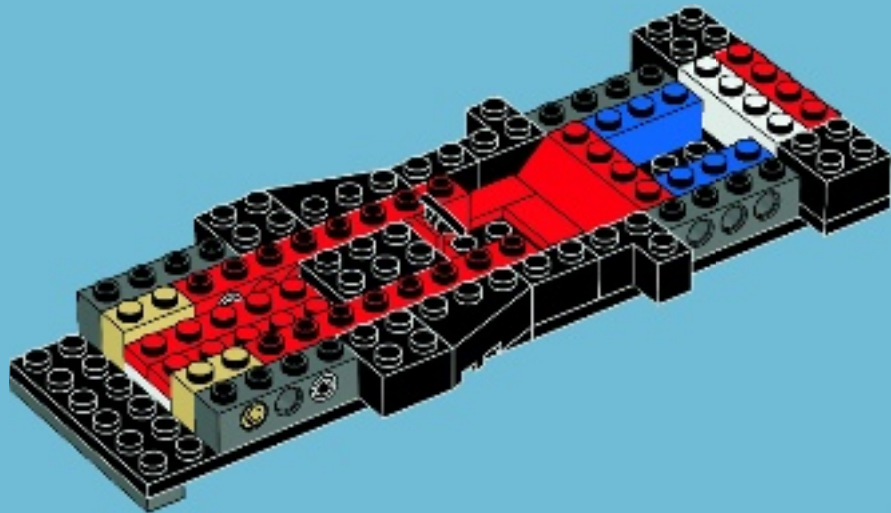

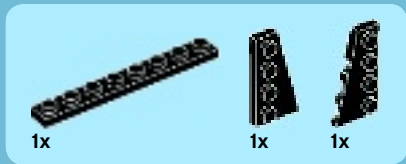

17

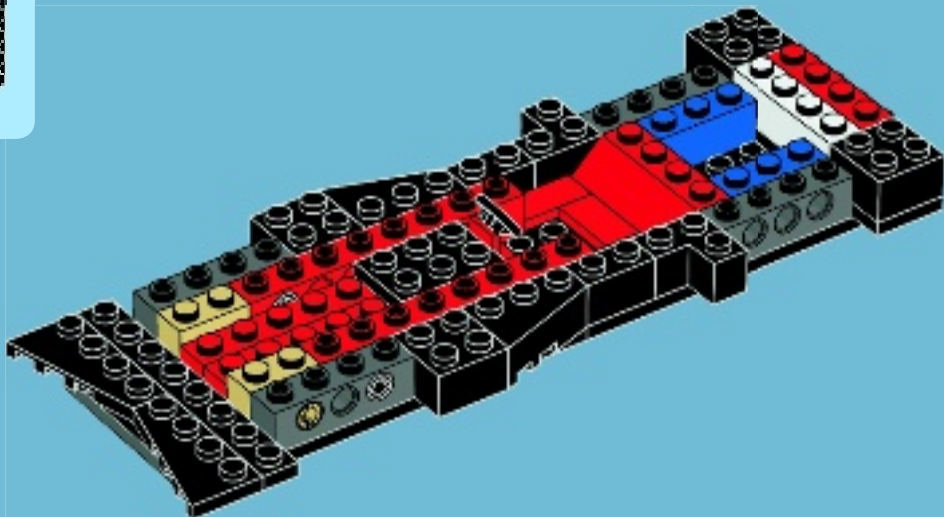

18

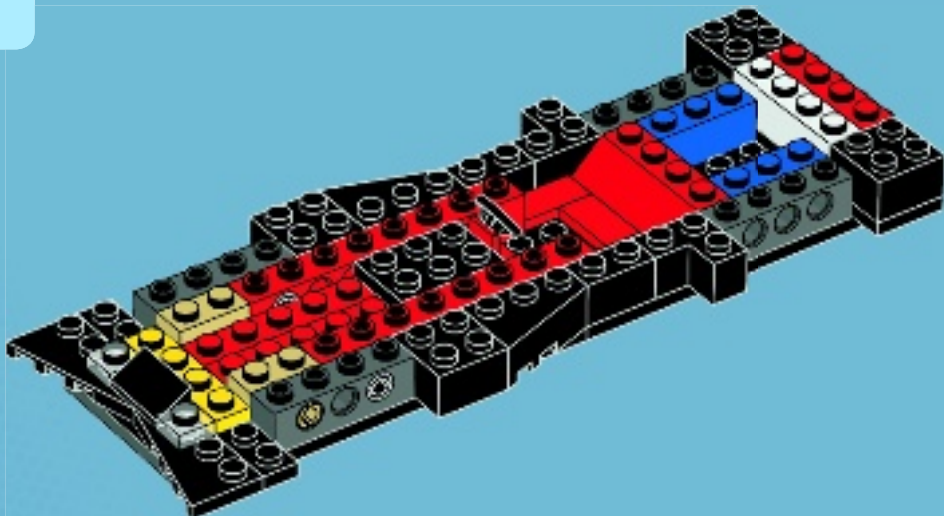



19

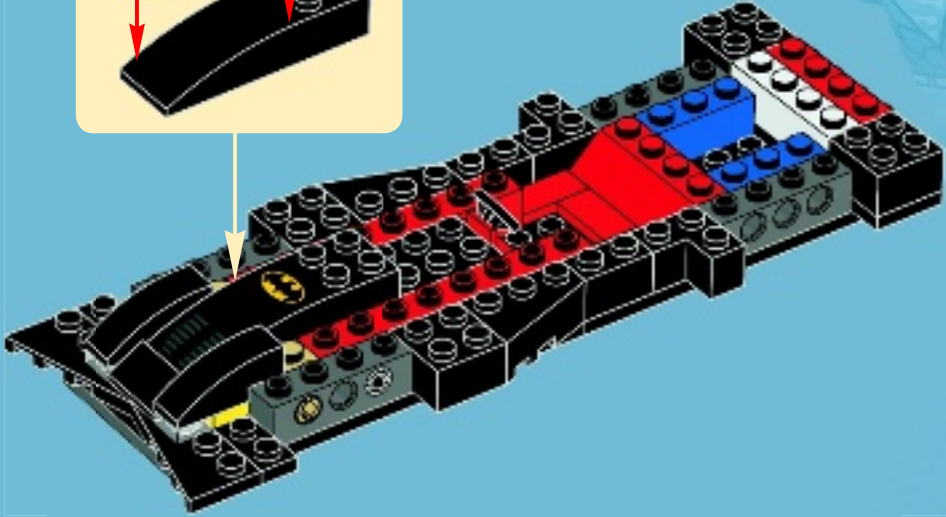

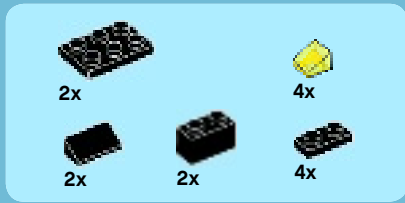

20

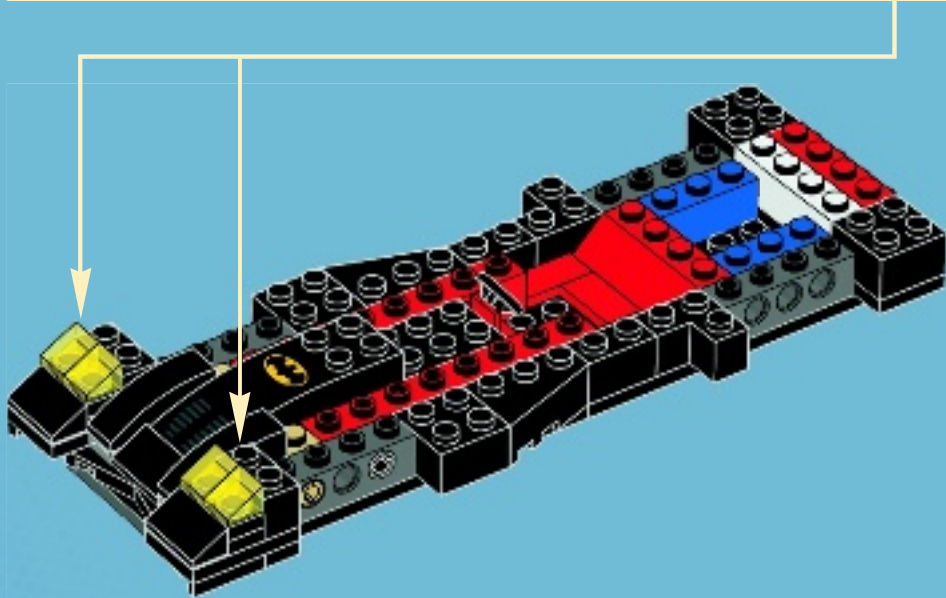
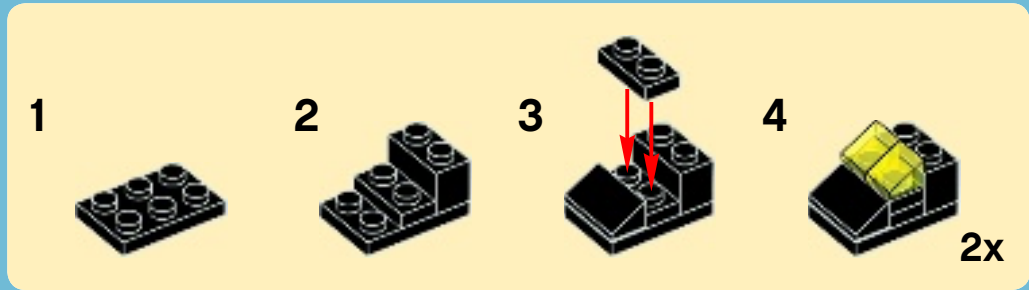



2x



1x

21

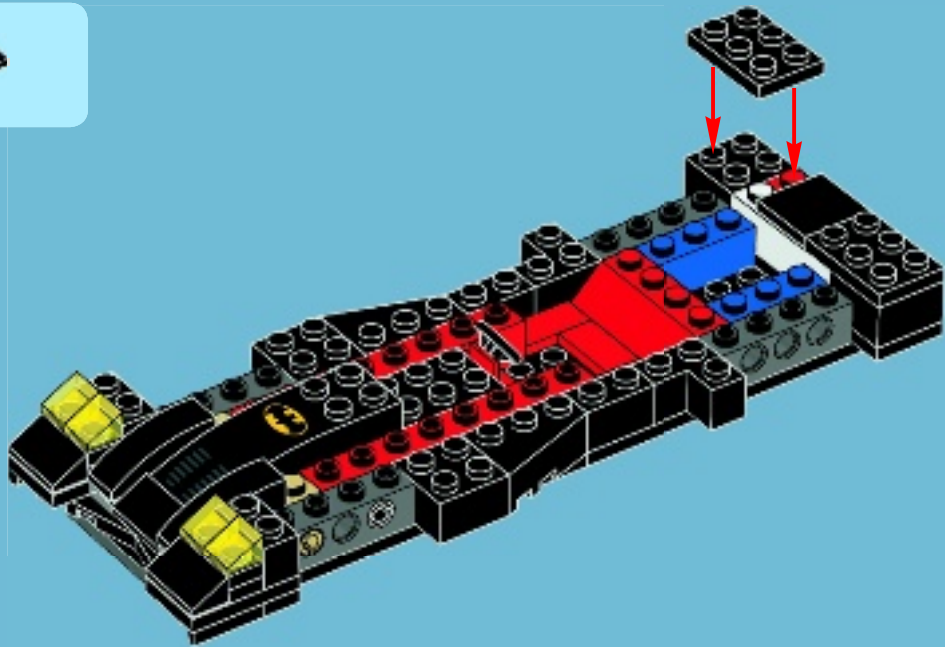

2x

22

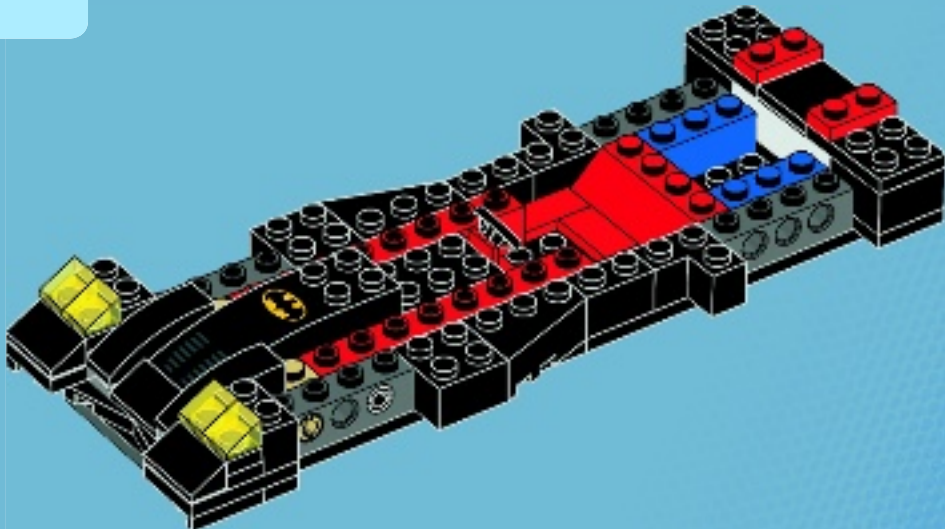

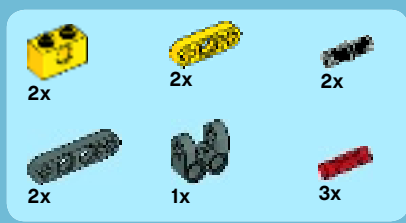

23

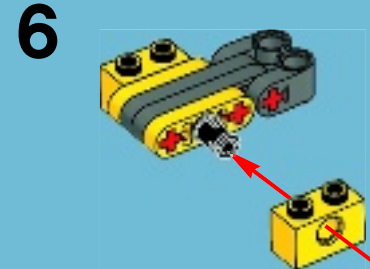
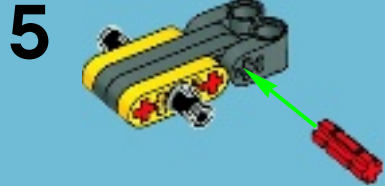
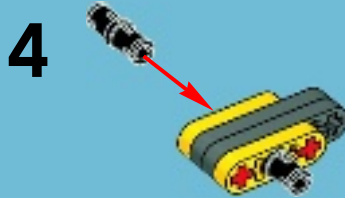
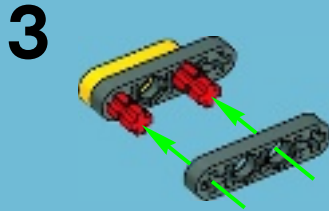

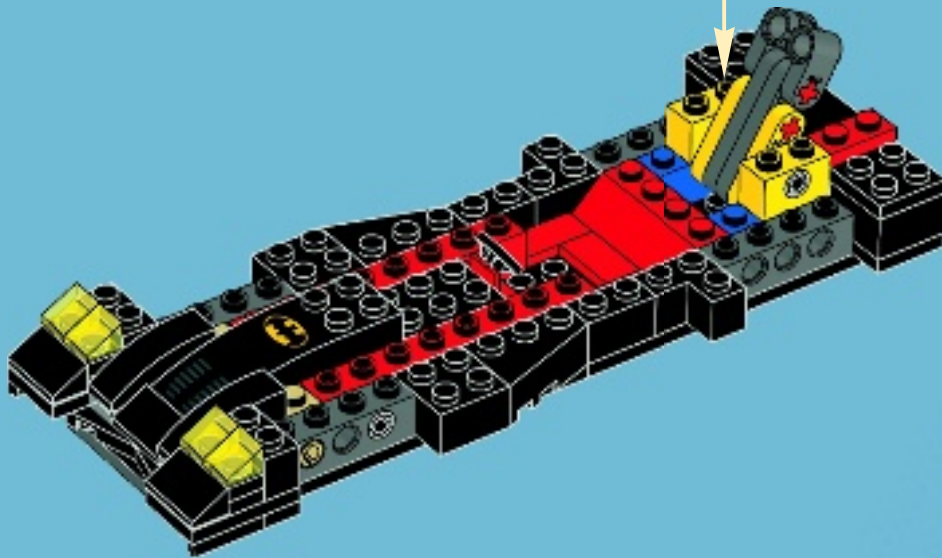
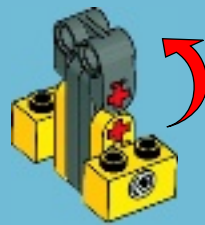



2x



1x

24

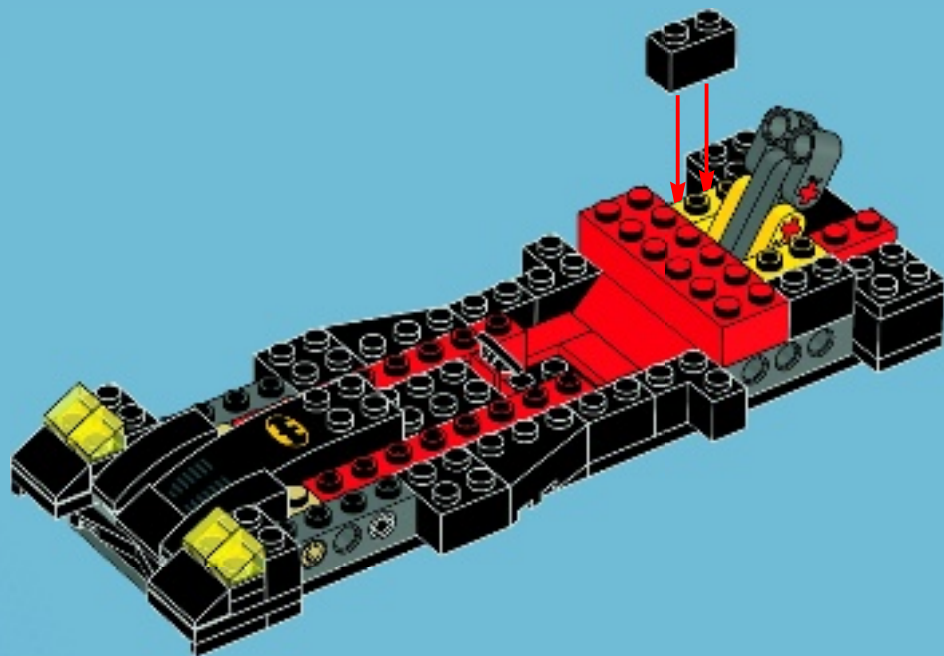



2x



2x



1x

25

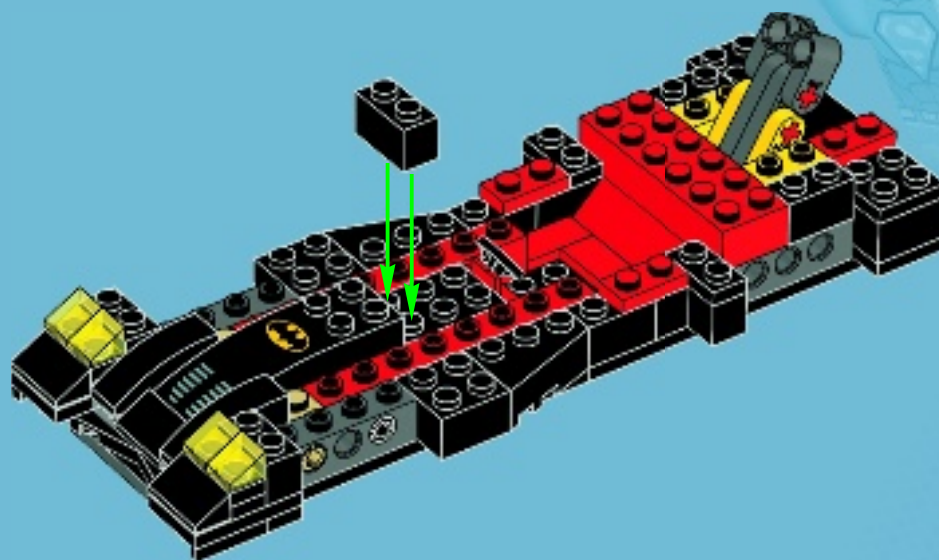



2x



2x

26

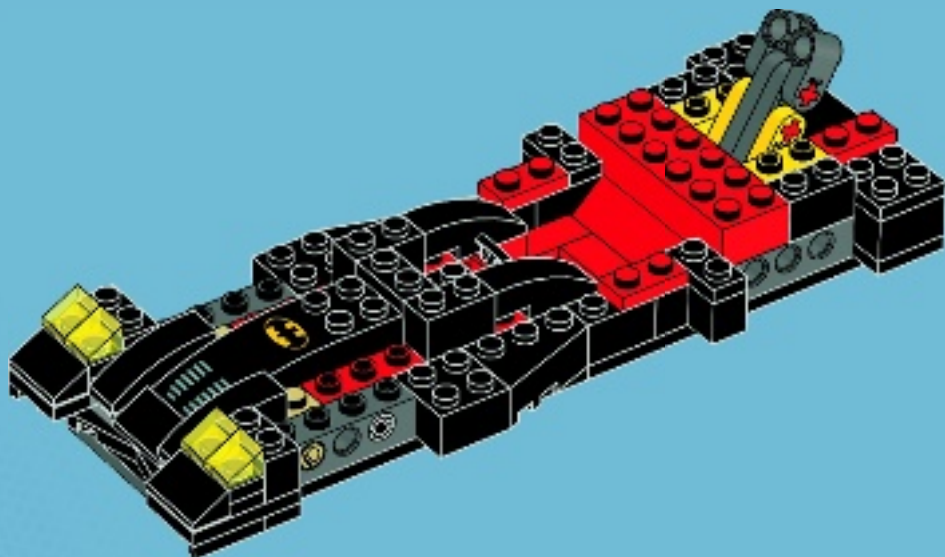



2x



1x



1x



1x

27

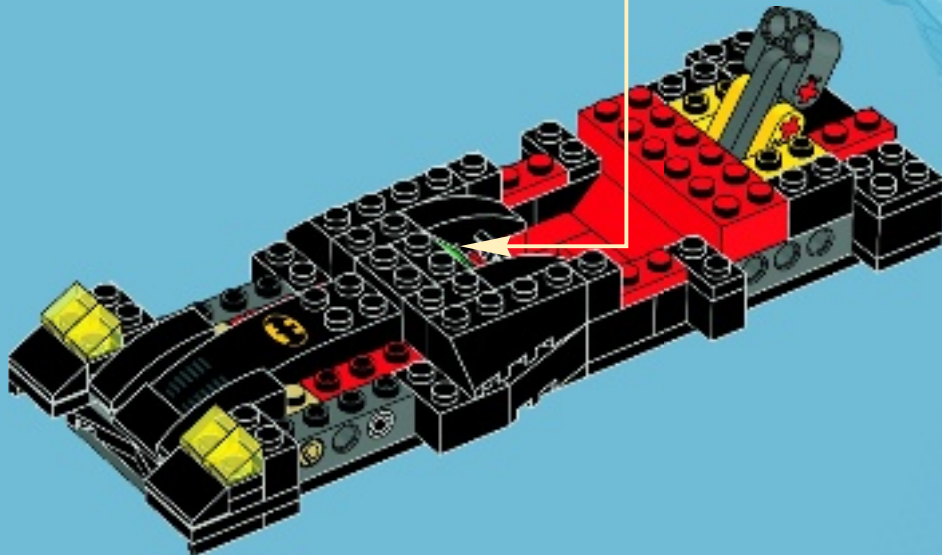



2x



2x



4x

28

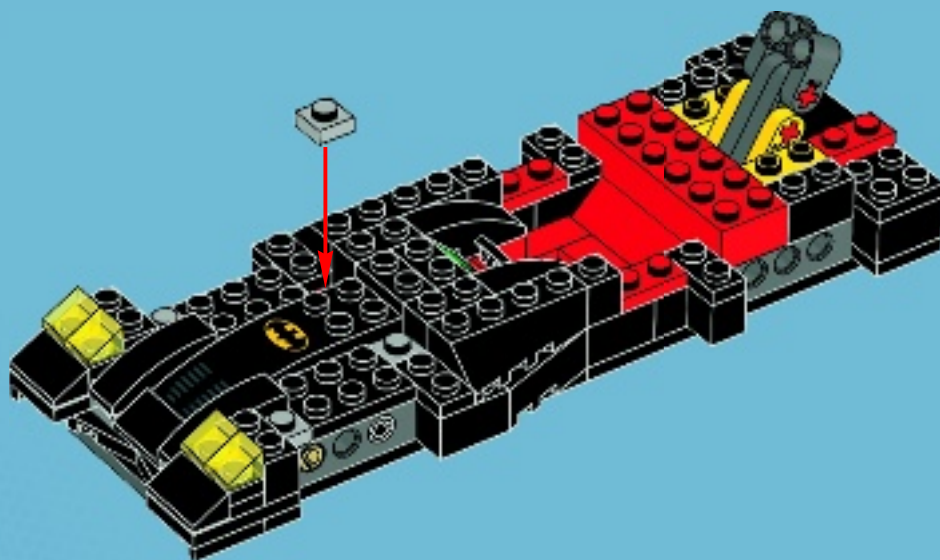



2x



2x

29

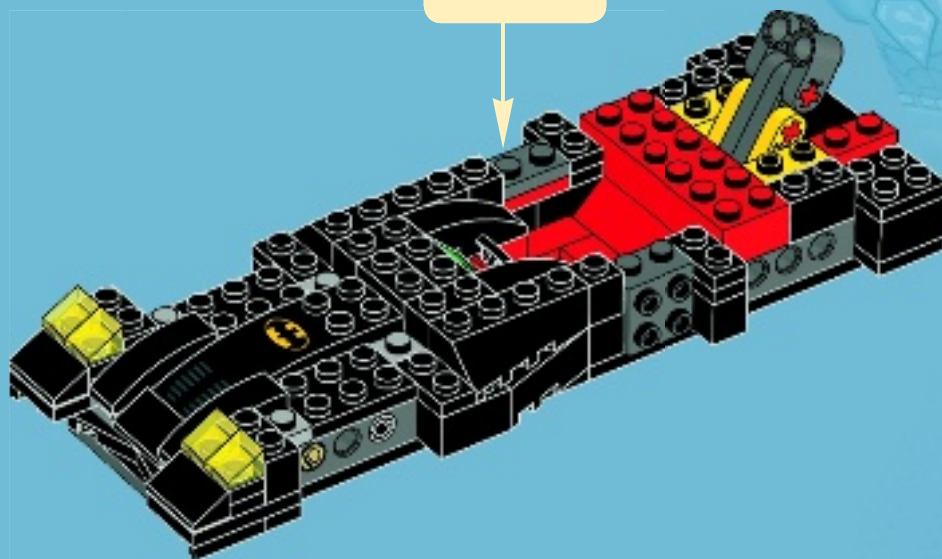



1x



2x



1x

30

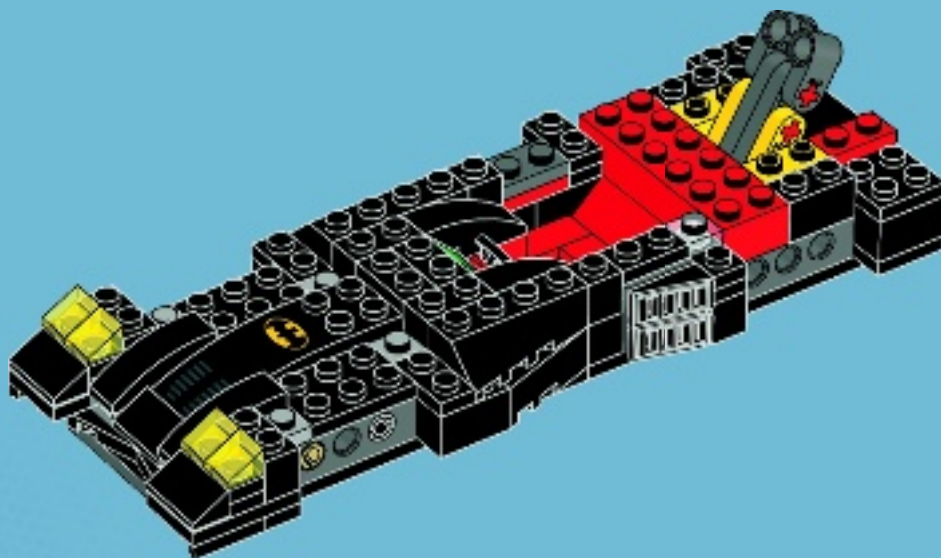



1x



2x



1x

31

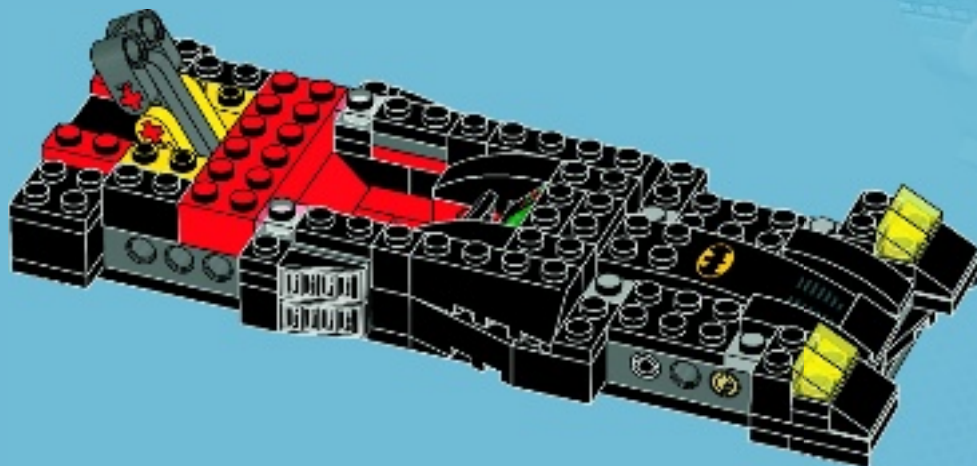



2x



2x



2x

32

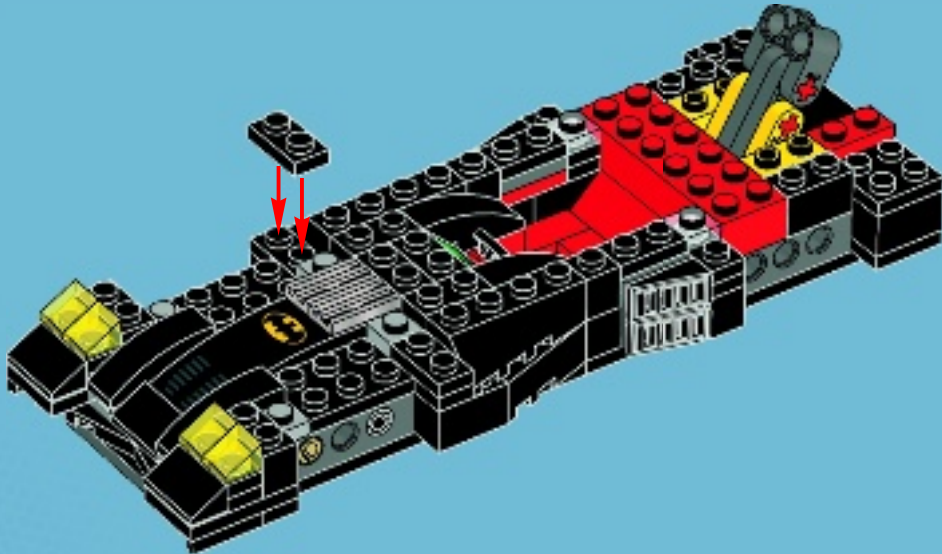



2x



2x

33

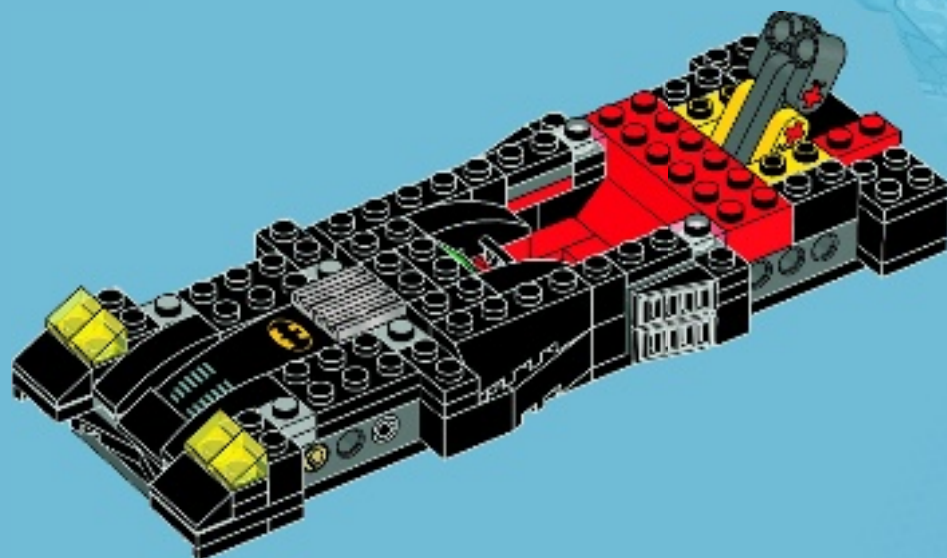



4x



2x



2x



1



2



34

1



2

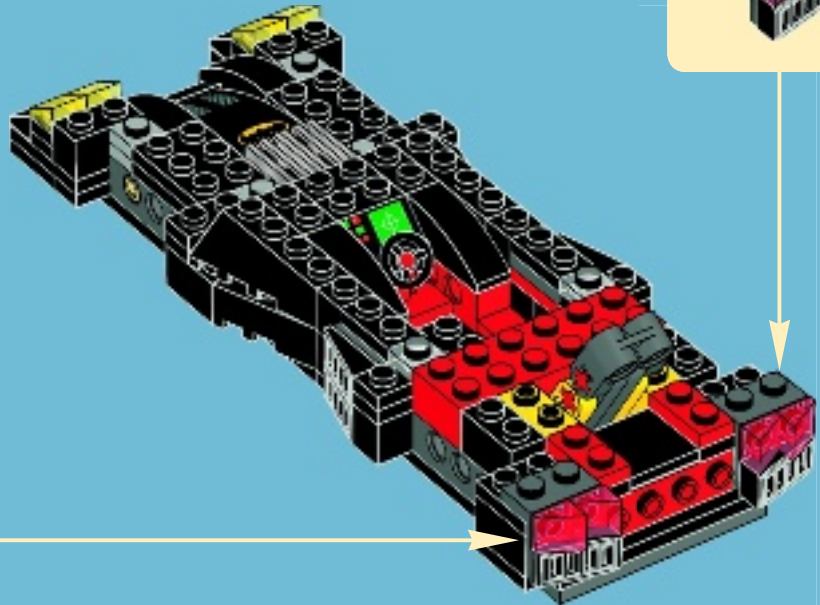



2x



2x

35

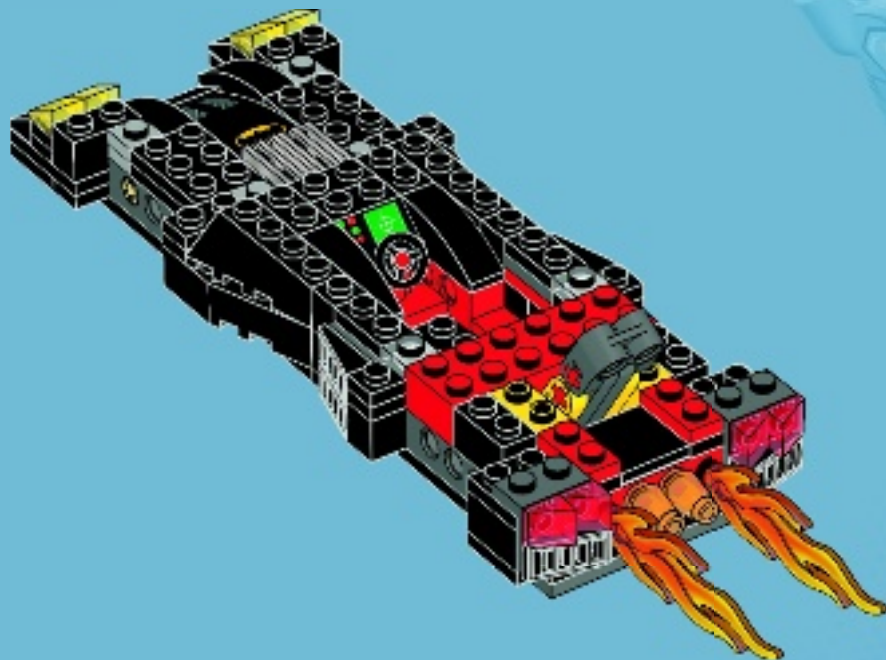



1x



1x

36

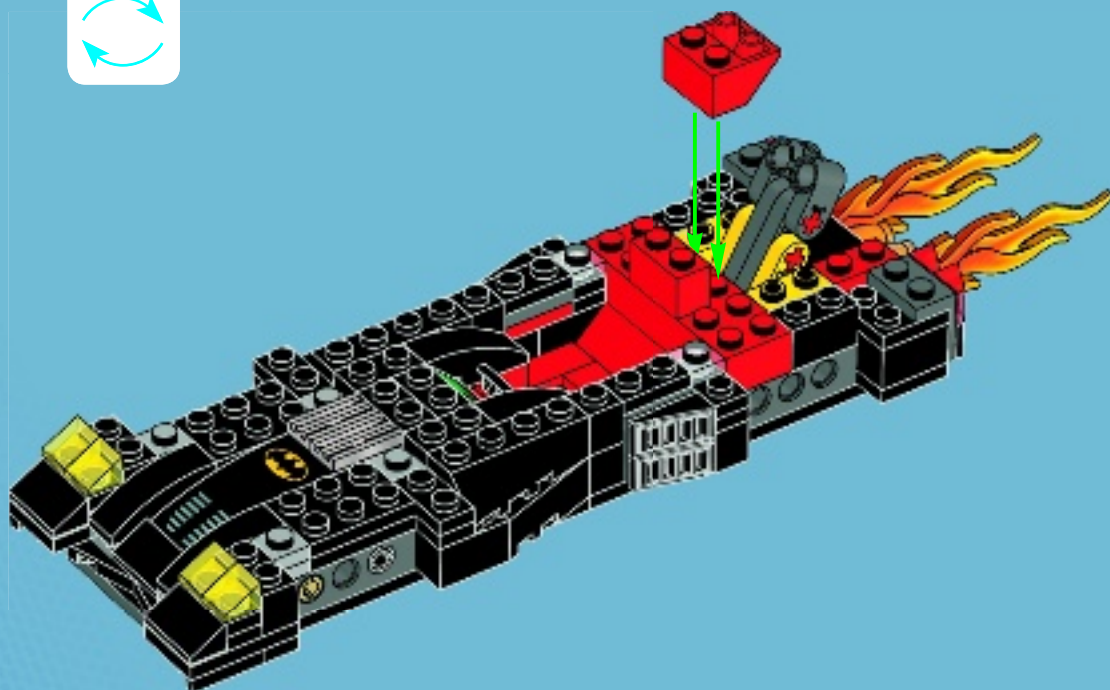



2x



2x

37

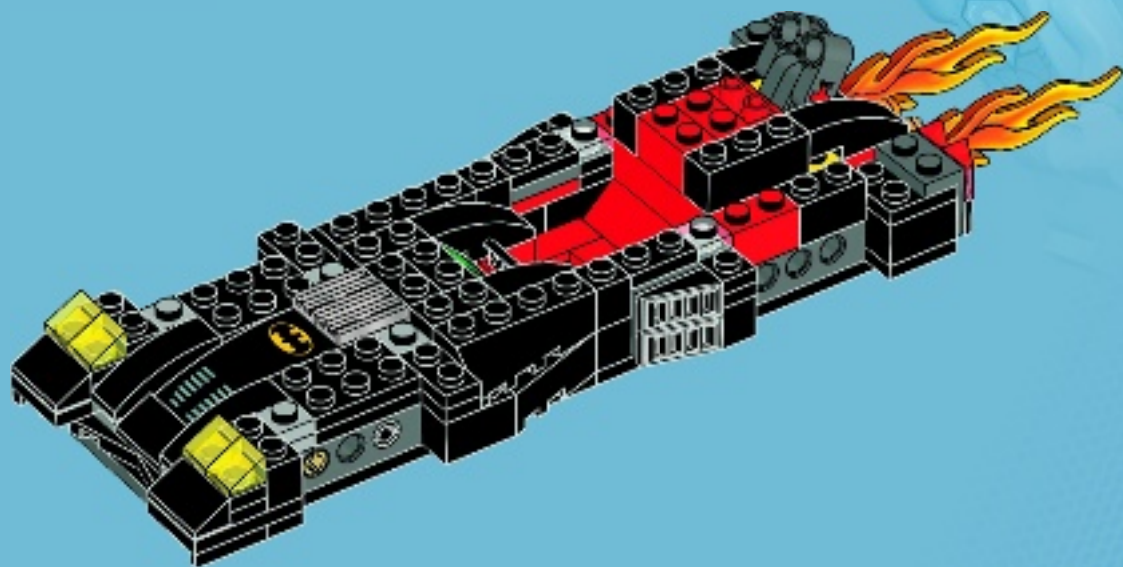



2x

38

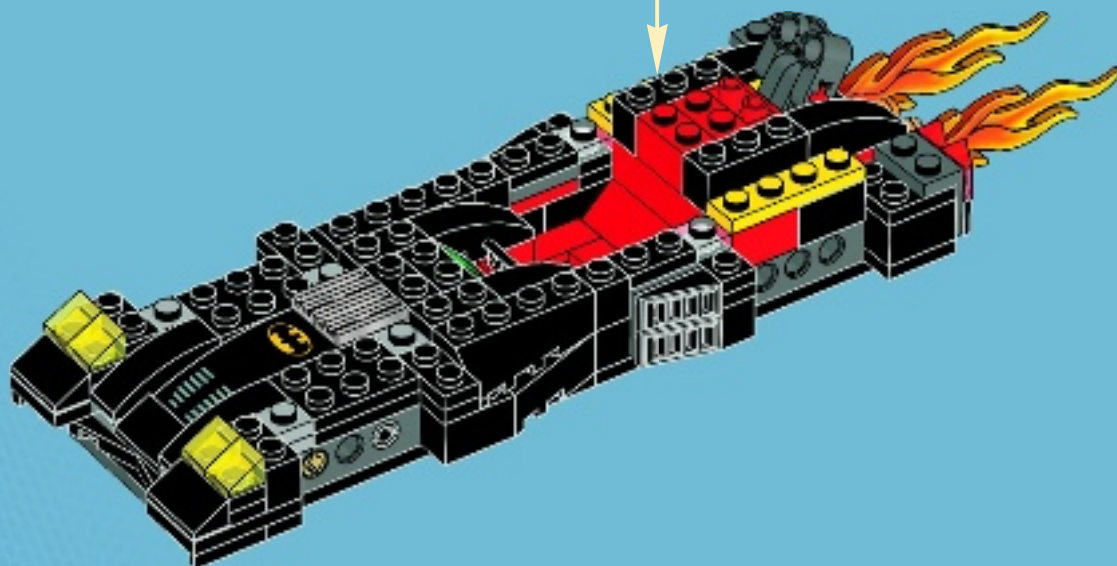
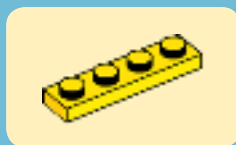



2x



2x



2x

39

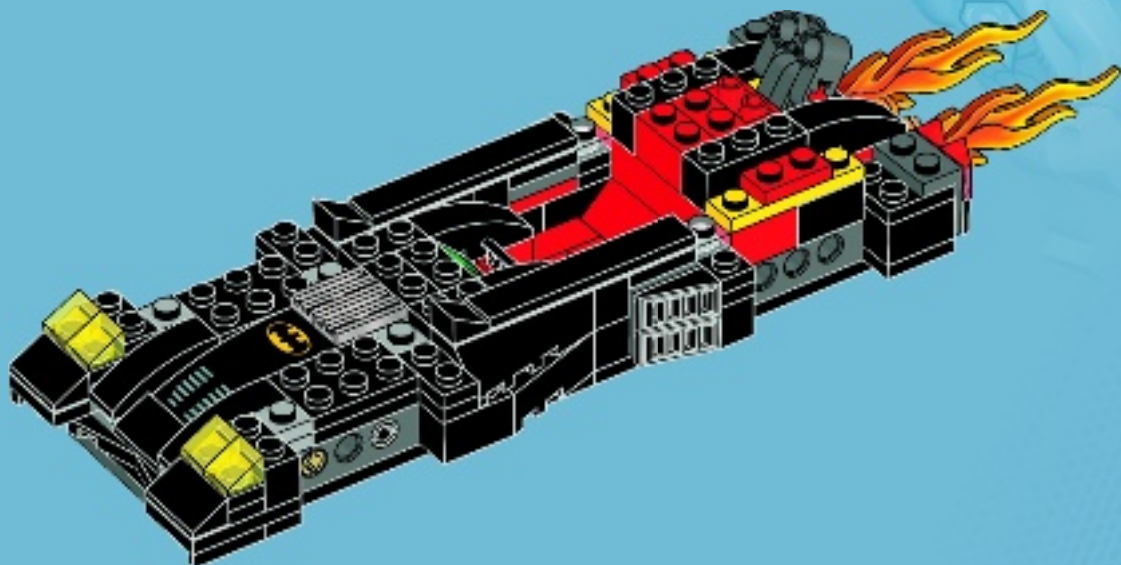



1x



1x

40

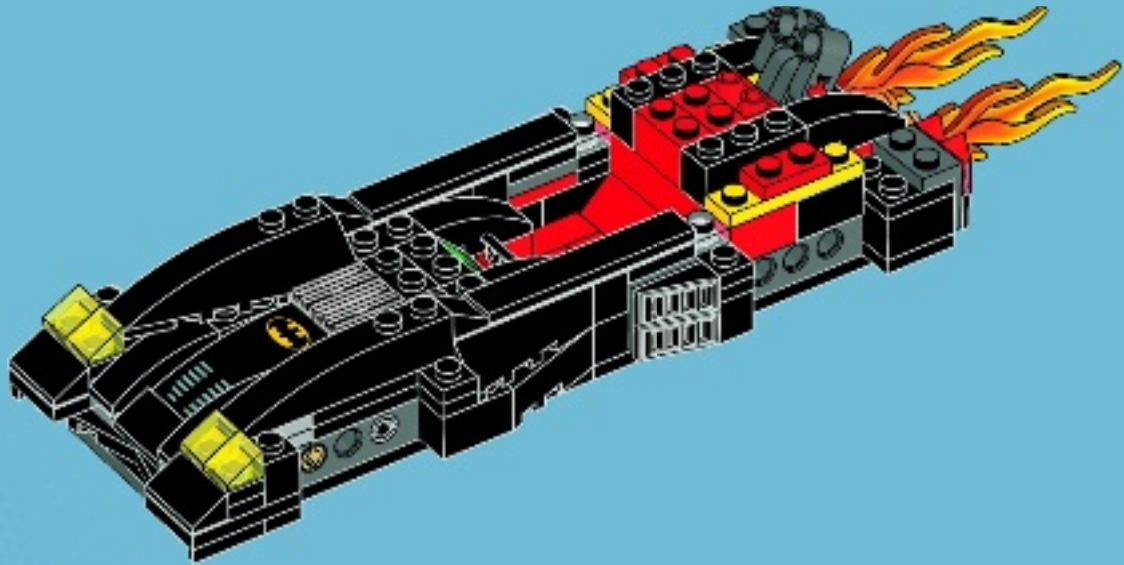



4x

41

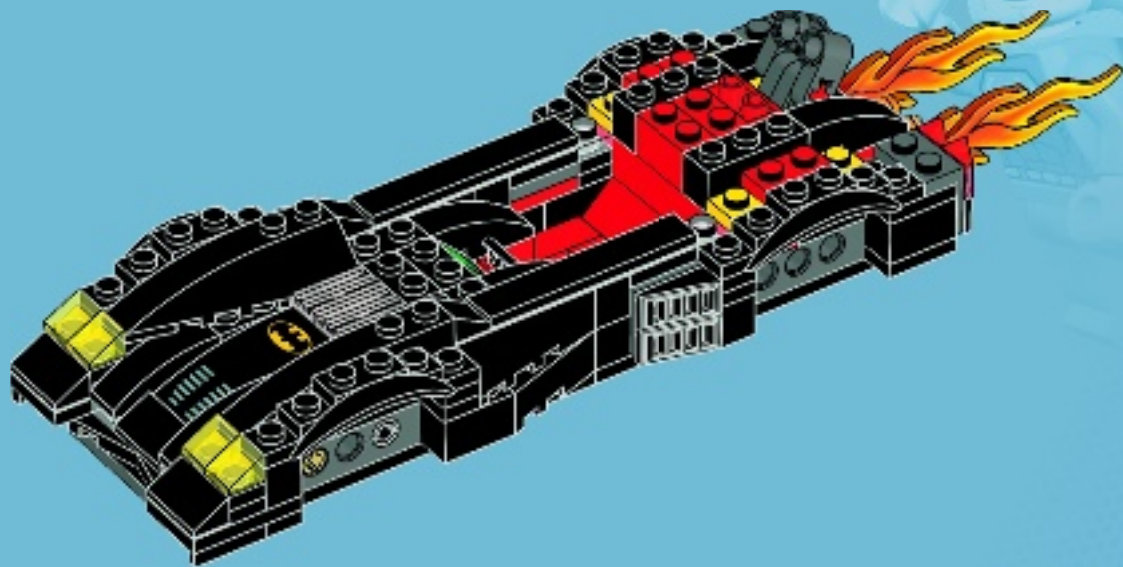



2x



8x

42

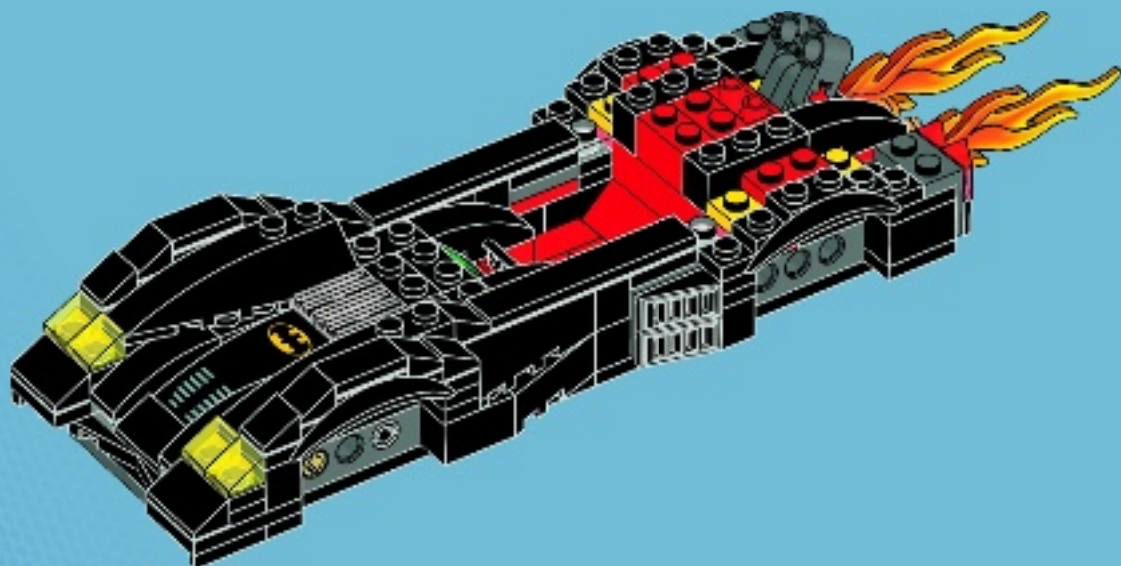



4x

43

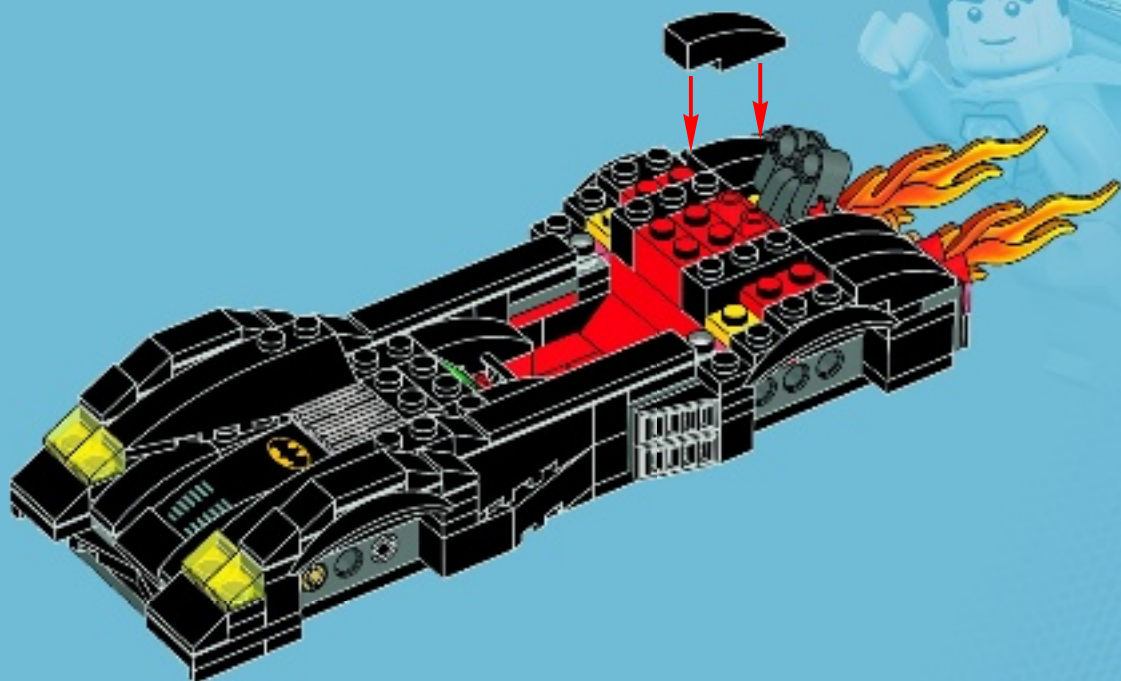



2x



2x



4x

44

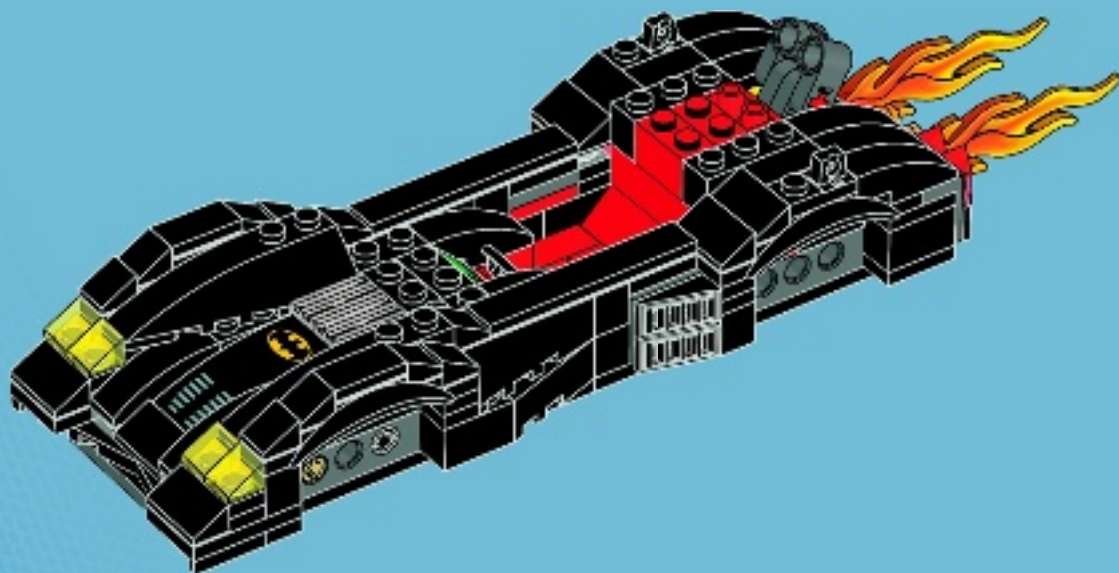



1x



1x

45

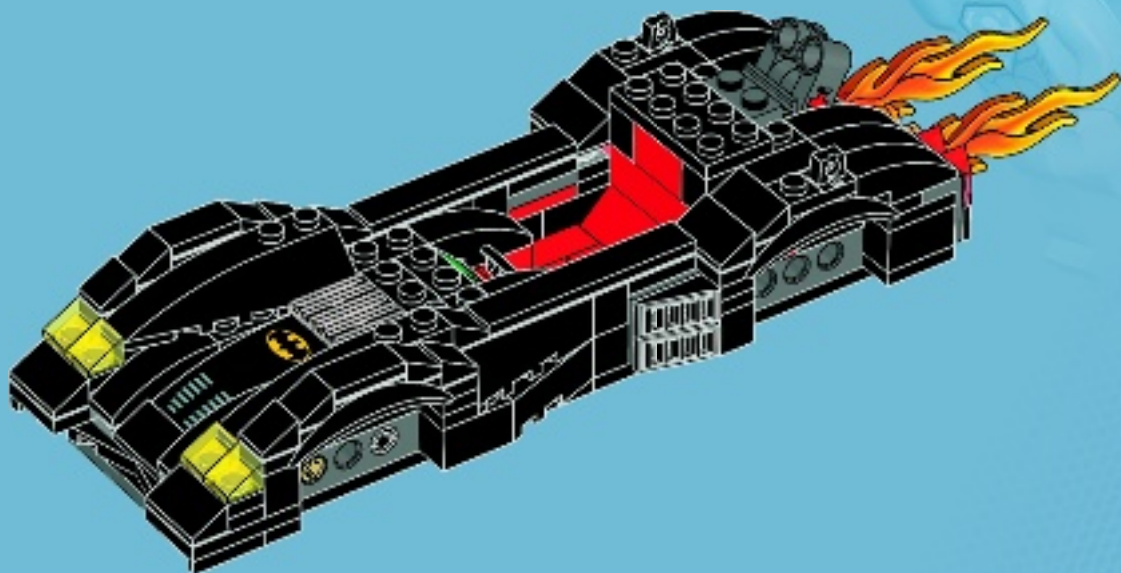



2x



1x

46

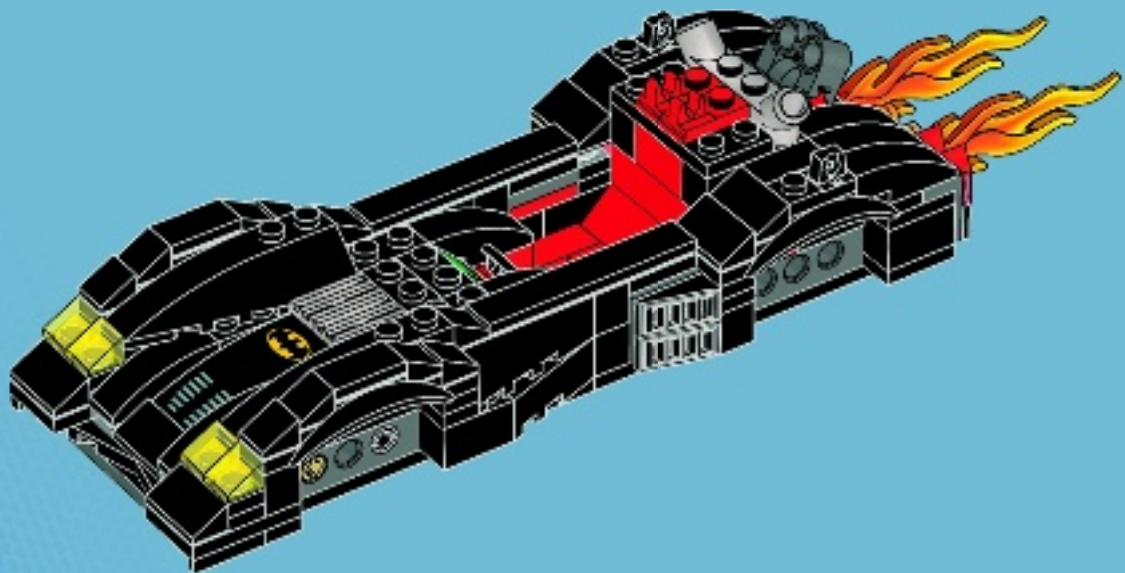



1x



2x

47

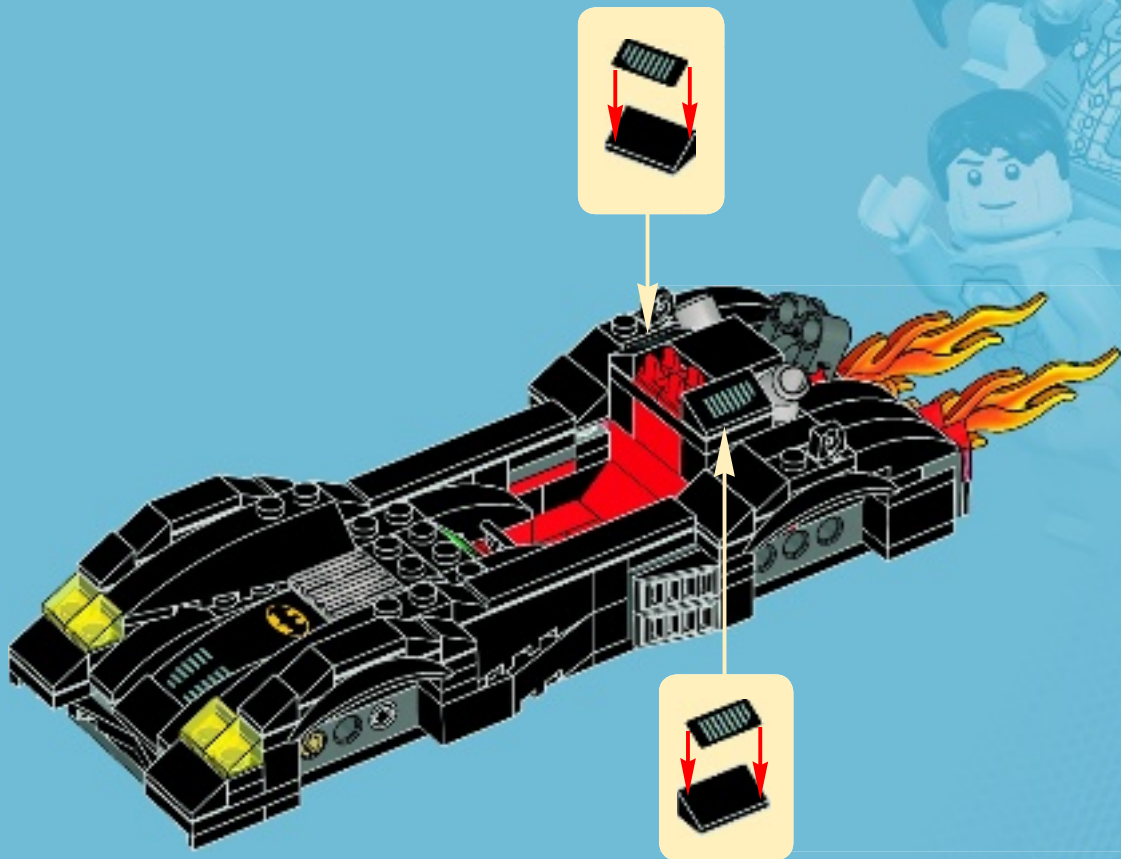

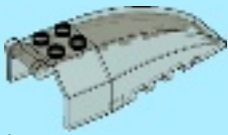

1x

48

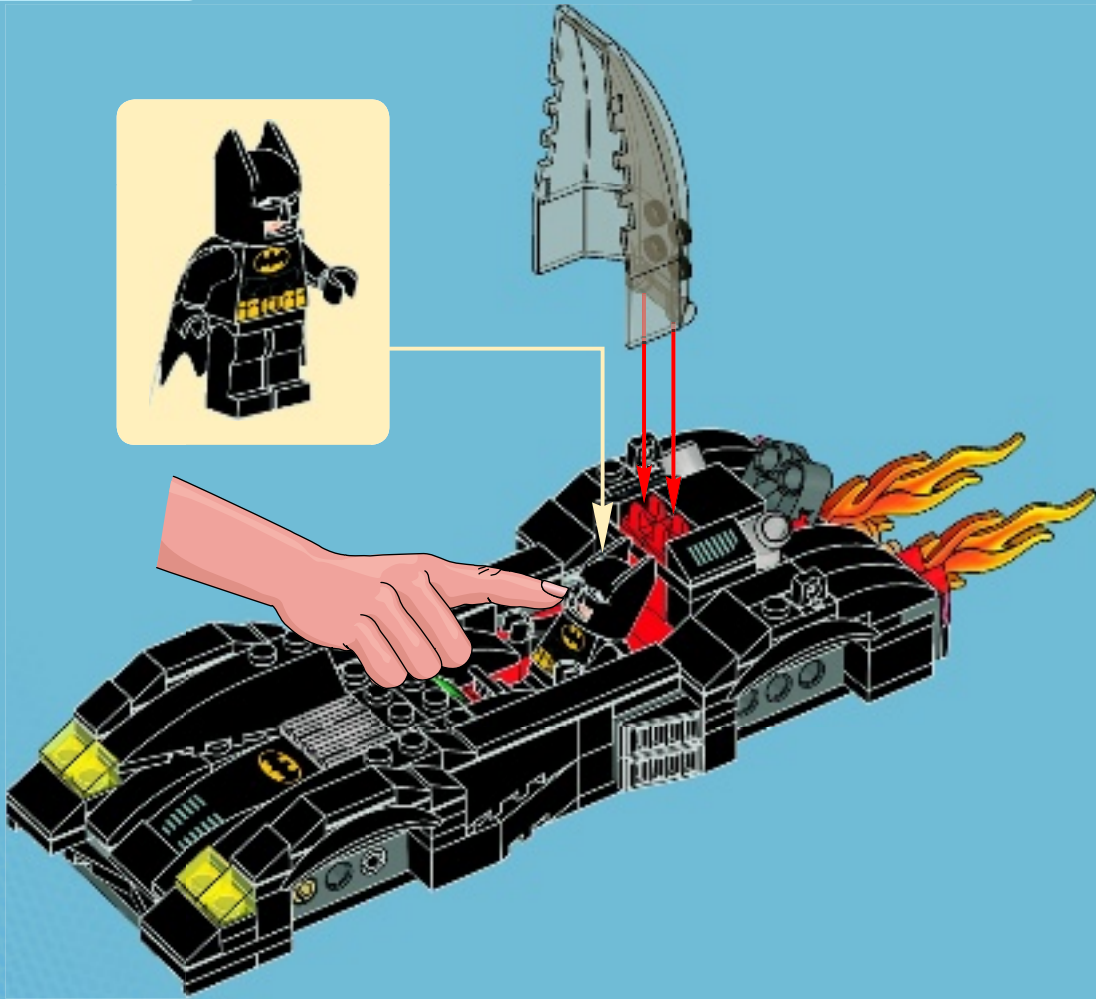



2x



2x

49

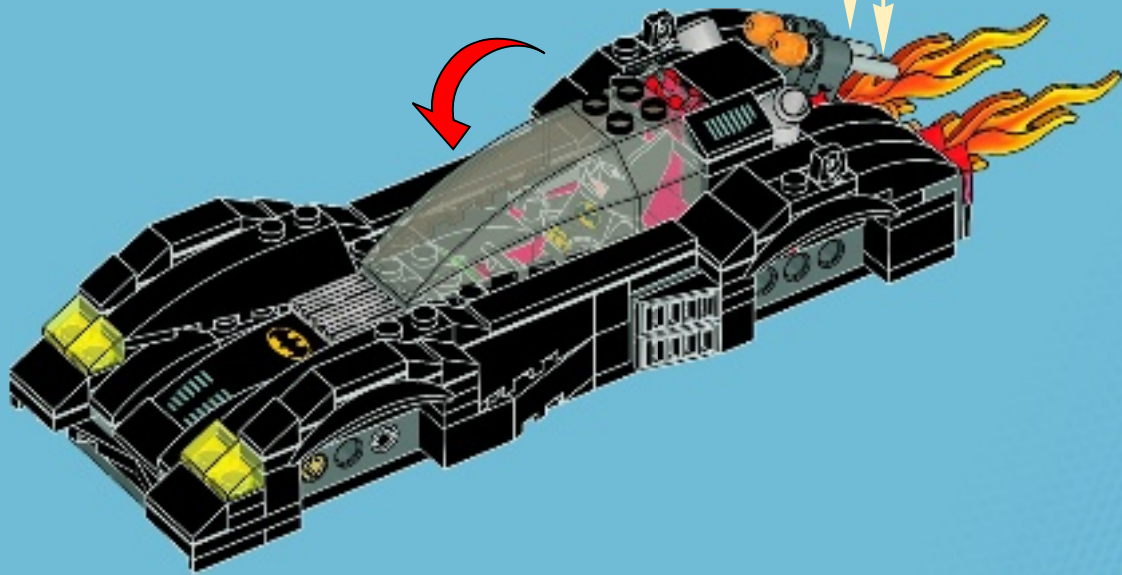
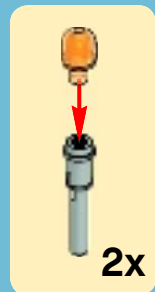



50

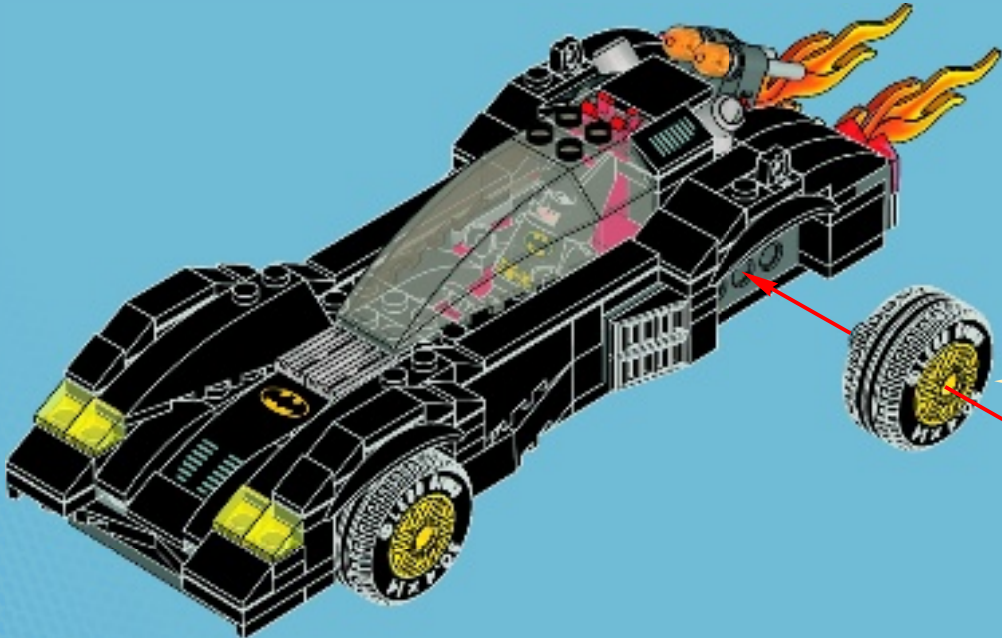
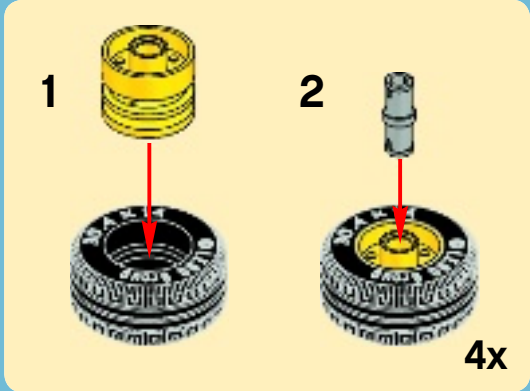

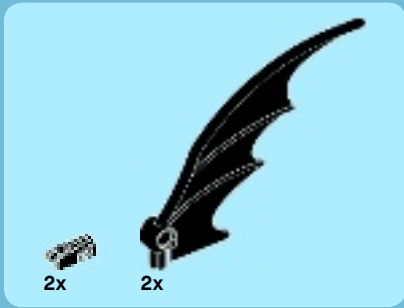

51

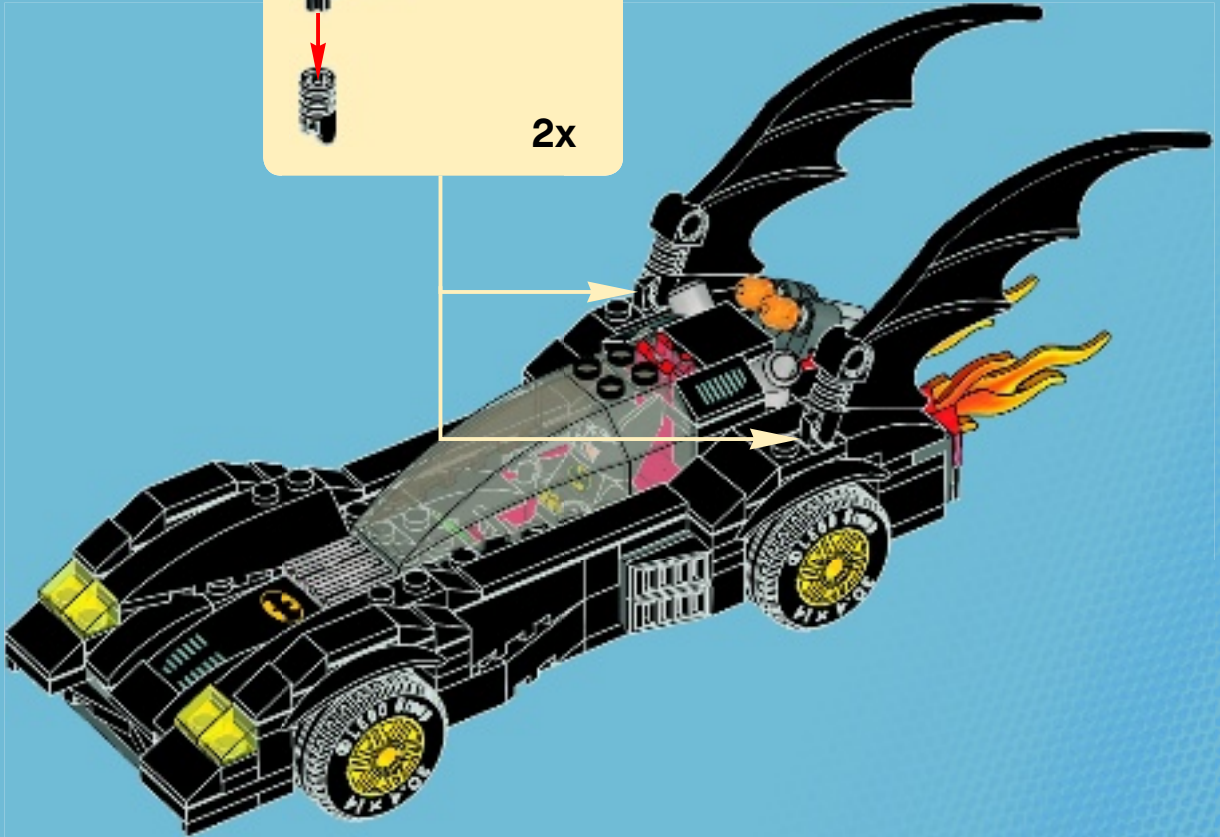
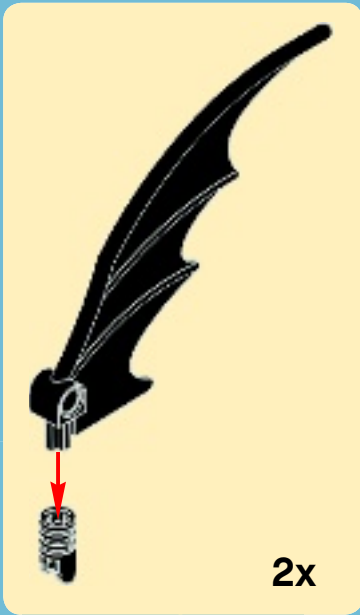



WIN!

Go to www.LEGOsurvey.com/product to fill out a survey for a chance to win a cool LEGO® Product.

No purchase necessary.

Open to all residents where not prohibited.



www.LEGOsurvey.com/product

GEWINNE! WIN!

Nimm an der Umfrage auf www.LEGOsurvey.com/product teil und hab die Chance ein cooles LEGO® Produkt zu gewinnen!

Die Teilnahme am Gewinnspiel führt zu keinerlei Kaufverpflichtungen. Teilnahme in allen nicht ausgeschlossenen Ländern möglich.

Ga naar www.LEGOsurvey.com/product, vul een enquêteformulier in en maak kans op een cool LEGO® product.

Geen aankoopverplichting. Iedereen mag deelnemen, uitgezonderd ingezetenden van landen waar een enquêteverbod geldt.

GAGNE! 当てよう!

Visite www.LEGOsurvey.com/product pour répondre à un questionnaire et avoir une chance de gagner un produit LEGO® très cool!

Aucune obligation d'achat. Ouvert à tous les résidents des pays autorisés.

www.LEGOsurvey.com/product にアクセスしアンケートにご記入ください。当選者には1製品を差し上げます。

お買い上げの必要はありません。

禁止されていない限り、すべての皆様にご利用いただけます。