

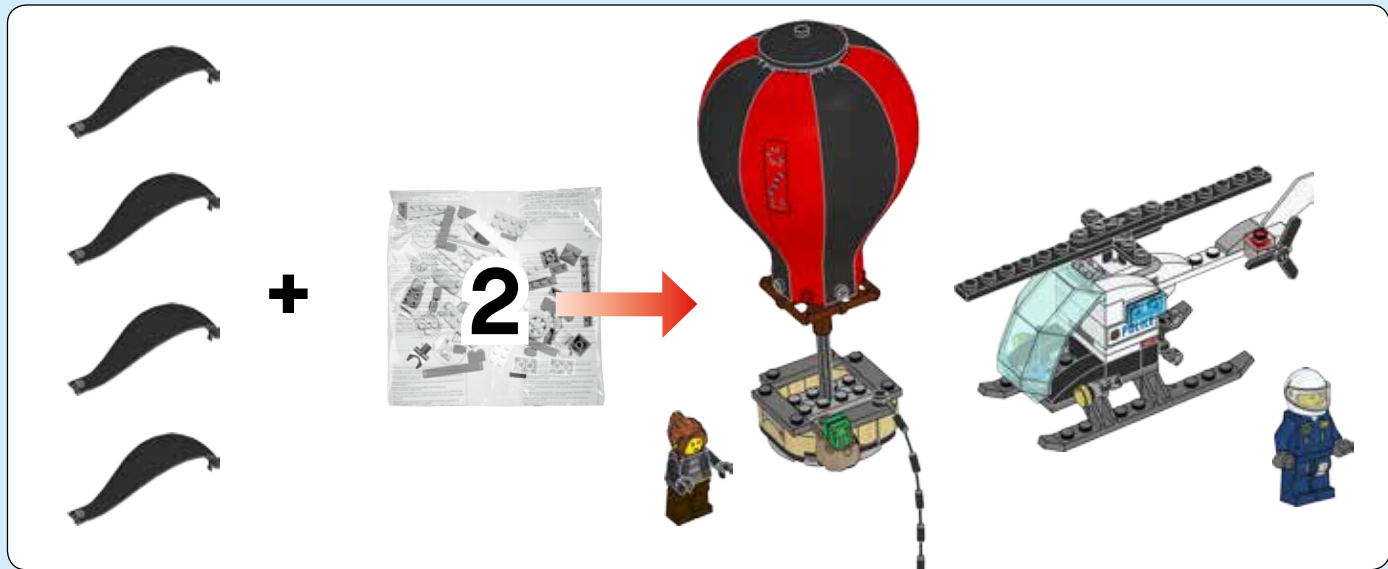

# CITY

60130





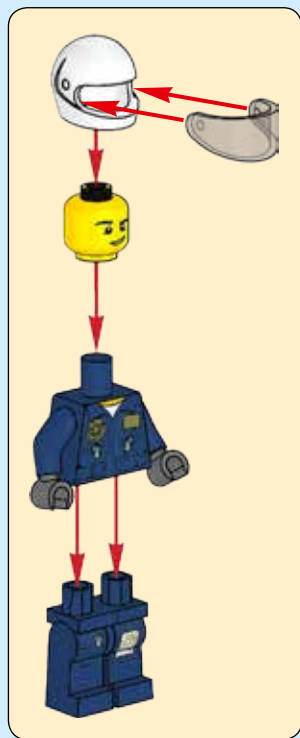

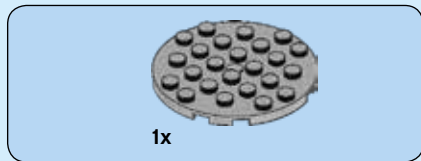

**1**



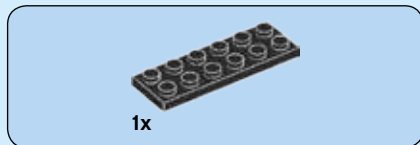

**2**

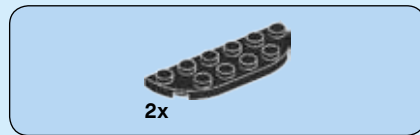
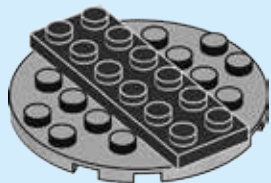

**3**

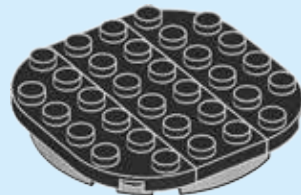



2x



1x

4

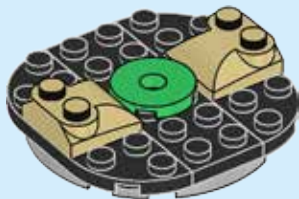

6



1x



2x

5

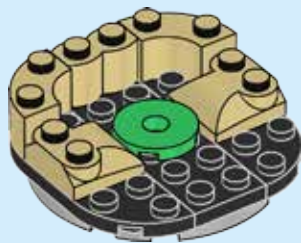

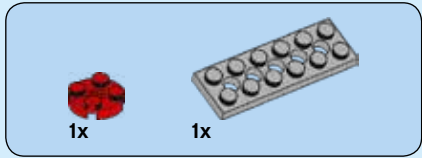

6

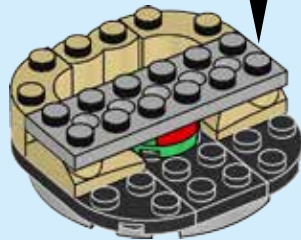
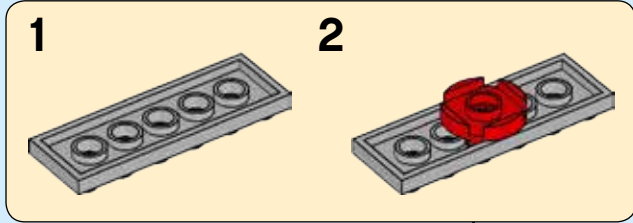





1x



2x

7

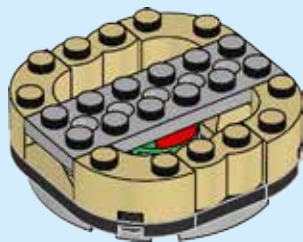

4x

8

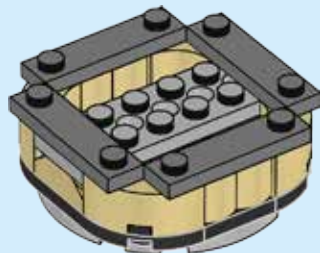

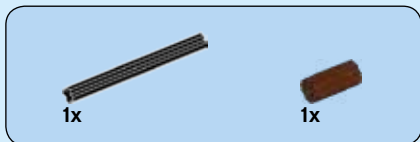

9

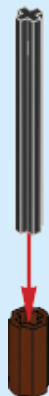



1x

10



1x

11





1x

12





1x

13



1x

14



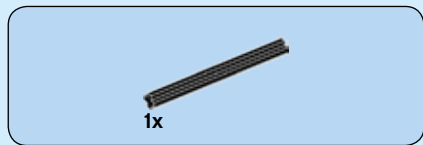

15



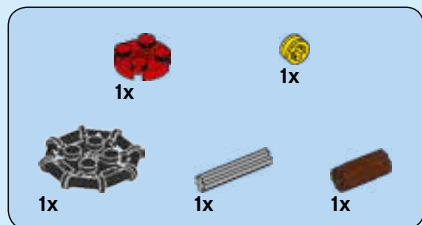

# 16

1



2



3



4



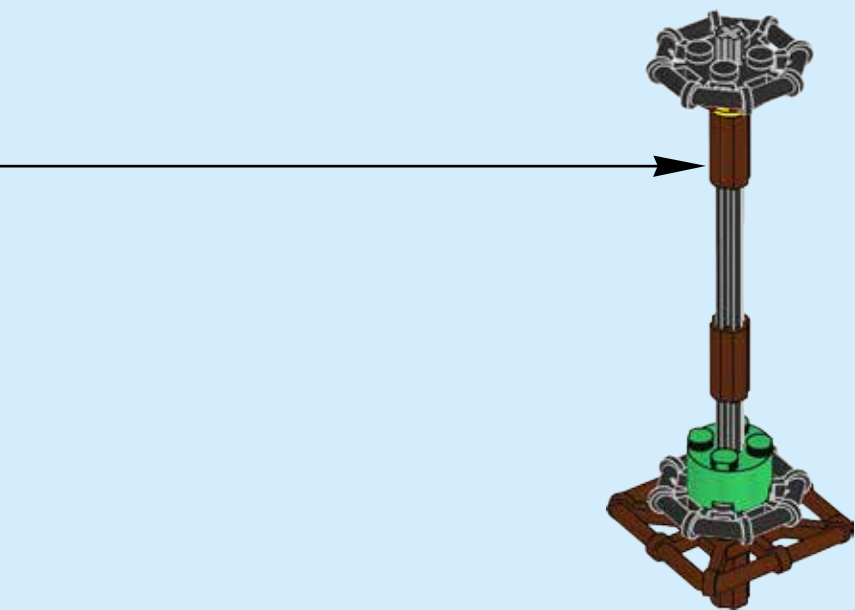



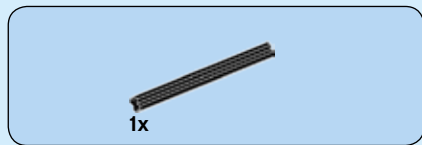

17

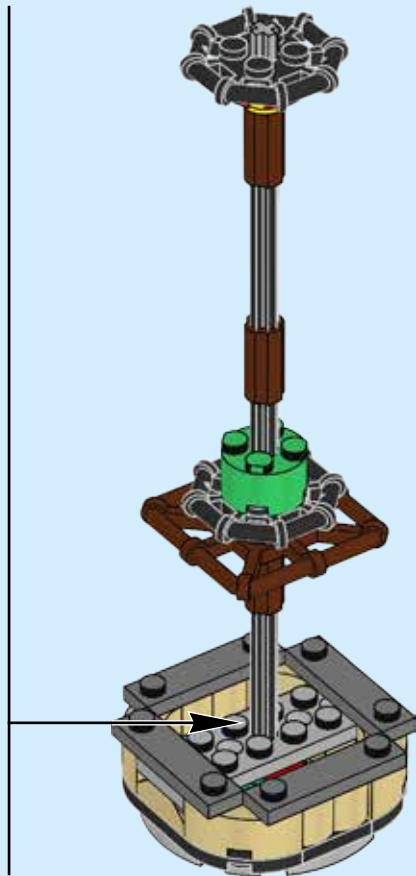
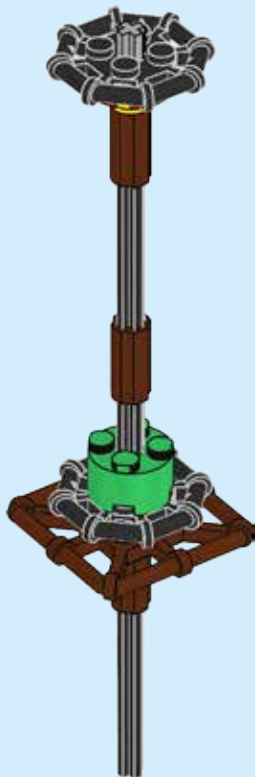

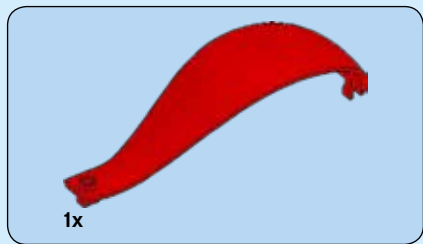

18

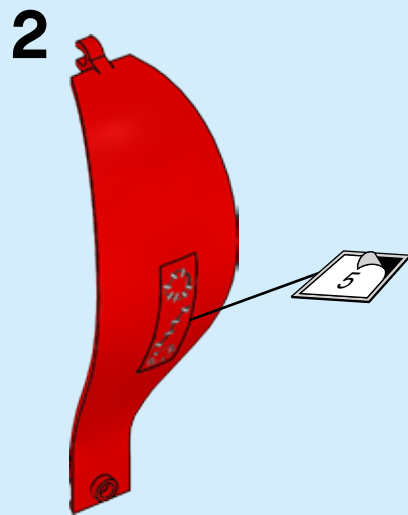
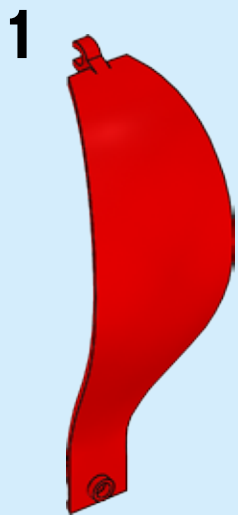

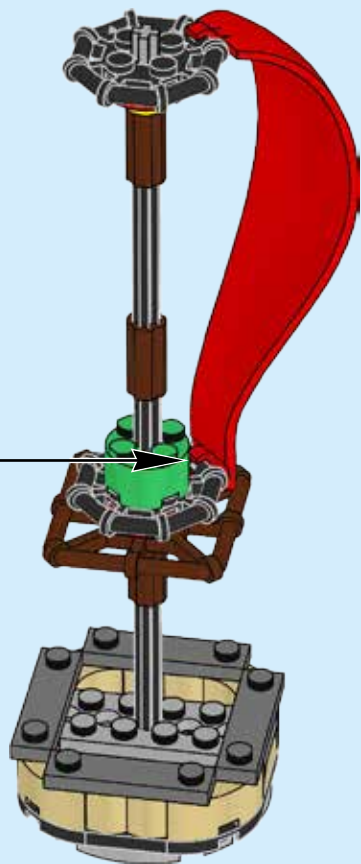

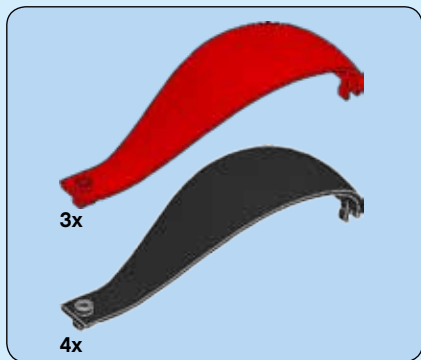

19

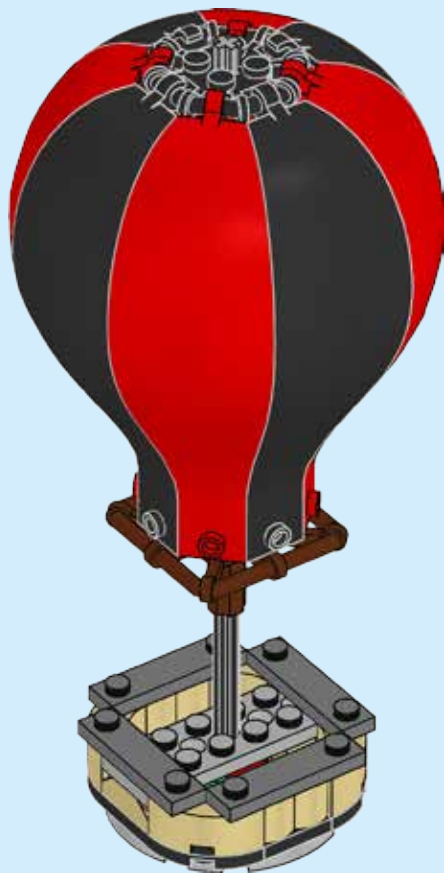

20

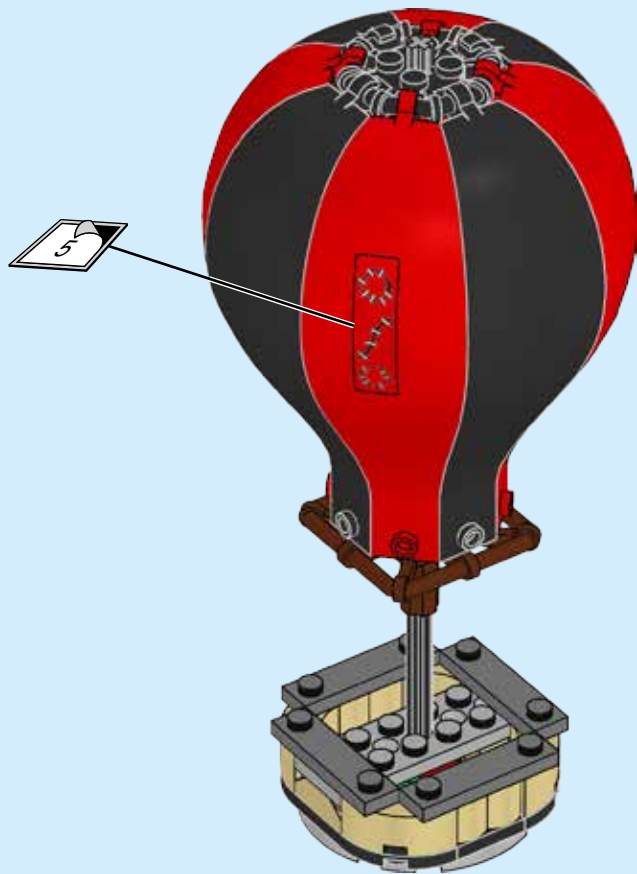



1x

21

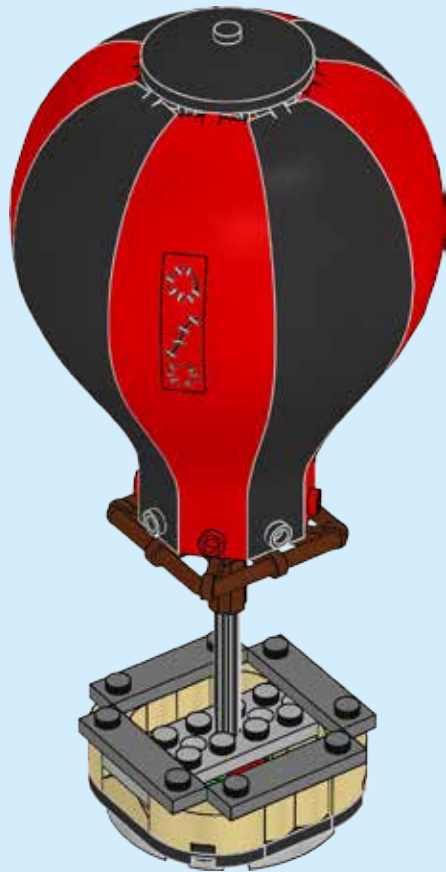

22

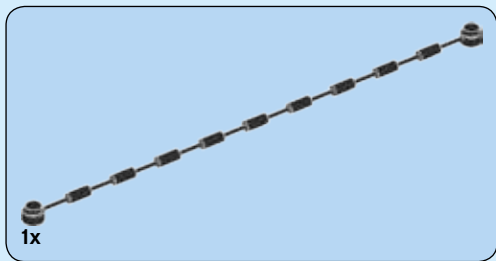

22

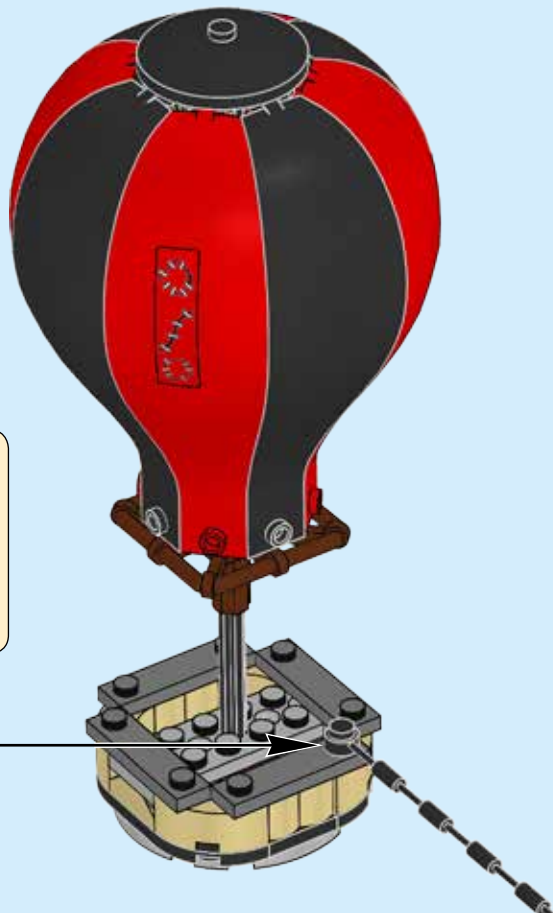
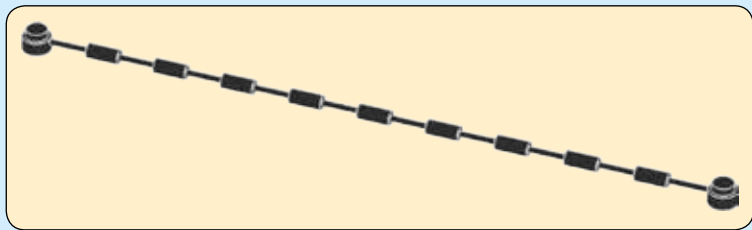



2x



1x

# 23

1



2

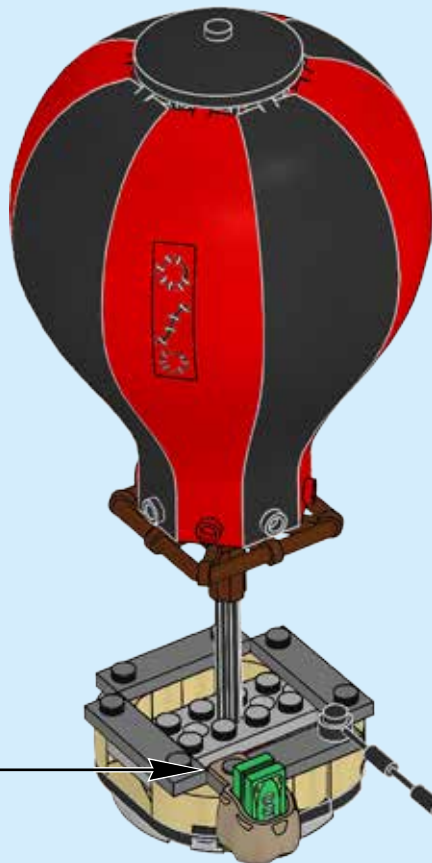

24







**1**





1x

**2**



2x

**3**

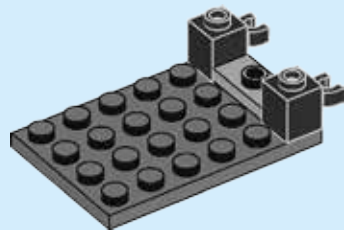

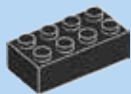

1x

4

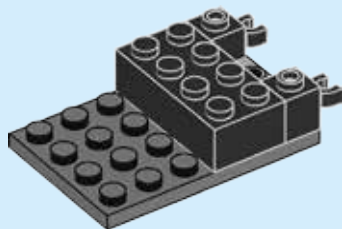



2x



1x

5

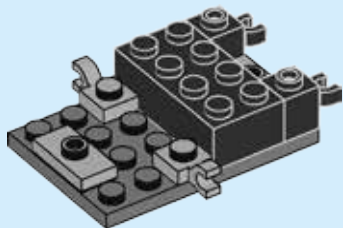

2x

6

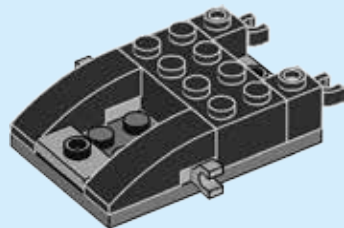



2x



2x

7

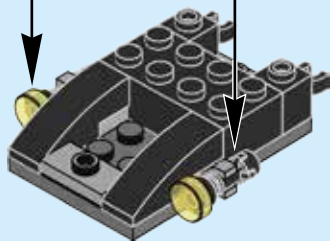
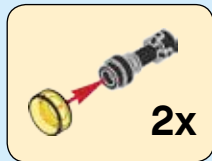



1x



1x



1x

# 8

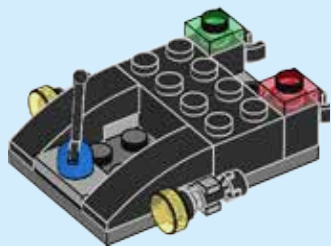

1x

# 9

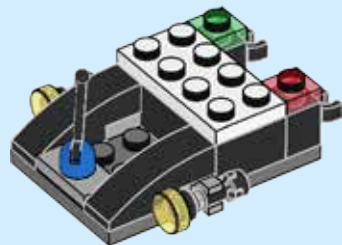



2x

# 10

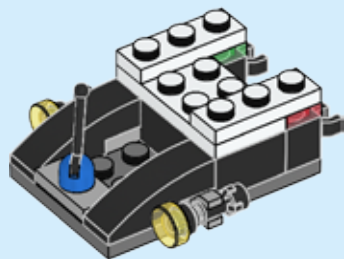



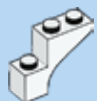

1x

# 11

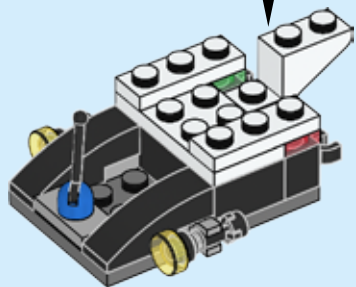
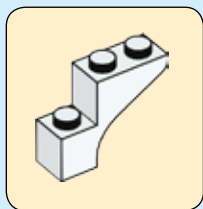

1x

# 12

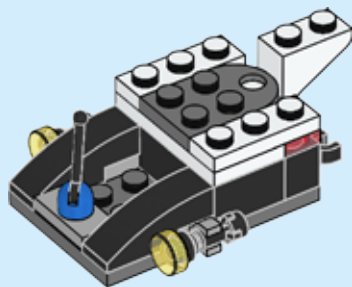



2x

# 13

1



2



2x





1x

# 14

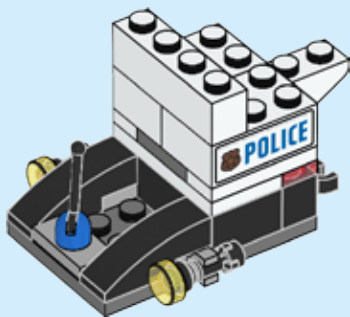

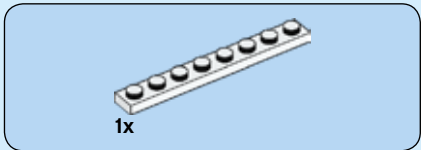

15

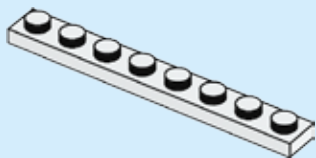



1x

16

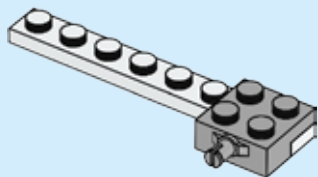

1x

17

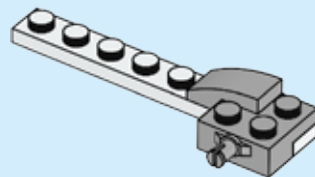



1x

18

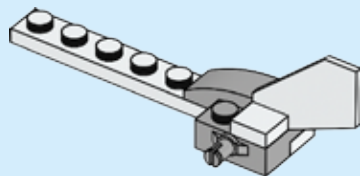



1x

19

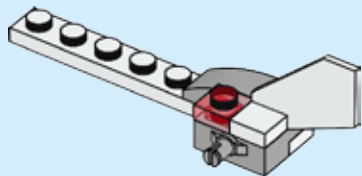

1x

20

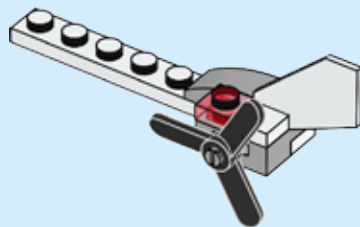

# 21

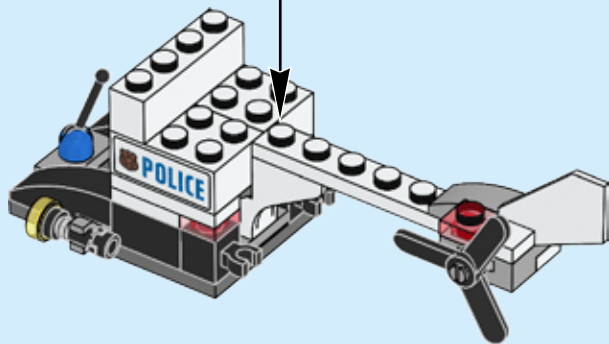





1x

22

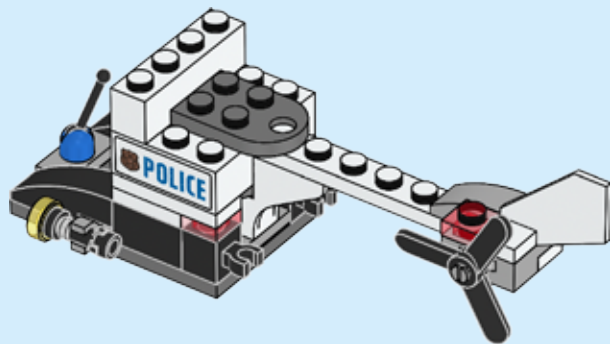

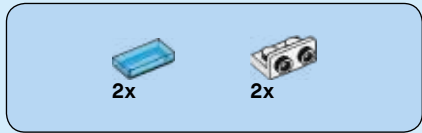

# 23

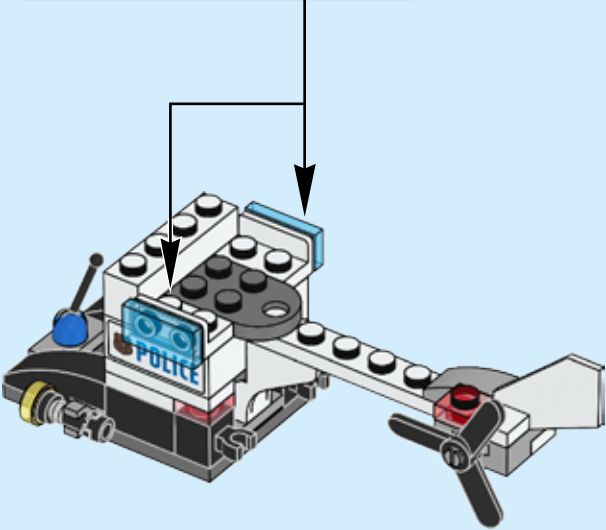
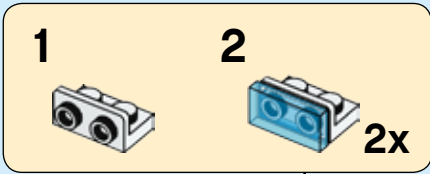



1x

24

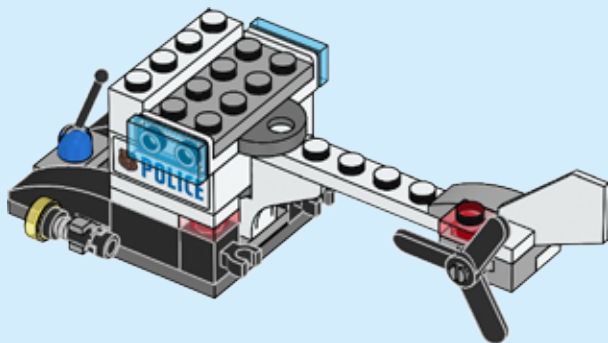



1x

25

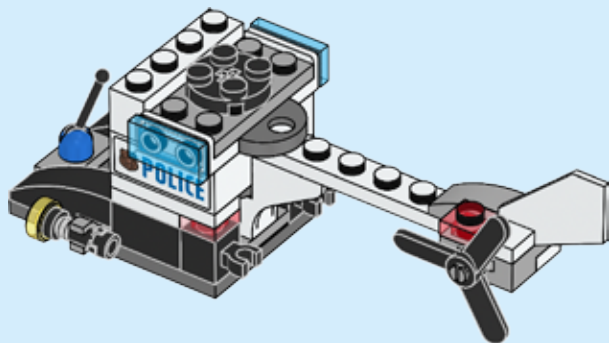



1x

26

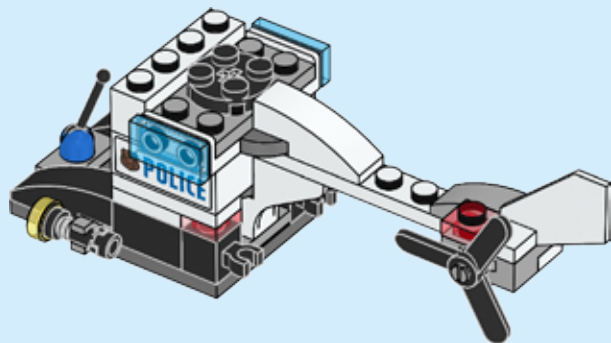

1x



2x

27

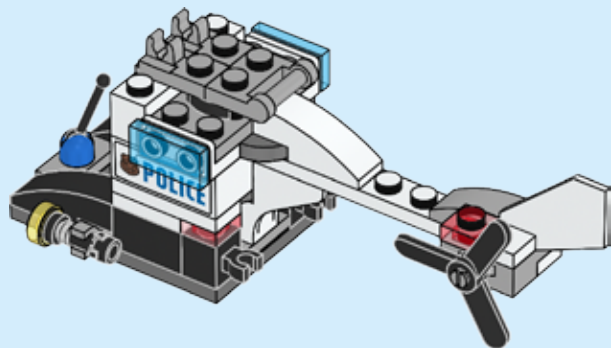



2x

# 28

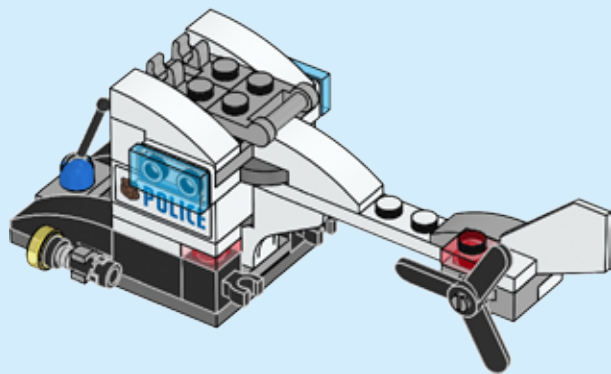



1x

# 29

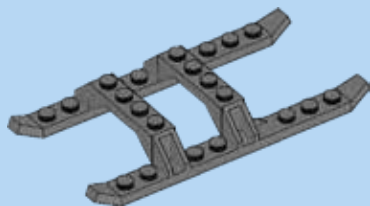
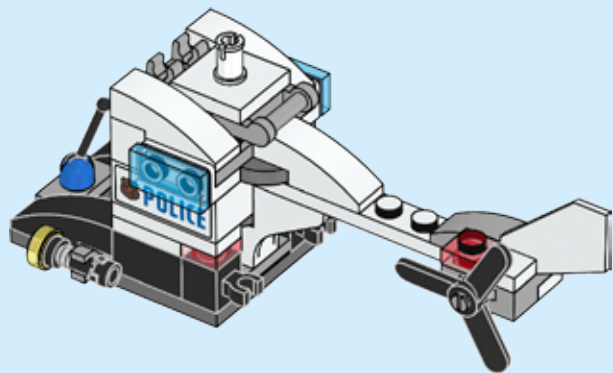

1x

# 30

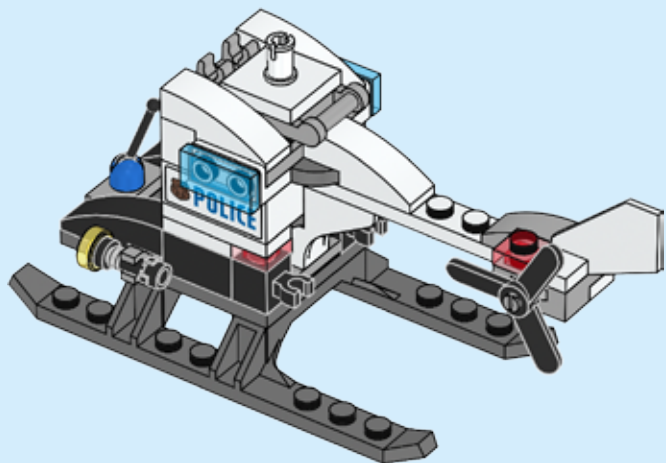



2x

# 31

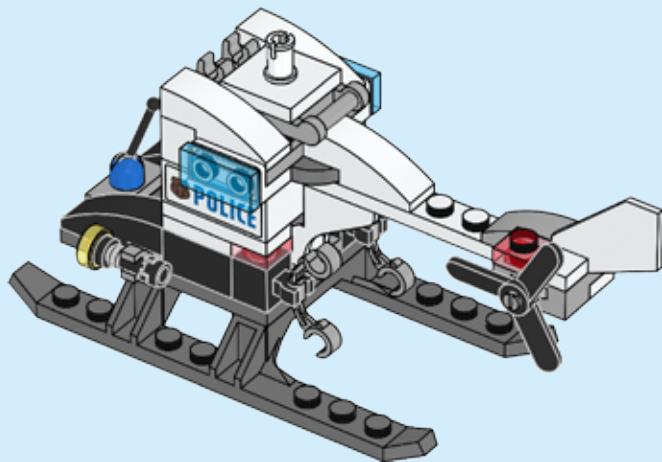



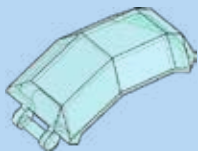

1x

32

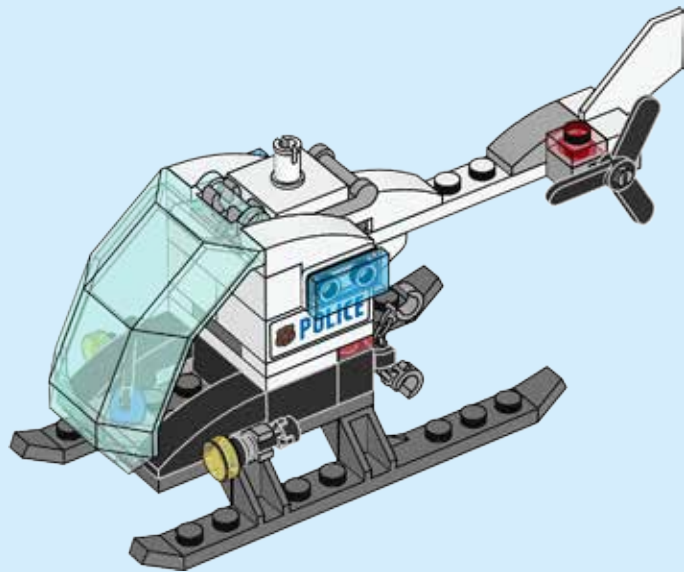

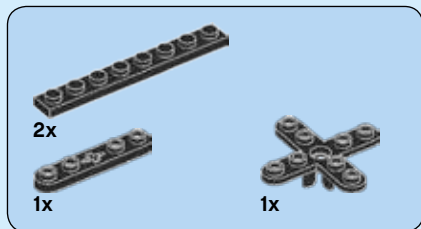

# 33

## 1



## 2

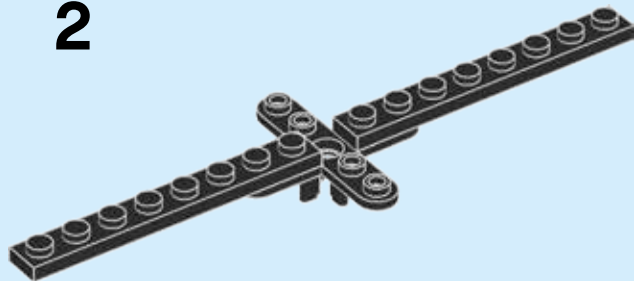

**3**

