

**LEGO**

**Harry Potter**

4728

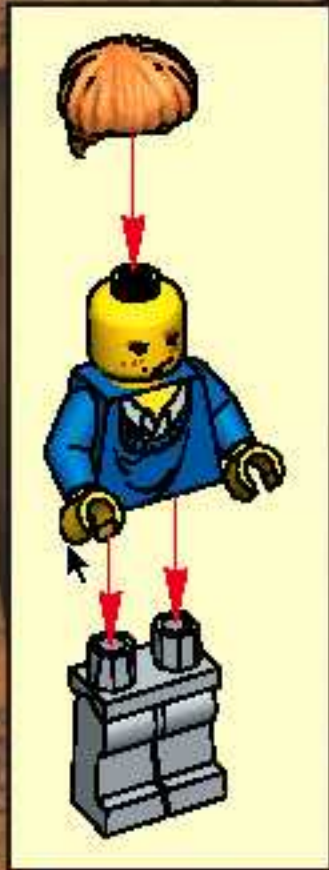



1

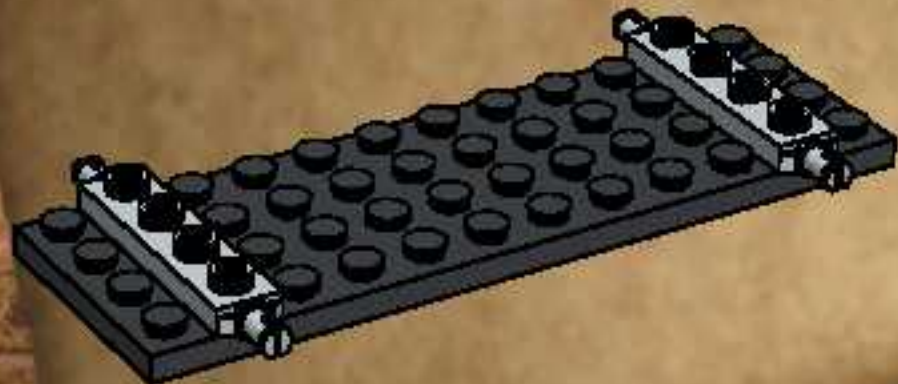

2

2

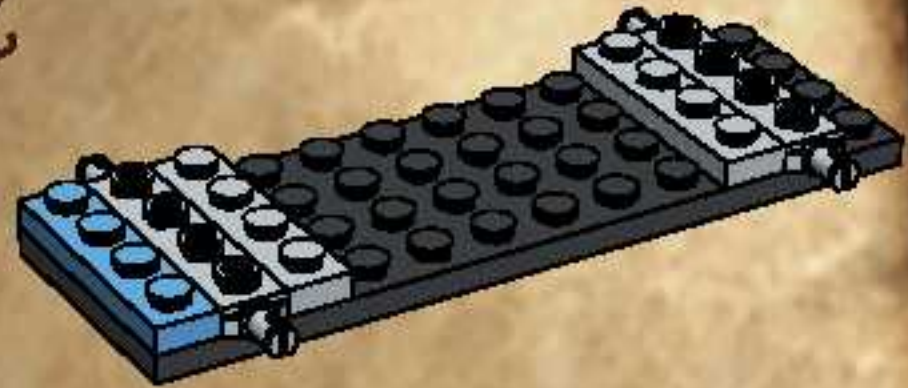

3

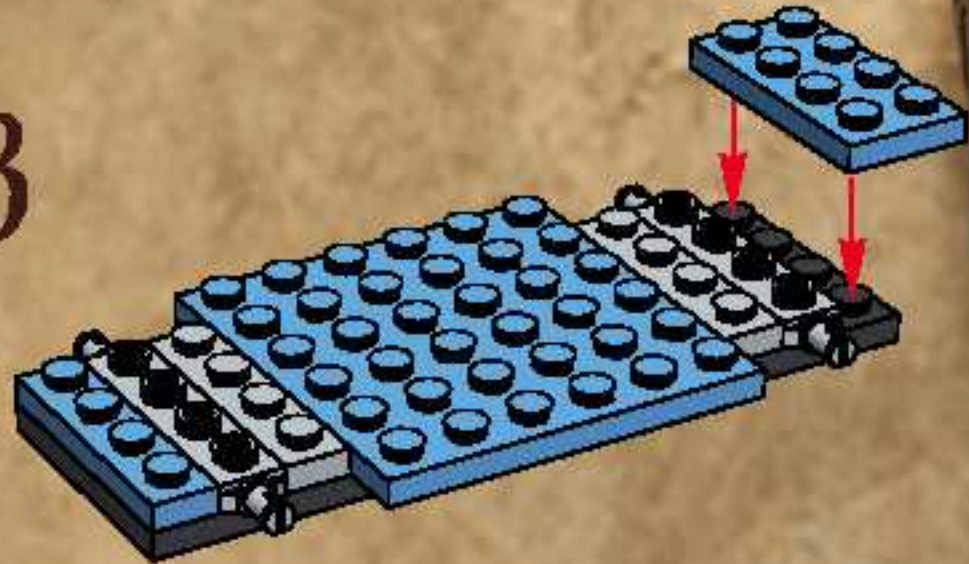

4

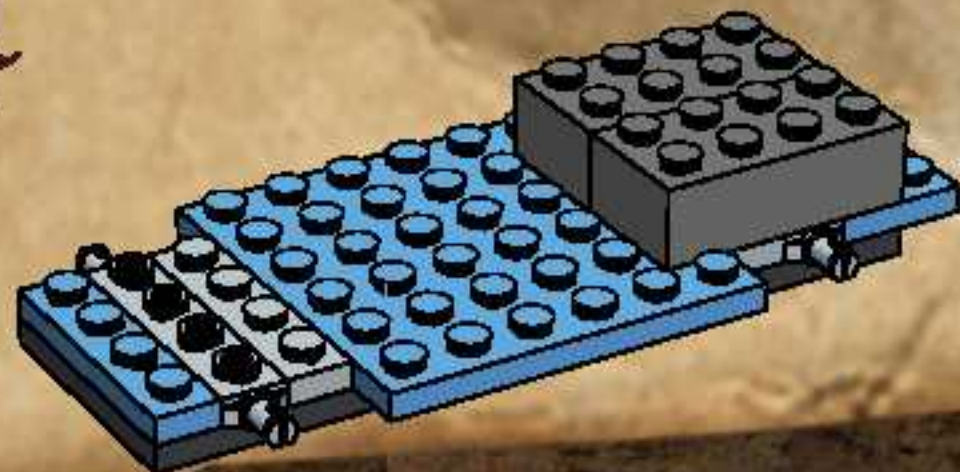

5

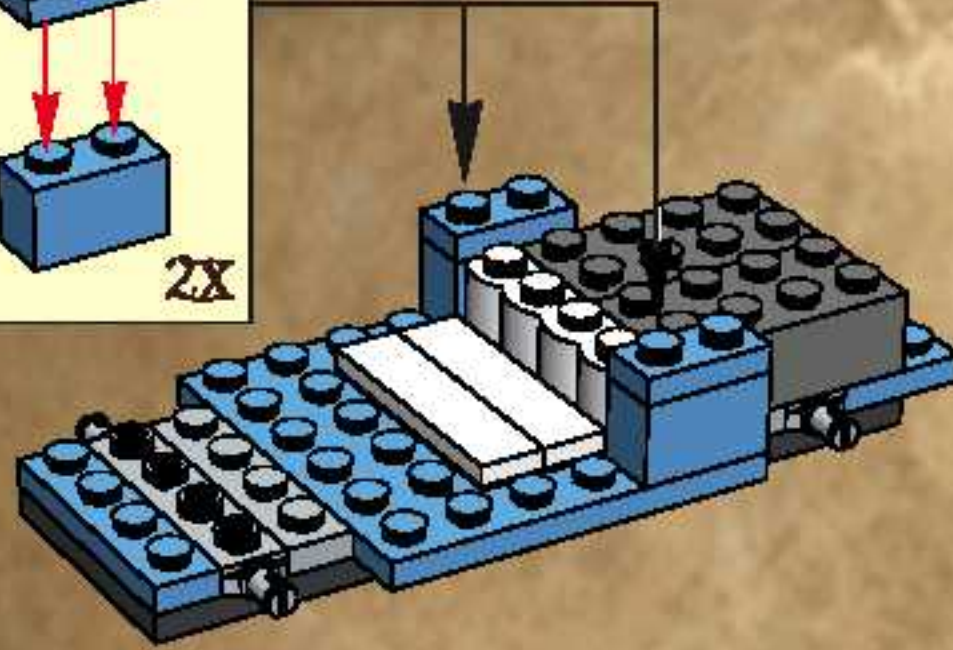
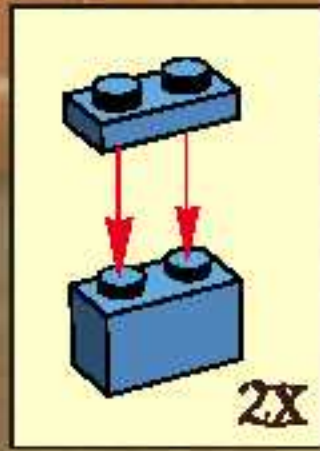

1

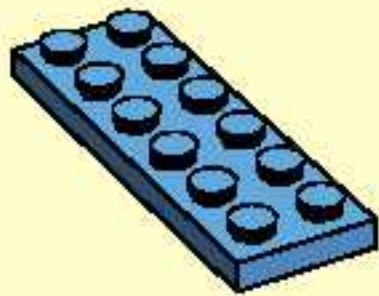

2

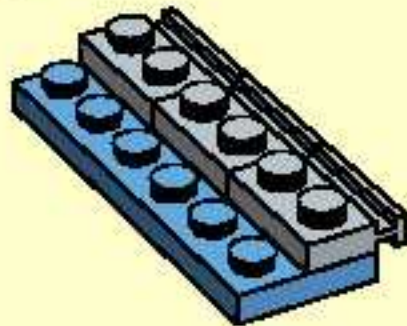

3

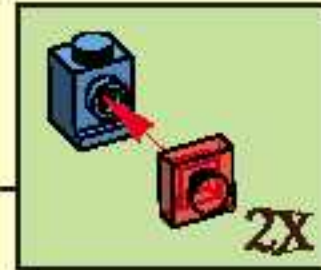
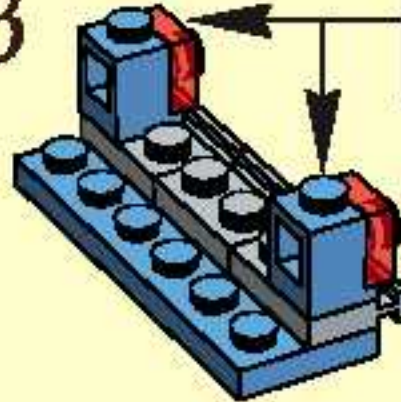

4

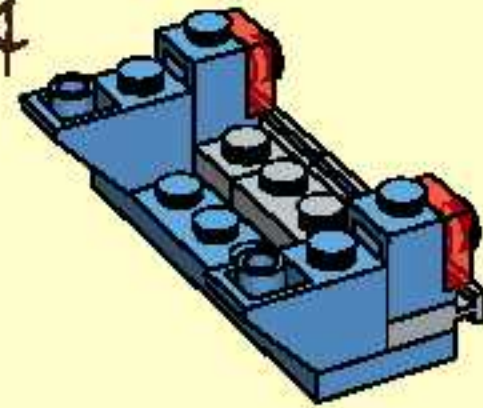

6

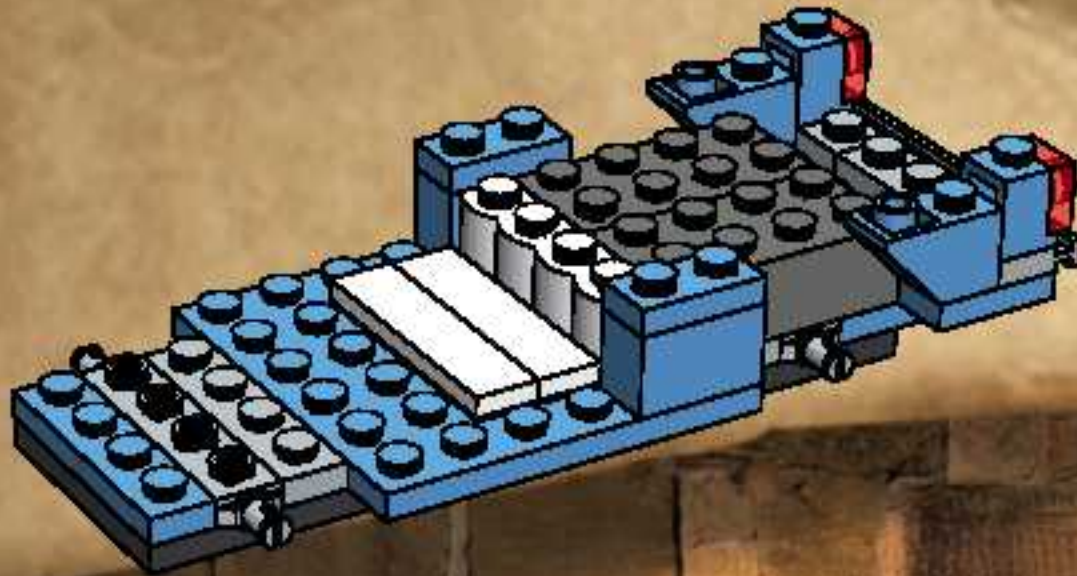

7

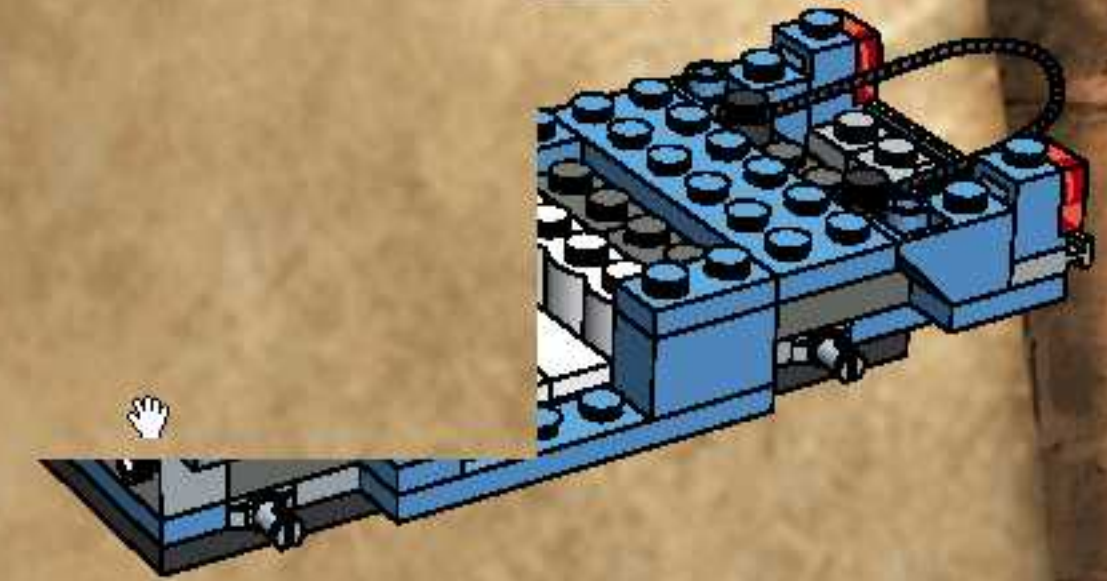
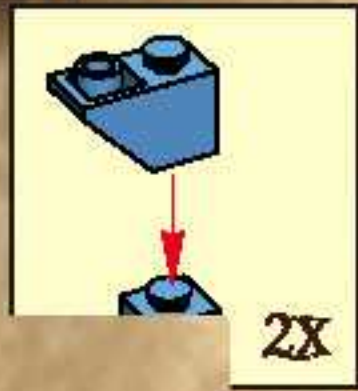
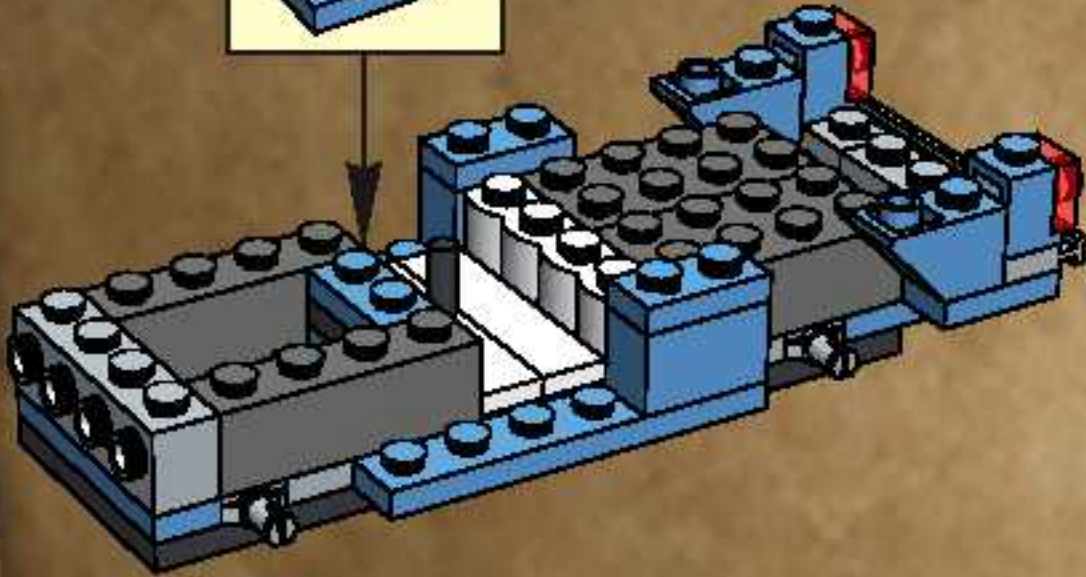
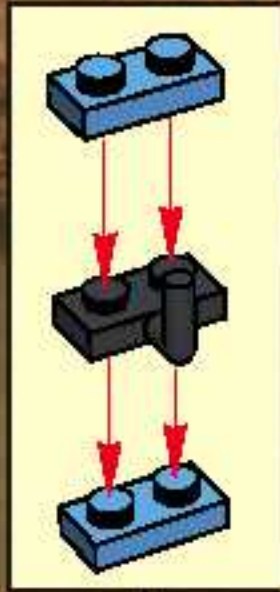

8

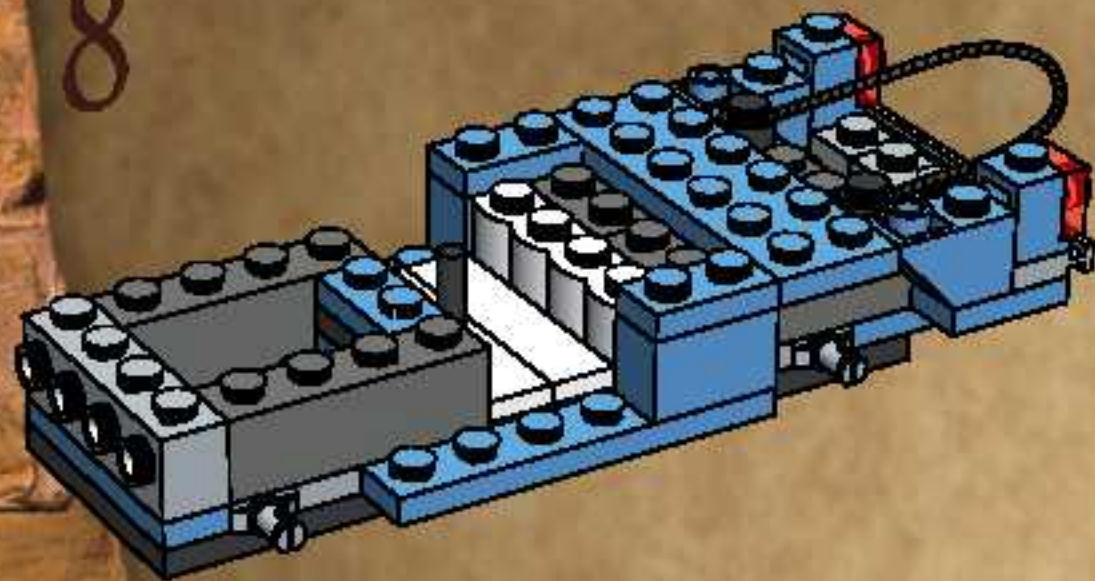

10

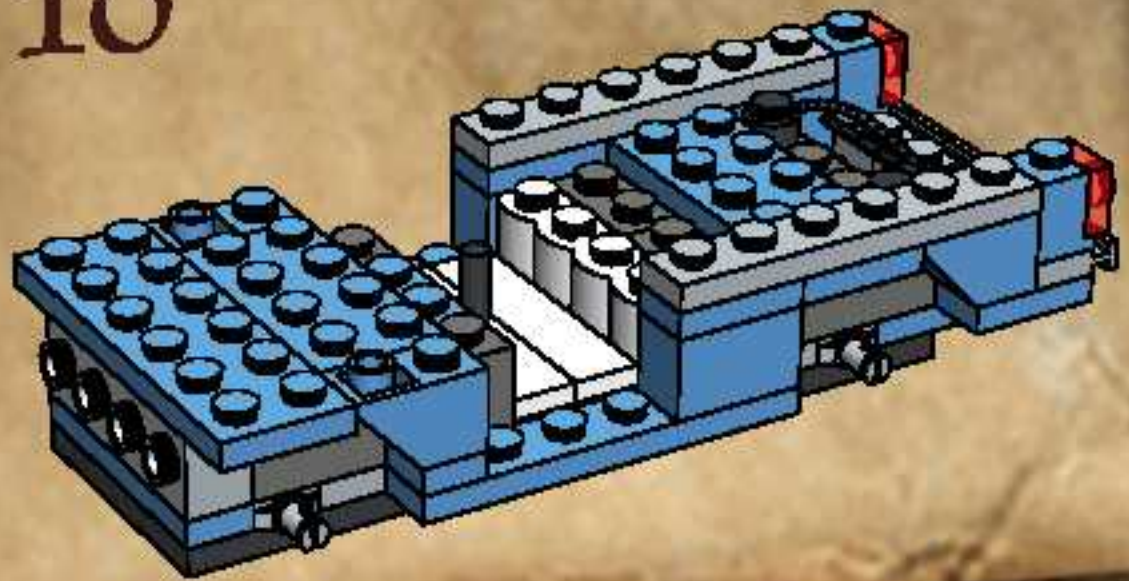

11

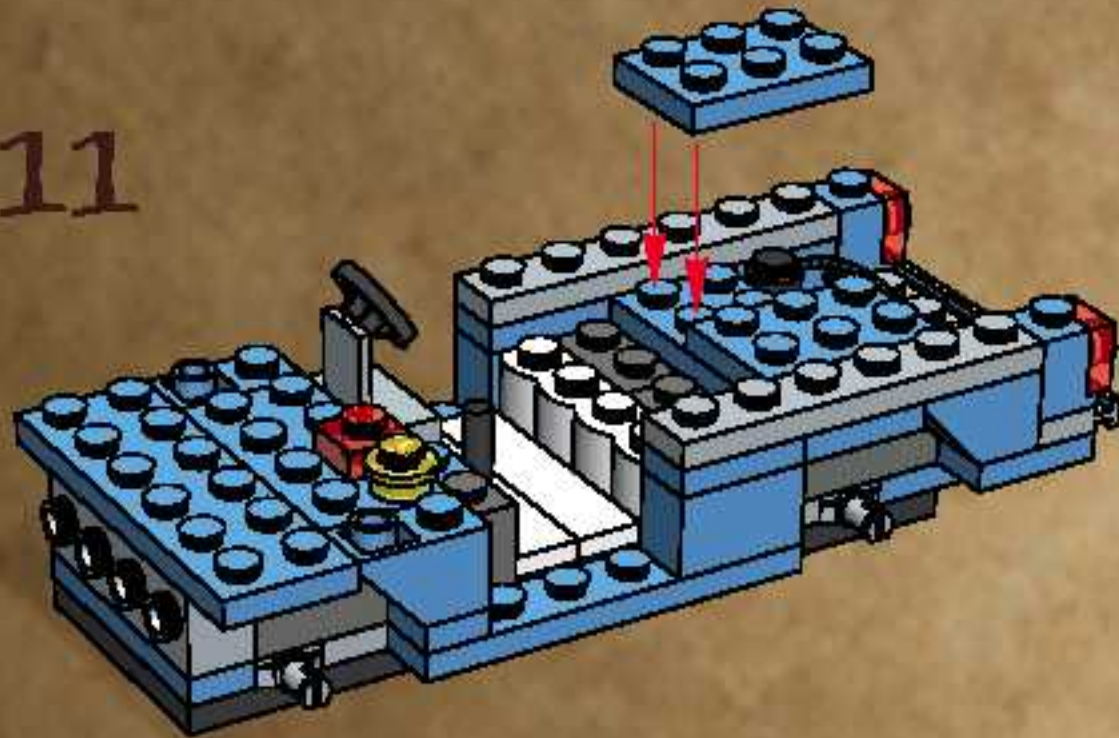

12

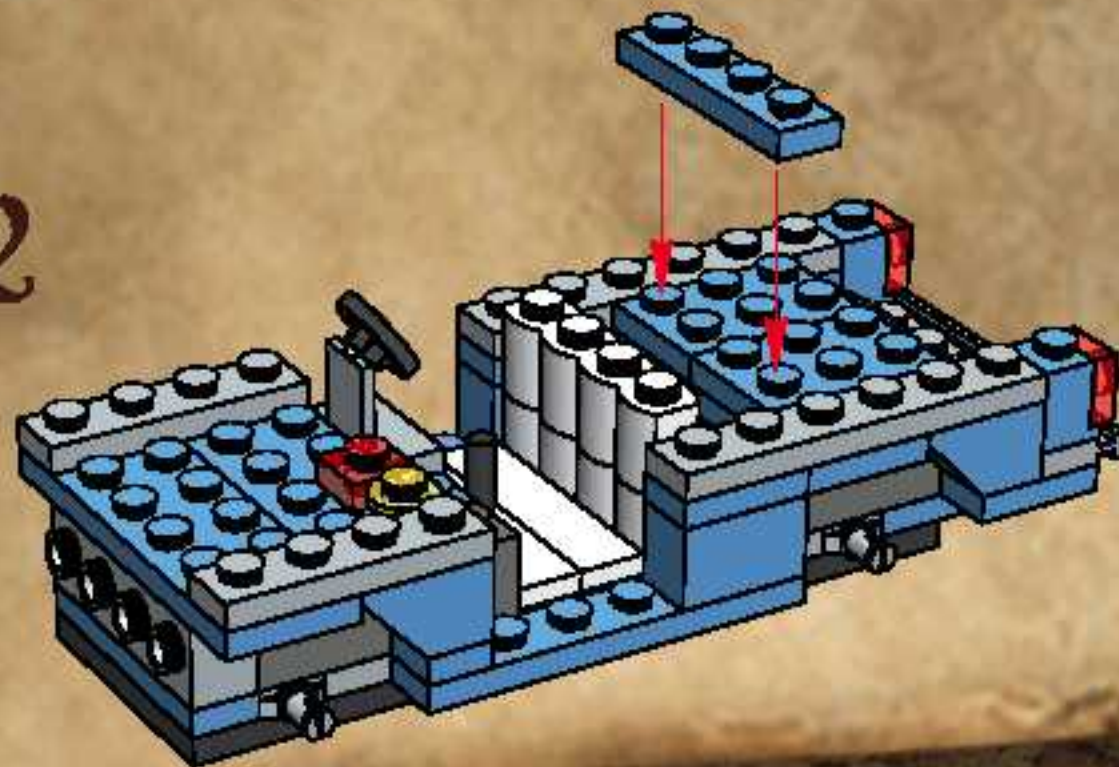

13

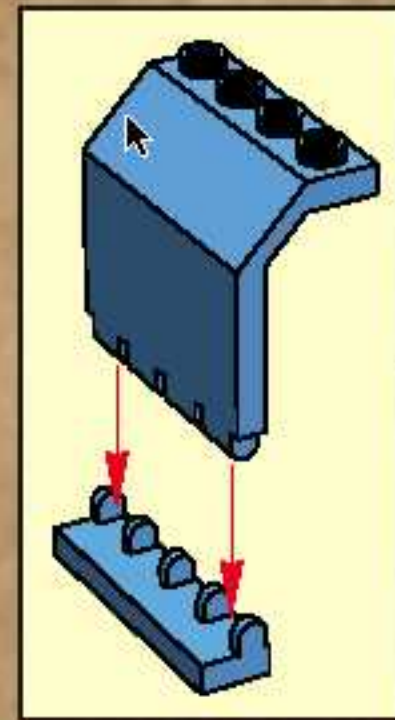
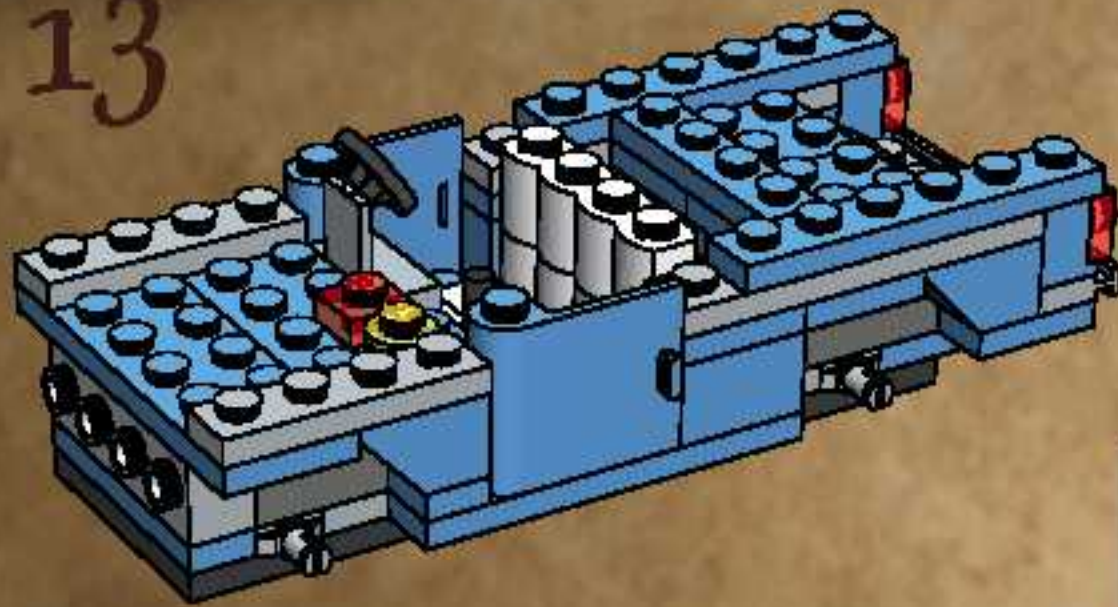

14

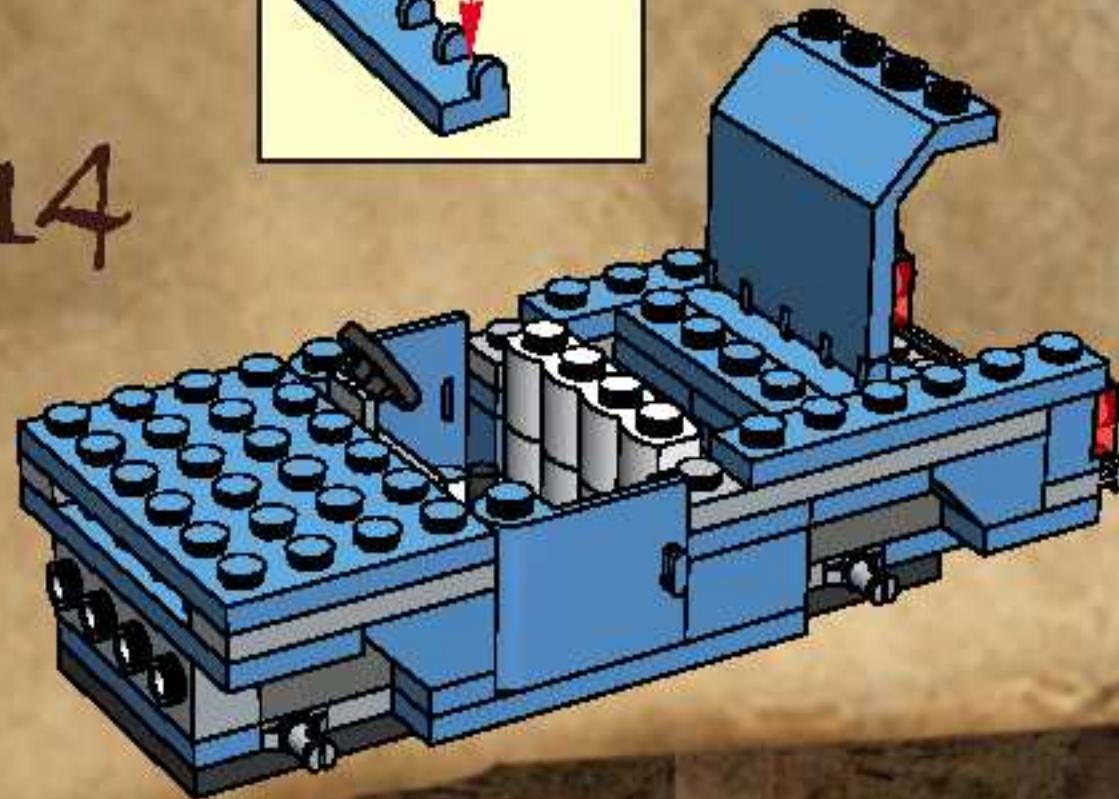

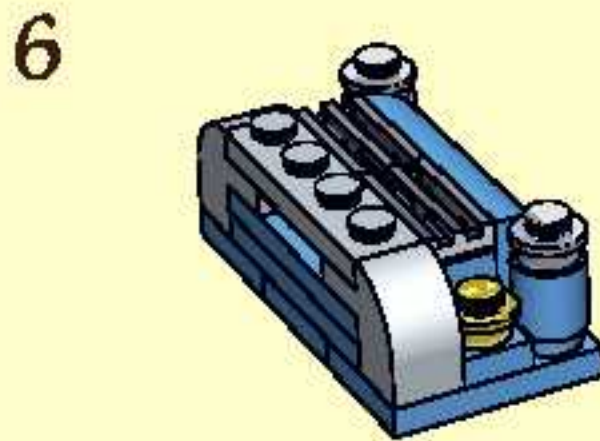
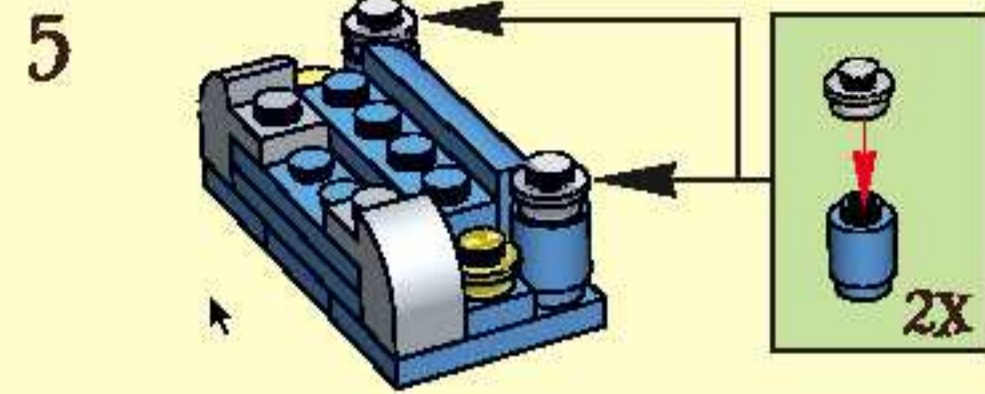
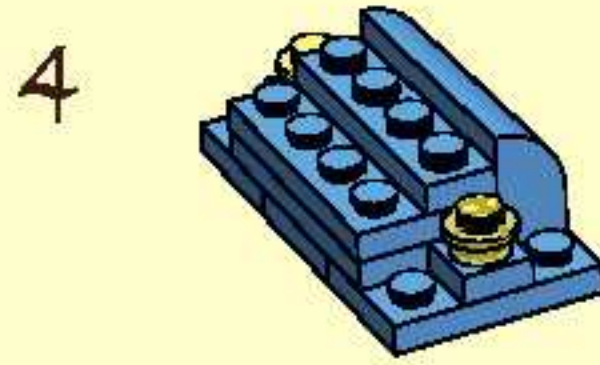
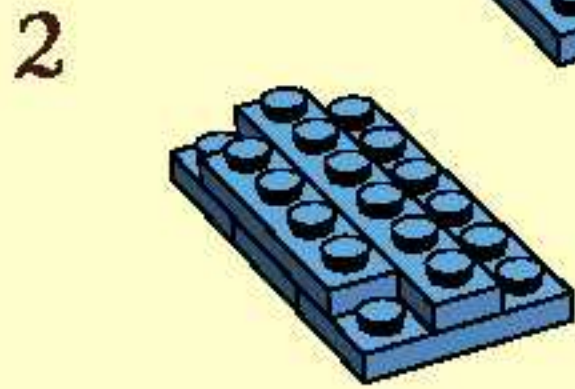
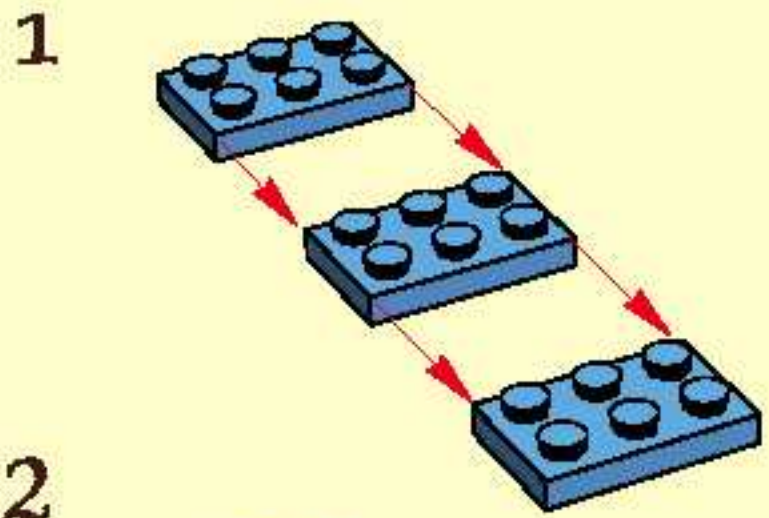

15

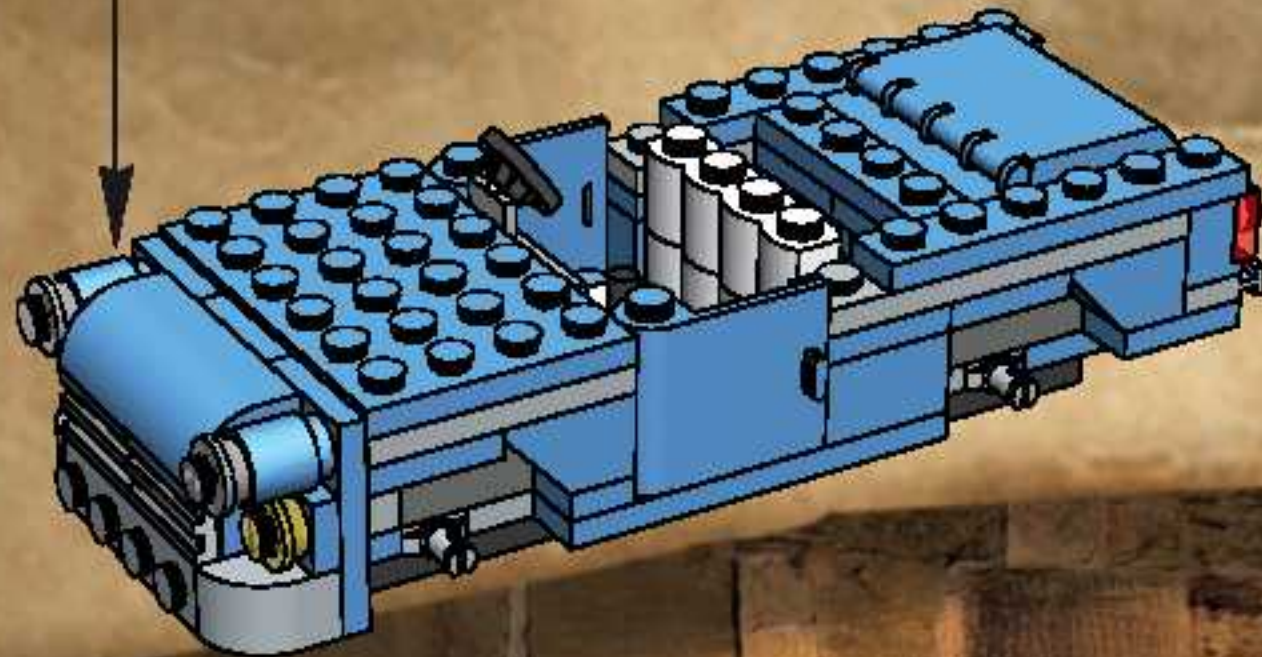

16

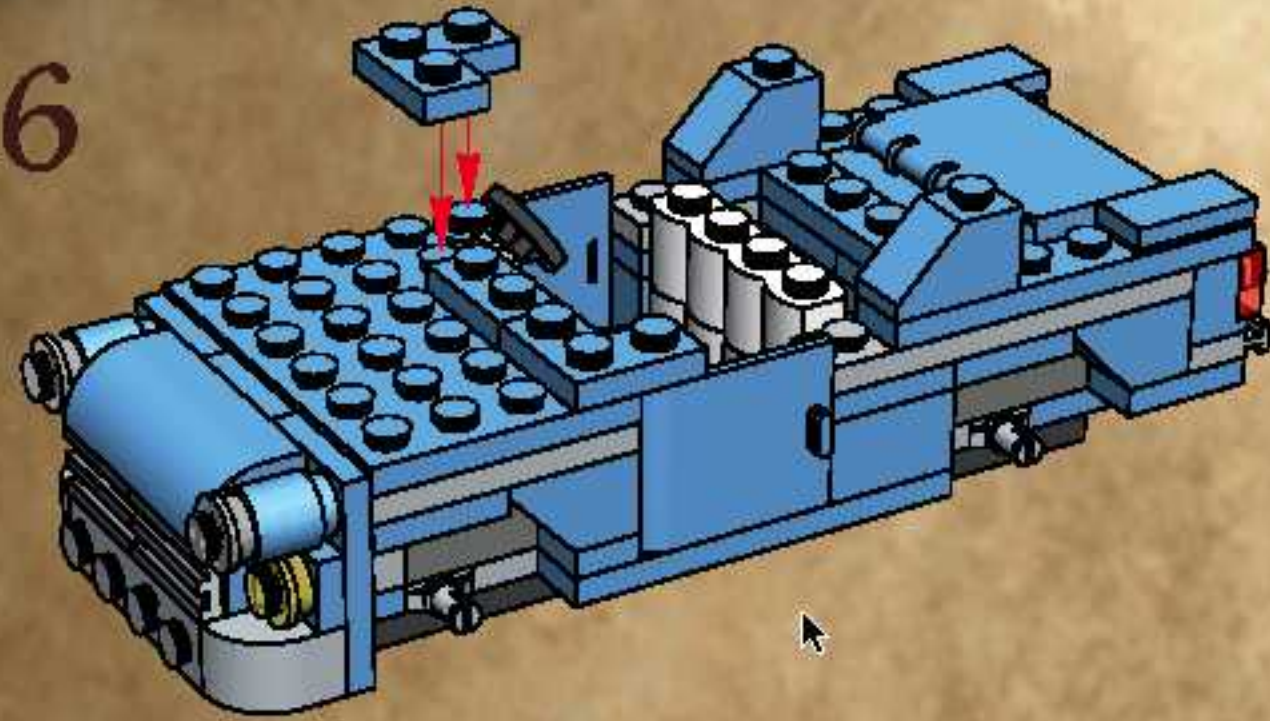

17

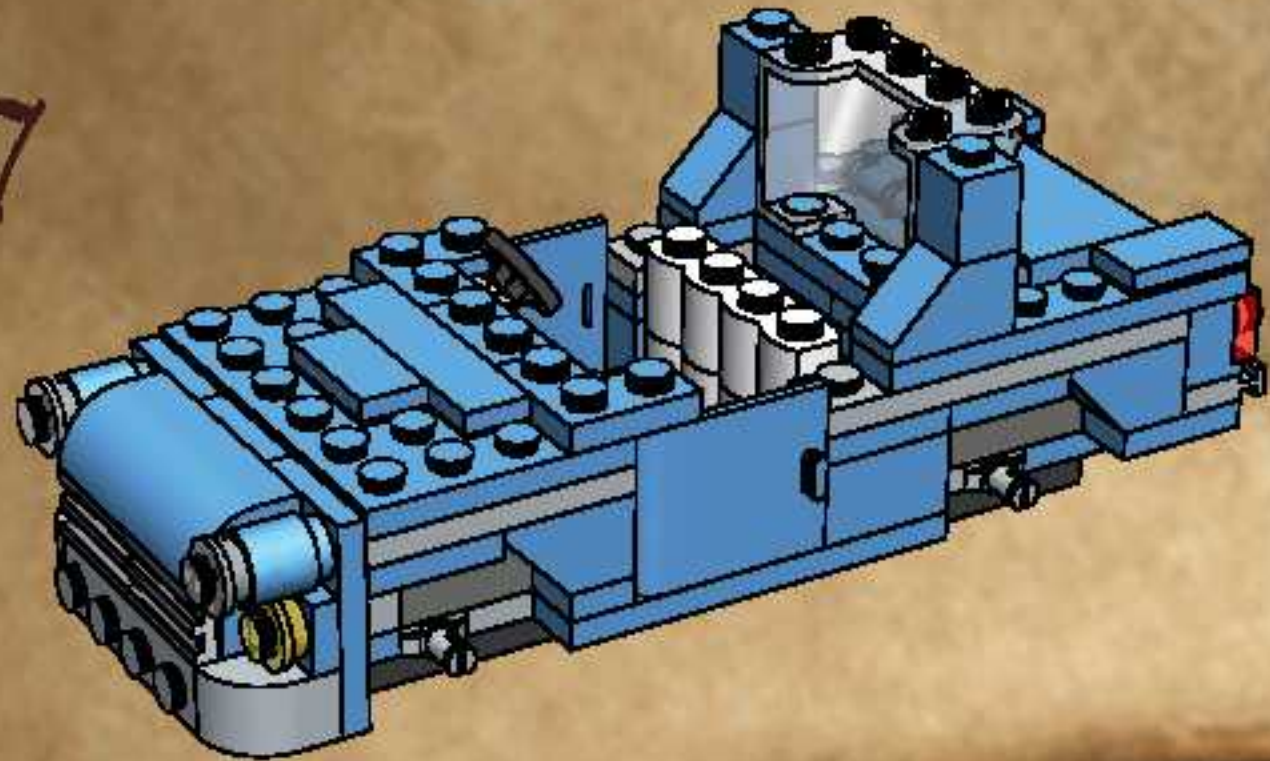



18

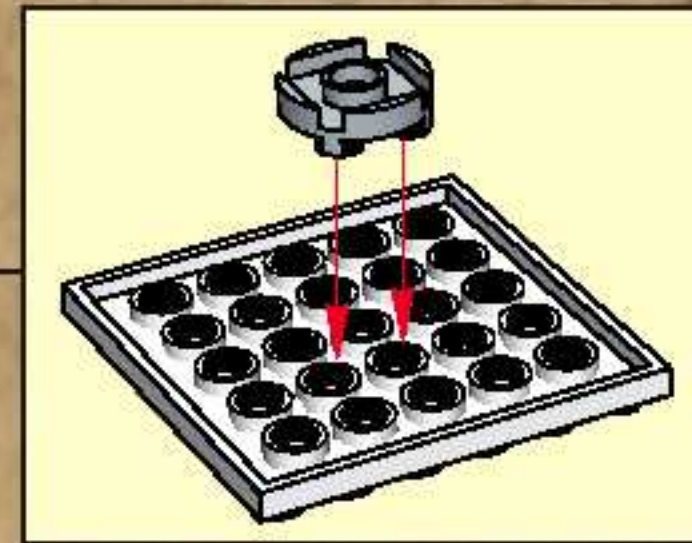
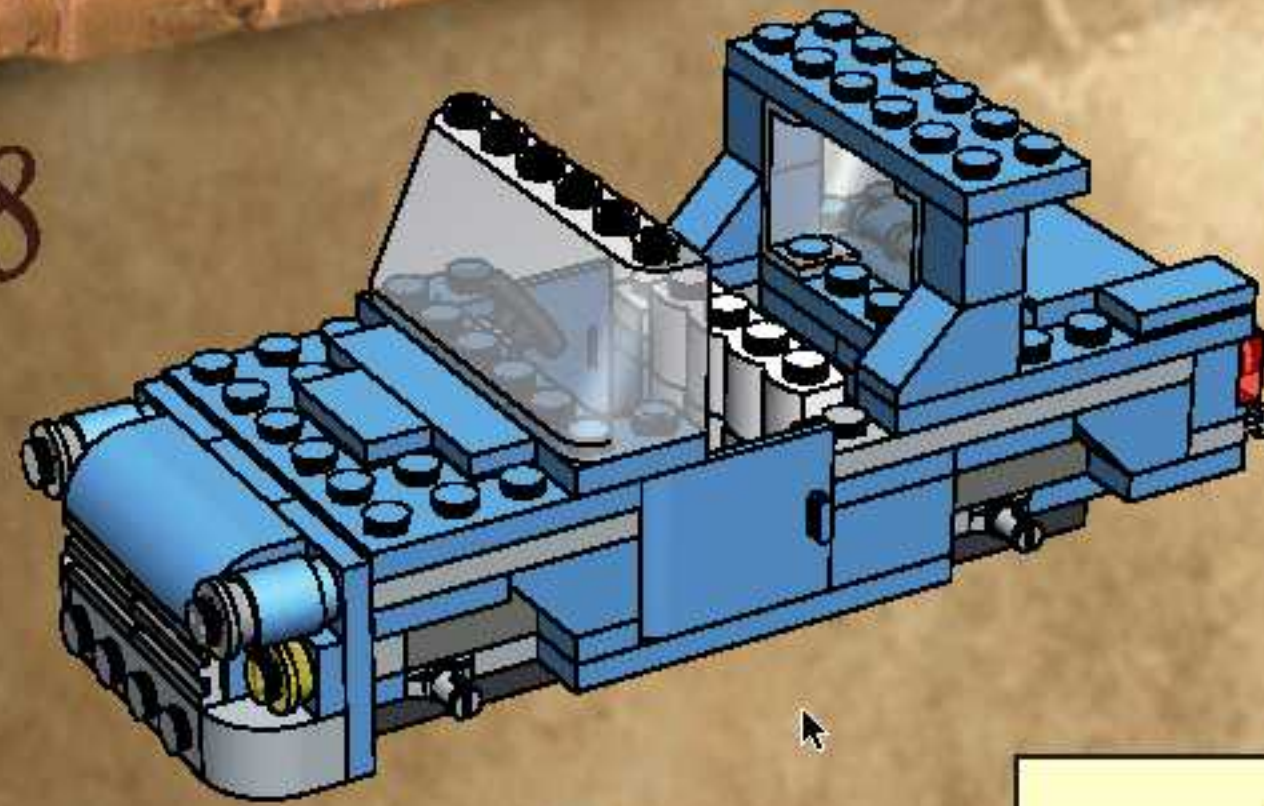

19

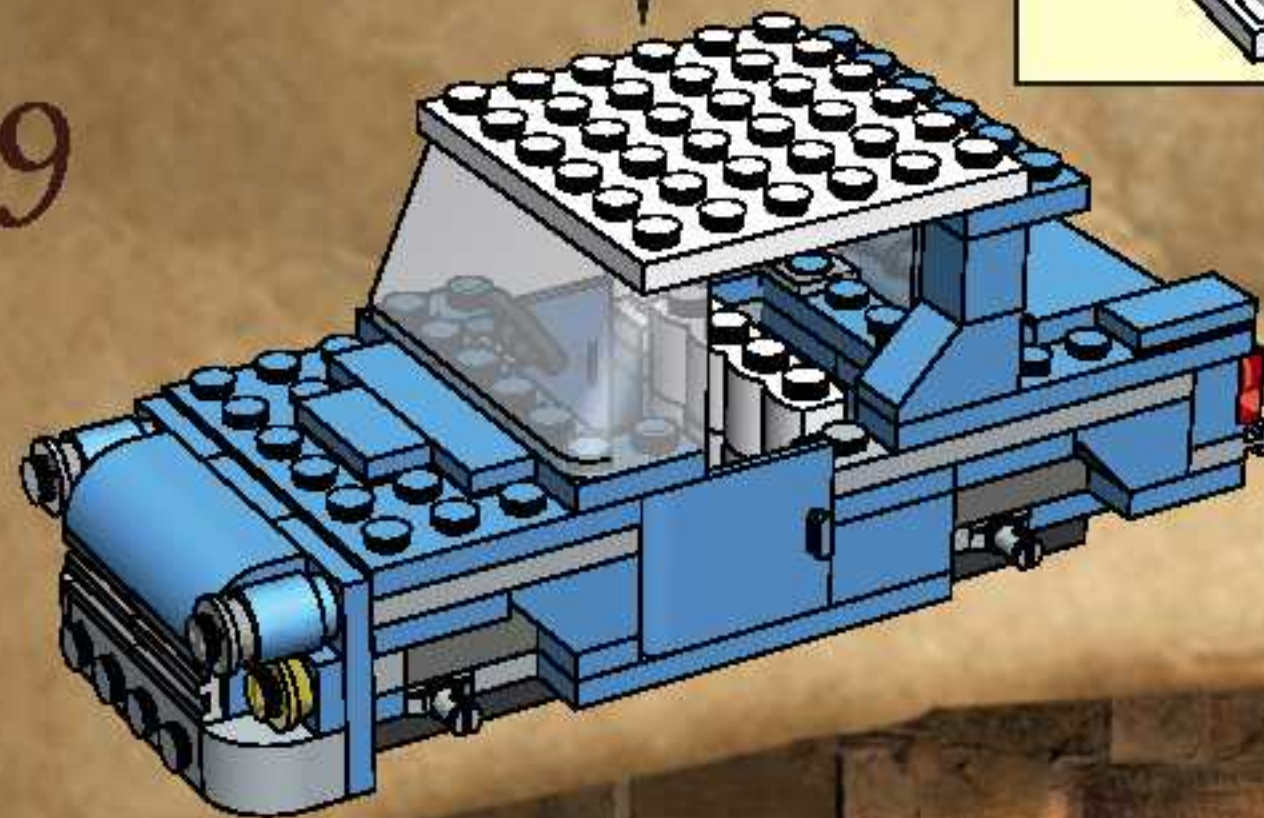

20

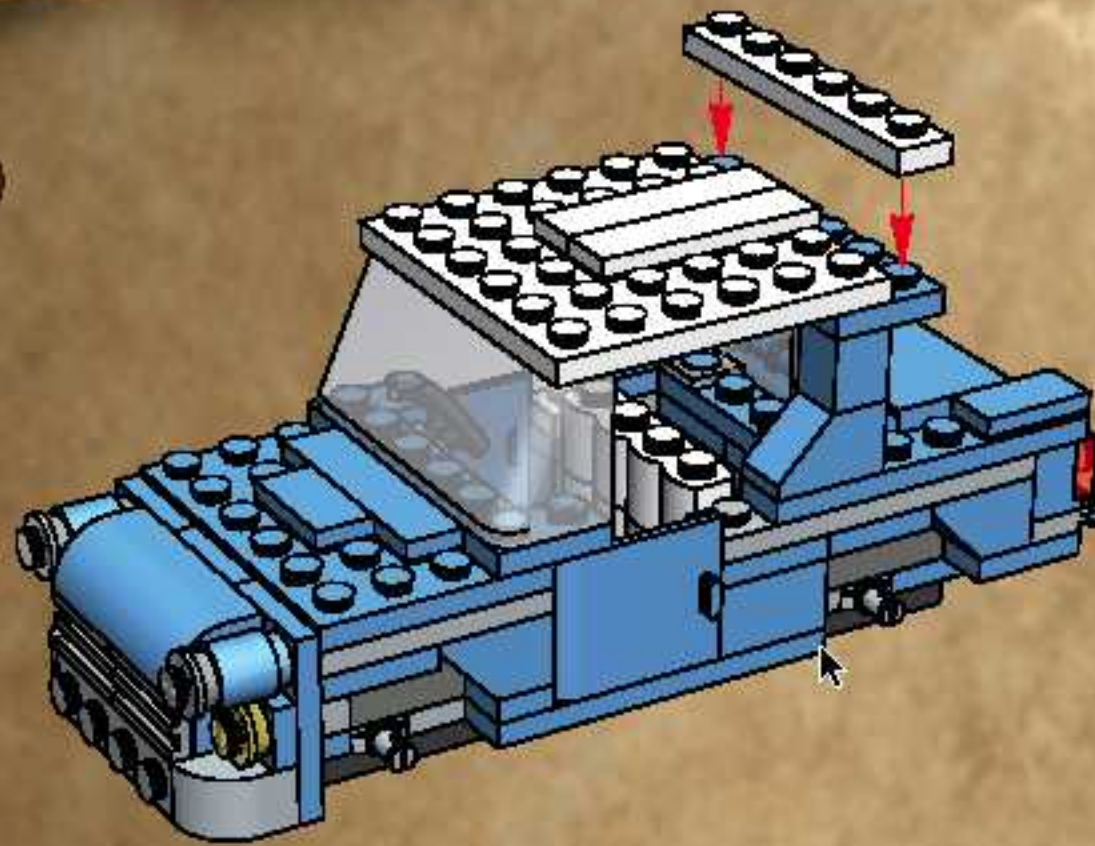

21

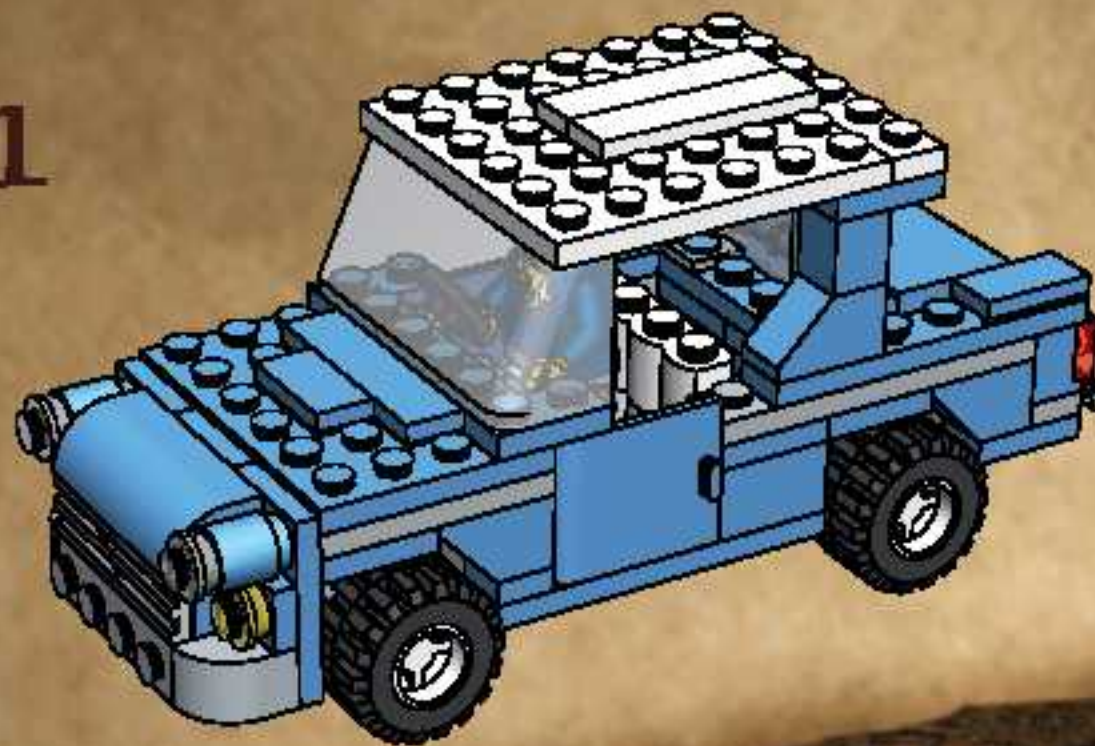

1

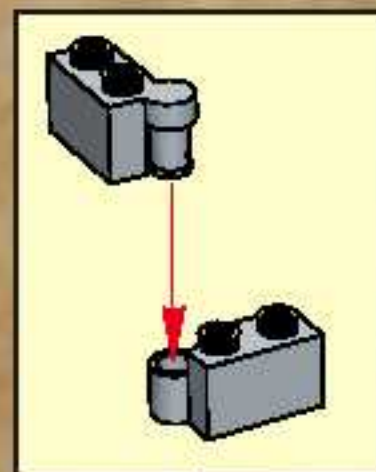
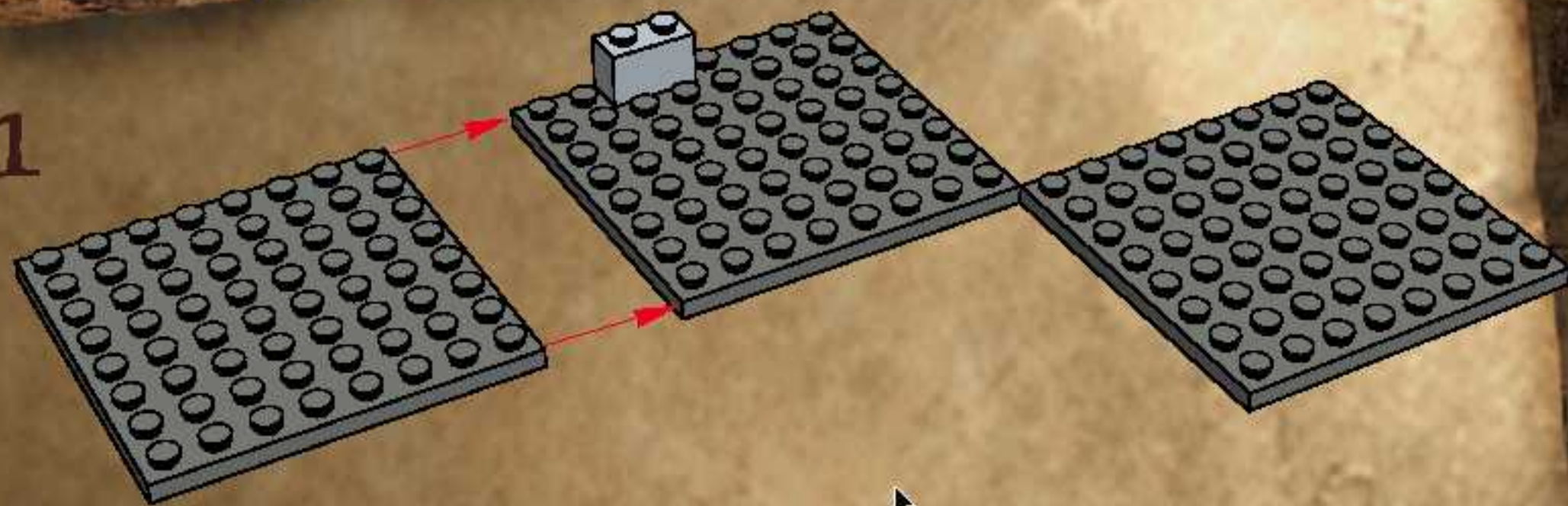

2

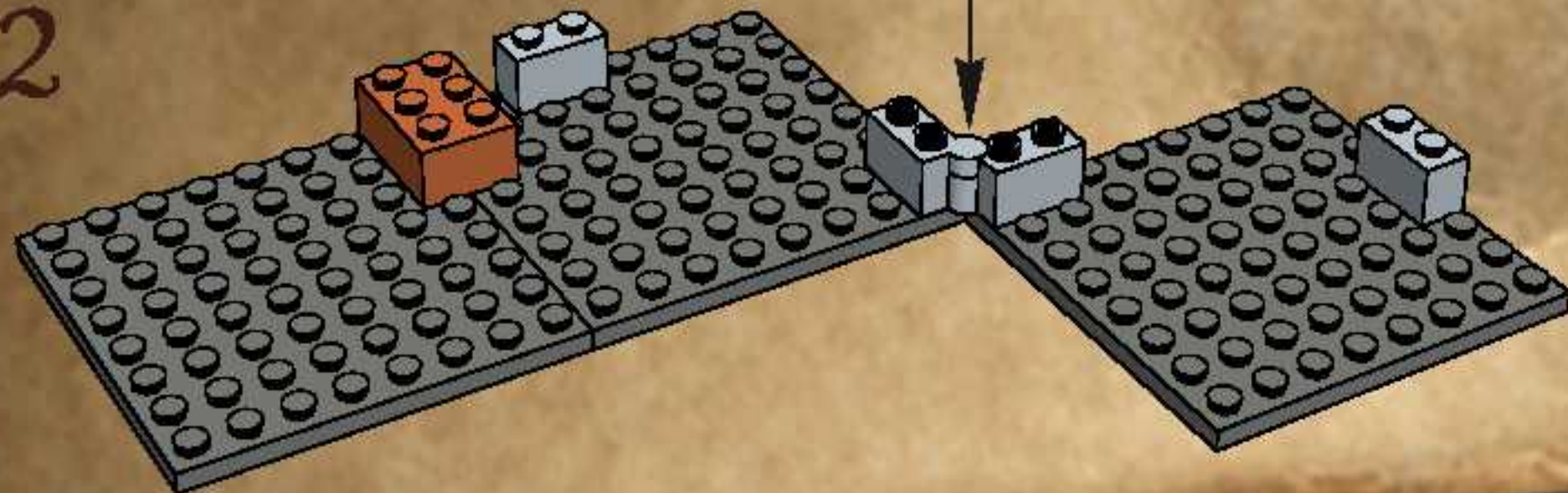

3

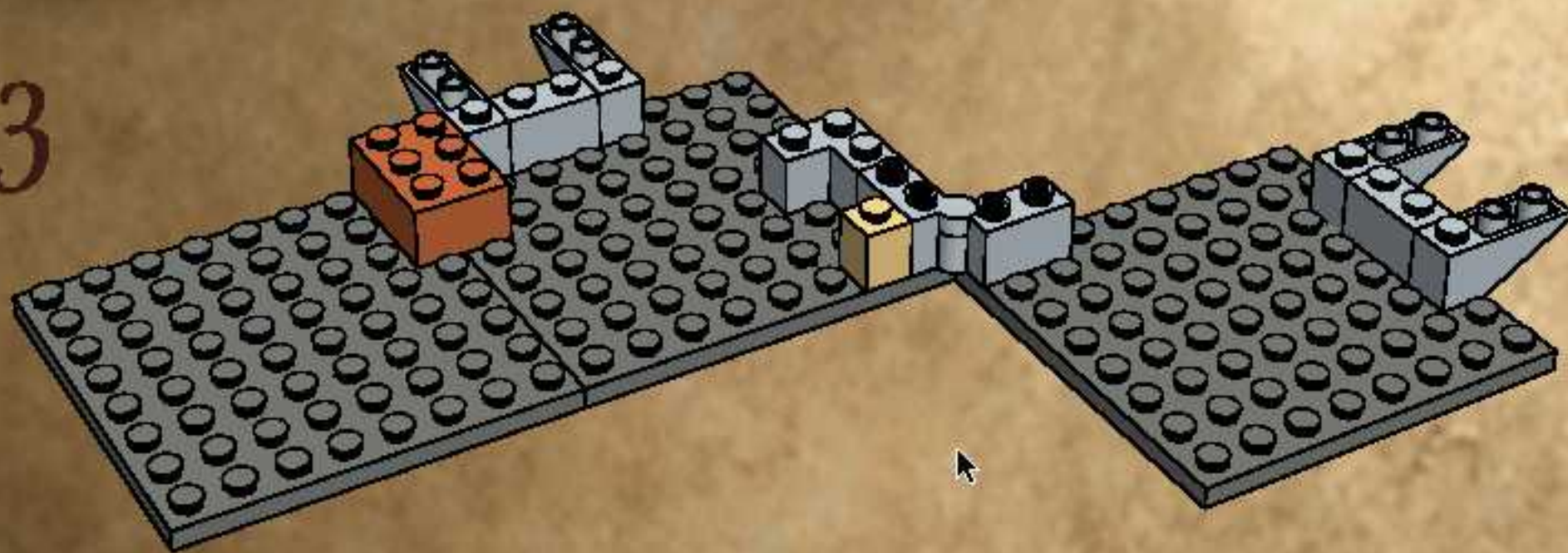

4

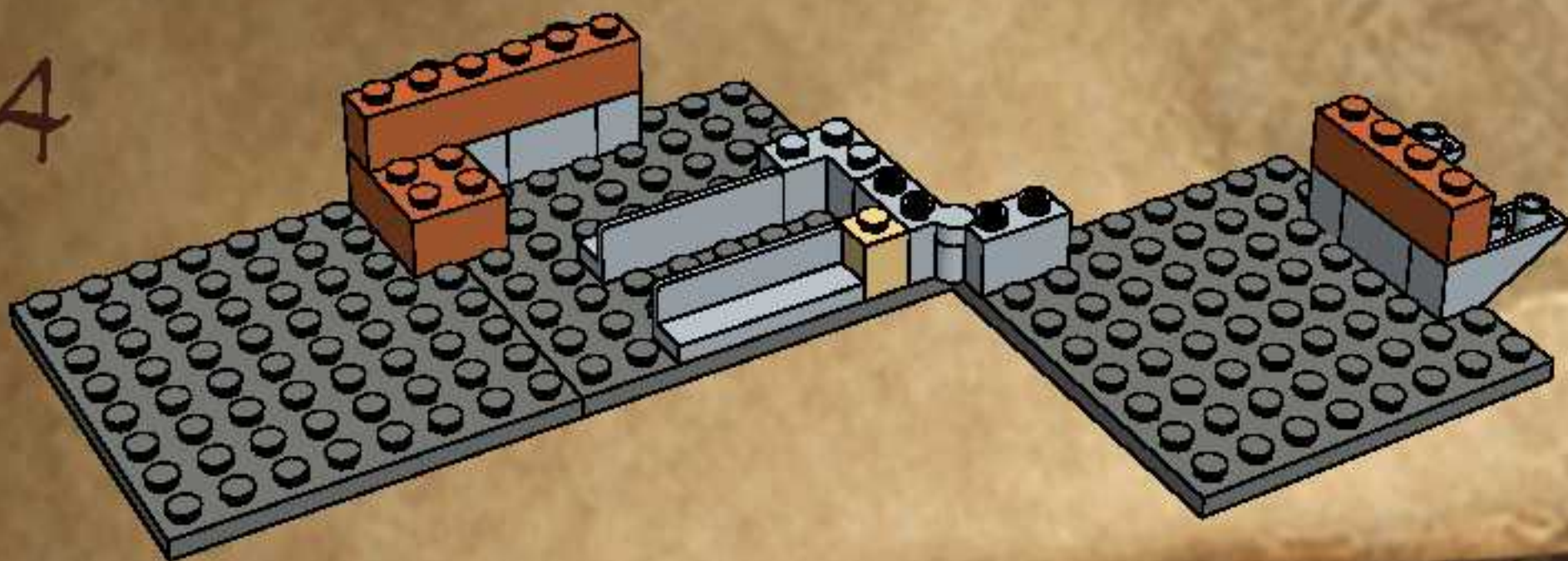

5

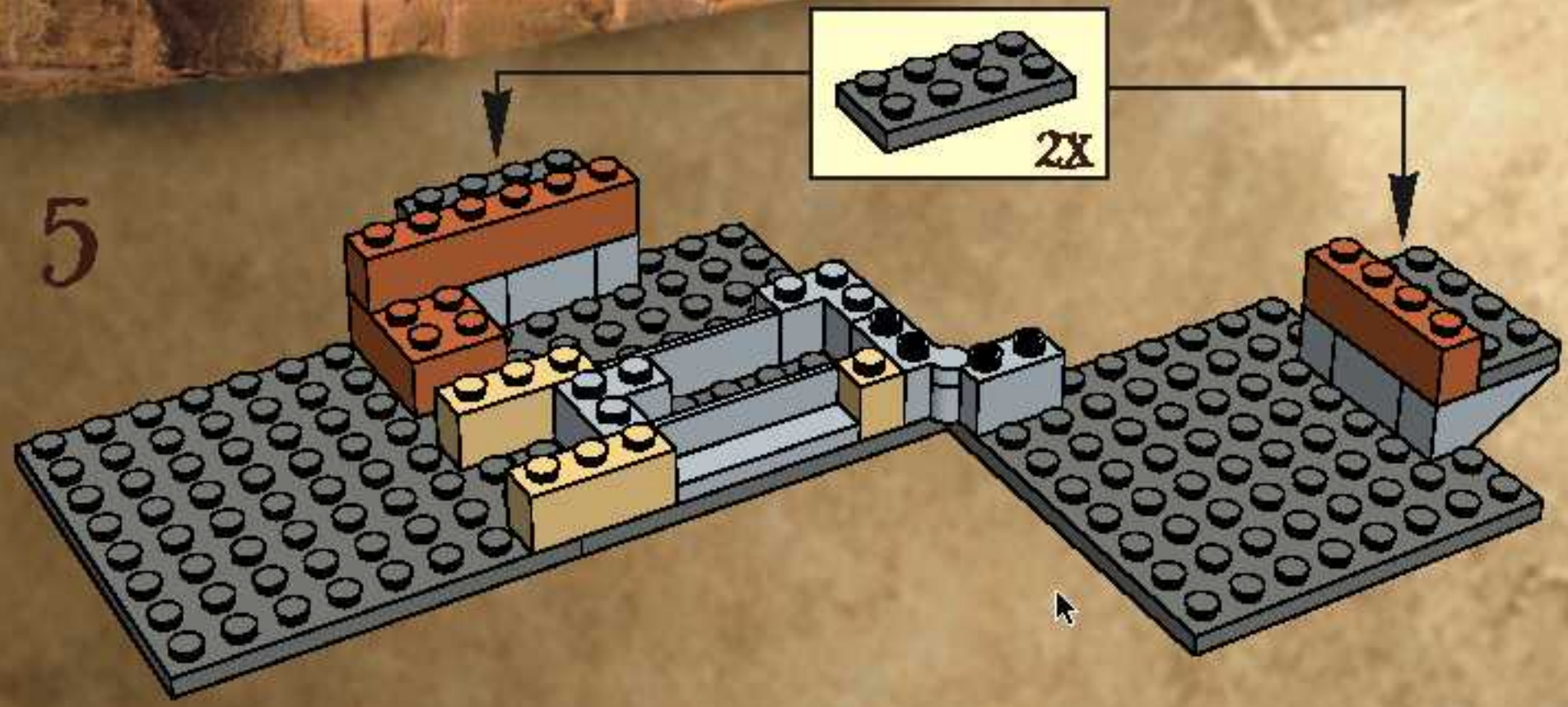

6

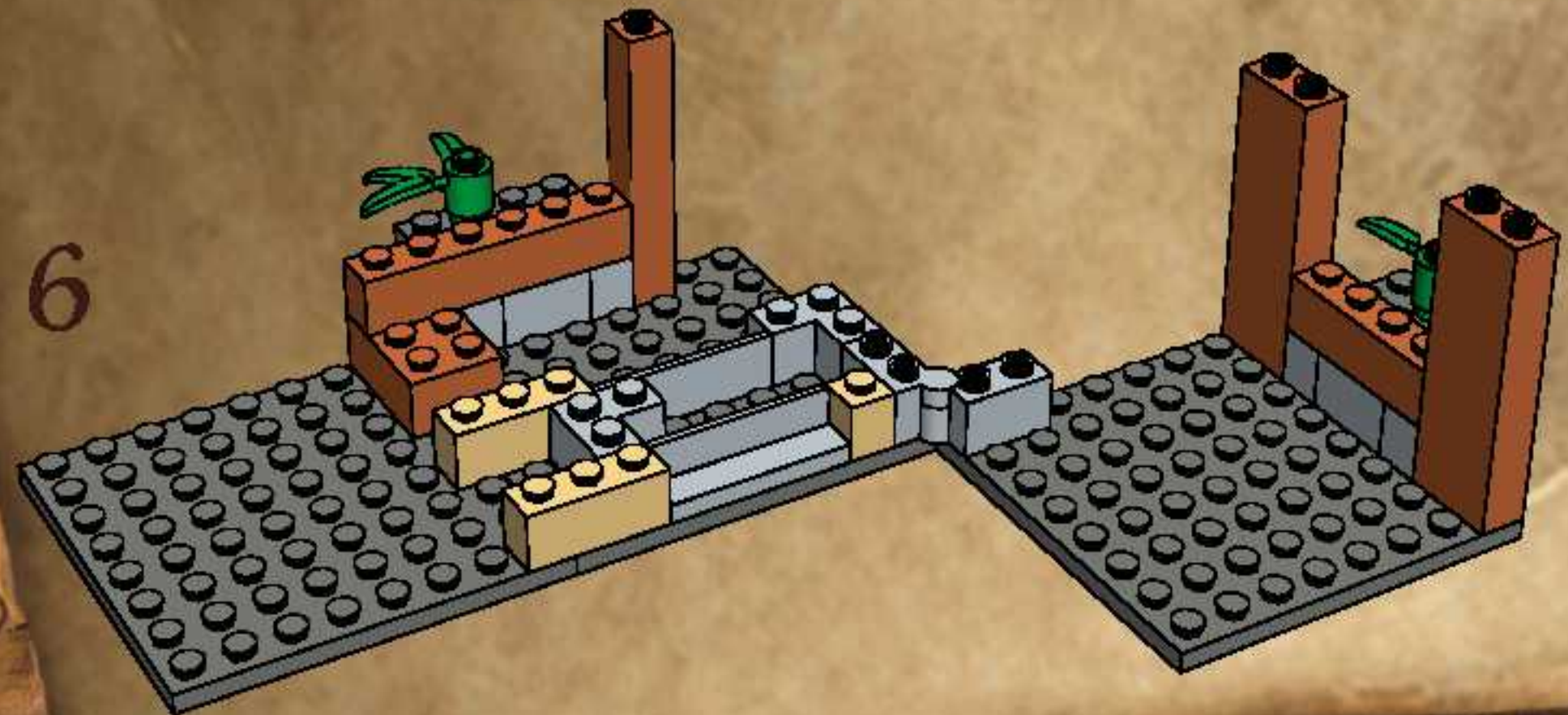

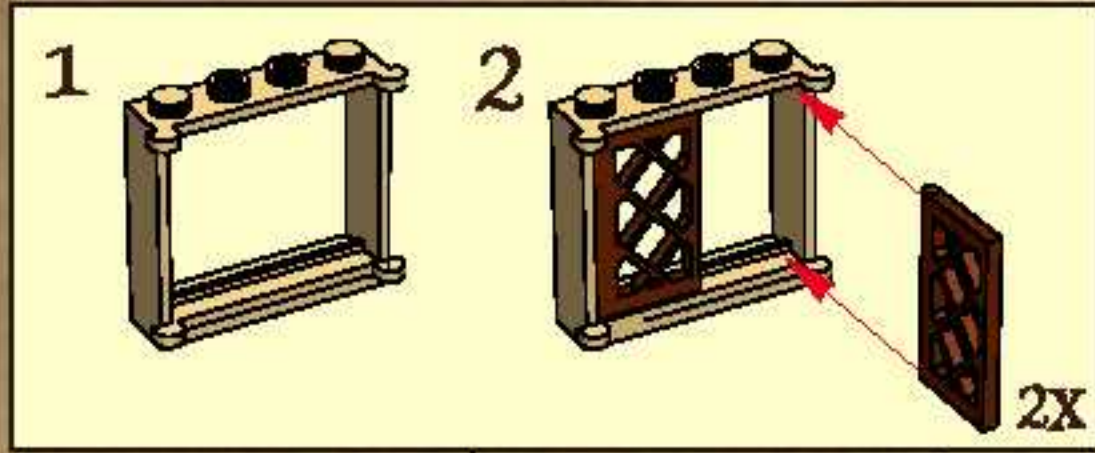

7

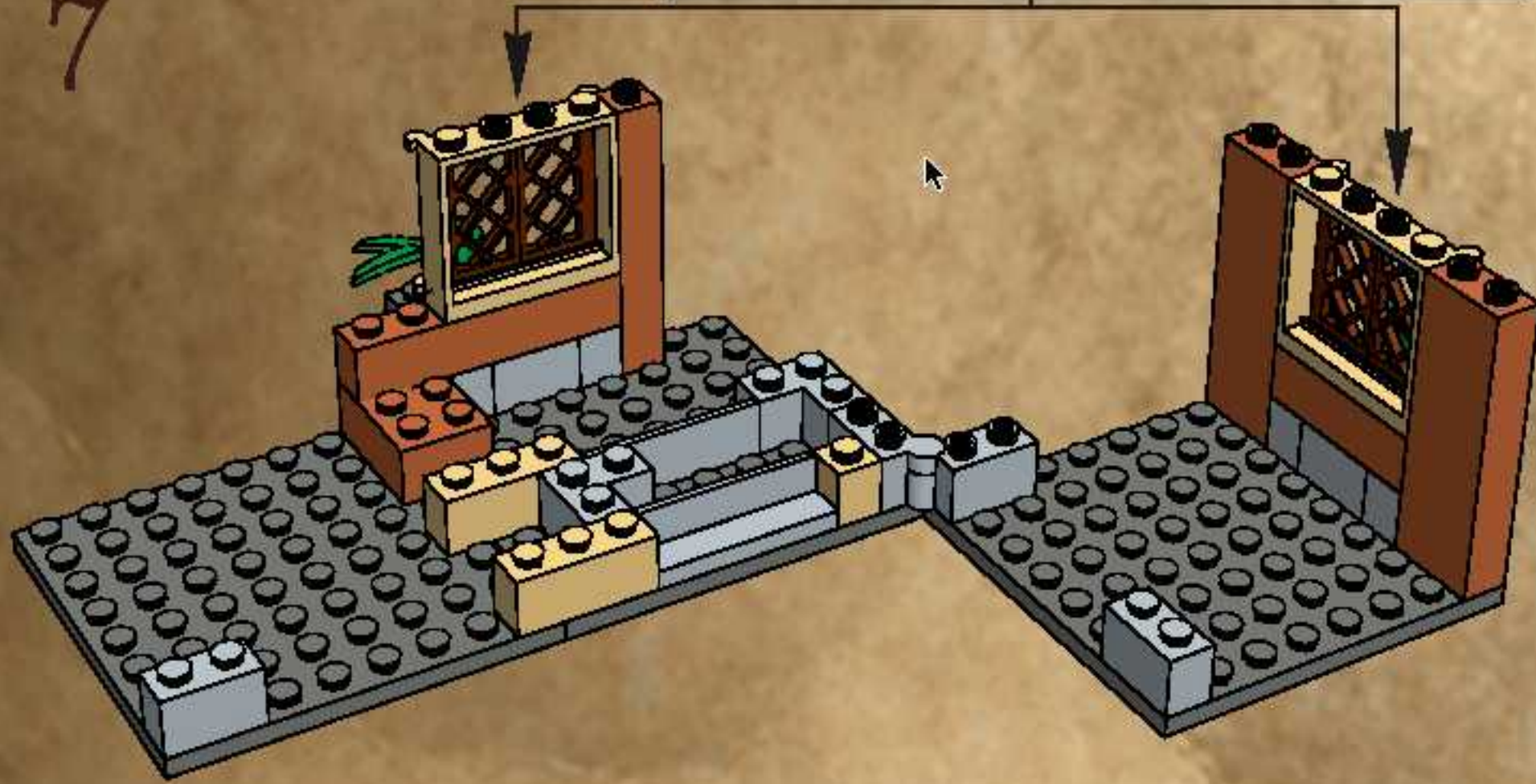

8

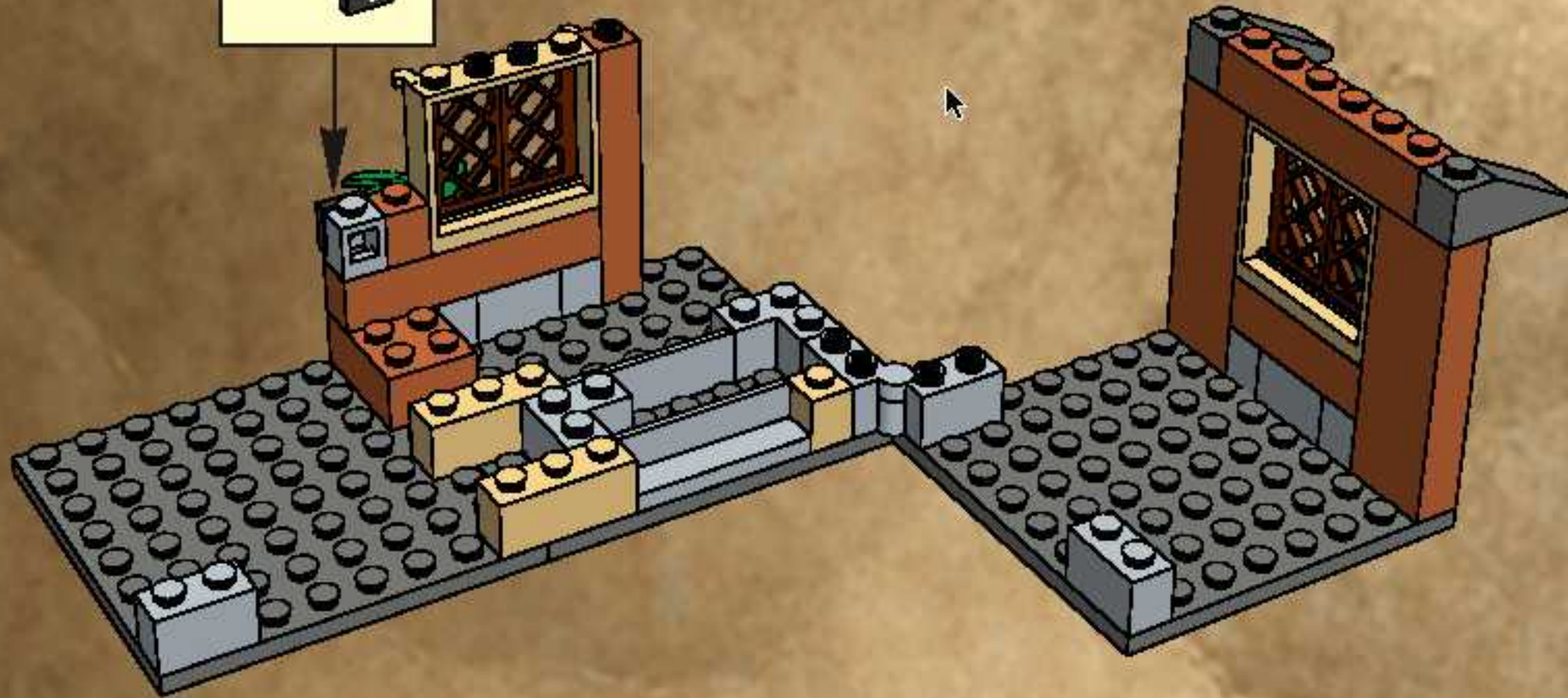
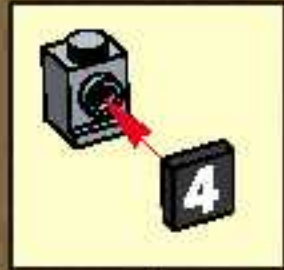

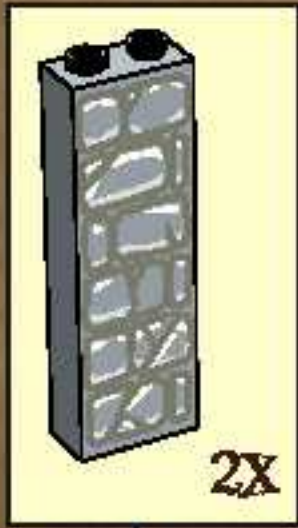

9

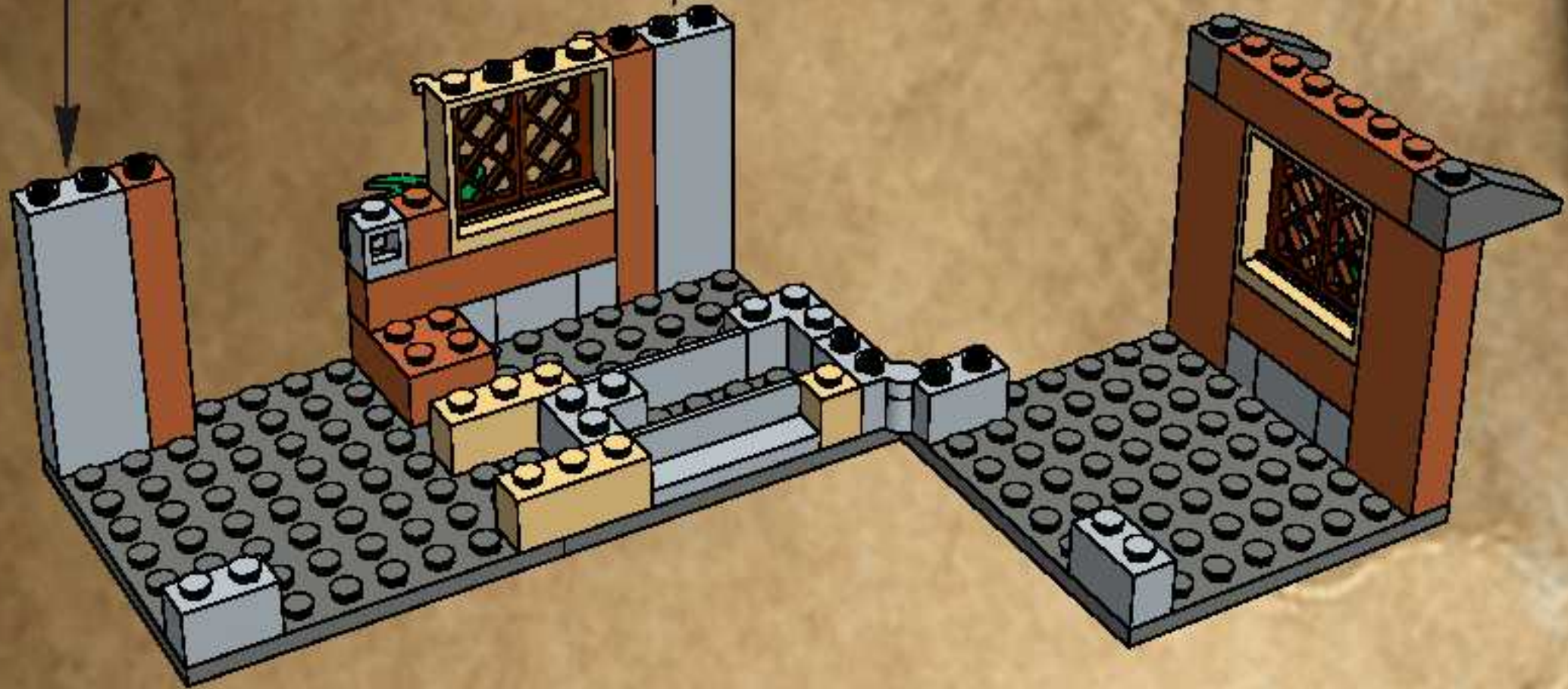



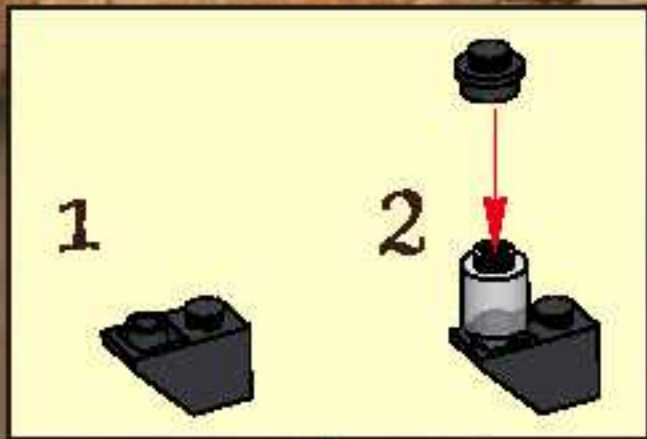

10

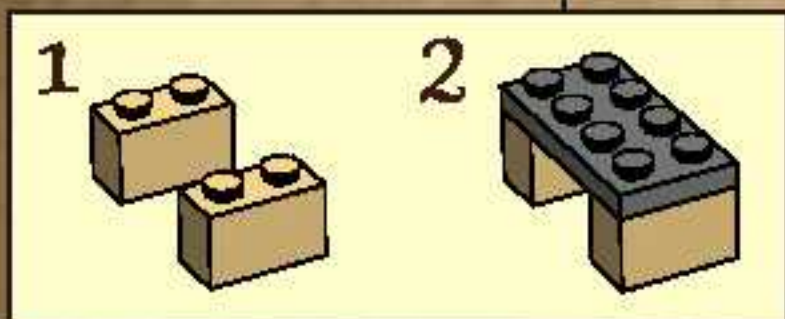
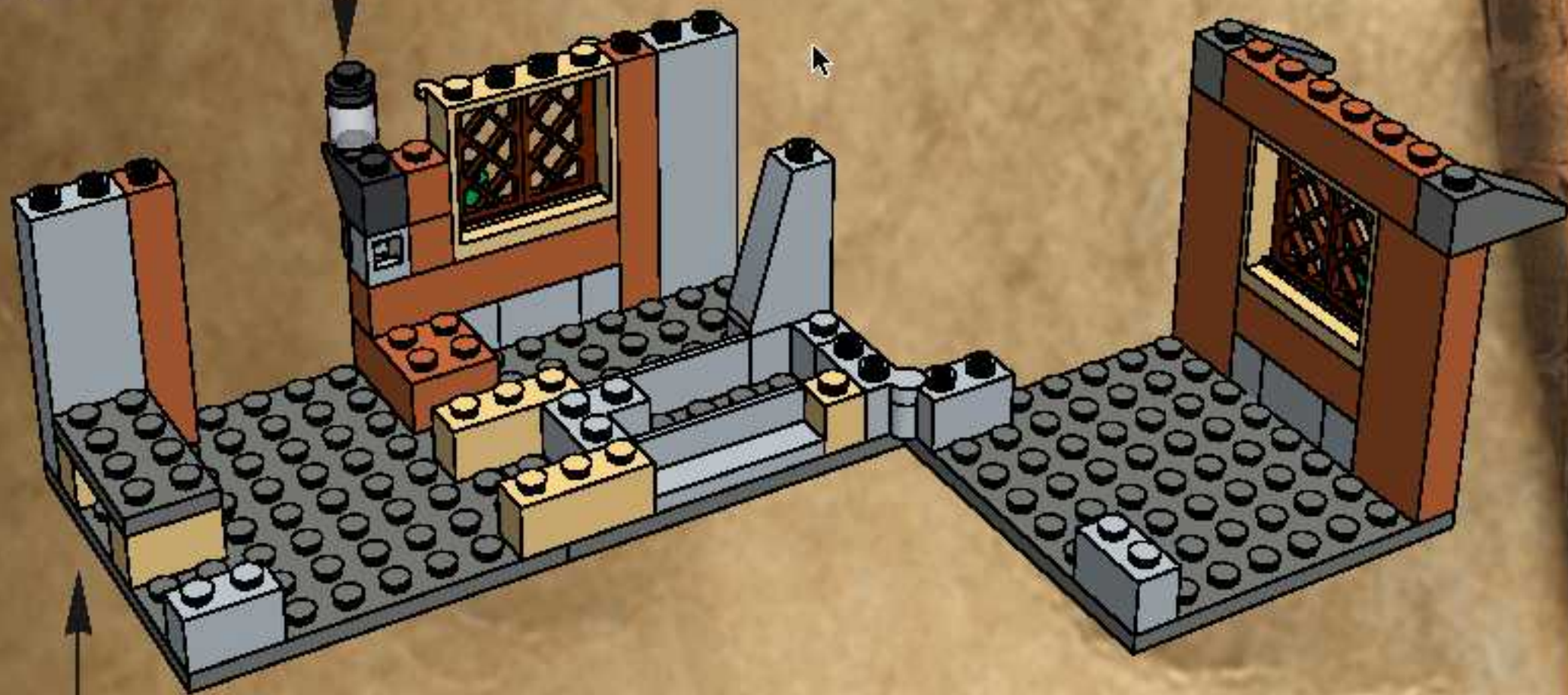

11

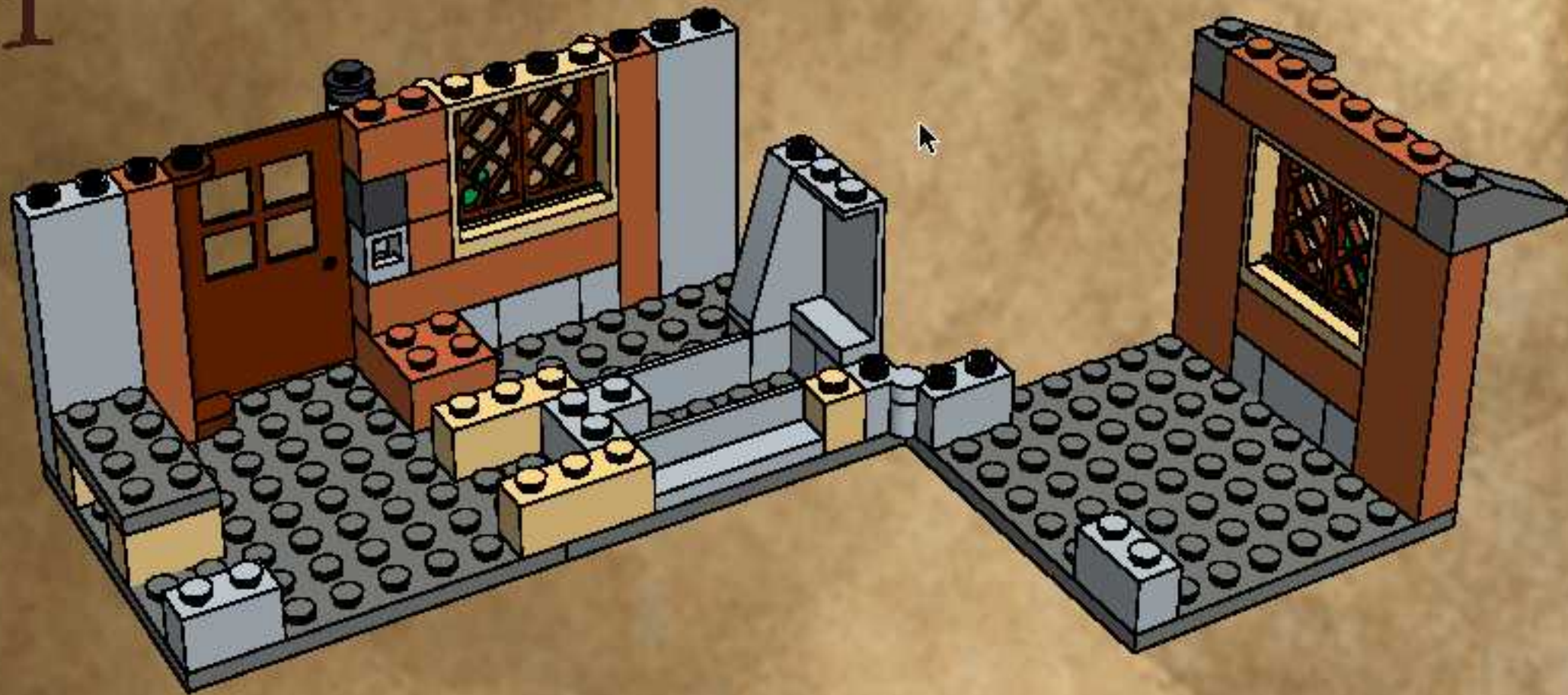

12

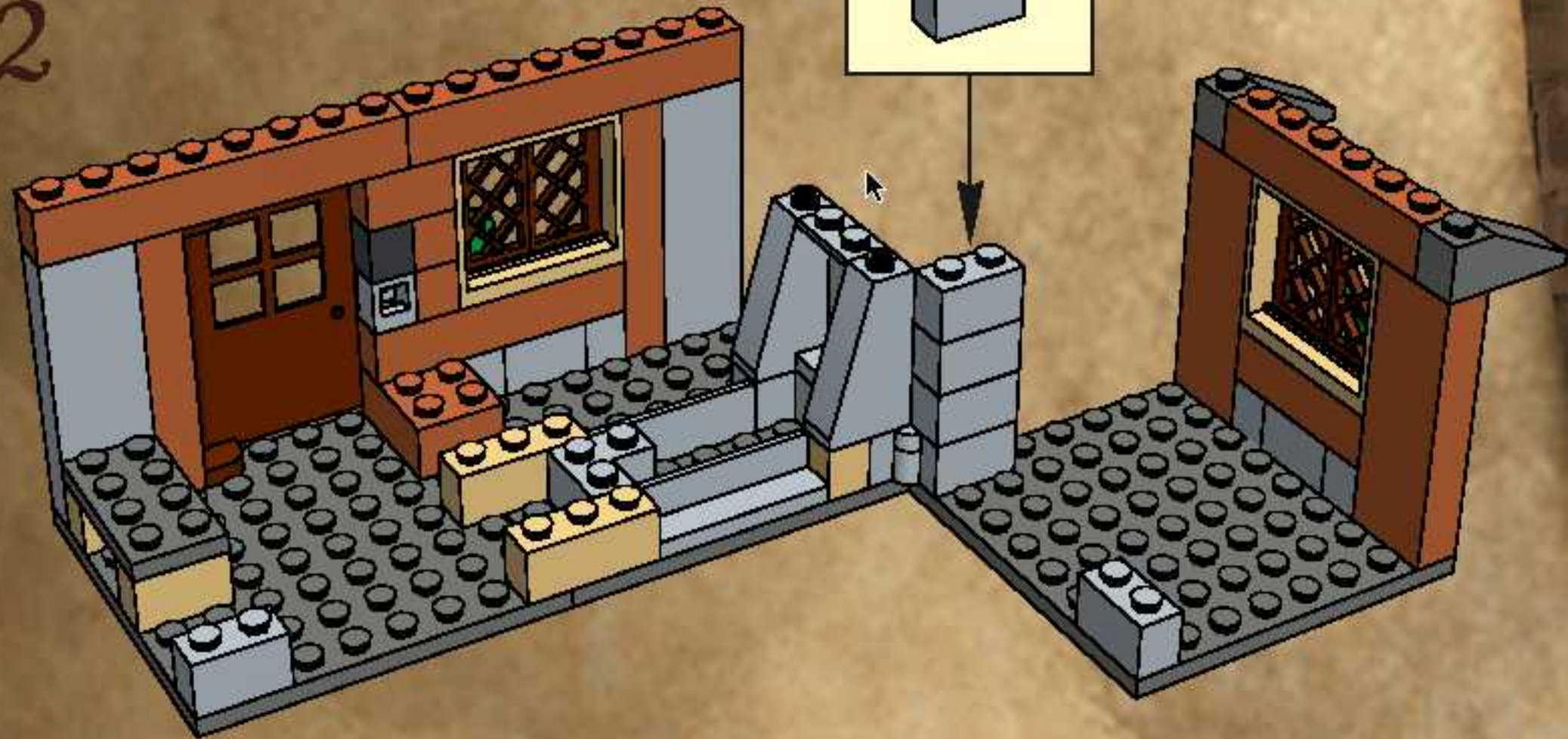
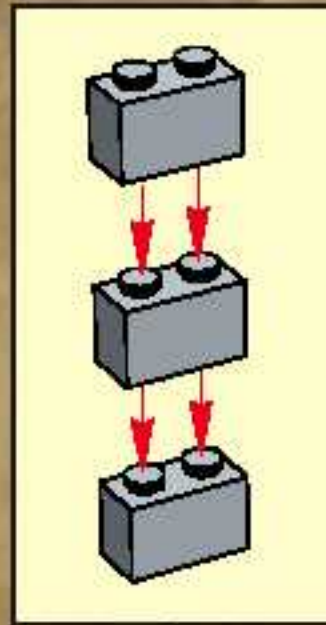

13

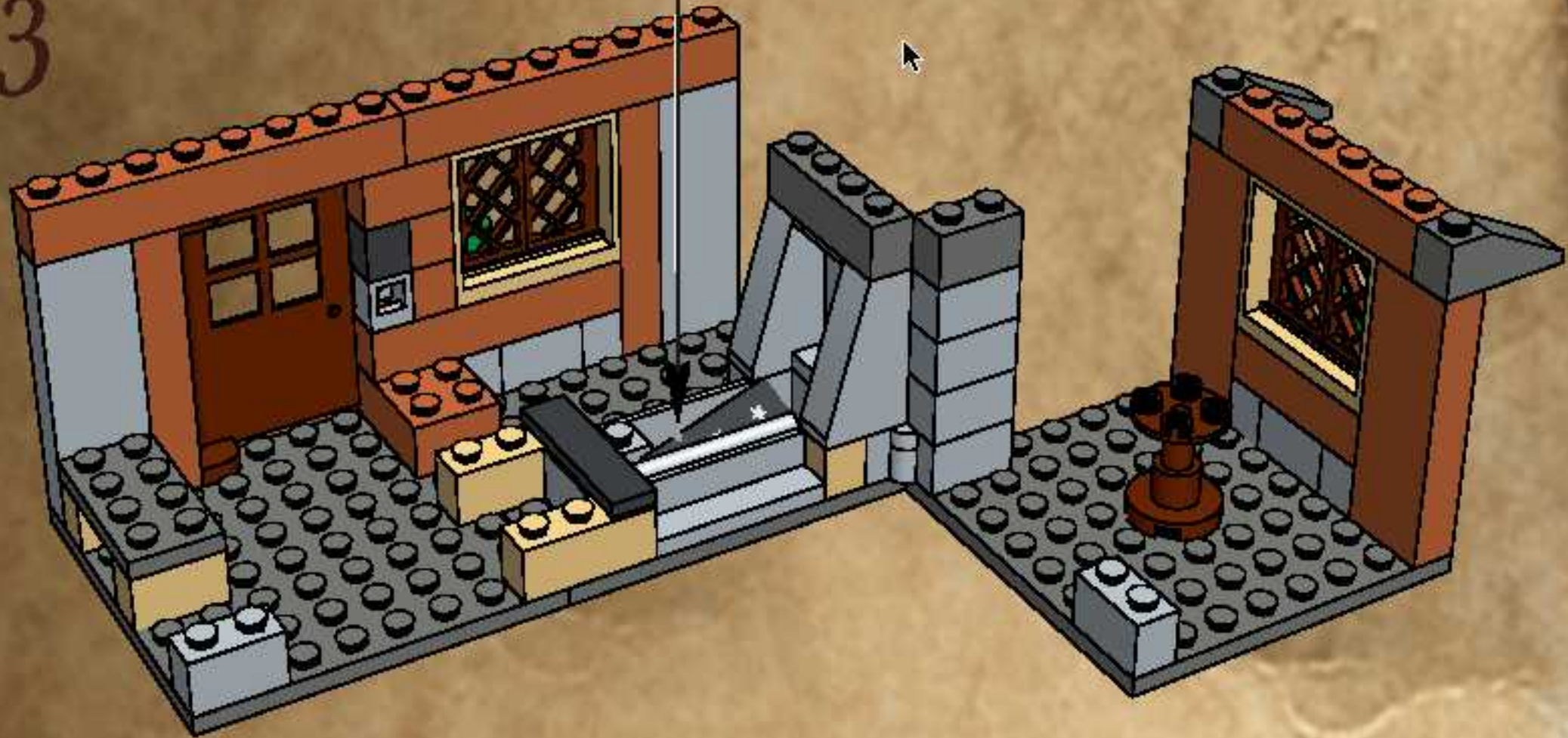
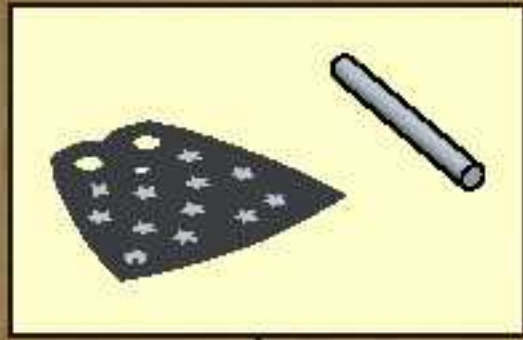

14



15

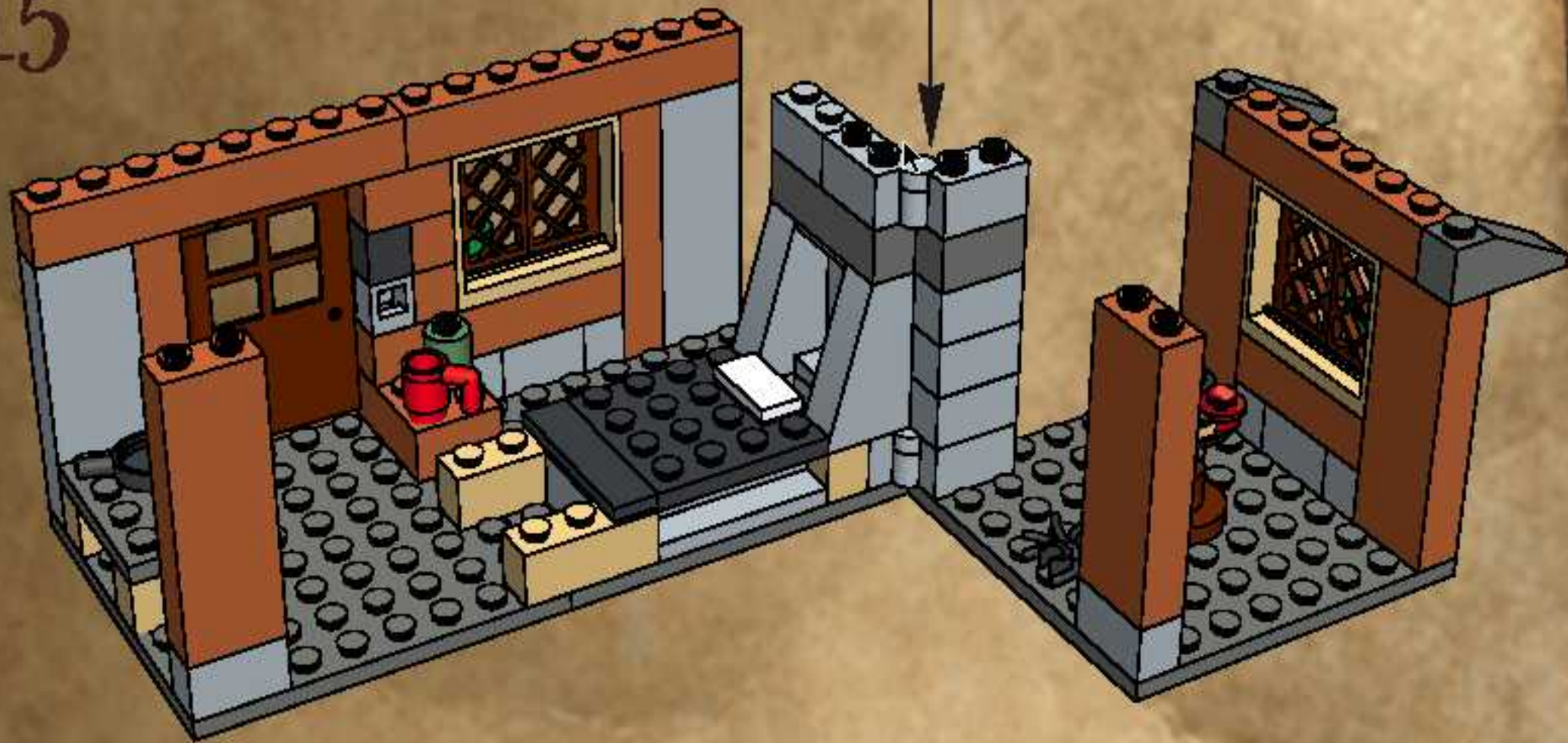
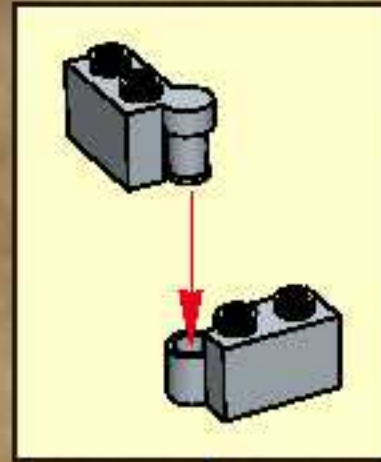

16

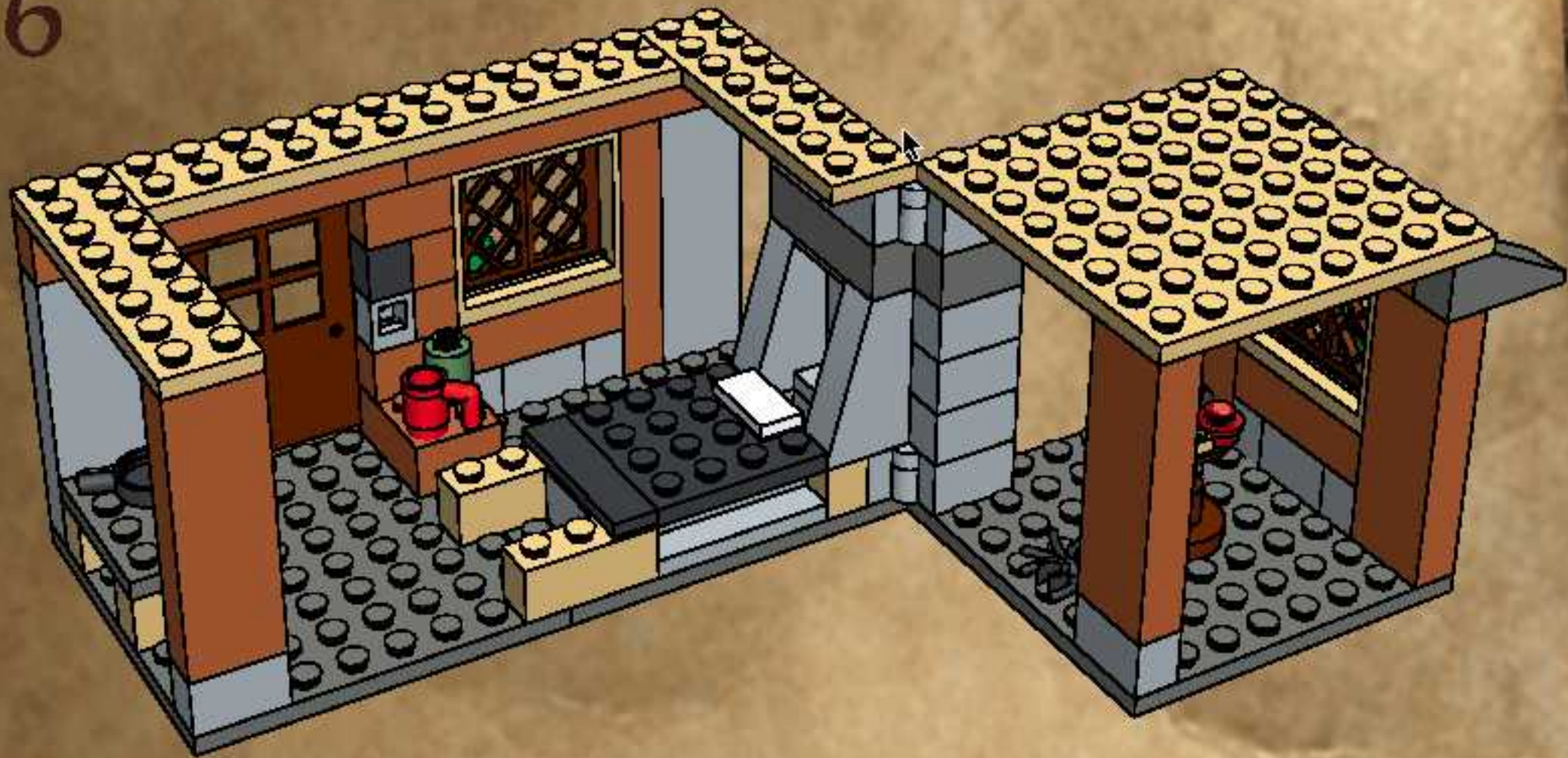

17

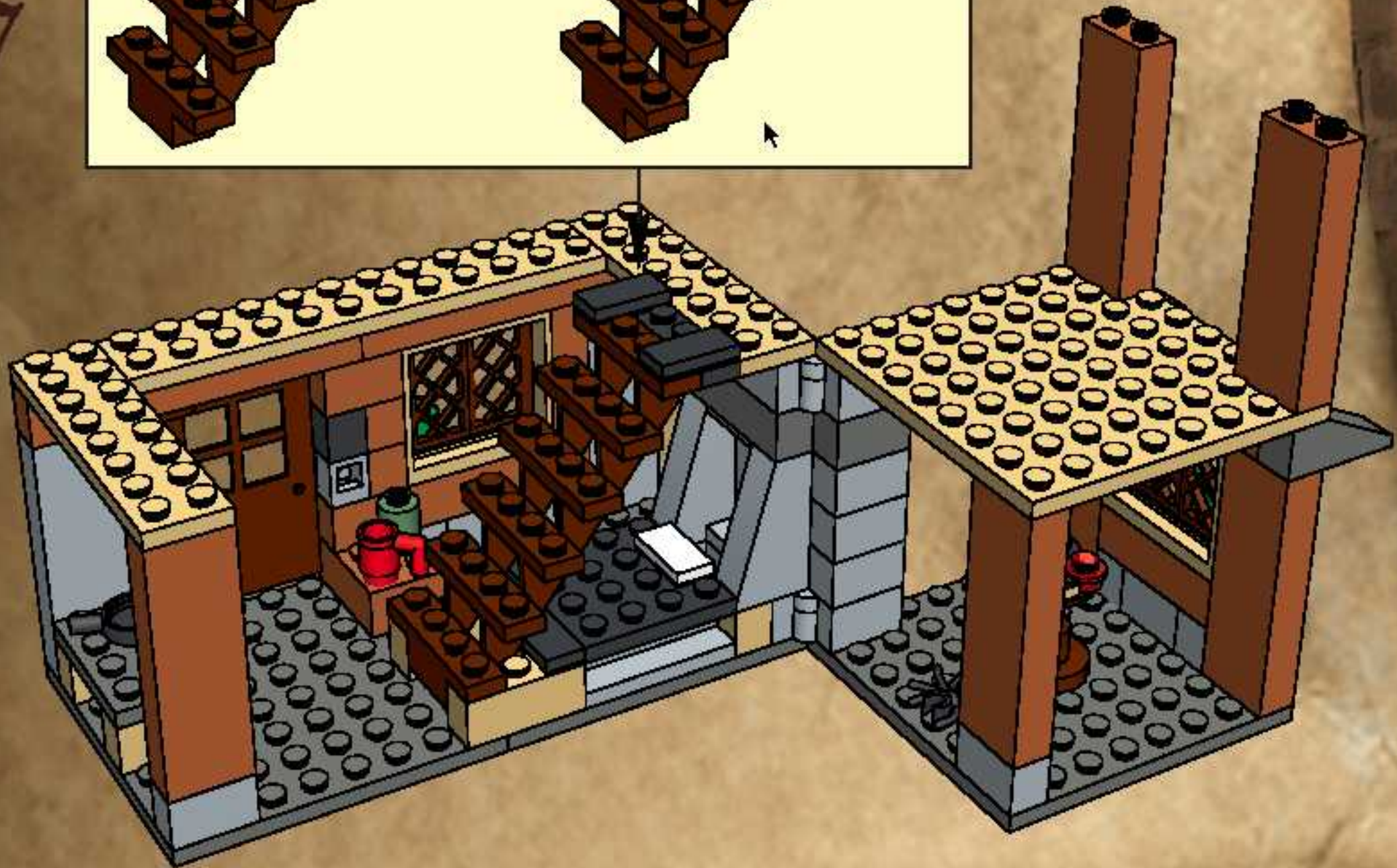
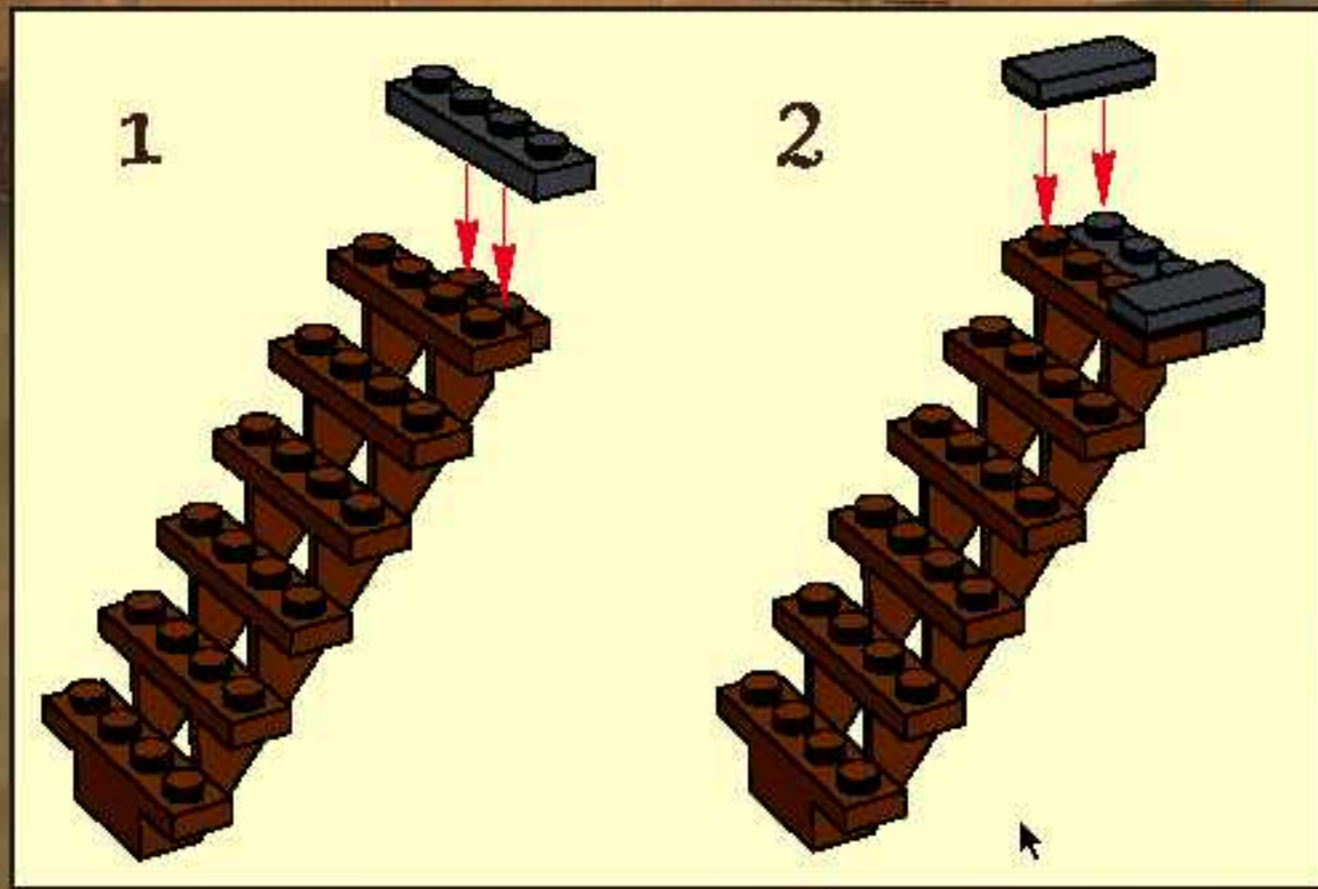



18



19

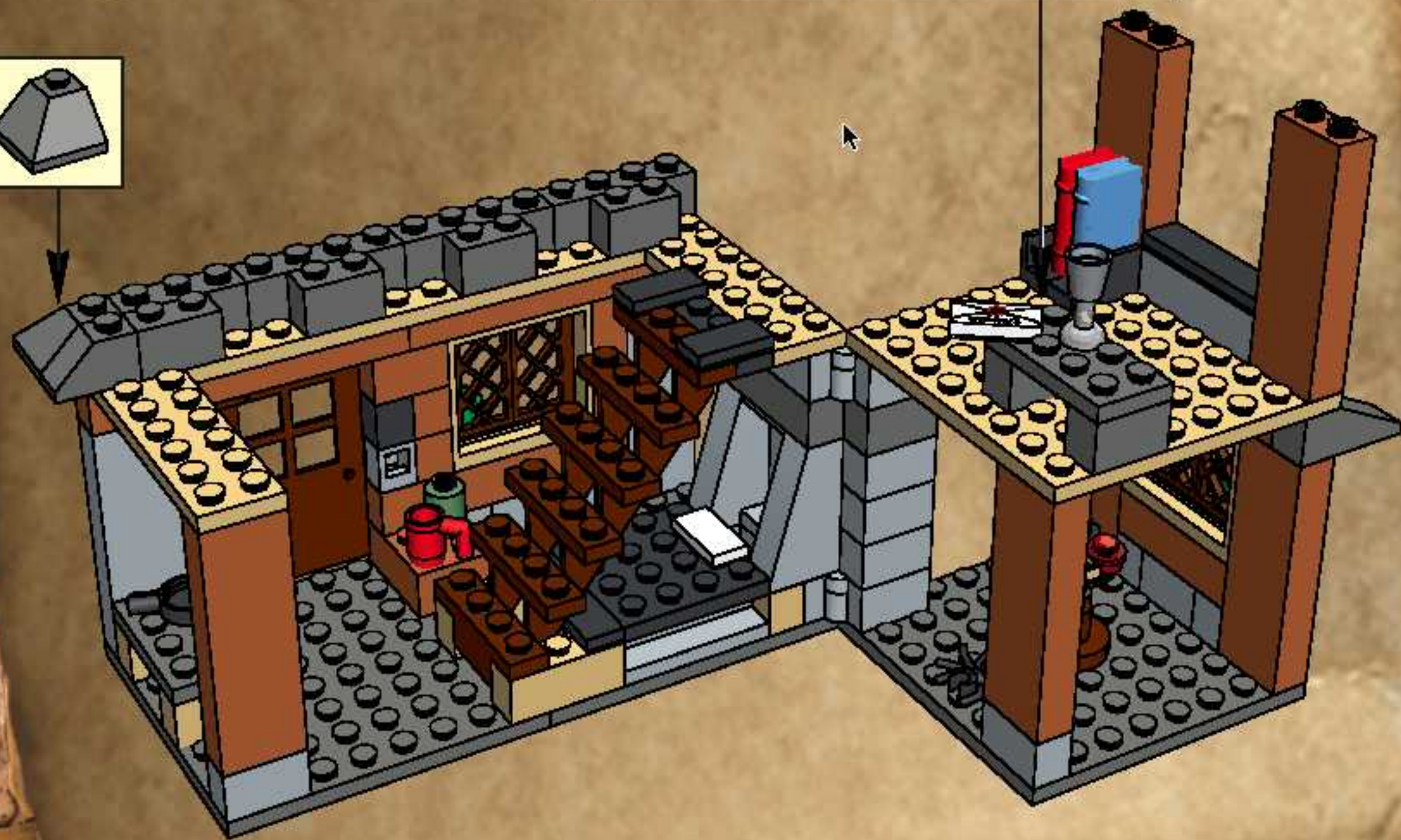
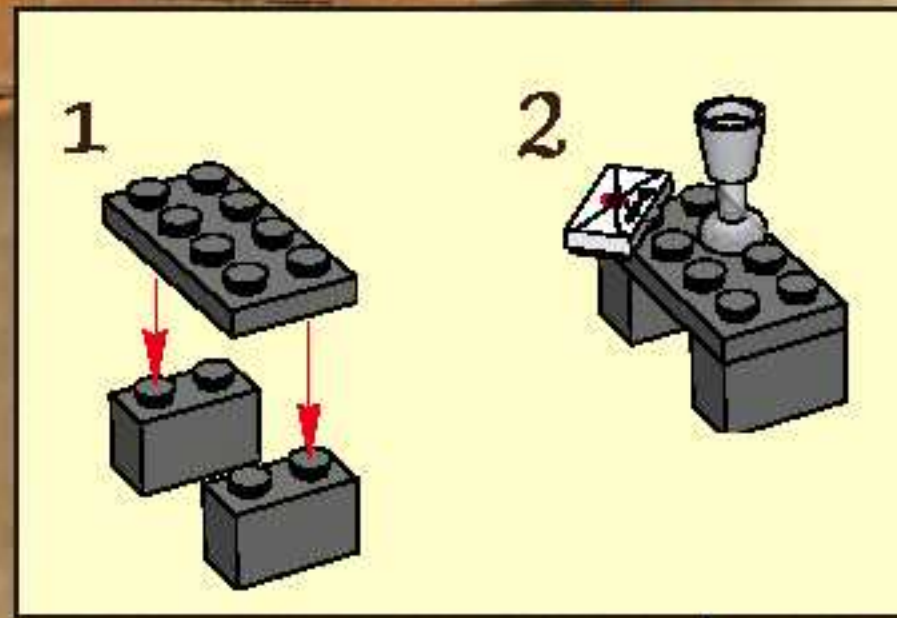

20

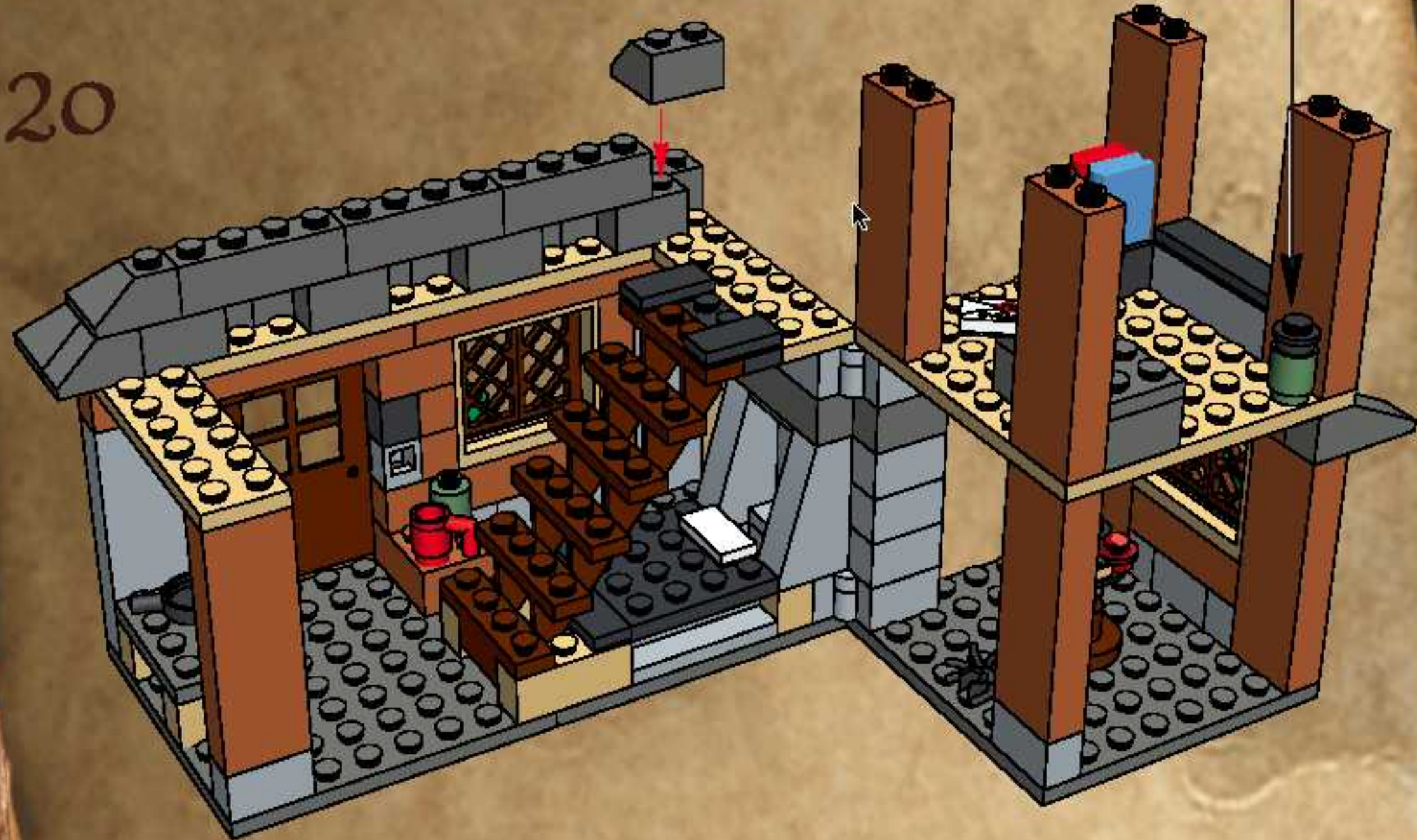

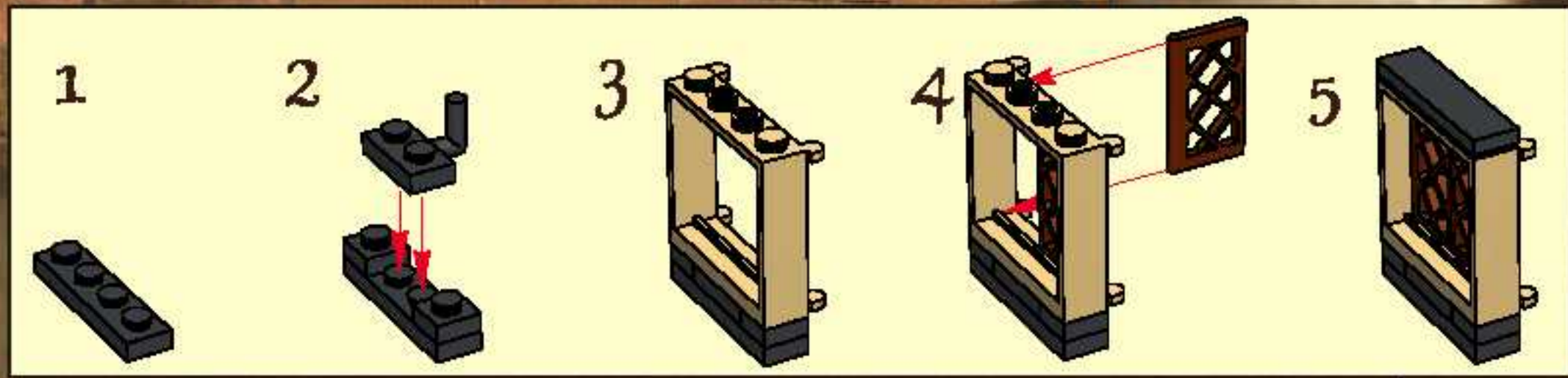

21

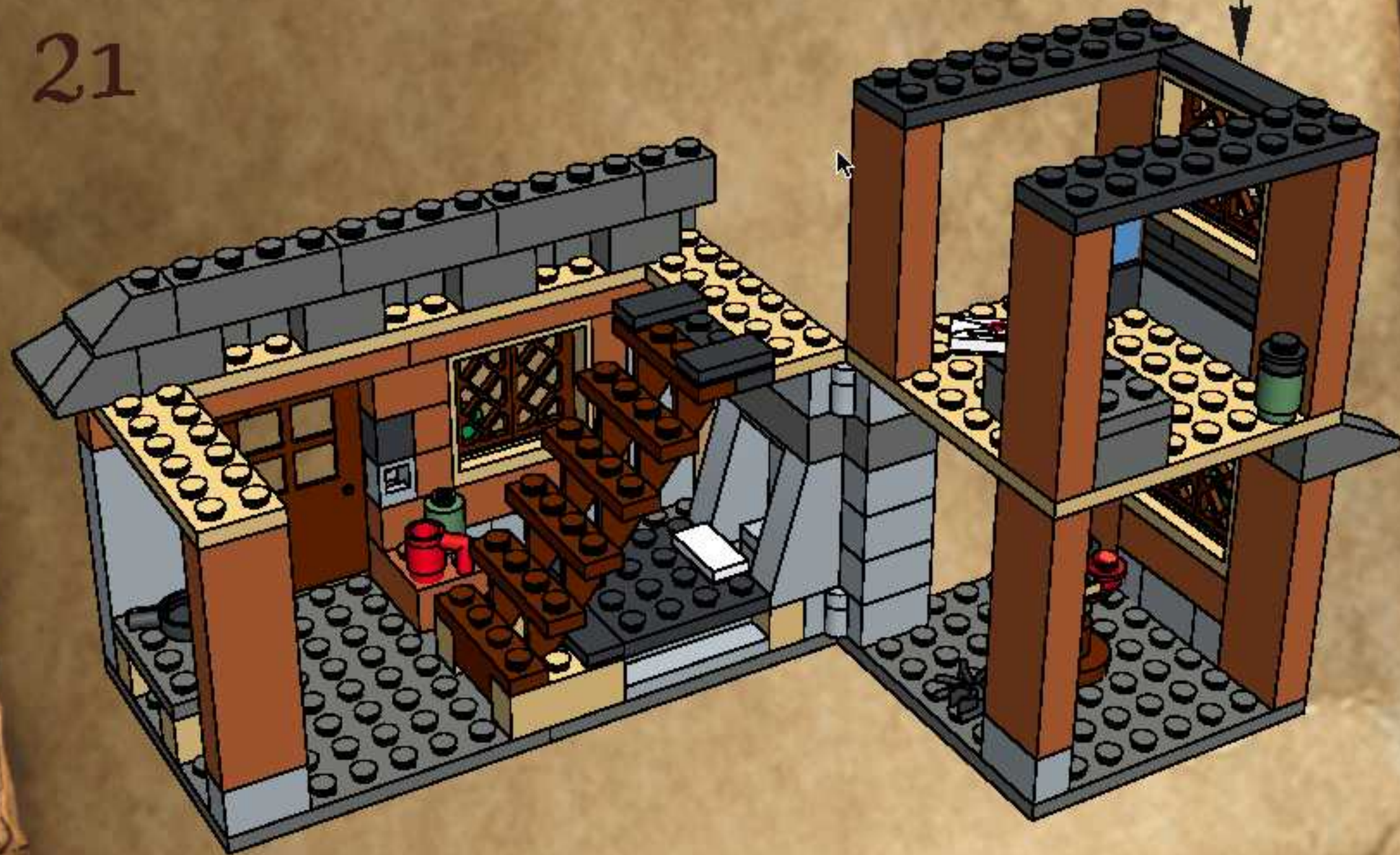

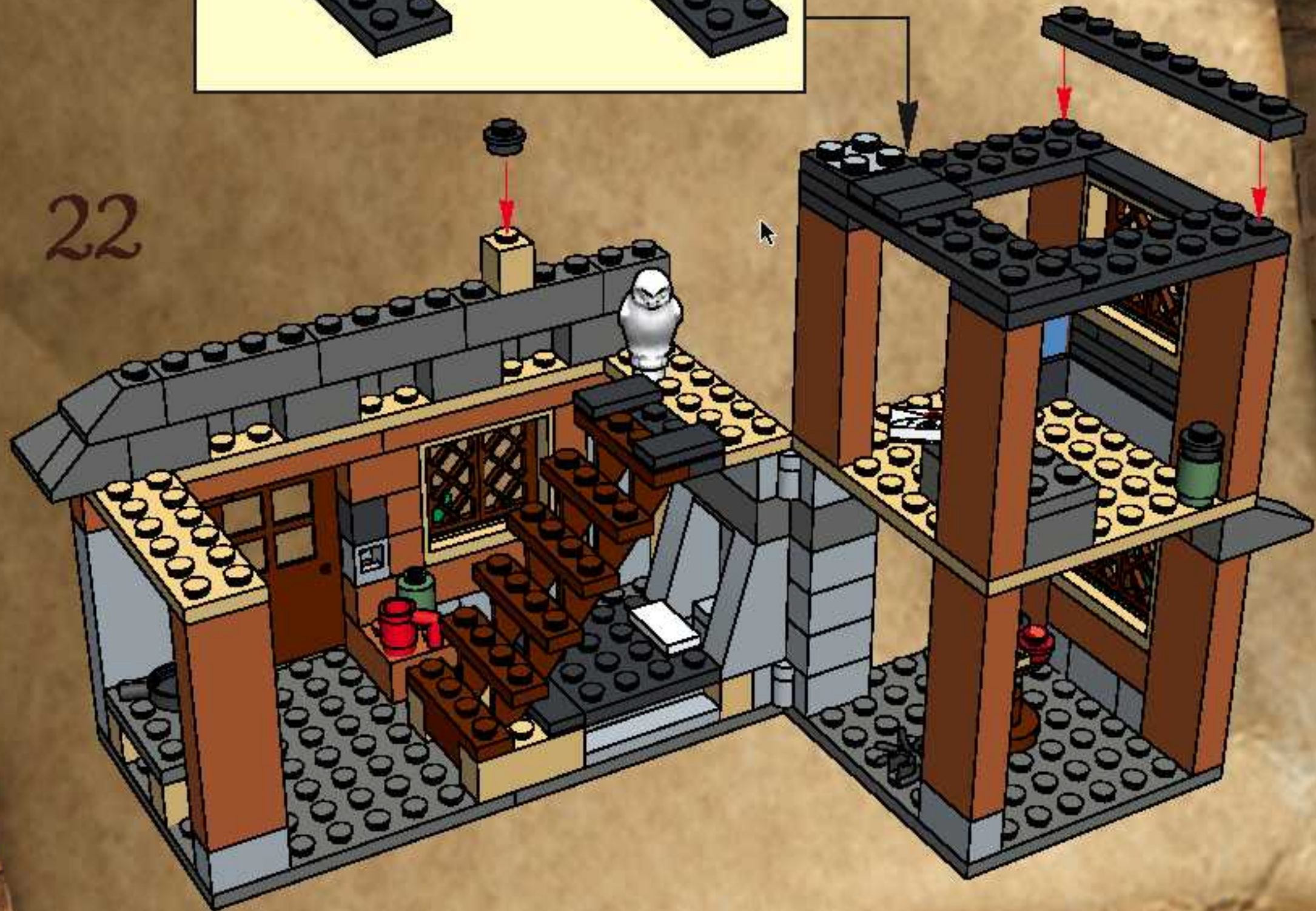
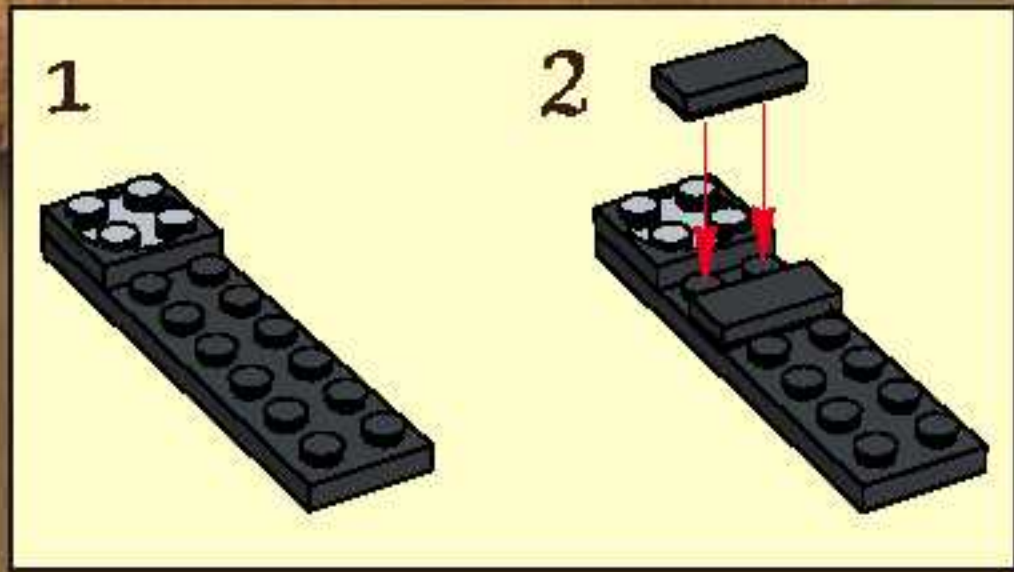

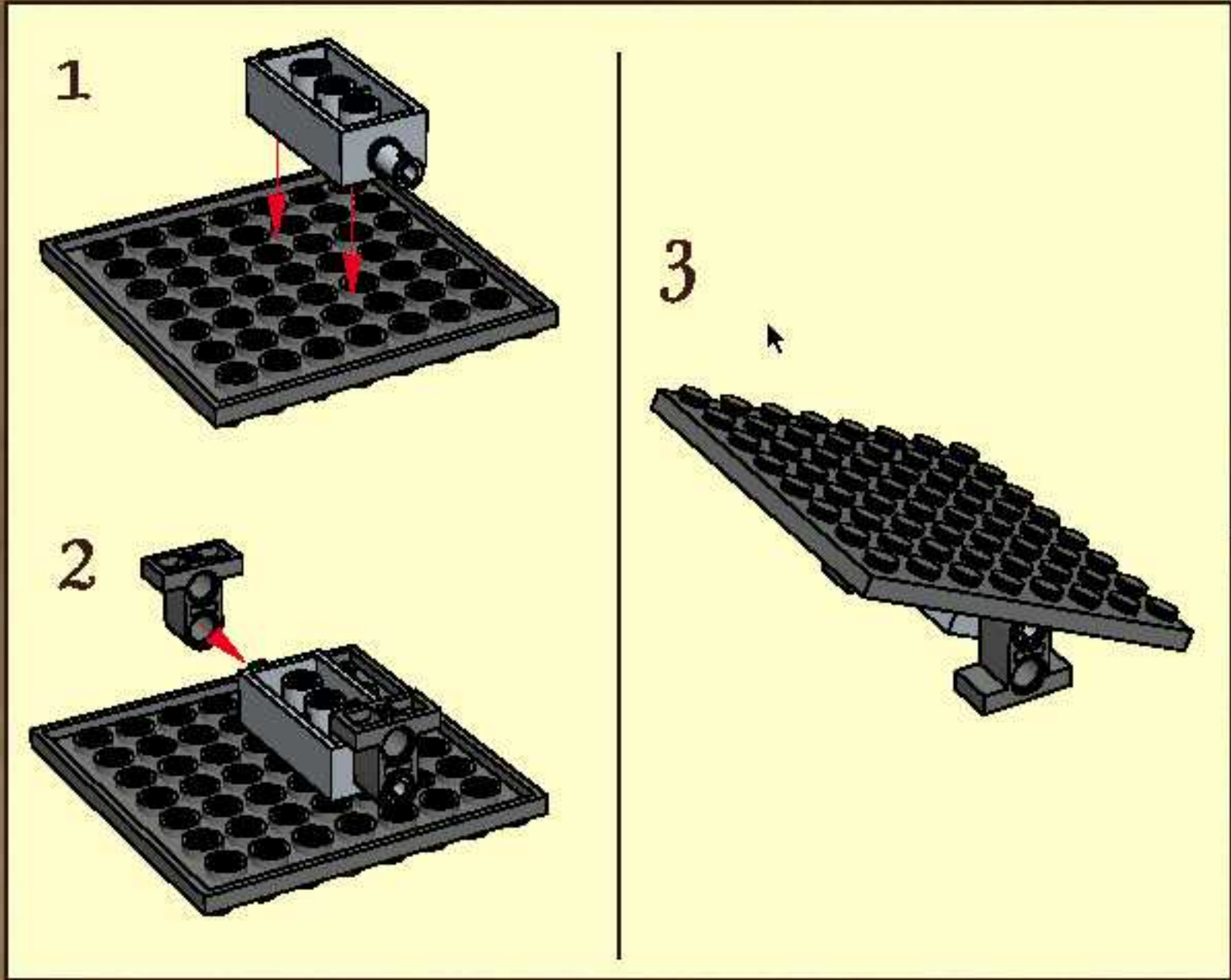

23

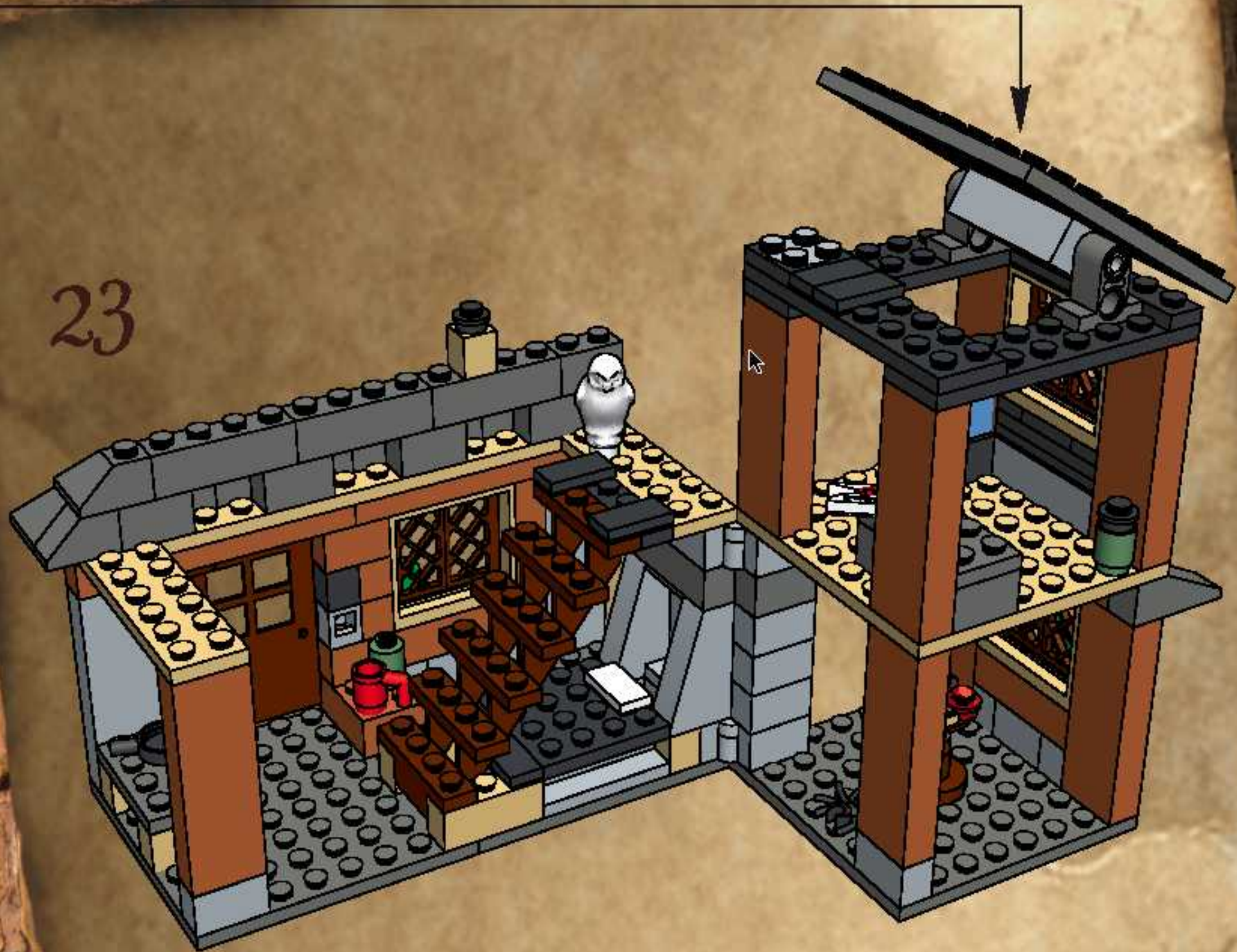

1

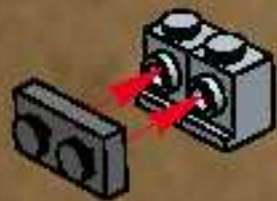

2



3



4



5



6





24

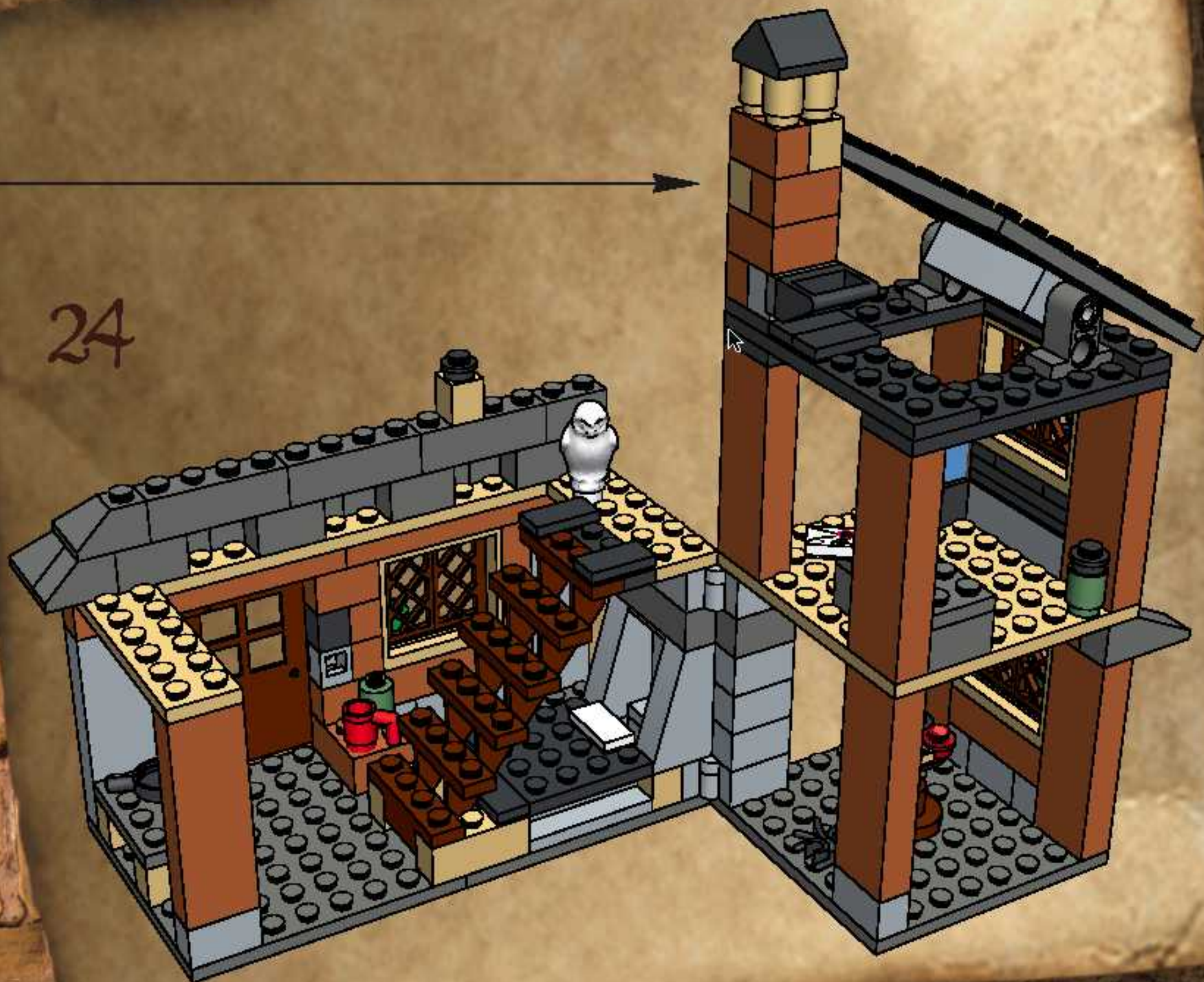

25

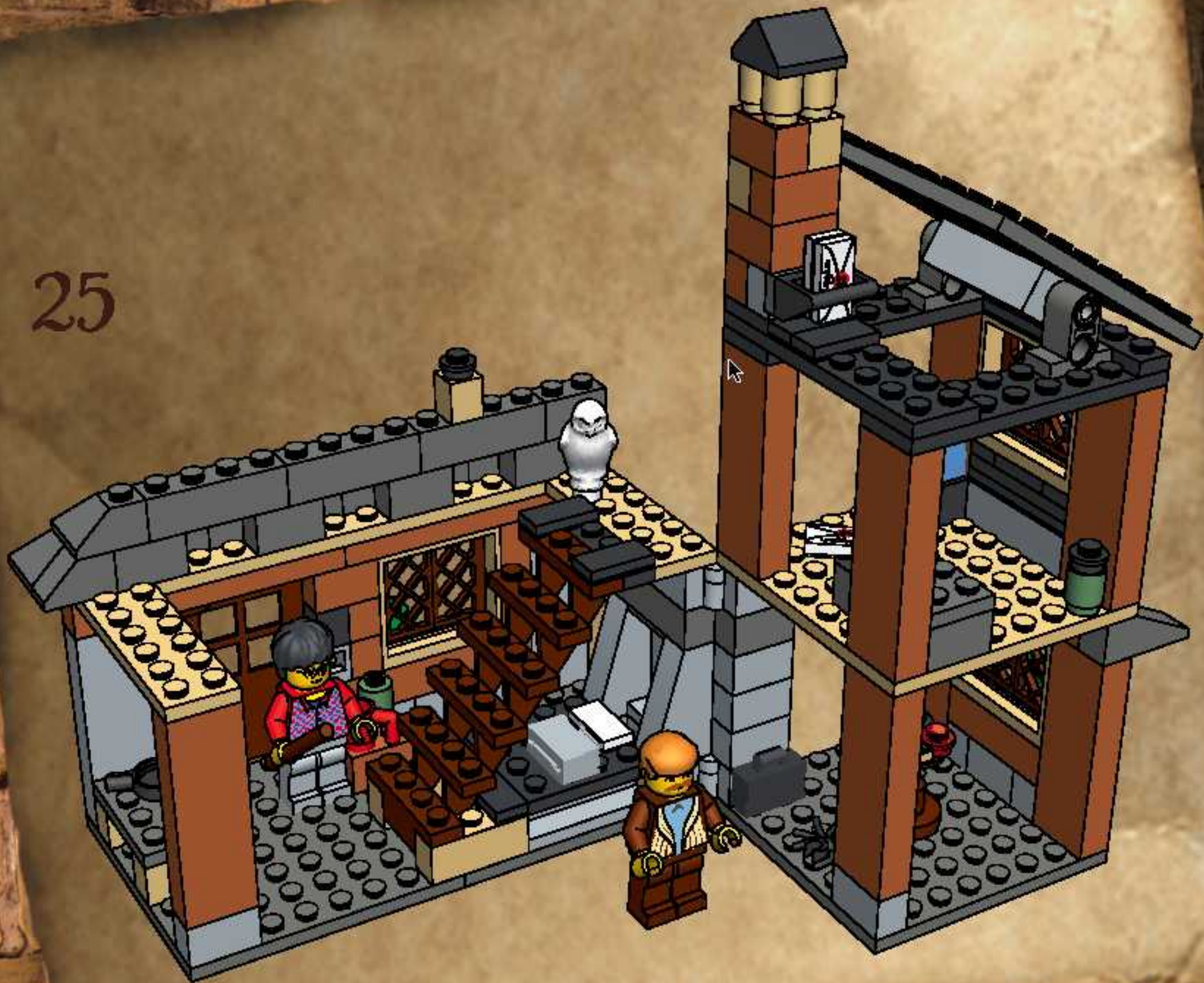

26

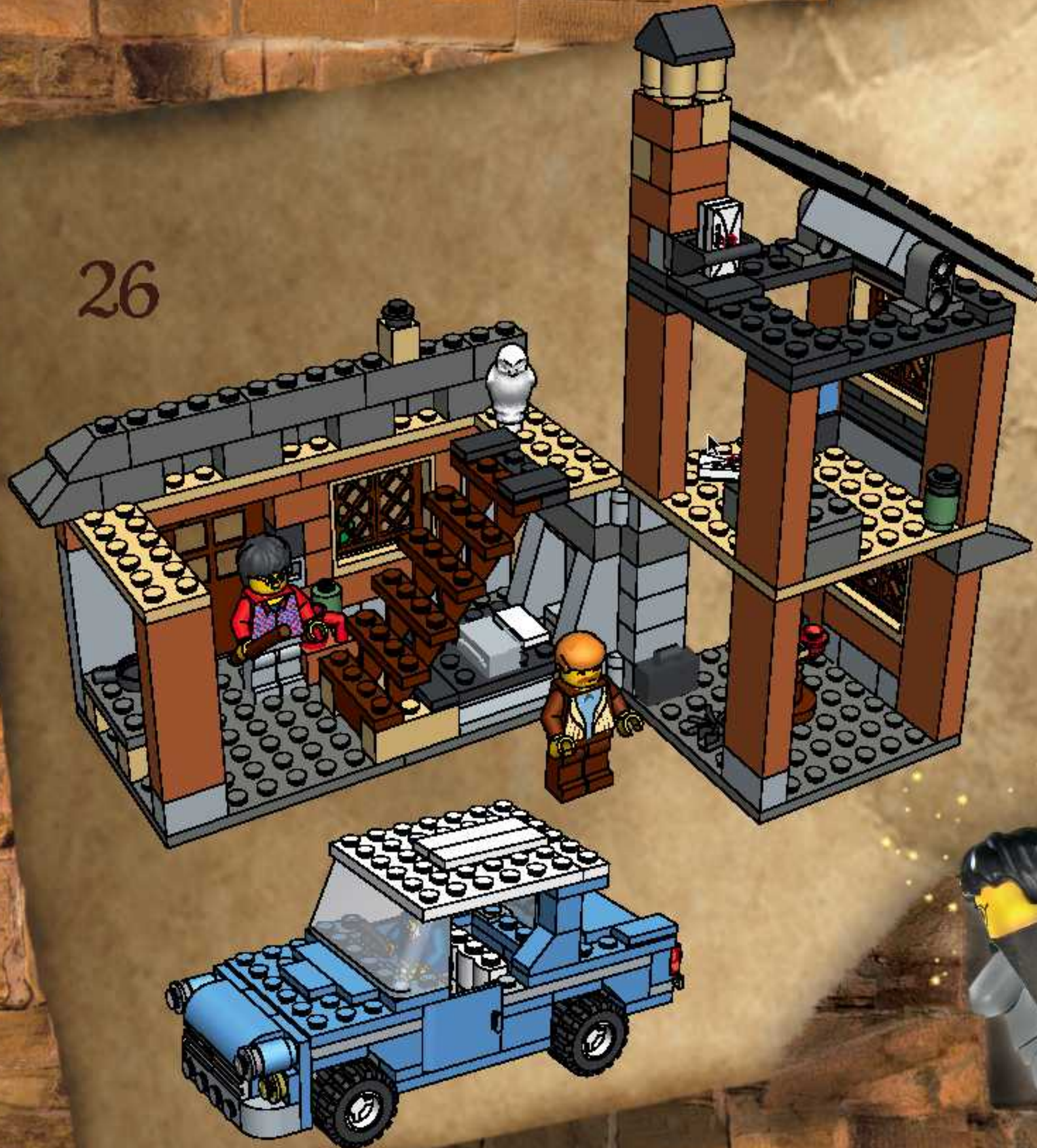

1

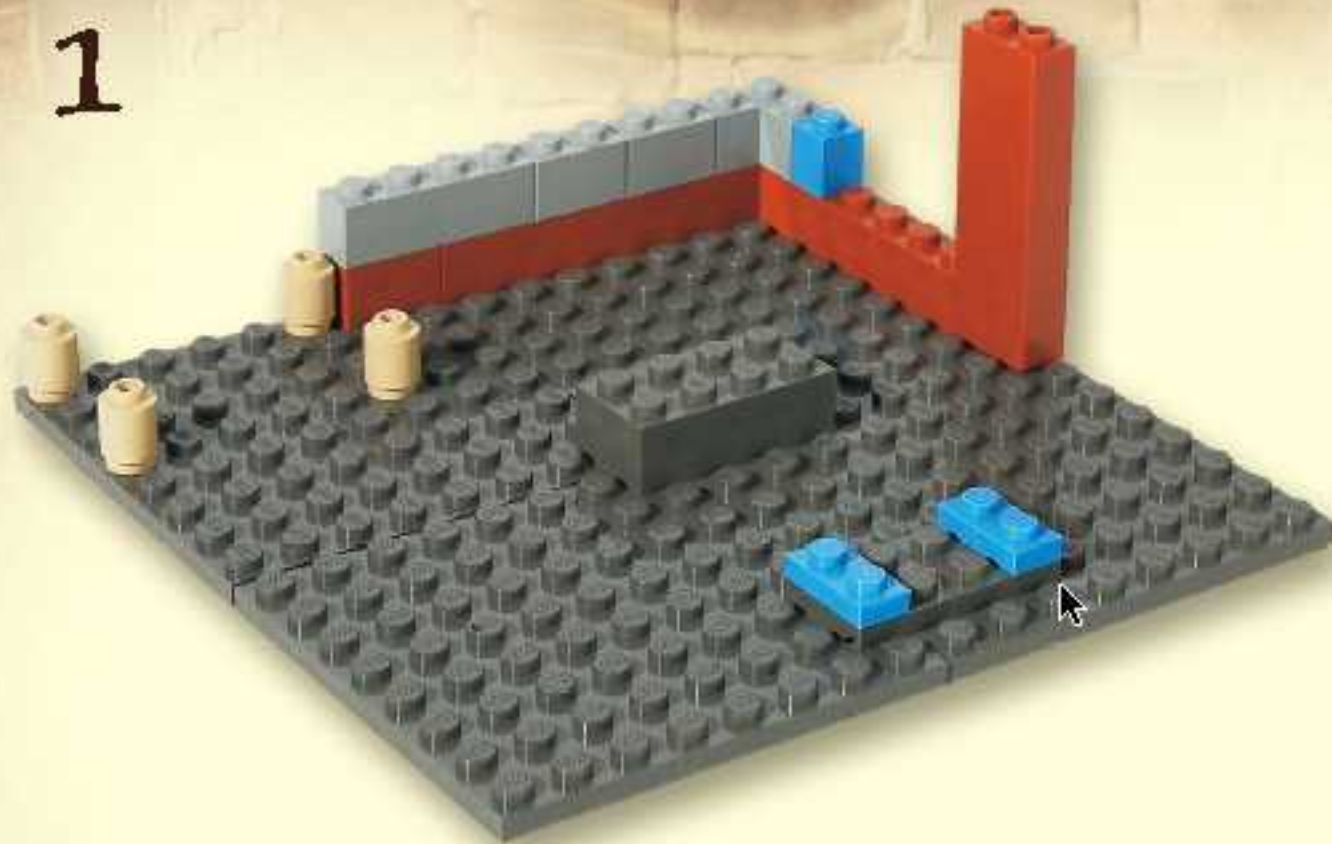

2





1

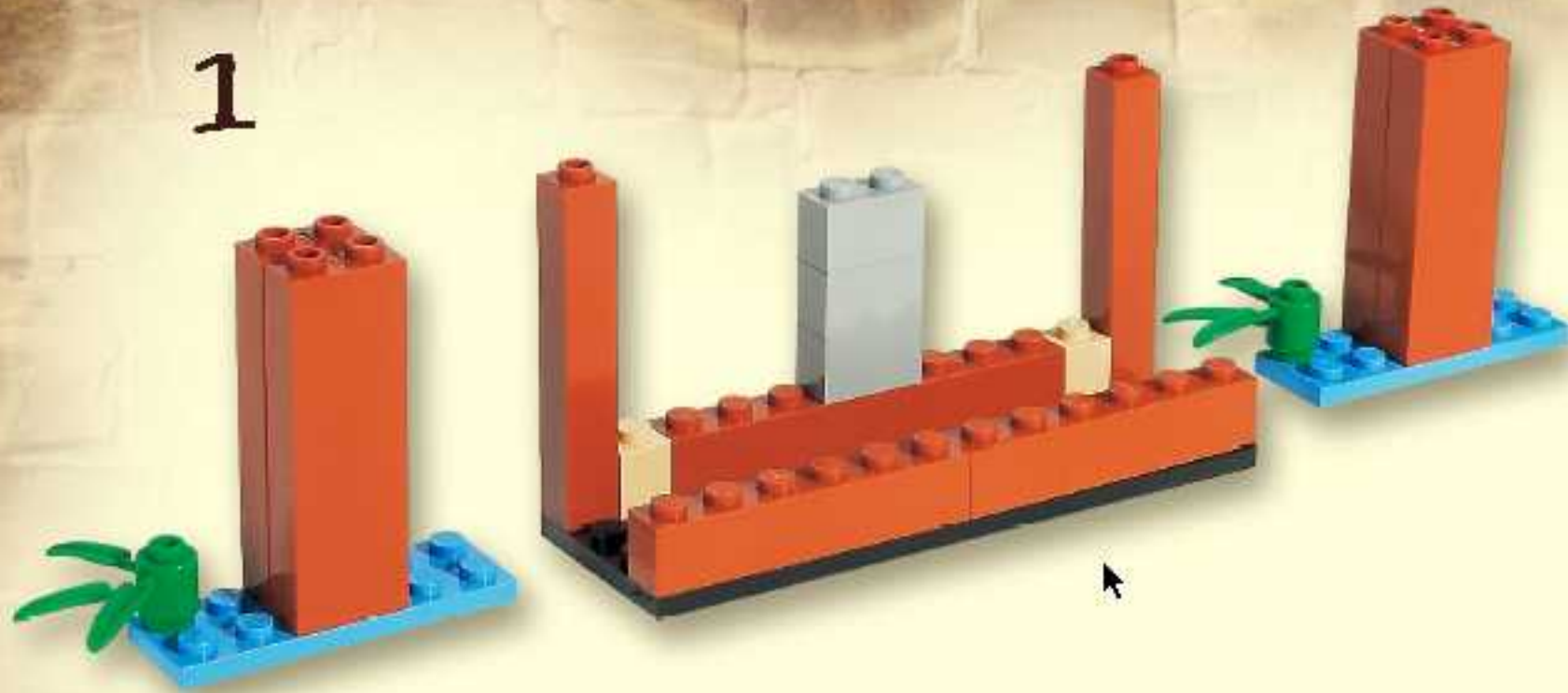

2



3



1

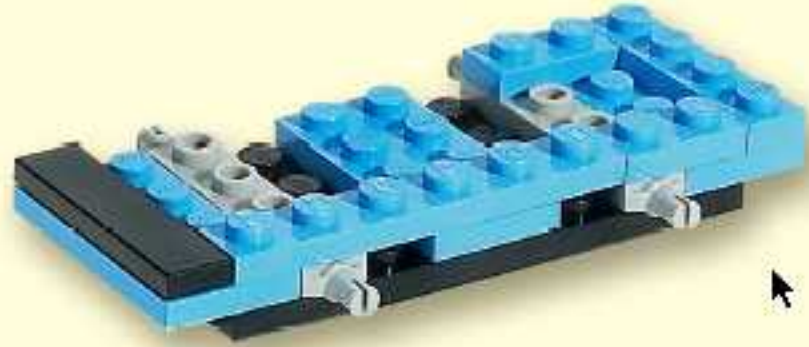

2

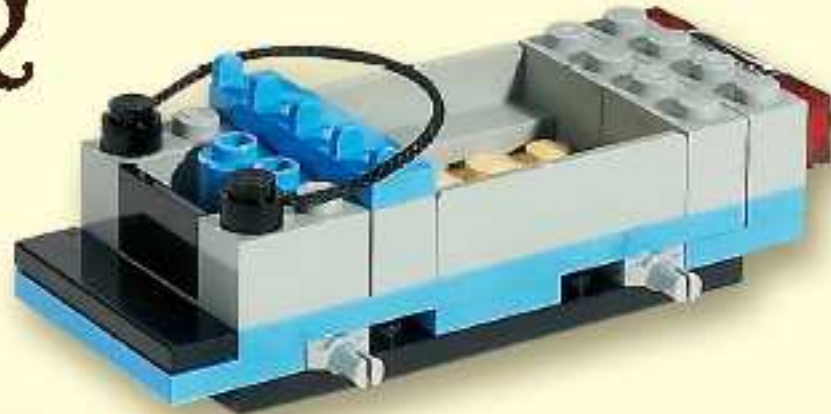



3



4





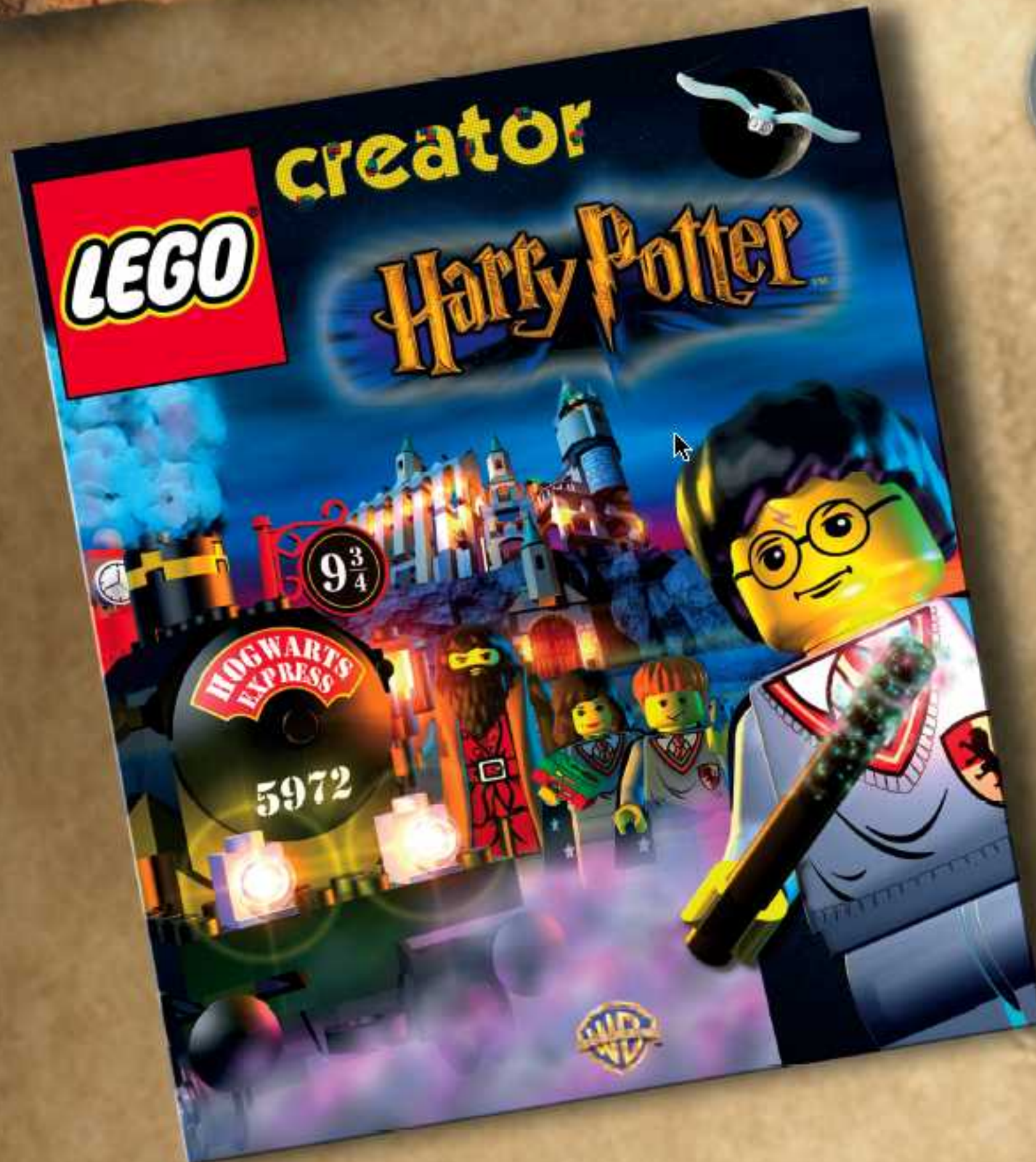

LEGO and the LEGO logo are trademarks of the LEGO Group.  
©2002 The LEGO Group.

HARRY POTTER, characters, names and related indicia are trademarks of  
and © Warner Bros.  
Harry Potter Publishing Rights © J.K. Rowling.  
2002



4728



4707



4726



4730



4709



4735



4729



4731



4733



4730



4712



4709

4726

4705

4733



4727



LEGO and the LEGO logo are trademarks of the LEGO Group.  
©2002 The LEGO Group.

HARRY POTTER, characters, names and related indicia are trademarks of and © Warner Bros.

WIZARDING WORLD™ & © Warner Bros.

Harry Potter Publishing Rights © J.K. Rowling.  
©2002



[www.harrypotter.com](http://www.harrypotter.com)

[www.LEGO.com](http://www.LEGO.com)

JOIN THE FUN!

419992