



Friends

41743



WARNING: CHOKING HAZARD. Toy contains small parts and a small ball. Not for children under 3 years.



Get excited about our new packaging!

We're switching from plastic to paper-based packaging. That's why you might find a mix of paper and plastic in our boxes!

Nos nouveaux emballages vous emballeront !

Nous passons des emballages en plastique aux emballages à base de papier. C'est pourquoi vous pourriez trouver un mélange de papier et de plastique dans nos boîtes !

¡Te presentamos nuestros nuevos empaques!

Estamos sustituyendo las bolsas de plástico por bolsas con base de papel. ¡Por eso, puedes encontrar una mezcla de papel y de plástico en nuestras cajas!

[LEGO.com/sustainable-packaging](https://www.lego.com/sustainable-packaging)



BUILDER



Apple and the Apple logo are trademarks of Apple Inc., registered in the U.S. and other countries and regions. App Store is a service mark of Apple Inc. Google Play and the Google Play logo are trademarks of Google LLC. Tencent and the Tencent logo are trademarks of Tencent Inc.

Q [LEGO.com/devicecheck](https://www.lego.com/devicecheck)

EN Ask parents' permission before going online | **DE** Eltern um Erlaubnis bitten, bevor du online gehst | **FR** Demande l'autorisation d'un parent avant d'aller en ligne | **IT** Chiedi il permesso ai tuoi genitori prima di andare online | **ES** Pídeles permiso a tus papás antes de conectarte a Internet | **PT** Peça autorização aos pais antes de acederes online | **JA** オンラインになる前に ほかの方のきよかもをもらおう | **ZH** 上网前应先征得父母的同意 | **KO** 온라인 접속 전에 보호자 동의가 필요합니다 | **RU** Спроси разрешения у родителей, прежде чем заходить в интернет | **PL** Poproś rodziców o zgodę, zanim wejdiesz do Internetu | **CS** Než půjdeš na internet, požádej rodiče o svolení | **SK** Skôr než pôjdeš na internet, vypýtaj si povolenie od rodičov | **HU** Kérj szülői engedélyt, mielőtt online csatlakoznál! | **RO** Cere permisiunea părinților înainte de a te conecta online | **BG** Поискайте разрешение от родител, преди да влезете онлайн | **LV** Pirms došanās tiešsaistē palūdz atļauju vecākiem | **ET** Enne Interneti kasutamist küsi vanematelt luba | **LT** Prieš prisijungdami prie interneto, atsiklauskite tėvų

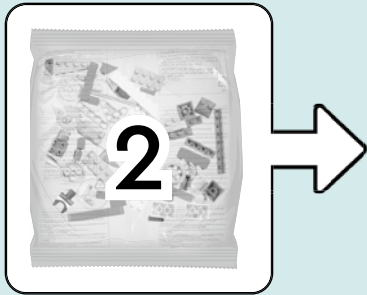
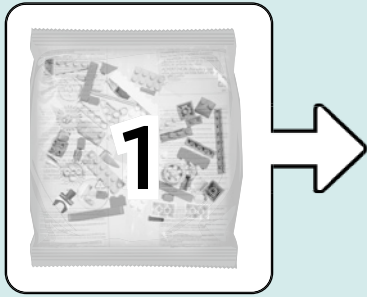

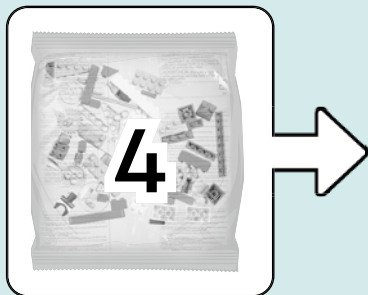
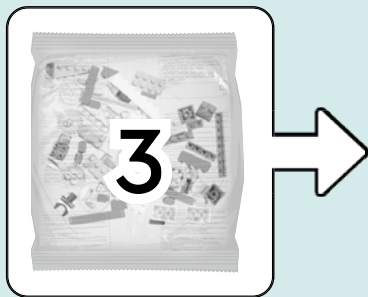

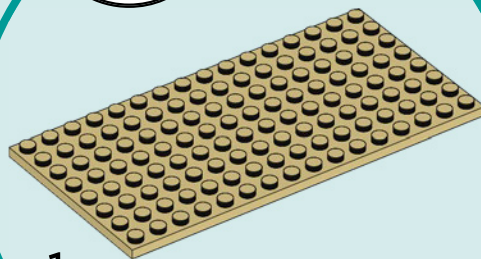
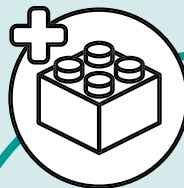
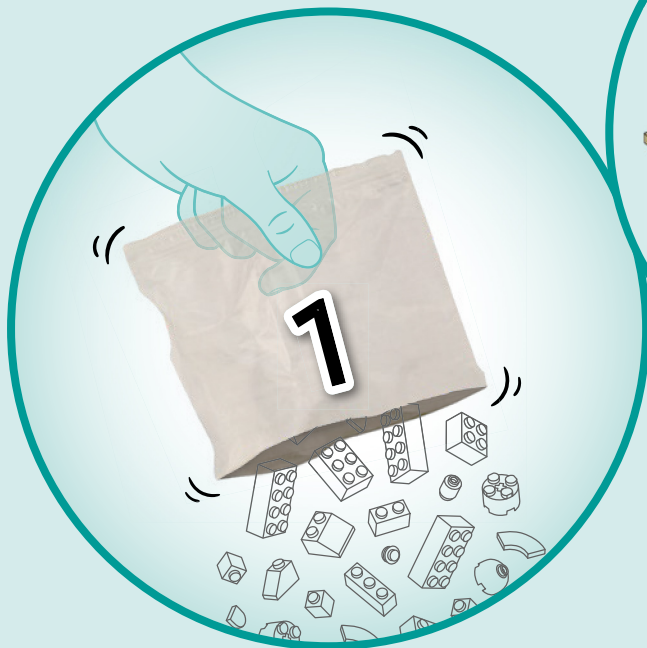

1x



AVERTISSEMENT : RISQUE D'ÉTOUFFEMENT.

Le jouet contient des petites pièces ainsi qu'une petite boule.
Il ne convient pas aux enfants de moins de 3 ans.



ADVERTENCIA: PELIGRO DE ASFIXIA.

Juguete que contiene partes pequeñas y una pelota pequeña.
No recomendado para niños menores de 3 años.



OLLY

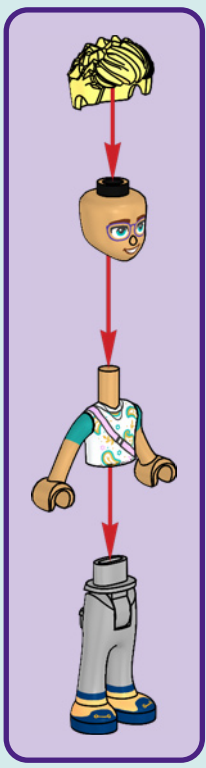

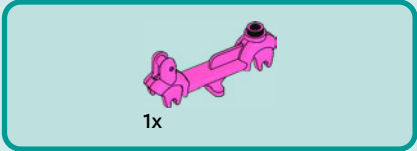
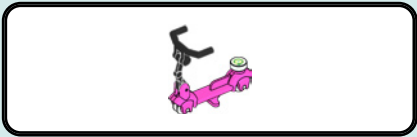

1

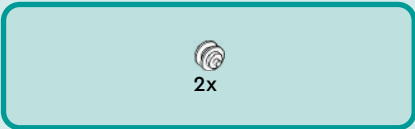
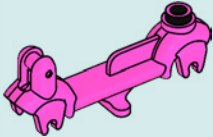

2

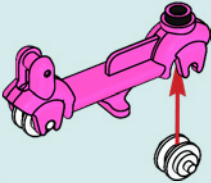



3



4

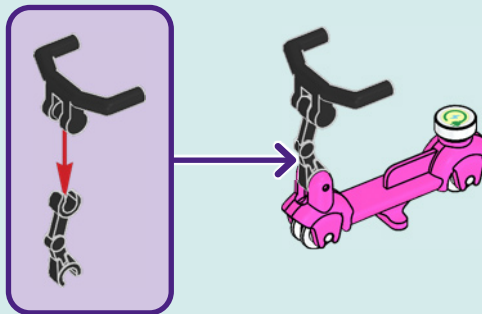

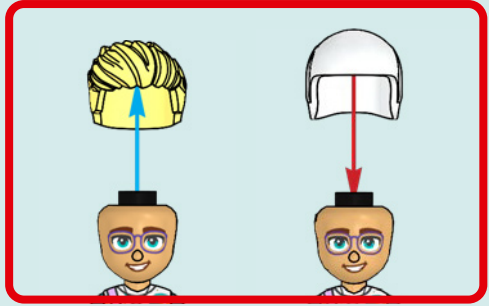

PAISLEY

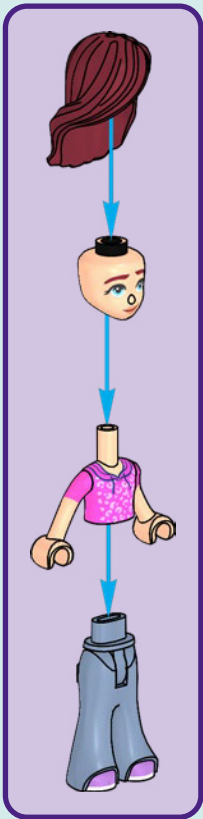

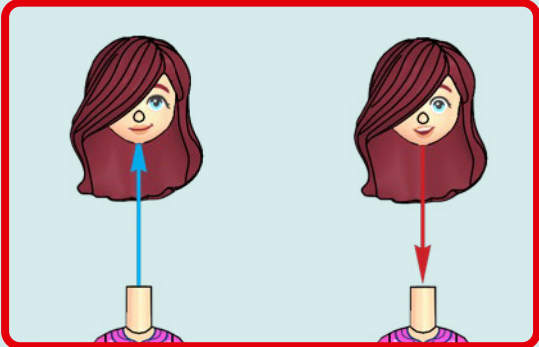

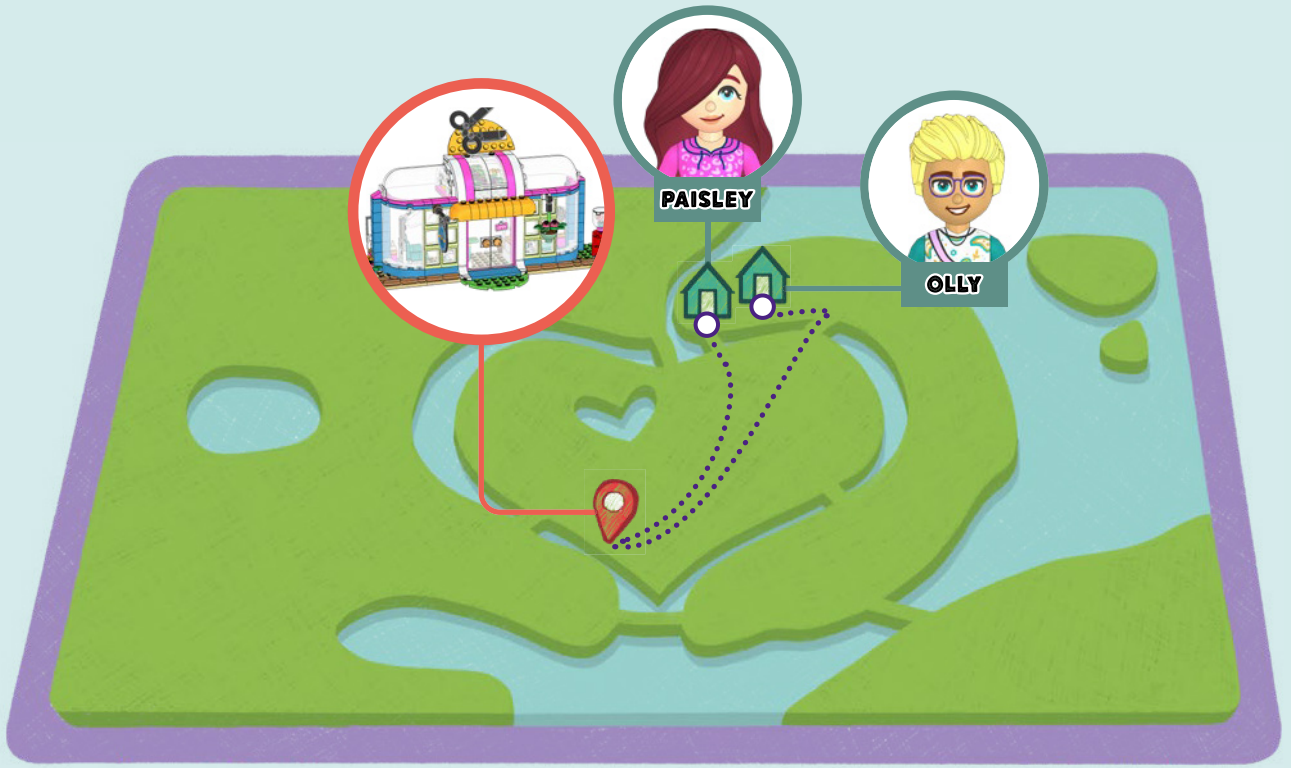

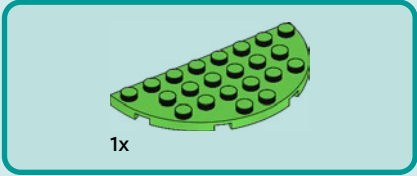

1

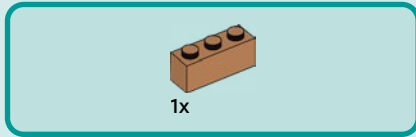
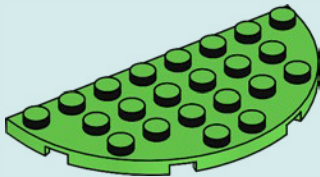

2

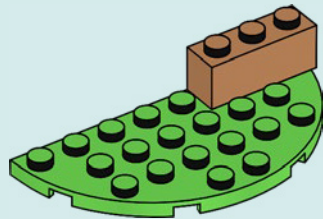

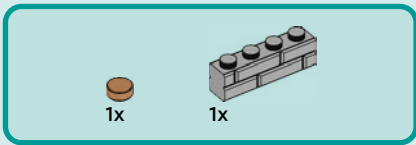

3

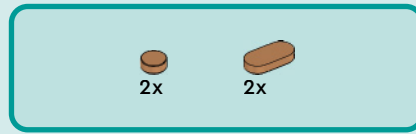
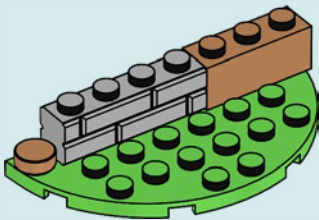

4

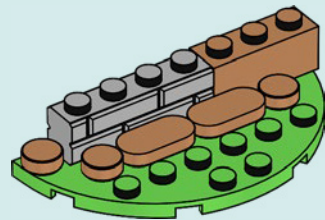

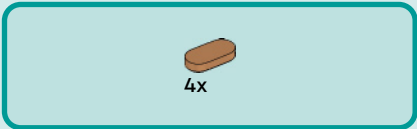

5

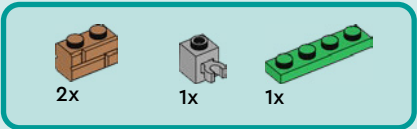
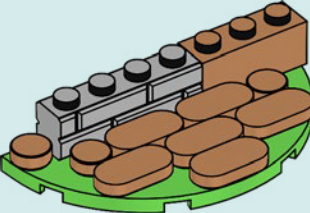

6

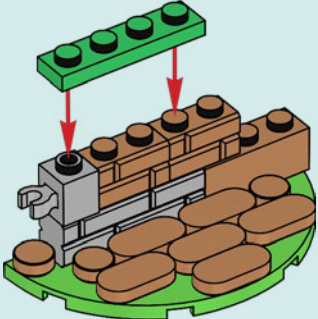

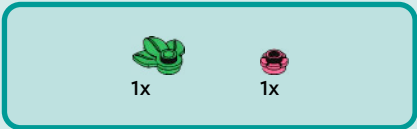

7

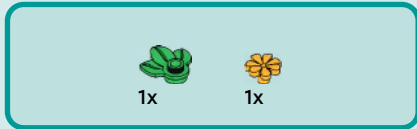
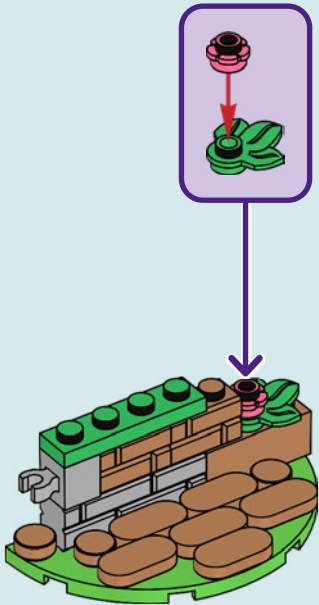

8

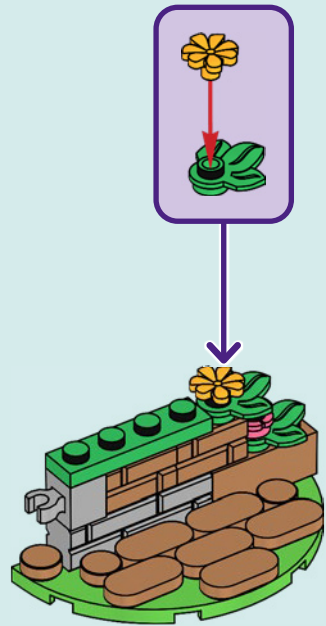

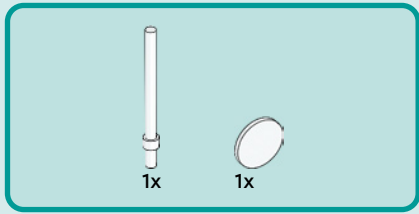

9

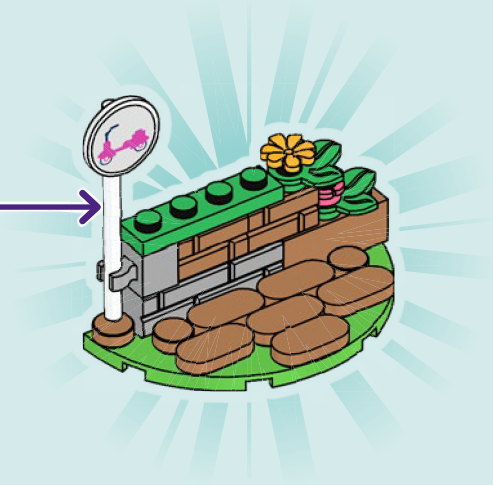
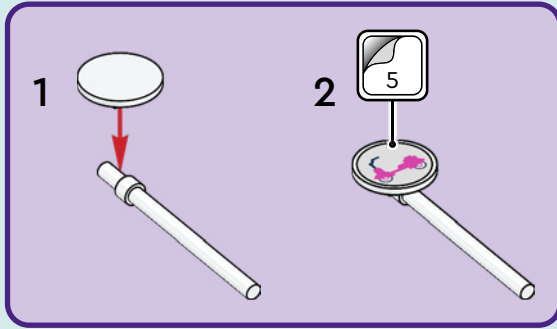

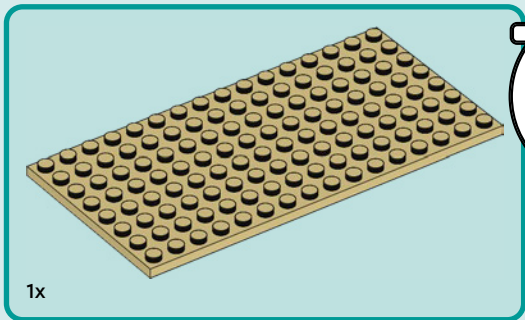
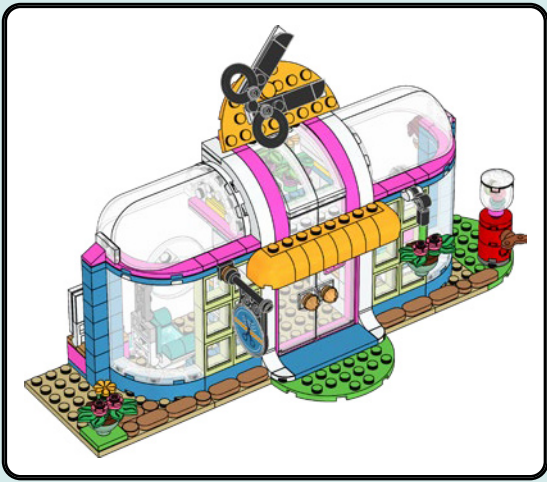

1x

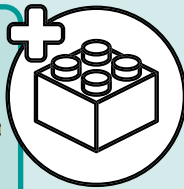

1

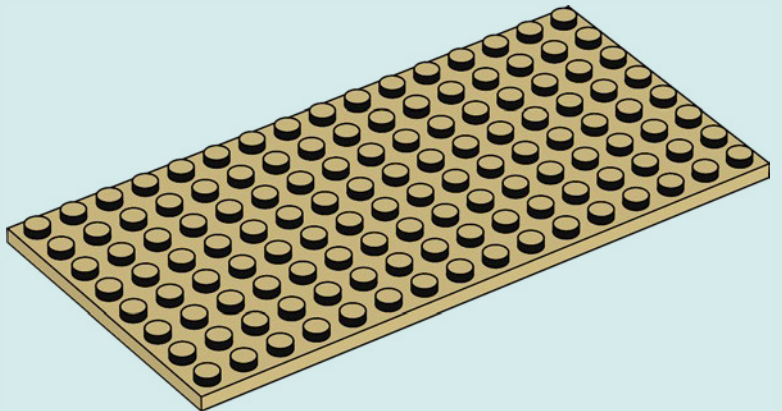



2x

2

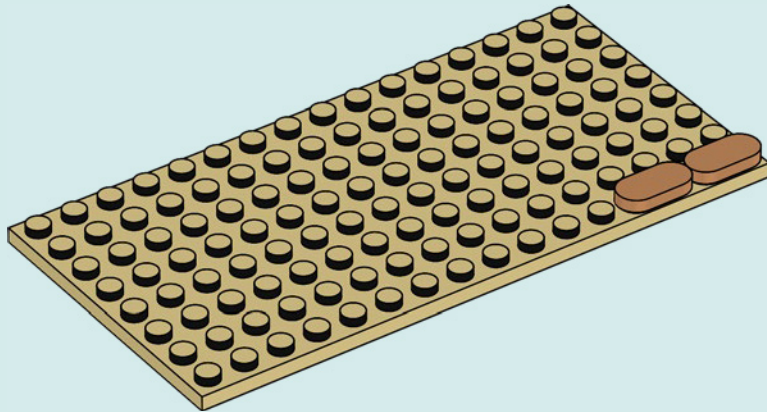

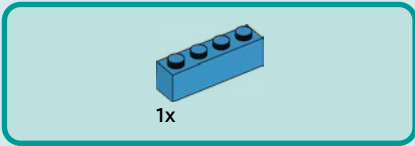

3

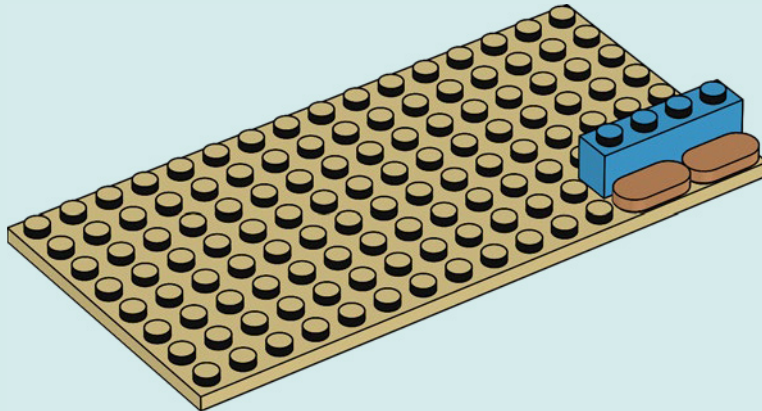



1x

4

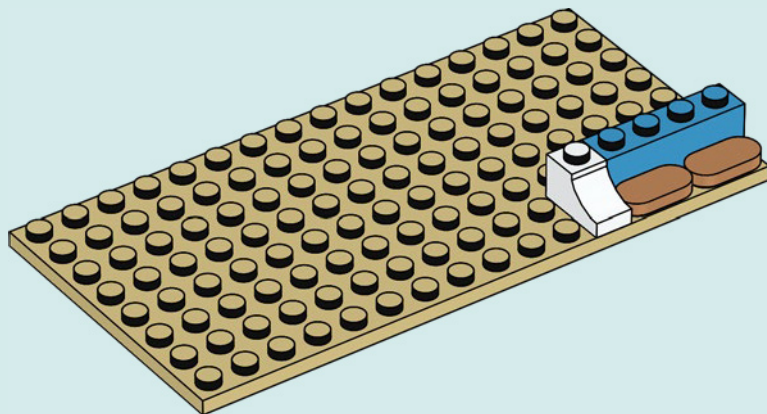

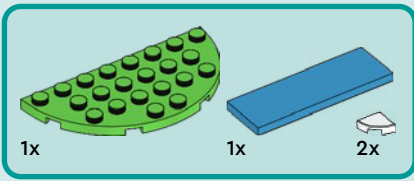

5

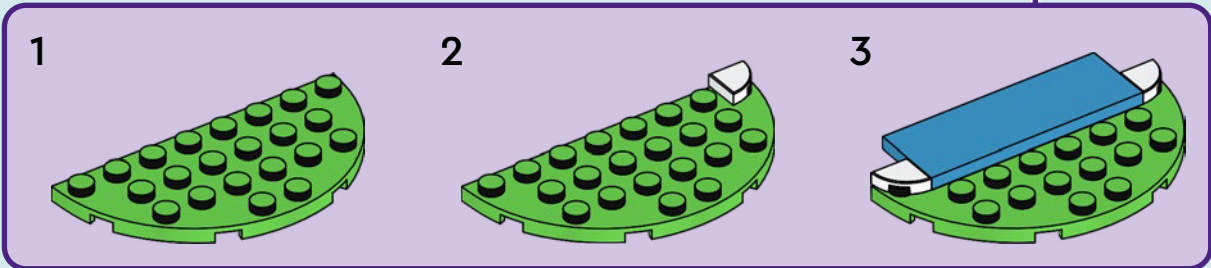
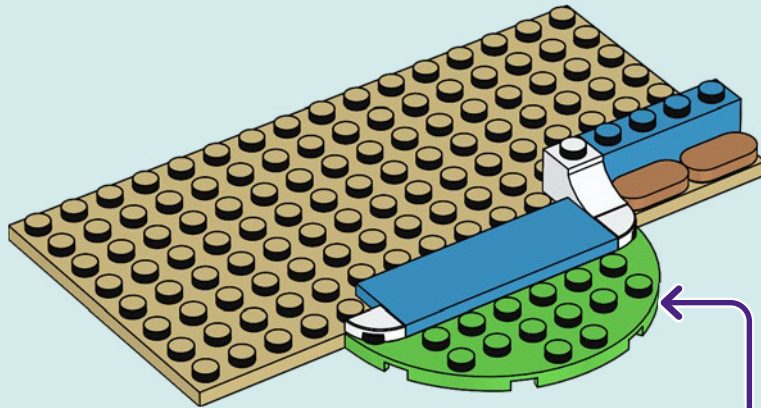



1x

6

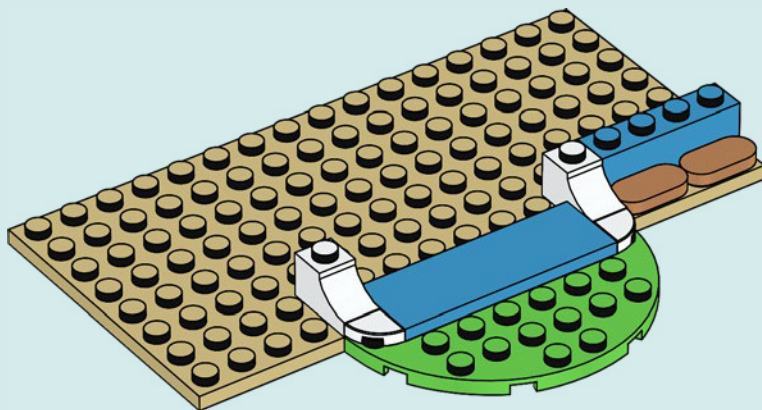



7

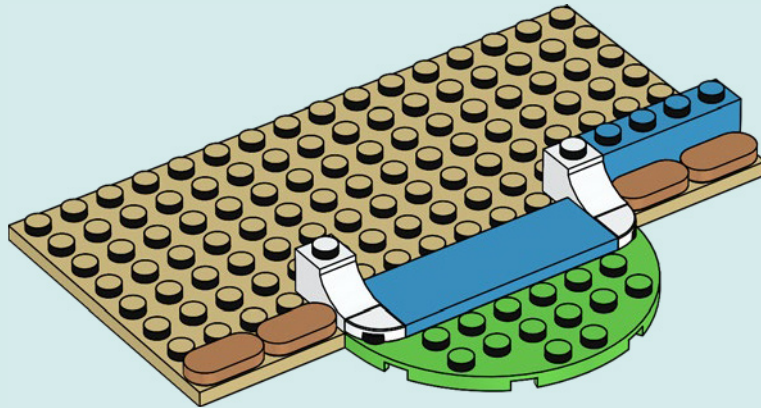

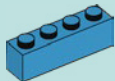

2x

8

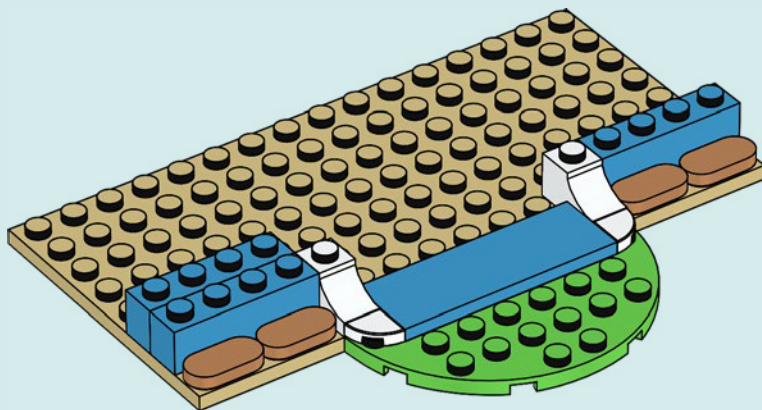

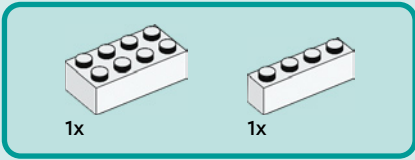

9

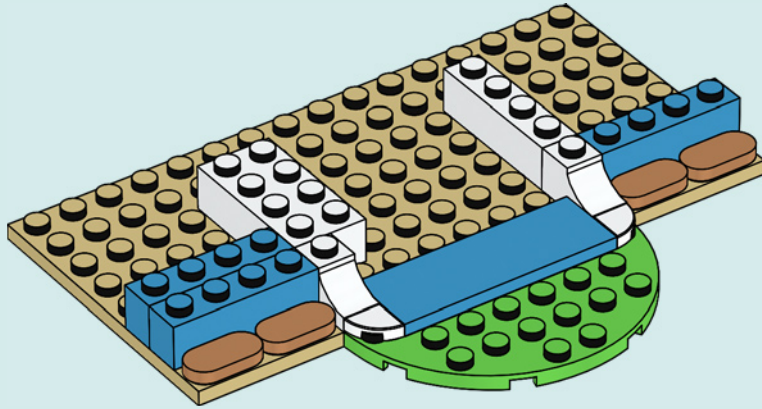



1x

10

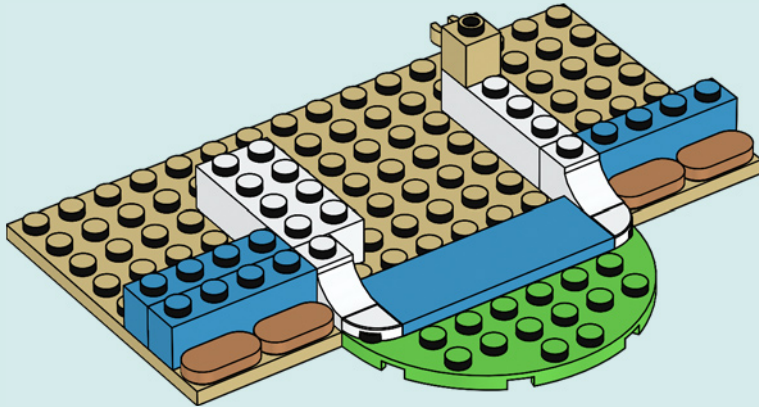

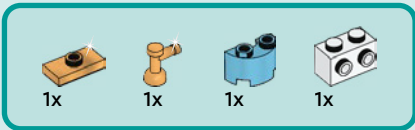

11

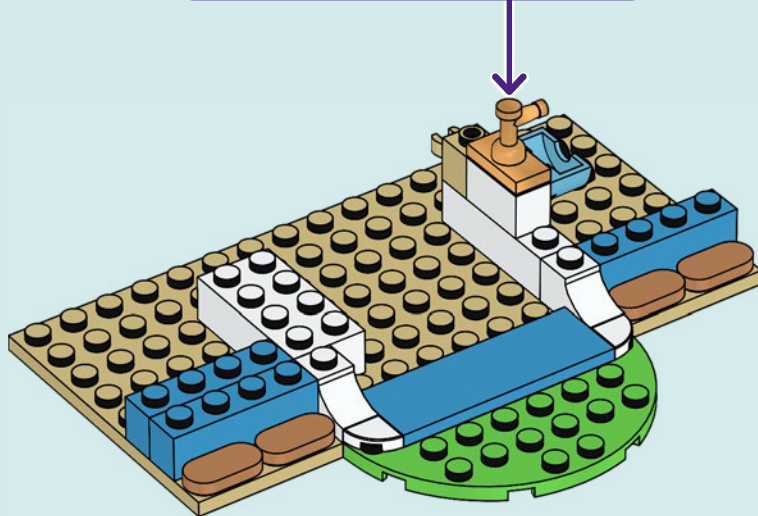
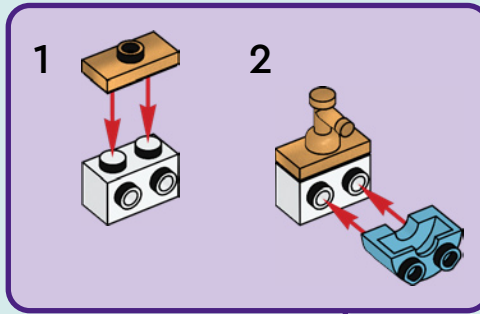



1x

12

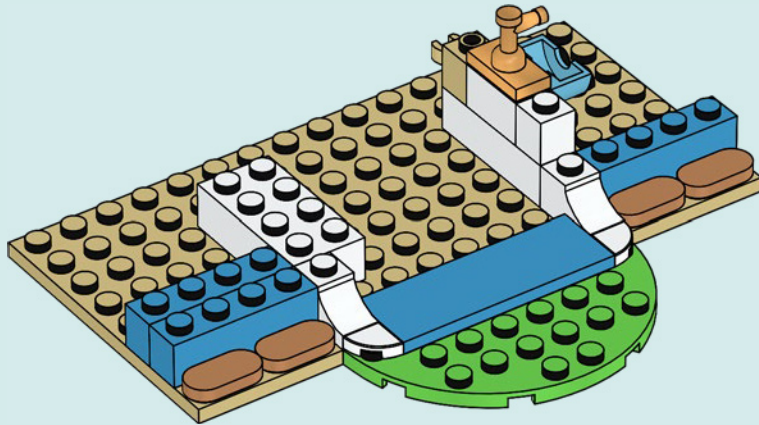



13

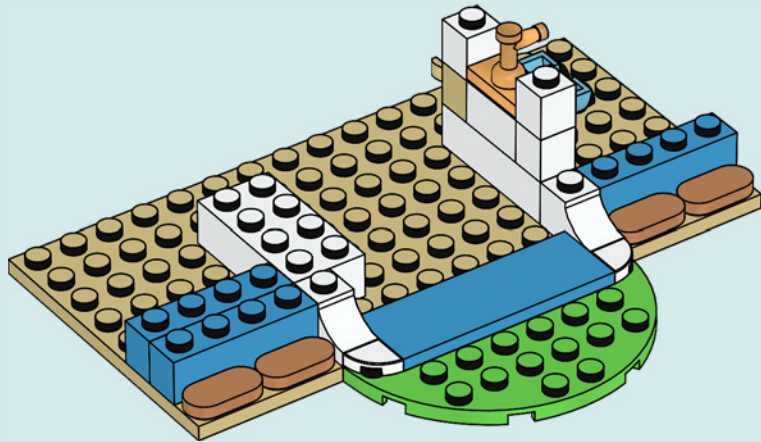

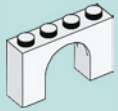

1x

14

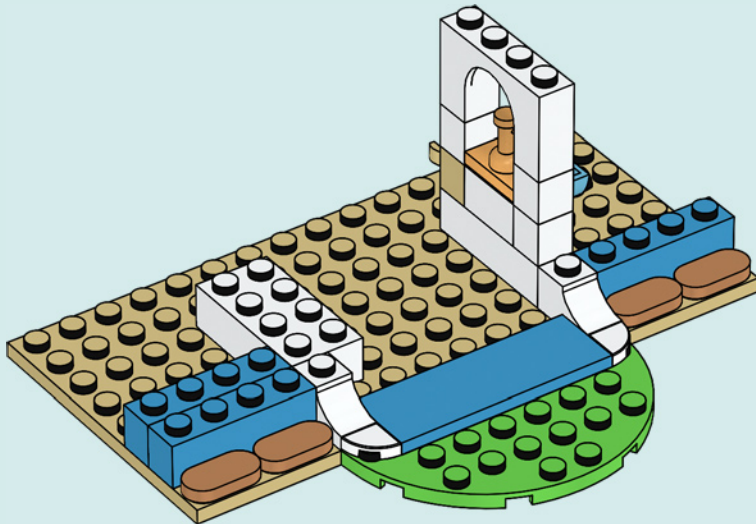

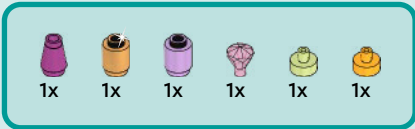

15

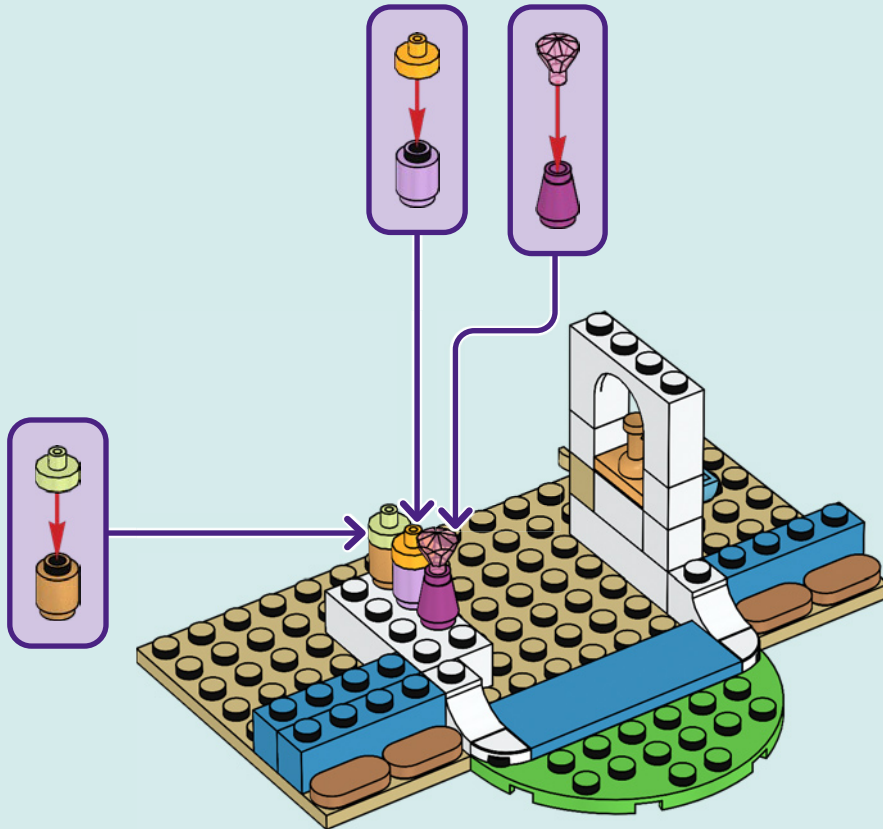



2x

16

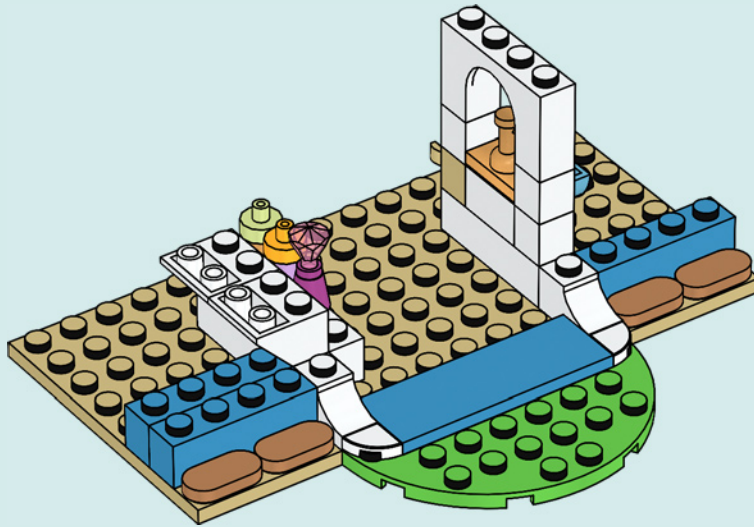

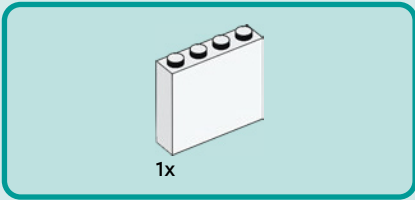

17

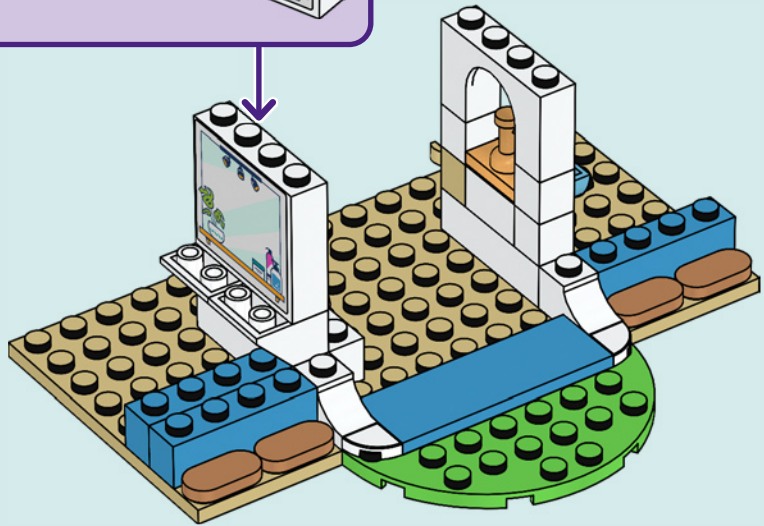
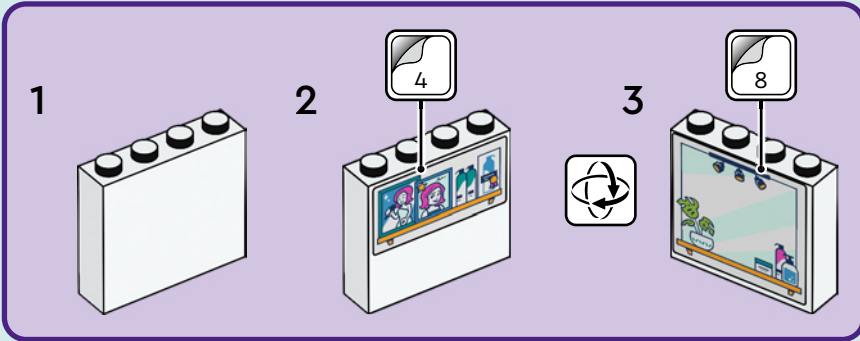



4x

18

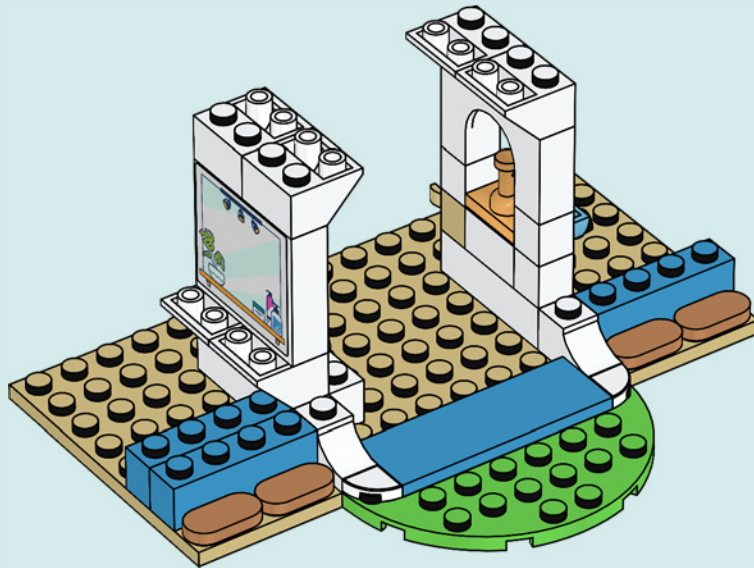

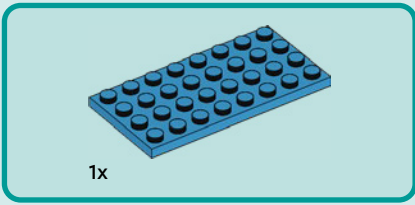

19

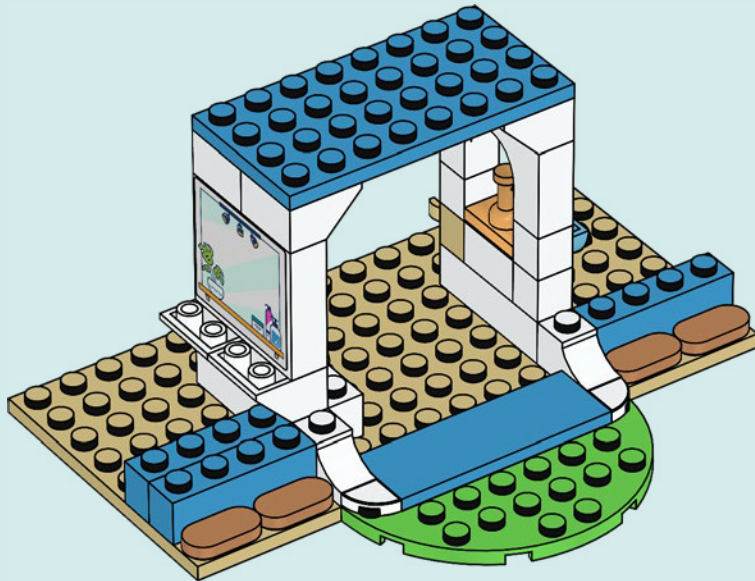

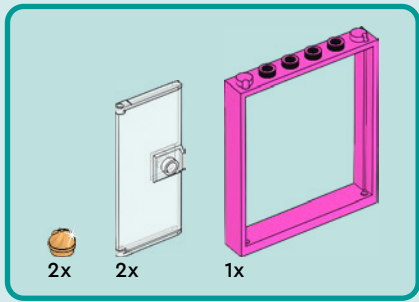

20

1

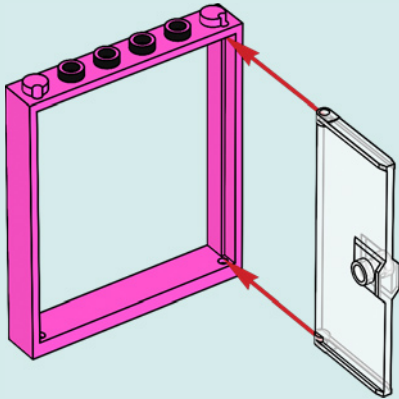

2

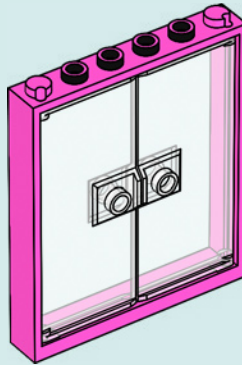

3

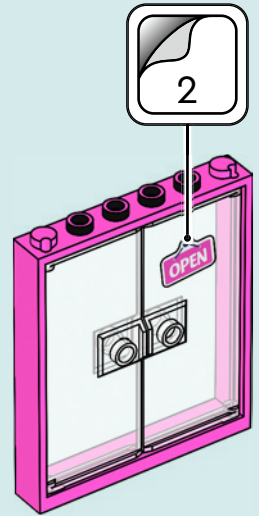

4

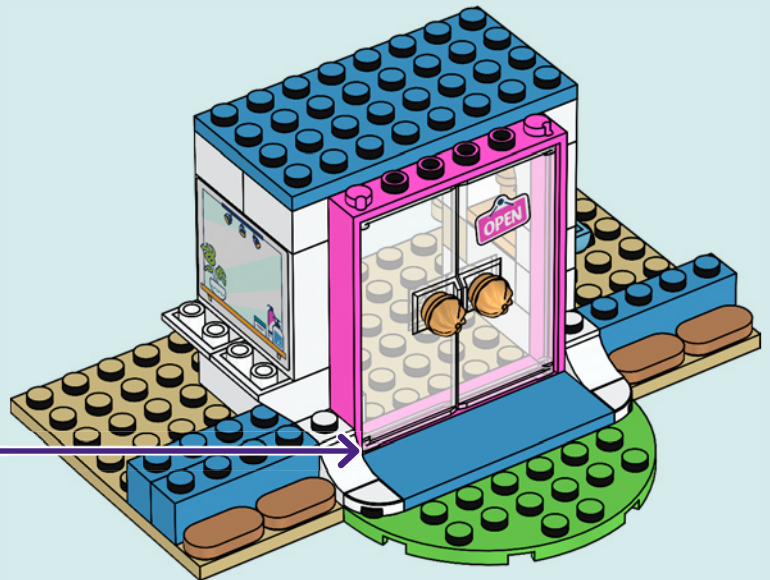
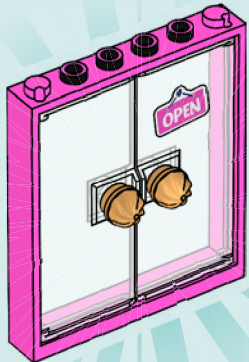



2x

21

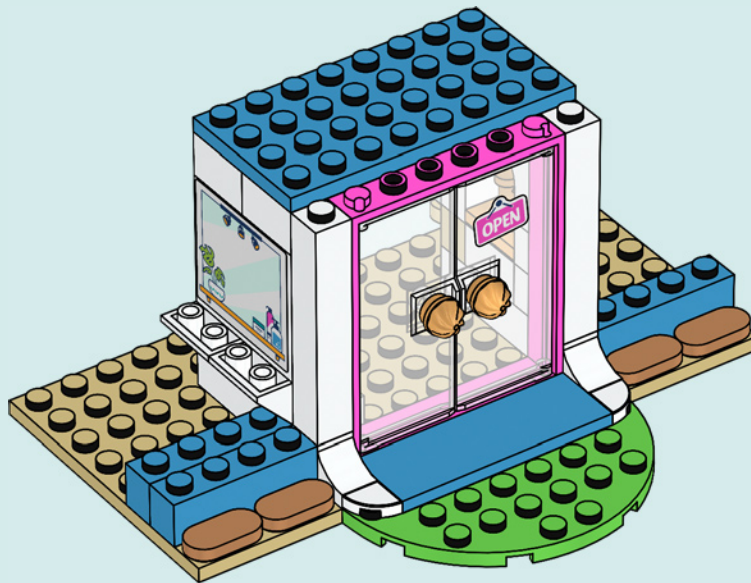

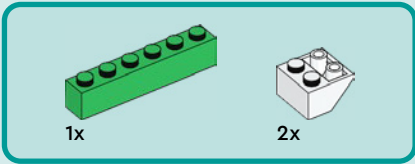

22

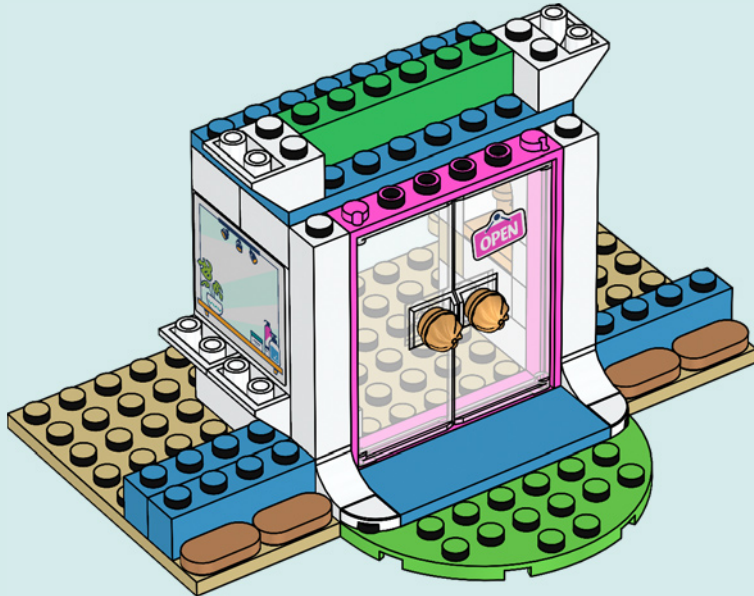

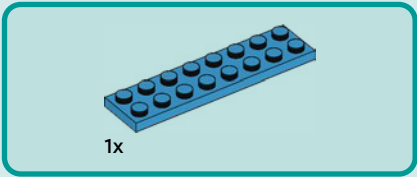

23

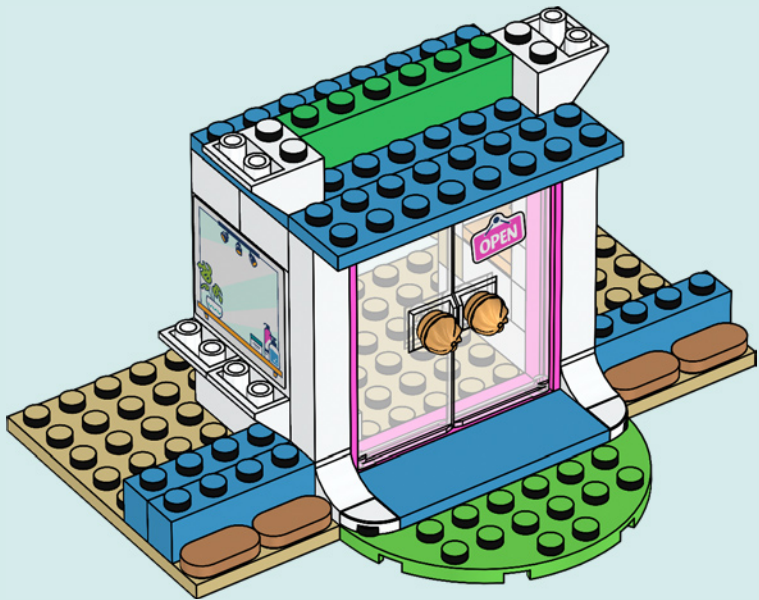



1x

24

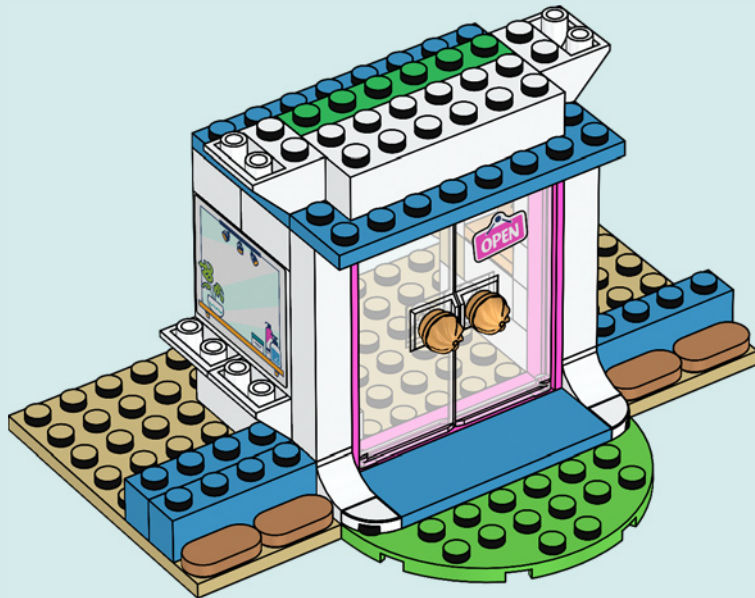



1x

25

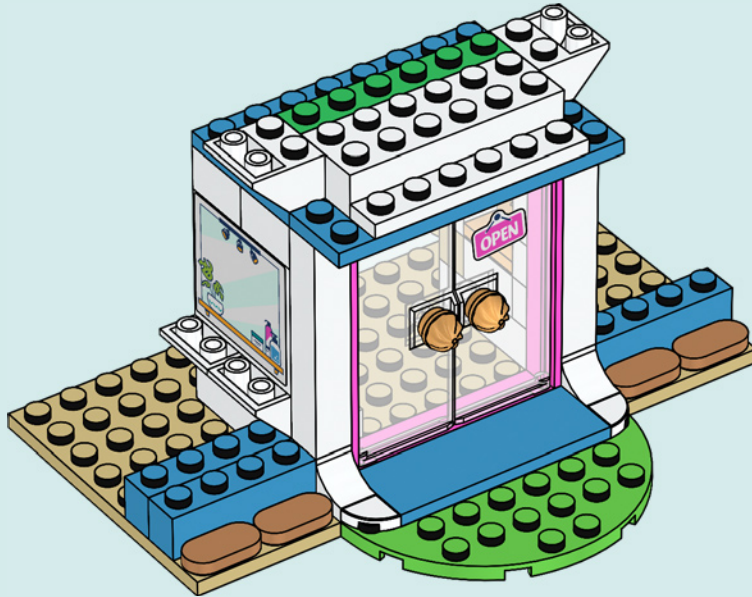



2x



2x

26

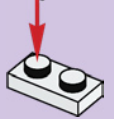
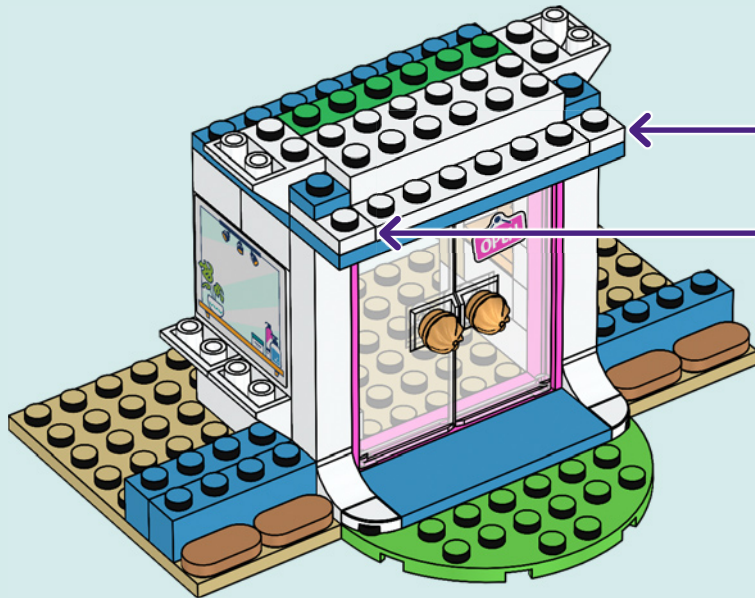

2x



6x



6x

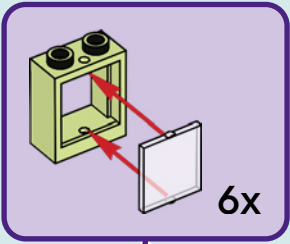

27

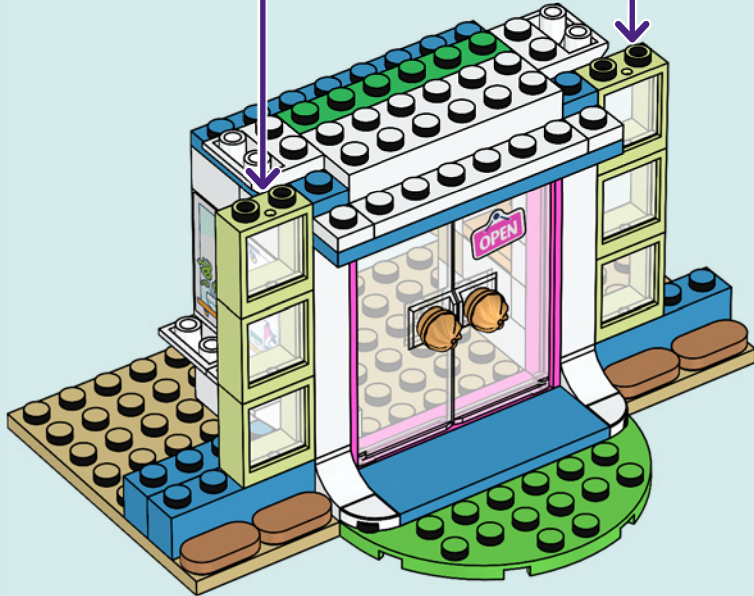



2x

28

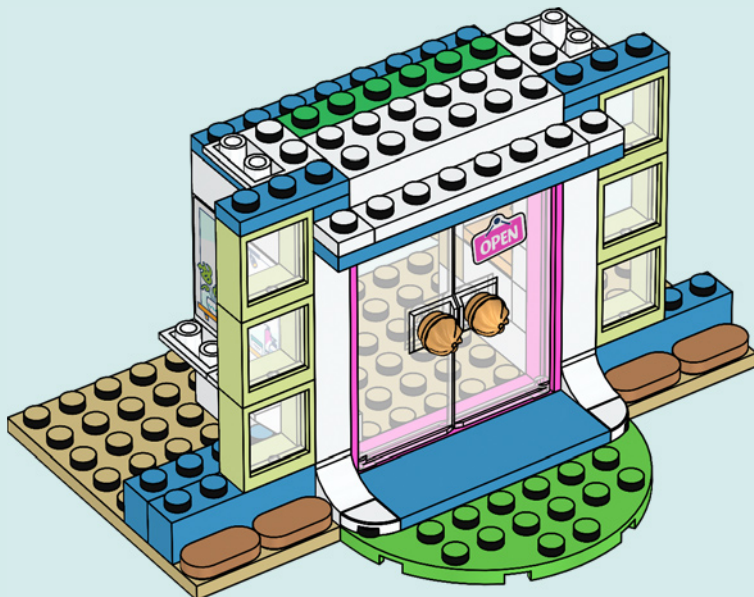



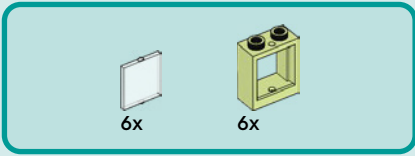

29

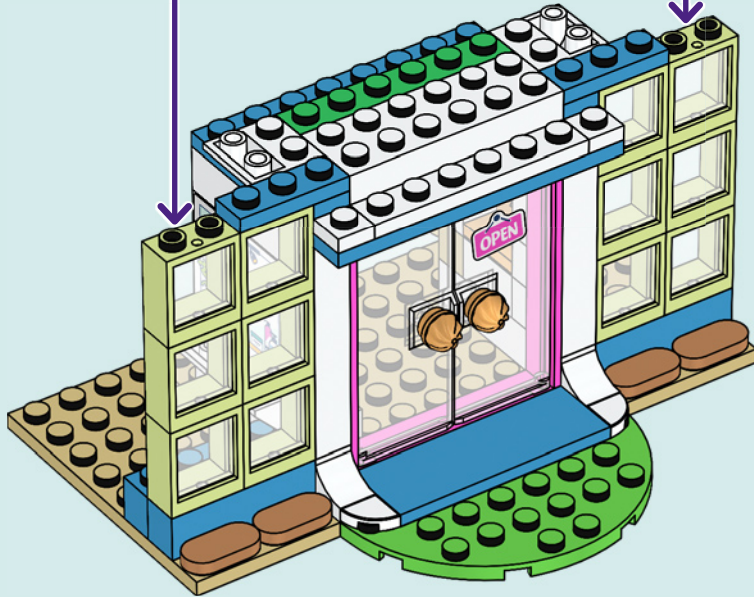
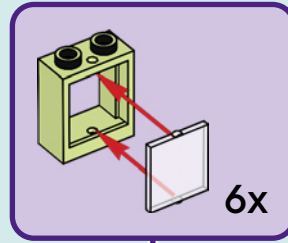

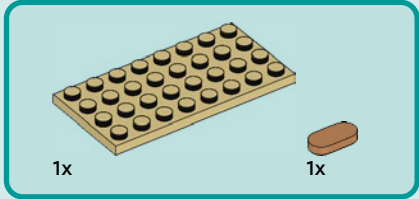
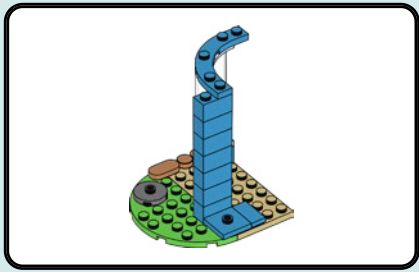

30

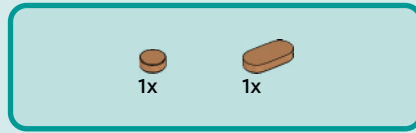
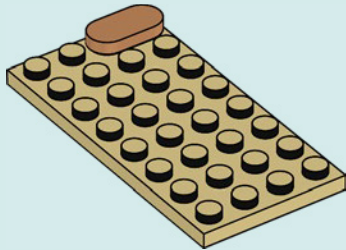

31

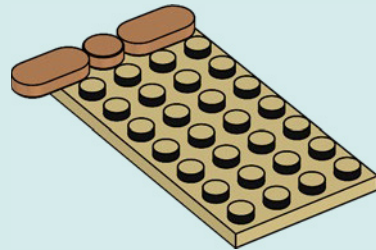

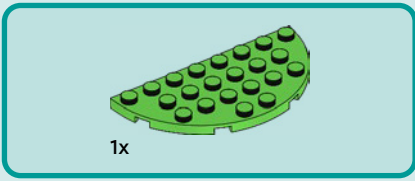

32

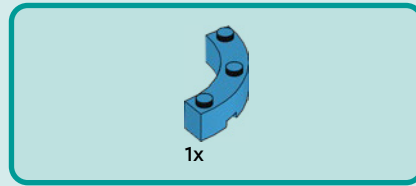
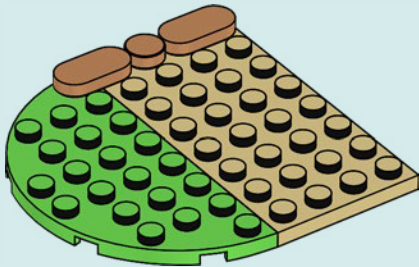

33

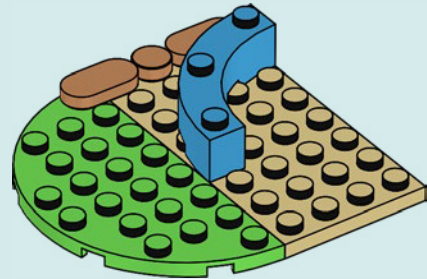

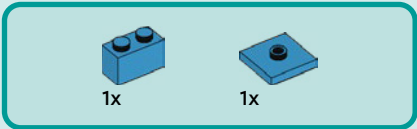

34

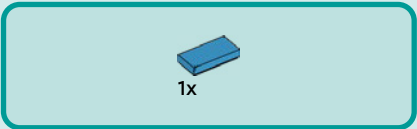
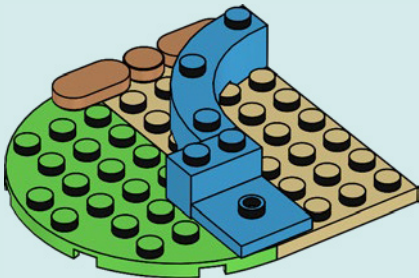

35

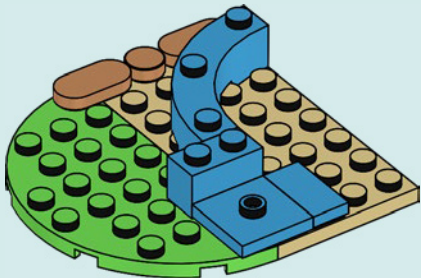

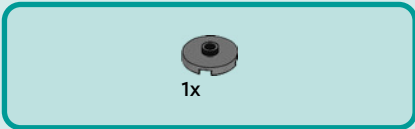

36

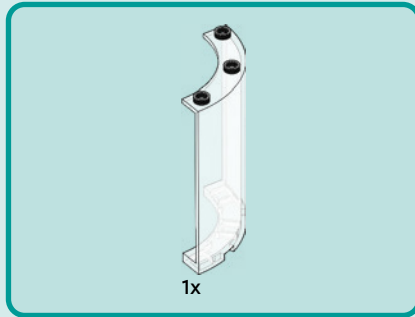
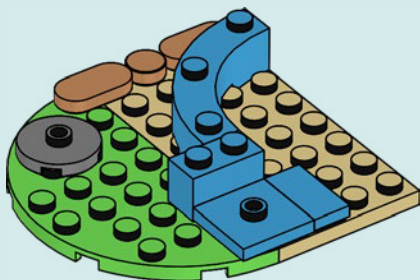

37

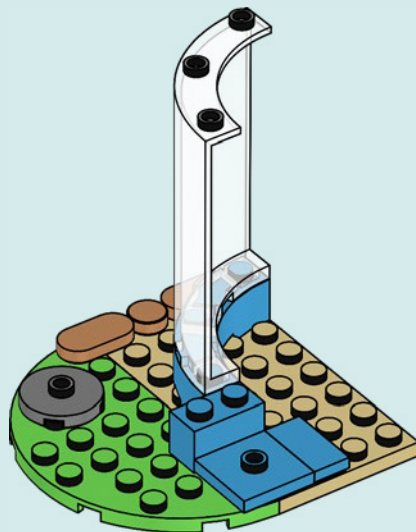



6x

38

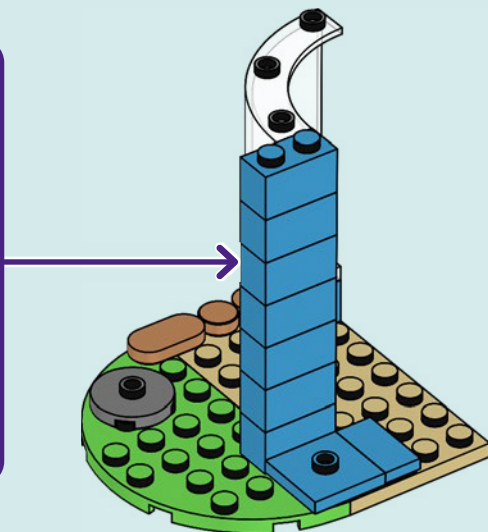
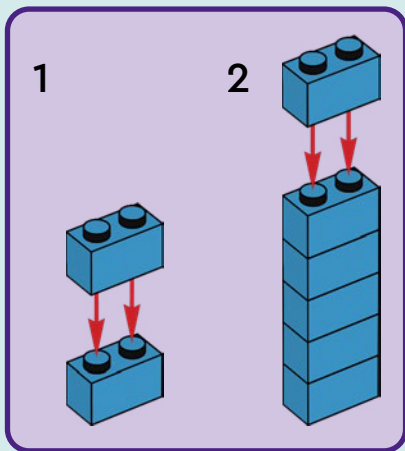

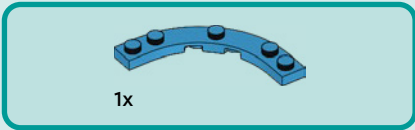

39

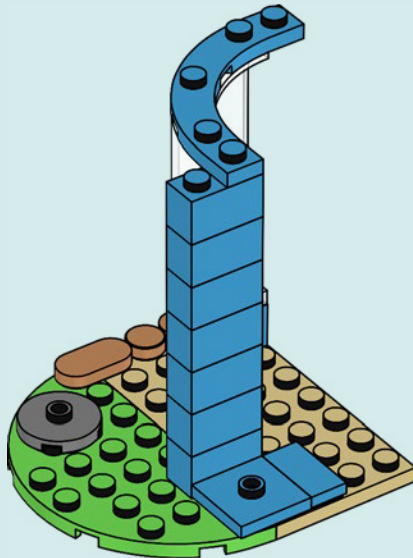

40

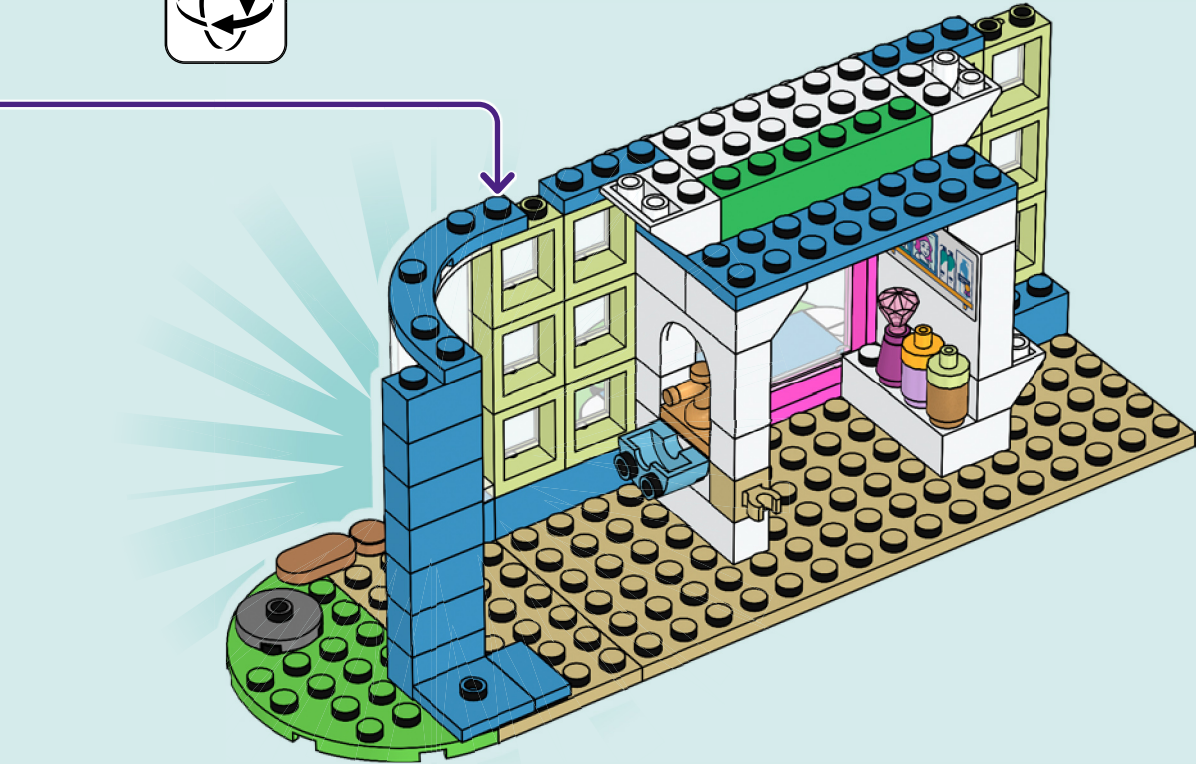



1x



1x

41

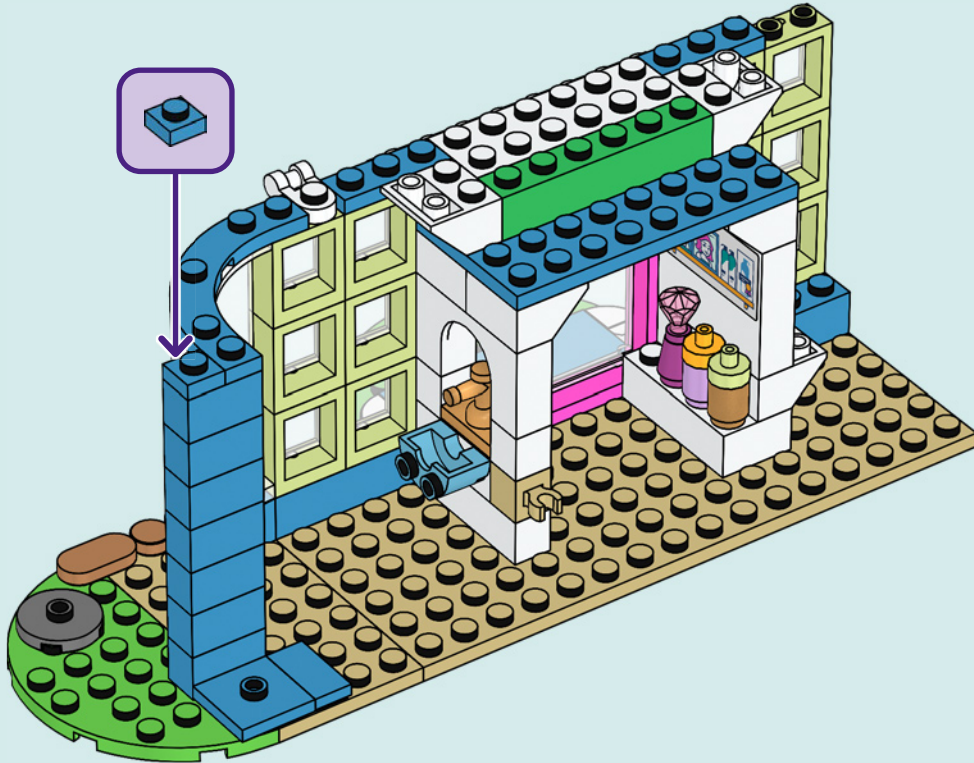

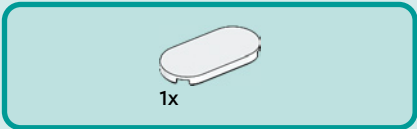

42

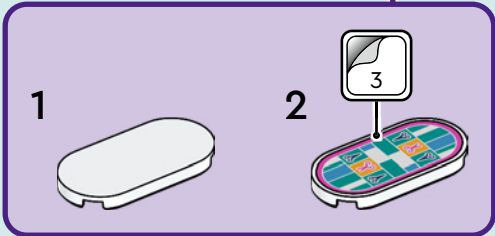
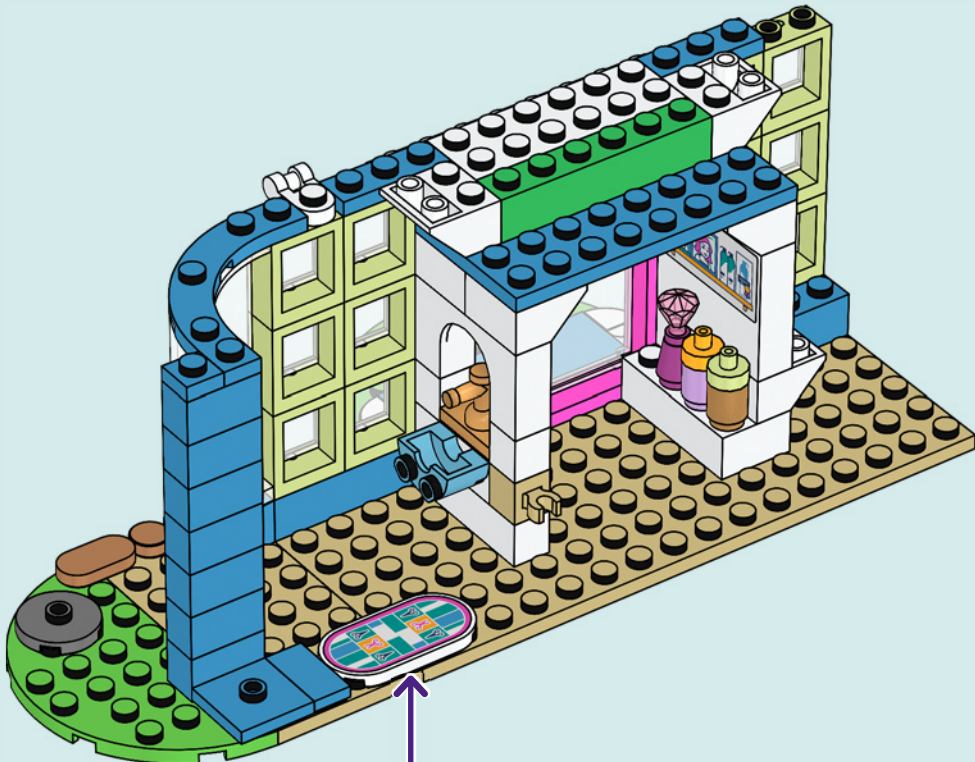

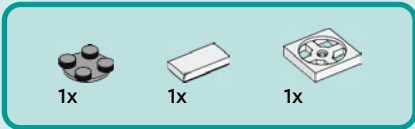

43

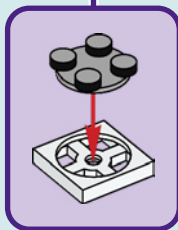
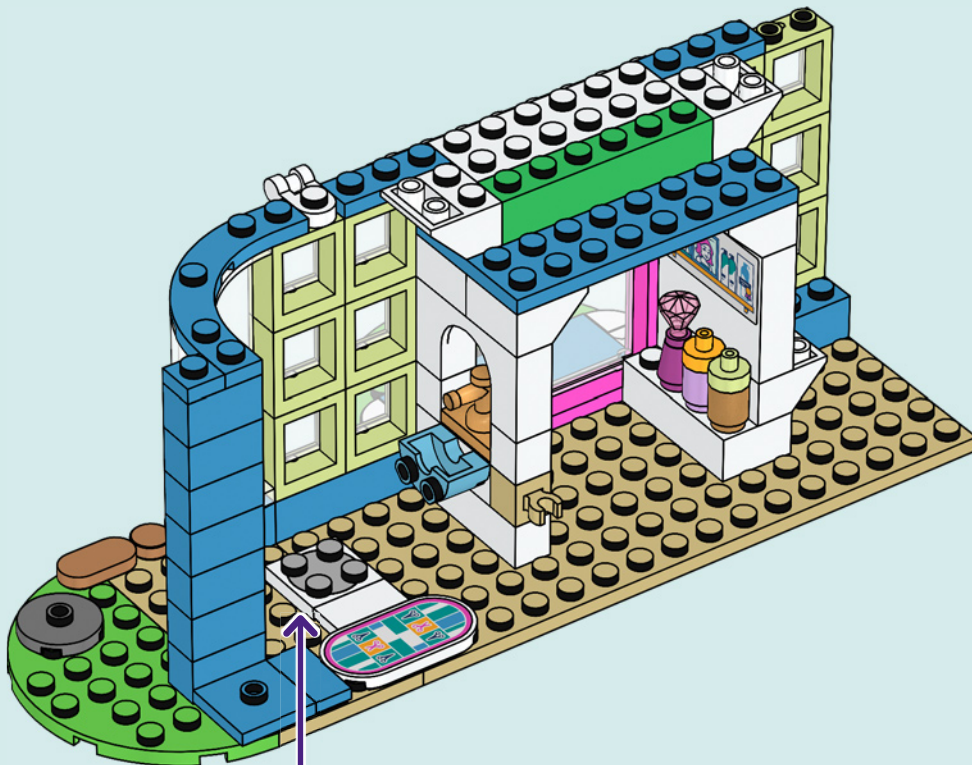

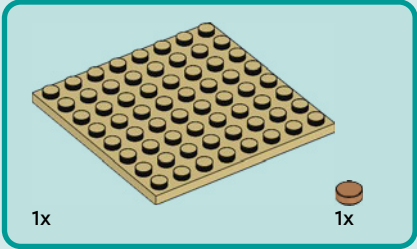
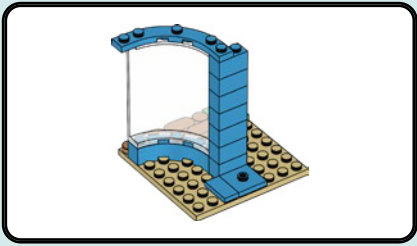

44

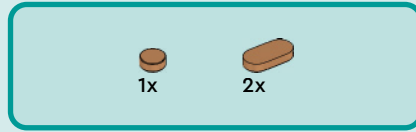
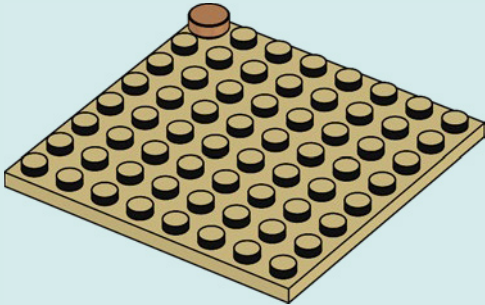

45

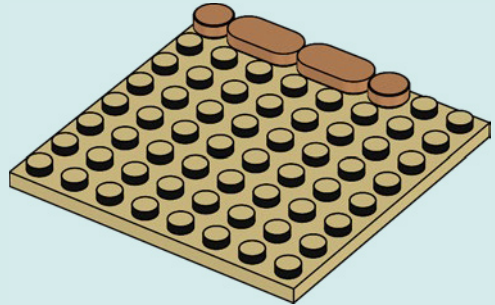

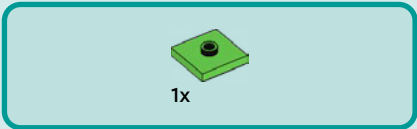

46

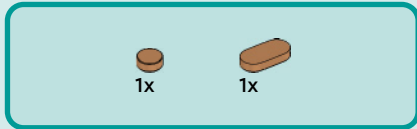
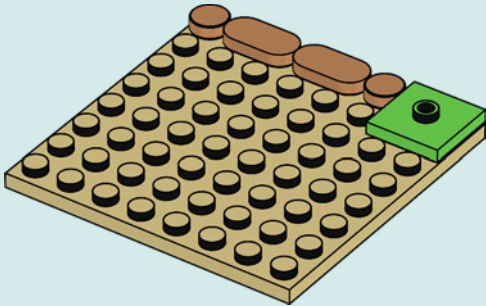

47

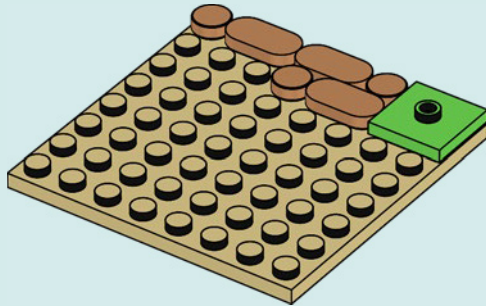

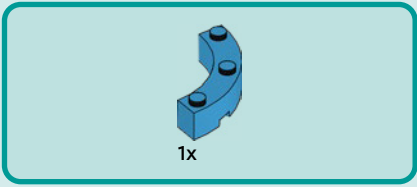

48

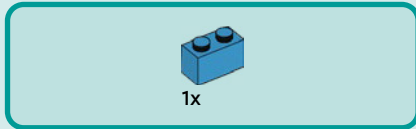
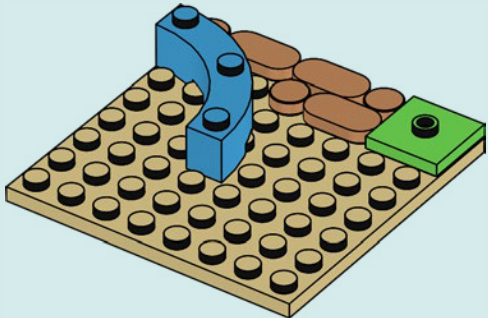

49

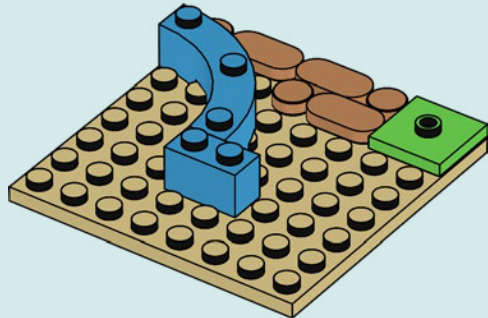

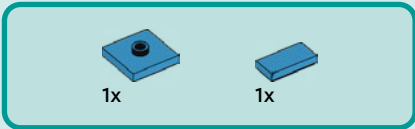

50

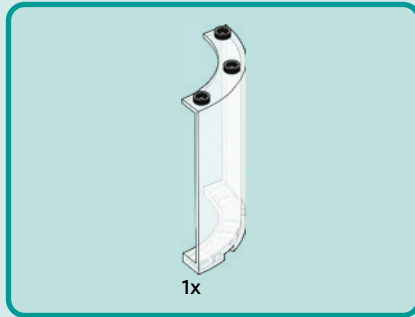
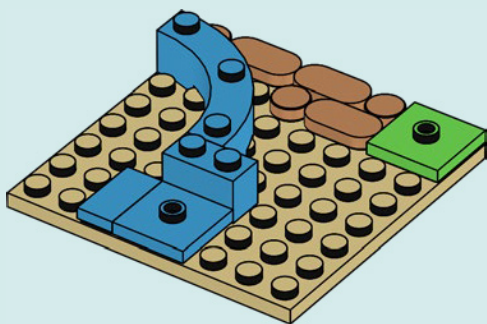

51

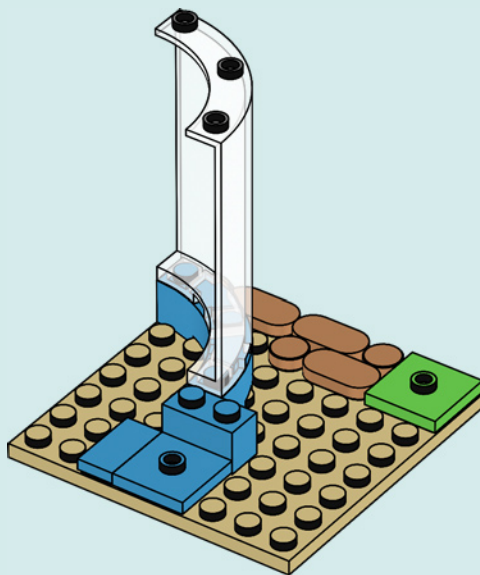



6x

52

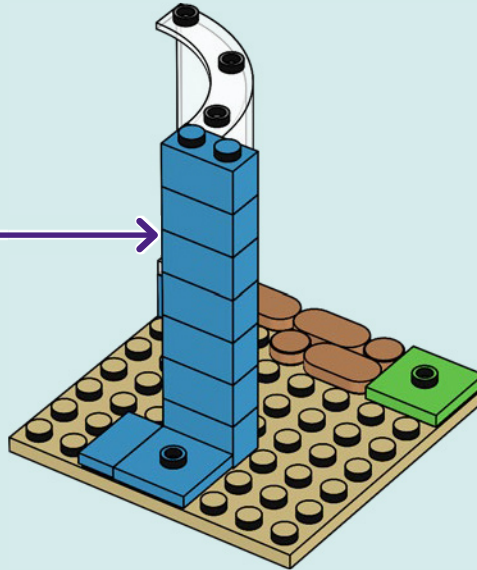
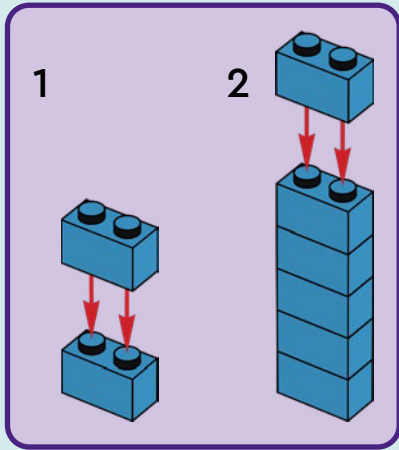

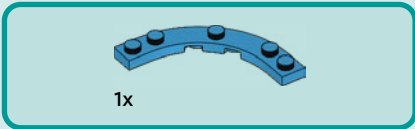

53

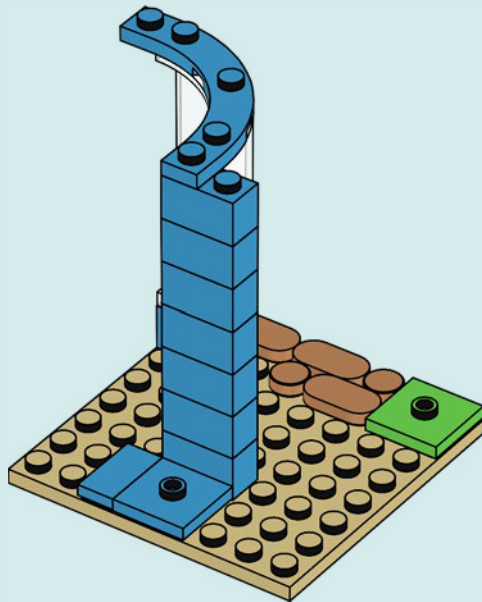

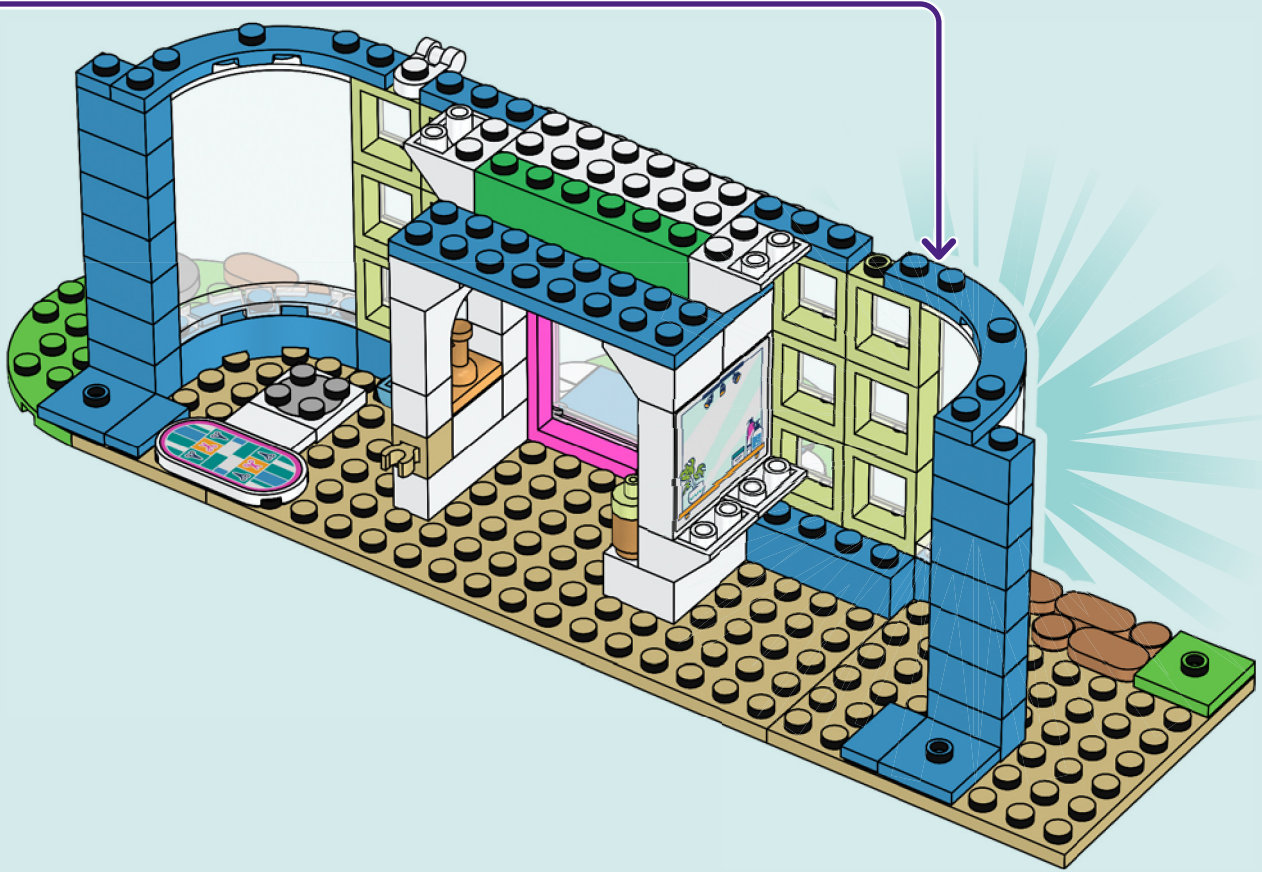



1x



1x

55

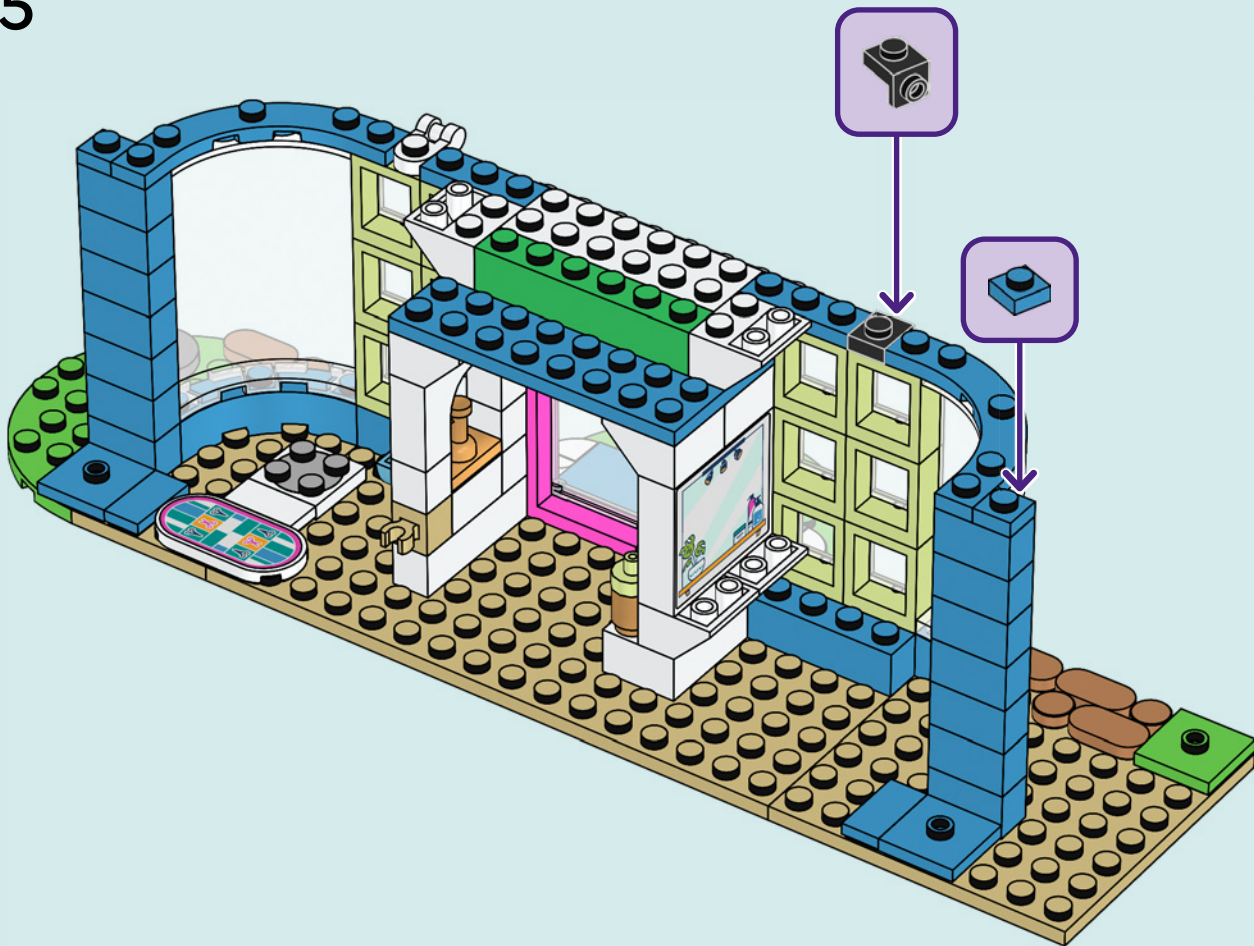

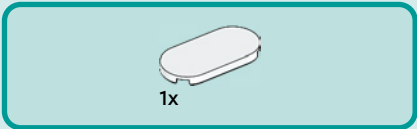

56

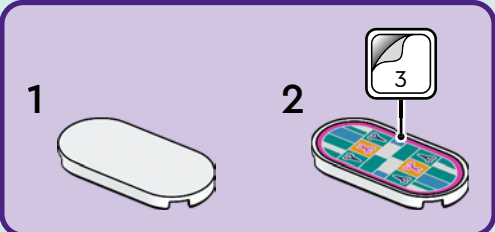
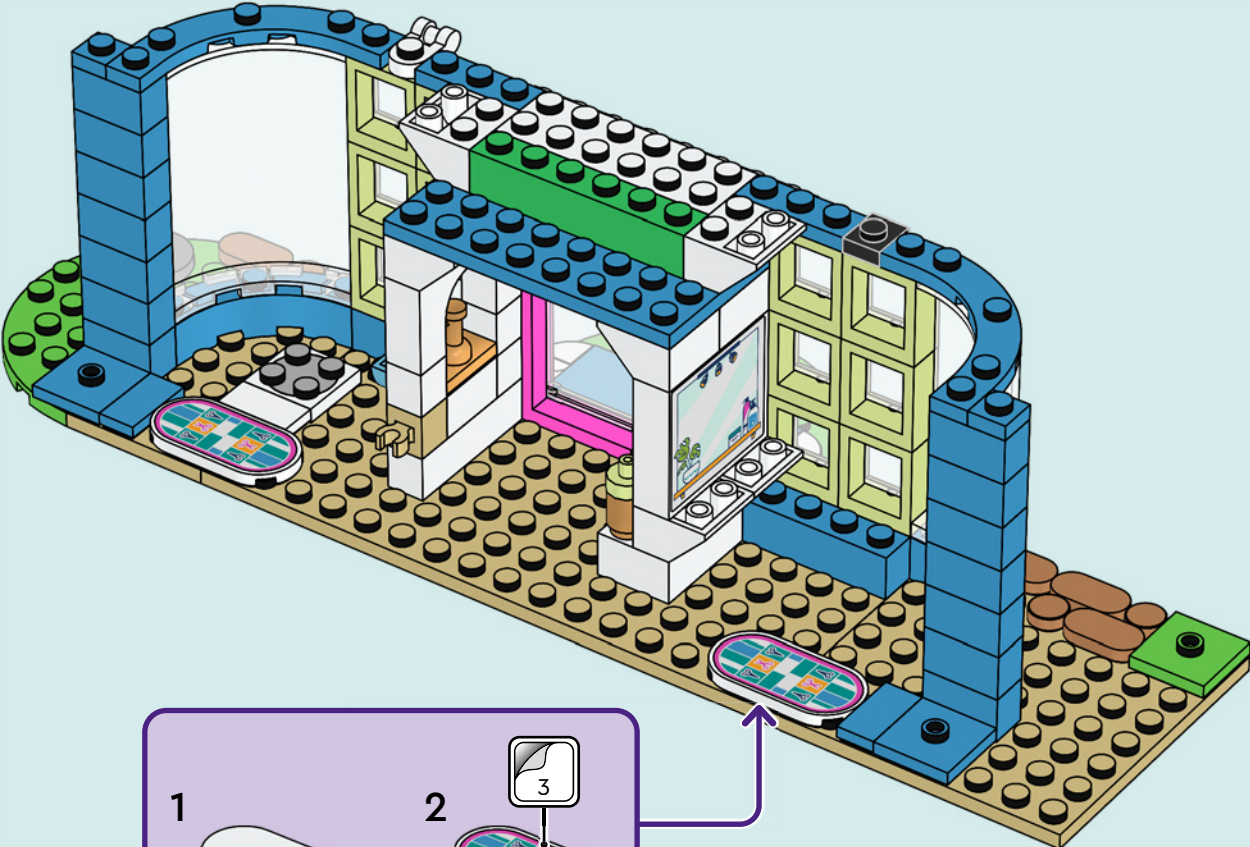



1x



1x

57

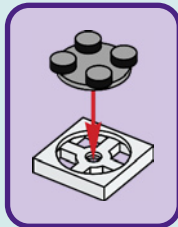
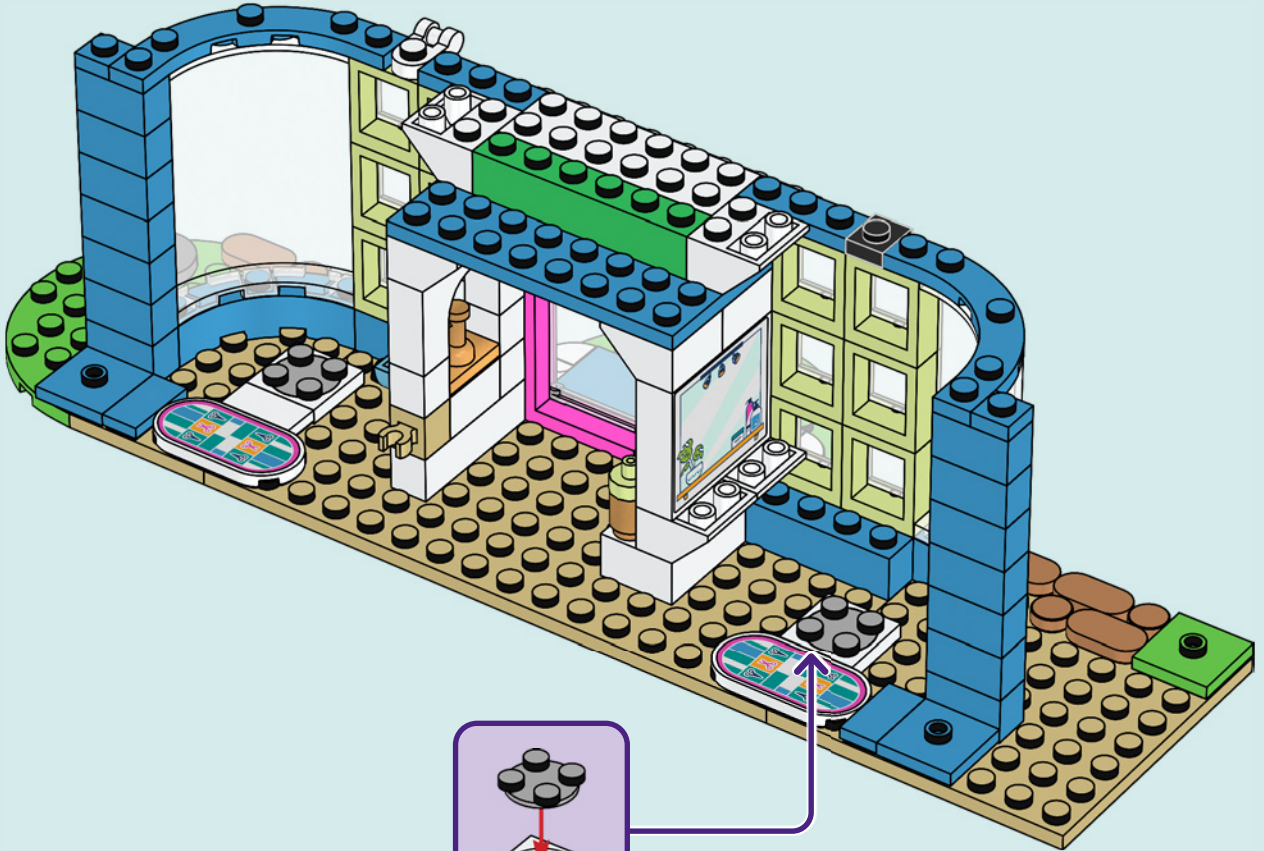



1x

58

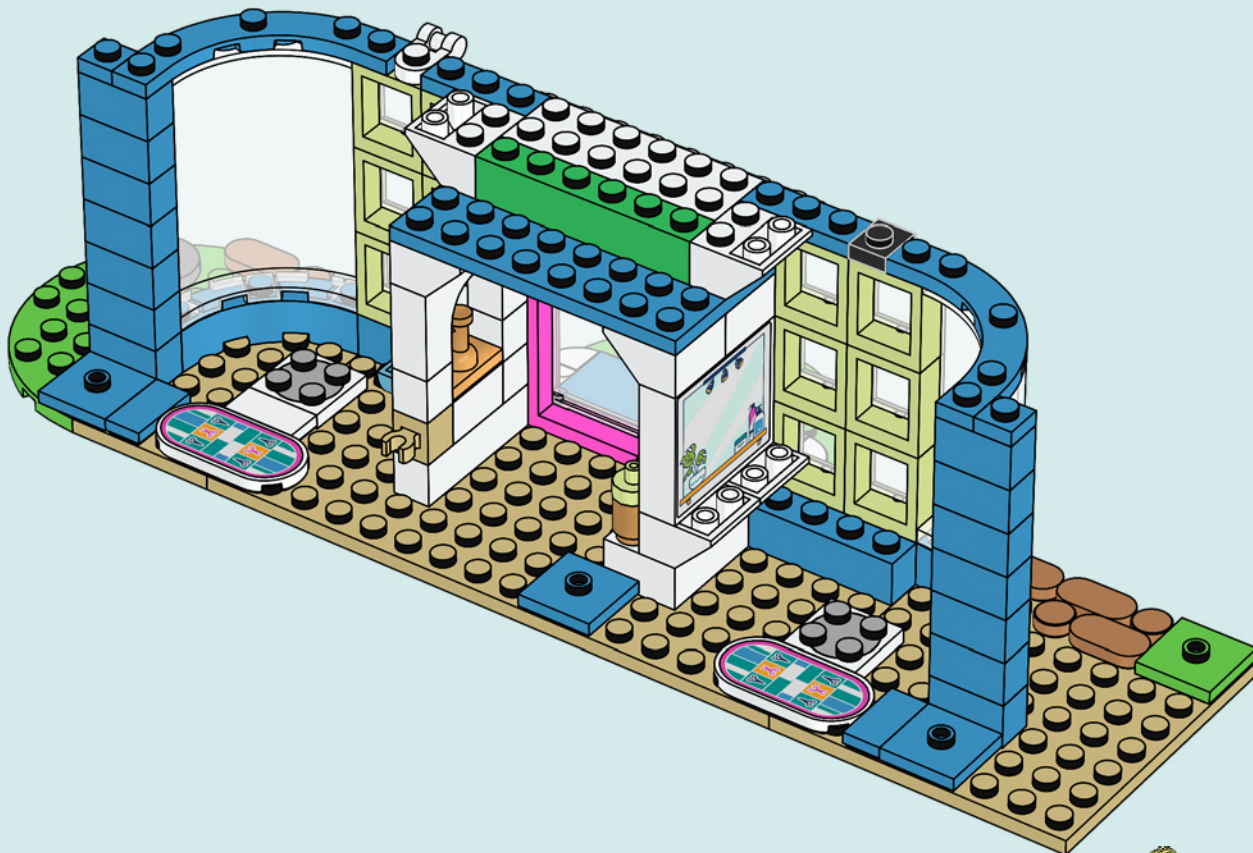



2x

59

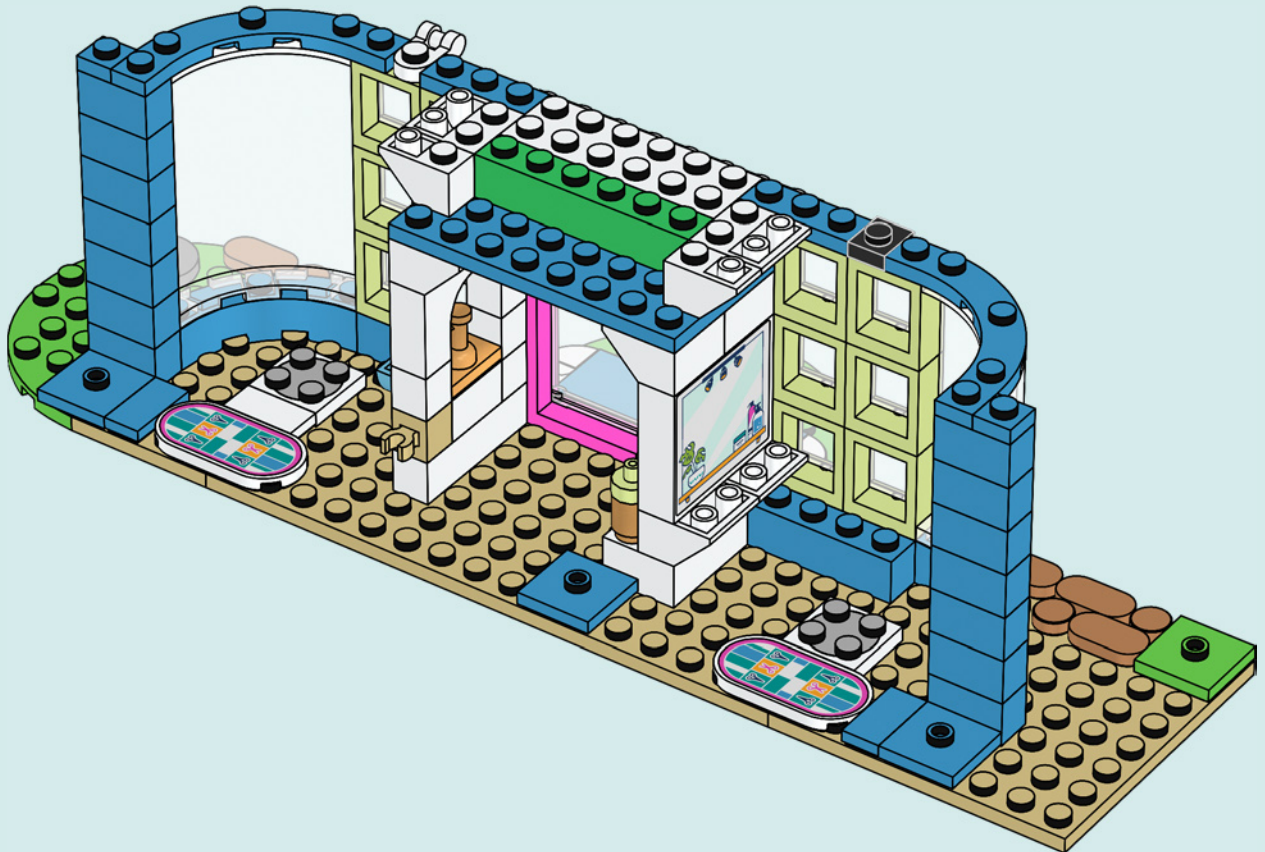



2x

60

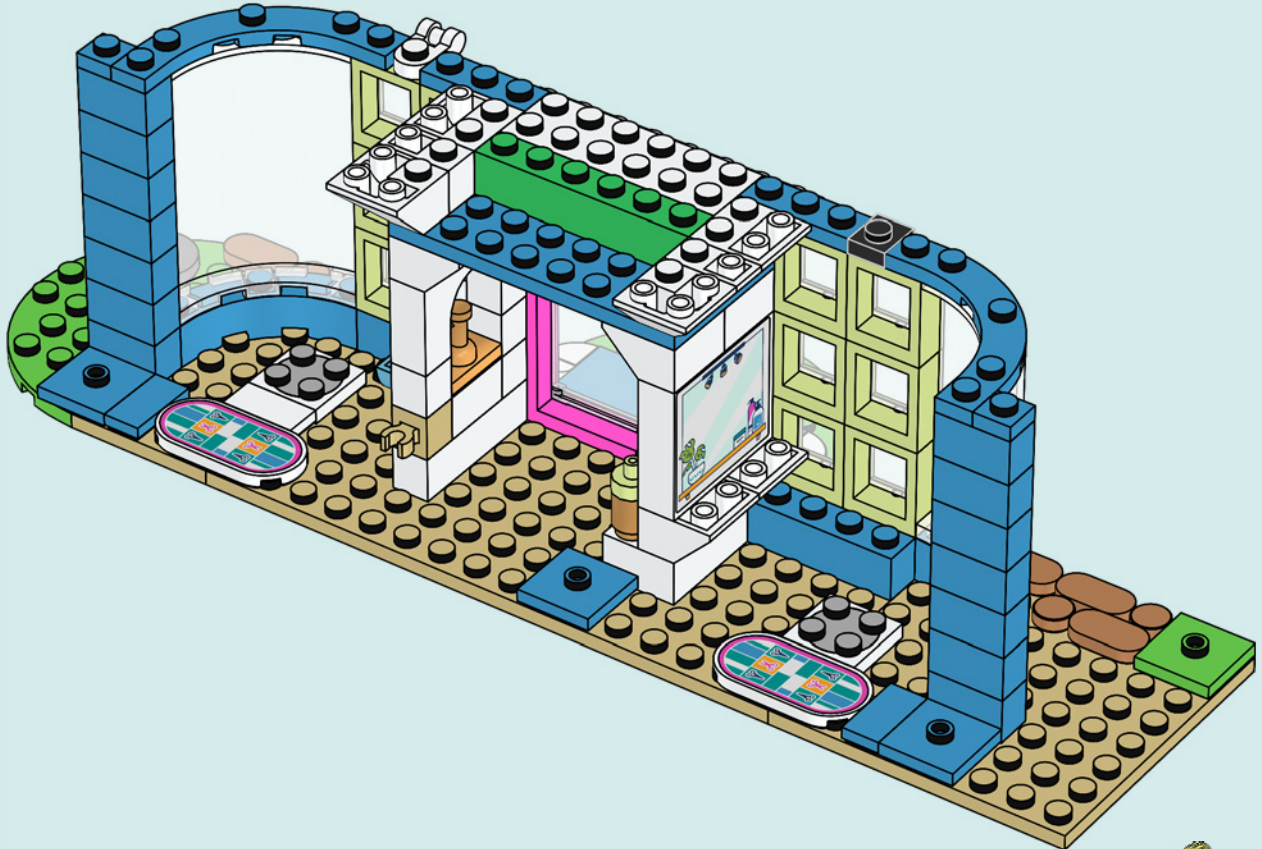

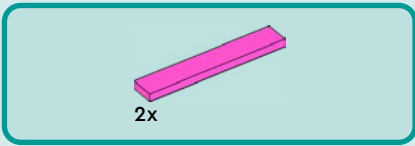

61

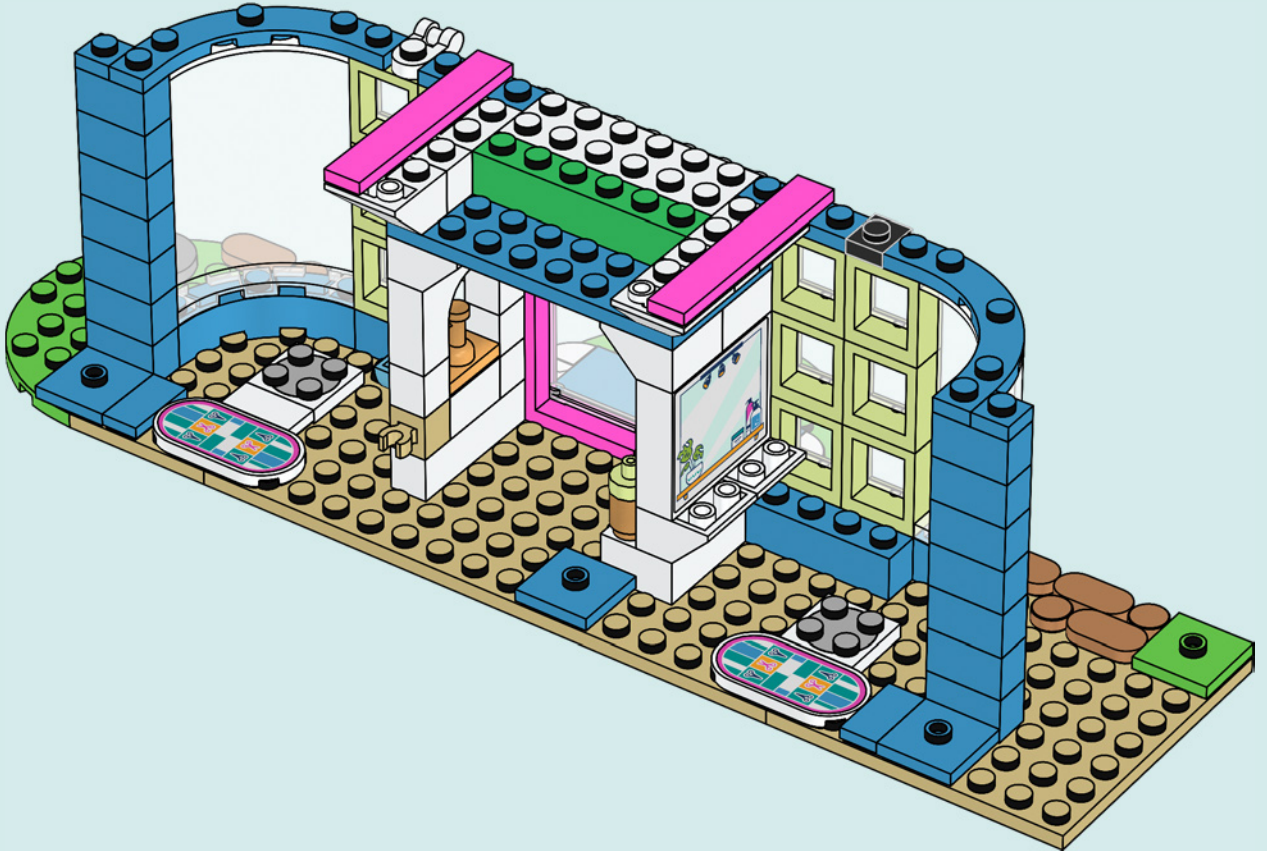

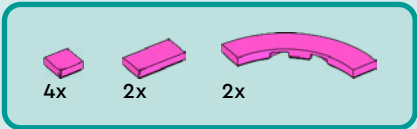

62

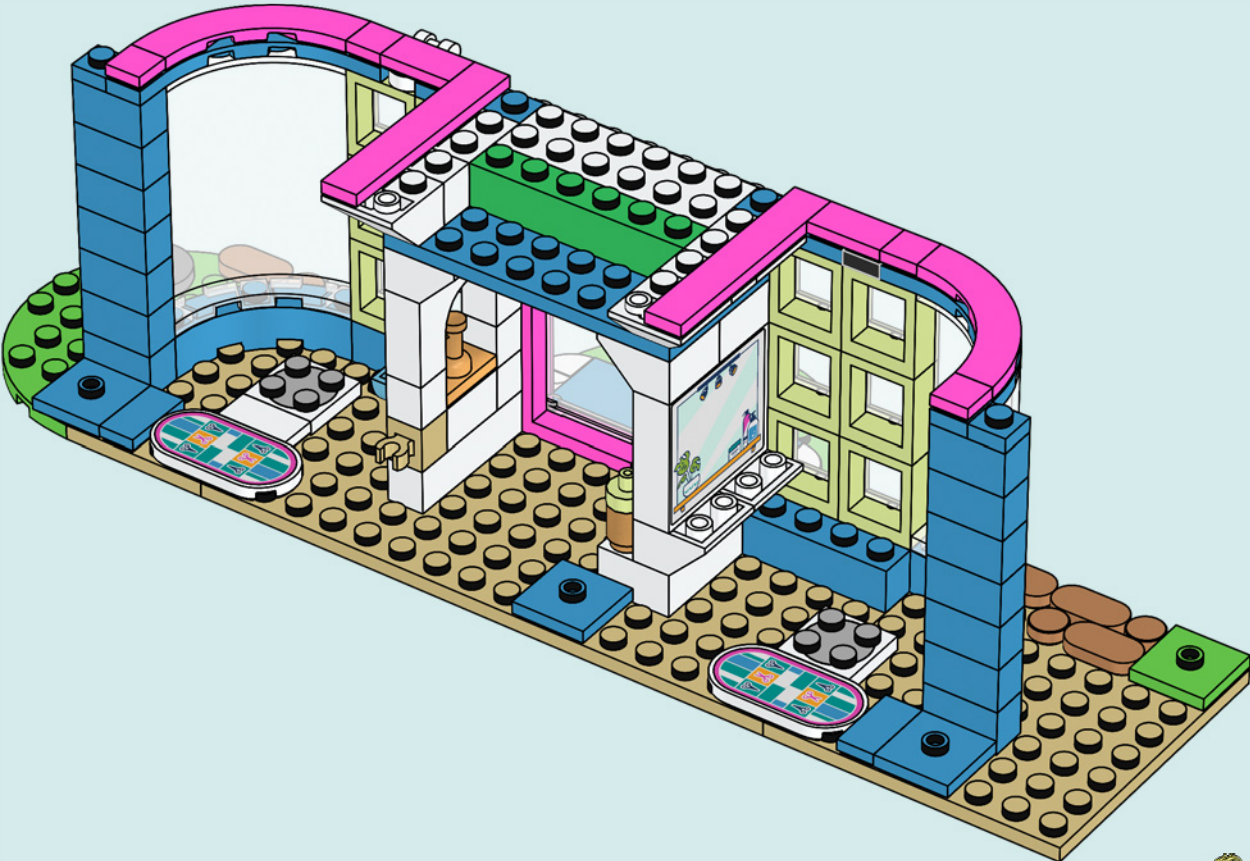

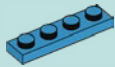

2x

63

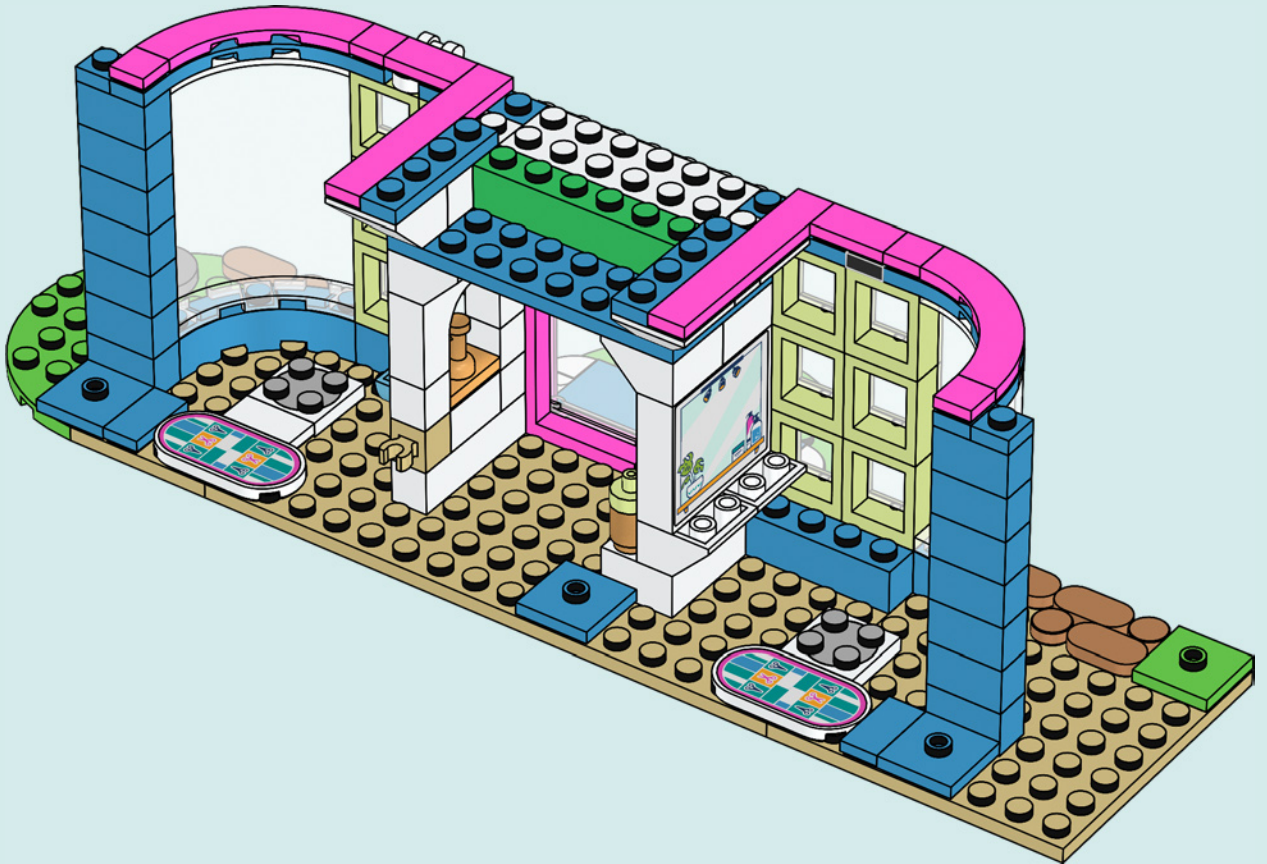



2x

64

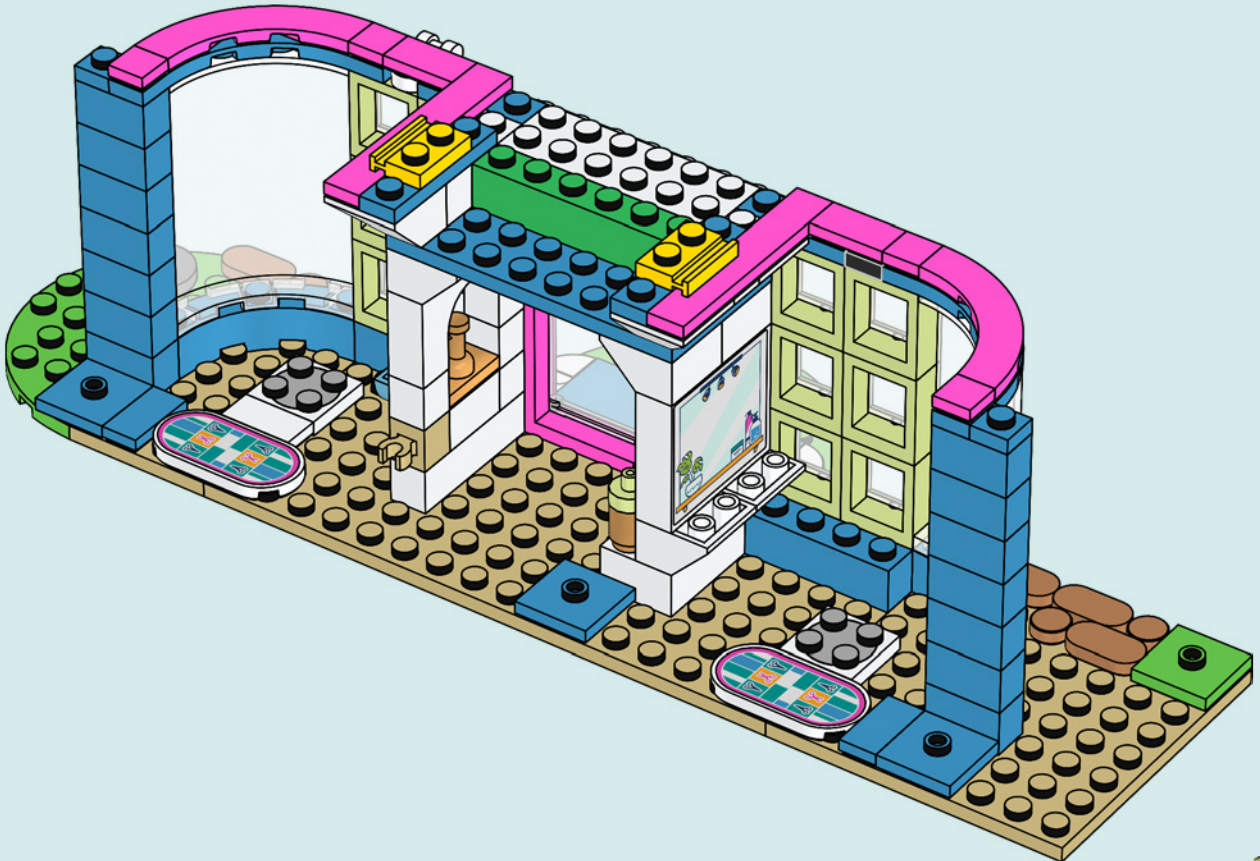

3x

65

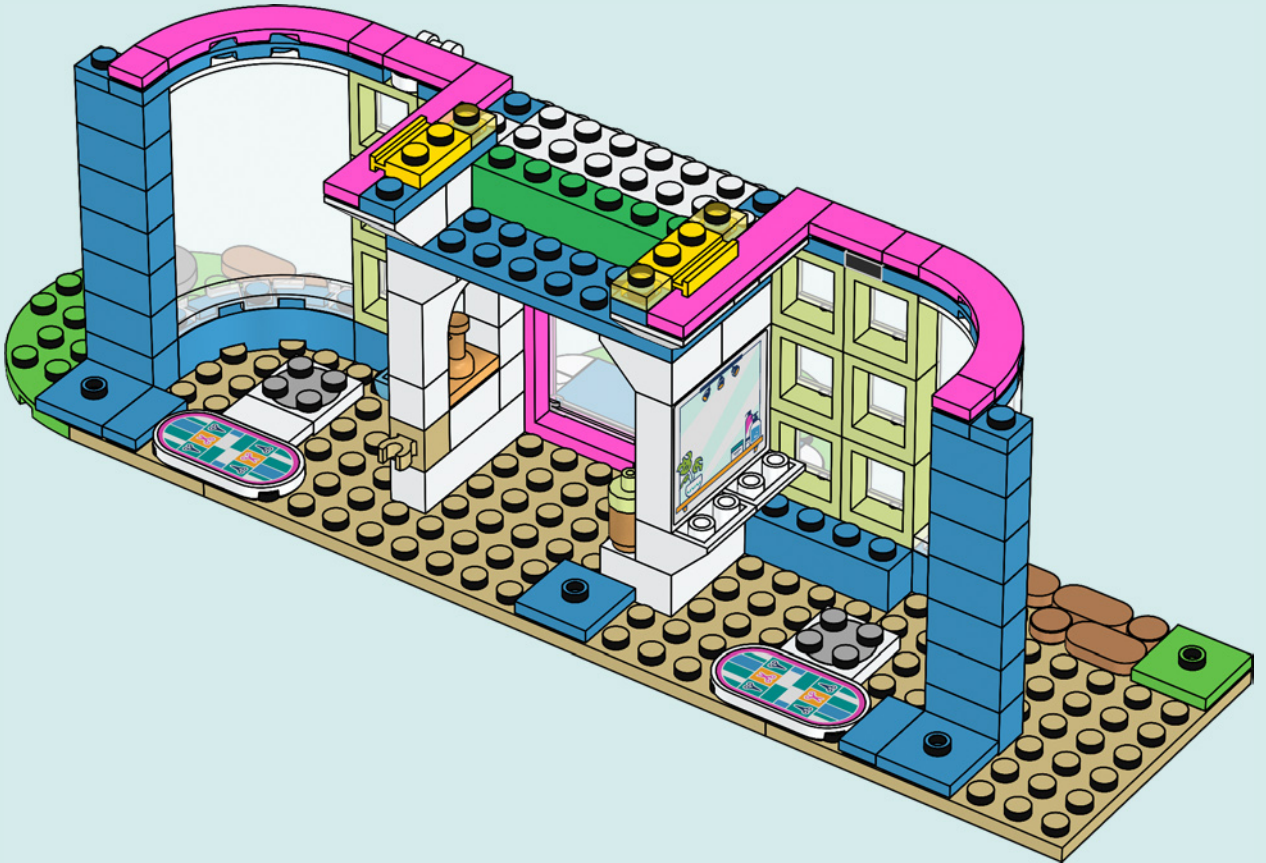

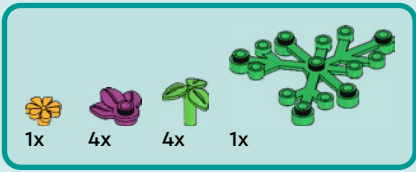

66

1

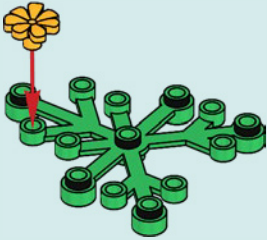

2

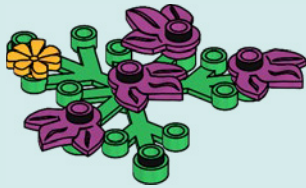

3

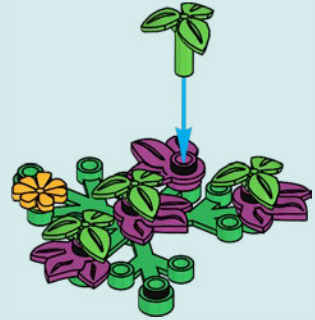

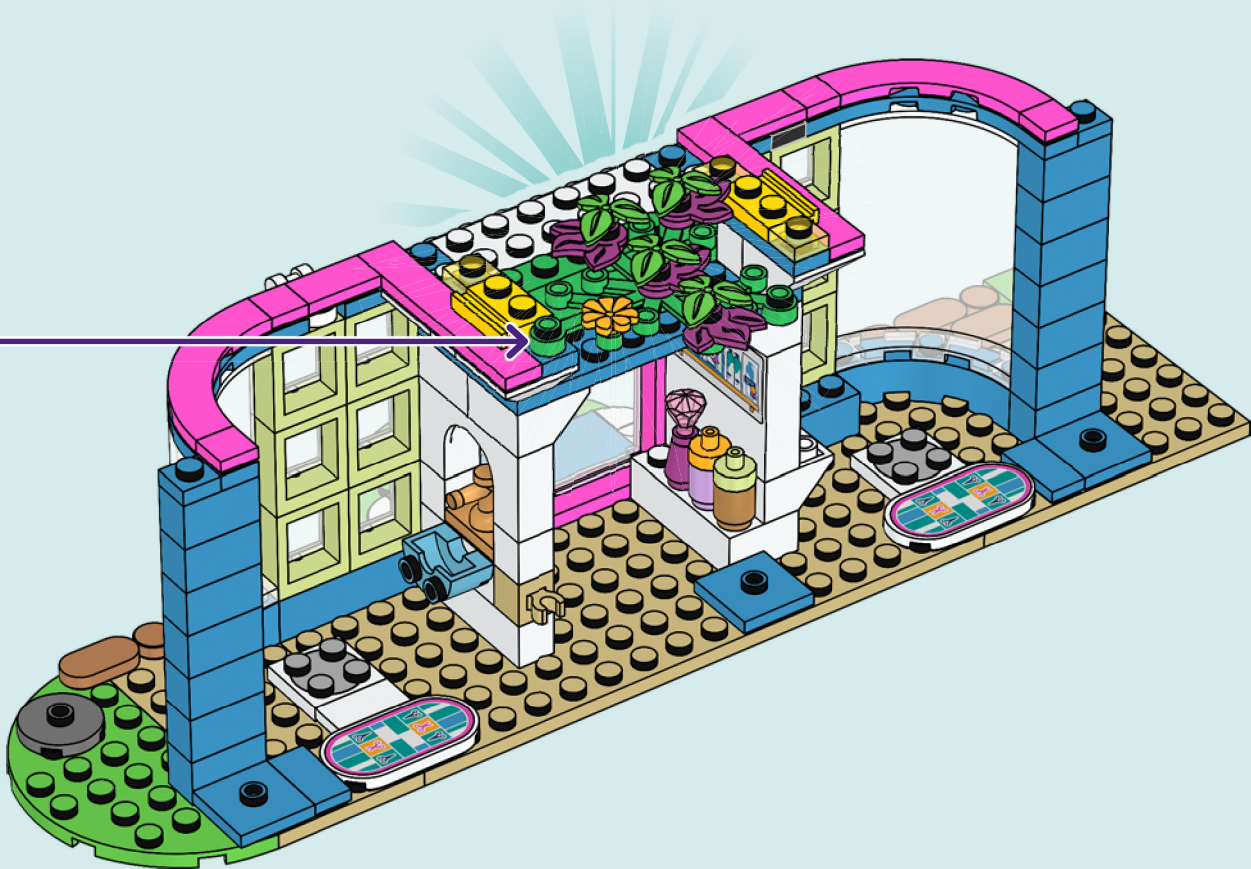



2x

67

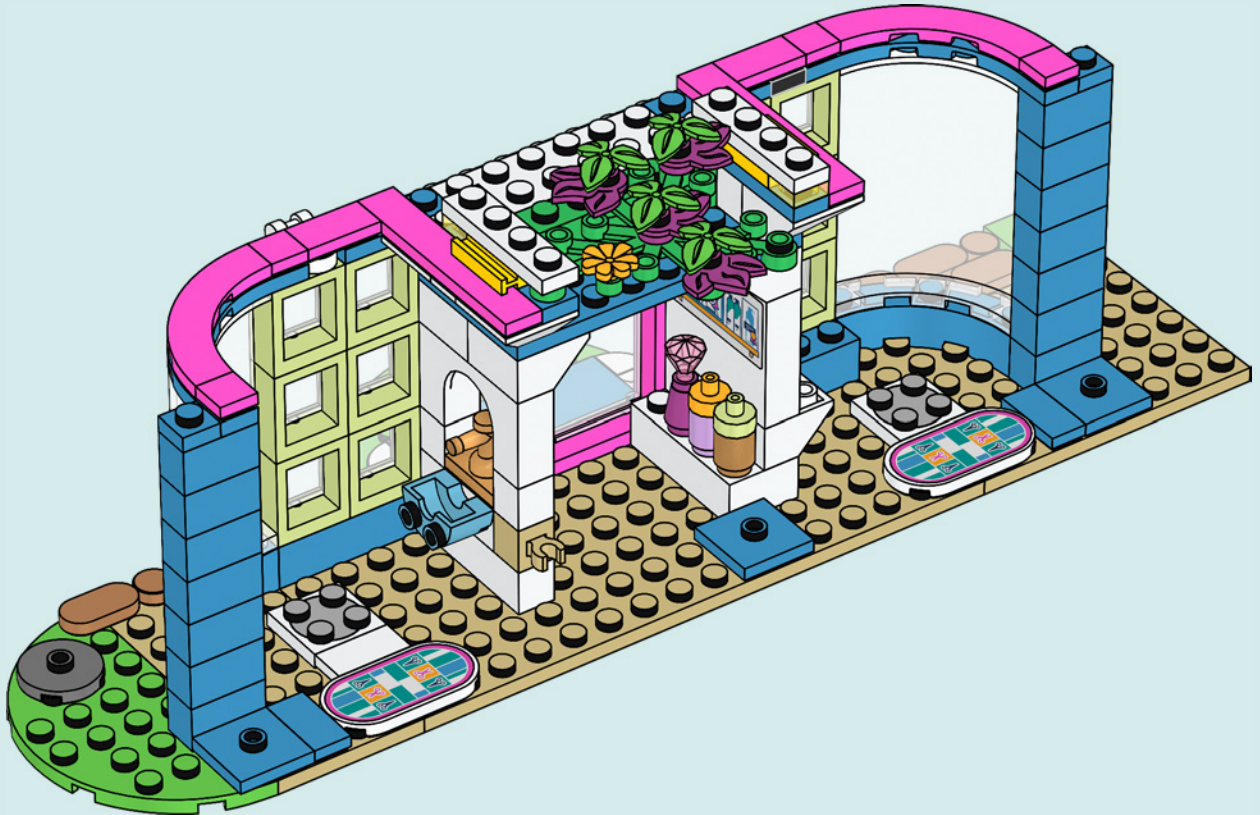

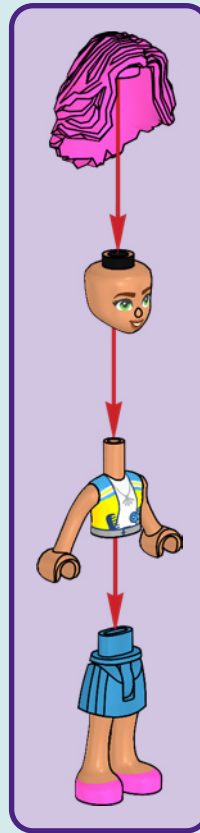

NADIA



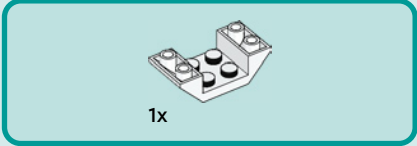
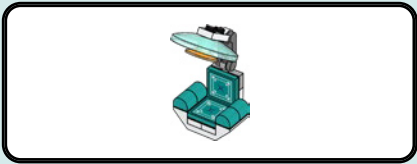

68

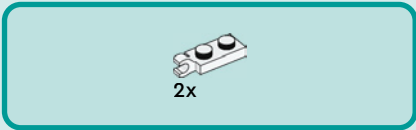
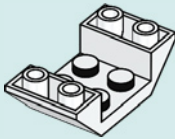

69

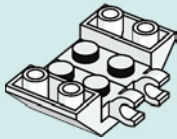

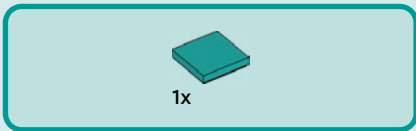

70

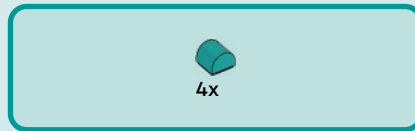
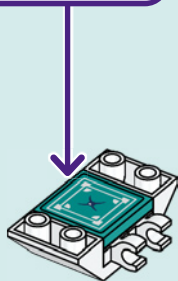
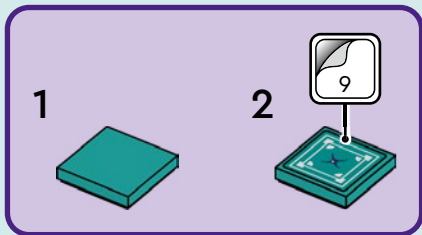

71

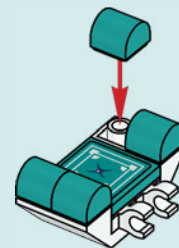

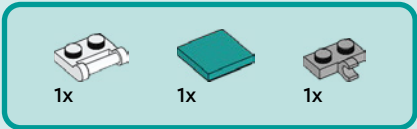

72

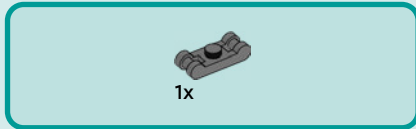
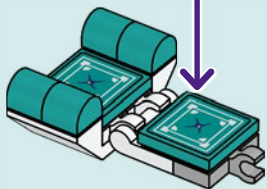
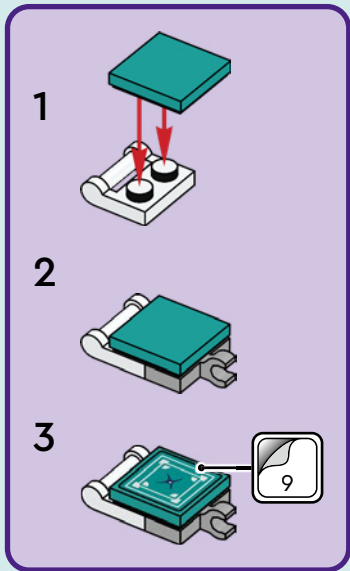

73

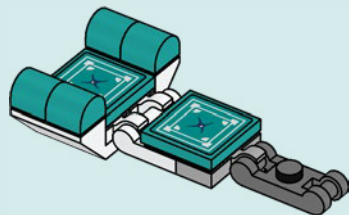

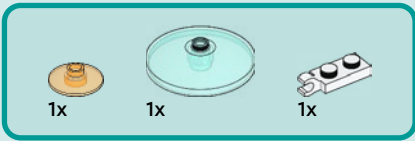

74

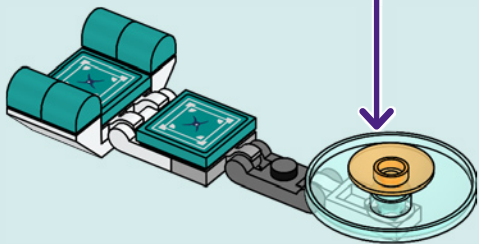
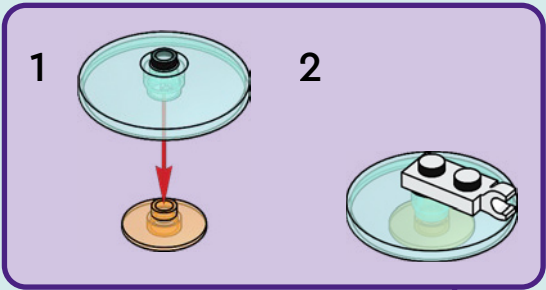

75



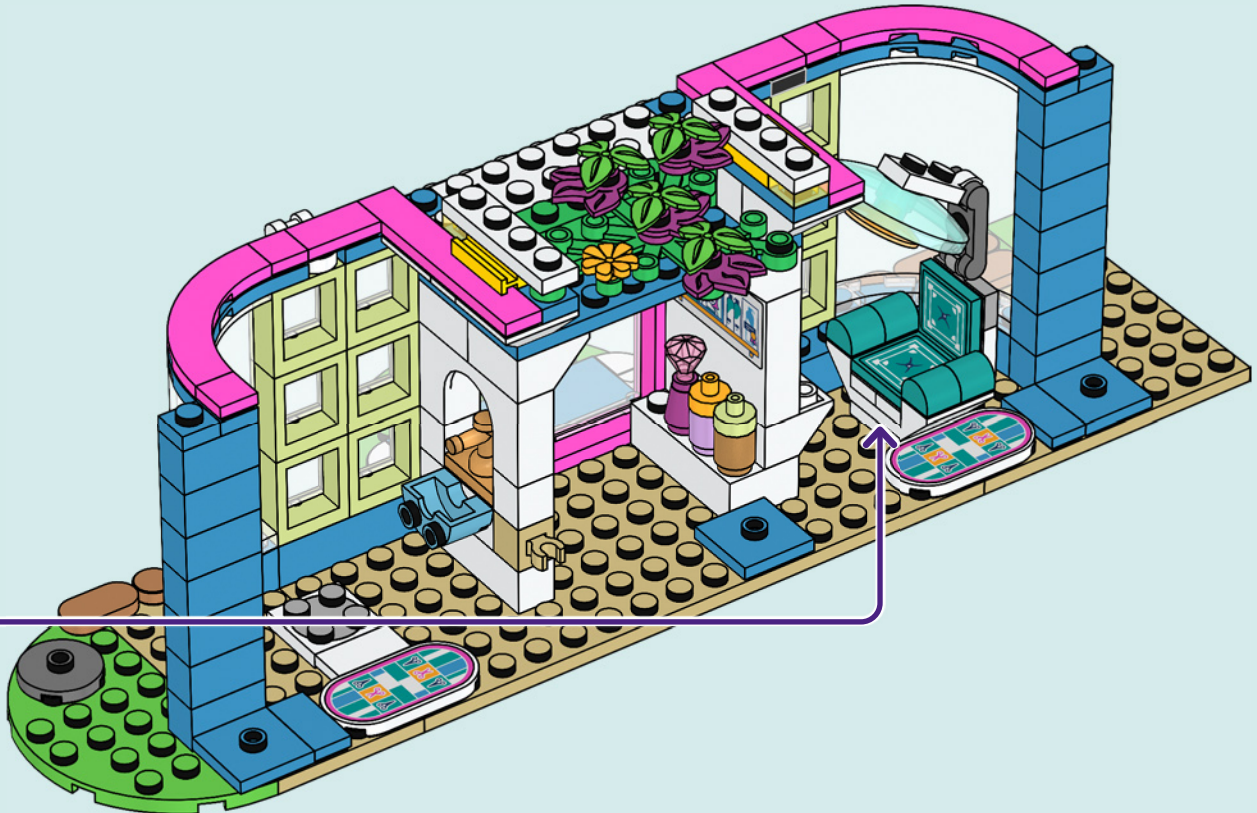

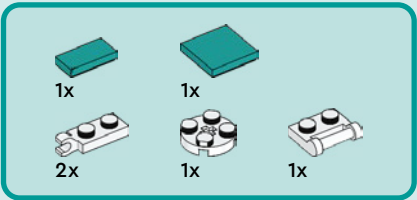

77

1

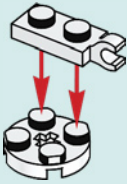

2

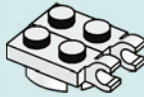

3

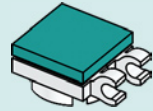

4



5

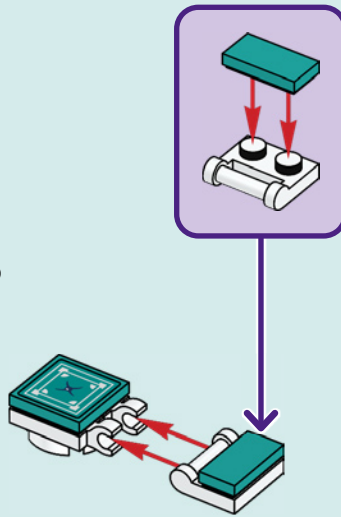

6



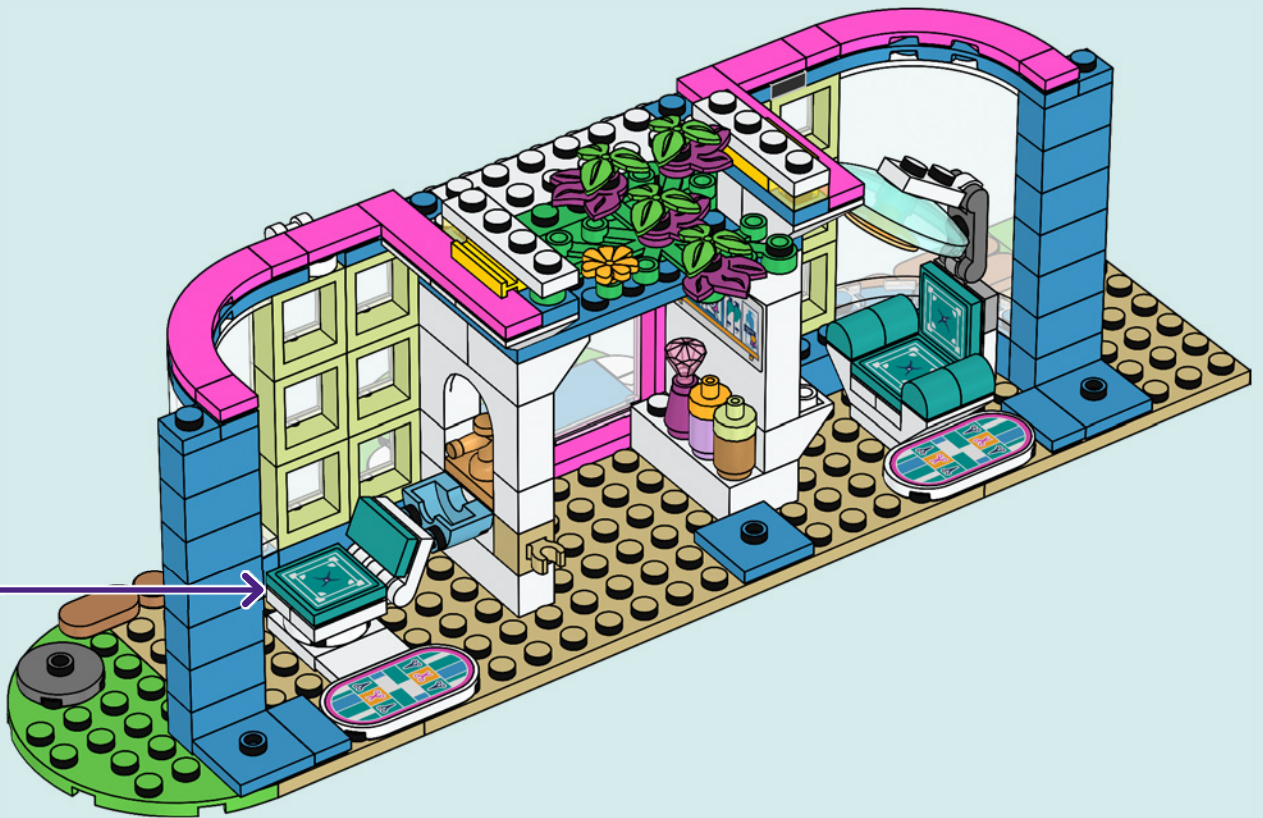



1x

78





6x



1x

79

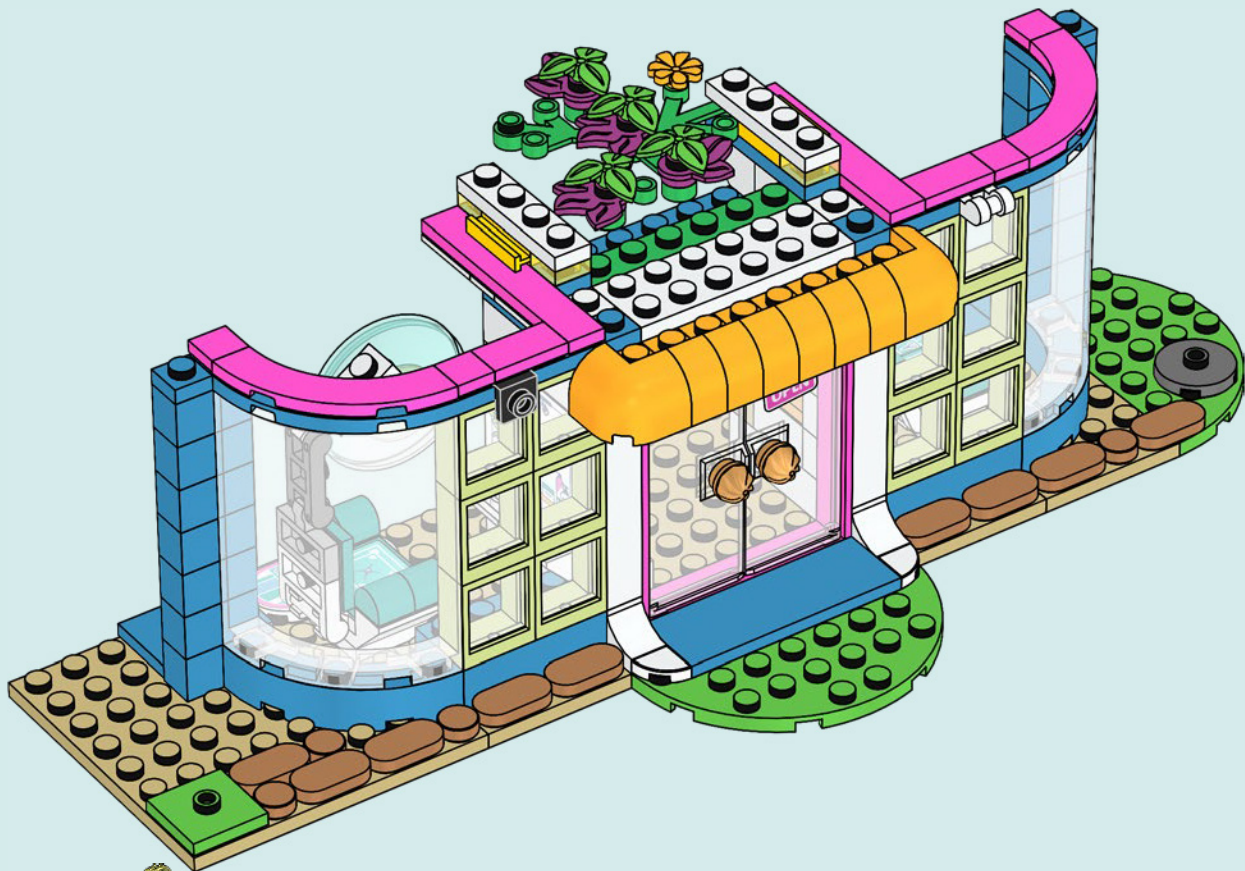

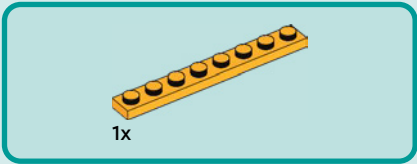

80

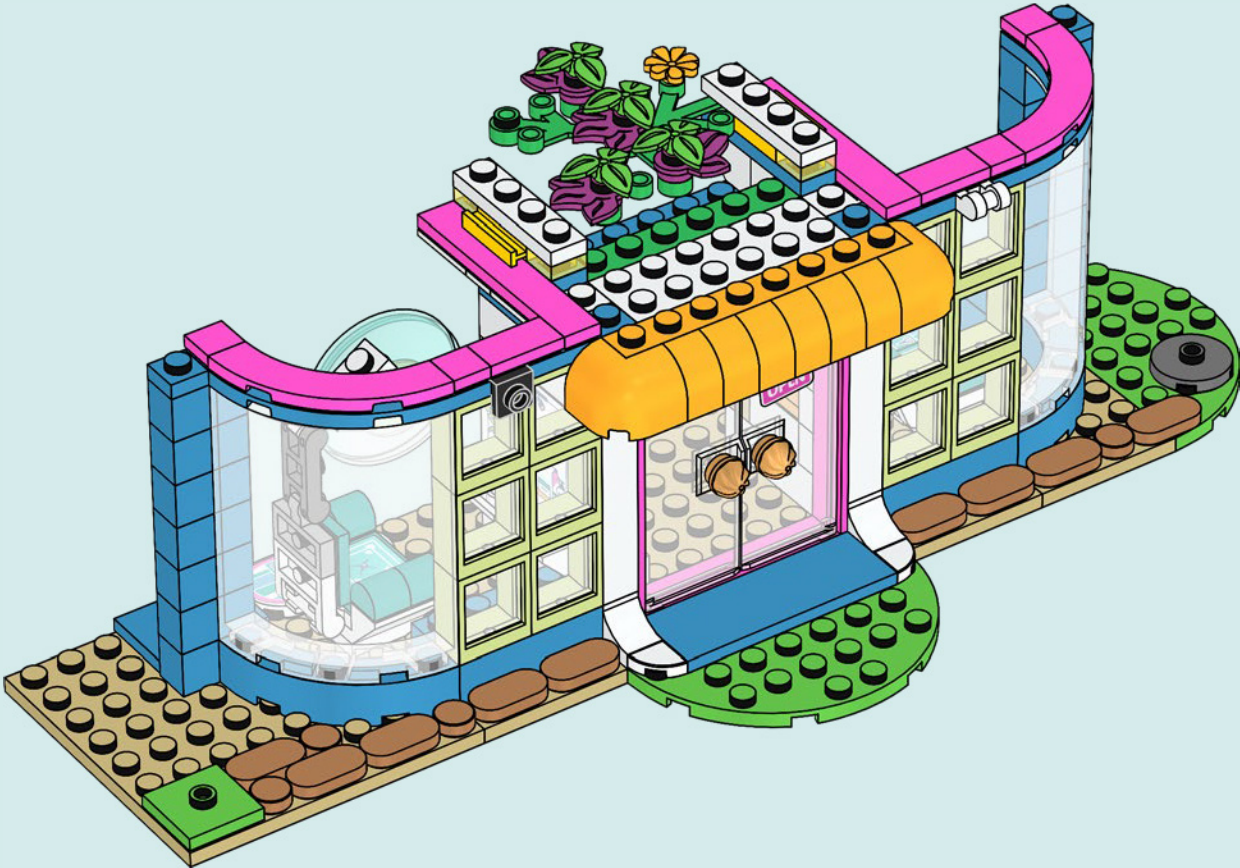



2x

81

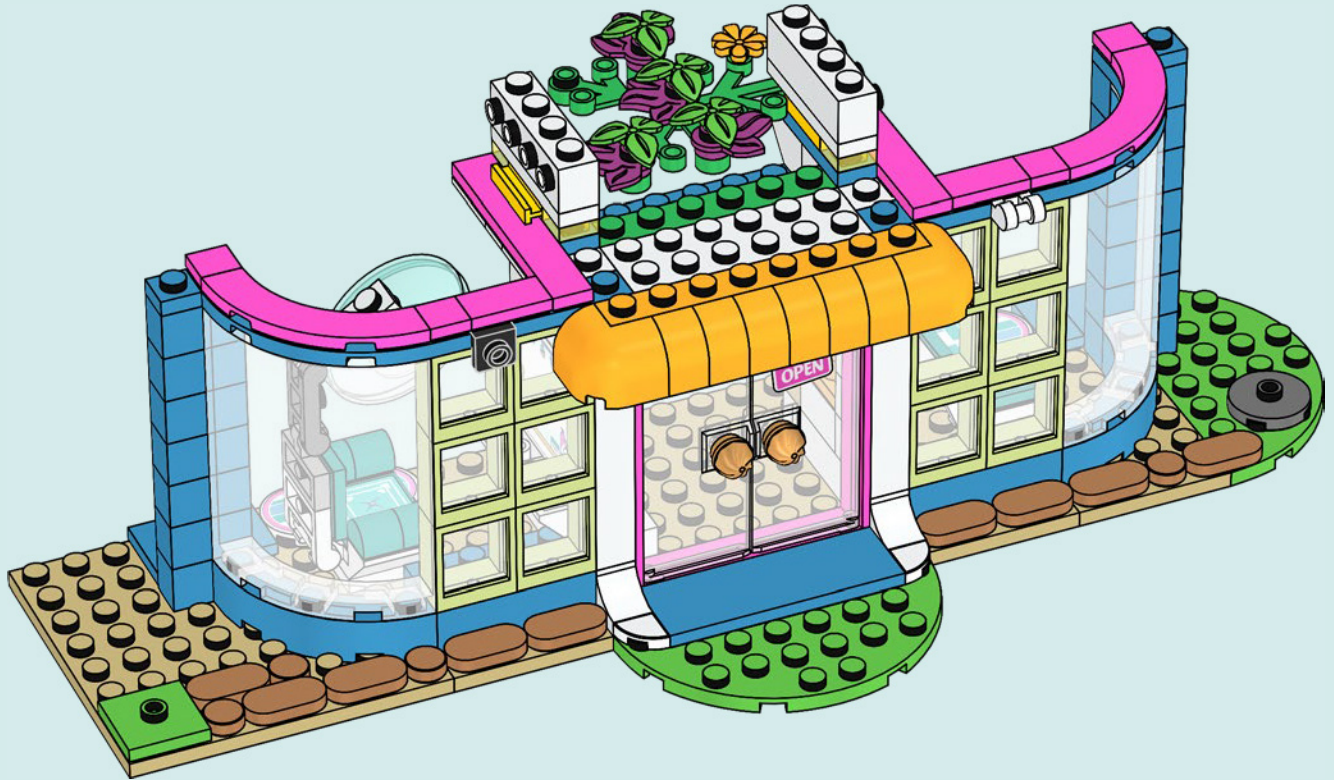



2x

82



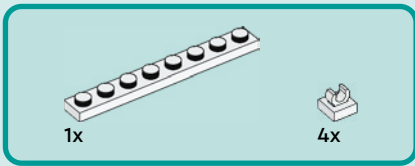

83

1

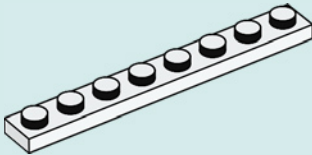

2

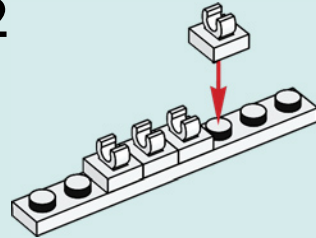

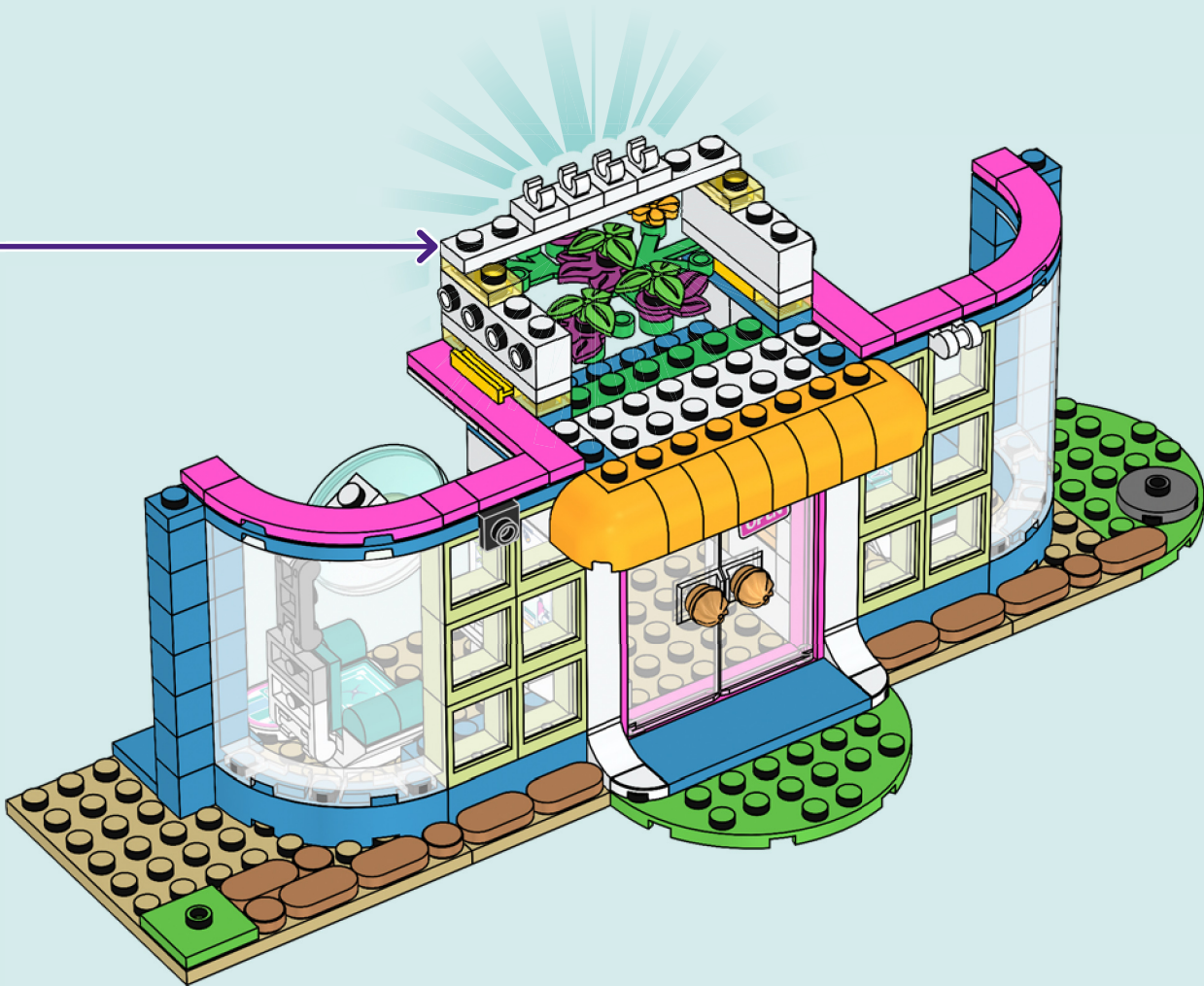



2x

84

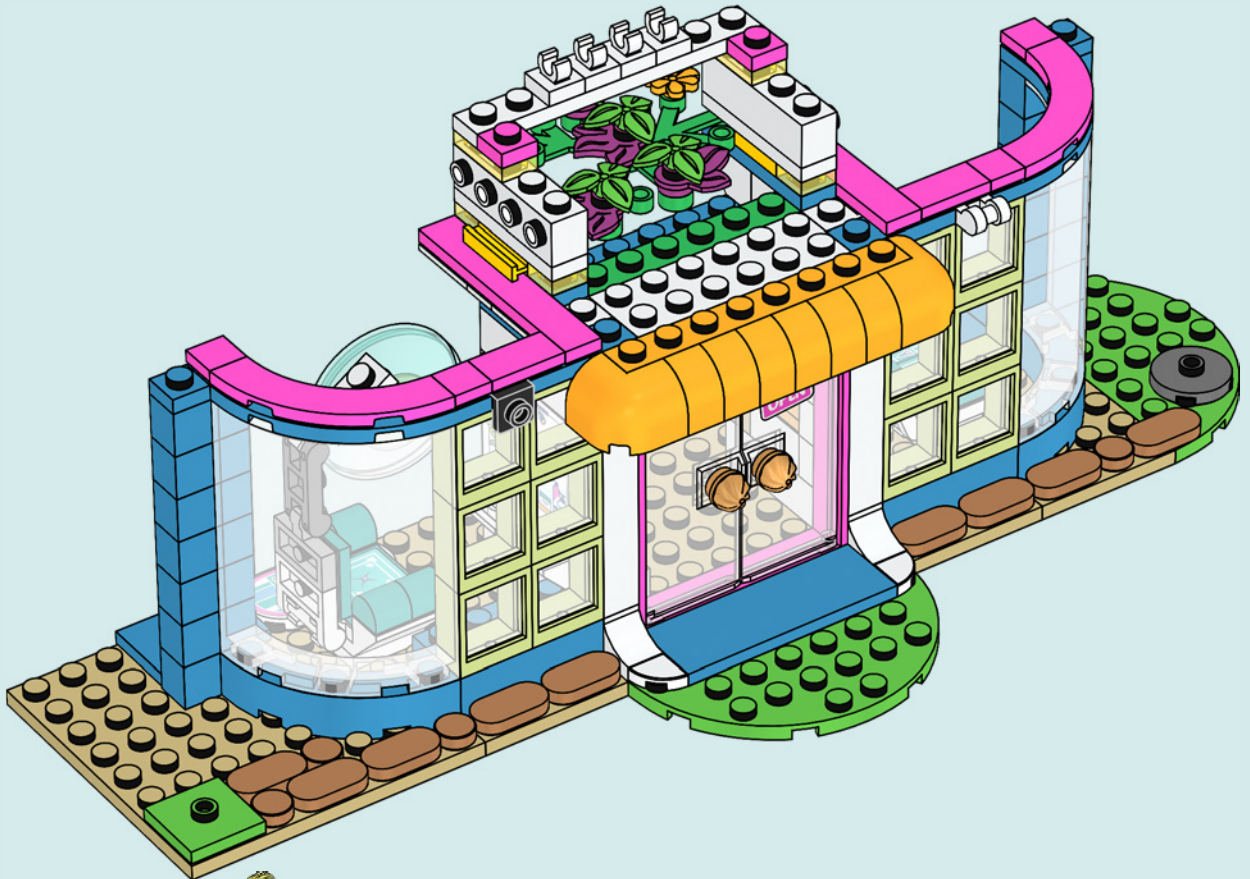

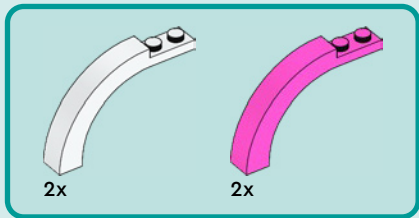

85

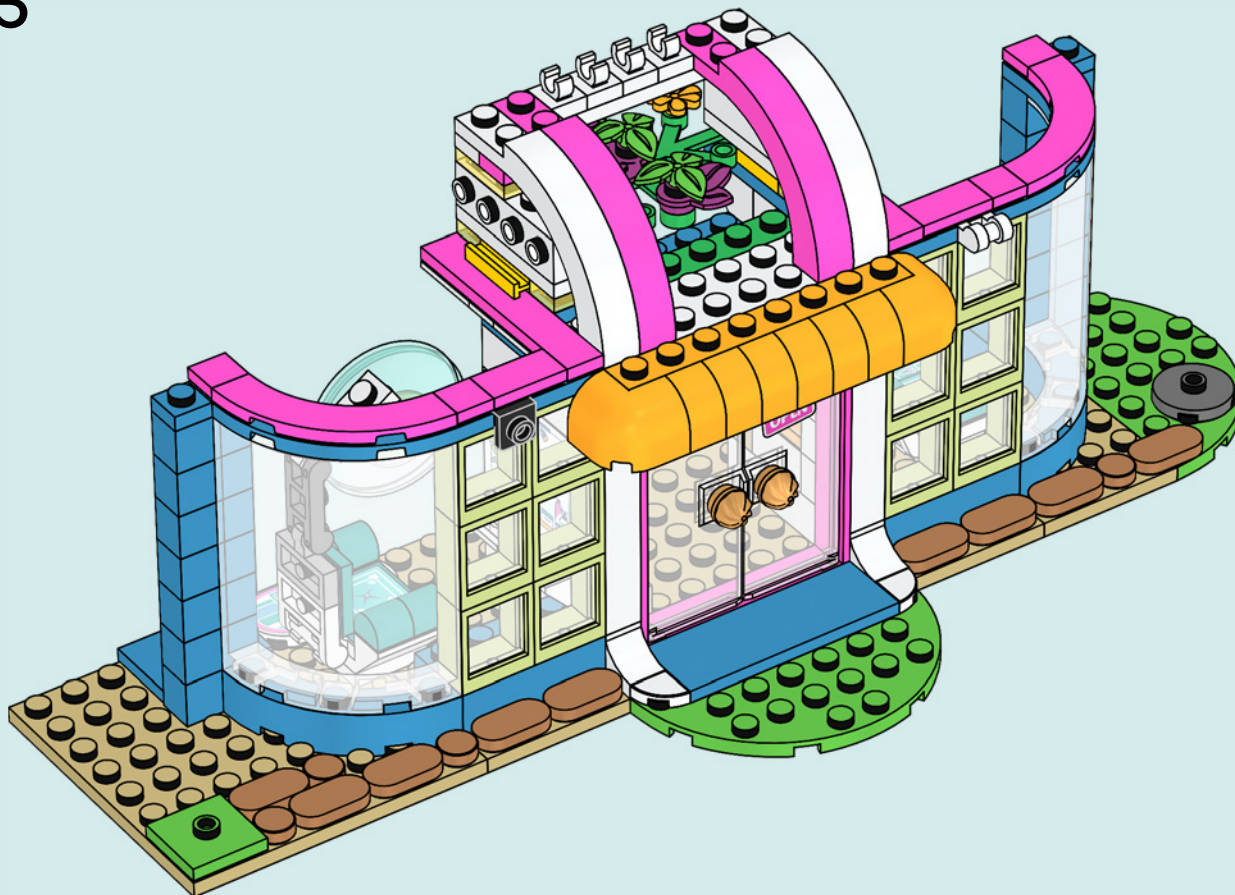



2x



2x

86

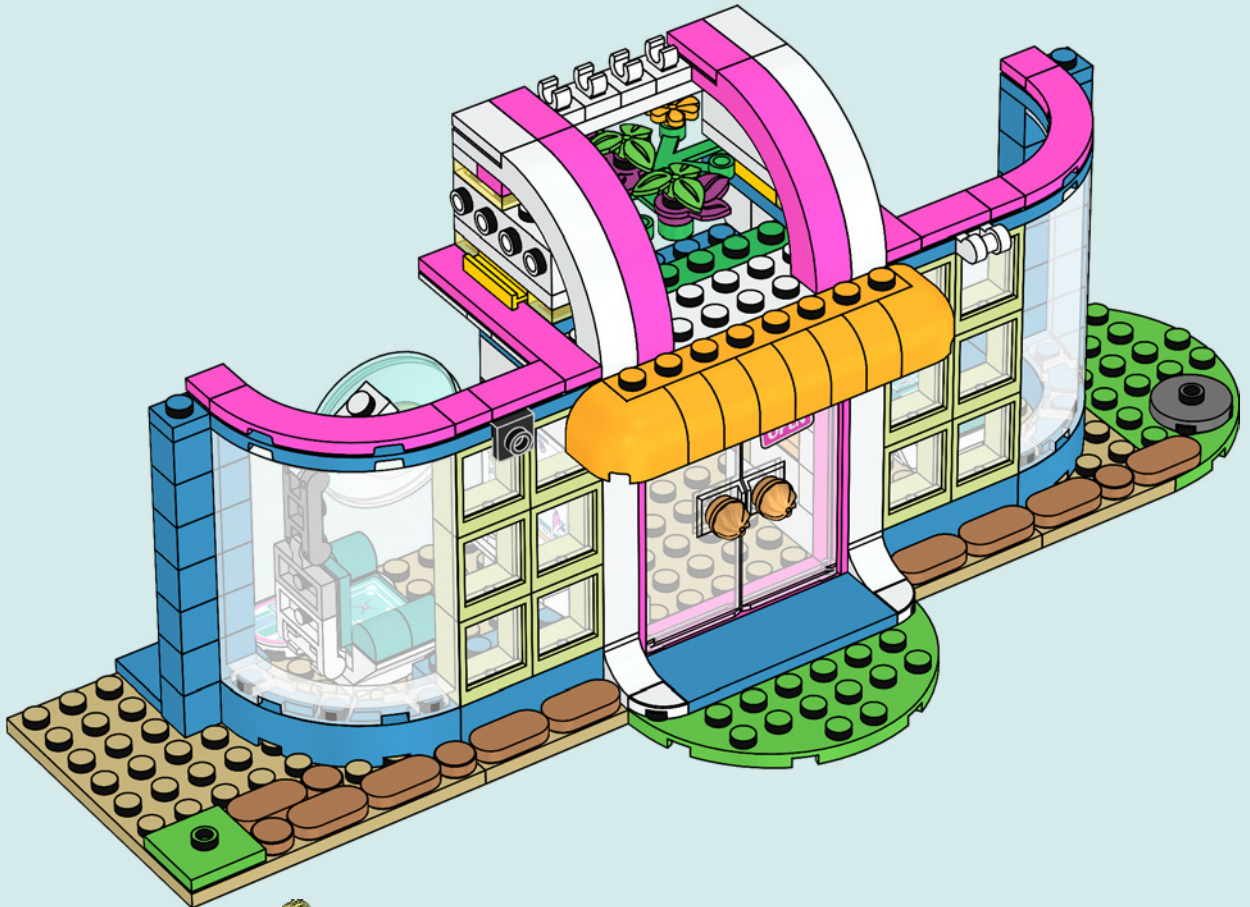



2x



2x

87

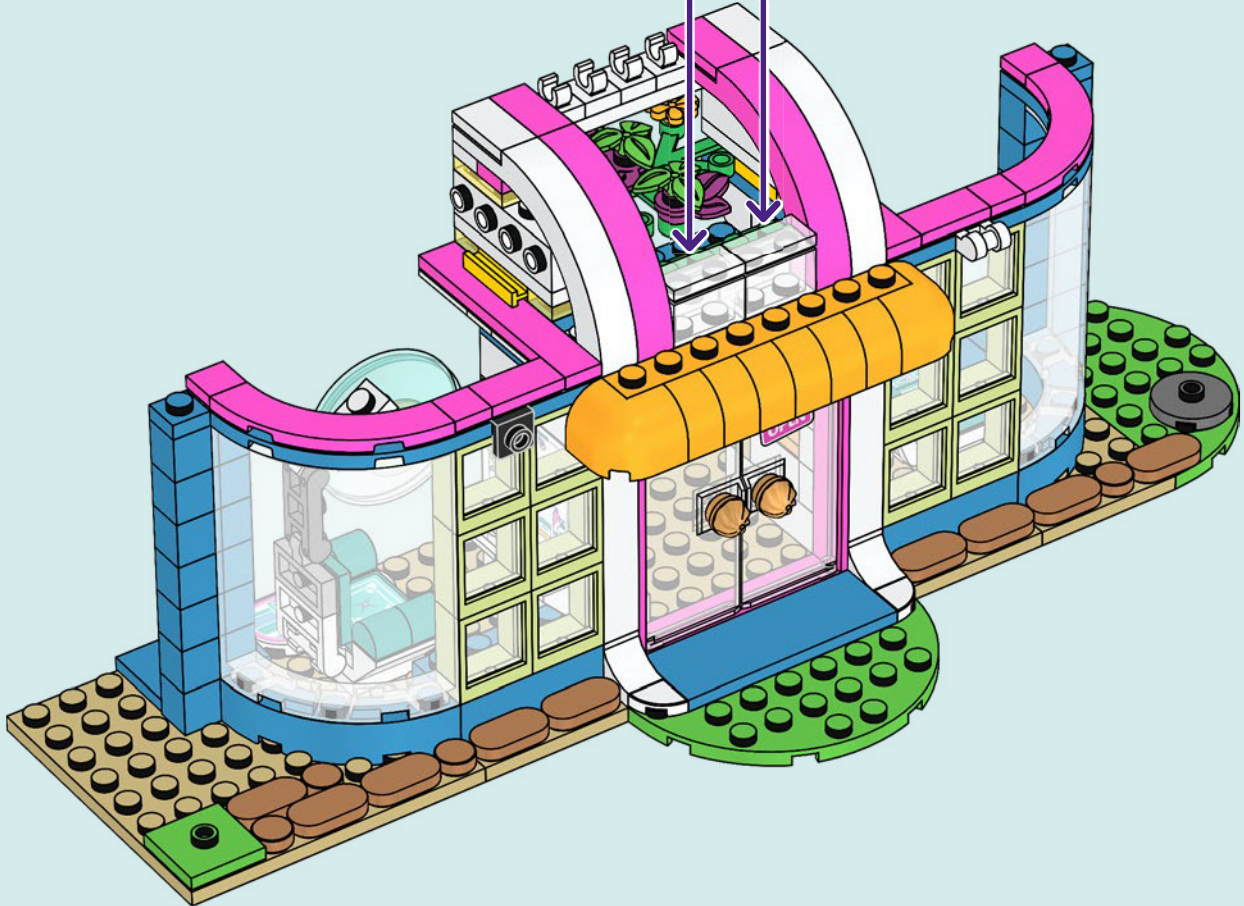
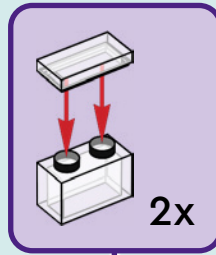



2x

88



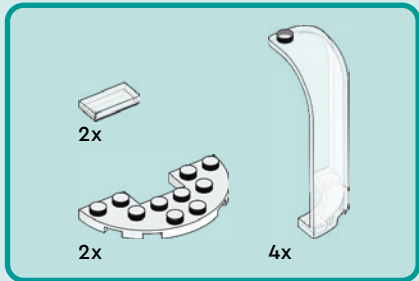

89

1

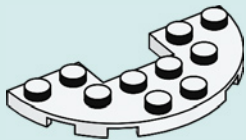

2

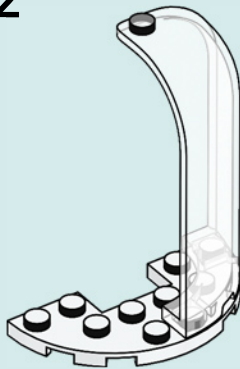

3

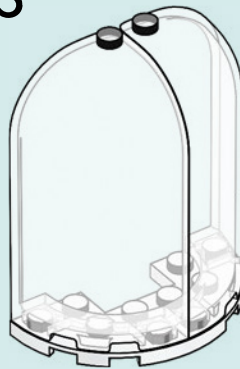

4

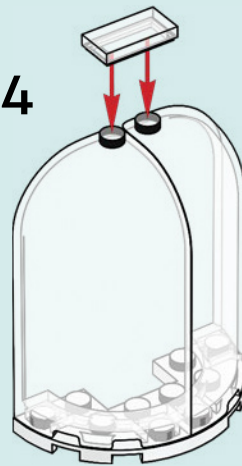

2x

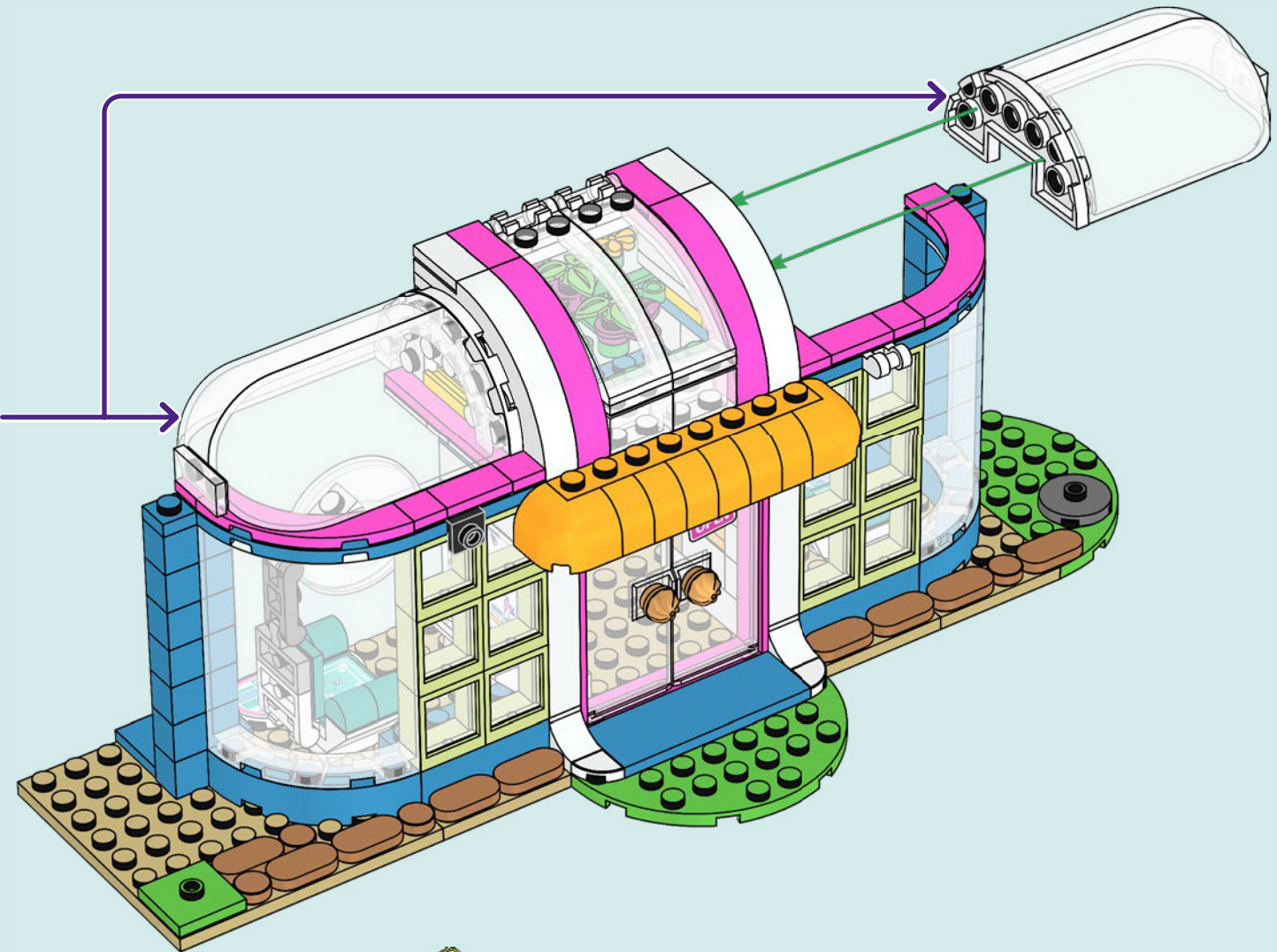



2x

90

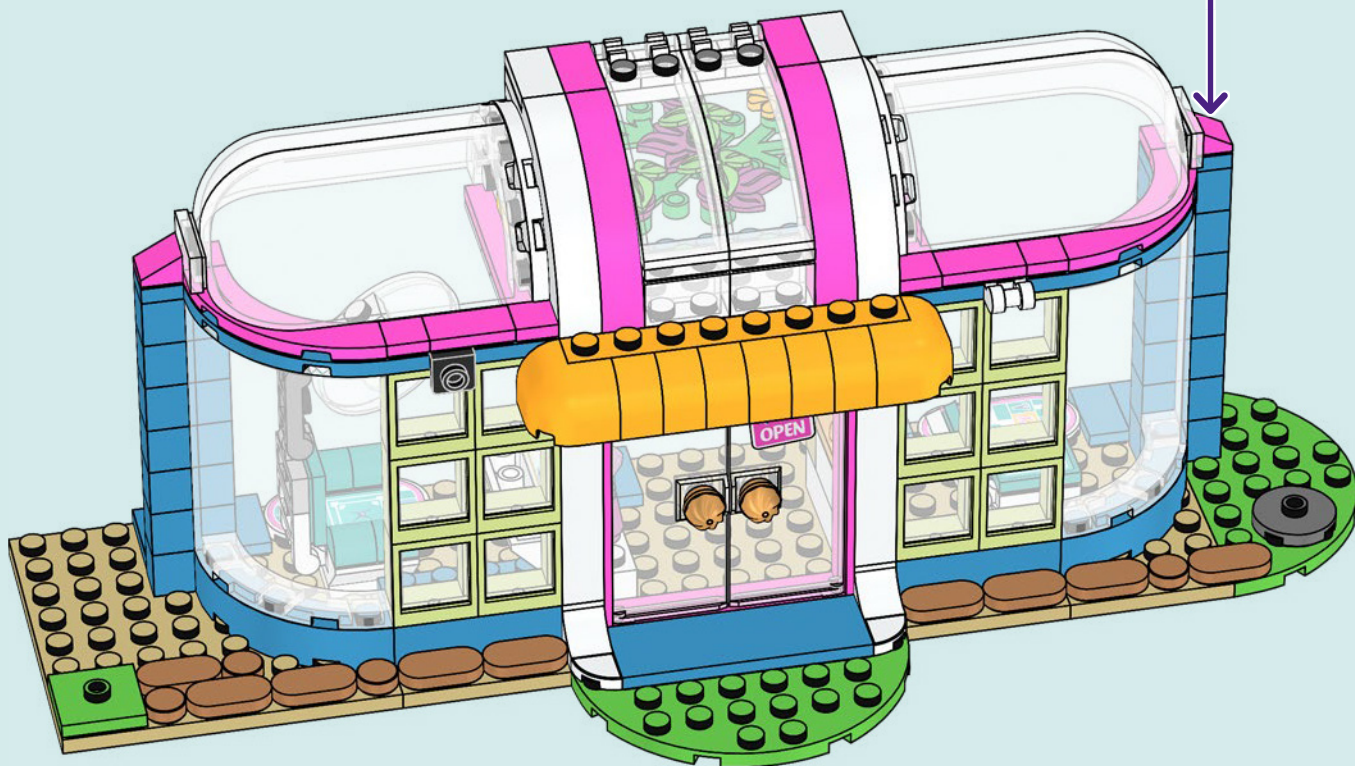



1x



1x

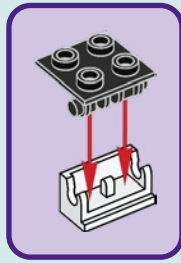

91



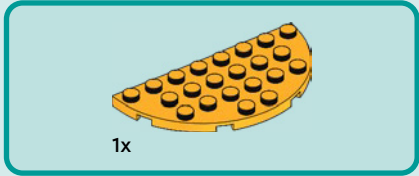

92

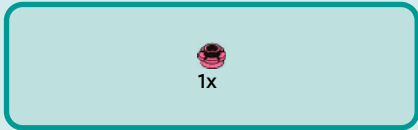
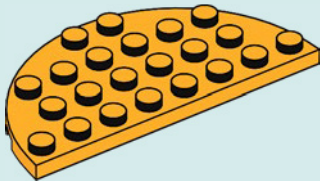

93

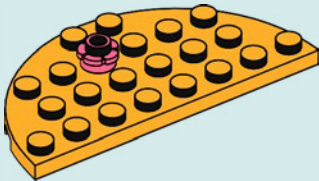



1x



1x

94

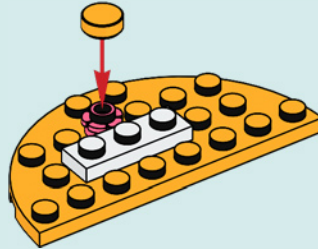

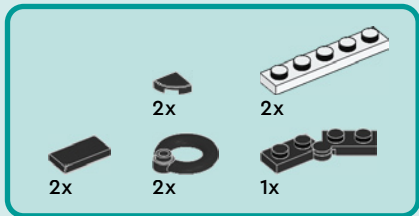

95

1



2

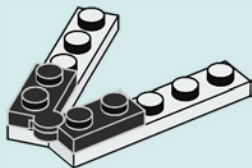

3

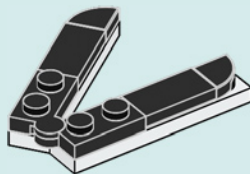

4

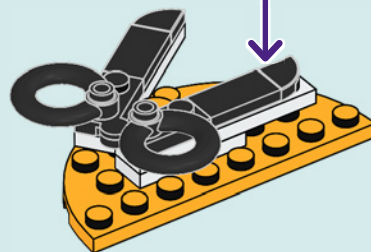

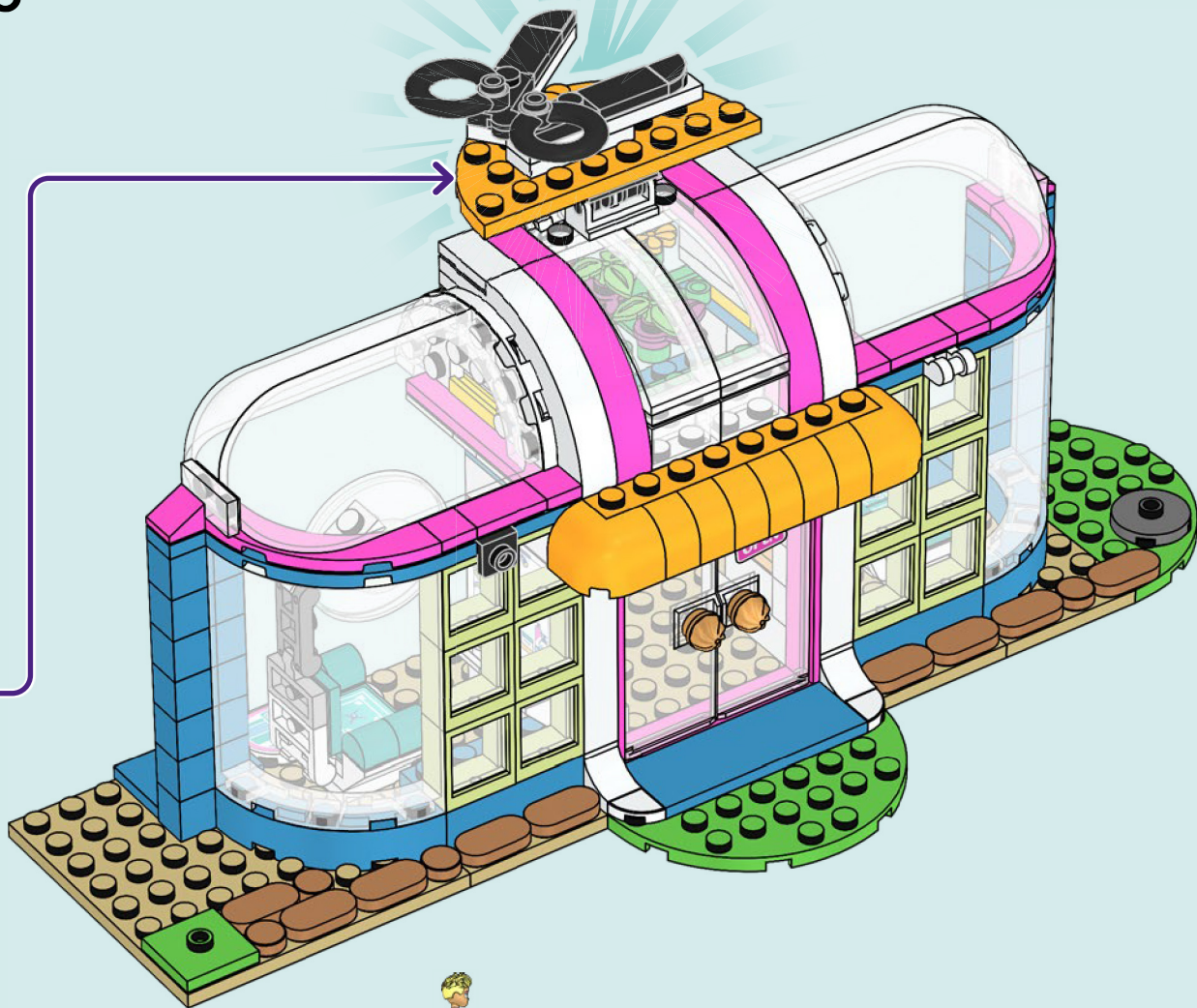





98

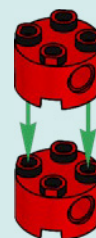



1x

99

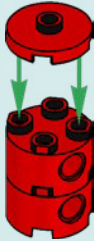

1x

100

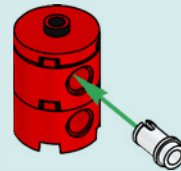



1x



1x

101



1x

102





1x



1x



1x

103



1x

104



105



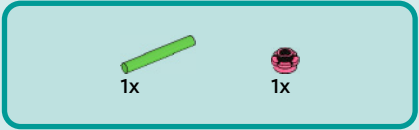

106

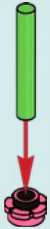

107

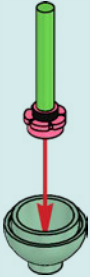



1x

108



1x

109

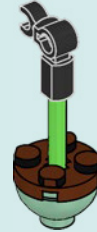



2x



2x

110

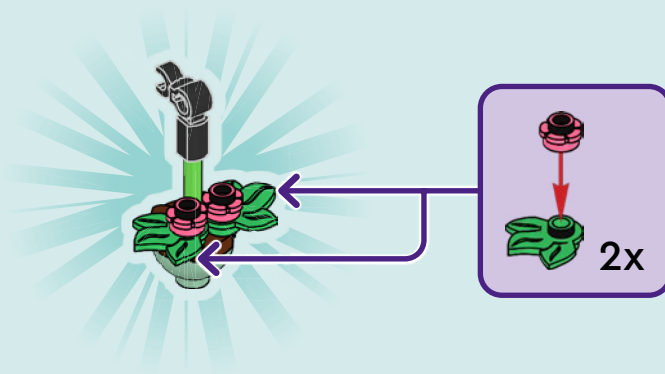

111

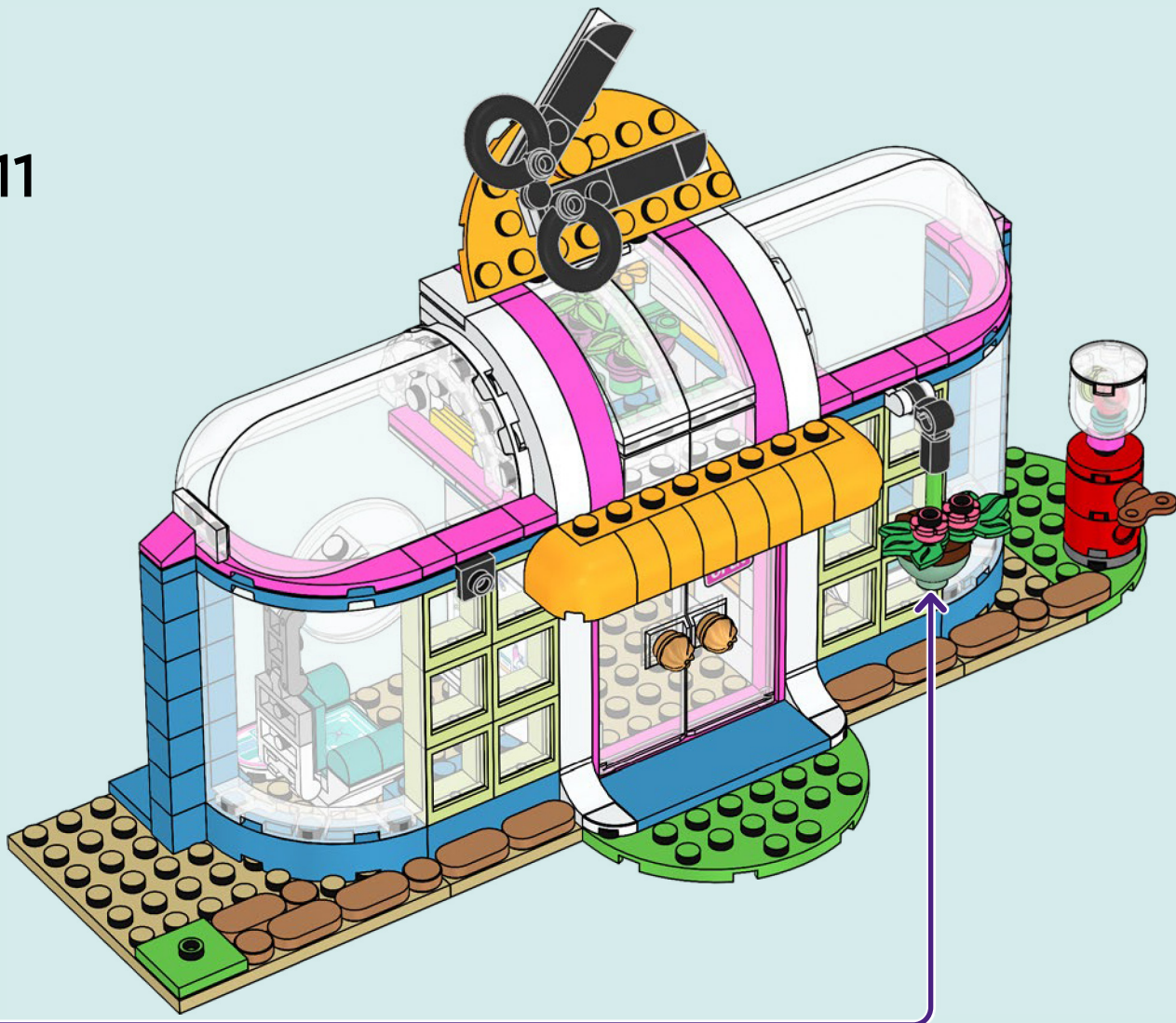



1x

112



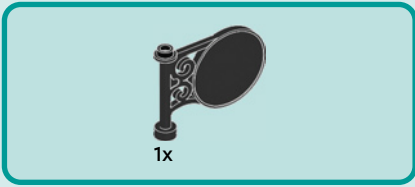

113

1



2

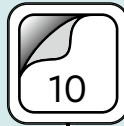

3

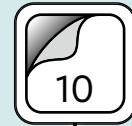
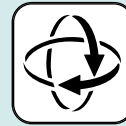

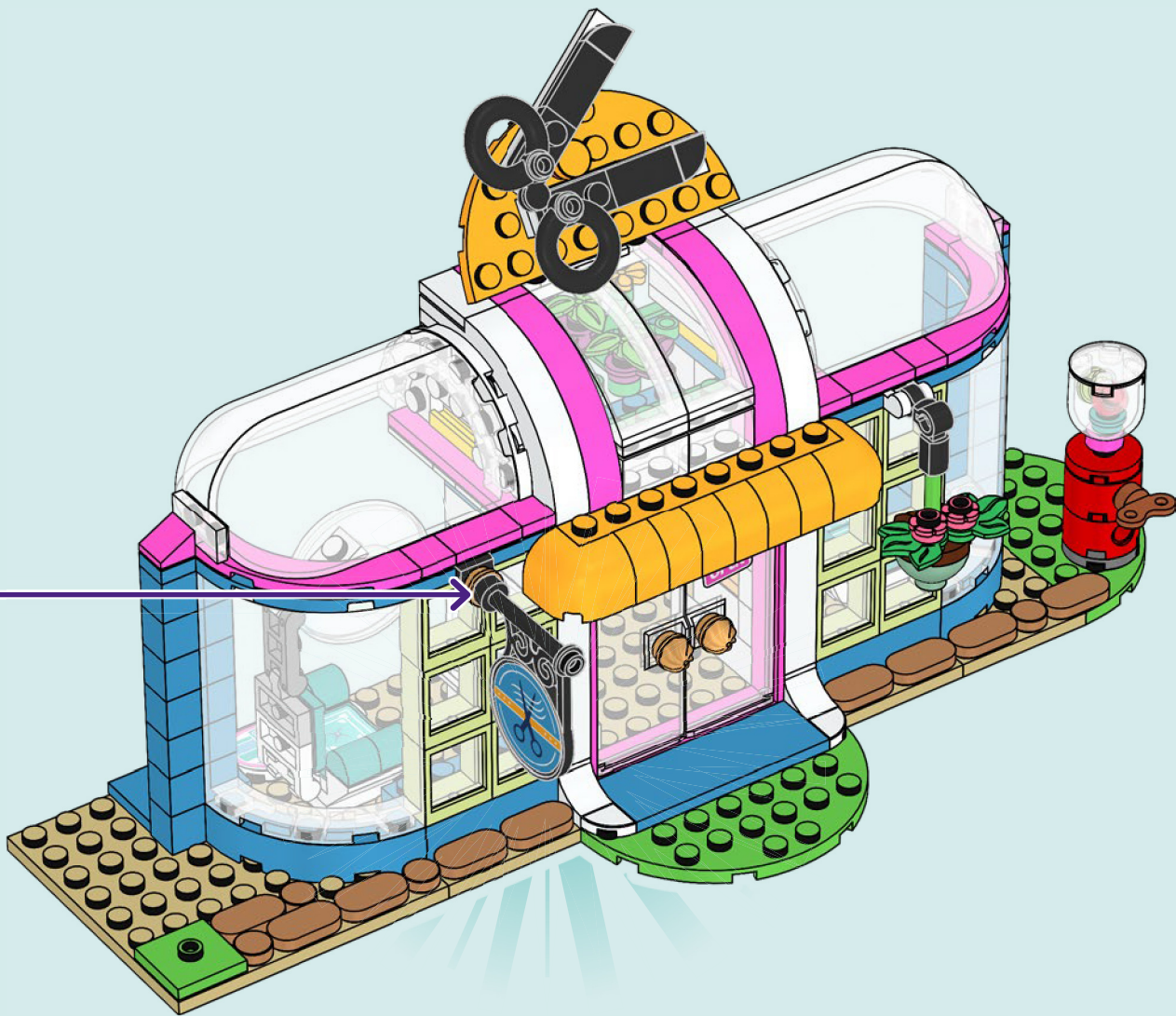

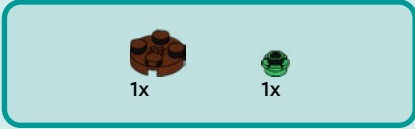

114

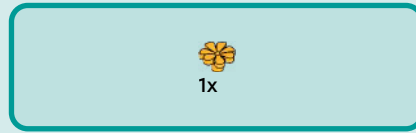
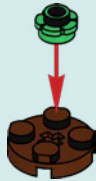

115





2x



2x

116

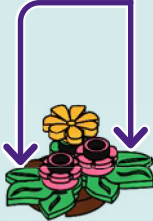
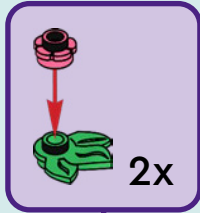

1x

117



118



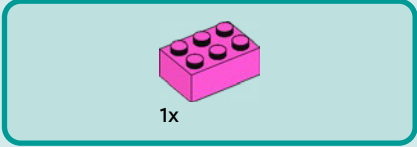
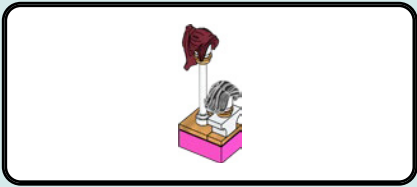

1x

119

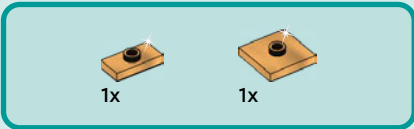
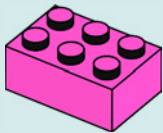

1x

1x

120

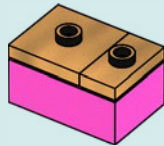



121

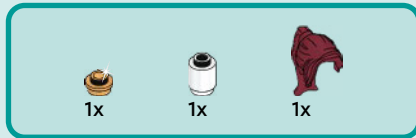
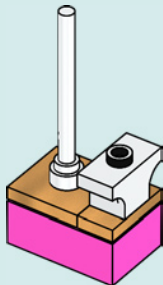

122

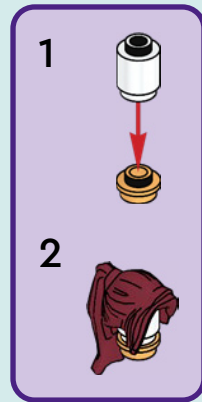



1x



1x



1x

123

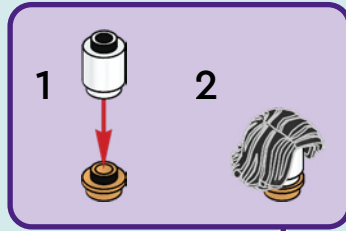

124

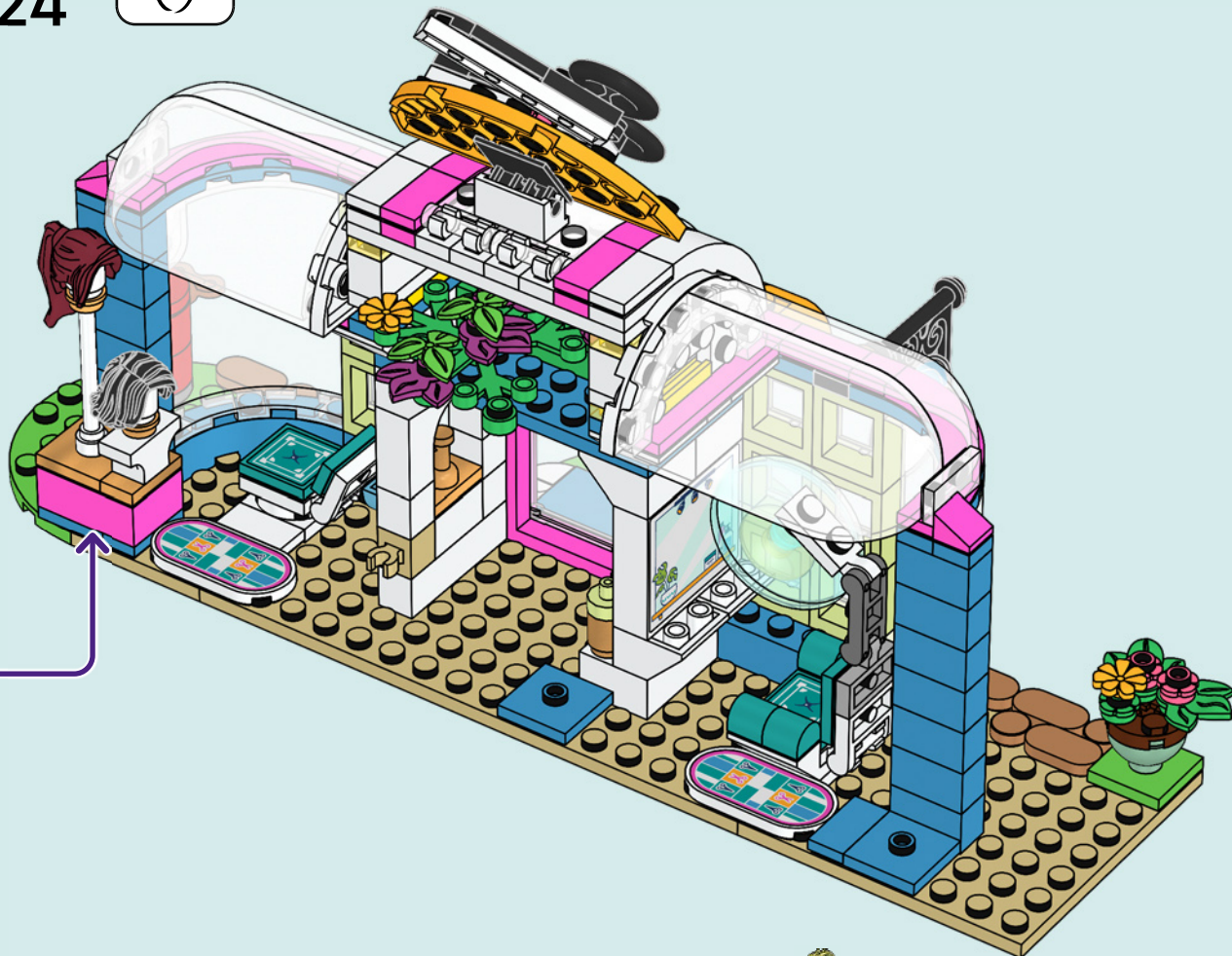



1x

125

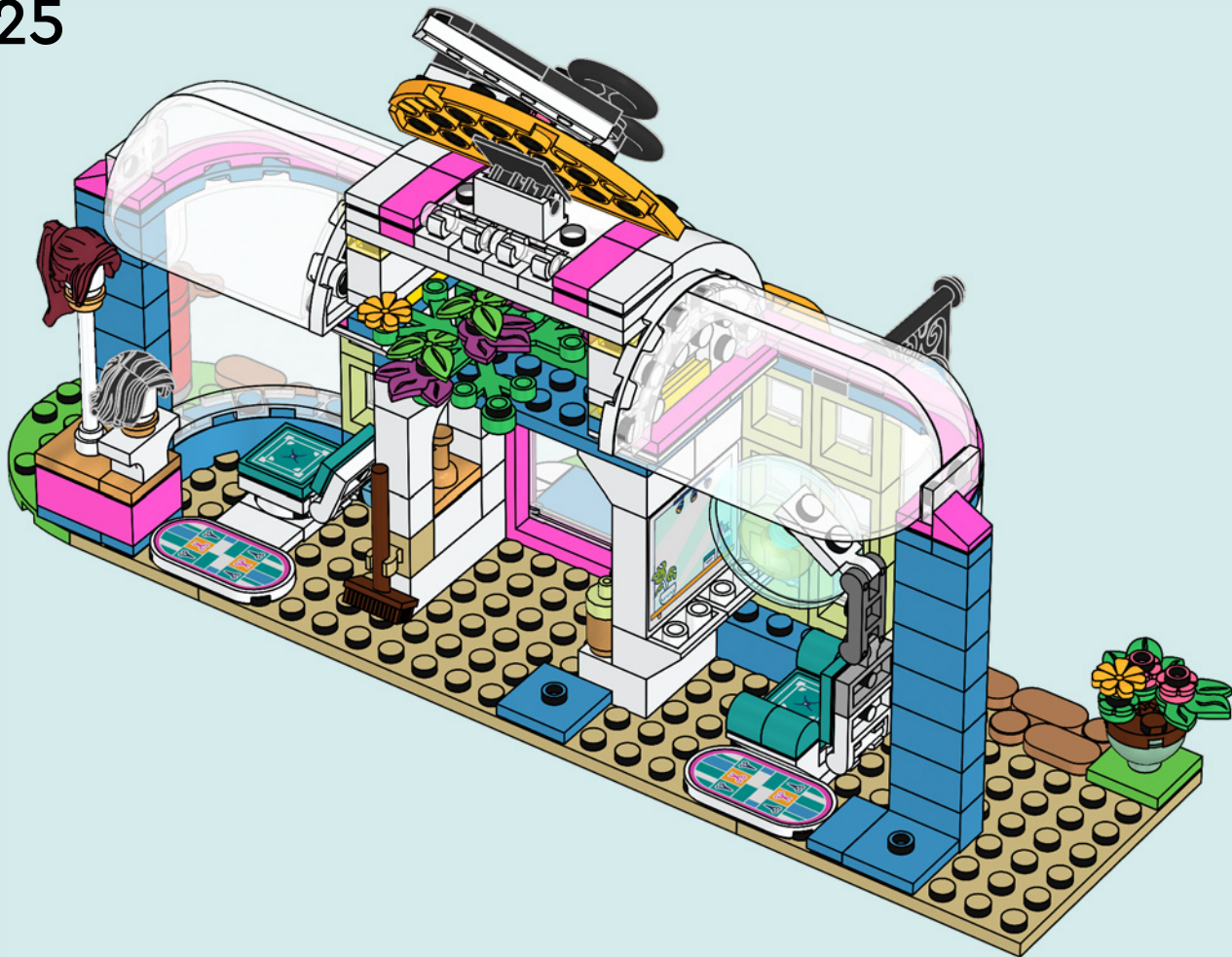

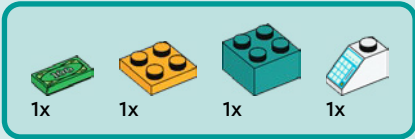

126

1

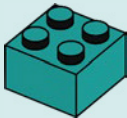

2

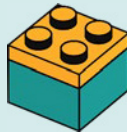

3



4

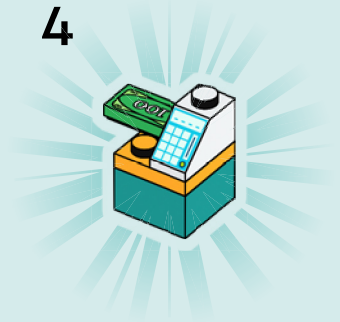

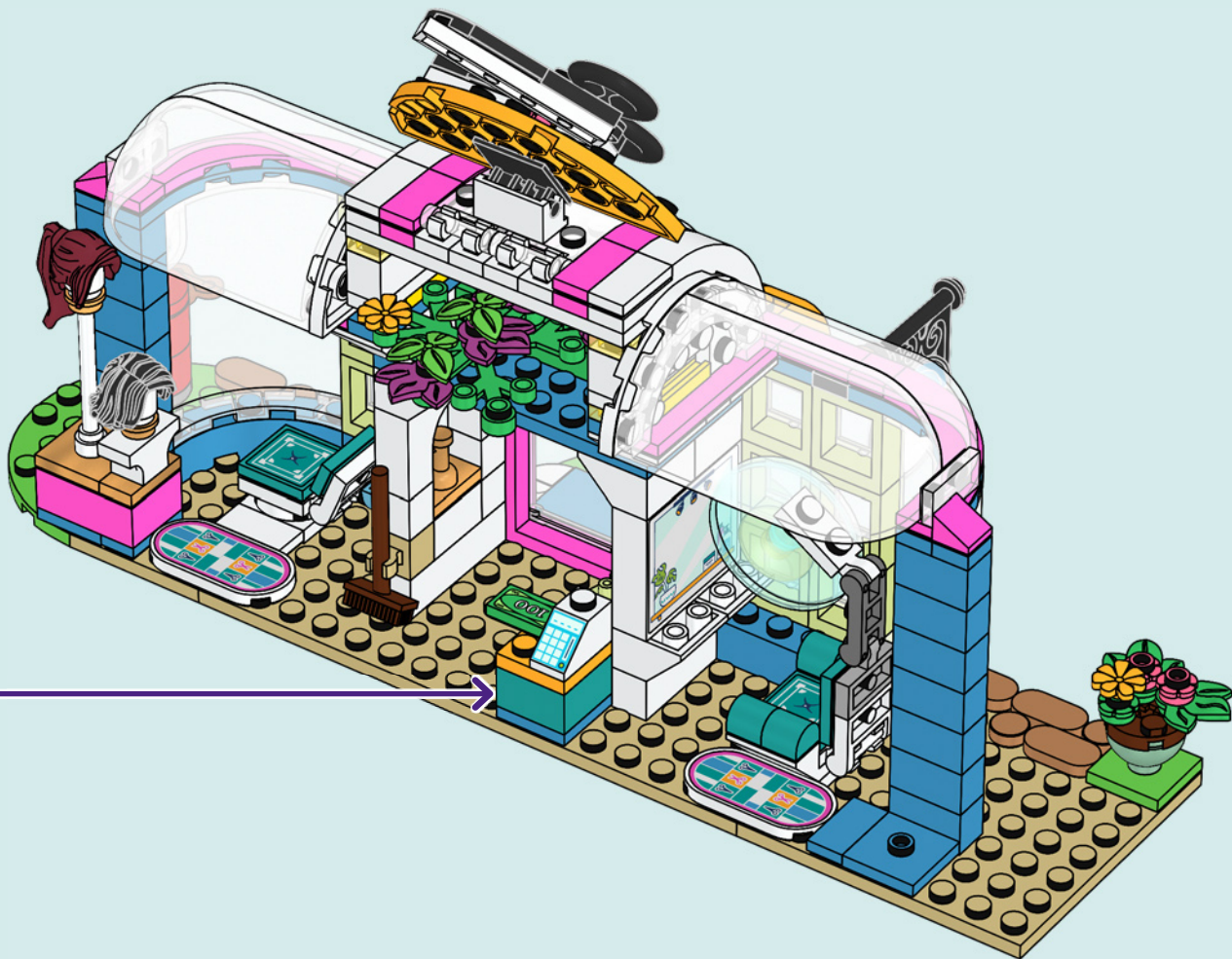



1x



1x

127

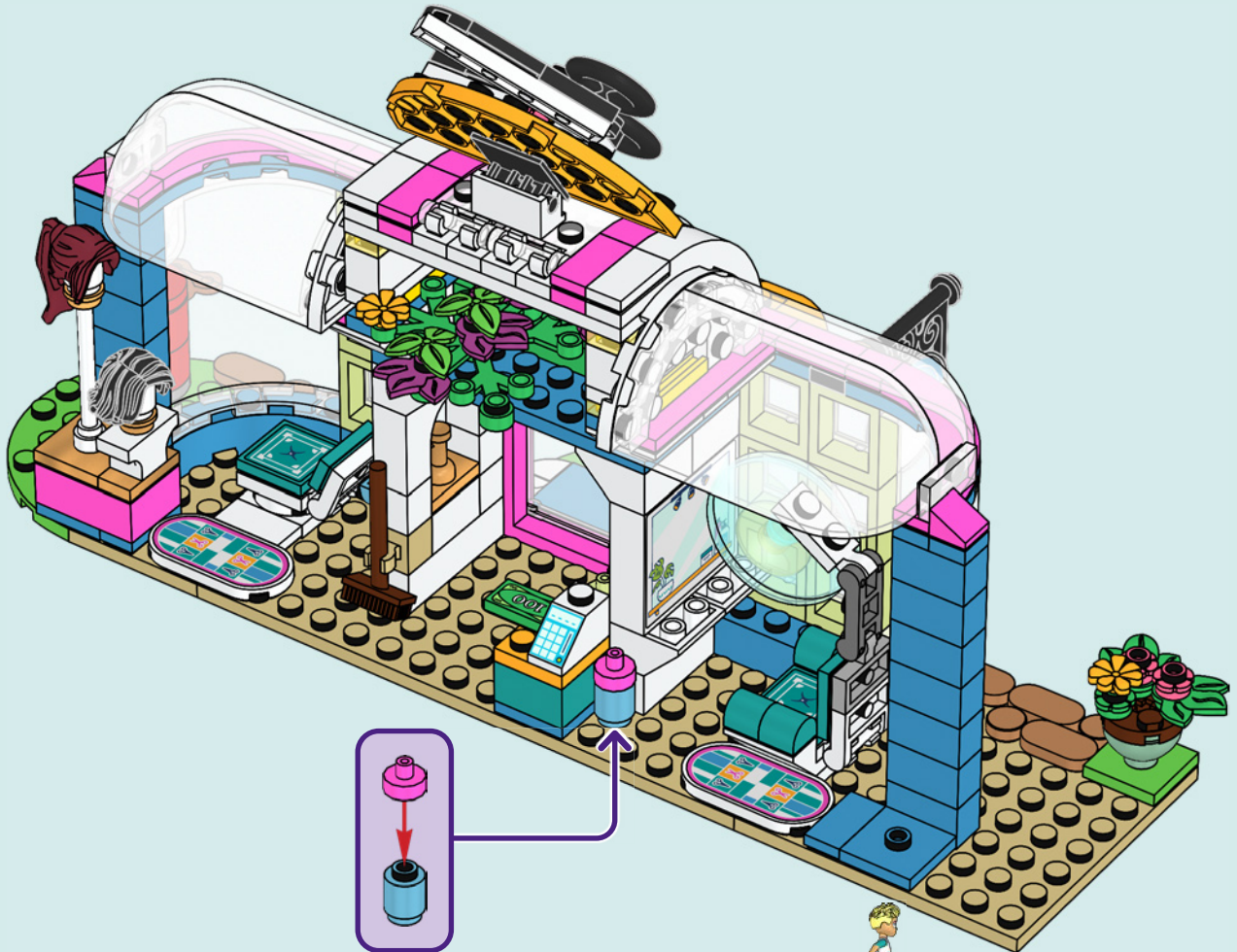

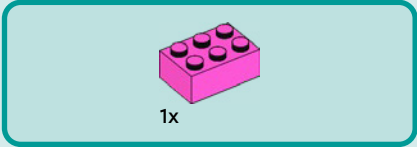
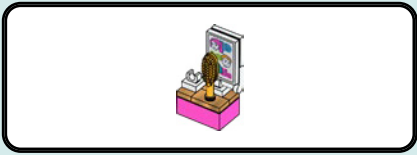

128

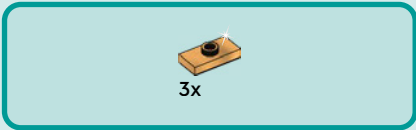
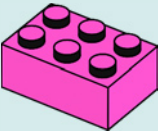

129

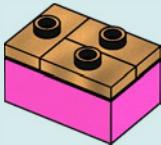



2x

130

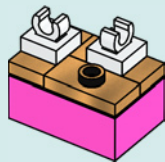

1x



1x

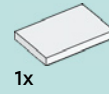

1x

131

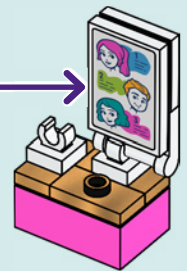
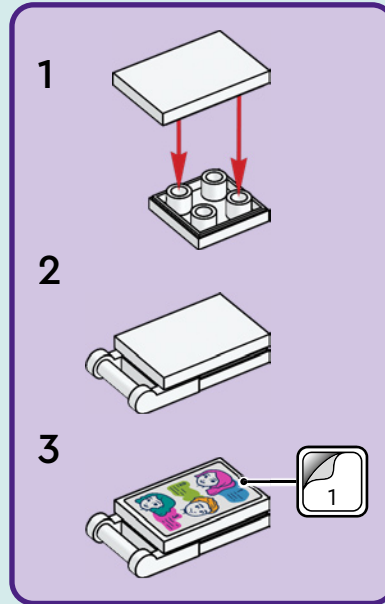



1x

132



133

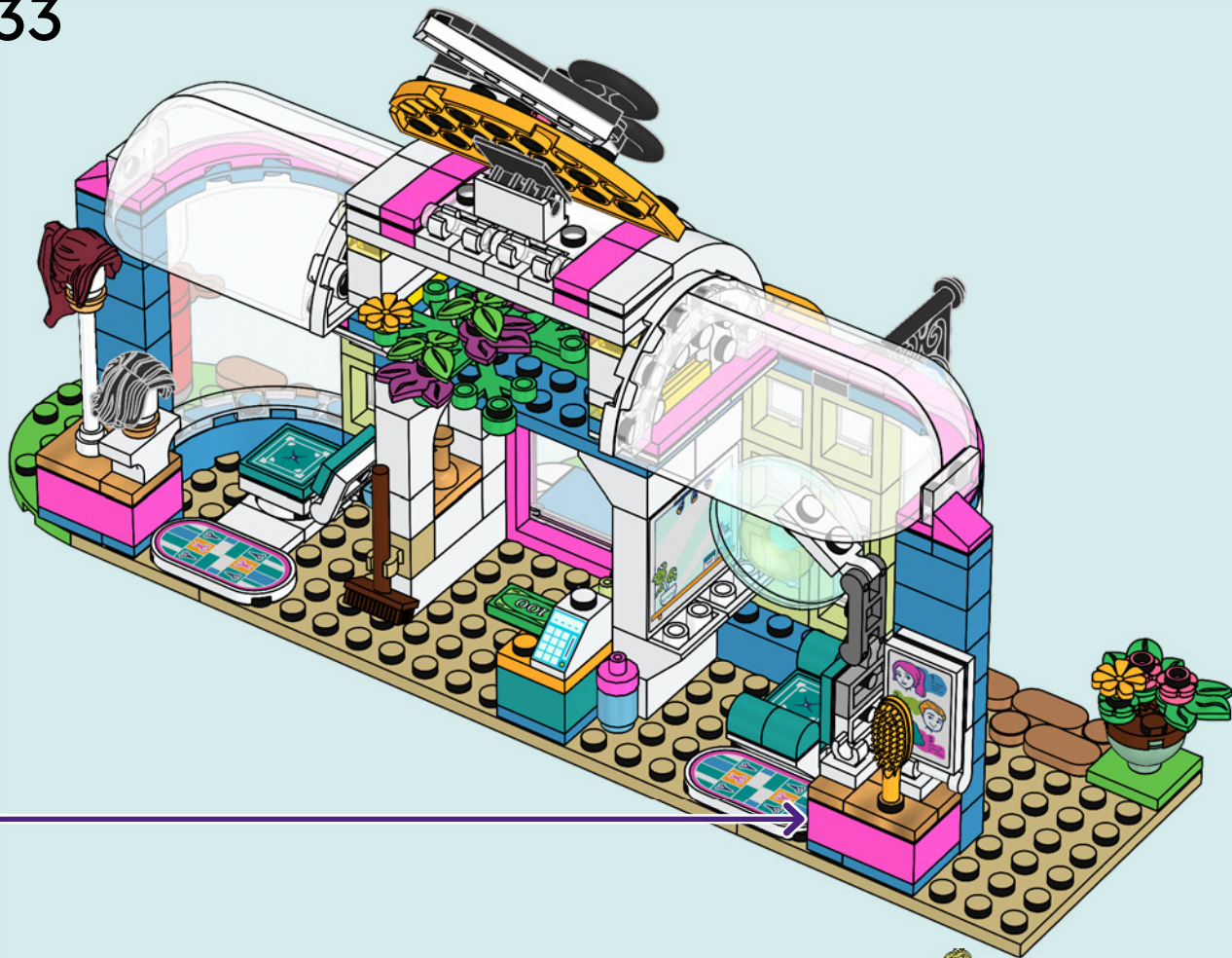

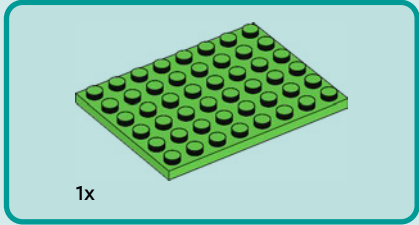
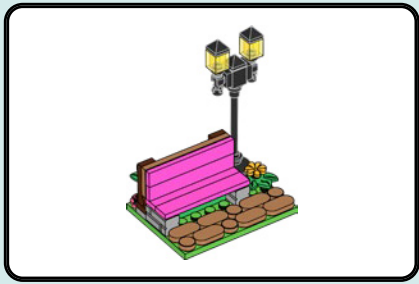

1

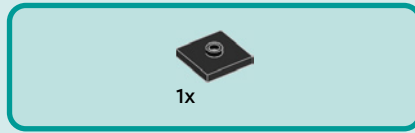
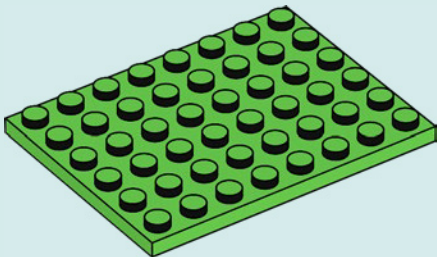

2

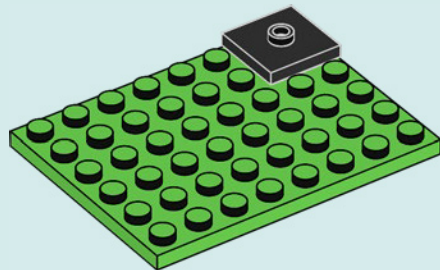

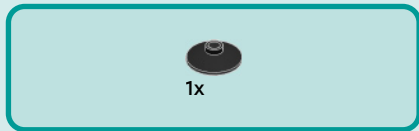

3

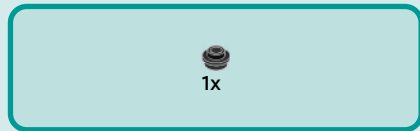
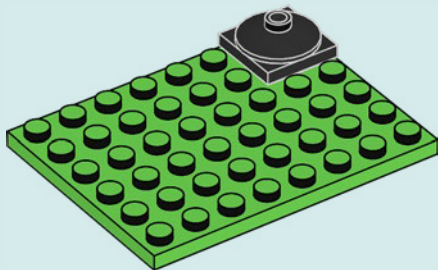

4

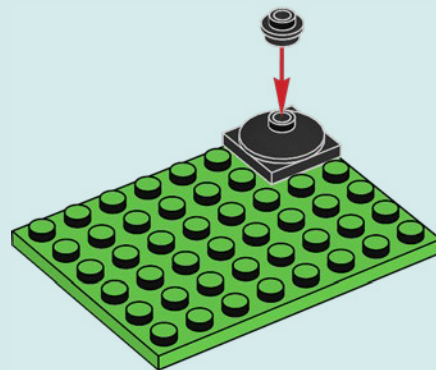



1x

5

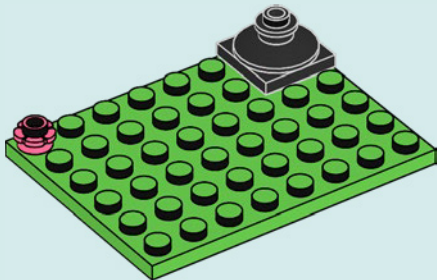

1x

6

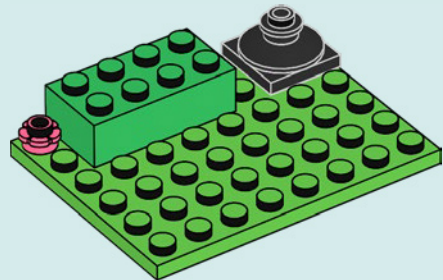



7

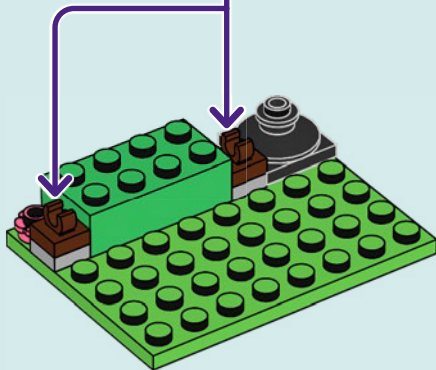
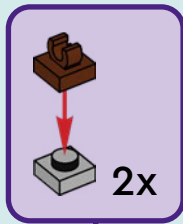

8

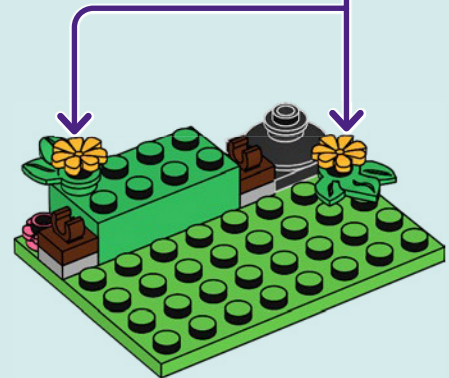
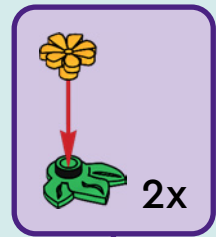

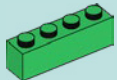

1x

9

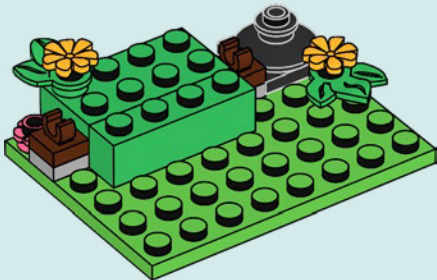

2x

10

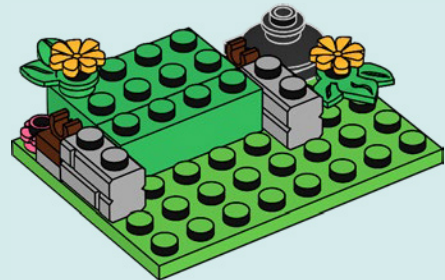

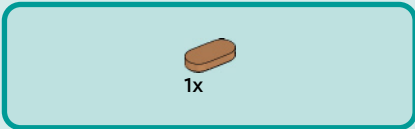

11

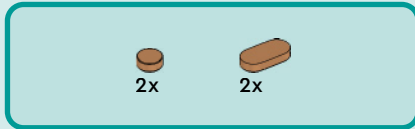
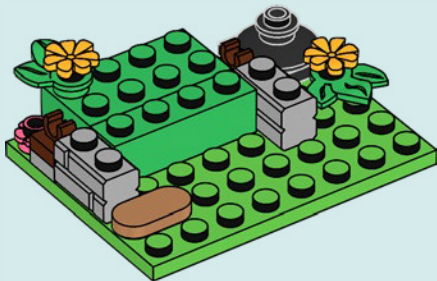

12

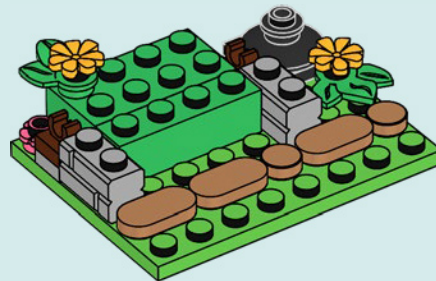

2x



3x

13

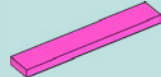
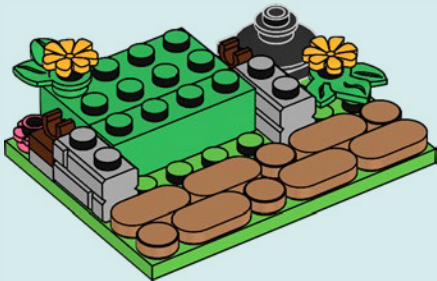

2x

14

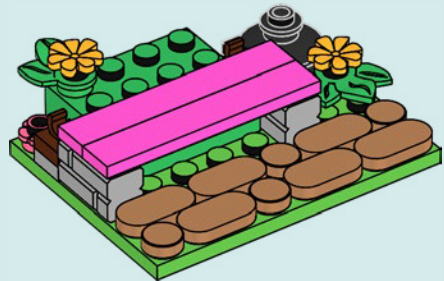

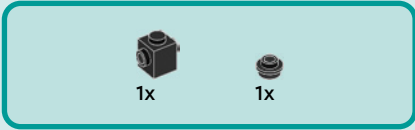
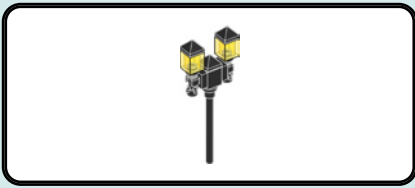

15

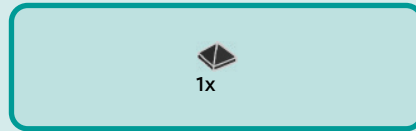
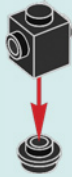

16





2x

17

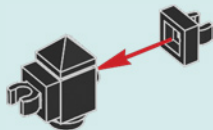

2x



2x



2x

18

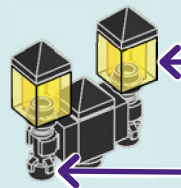

1



2



2x

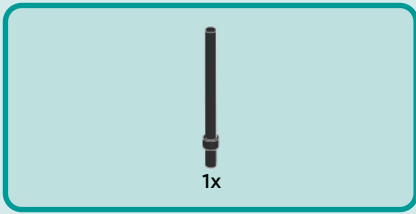

19

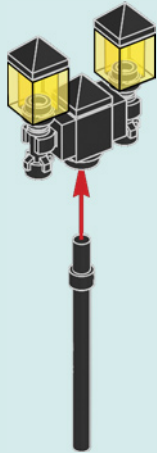

20

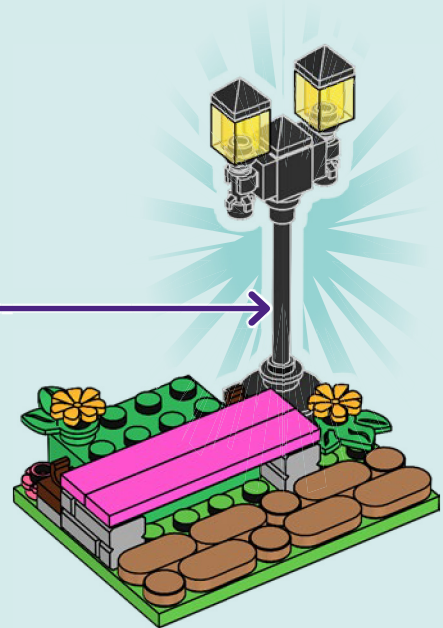

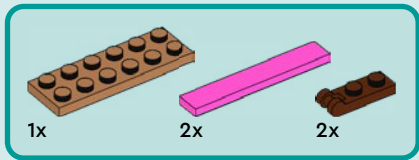

21

1

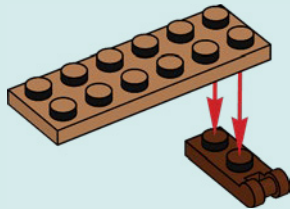

2

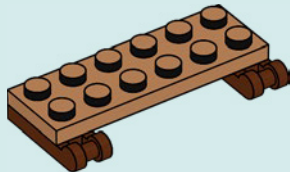

3

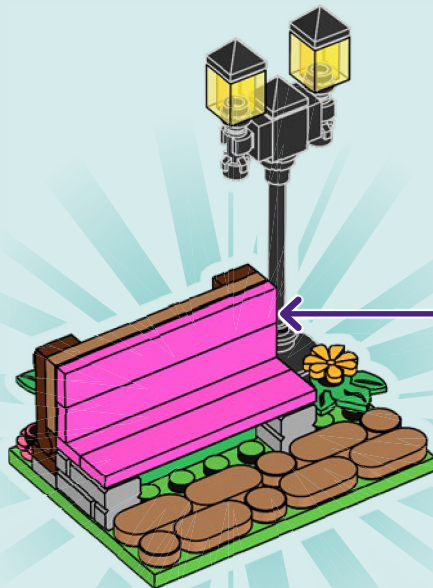
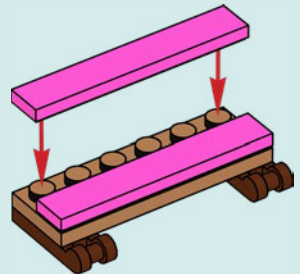



1

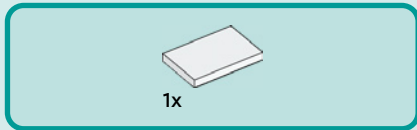

2

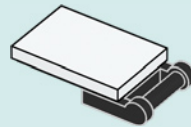



2x

3



4

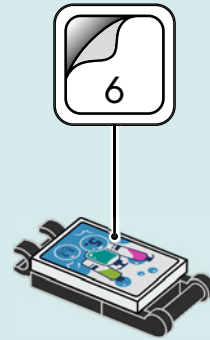

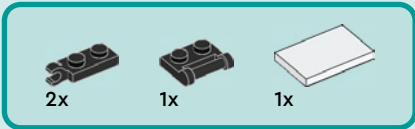

5

1



2

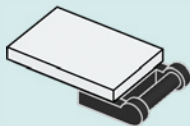

3



4

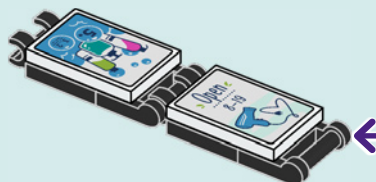
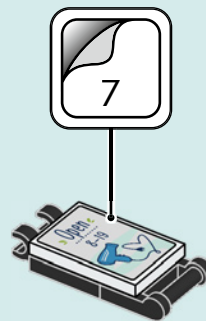

6





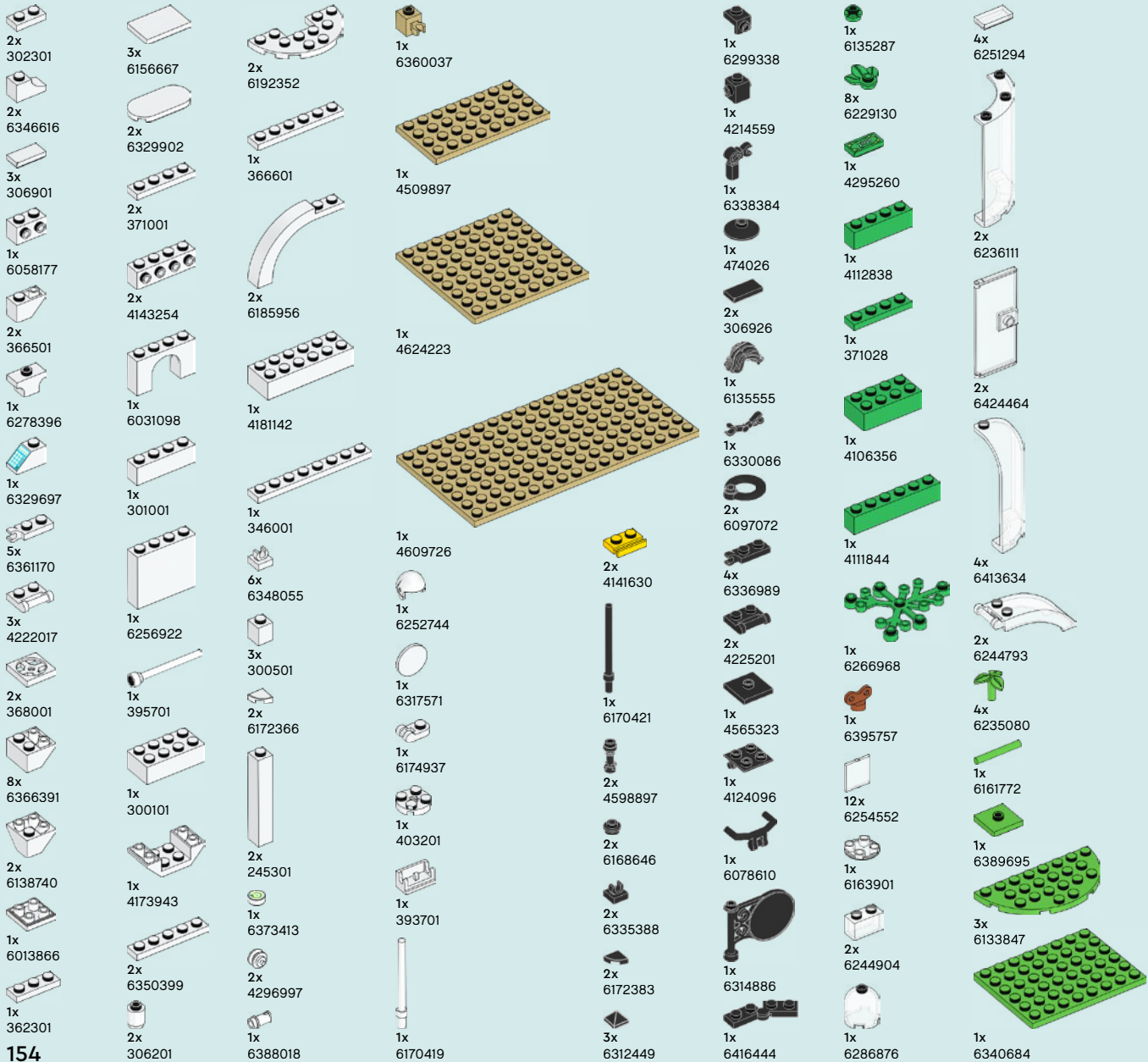



YOU COULD

WIN



Scan this QR code or go to
LEGO.COM/PRODUCTFEEDBACK and give
us your short feedback about this LEGO®
set for a chance to win a cool LEGO prize.

Terms and Conditions apply*

DE: Du könntest GEWINNEN. Es gelten die Teilnahmebedingungen* **FR: Tu pourrais GAGNER.** Des conditions s'appliquent* **IT: Potresti VINCERE tu.** Termini e condizioni sono applicabili* **ES: Puedes GANAR.** Aplican términos y condiciones* **PT: Poderá GANHAR.** Aplicam-se termos e condições* **JA: プレゼント付き! 利用規約が適用されます*** **ZH: 轻松获奖. 条款和条件适用*** **KO: 상품의 주인이 되어보세요. 소정의 약관이 적용됩니다*** **RU: Вы можете ВЫИГРАТЬ.** Действуют положения и условия* **PL: Szansa na WYGRANĄ.** Obowiązują warunki korzystania* **CS: Máte šanci VYHRÁT.** Platí všeobecné smluvní podmínky* **SK: Máte šancu VYHRAŤ.** Platia všeobecné zmluvné podmienky* **HU: TE IS NYERHETSZ.** Felhasználási feltételek érvényesek* **RO: Ai putea CÂȘTIGA.** Se aplică termeni și condiții* **BG: Можете да СПЕЧЕЛИТЕ.** Има определени правила и условия* **LV: Tu vari LAIMĒT.** Ir spēkā noteikumi un nosacījumi.* **ET: Sul on võimalus VÕITA.** Kehtivad tingimused* **LT: Jūs galite LAIMĖTI.** Taikomos sąlygos*
*LEGO.com/productfeedback-terms