



# Mixels

41520  
TORTS



## MIX!



41522  
SCORPI



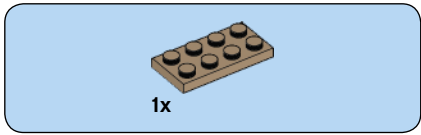

1

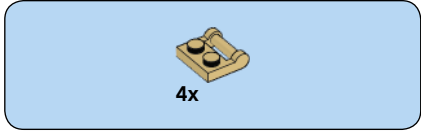
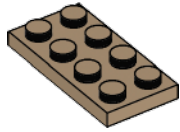

2

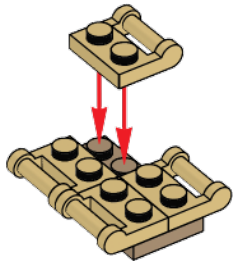

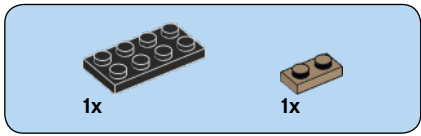

3

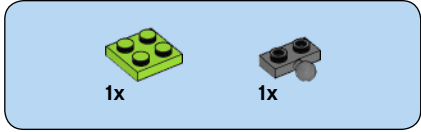
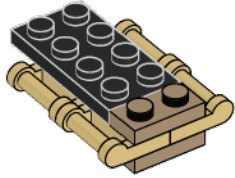

4

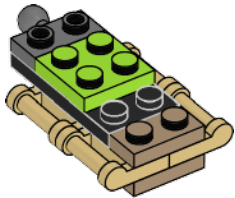

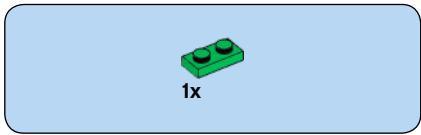

5

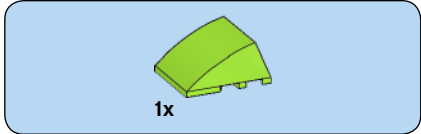
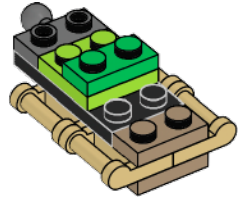

6

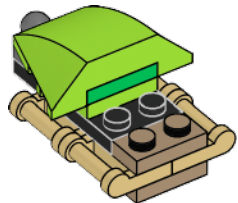

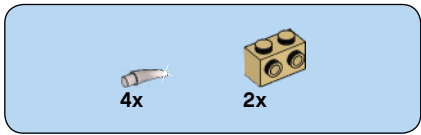

7

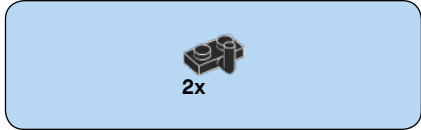
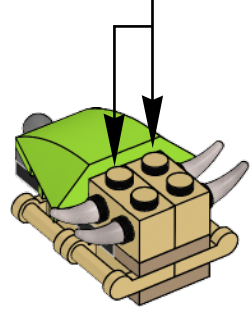
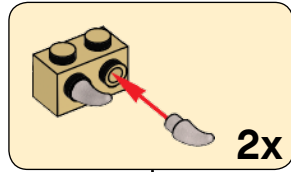

8

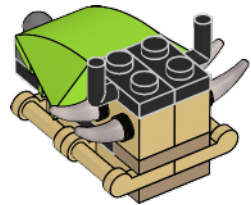

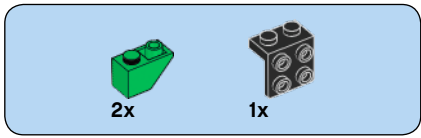

9

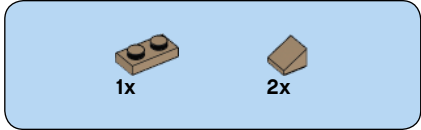
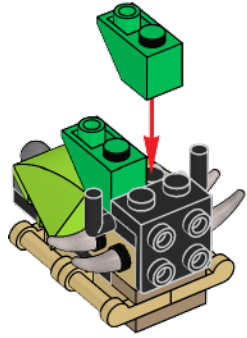

10

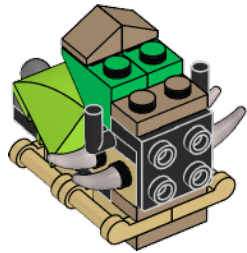



1x

# 11

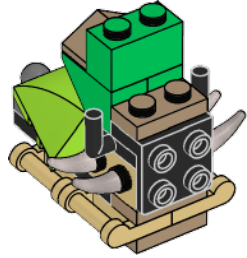

2x

# 12

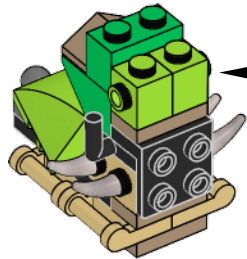

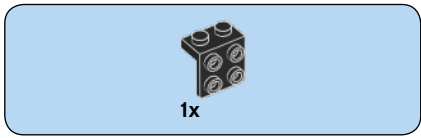

13

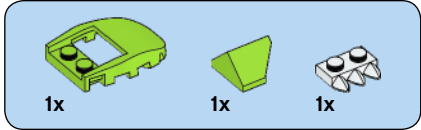
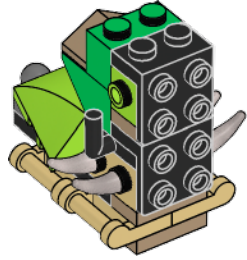

14

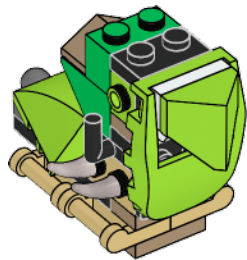
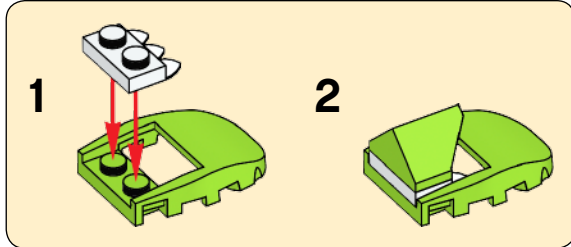



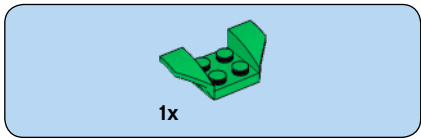

15

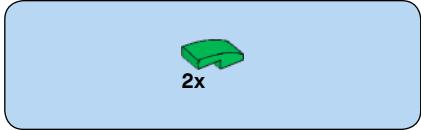
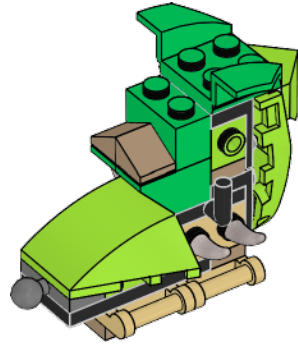
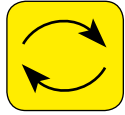

16

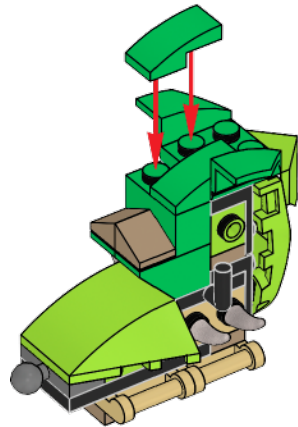

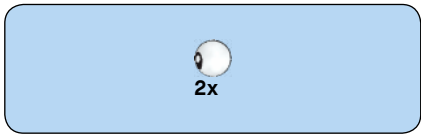

17

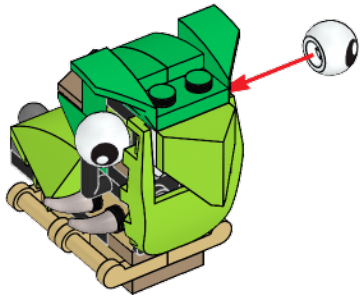

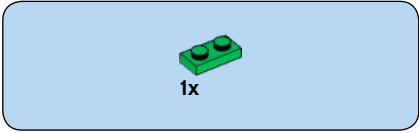
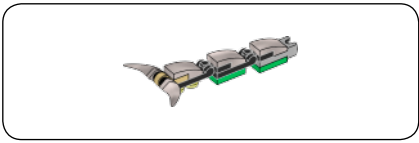

**1**

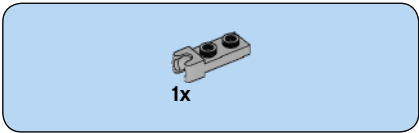
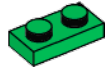

**2**

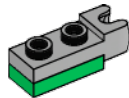

**3**

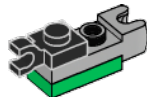

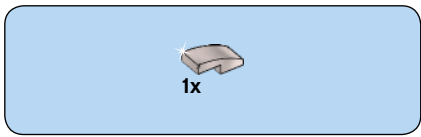

4

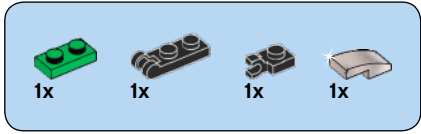
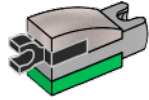

5

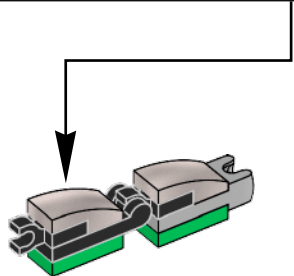
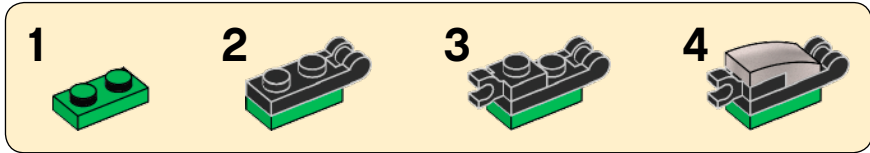

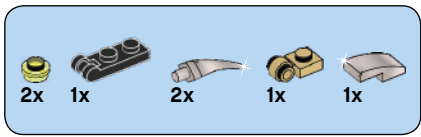

6

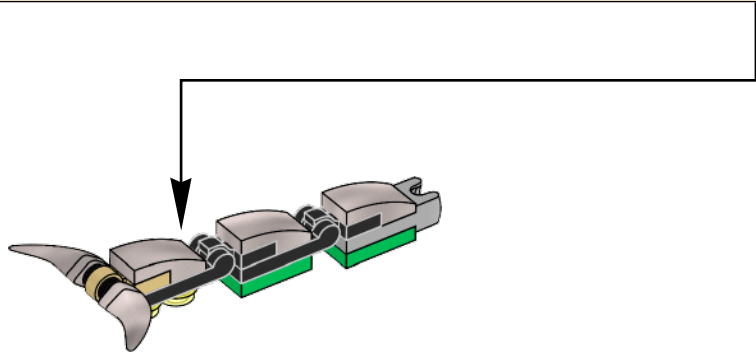
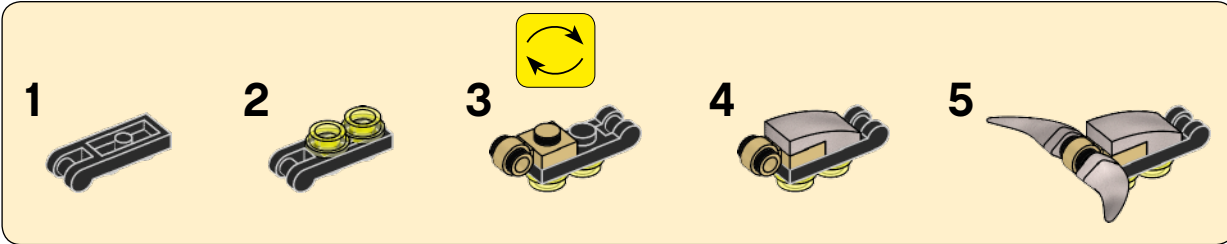

18

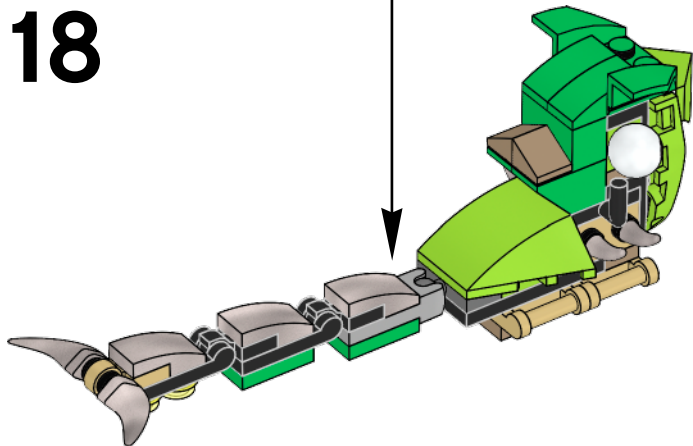

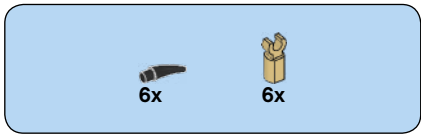

# 19

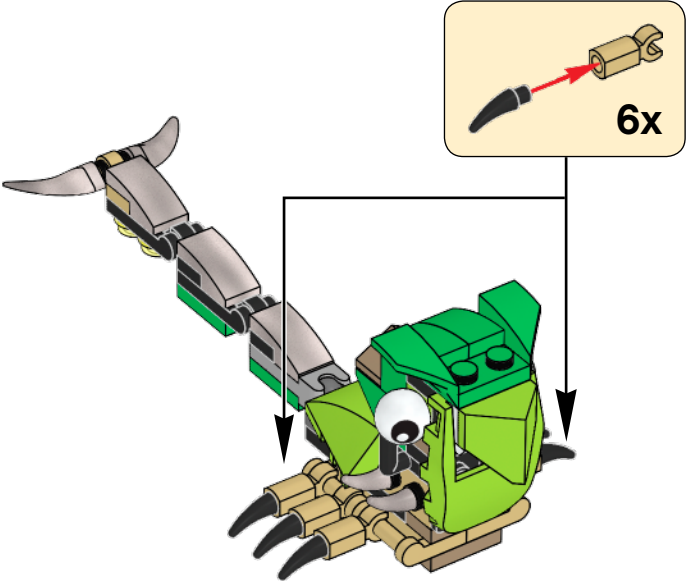

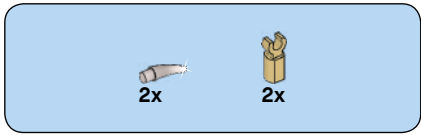

20

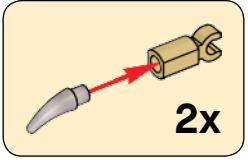
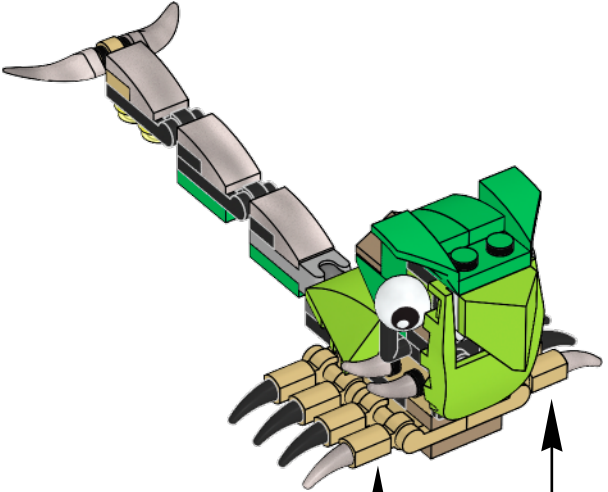

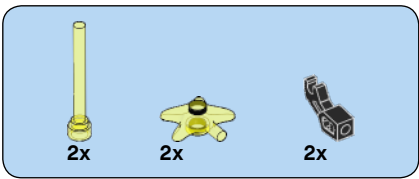

# 21

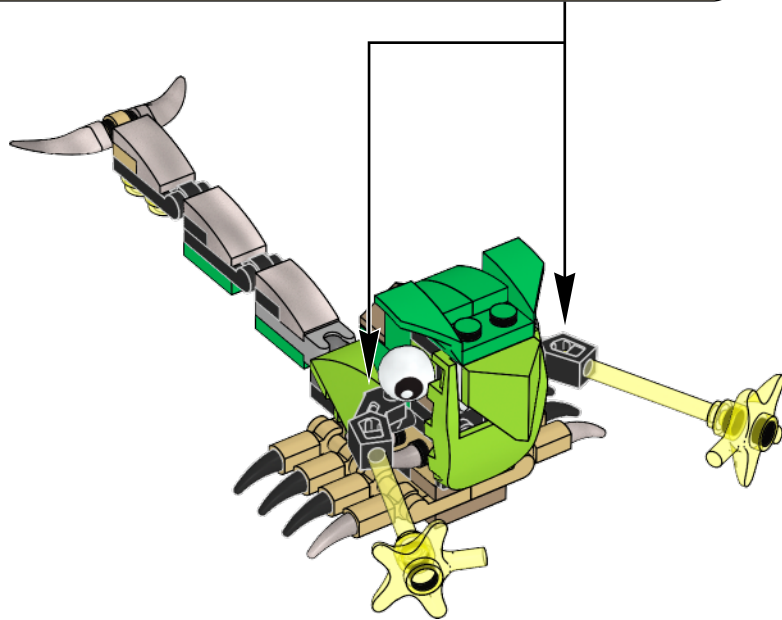
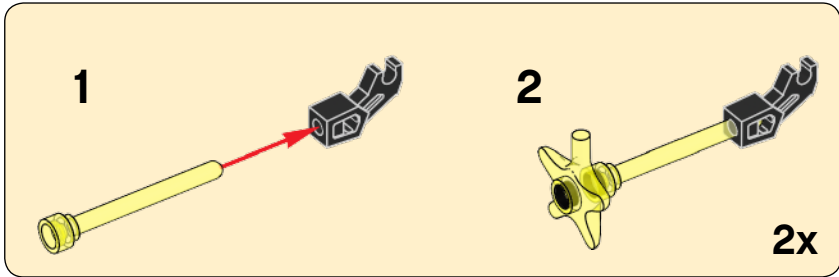

LEGO, the LEGO logo and MIXELS are trademarks and/or copyrights of the/sont des marques de commerce et/ou copyrights du/son marcas registradas, algunas de ellas protegidas por derechos de autor, de LEGO Group. ©2014 The LEGO Group. All rights reserved/Tous droits réservés/Todos los derechos reservados.



Customer Service  
 Kundenservice  
 Service Consommateurs  
 Servicio Al Consumidor  
 LEGO.com/service or dial

: 00800 5346 5555  
 : 1-800-422-5346