

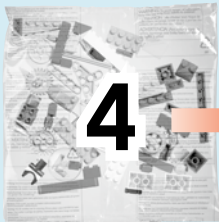

# ELVES

41175

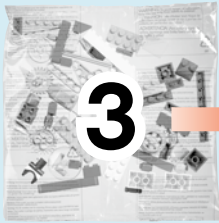



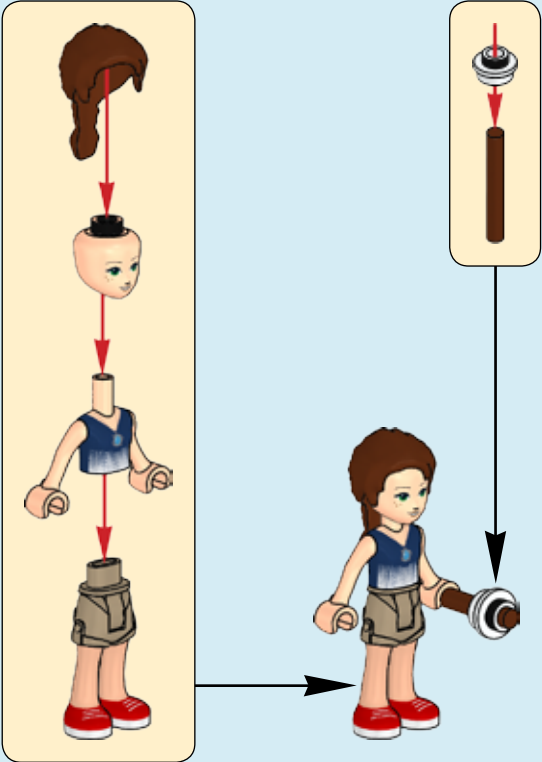
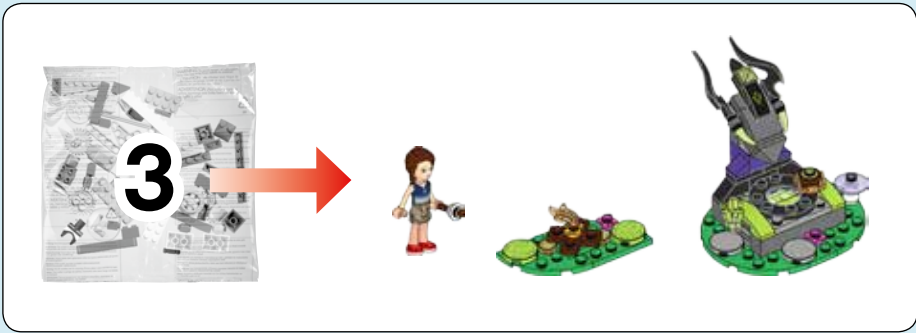



2x

1

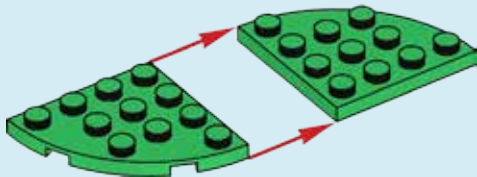

1x



2x

2



1x

2x

# 3



1x

1x

1x

# 4



1

2



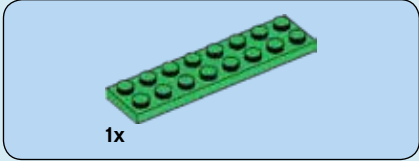

1

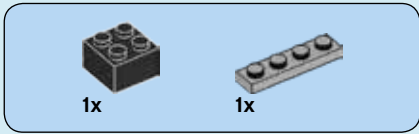
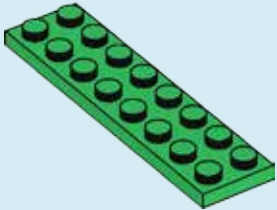

2

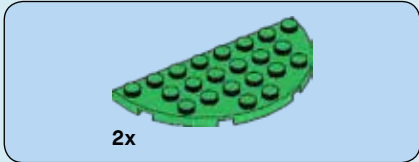
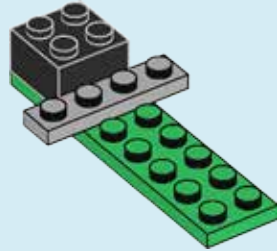

3

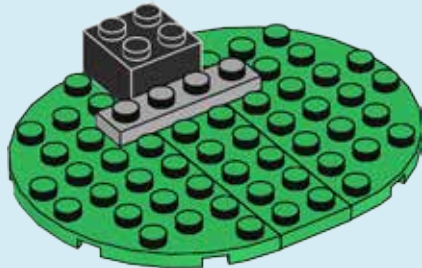

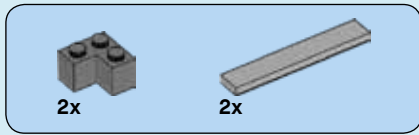

4

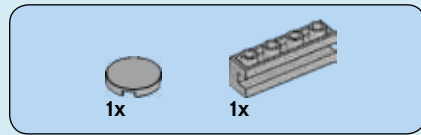
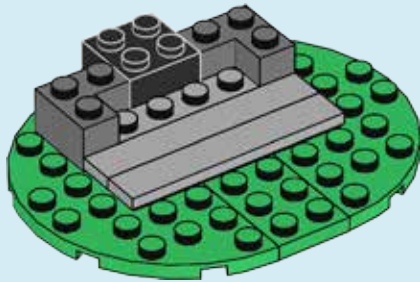

5

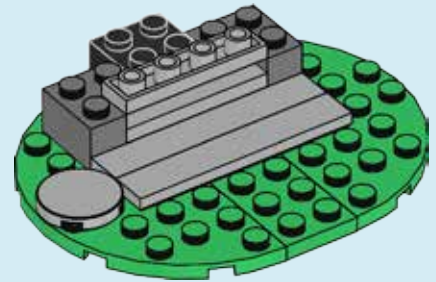

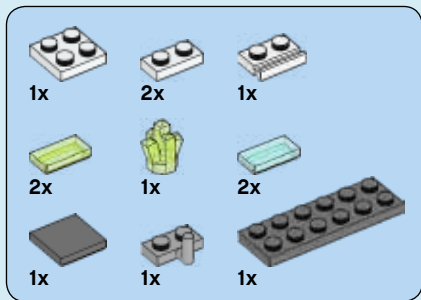

6

1

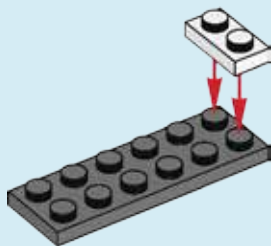

2

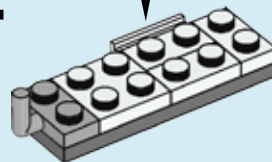

3

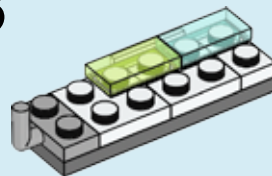



4

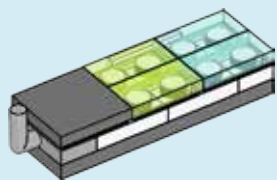

5

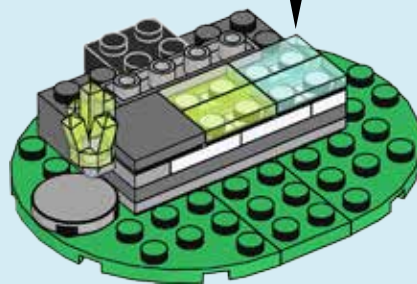
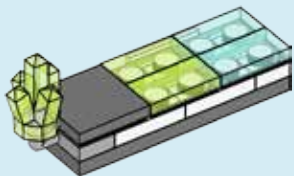

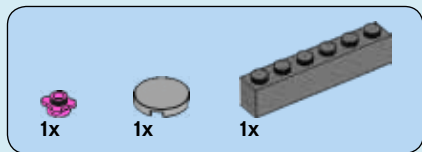

7

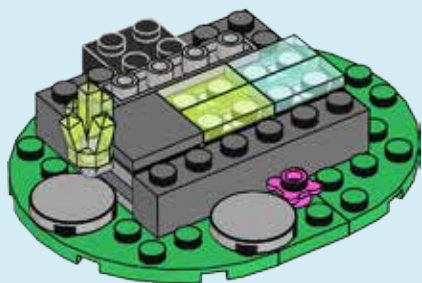

8

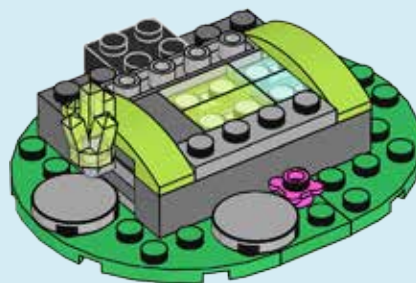



1x



2x

# 9

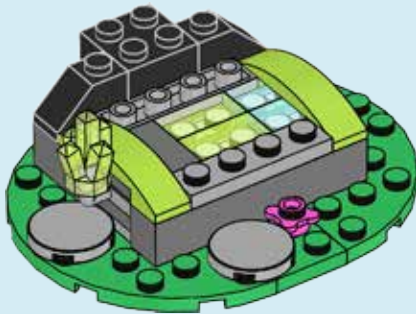

2x



1x

# 10

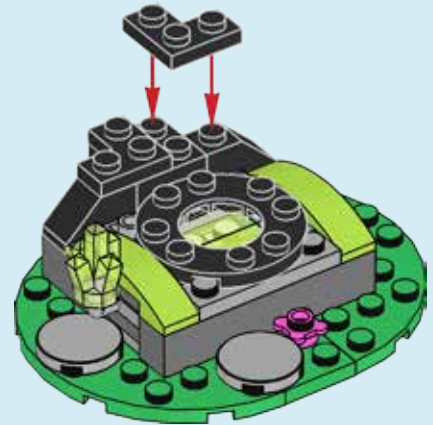

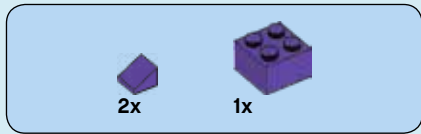

11

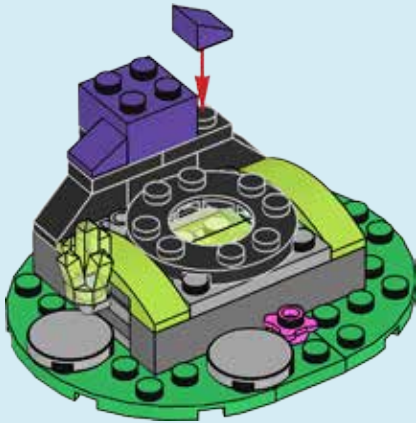

12

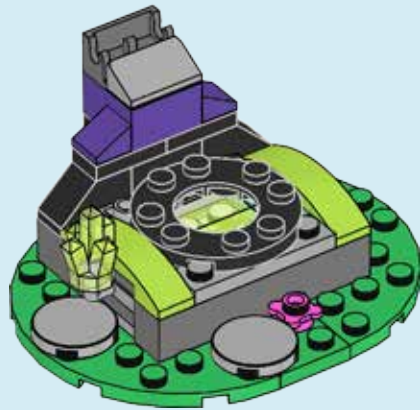

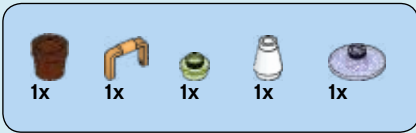

13

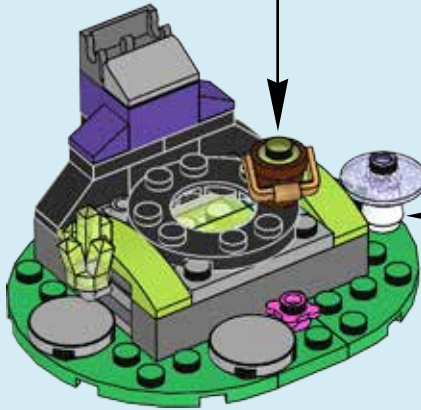
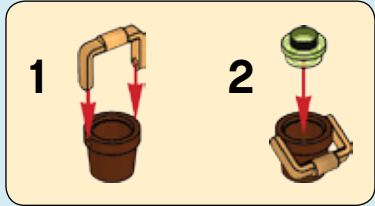
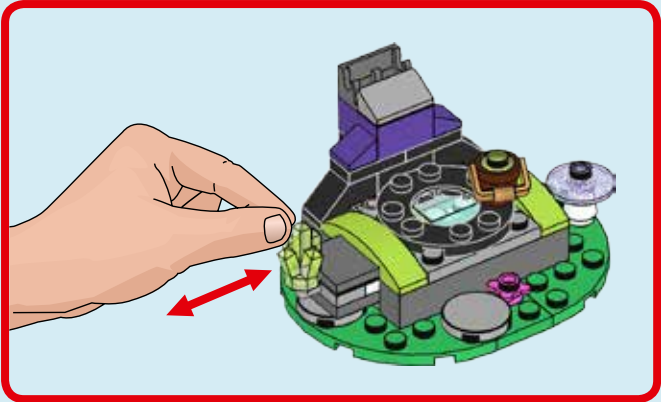



1x



1x

# 14

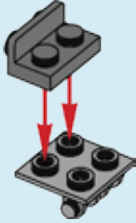

1x

# 15

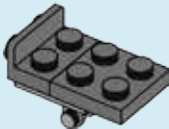

1x

# 16

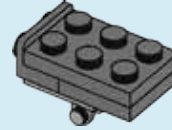

1x



2x

# 17

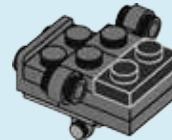

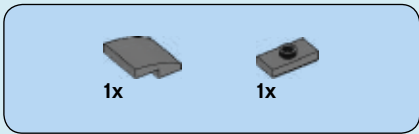

18

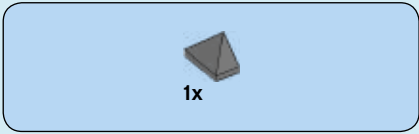
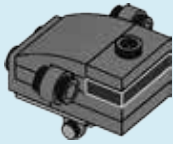

19

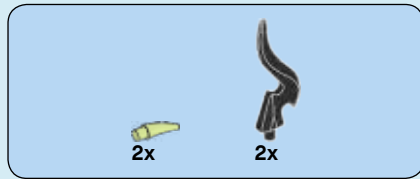
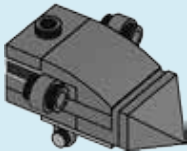
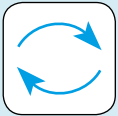

20

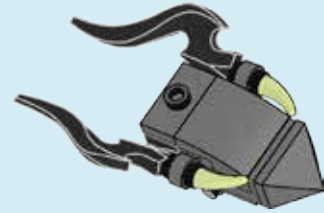

21

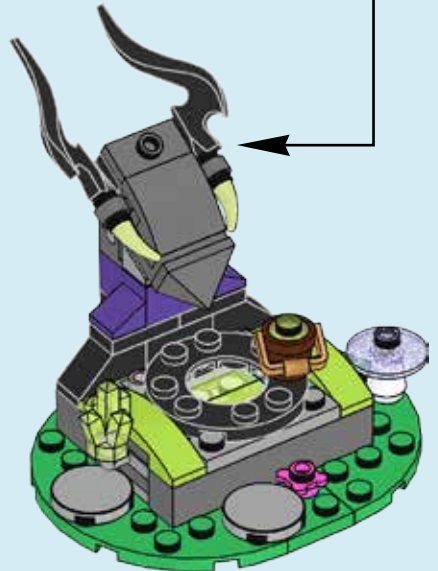



1x



1x



1x



1x

# 22

1



2

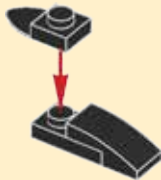

3

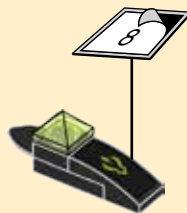



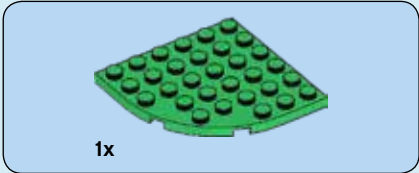
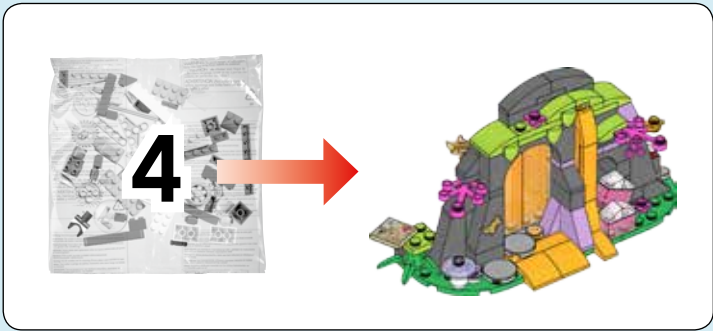

**1**

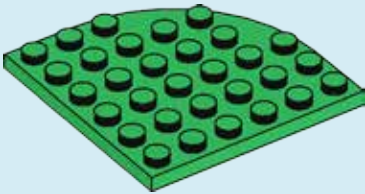

**2**

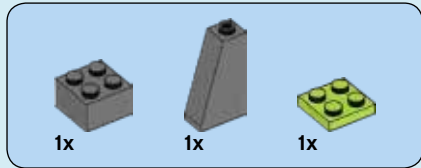
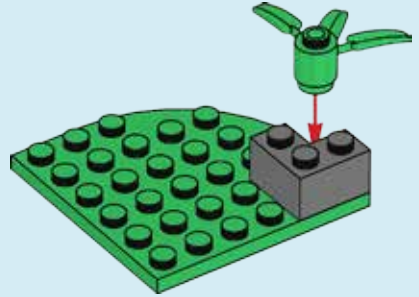

**3**

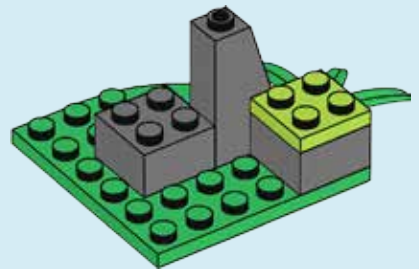

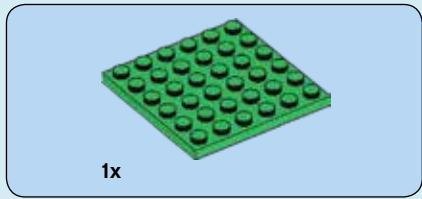

4

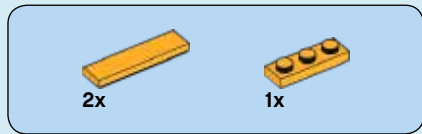
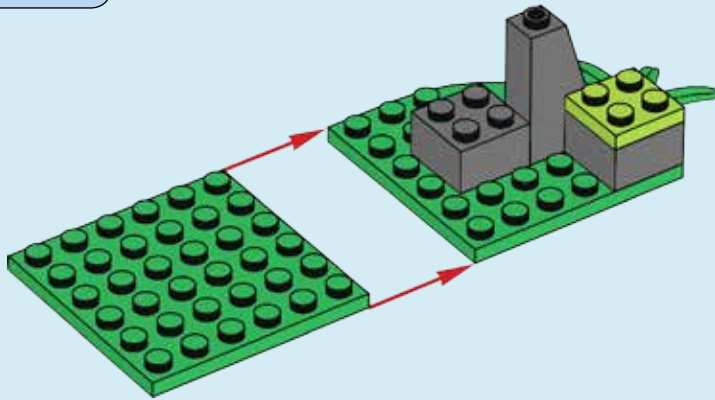

5

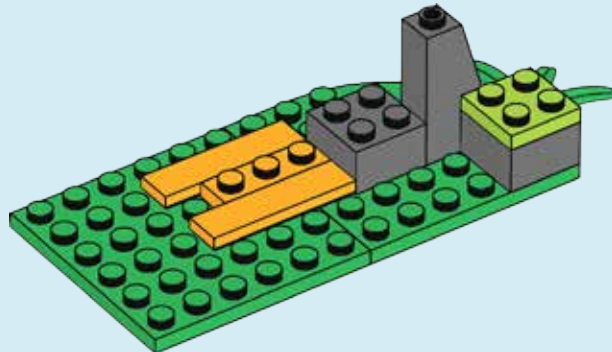

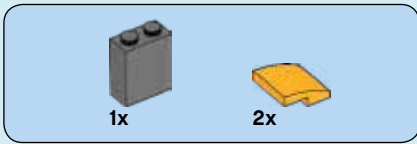

6

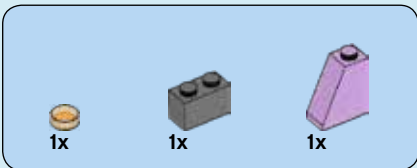
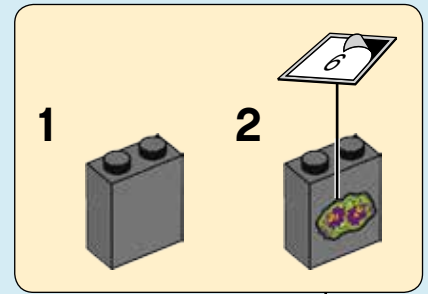
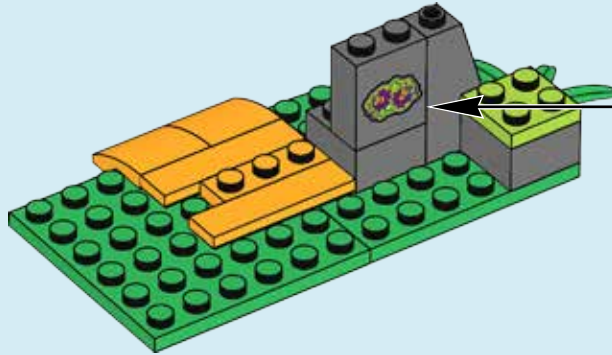

7

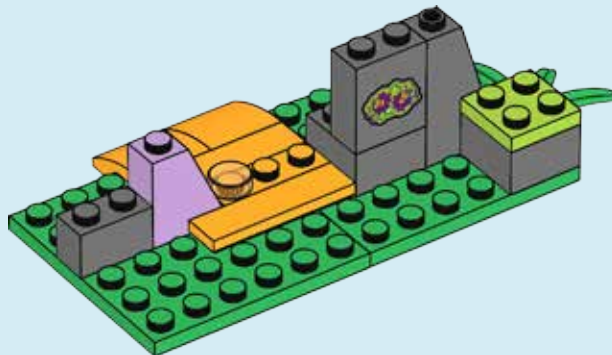

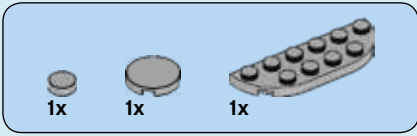

8

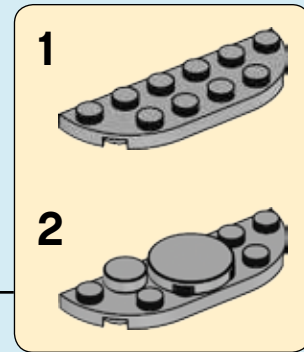
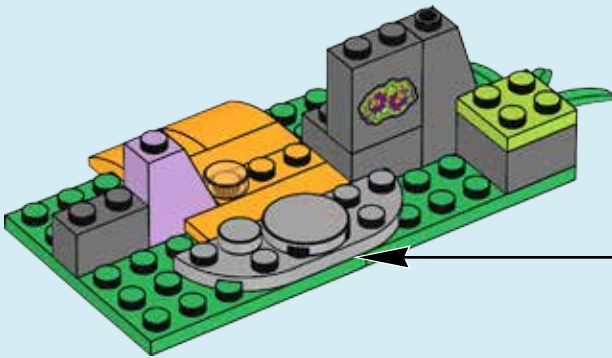

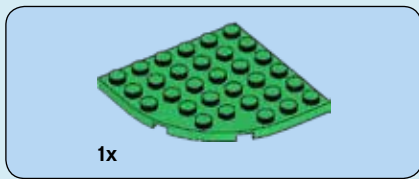

9

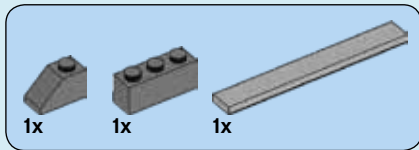
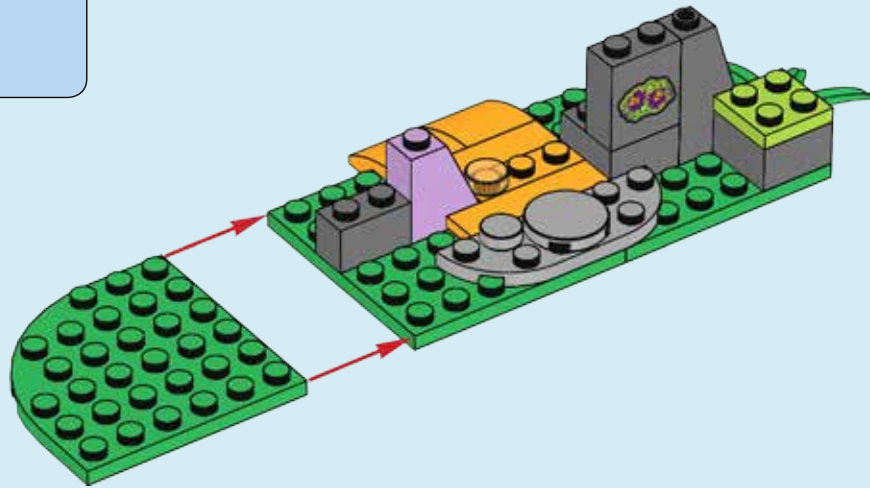

10

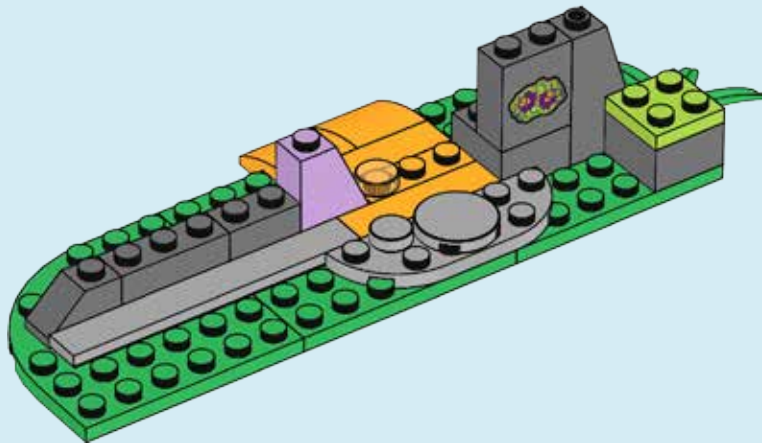

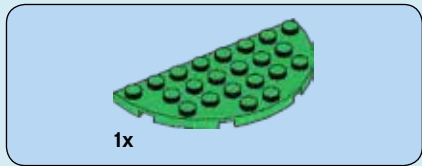

11

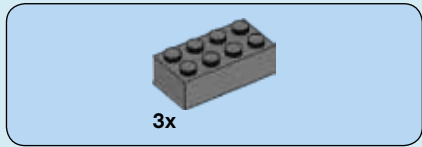
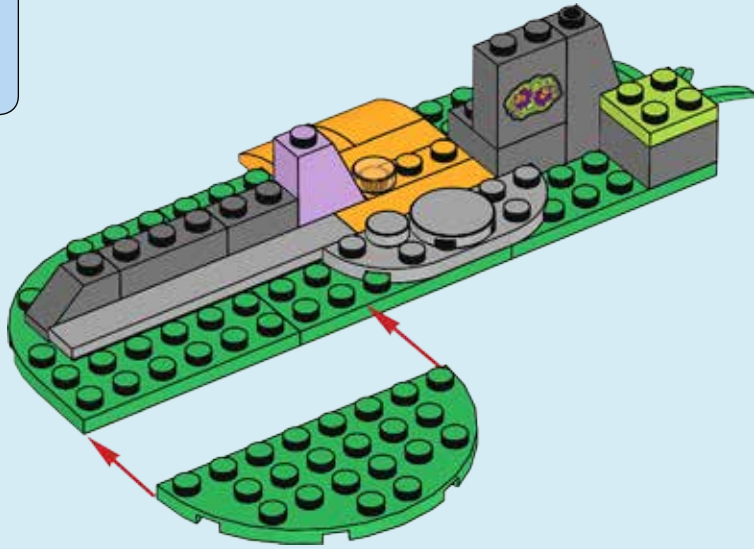

12

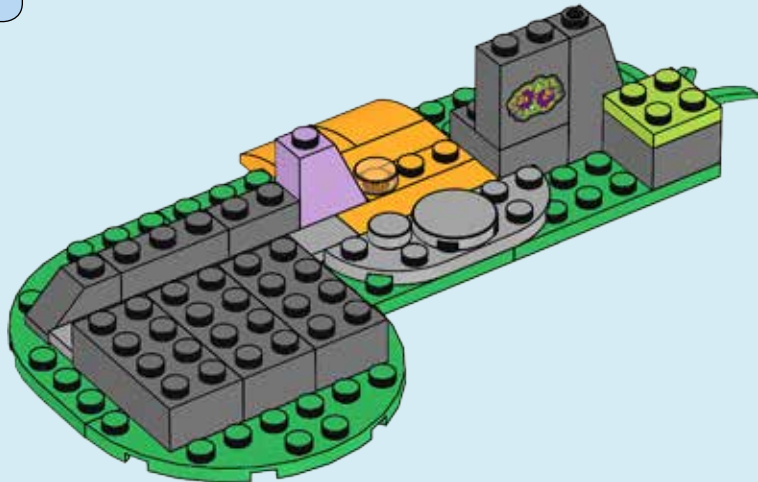

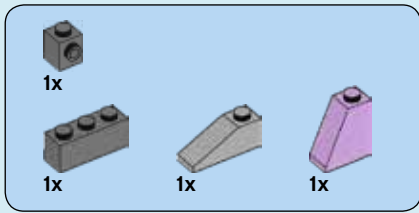

# 13

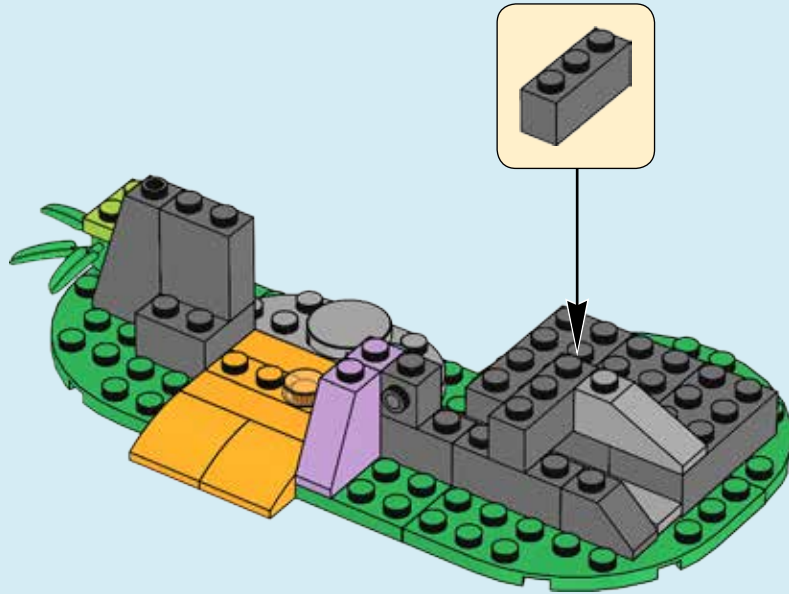
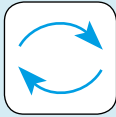

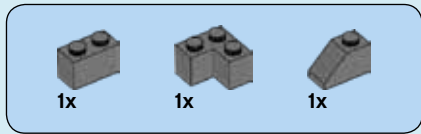

# 14

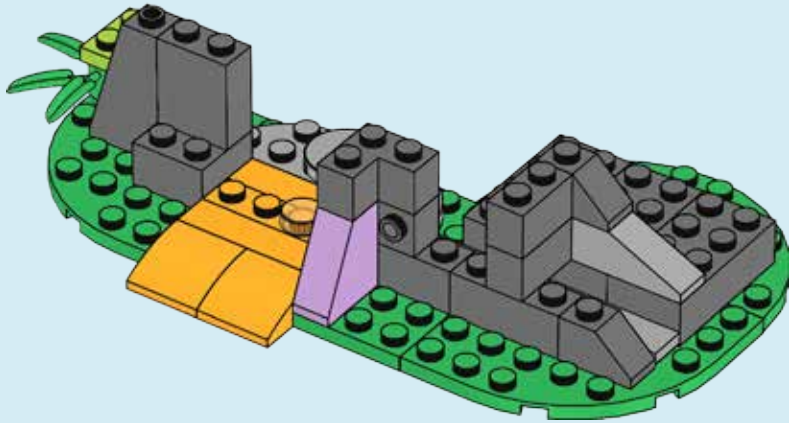



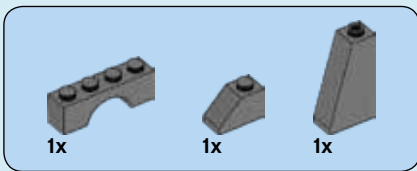

# 15

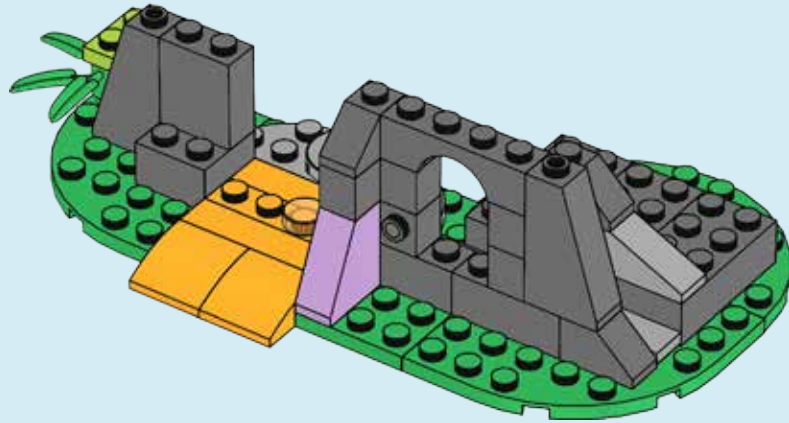

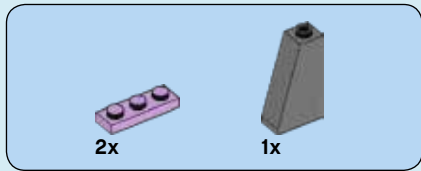

# 16

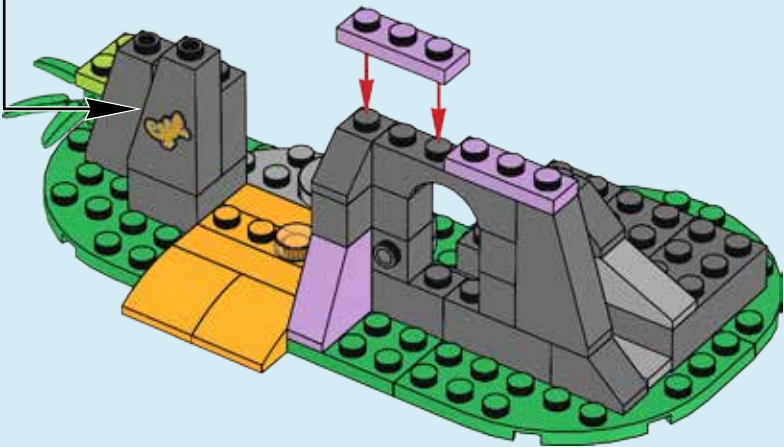
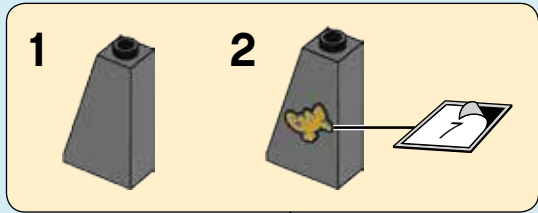

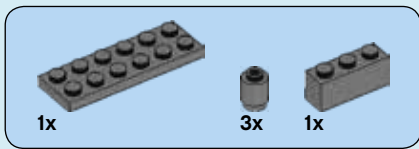

17

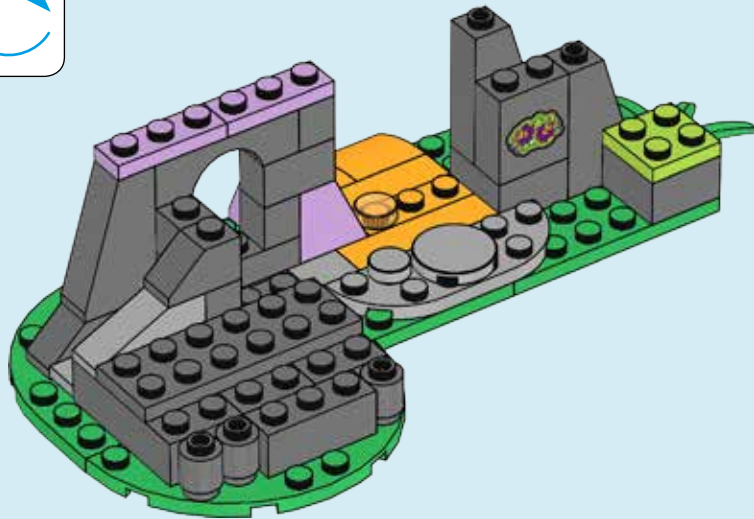
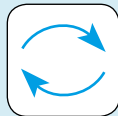



2x



2x

# 18

1



2

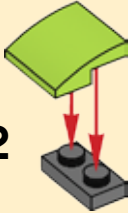

3



2x

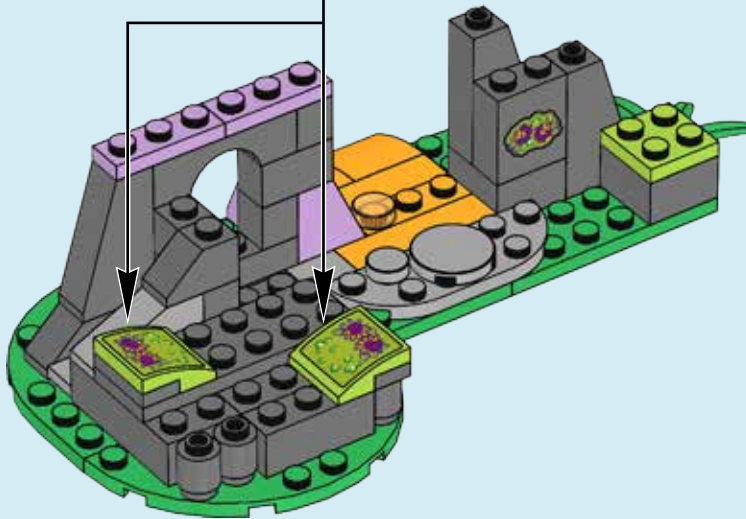

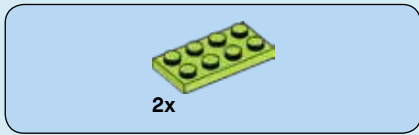

19

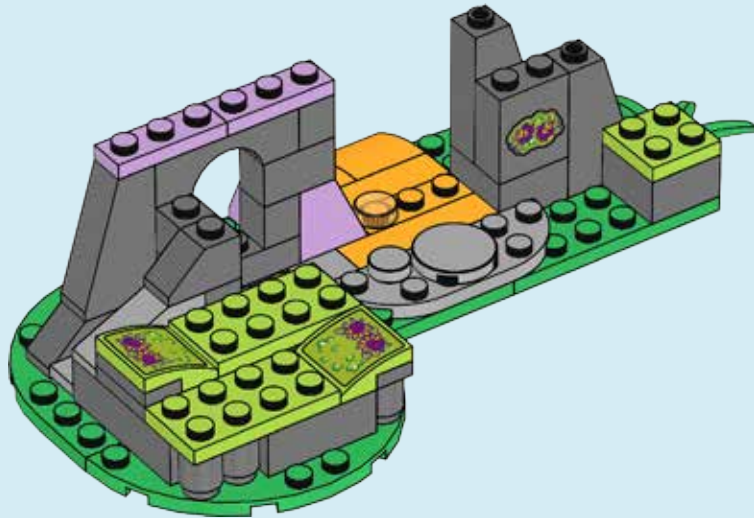

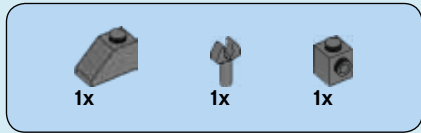

# 20

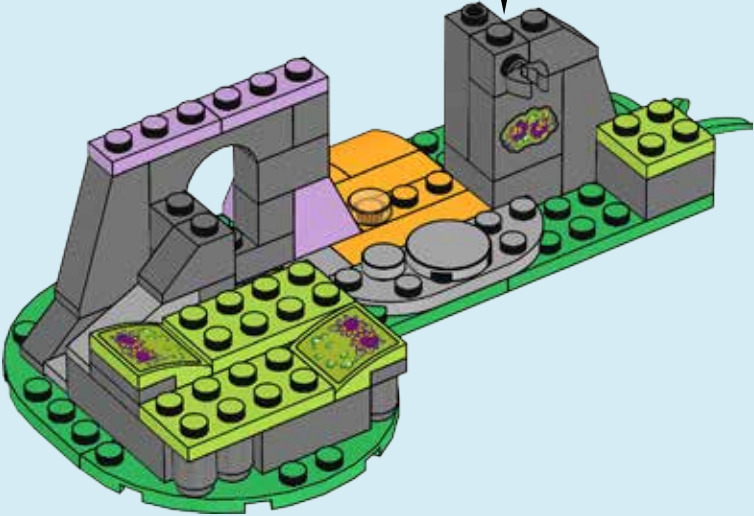
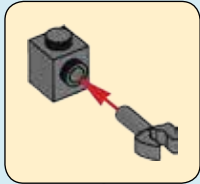

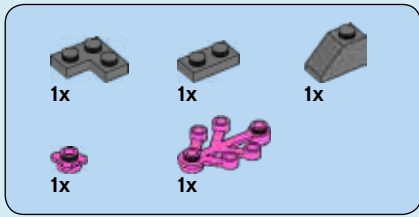

21

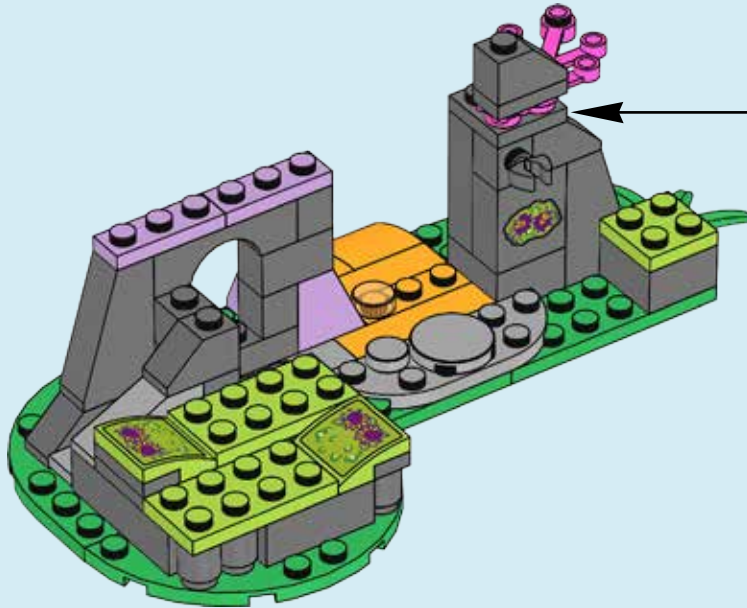
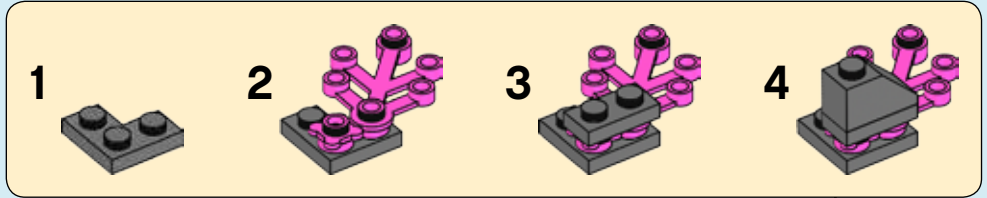

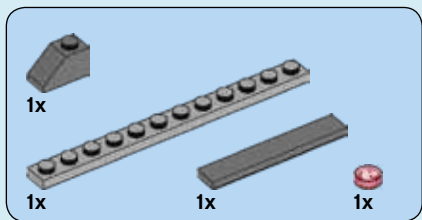

22

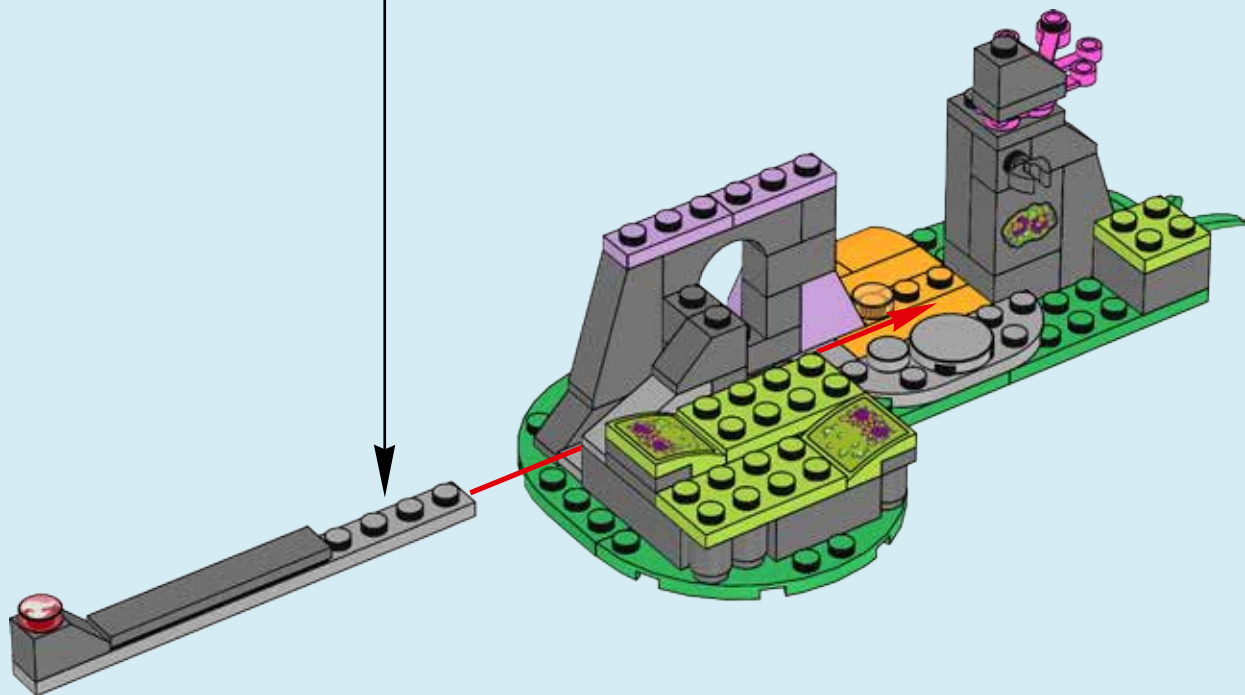
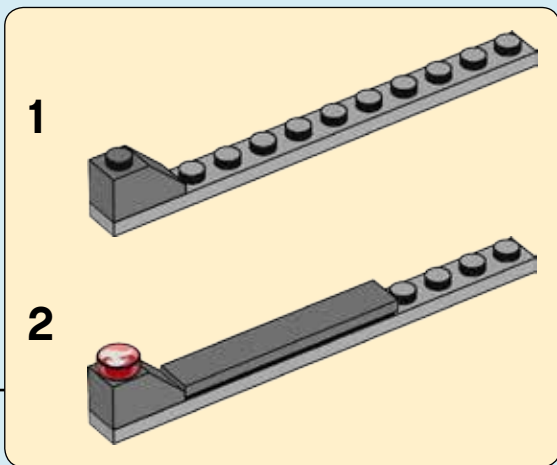



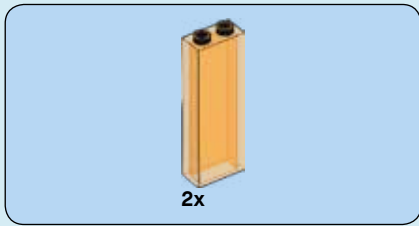

23

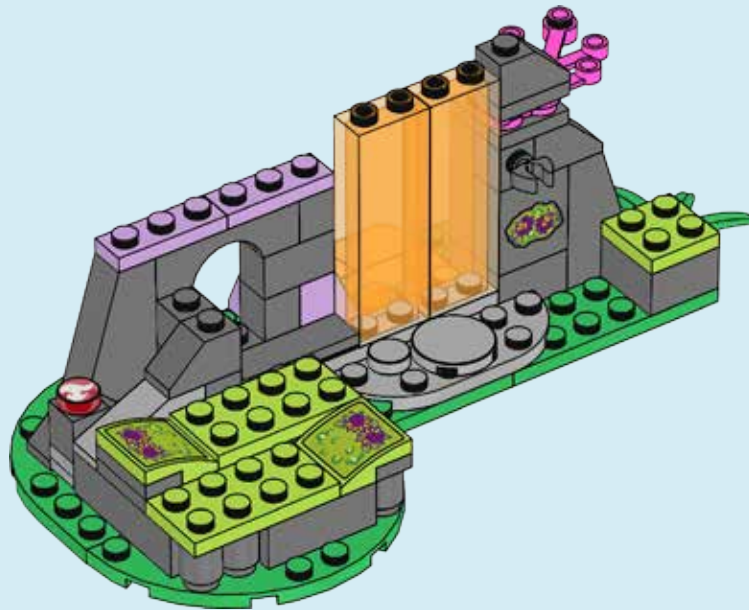

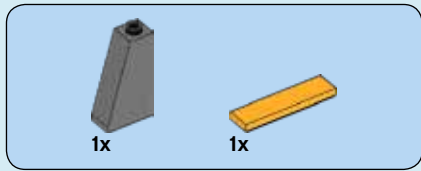

# 24

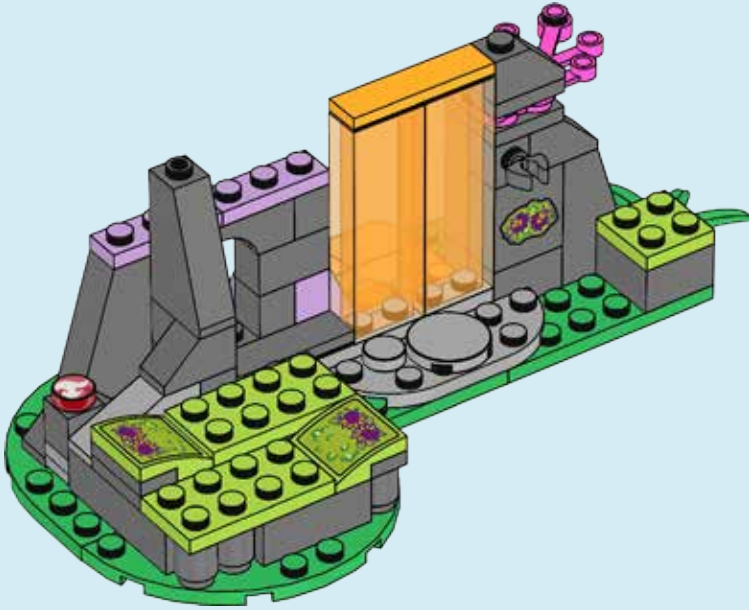

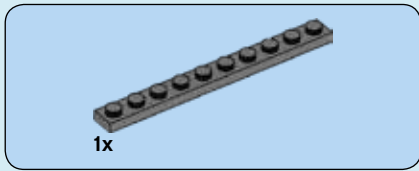

25

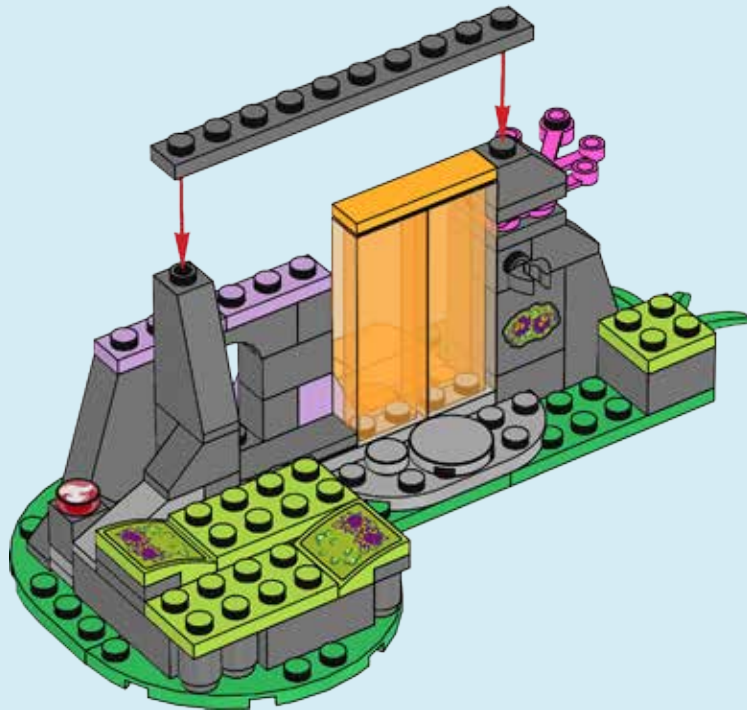
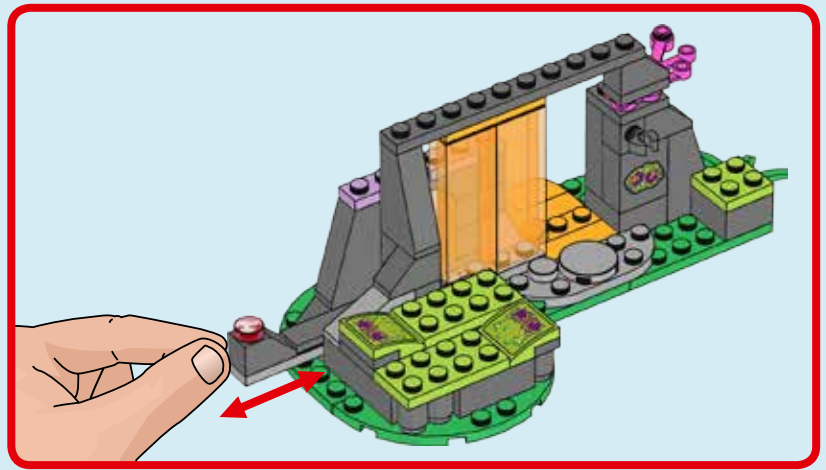



26

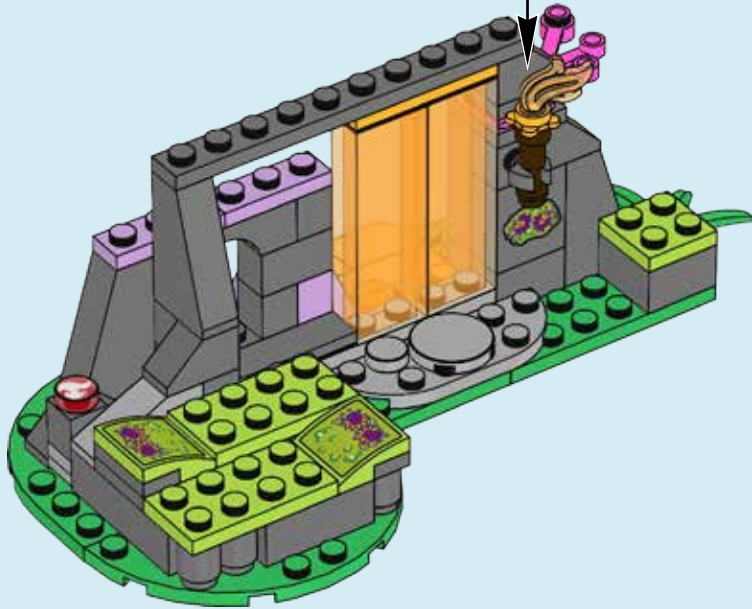
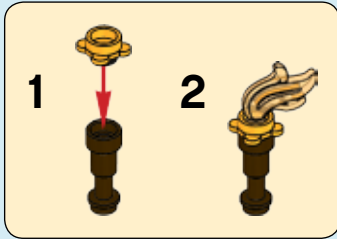

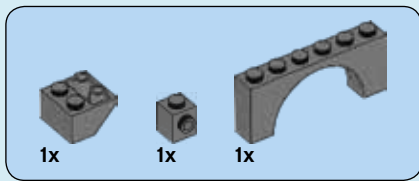

# 27

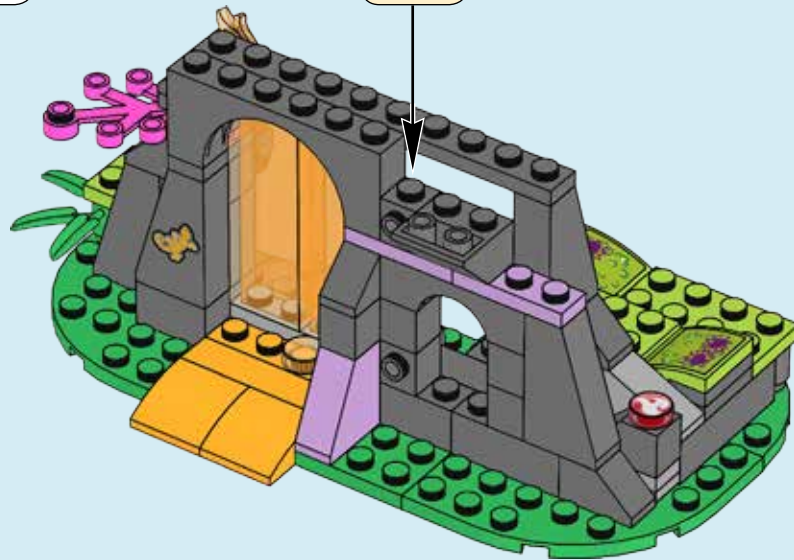
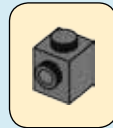
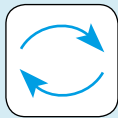



1x



1x

# 28

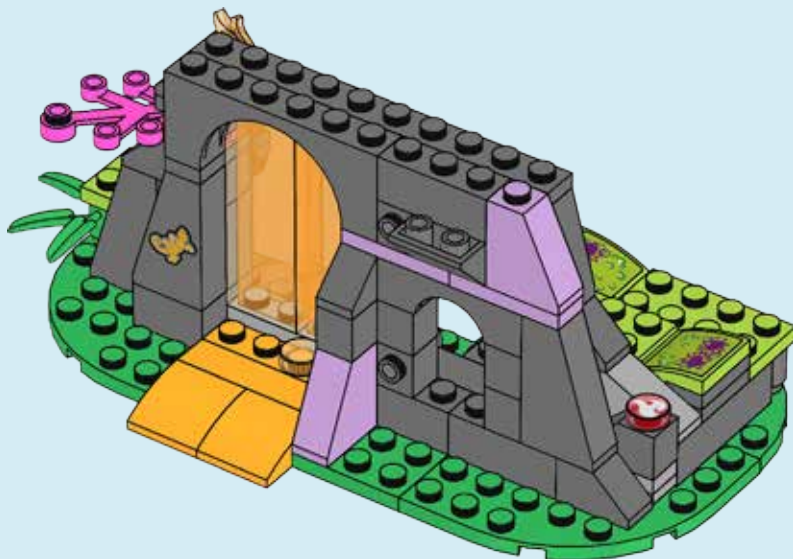

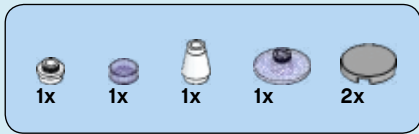

# 29

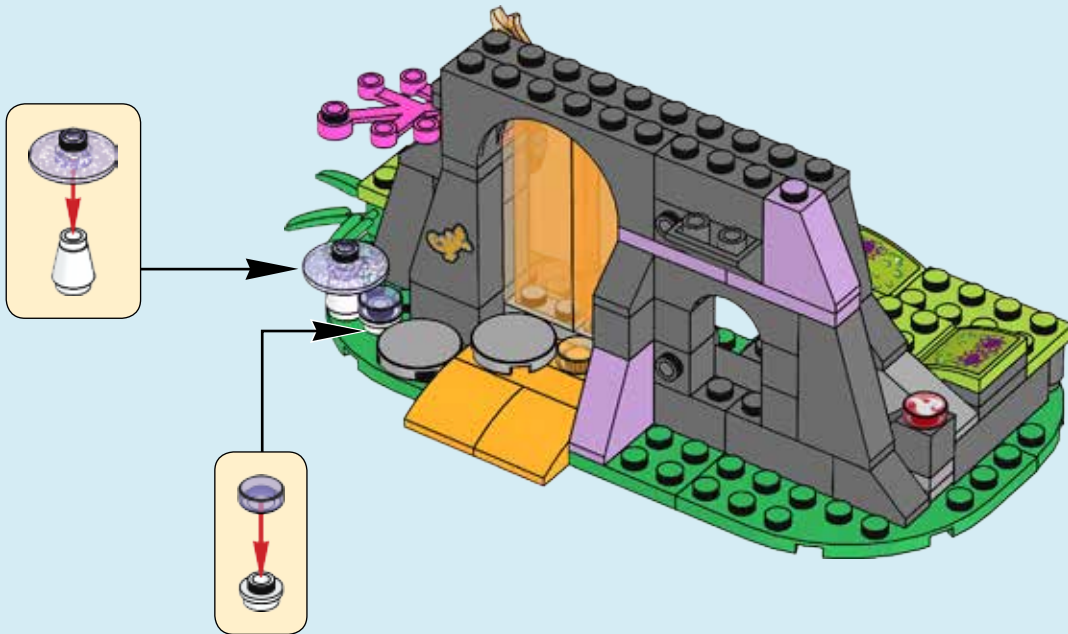



1x



1x



1x

# 30

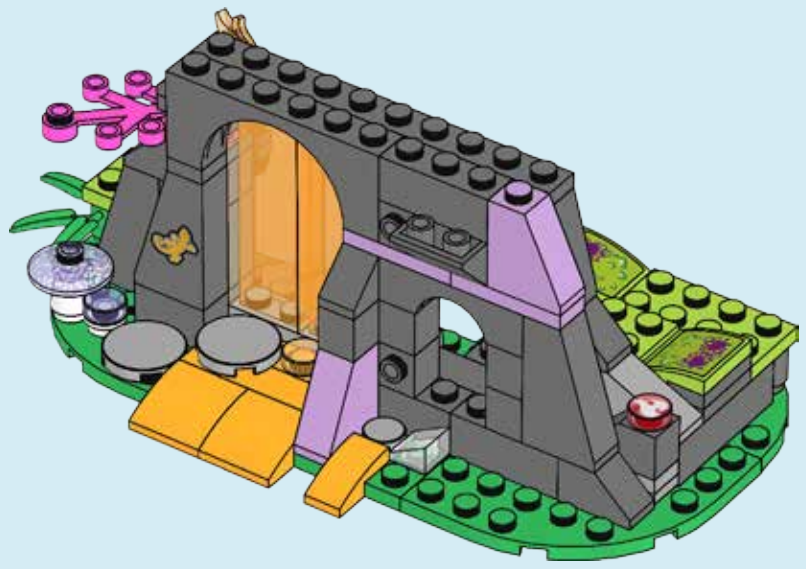





1x



1x



1x

# 31

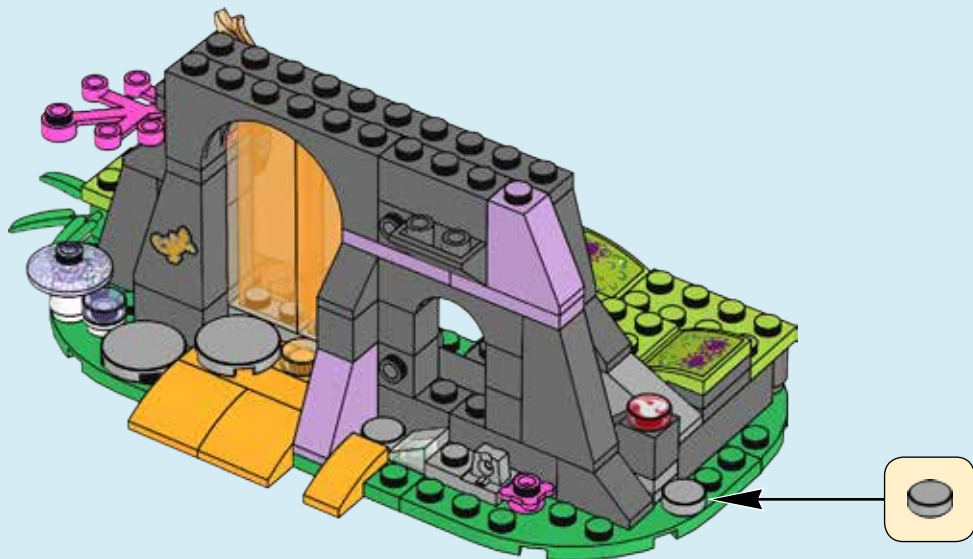

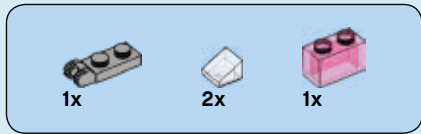

# 32

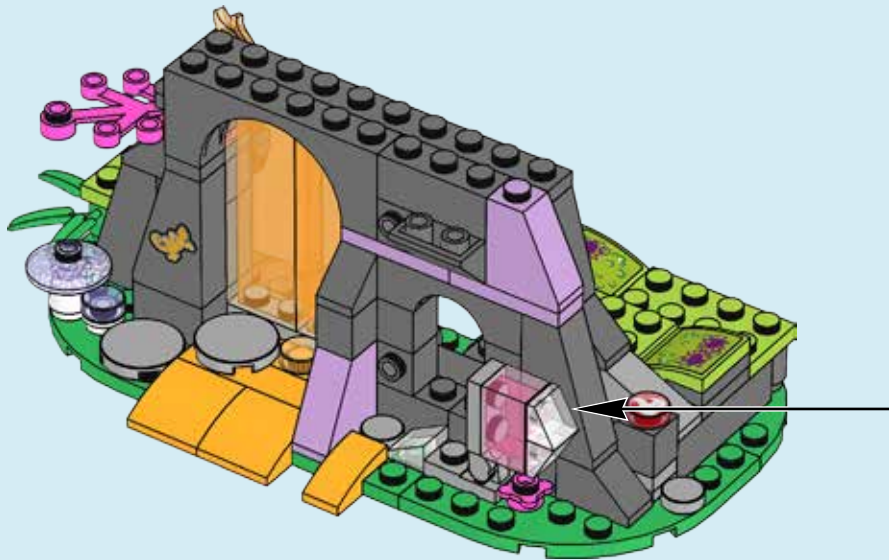
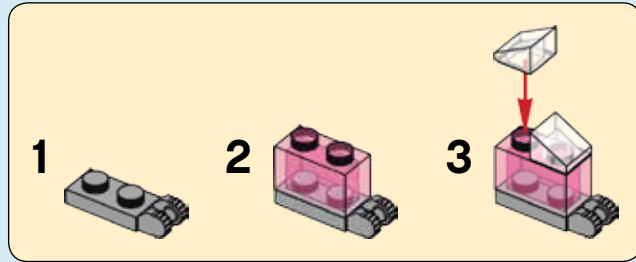

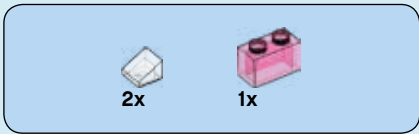

# 33

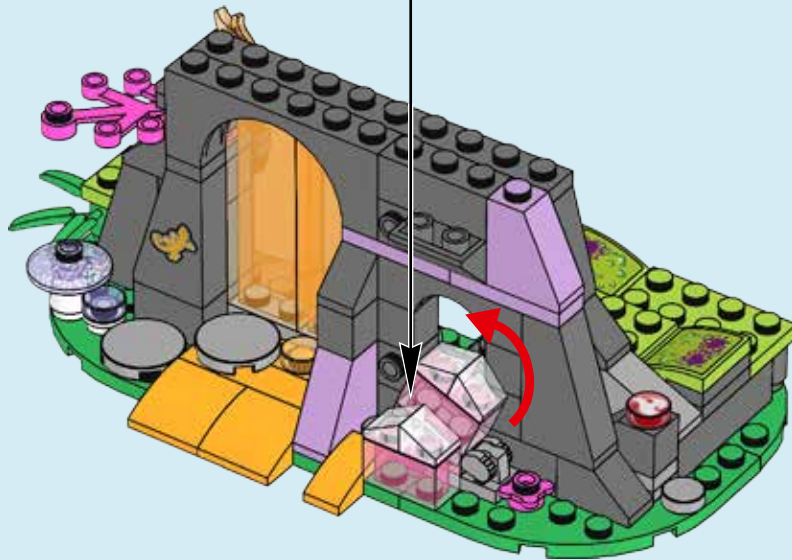
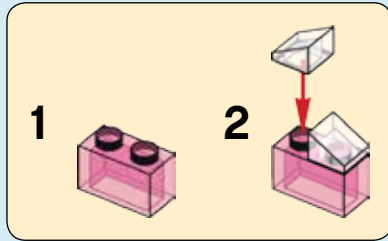



1x



1x



1x

# 34

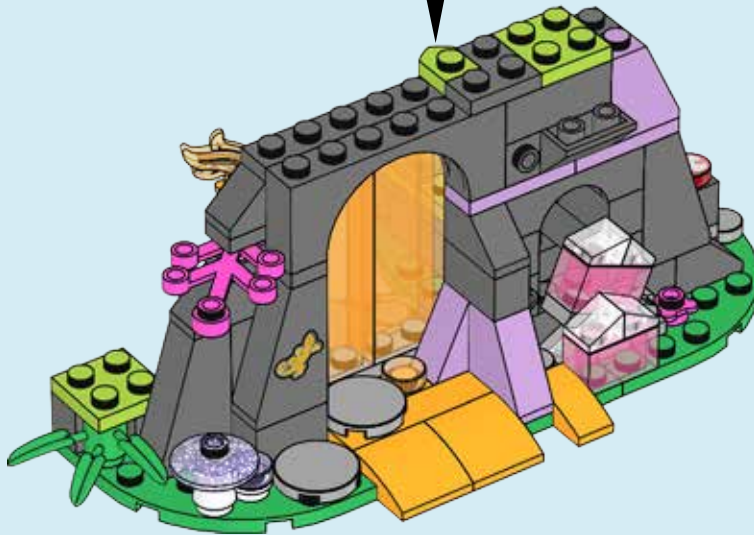



1x



4x

# 35

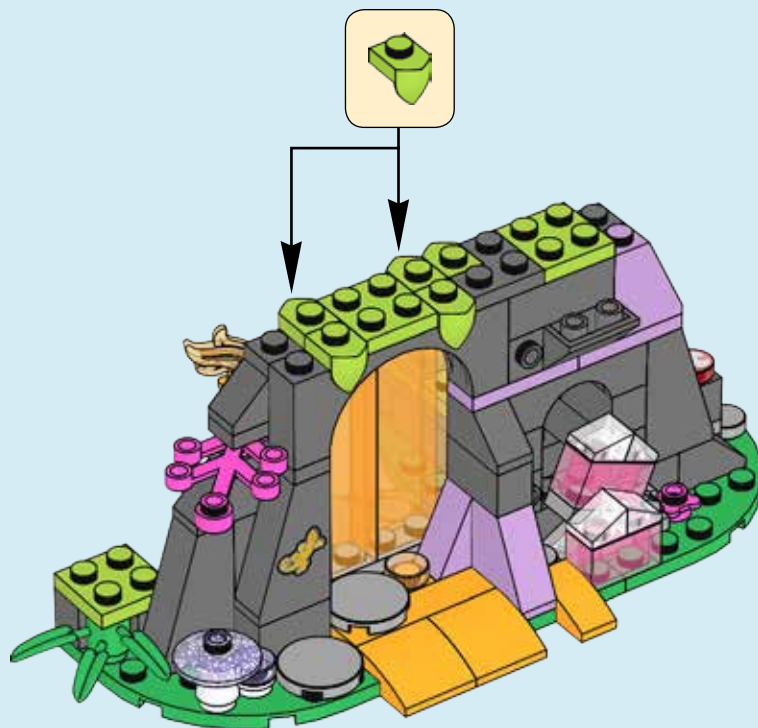



# 36

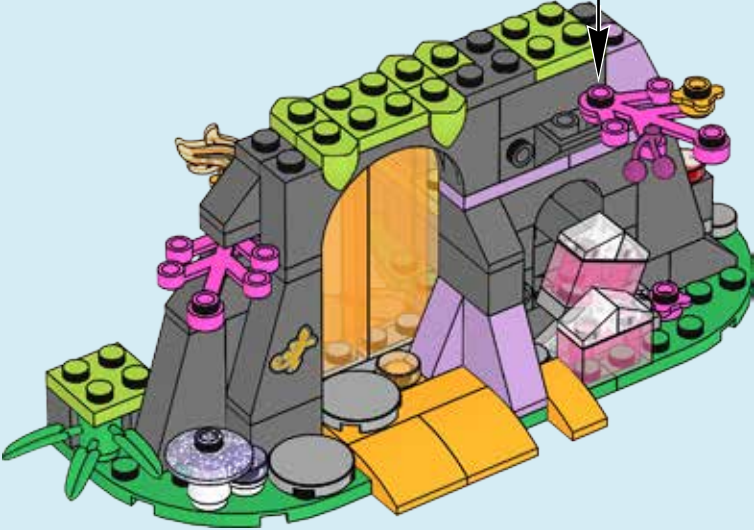
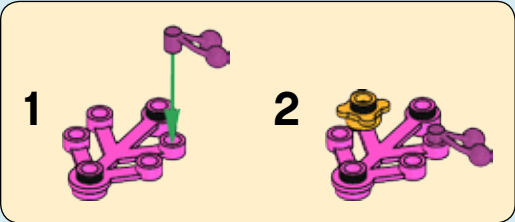

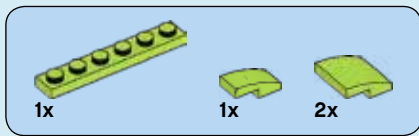

# 37

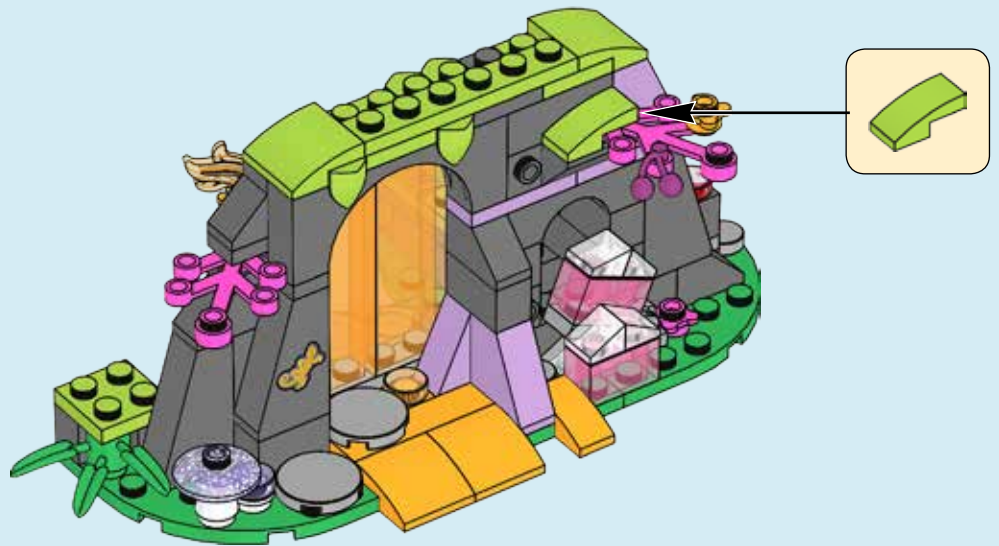

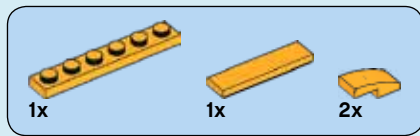

# 38

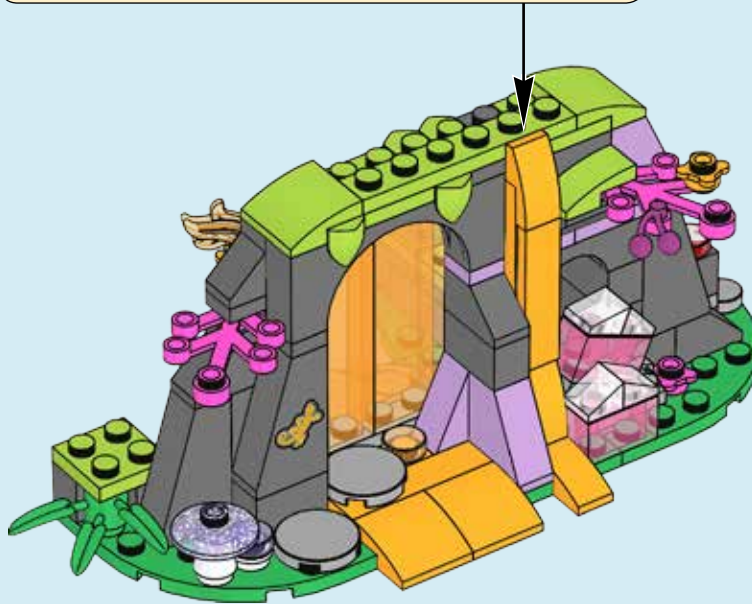
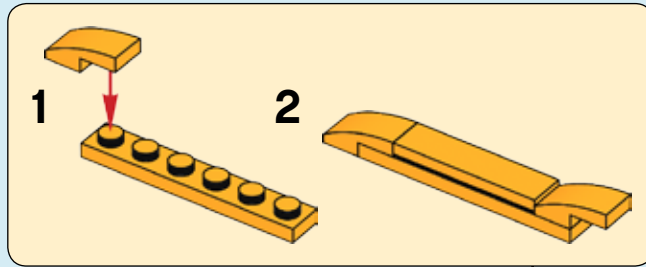



1x

1x

# 39

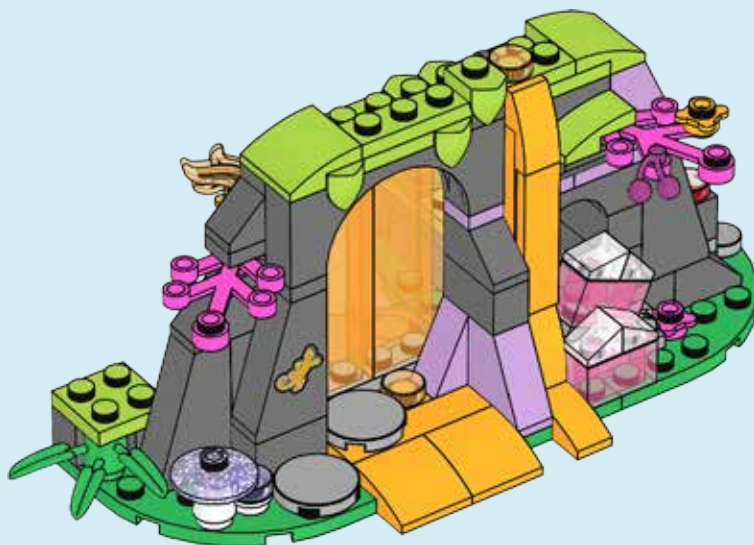



1x



2x

# 40

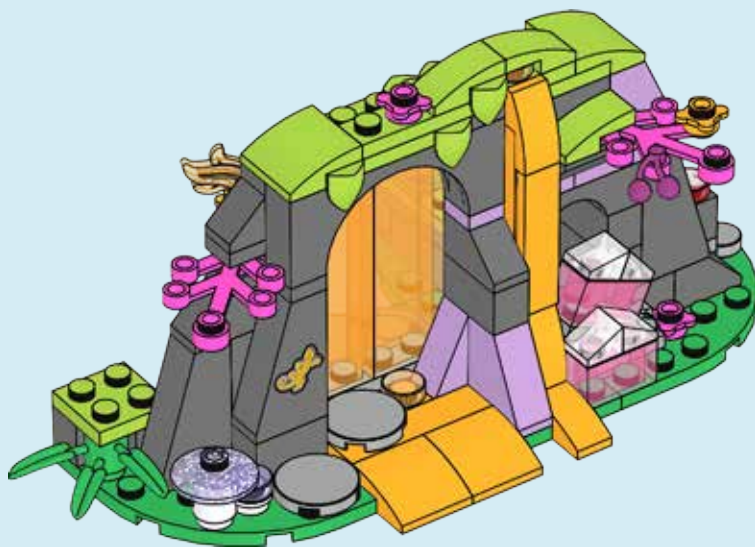

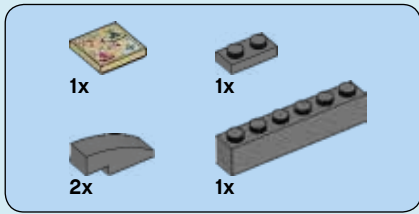

# 41

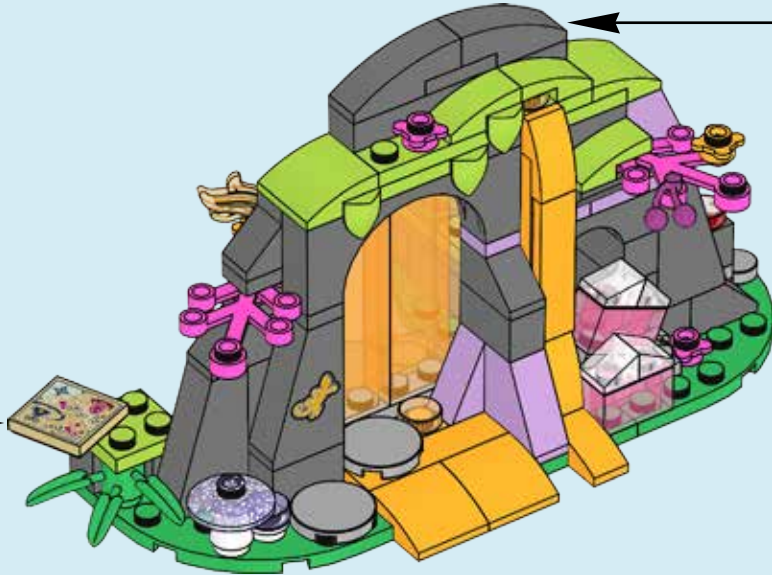
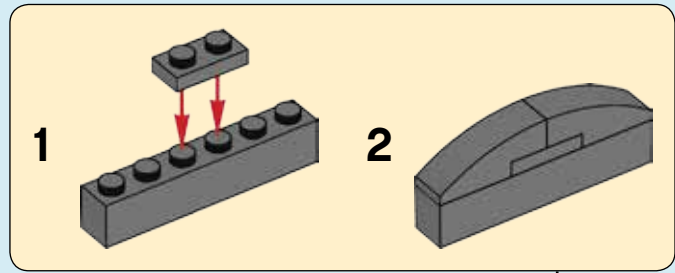



3x  
4650260

1x  
4211375

5x  
6052200

1x  
4568637

4x  
4211398

3x  
4219913

10x  
6043656

1x  
4611702

2x  
4654580

1x  
4211881

1x  
4211804

1x  
4211488

2x  
4211396

1x  
4211613

2x  
4211445

1x  
6105964

2x  
4211549

1x  
4211481

3x  
4211090

1x  
4289542

3x  
4558955

1x  
6076203

2x  
4632574

2x  
4211088

1x  
6092572

1x  
4210978

4x  
4221745

5x  
6039479

4x  
4211063

1x  
4211066

6x  
4211135

1x  
6000606

4x  
6123814

7x  
4211094

1x  
6071261

2x  
4210635

1x  
4211055

4x  
4211109

1x  
4211000

1x  
4211060

4x  
4211104

2x  
4246896

3x  
6039482

1x  
4211043

1x  
4211105

1x  
6099909

1x  
4210999

3x  
4211085

2x  
4211100

1x  
6106191

1x  
4210651

2x  
4211002

2x  
6114248

1x  
4273590

4x  
4121715

2x  
302326

1x  
6047276

2x  
4121966

2x  
300326

2x  
242026

2x  
6116604

1x  
6045912

1x  
4538950

6x  
6138659

2x  
6142097

3x  
6069006

4x  
6138661

3x  
4537937

2x  
4617069

2x  
4537936

1x  
4529160

1x  
6057034

1x  
6138727

1x  
6134621

2x  
6139003

2x  
6109556

1x  
4565321

1x  
4114348

2x  
6038682

3x  
6133767

1x  
303428

1x  
6097194

2x  
6021999

1x  
4257526

1x  
4514846

2x  
6134203

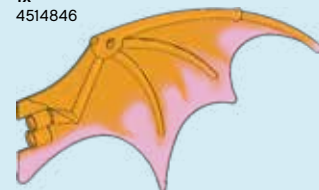

**Customer Service**  
Kundenservice  
Service Consommateurs  
Servicio Al Consumidor

**LEGO.com/service or dial**



**: 00800 5346 5555**

**: 1-800-422-5346**

 2x 4518400	 5x 4216479	 2x 4654105	 1x 6141978	 14x 6028736	 1x 6097511	 1x 4216695
 2x 4547649	 2x 6054406	 1x 6133929	 4x 4646865	 3x 4622062	 1x 6020074	 2x 4211257
 6x 302301	 2x 6093480	 1x 6065505	 2x 4649066	 4x 6138731	 4x 4523159	 1x 6050918
 4x 6046381	 1x 6100562	 2x 6093752	 2x 6108173	 16x 6099730	 4x 6109757	 2x 4211247
 2x 6117940	 2x 6133932	 3x 6138504	 1x 4261397	 1x 6073042	 1x 4587002	 1x 6103036
 1x 4249563	 2x 6096942	 2x 6112961	 3x 4624184	 1x 6097503	 4x 6071259	 1x 6136548
 1x 302201	 2x 6133934	 2x 4567509	 6x 6073040	 1x 6134876	 1x 4654247	 1x 6136566
 1x 6046979	 6x 6143445	 1x 4653960	 2x 6061685	 5x 6072668	 1x 6092594	 1x 6136578
 1x 302001	 3x 6101073	 4x 4206482	 1x 6020145	 4x 6133826	 1x 4626196	 1x 6136578
 5x 4244362	 3x 6103415	 4x 6047218	 1x 6020146	 5x 6020073	 2x 6133860	 1x 6107282
 2x 6104419	 6x 6022048	 2x 4183981	 3x 6133925	 2x 6133930	 2x 4211150	 1x 6135502
 1x 4646864	 2x 6142402	 2x 362324	 7x 6099728	 1x 6136956	 4x 6138664	 1x 6136842
 2x 4667222	 4x 6133927	 4x 4164073	 4x 6023185	 1x 6133332	 2x 6035547	 1x 6136847
 6x 4129917	 1x 6037658	 4x 4113917	 2x 6003003	 1x 6075208		



Aira

Azari

Emily Jones

Farran

Naida



ELVES



# ELVES







**LEGO**

# ELVES

Forgotten Valley

Cursed Crystal Canyon

Diamond Peaks

Whispering Willows

Driftwood Forest

Sacred Dragon Cove

Shimmering Shore

Crystal River

The land of  
**Elvendale**

Dragon Mountains

**LEGO**

# ELVES

