



40587





Get excited about our new packaging!

We're switching from plastic to paper-based packaging. That's why you might find a mix of paper and plastic in our boxes!

Nos nouveaux emballages vous emballeront !

Nous passons des emballages en plastique aux emballages à base de papier. C'est pourquoi vous pourriez trouver un mélange de papier et de plastique dans nos boîtes !

¡Te presentamos nuestros nuevos empaques!

Estamos sustituyendo las bolsas de plástico por bolsas con base de papel. ¡Por eso, puedes encontrar una mezcla de papel y de plástico en nuestras cajas!

[LEGO.com/sustainable-packaging](https://www.lego.com/sustainable-packaging)



1





2x

2



1x

3

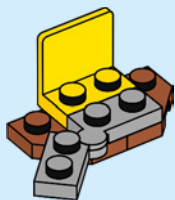



1x

4

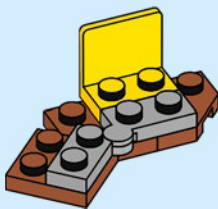

1x

5

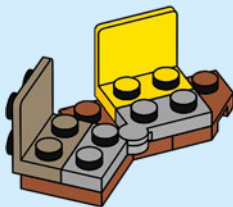



2x

6

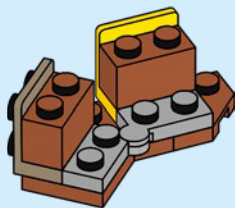

2x



2x

7

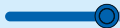
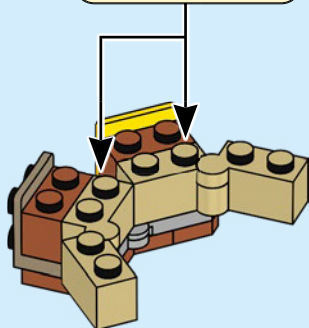
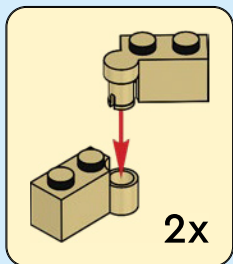



2x



4x



2x



4x



2x



2x



2x

8

1



3

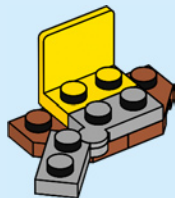

2



4

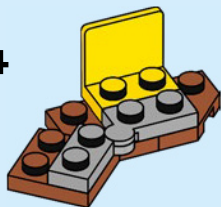

5

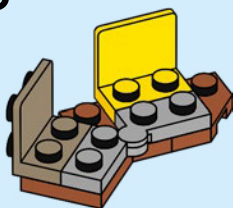

6

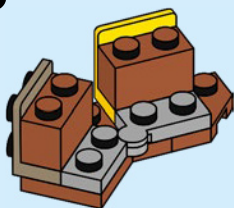

2x

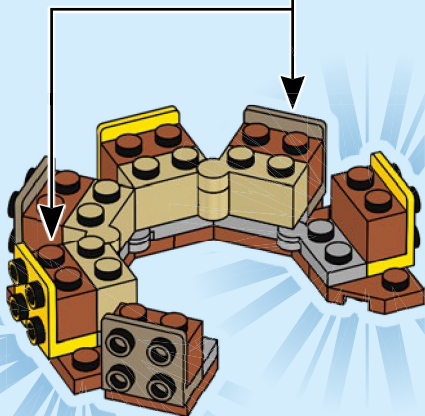



9

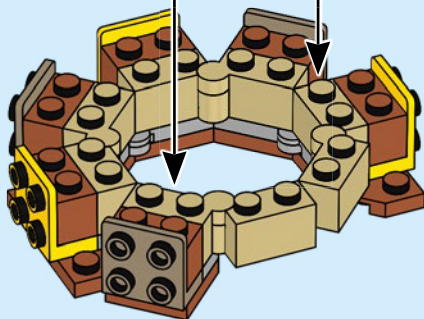
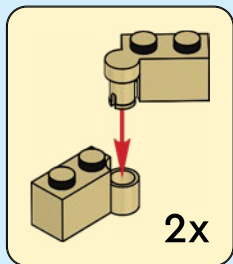



2x



1x



2x



1x



1x



1x

10

1



2



3

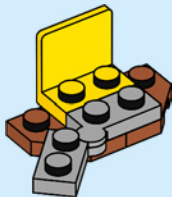

4

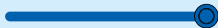
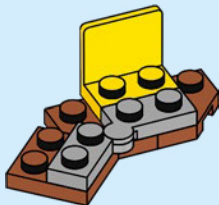

5

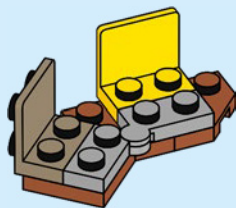

6

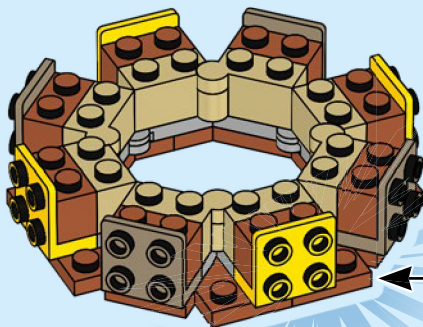
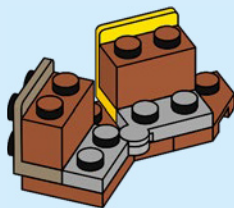



8x

11

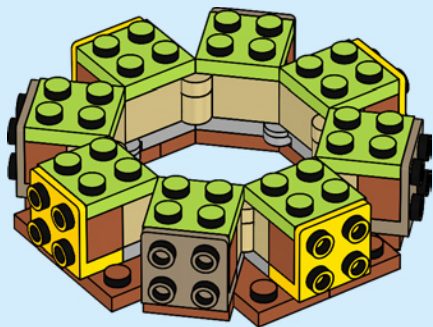

8x

12

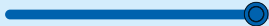
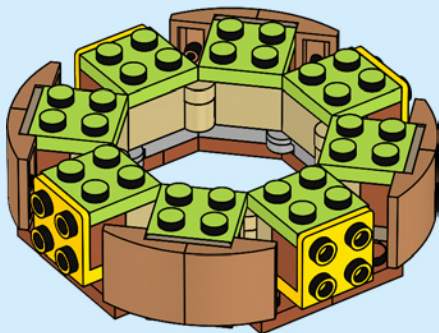



8x

13

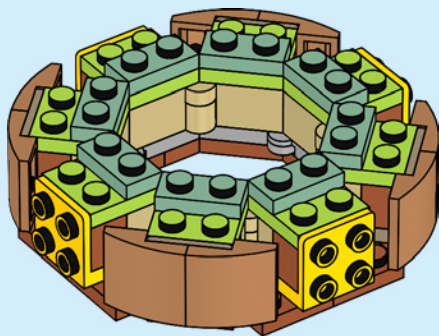

4x

14

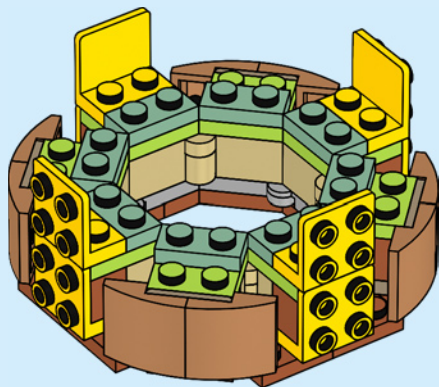



4x

15

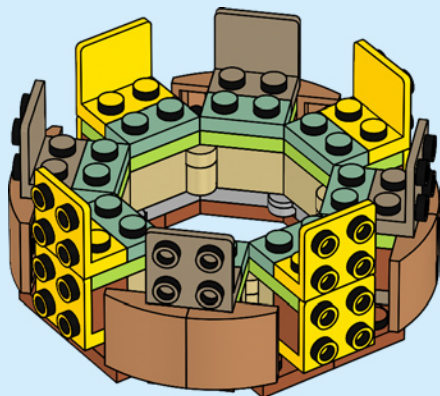

8x

16

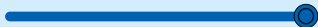
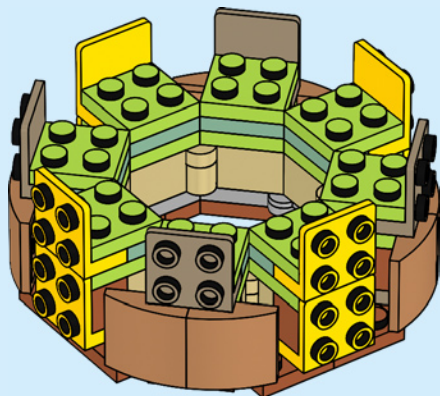



4x

17

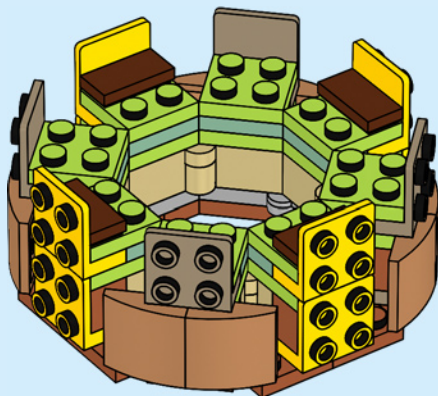

8x



8x

18

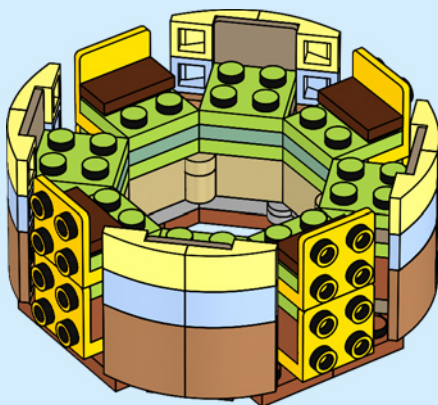



4x

19

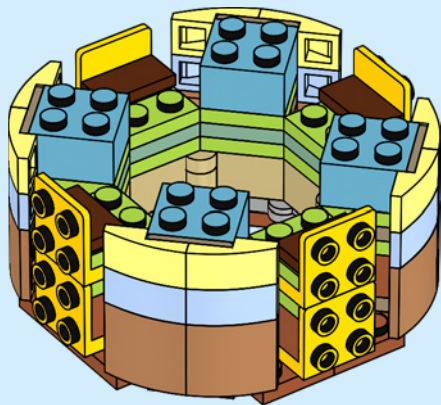

4x



4x

20

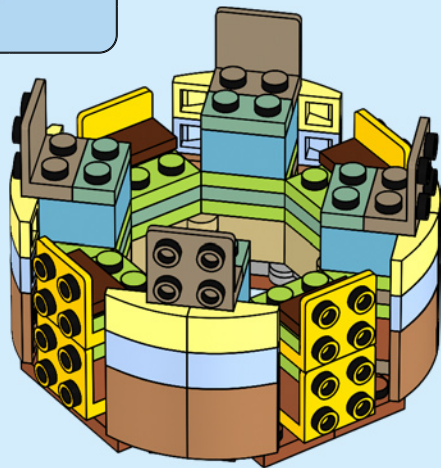

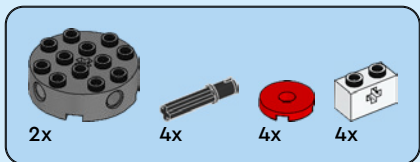
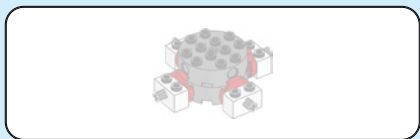

21

1



2

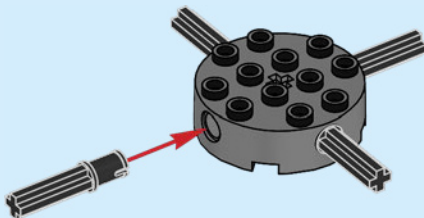

3

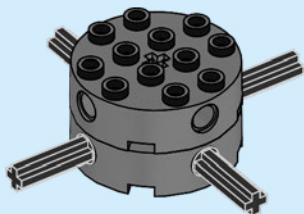

4

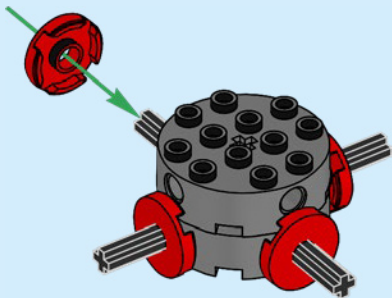

5

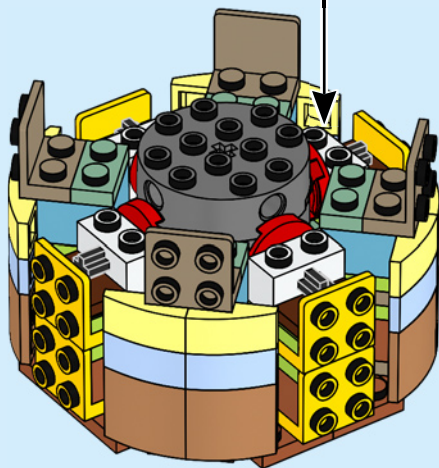
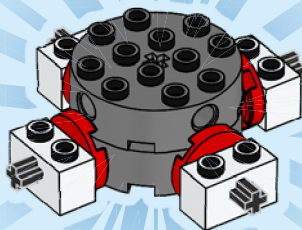



4x

22

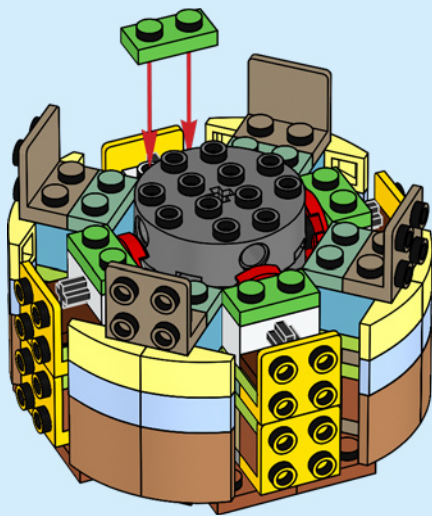



1x

23

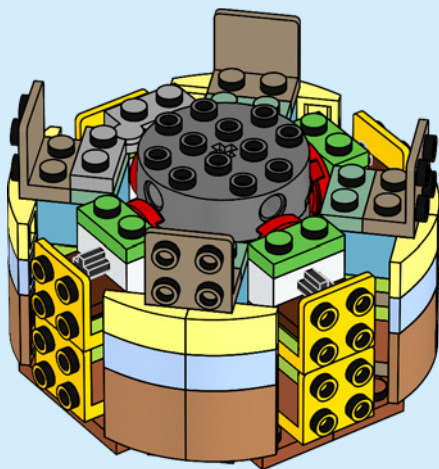



3x

24

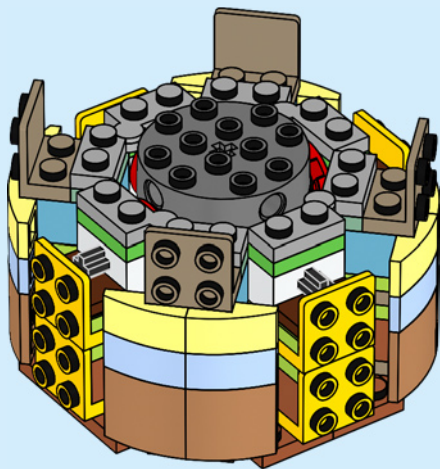



8x

25

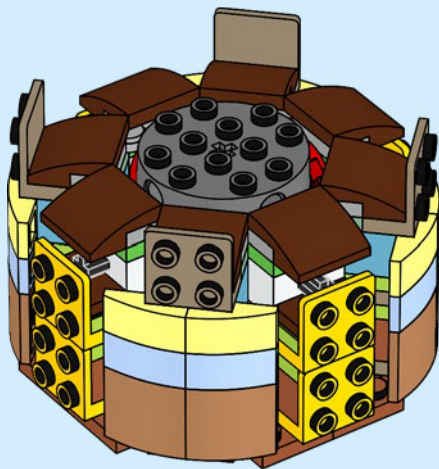



8x

26

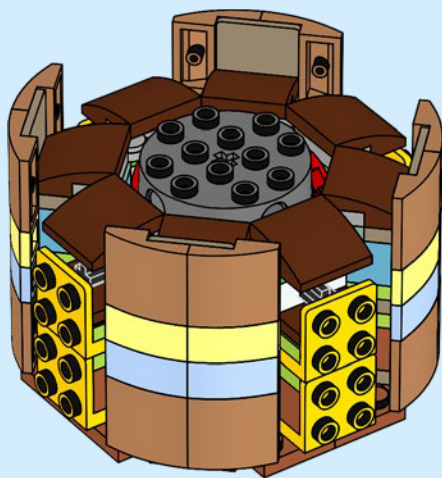

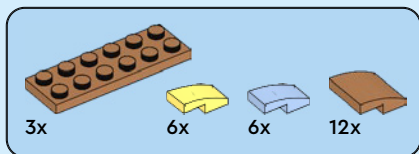

27

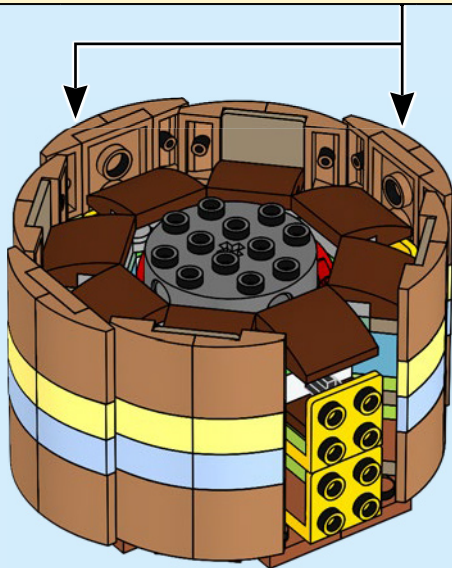
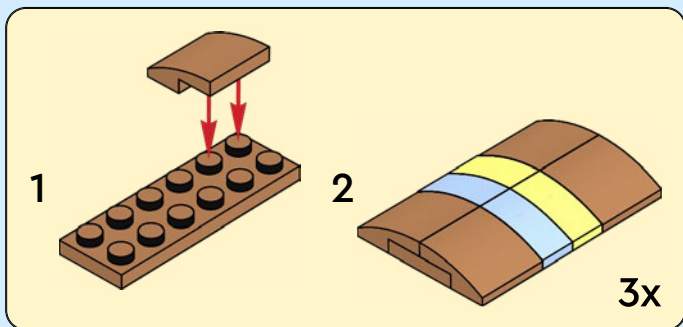

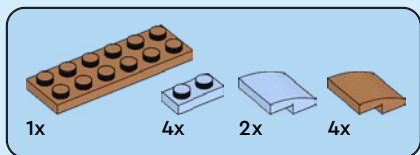

28

1

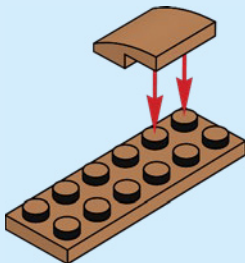

2

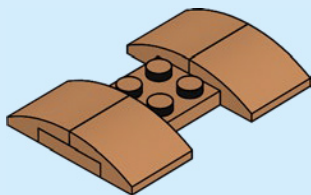

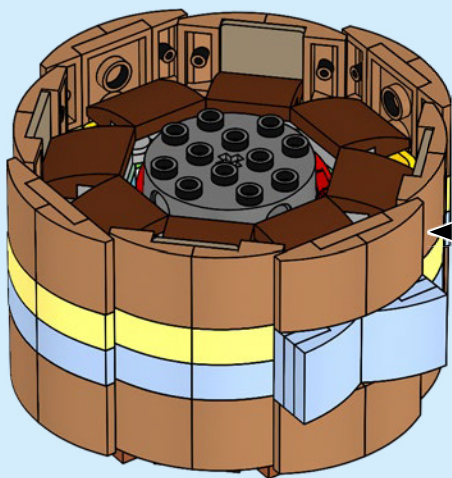
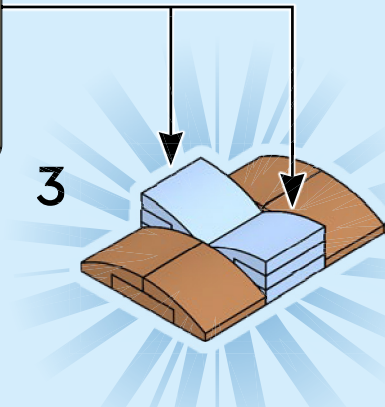
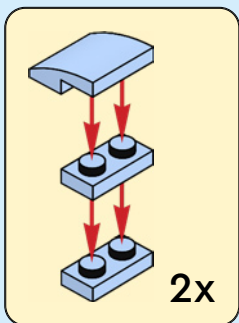

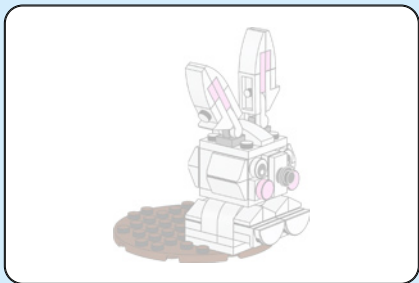

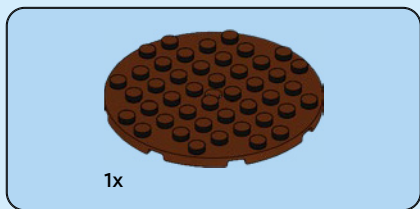

29

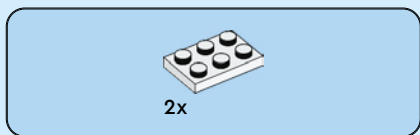
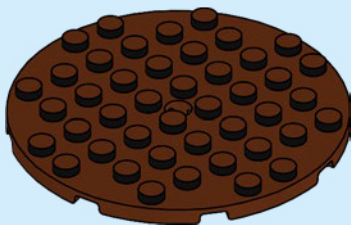

30

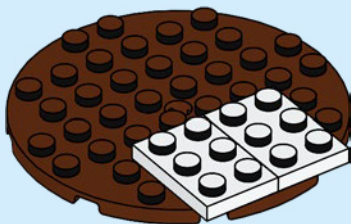



1x



1x



1x



1x

31

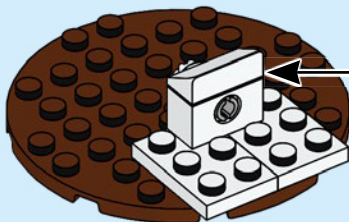

1

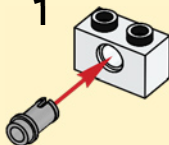

2



2x



1x

32

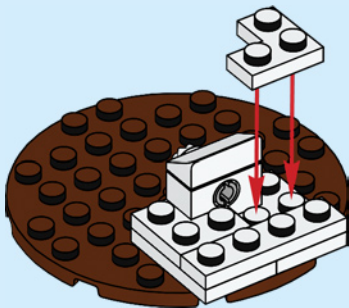

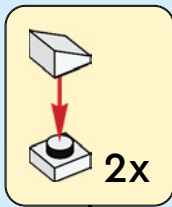
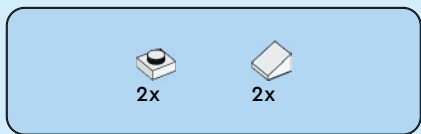

33

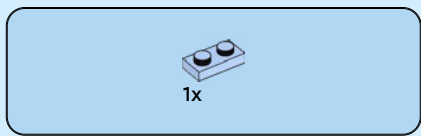
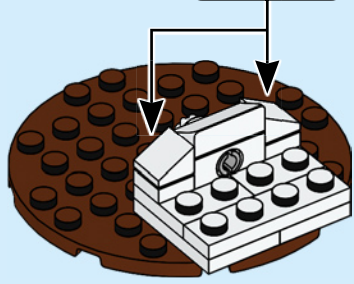

34

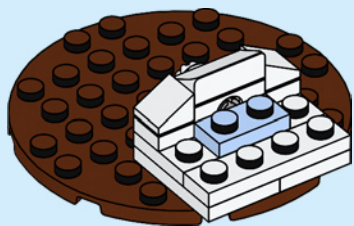



2x

35

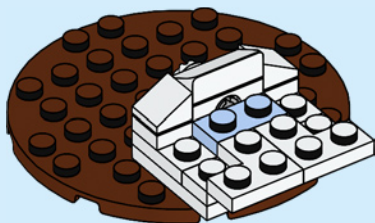

1x

36

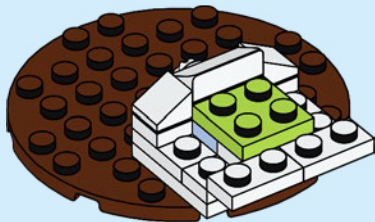



4x

37

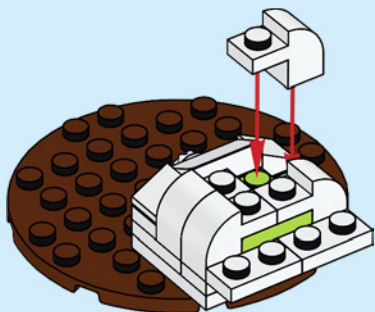

1x



1x

38

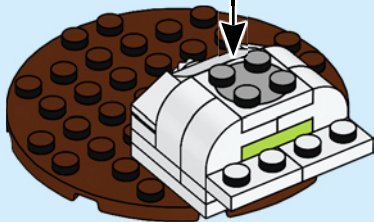
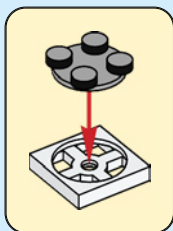



2x



2x

39



2x

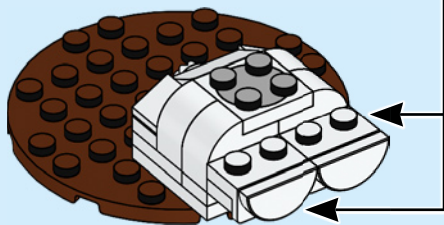

4x

40

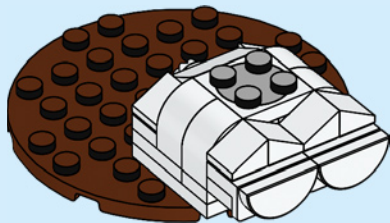

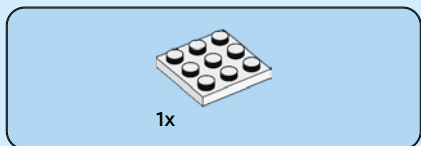
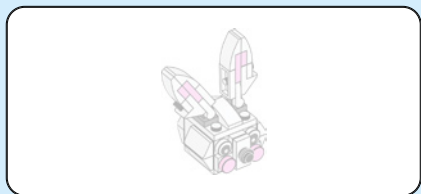

41

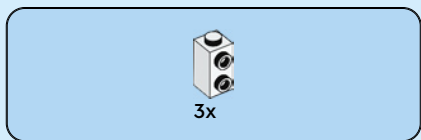

42

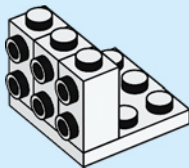

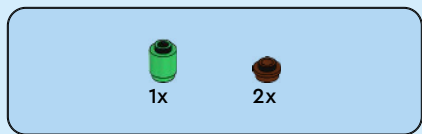

43

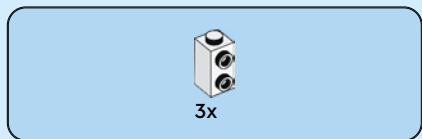
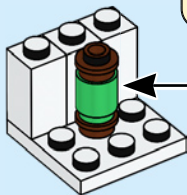
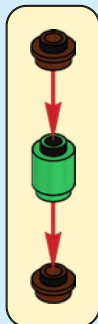
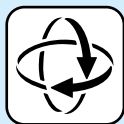

44

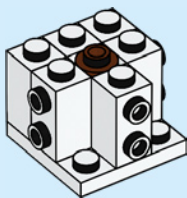



45

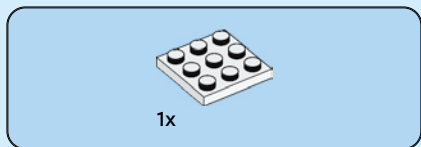
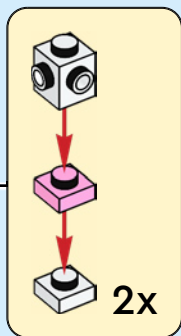
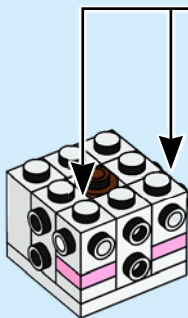

46

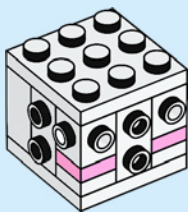



47

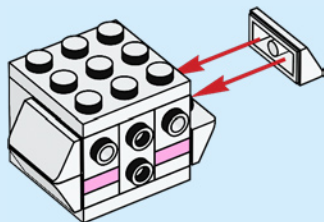

48

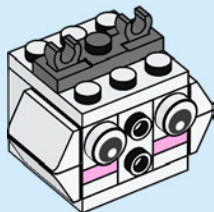



49

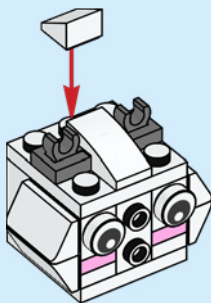

50

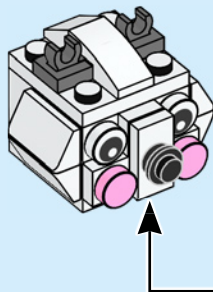

1

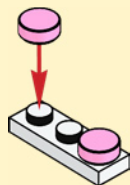

2

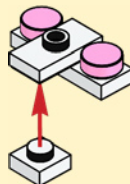

3





2x



2x

51

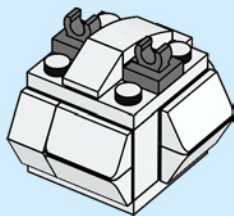

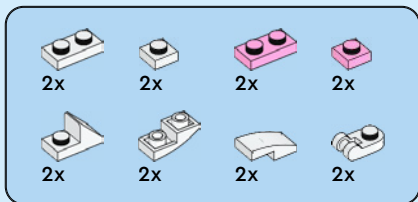

52

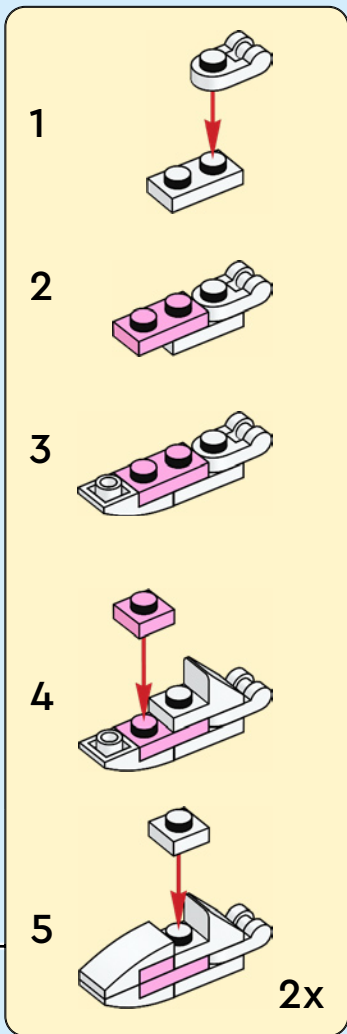
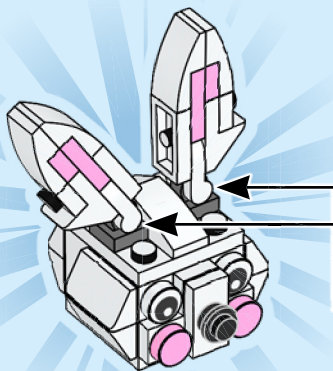
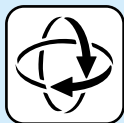

53

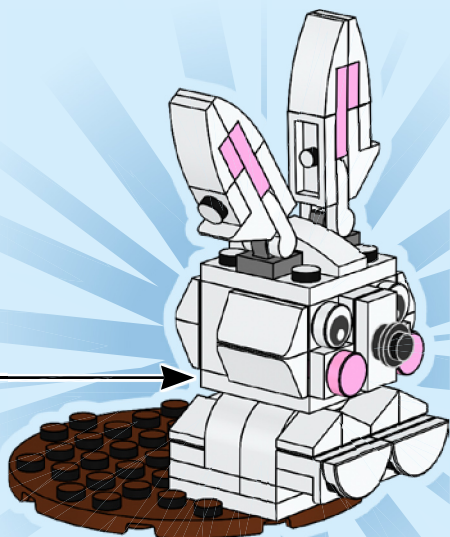

54

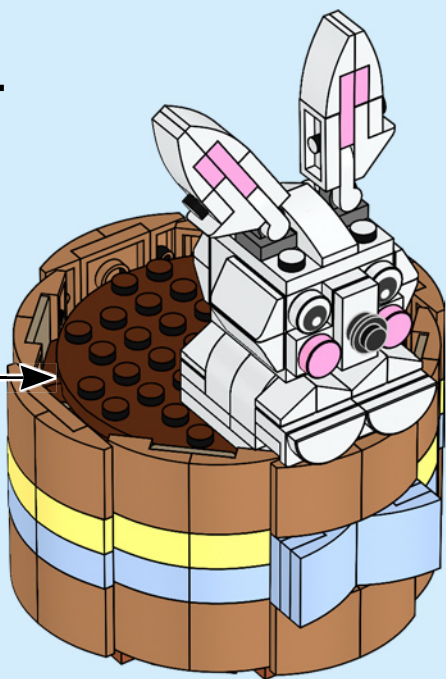



2x



2x

55

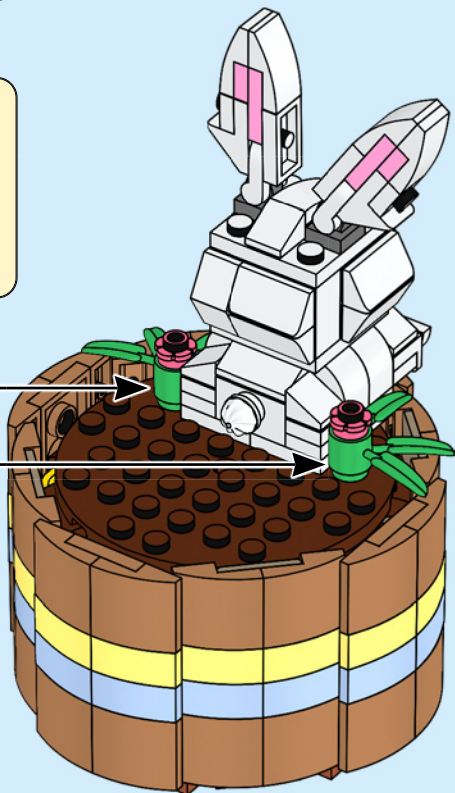
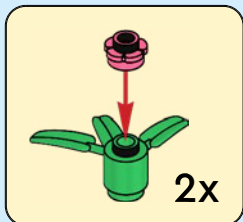
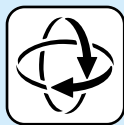

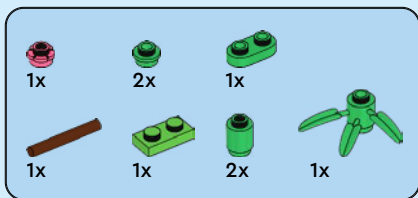

56

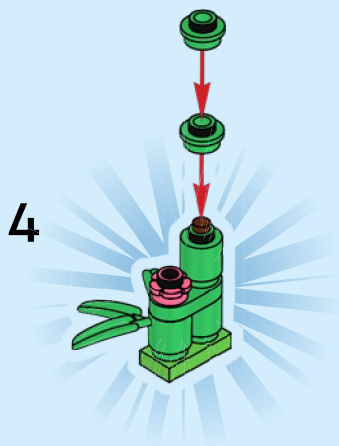
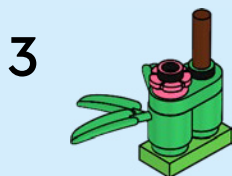
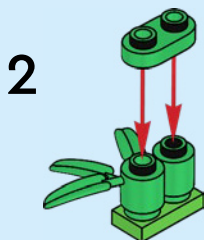
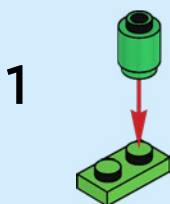

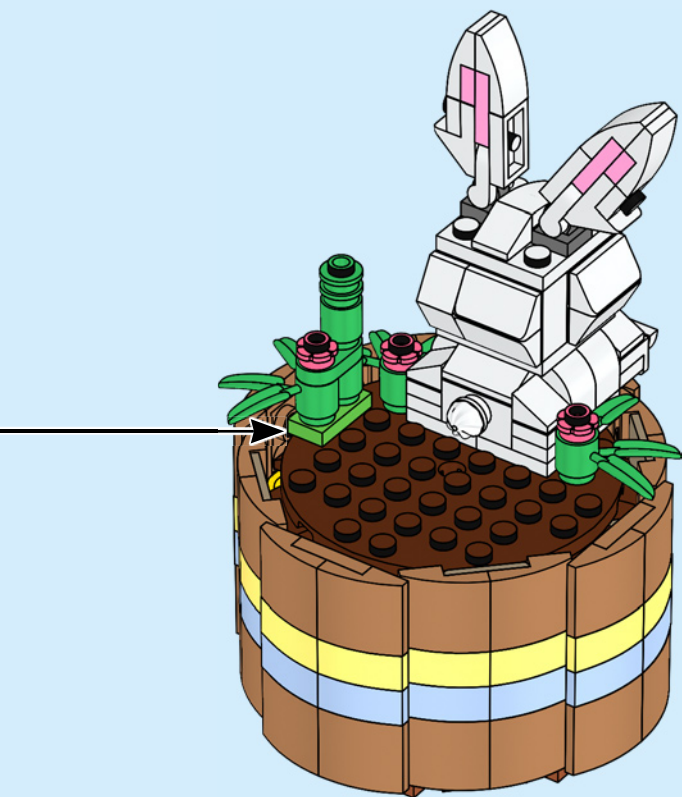

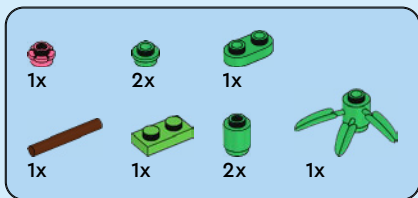

57

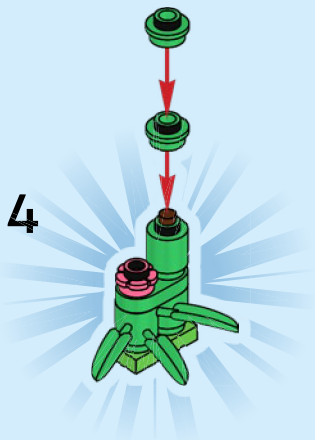
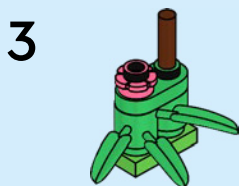
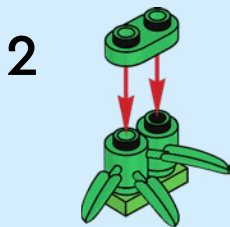
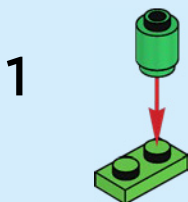

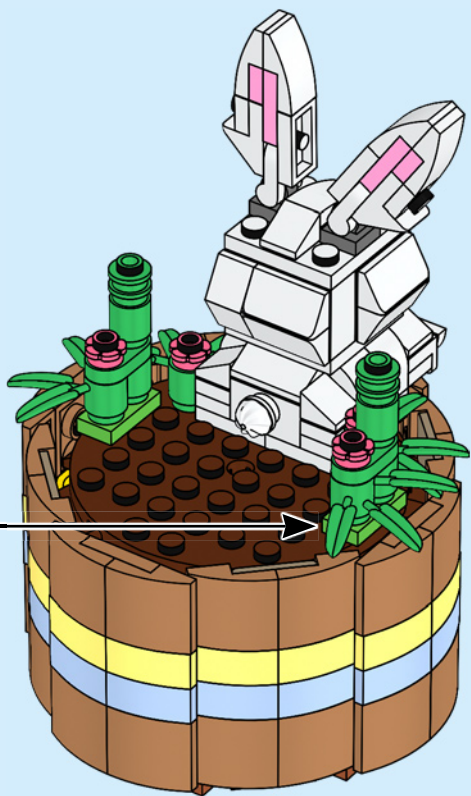

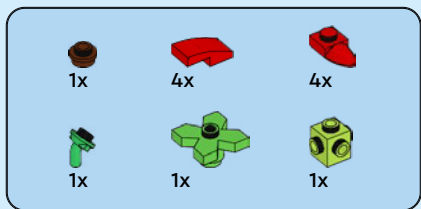

58

1



2

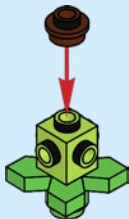

3

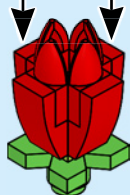

4

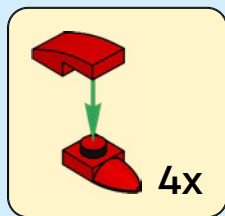
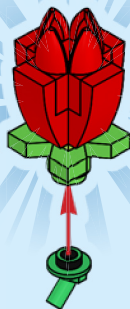

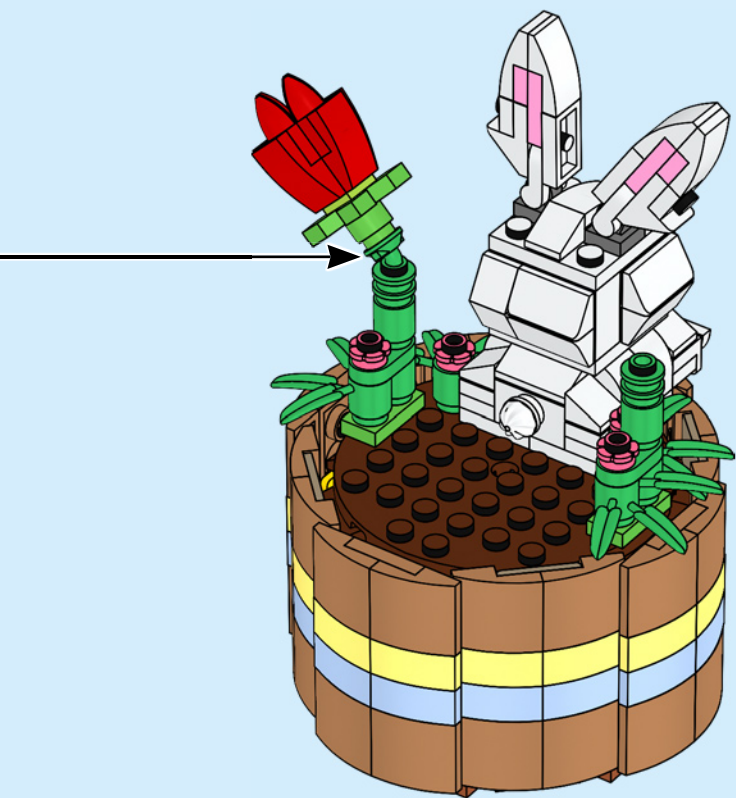

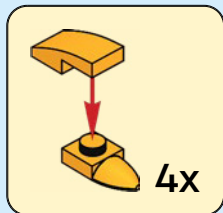
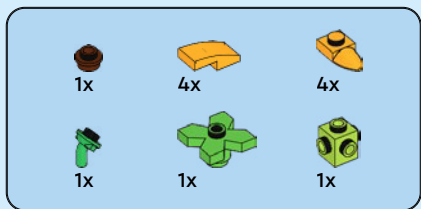

59

1



2

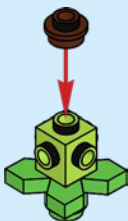

3

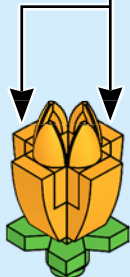

4

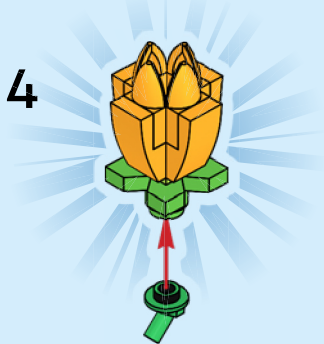

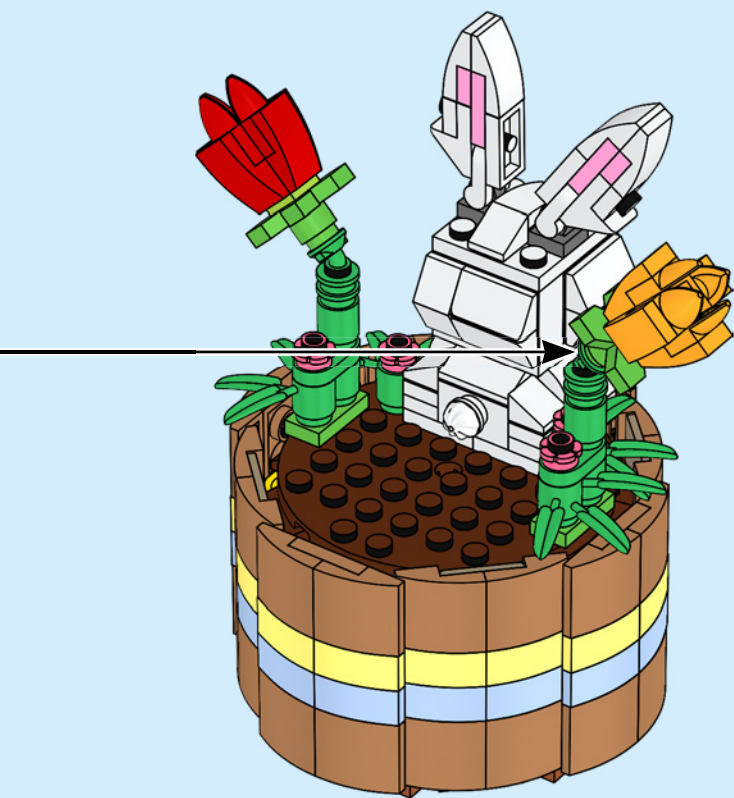



4x



2x

60



2x

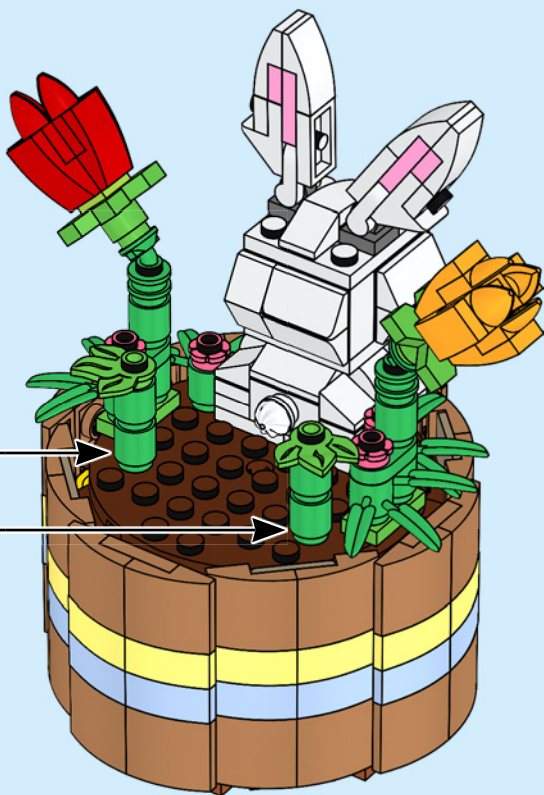

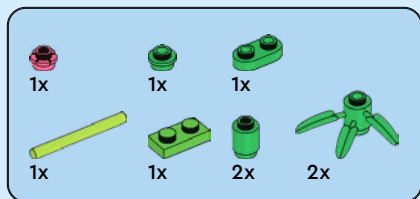

61

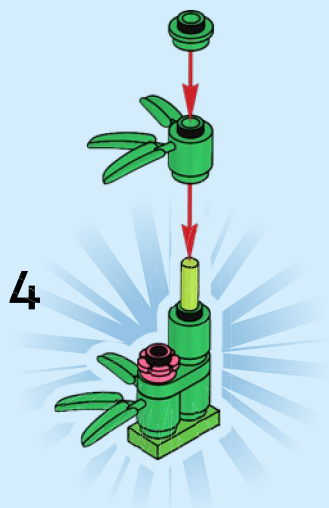
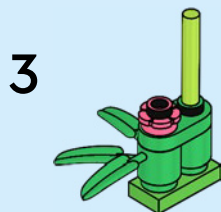
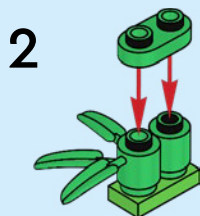
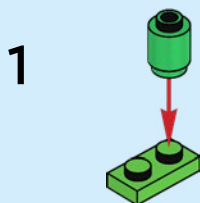



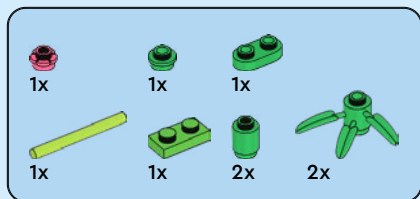

62

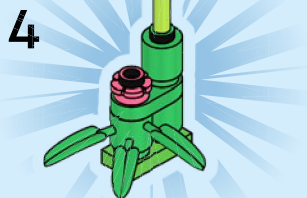
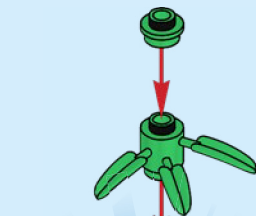
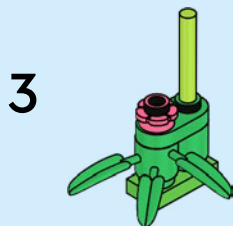
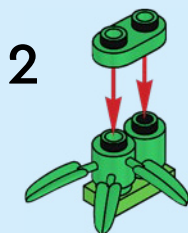
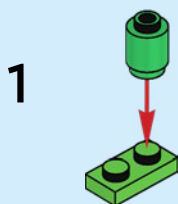





1x



1x



1x

63

1

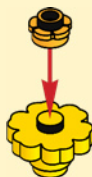

2





1x



1x



1x

64

1

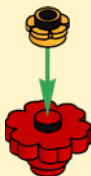

2

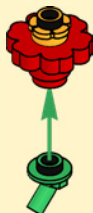

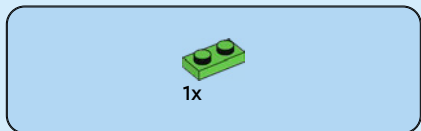

65

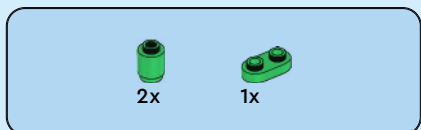
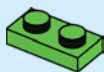

66

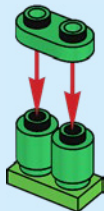

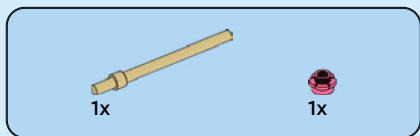

67

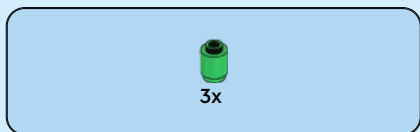
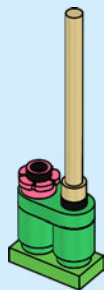

68

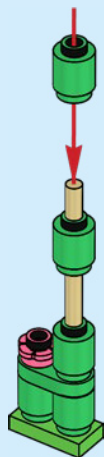



1x

69

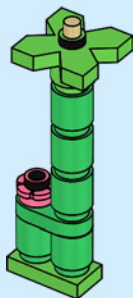

1x



1x

70





4x



4x

71

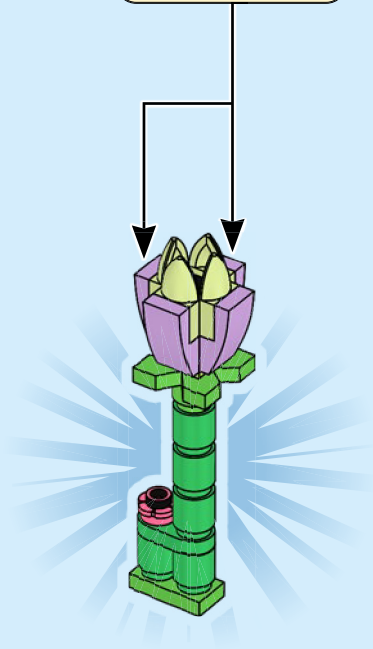
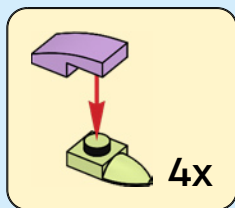

72





2x
6284599

2x
6172927

4x
6285777

1x
614126

3x
6174006

1x
6102794

1x
6051511

2x
6018774

4x
6089119

17x
4537937

6x
6218841

2x
302301

4x
6364438

4x
6382575

2x
6327442

7x
302401

3x
6034044

4x
6334219

18x
306228

1x
4211483

9x
4504369

2x
6400114

1x
6254770

6x
6338221

1x
4540203

2x
6224811

4x
242001

5x
6210271

8x
6416524

2x
6174937

1x
368001

1x
6000020

8x
6270003

2x
6209681

7x
4547489

1x
362301

4x
6102138

2x
6182261

4x
4282860

4x
6178921

2x
302101

4x
6029946

9x
6343326

4x
6099728

1x
370001

1x
371001

4x
6078640

3x
4143562

4x
6267420

2x
6069002

2x
6104805

1x
6000022

12x
6330148

14x
6147726

8x
6208753

12x
4655080

4x
6097647



8x
4579659



8x
6228840



4x
4615606



32x
6312473



4x
6313600



1x
6365692



2x
4211097



2x
6428805



8x
6146858



1x
6409901



5x
6215659



4x
4211151



4x
4653970



14x
6335524



5x
6362254



2x
6372227



2x
6284587



4x
6031883



2x
4654128



7x
6295242

YOU COULD

WIN



Scan this QR code or go to
LEGO.COM/PRODUCTFEEDBACK
and give us your short feedback
about this LEGO® set for a chance
to win a cool LEGO prize.

Terms and Conditions apply*

DE: Du könntest GEWINNEN. Es gelten die Teilnahmebedingungen* **FR: Tu pourrais GAGNER.** Des conditions s'appliquent* **IT: Potresti VINCERE tu.** Termini e condizioni sono applicabili* **ES: Puedes GANAR.** Aplican términos y condiciones* **PT: Poderá GANHAR.** Aplicam-se termos e condições* **JA: プレゼント付き! 利用規約が適用されます*** **ZH: 轻松获奖. 条款和条件适用*** **KO: 상품의 주인이 되어보세요. 소정의 약관이 적용됩니다*** **RU: Вы можете ВЫИГРАТЬ.** Действуют положения и условия* **PL: Szansa na WYGRANĄ.** Obowiązują warunki korzystania* **CS: Máte šanci VYHRÁT.** Platí všeobecné smluvní podmínky* **SK: Máte šancu VYHRÁŤ.** Platia všeobecné zmluvné podmienky* **HU: TE IS NYERHETSZ.** Felhasználási feltételek érvényesek* **RO: Ai putea CÂȘTIGA.** Se aplică termeni și condiții* **BG: Можете да СПЕЧЕЛИТЕ.** Има определени правила и условия* **LV: Tu vari LAIMĒT.** Ir spēkā noteikumi un nosacījumi.* **ET: Sul on võimalus VÕITA.** Kehtivad tingimused* **LT: Jūs galite LAIMĖTI.** Taikomos sąlygos*

*[LEGO.com/productfeedback-terms](https://www.lego.com/productfeedback-terms)