

LEGO

LEGOLAND

40115

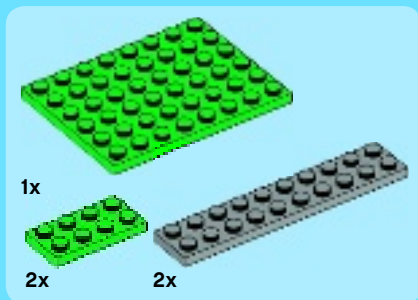



1

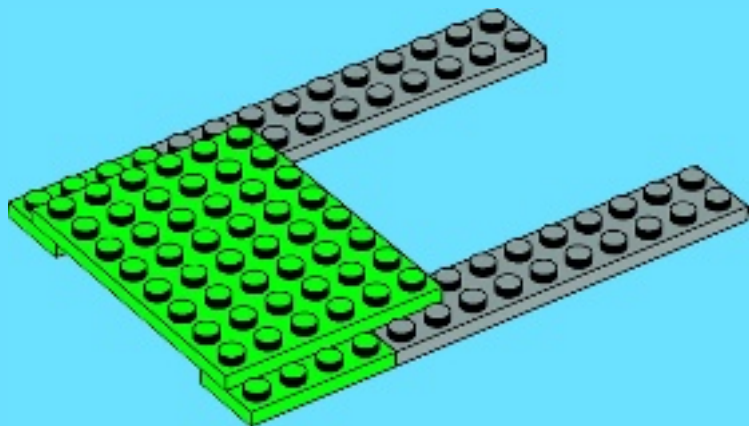

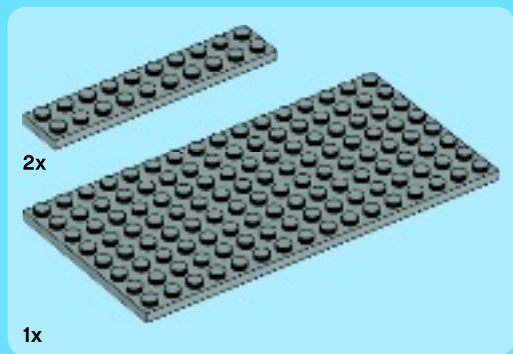

2

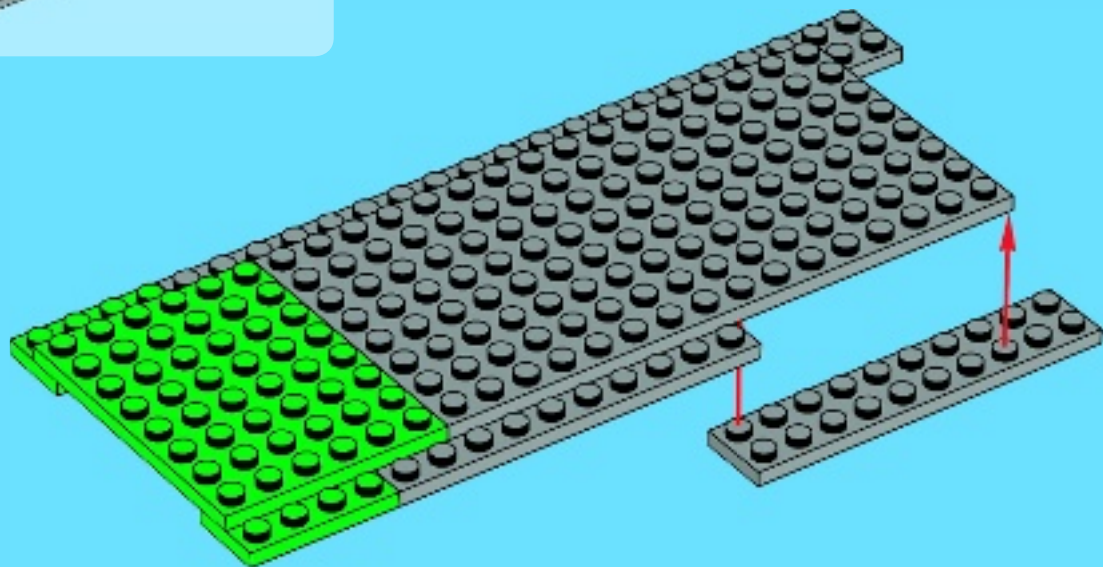

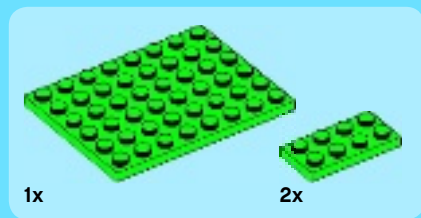

3

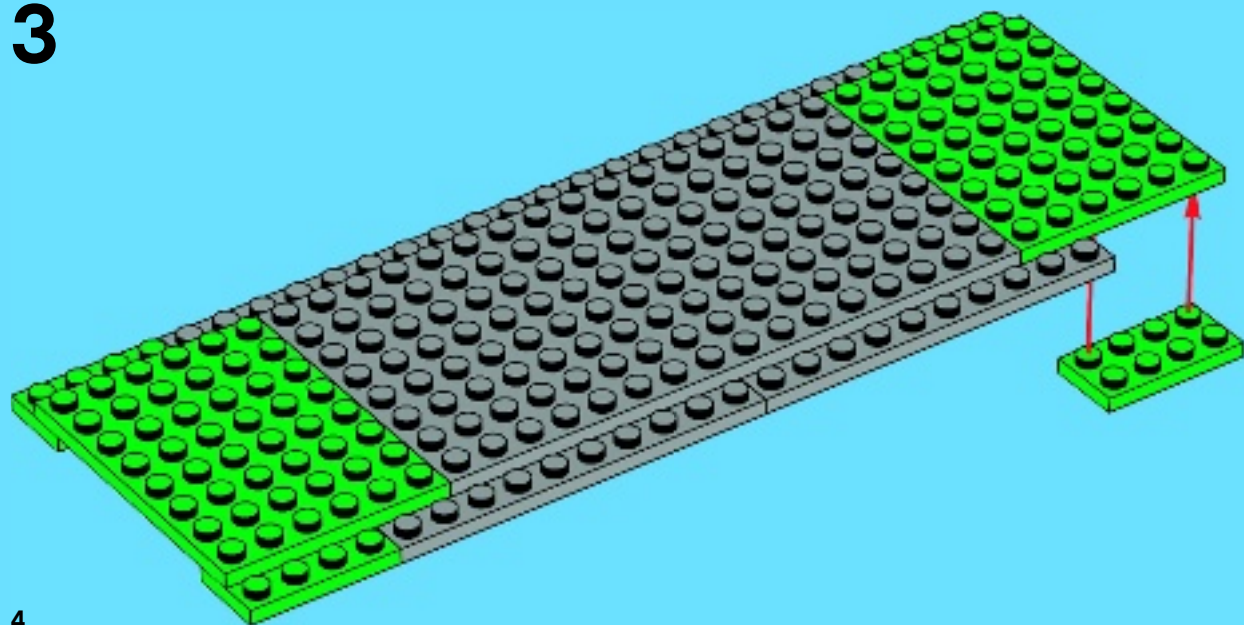

4



4x



2x

4

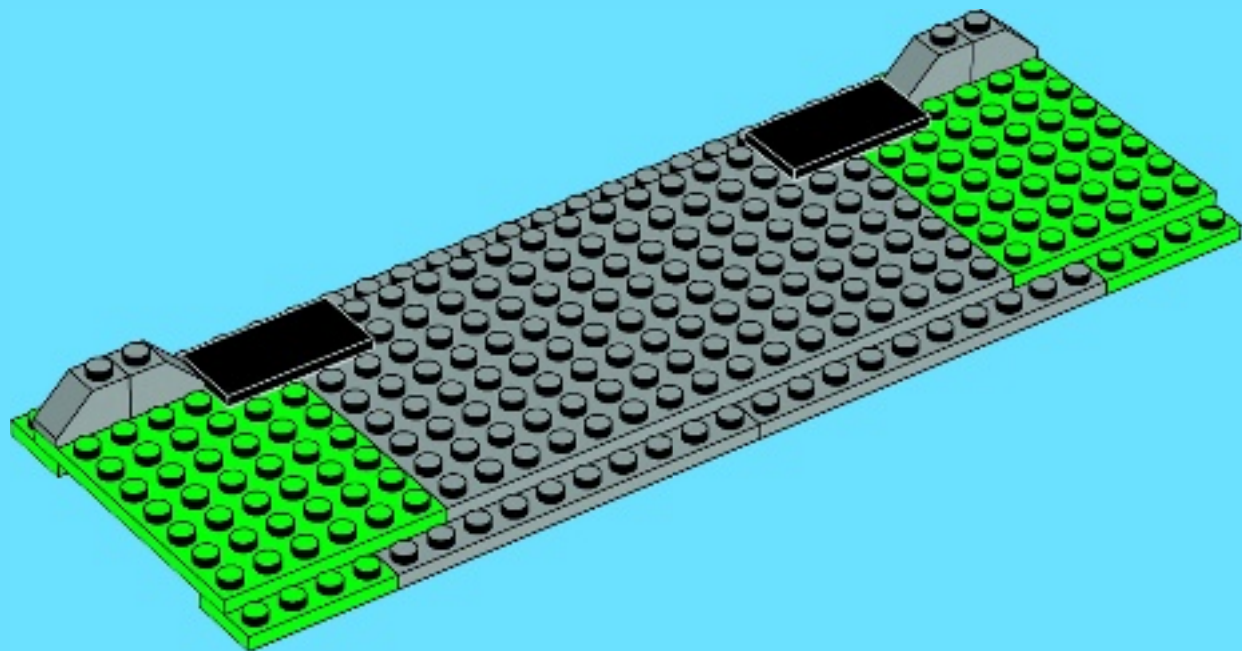

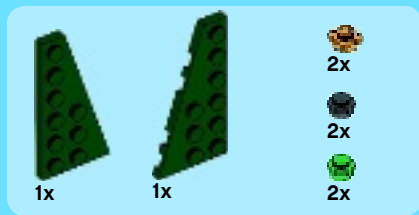

5

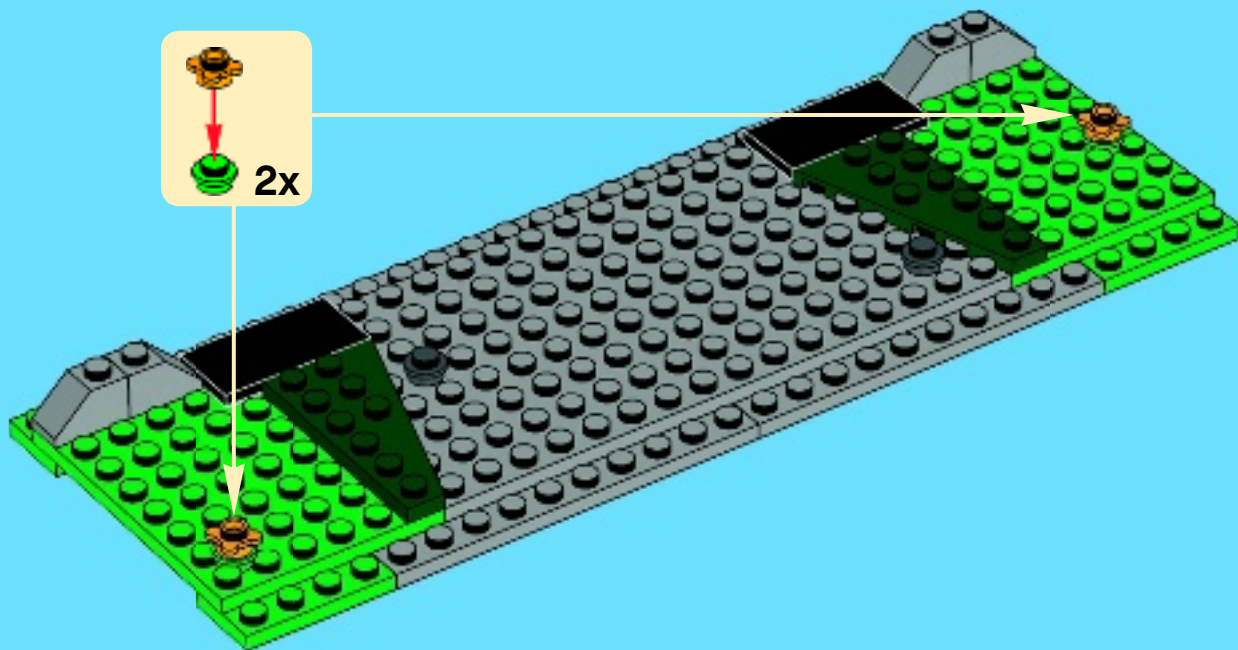
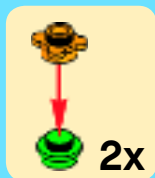

6

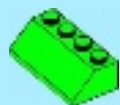

2x



2x



2x

6

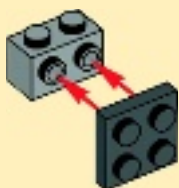

2x

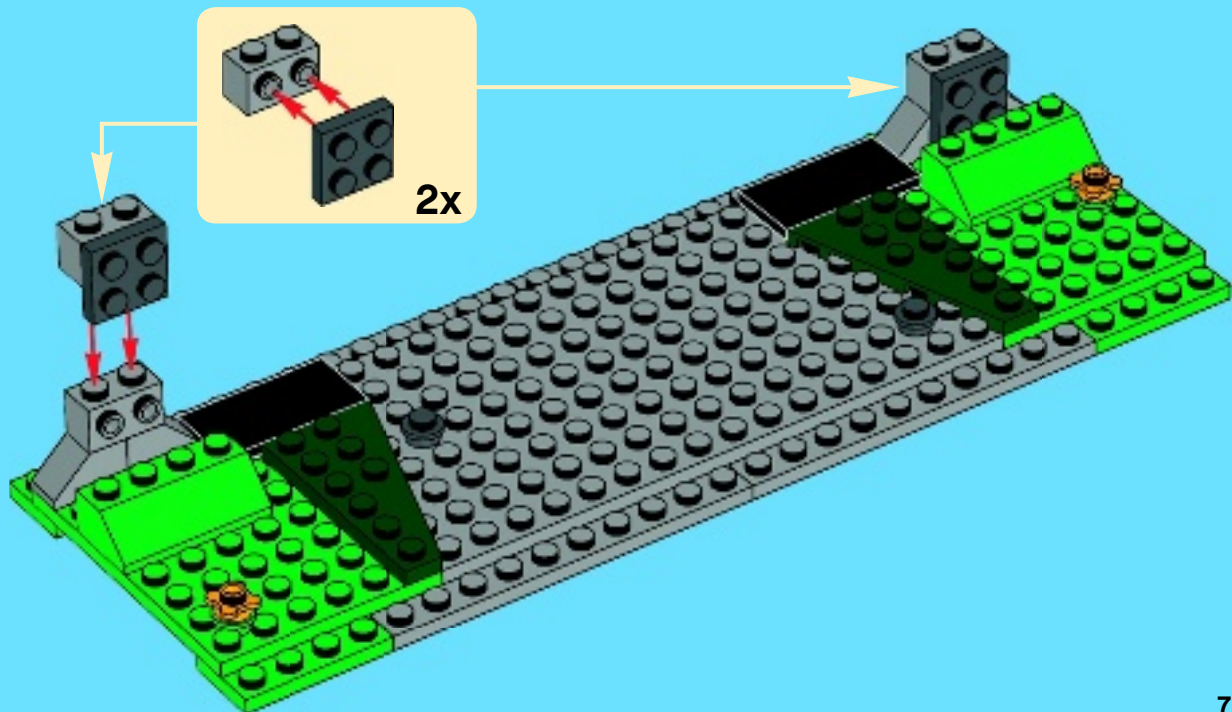



2x



2x



1x



2x

7

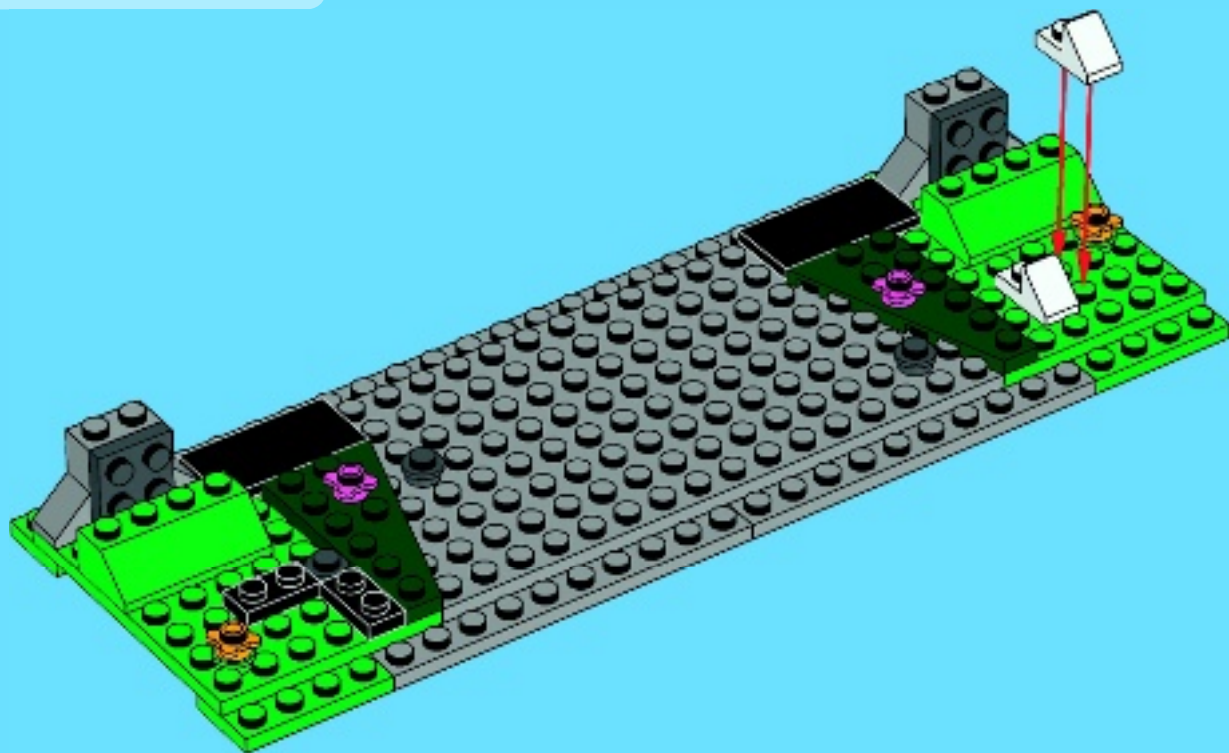

8



1x



2x



2x



2x

8

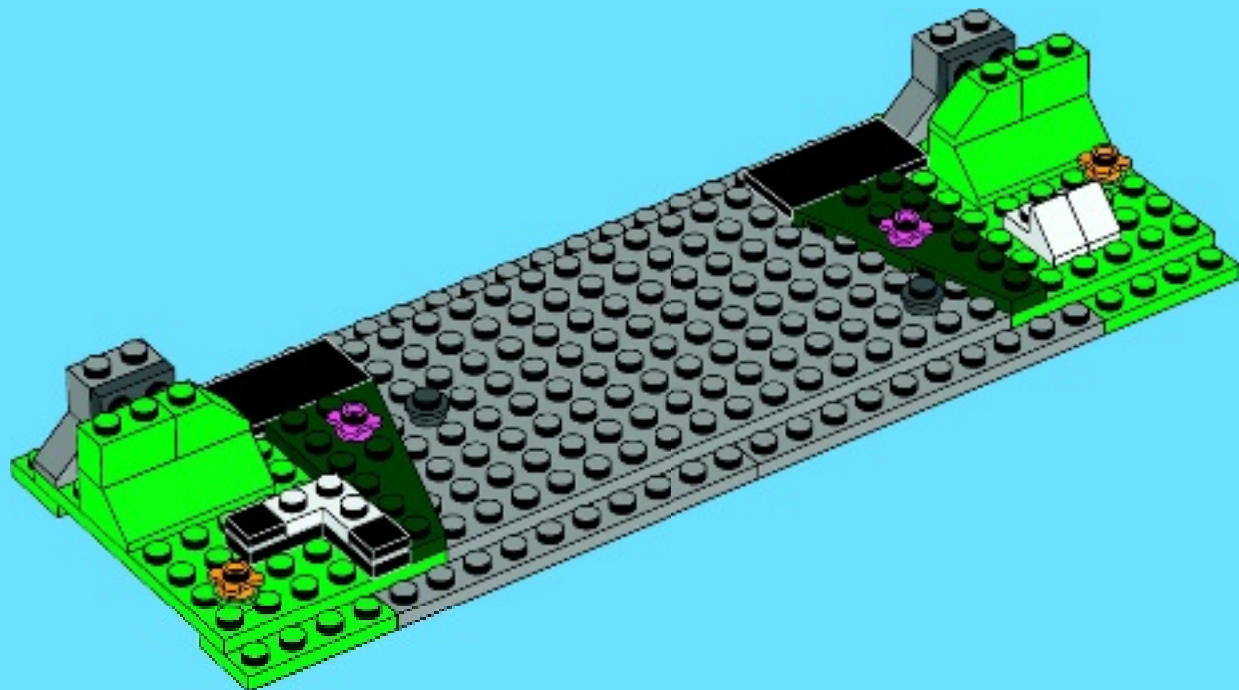



2x



1x

9

1



2

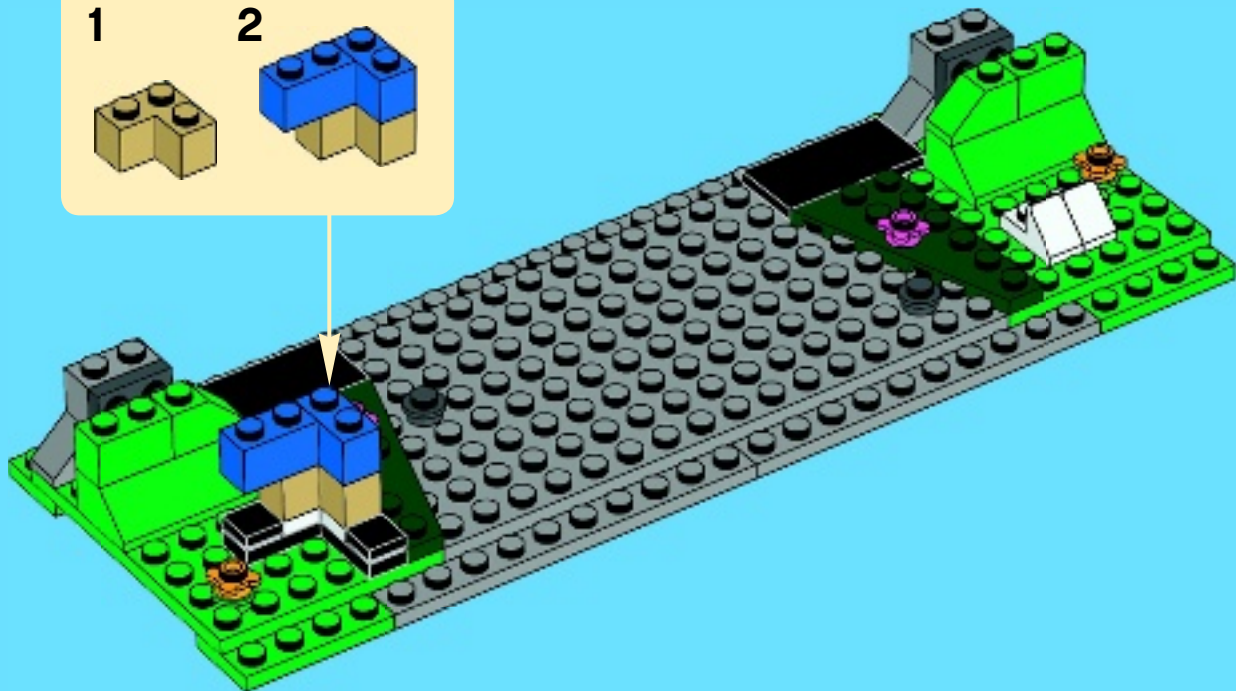
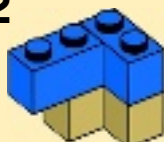



1



2



3

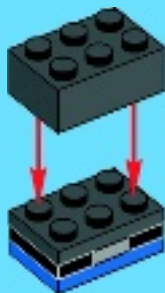

4



5



6





7

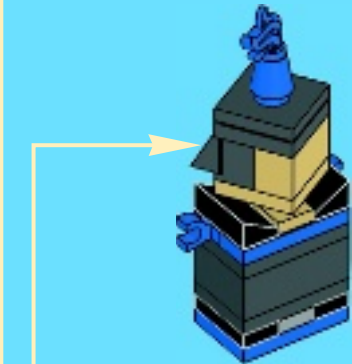
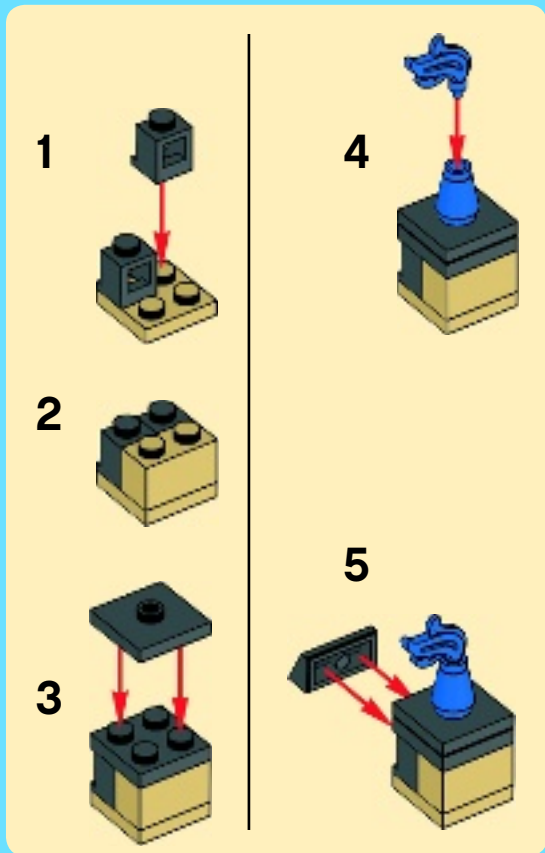

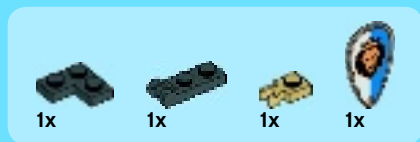

8

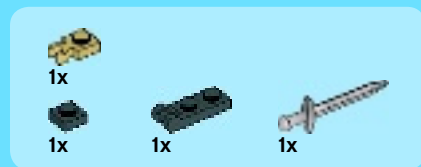
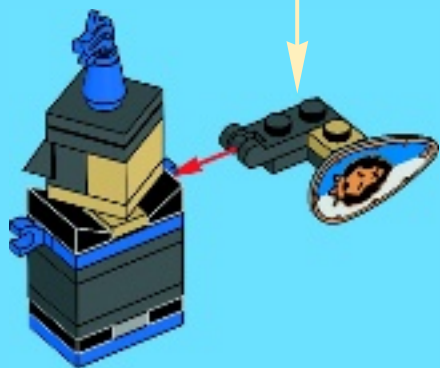
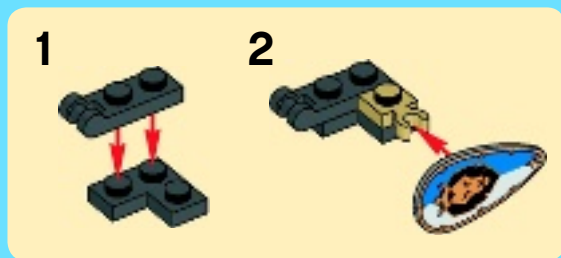

9

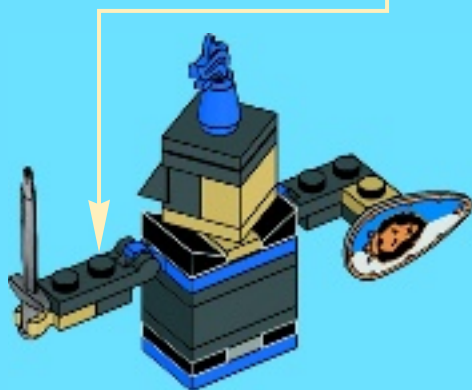
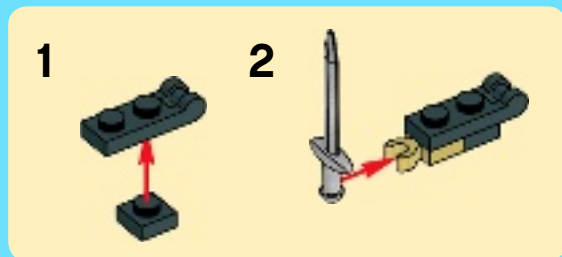

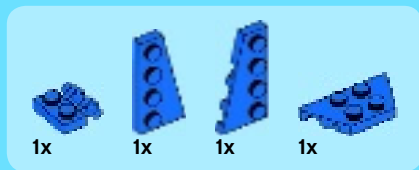

10

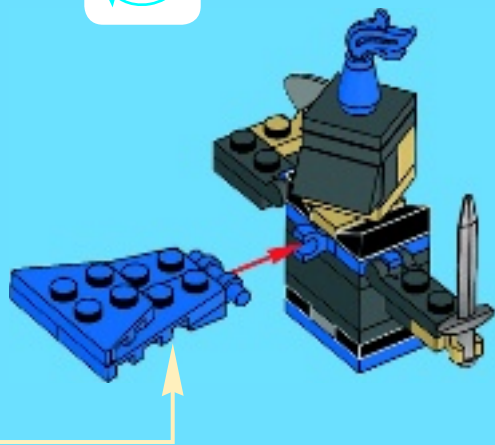
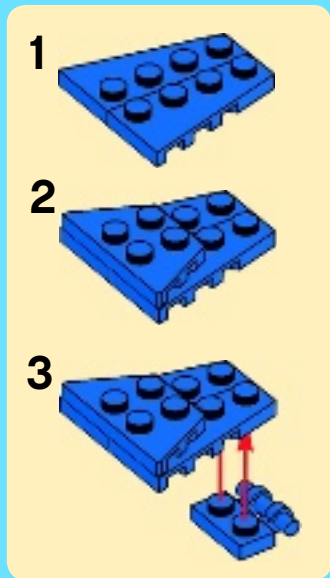

11





1x

1



2x



1x

2



1x

3



2x



1x



1x

4



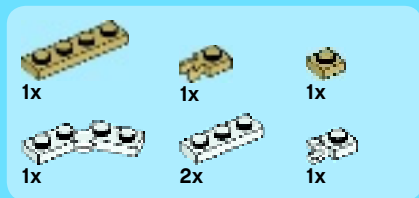

5

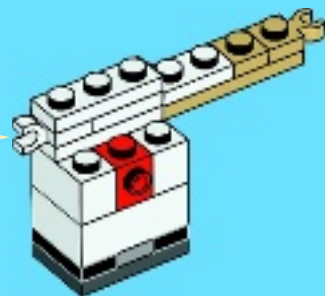
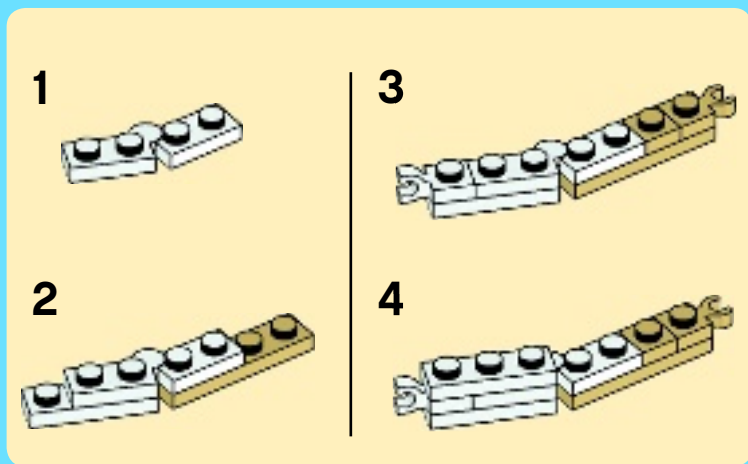



1x

6

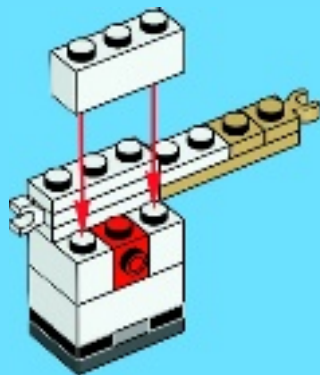

1x



1x



1x

7

1

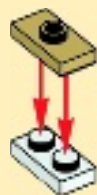

2

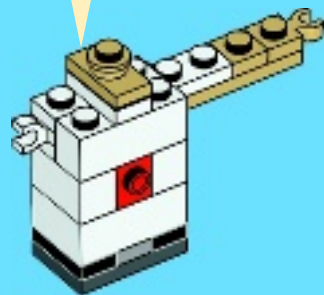



2x



1x

8

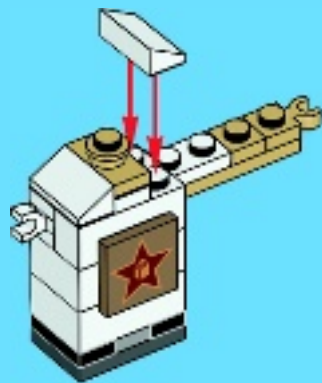

1x



1x



1x

9

1



2

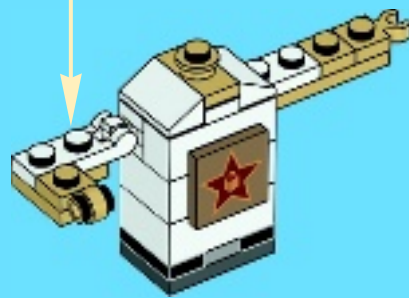



10

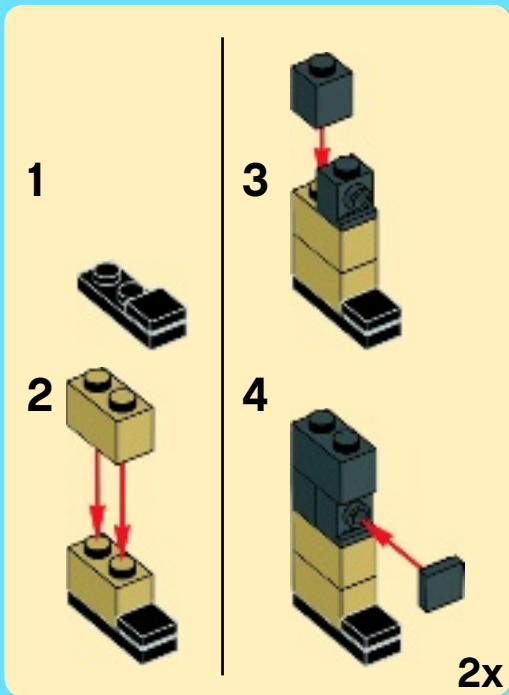
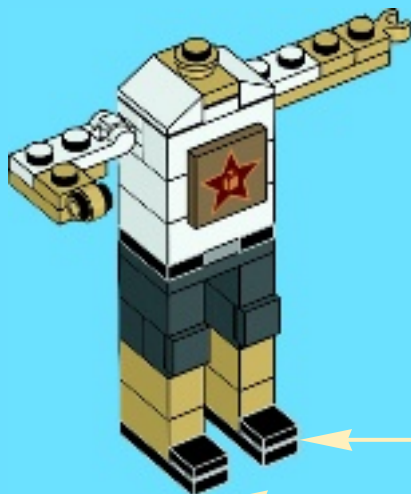

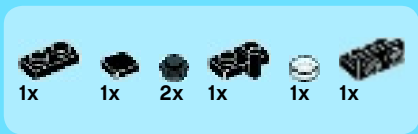

11

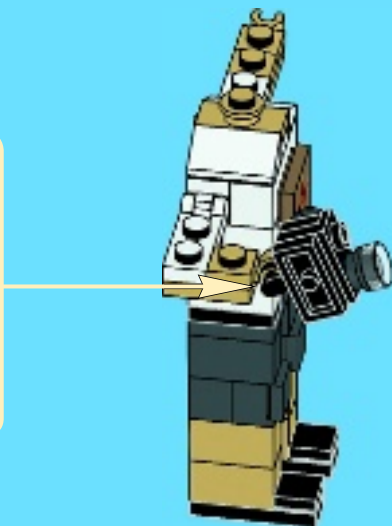
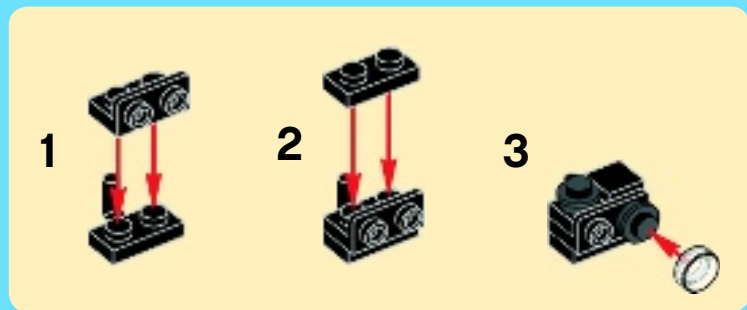

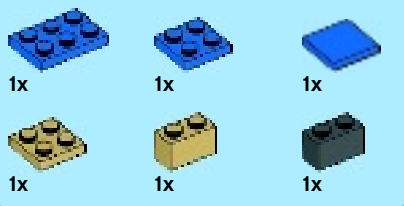

12

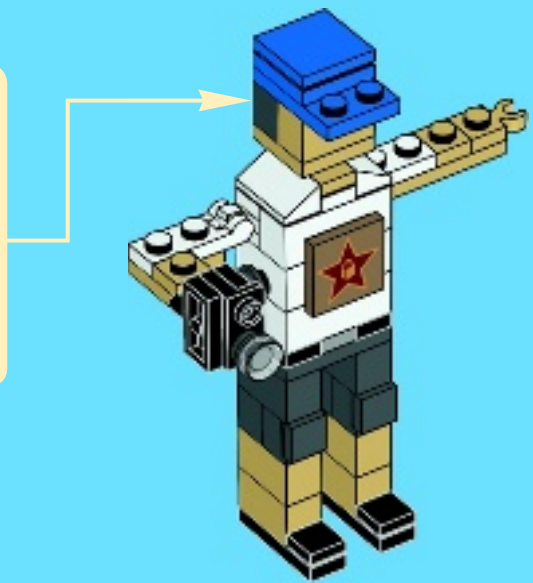
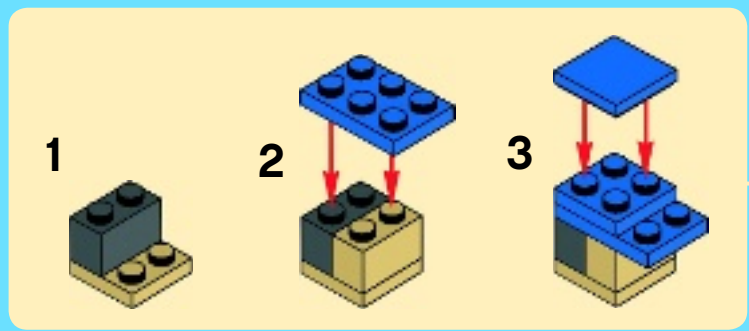

13

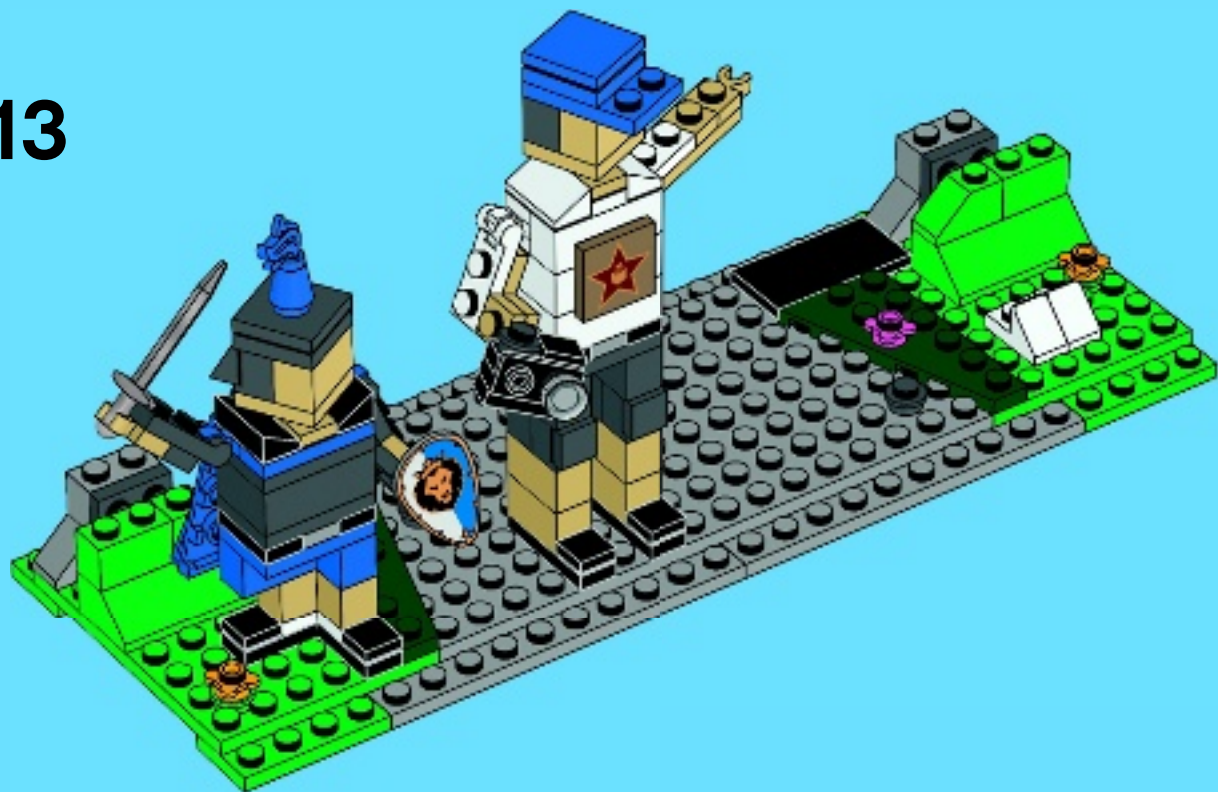



1x



2x



2x

14

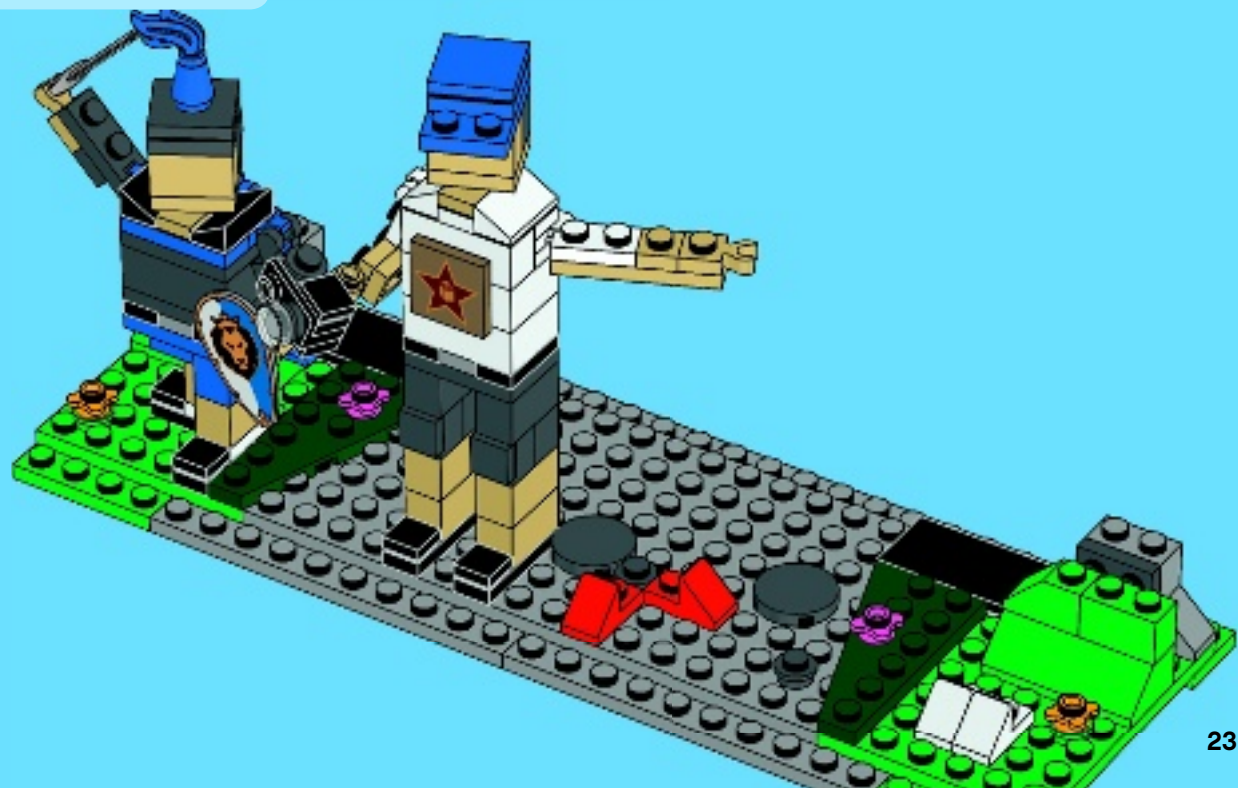



1x



2x



2x

15

1



3



2



4

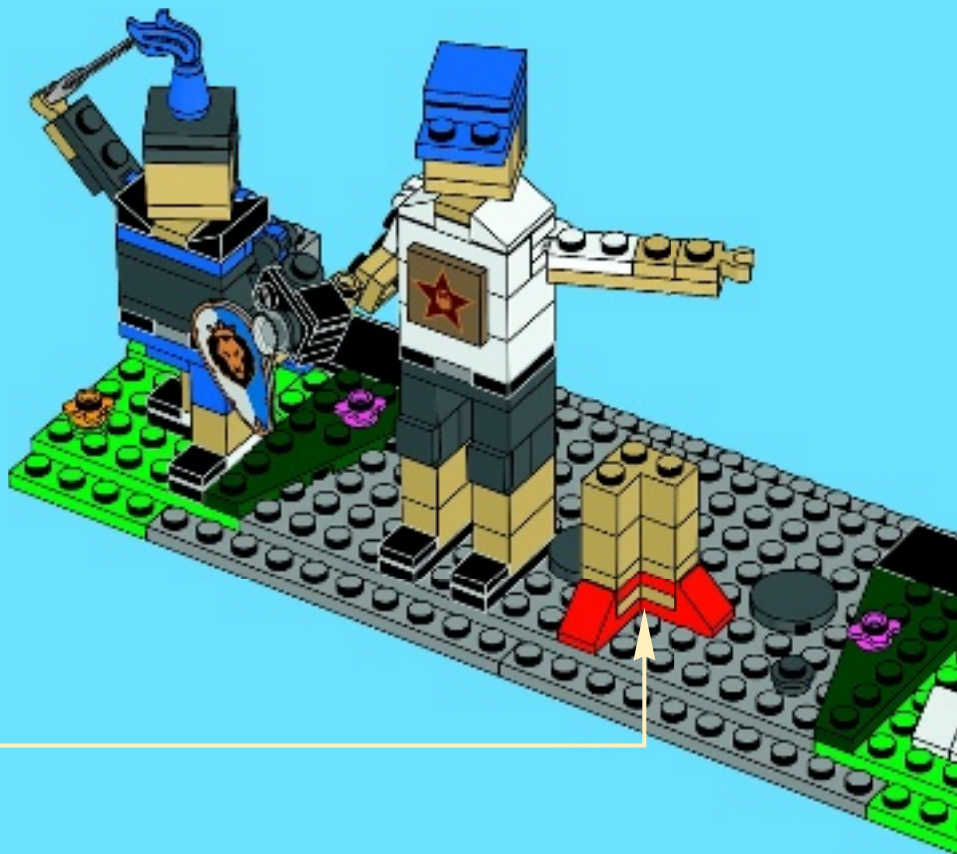

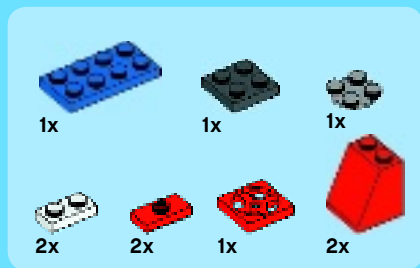

16

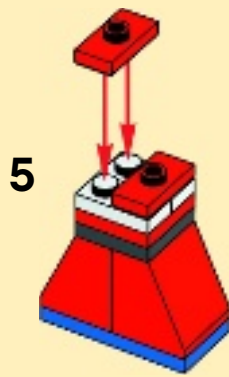
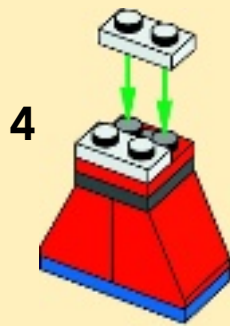
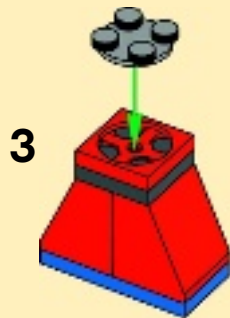
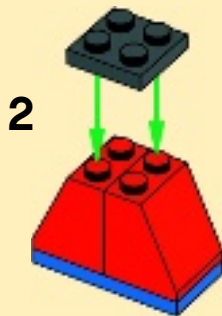
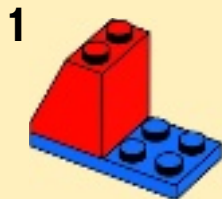

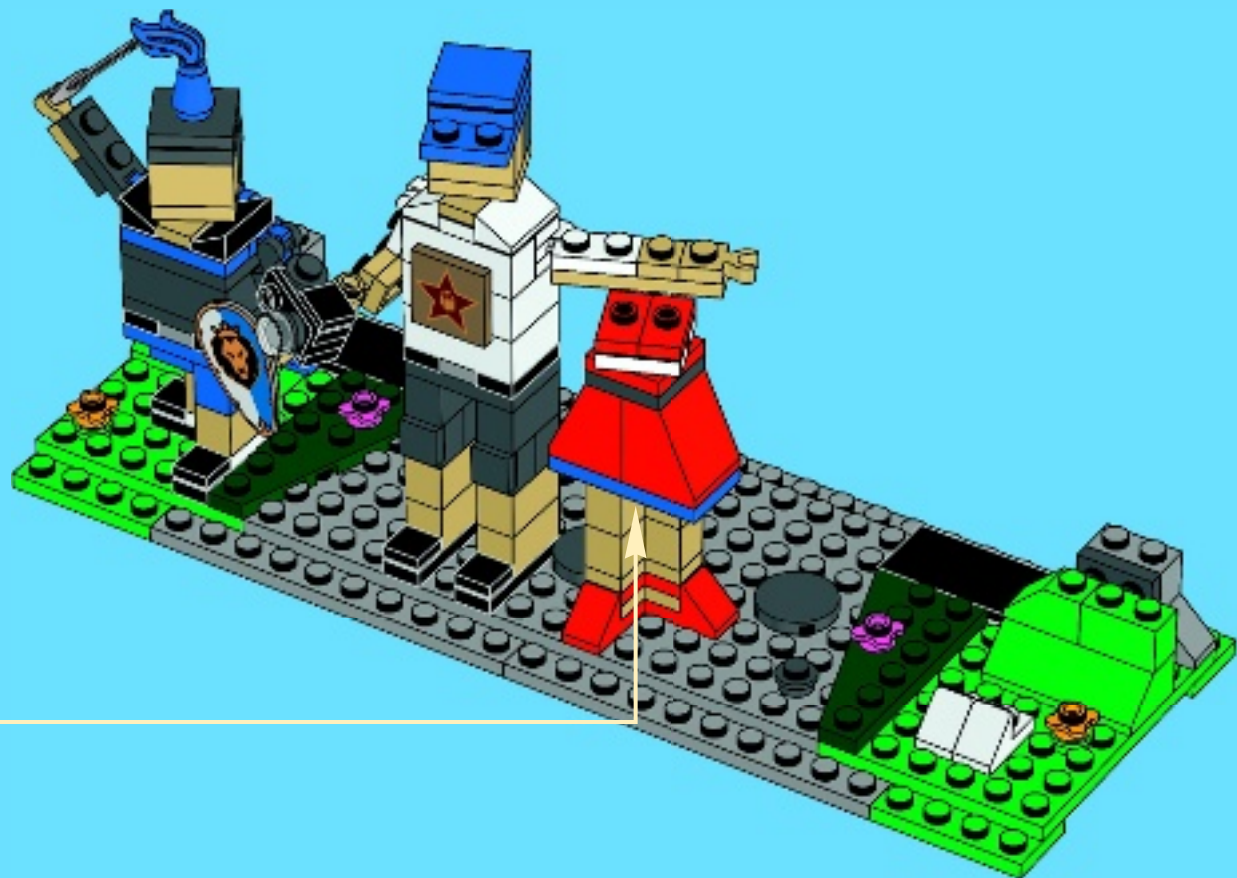



1x

1



1x



2x

2



1x



2x

3

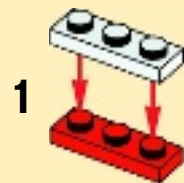

1

2





1x



1x



1x

4

1

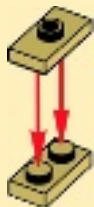

2



2x



2x

5

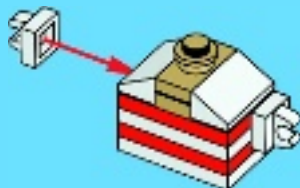



1x



1x



1x

6

1



2

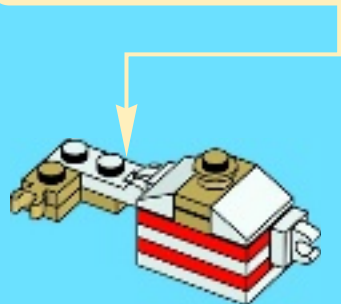

1x



1x



1x

7

1

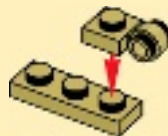

2

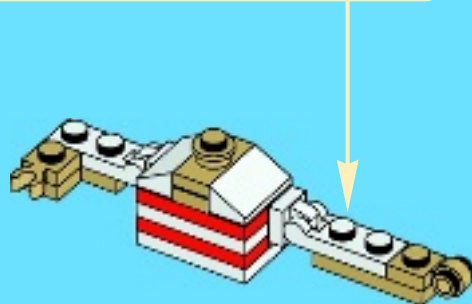
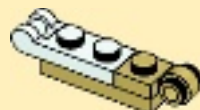

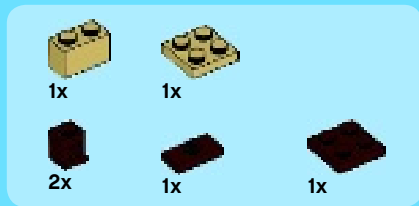

8

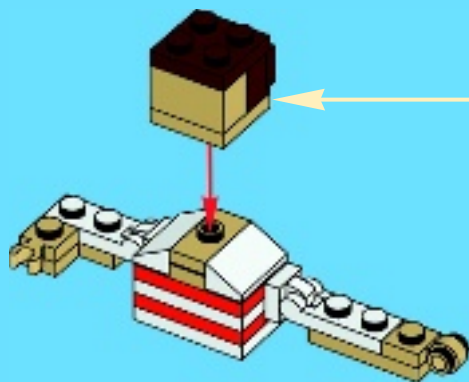
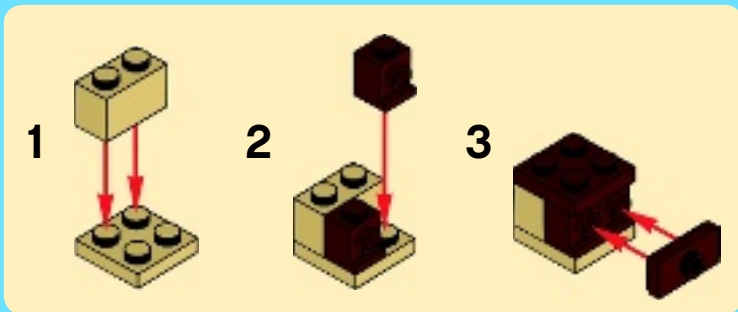



1x



1x

9

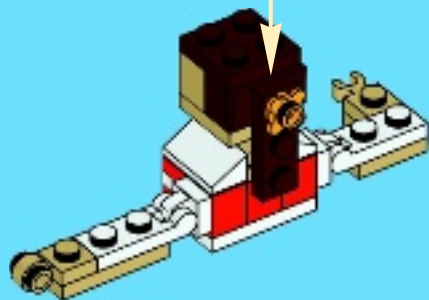

1x



1x

10

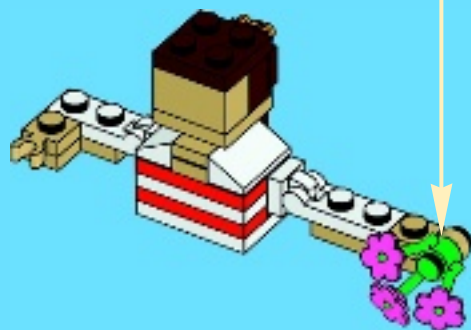
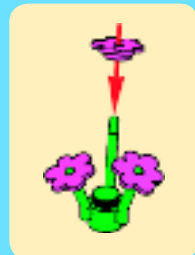

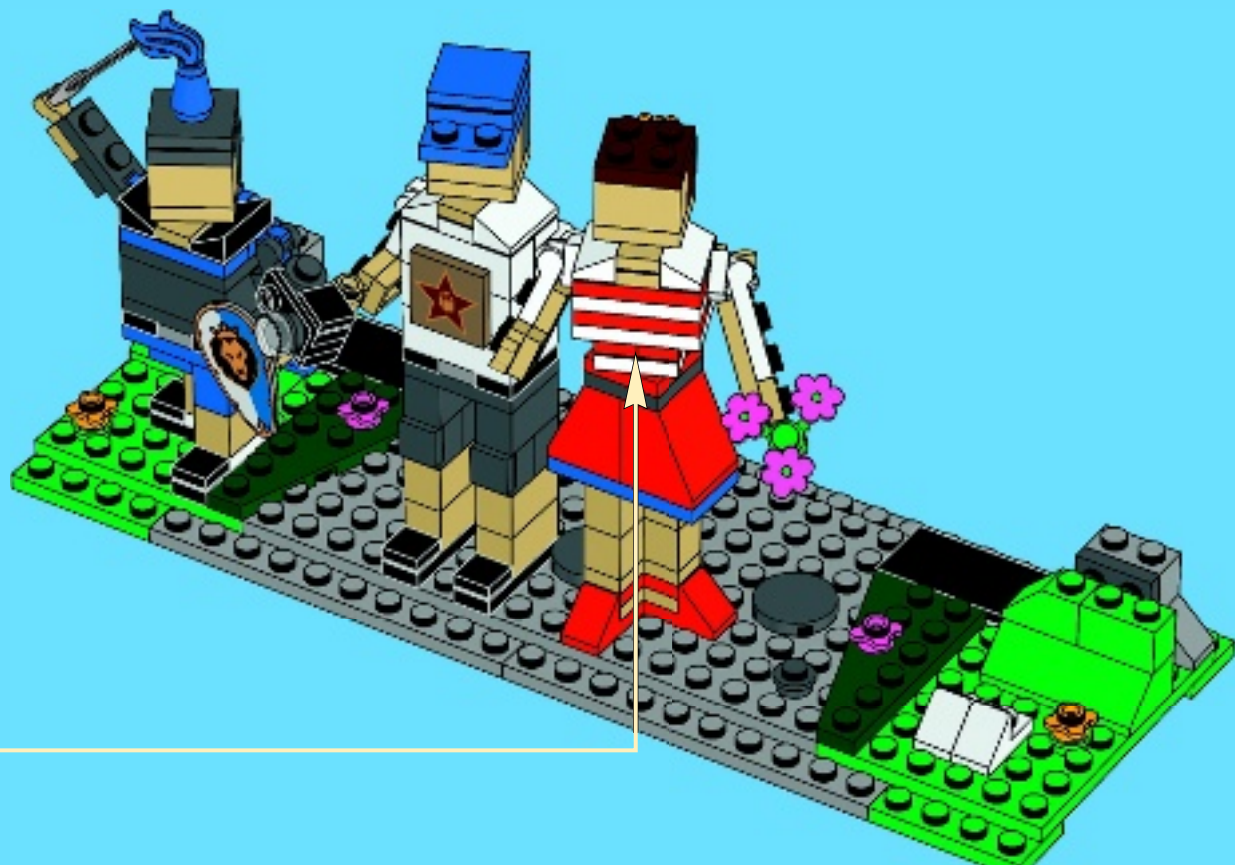



1x



1x

18

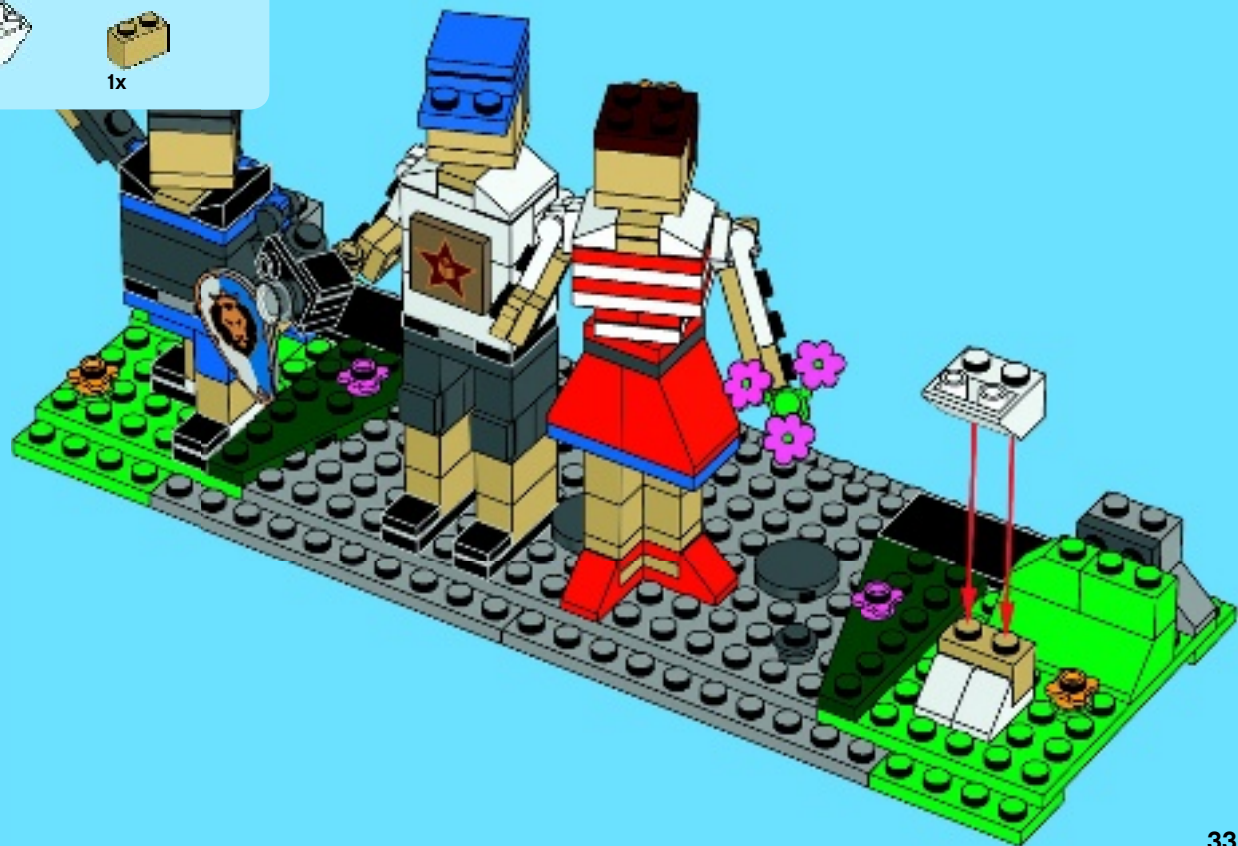



1x



1x

1



1x

2



1x



2x

3



1x



1x

4

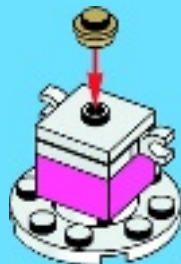



1x



1x



1x

5

1



2

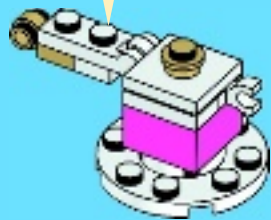

1x



1x



1x



1x

6

1



2

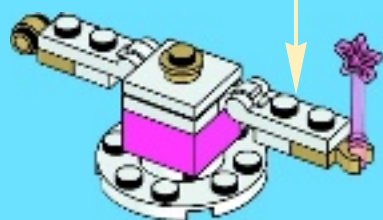



7

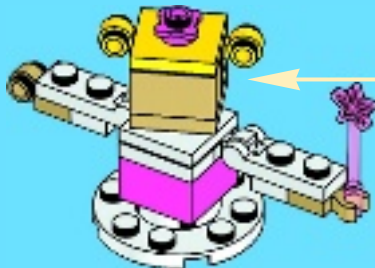
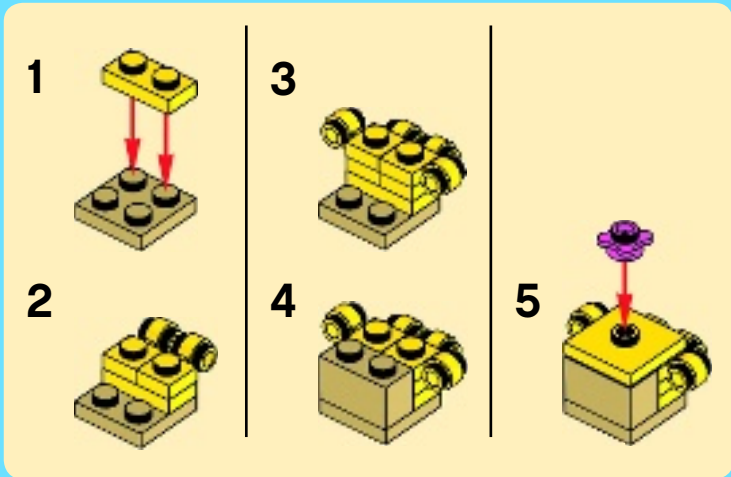

19



20

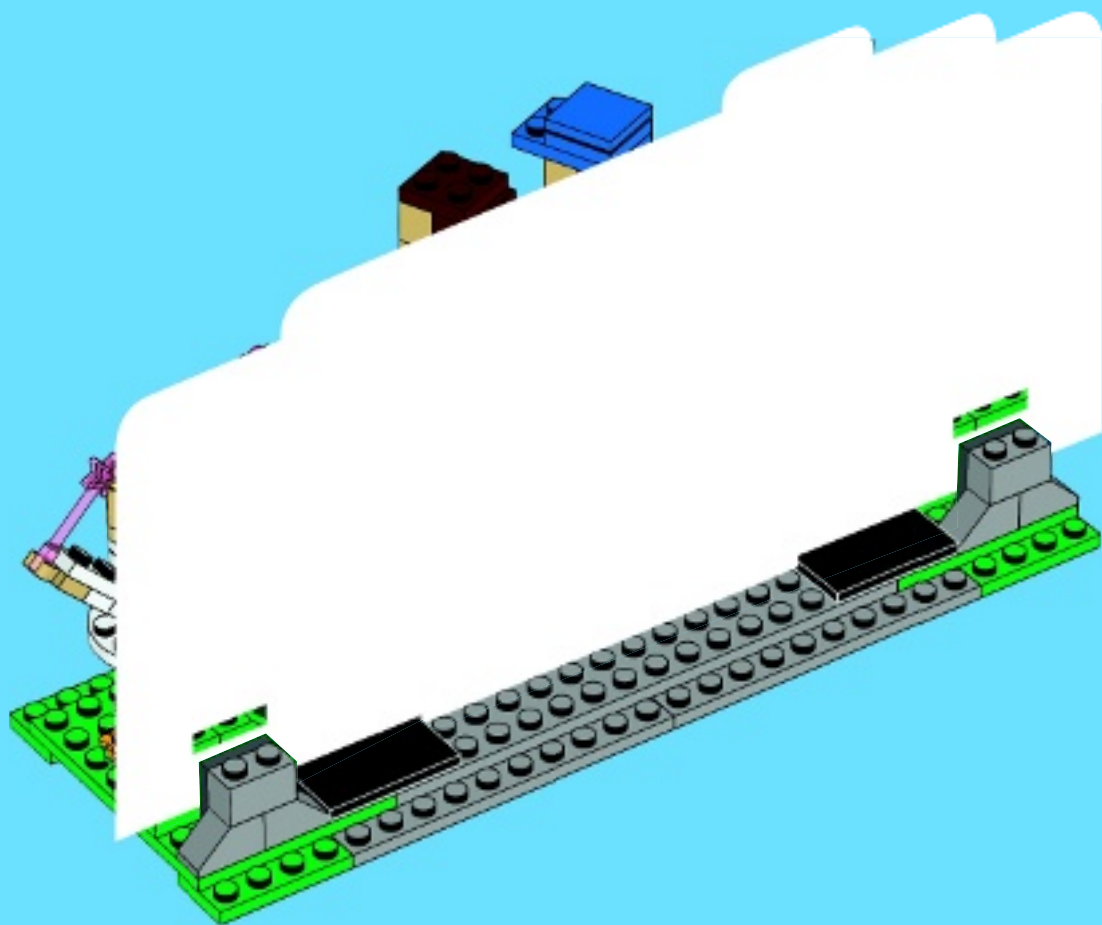



4x

21

