

WIN

GO TO WWW.LEGO.COM/RB2019 TO
 FILL OUT A SHORT SURVEY ON THIS
 PRODUCT FOR A CHANCE TO WIN
 A COOL LEGO® SET.

Terms & Conditions apply

LEGO.com/RB2019

GAGNE

Rendez-vous au www.LEGO.com/RB2019
 pour remplir un court questionnaire sur ce
 produit et courir la chance de gagner un
 fantastique ensemble LEGO®.

Voir Conditions Générales

GANA

Visita www.LEGO.com/RB2019
 y responde una breve encuesta sobre este producto.
 ¡Puedes ganar un fantástico set LEGO®!

Términos y Condiciones aplicables



30461

20

LEGO'S 20th ANNIVERSARY

20

LEGO'S 20th ANNIVERSARY

20

LEGO'S 20th ANNIVERSARY

STAR WARS

LEGO.com/starwars

7

6278164

4

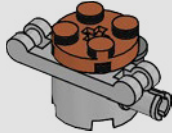

3

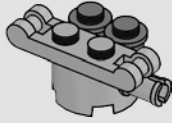

2

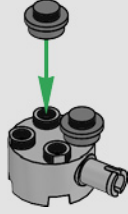

1

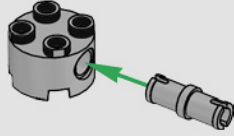

7

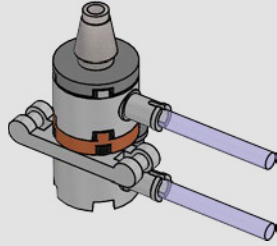

6

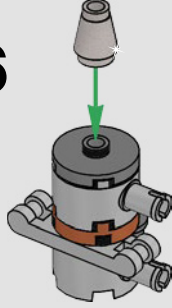

5

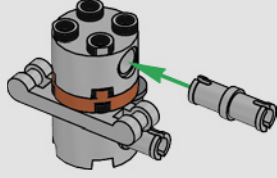

8

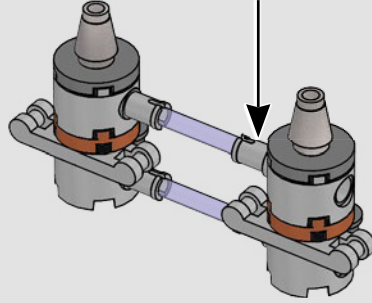

3

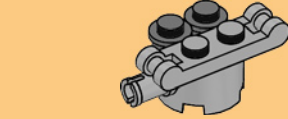

2

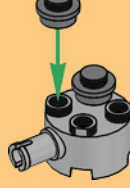

1

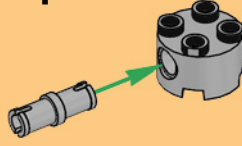

6

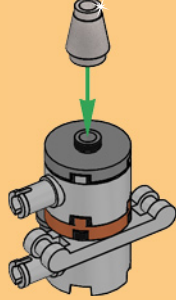

5

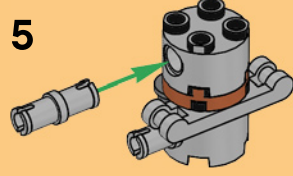

4

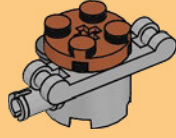

9

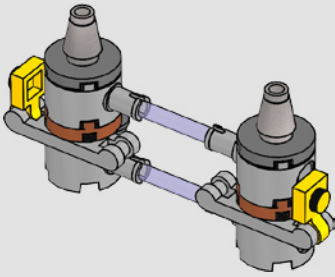

10

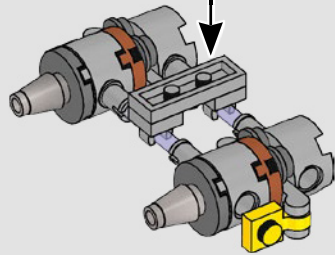
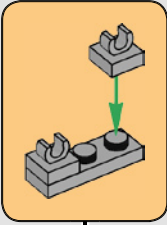

11

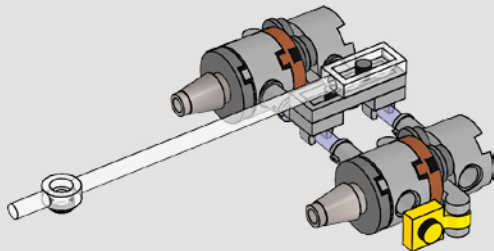

1

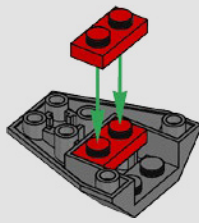

2

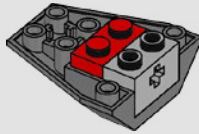

3

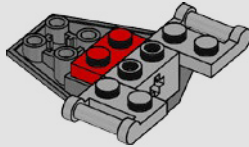

4

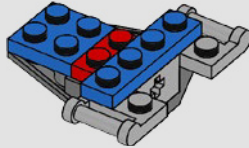

5

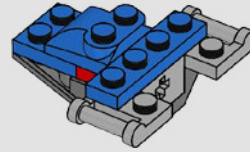

6

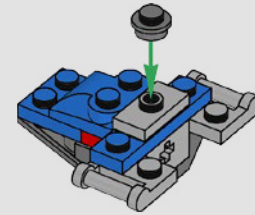

7

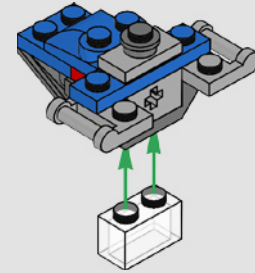

12

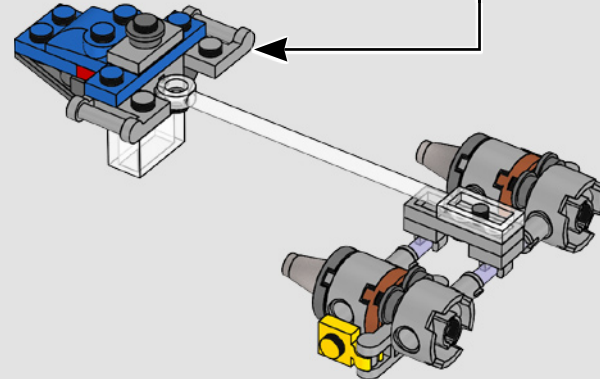

1

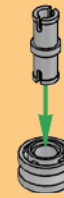

2



3

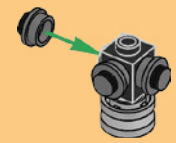

2x

13

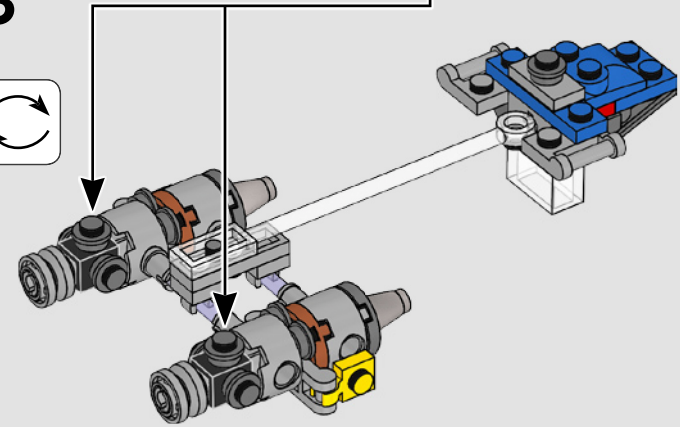

14

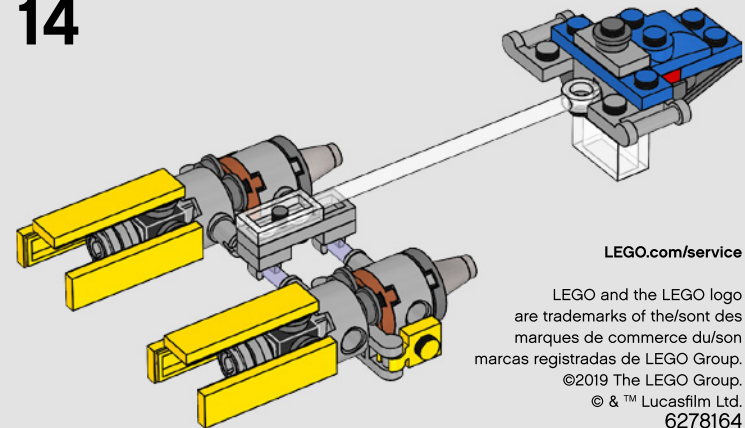

LEGO.com/service

LEGO and the LEGO logo are trademarks of the/sont des marques de commerce de/son marcas registradas de LEGO Group. ©2019 The LEGO Group. © & ™ Lucasfilm Ltd. 6278164