



Architecture

21047

Las Vegas

USA

États-Unis

EE. UU.



[LEGO.com/architecture/booklet](https://www.LEGO.com/architecture/booklet)

Welcome to Fabulous Las Vegas

Stretching out over the desert floor, the City of Las Vegas boasts some of the most jaw-dropping architecture in the United States. What started as a small, isolated railroad town in 1905, is now the fastest growing city in the country and one of the most visited tourist destinations in the world.

For much of its history, Las Vegas created its own identity as a city by borrowing from everyone else's. Walk along the famous Las Vegas Strip and you'll see New York skyscrapers, the canals of Venice and even a version of the Eiffel Tower.

The city's architecture often stretches the bounds of the imagination and structural engineering. Constantly making things bigger, better, higher or longer is what drives Las Vegas forwards and what continues to create one of the world's most vibrant skylines.

*"So much of Las Vegas falls
under the heading "it has to be
seen to be believed."*

Jeff Maguire





*"Las Vegas is the only place
I know where money really talks
– it says, Goodbye."*

Frank Sinatra

Welcome to Fabulous Las Vegas Sign

The classic 25 ft. (7.6 m) tall "Welcome to Fabulous Las Vegas" sign has stood at 5200 Las Vegas Boulevard since 1959. It was created by Betty Willis, who set out to design a roadside sign that was unique in its shape, style and content. Willis chose not to copyright her iconic work, instead seeing it as her gift to the city.

The sign is currently owned by the Young Electric Sign Company, who leases it to Clark County. Technically the sign isn't actually in Las Vegas; instead it stands approx. 4 miles (6.5 km) south of the city limits, in the town officially known as Paradise.







*"Everything and anything you want to do,
you can do in Las Vegas"*

Drew Carey



Bellagio Hotel, LLC

Inspired by the Lake Como town of Bellagio in Italy, Bellagio is one of the largest and most elegant resorts on the Las Vegas Strip. Completed in 1998 at a cost of \$1.6 billion, it has 3,933 guest rooms, including 512 suites, and a 100,000 ft² (9290 m²) gaming area. Guests entering the lobby are met by the stunning Fiori Di Como (Flowers of Como) sculpture, made up of over 2,000 hand-blown glass flowers that hang from the ceiling.

The Bellagio's most renowned feature is the 8-acre (3.2 hectare) lake, situated between the building and the Strip itself. Home to the spectacular Fountains of Bellagio, thousands of visitors to Las Vegas gather every evening to enjoy the graceful ballet of dancing fountains choreographed to music and lights.



Luxor Las Vegas

The spectacular Luxor Las Vegas is the 30-story, 120,000 ft² (11,000 m²) resort that brings the wonders of ancient Egypt to the ultra-modern Las Vegas. When it opened in October 1993, its iconic pyramid was the tallest building on the Strip and included a Nile River ride that encircled the casino and carried guests past re-created ancient Egyptian artwork.

Out of the top of the pyramid, the famous Luxor Sky Beam shoots the world's strongest beam of light up into the air. On a clear night it is said the beam can be seen 275 miles (443 km) away by aircraft cruising above Los Angeles airport.







Encore at the Wynn

Originally envisioned as an extension to the neighboring Wynn Las Vegas, the Encore instead became a full-blown resort and was completed at the end of 2008, at a cost of \$2.3 billion. The 631 ft. (192 m) tall and 93 ft. (28 m) wide structure features 2,034 hotel rooms, a 74,000 ft² (6,900 m²) casino and 27,000 ft² (2,500 m²) of convention space.

Though it officially has 63 floors, in reality there are only 48 floors in the building, as certain floor numbers have been omitted. The number 13 has traditionally been seen as unlucky in various Western cultures, while many Asian cultures are superstitious about the number 4.

“A little bit of this town goes a very long way”

Hunter S. Thompson



Stratosphere Las Vegas

At 1149 ft. (350 m), the Stratosphere is the tallest freestanding observation tower in the United States. It's also the tallest structure in Las Vegas and home to one of the most incredible views of the city. It has two observation decks, a revolving restaurant and four thrill rides that let visitors dangle, spin and plummet high above the city at 855 ft. (261 m).

Bob Stupak, previous owner and entrepreneur who built the Stratosphere, claimed the tower would “do for Las Vegas what the Eiffel Tower did for Paris.”

“Las Vegas is a city built on hopes, dreams, and a little bit of crazy.”

Michael McDonald



Fremont Street

Fremont Street is where Las Vegas as we know it today began; it is home to the original Vegas Strip, as well as where the first street was paved in 1925 and where the city's first traffic light was erected in 1931. As the city grew, Fremont Street was the place to see and be seen, featuring Las Vegas' legendary entertainers, best-known establishments and iconic neon signs. By the late 1980s, the street and surrounding neighborhood found itself in fierce competition with the growth and expansion of the newer casinos on Las Vegas Boulevard.

In response, Fremont Street was revitalized by the development of the Fremont Street Experience, transforming the five-block area into a dazzling entertainment district. The centerpiece of the experience is the 1,500 ft. (457 m) long and 90 ft. (27.4 m) wide video screen canopy suspended 90 ft. (27.4 m) above the pedestrian mall below delivering a spectacular audio-visual show every hour in the evening.

"Las Vegas is the boiling pot of entertainment."

Don Rickles





Bienvenue dans la fabuleuse Las Vegas

Étendue à même le désert, la ville de Las Vegas compte une architecture parmi les plus impressionnantes des États-Unis. Cette petite ville ferroviaire isolée fondée en 1905 affiche aujourd'hui la croissance la plus rapide du pays et est l'une des destinations touristiques les plus visitées du monde.

Pendant une grande partie de son histoire, Las Vegas s'est forgé sa propre identité en empruntant des éléments de partout. Promenez-vous sur sa célèbre artère, la Strip, et vous verrez des gratte-ciel de New York, les canaux de Venise et même une version de la tour Eiffel.

L'architecture de la ville repousse souvent les limites de l'imagination et de l'ingénierie des structures. Las Vegas mise constamment sur la taille, la hauteur, l'étendue et le dépassement. C'est ce qui la propulse vers l'avant et qui continue d'en faire un des paysages les plus dynamiques qui soient.

« Il faut le voir pour le croire. À Las Vegas, cela s'applique à peu près partout. »

Jeff Maguire





*« Las Vegas est le seul endroit
que je connais où l'argent parle.
Il nous dit au revoir. »*

Frank Sinatra

Le panneau « Bienvenue dans la fabuleuse Las Vegas »

Le célèbre panneau « Bienvenue dans la fabuleuse Las Vegas », mesurant 7,6 m de hauteur, a pignon sur rue au 5200, Las Vegas Boulevard depuis 1959. Il a été créé par Betty Willis, qui voulait en faire un panneau routier unique tant par sa forme que par son style et son contenu. Mme Willis a choisi de ne pas protéger son droit d'auteur pour son œuvre, qu'elle a plutôt décidé d'offrir en cadeau à la ville.

Le panneau appartient aujourd'hui à l'entreprise Young Electric Sign Company, qui le loue au comté de Clark. Techniquement, il ne se trouve pas à Las Vegas, mais plutôt à environ 6,5 km au sud, dans une ville appelée Paradise.





WELCOME

TO *Fabulous*
LAS VEGAS
NEVADA





« Pensez à tout ce que vous souhaitez faire et vous pouvez le faire à Las Vegas. »

Drew Carey

Bellagio Hotel, LLC

Inspiré de Bellagio, une ville du lac de Côme en Italie, le Bellagio est l'un des plus grands et des plus élégants complexes hôteliers sur la Strip à Las Vegas. Achevé en 1998 au coût de 1,6 milliard de dollars, il possède 3 933 chambres, dont 512 suites, et une aire de jeu de 9 290 m². En entrant dans le hall, les invités découvrent la spectaculaire sculpture Fiori Di Como (fleurs de Como), qui compte plus de 2 000 fleurs en verre soufflé suspendues au plafond.

La caractéristique la plus célèbre du Bellagio est le lac de 3,2 hectares aménagé entre le bâtiment et la Strip. Accueillant les magnifiques fontaines du Bellagio, il attire des milliers de visiteurs de Las Vegas tous les soirs, qui viennent y admirer le ballet gracieux des fontaines dansant au rythme de la musique et des jeux de lumière.



Luxor Las Vegas

Le spectaculaire Luxor Las Vegas est un centre de villégiature de 30 étages et de 11 000 m² qui déploie les merveilles de l'Égypte ancienne dans le contexte ultramoderne de Las Vegas. Lorsqu'il a ouvert ses portes en octobre 1993, le célèbre bâtiment en forme de pyramide était le plus haut sur la Strip de Las Vegas. On pouvait y faire une balade sur le fleuve Nil qui entourait le casino, en visitant au passage des recreations de l'art de l'Égypte ancienne.

Dans la partie supérieure de la pyramide, un projecteur émet dans le ciel le plus puissant faisceau lumineux du monde. Par une nuit dégagée, les avions survolant l'aéroport de Los Angeles peuvent apercevoir ce faisceau à 443 km de distance.







Encore at the Wynn

Initialement envisagé comme une extension du Wynn Las Vegas dont il est voisin, le Encore est devenu un complexe à part entière terminé à la fin de 2008 au coût de 2,3 milliards de dollars. La structure de 192 m de hauteur et de 28 m de largeur comprend 2 034 chambres d'hôtel, un casino de 6 900 m² et un espace de congrès de 2 500 m².

S'il affiche officiellement 63 étages, le bâtiment en compte en réalité 48, car certains numéros ont été ignorés. Le numéro 13 est traditionnellement associé à la malchance dans diverses cultures occidentales, tandis que de nombreuses cultures asiatiques ont des superstitions associées au numéro 4.

« Il ne faut que peu de temps dans cette ville pour vivre de grandes choses. »

Hunter S. Thompson



Stratosphere Las Vegas

Avec ses 350 m, la Stratosphere est la plus haute tour d'observation autoportante aux États-Unis. Cette structure est également la plus haute de Las Vegas et celle qui offre la vue la plus incroyable sur la ville. On y trouve deux terrasses d'observation, un restaurant tournant et quatre manèges à sensations fortes qui font balancer, tournoyer et plonger les visiteurs à 261 m au-dessus de la ville.

Bob Stupak, entrepreneur qui a construit la Stratosphere et ancien propriétaire, a affirmé que la tour « ferait pour Las Vegas ce que la tour Eiffel a fait pour Paris ».

« Las Vegas est une ville construite sur l'espoir, sur les rêves et sur un brin de folie. »

Michael McDonald



Fremont Street

Fremont Street est l'endroit où Las Vegas telle que nous la connaissons aujourd'hui a commencé. Grande artère d'origine de la ville, elle a été sa première rue pavée en 1925 et a accueilli son tout premier feu de circulation en 1931. Dans l'effervescence de l'agglomération, Fremont Street était l'endroit à voir et celui où il faisait bon être vu, réunissant des artistes légendaires, des établissements en vogue et d'emblématiques enseignes en néon. À la fin des années 1980, la rue et le quartier sont entrés dans une concurrence acharnée avec le mouvement de croissance et de prolongement des nouveaux casinos du Las Vegas Boulevard.

En réponse, Fremont Street a été revitalisée grâce à une initiative de transformation des cinq pâtés du secteur en un carrefour de divertissement éblouissant : le Fremont Street Experience. La pièce maîtresse de l'expérience est l'écran de 457 m de long et de 27,4 m de large occupant l'intérieur de la marquise et suspendu à 27,4 m au-dessus d'une rue piétonnière. Un spectacle audiovisuel y est diffusé toutes les heures en soirée.

« Las Vegas est un feu roulant de divertissement. »

Don Rickles





Te damos la bienvenida a la fabulosa Las Vegas

Construida sobre suelo desértico, la ciudad de Las Vegas presume de algunas de las obras arquitectónicas más asombrosas de los Estados Unidos. Lo que comenzó como un pequeño asentamiento ferroviario aislado en 1905 es hoy la ciudad de más rápido crecimiento del país y uno de los destinos turísticos más visitados del mundo.

Durante gran parte de su historia, Las Vegas desarrolló su identidad como ciudad tomando prestada la de todas las demás. Caminar por la famosa Las Vegas Strip permite contemplar los rascacielos de Nueva York, los canales de Venecia e incluso una versión de la Torre Eiffel.

Con frecuencia, la arquitectura de la ciudad supera los límites de la imaginación y la ingeniería estructural. Hacer las cosas constantemente más grandes, mejores, más altas o más largas es el motor de Las Vegas y lo que sigue dando lugar a uno de los horizontes más dinámicos del mundo.

«Buena parte de lo que hay en Las Vegas pertenece a la categoría “hay que verlo para creerlo”».

Jeff Maguire





*«Las Vegas es el único lugar
que conozco en el que el dinero
habla de verdad. Y dice adiós».*

Frank Sinatra

Letrero «Welcome to Fabulous Las Vegas»

El clásico letrero «Welcome to Fabulous Las Vegas», de 7,6 m de altura, ha estado instalado en el 5200 de Las Vegas Boulevard desde 1959. Fue creado por Betty Willis, que se propuso diseñar un letrero a pie de carretera que fuera único por su forma, estilo y contenido. Willis decidió no registrar su emblemático trabajo y lo consideró un regalo para la ciudad.

En la actualidad, el letrero es propiedad de la Young Electric Sign Company, que se lo renta al condado de Clark. Técnicamente, el letrero no está realmente en Las Vegas: se encuentra a unos 6,5 km al sur de los límites de la ciudad, en un municipio oficialmente llamado Paradise.







«Absolutamente todo lo que quieras hacer, lo puedes hacer en Las Vegas».

Drew Carey



Hotel Bellagio, LLC

Inspirado en la ciudad italiana de Bellagio, a orillas del lago Como, el Bellagio es uno de los complejos hoteleros más grandes y elegantes de Las Vegas Strip. Con un costo de 1.600 millones de dólares, fue inaugurado en 1998 y cuenta con 3.933 habitaciones (de ellas, 512 de lujo) y un área de juego de 9.290 m². Los huéspedes que llegan al vestíbulo son recibidos por la deslumbrante escultura Fiori di Como (Flores de Como), compuesta por más de 2.000 flores de vidrio soplado a mano que cuelgan del techo.

La atracción más conocida del Bellagio es el lago de 3,2 ha que se encuentra entre el edificio y Las Vegas Strip. Hogar de las espectaculares Fuentes de Bellagio, miles de turistas se reúnen cada tarde frente a ellas para disfrutar de sus majestuosas danzas, coreografiadas con música y efectos luminosos.



Luxor Las Vegas

El espectacular Luxor Las Vegas es un complejo turístico de 30 pisos y 11.000 m² que reúne las maravillas del Antiguo Egipto en la ultramoderna Las Vegas. Cuando abrió sus puertas en octubre de 1993, su célebre pirámide era el edificio más alto de The Strip e incluía el juego Nile River, que rodeaba el casino y paseaba a los visitantes por una exposición de obras que recreaban el arte egipcio.

Desde la cúspide de la pirámide, el famoso Luxor Sky Beam lanza al aire el rayo de luz más intenso del mundo. Se dice que, en una noche clara, el rayo se puede ver a 443 km sobrevolando en avión el aeropuerto de Los Ángeles.







Encore at the Wynn

Diseñado originalmente como ampliación del cercano Wynn Las Vegas, el Encore acabó por convertirse en un complejo turístico independiente terminado en 2008 con un costo de 2.300 millones de dólares. La estructura, de 192 m de altura y 28 m de ancho, cuenta con 2.034 habitaciones de hotel, un casino de 6.900 m² y 2.500 m² de áreas de convenciones.

Aunque oficialmente tiene 63 pisos, en realidad sólo hay 48, ya que ciertos números se omitieron al numerarlos. Diversas culturas occidentales consideran que el número 13 atrae la mala suerte; sucede lo mismo en muchas culturas asiáticas con el número 4.

«Un poco de esta ciudad tiene muchísimo que contar».

Hunter S. Thompson



Stratosphere Las Vegas

Con 350 m de altura, la Stratosphere es la torre de observación independiente más alta de los Estados Unidos. Es también la estructura más alta de Las Vegas y ofrece una de las vistas más increíbles de la ciudad. Cuenta con dos plataformas de observación, un restaurante giratorio y cuatro emocionantes juegos que permiten a los visitantes suspenderse, girar y dejarse caer a 261 m del piso.

Bob Stupak, anterior propietario y empresario responsable de la construcción de la Stratosphere, llegó a decir que la torre «haría por Las Vegas lo que la Torre Eiffel hizo por París».

«Las Vegas es una ciudad construida sobre esperanzas, sueños y un poco de locura».

Michael McDonald



Fremont Street

Fremont Street es donde Las Vegas se convirtió en lo que es hoy y el punto de partida original de Las Vegas Strip. Fue también la primera calle asfaltada en 1925 y el lugar donde se instaló el primer semáforo de la ciudad en 1931. Durante el desarrollo de la ciudad, Fremont Street era donde había que ir para ver y ser visto; acogió a legendarios artistas de Las Vegas, célebres establecimientos y emblemáticas señales de neón. A finales de la década de 1980, la calle y el vecindario que la rodea tuvieron que competir ferozmente con el crecimiento y la expansión de los nuevos casinos de Las Vegas Boulevard.

En respuesta, Fremont Street se transformó en el Fremont Street Experience y sus cinco manzanas se convirtieron en un deslumbrante distrito de entretenimiento. La pieza central de la experiencia es una videobóveda de 457 m de longitud y 27,4 m de ancho suspendida a 27,4 m del área comercial peatonal que ofrece un asombroso espectáculo audiovisual cada hora en las tardes.

«Las Vegas es una olla de entretenimiento en ebullición».

Don Rickles





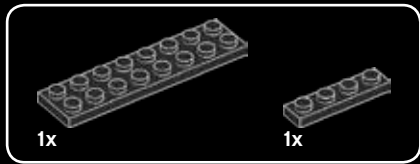

1

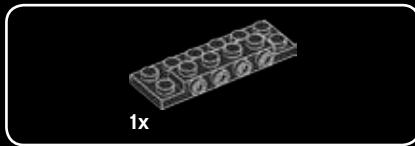
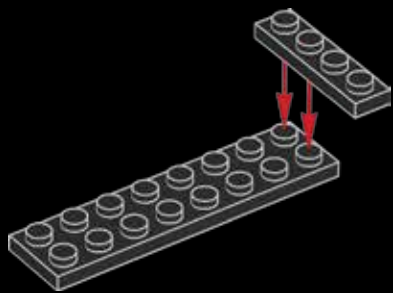

2

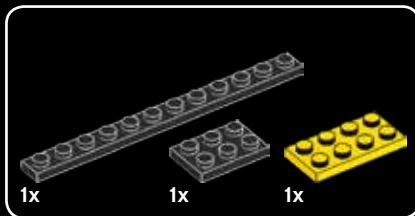
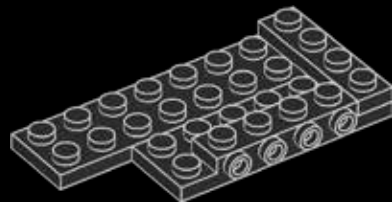

3

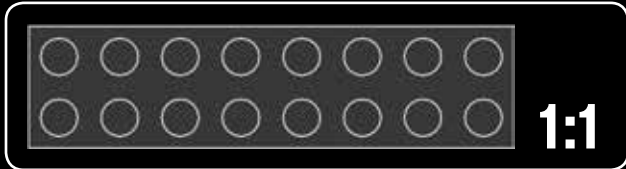
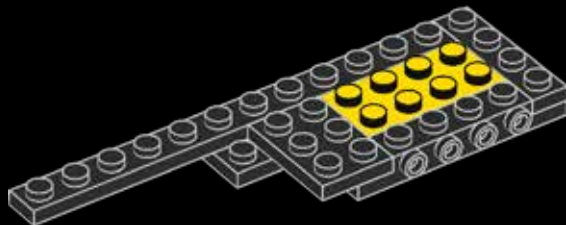

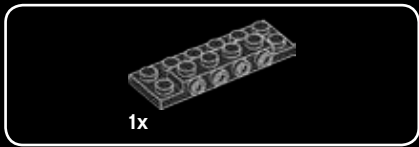

4

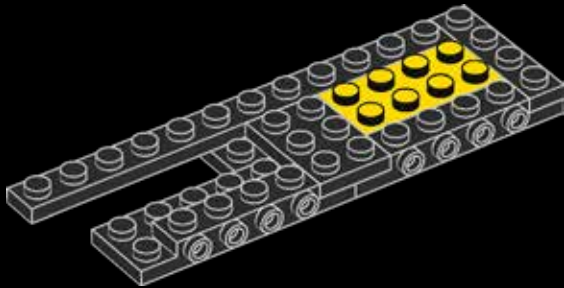

5

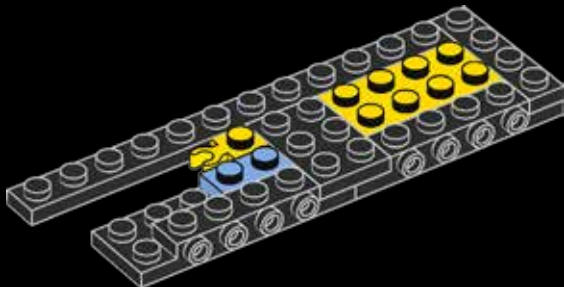

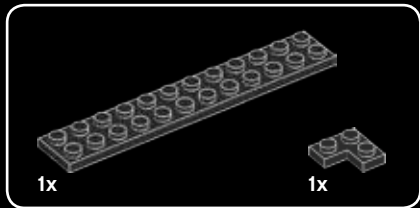

6

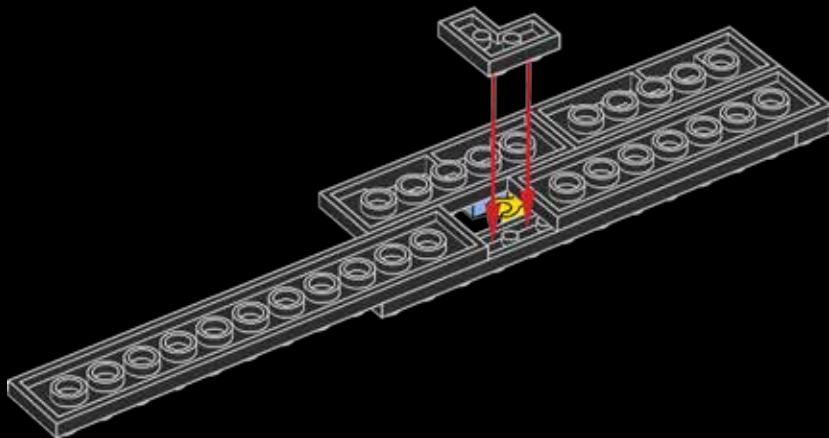

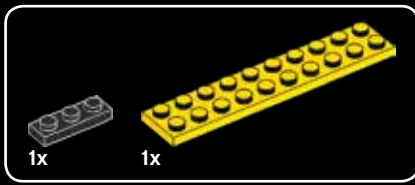

7

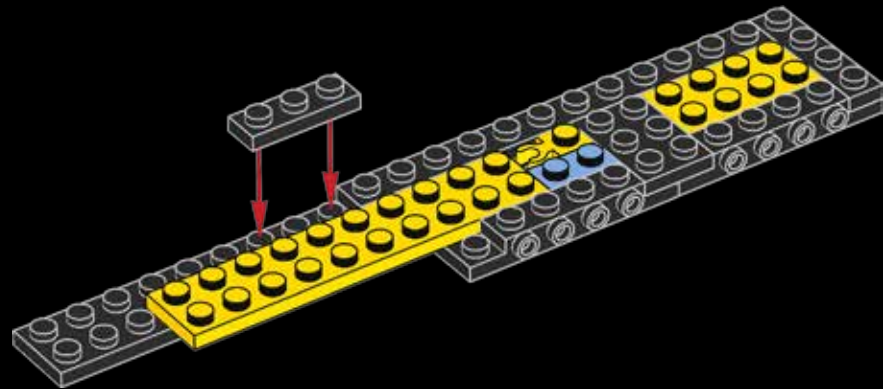
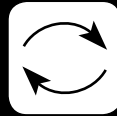

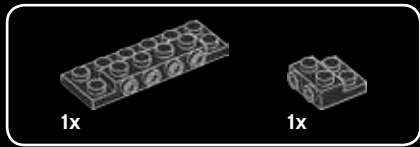

8

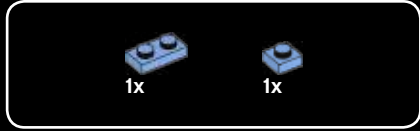
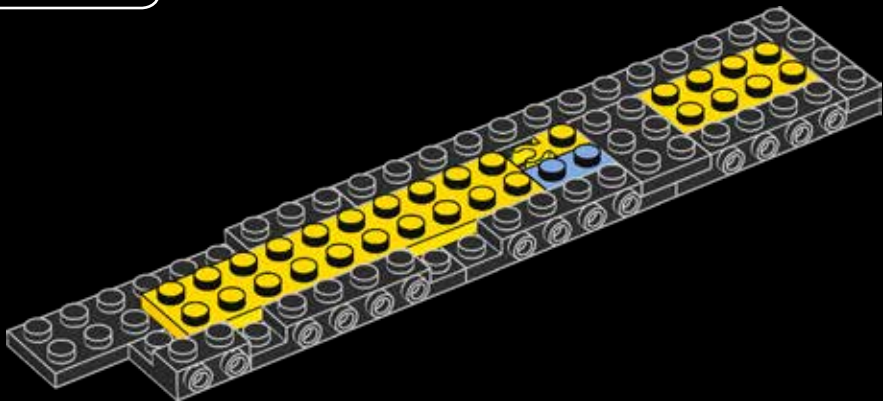

9

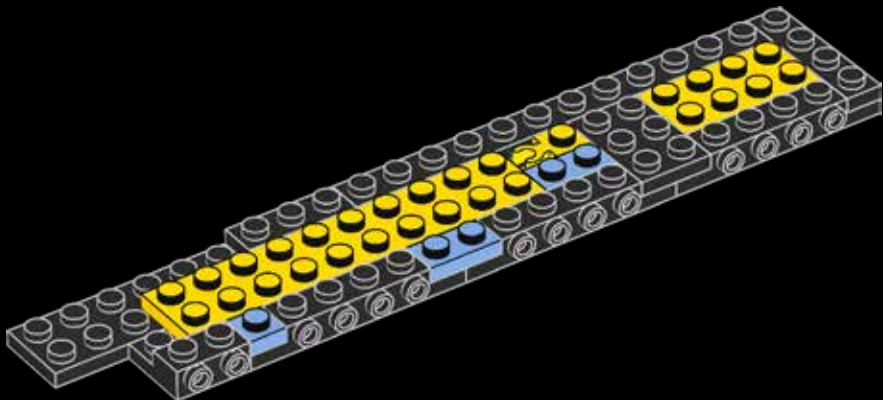

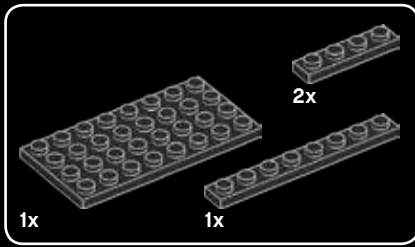

10

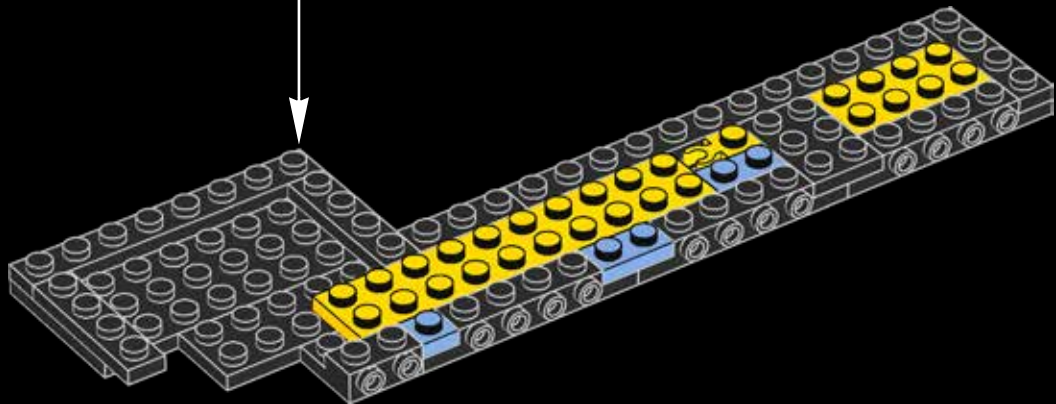
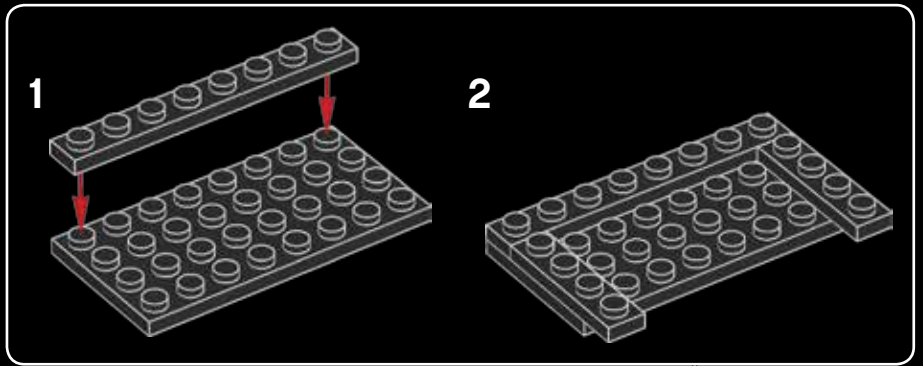



11

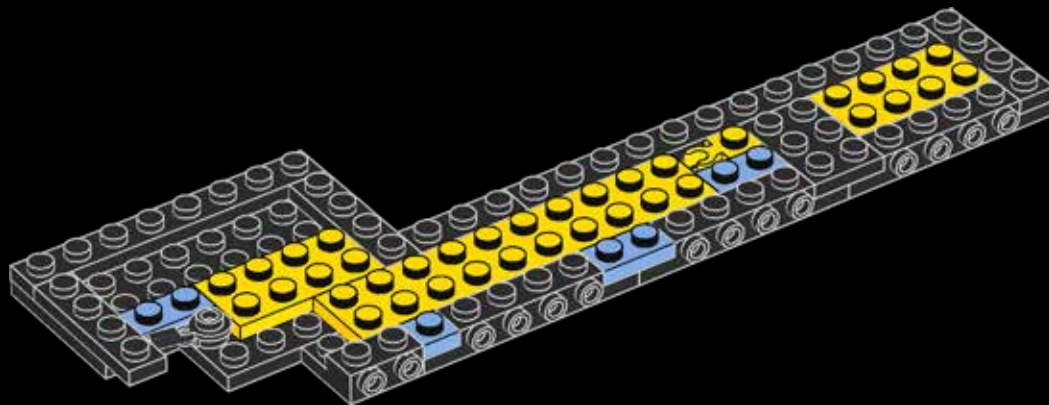
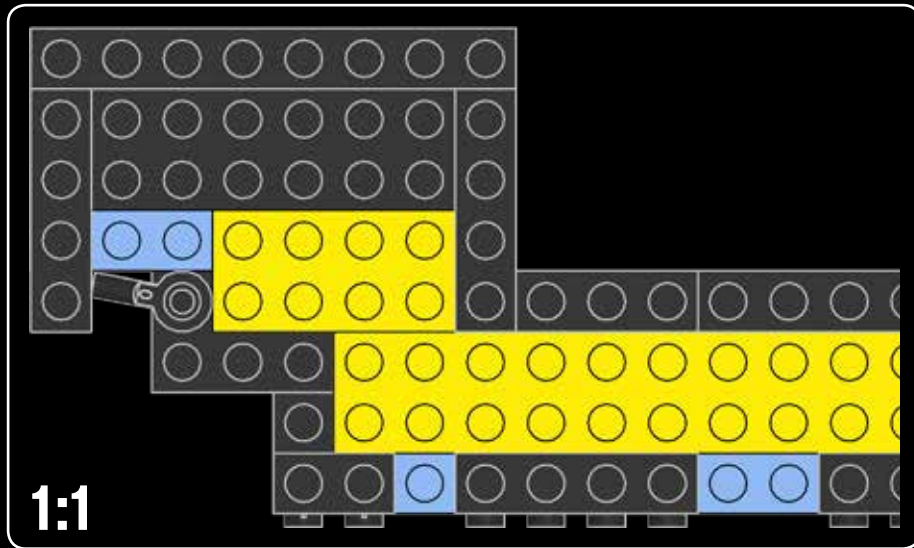

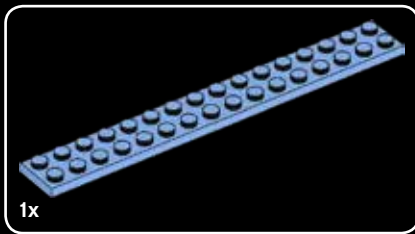

12

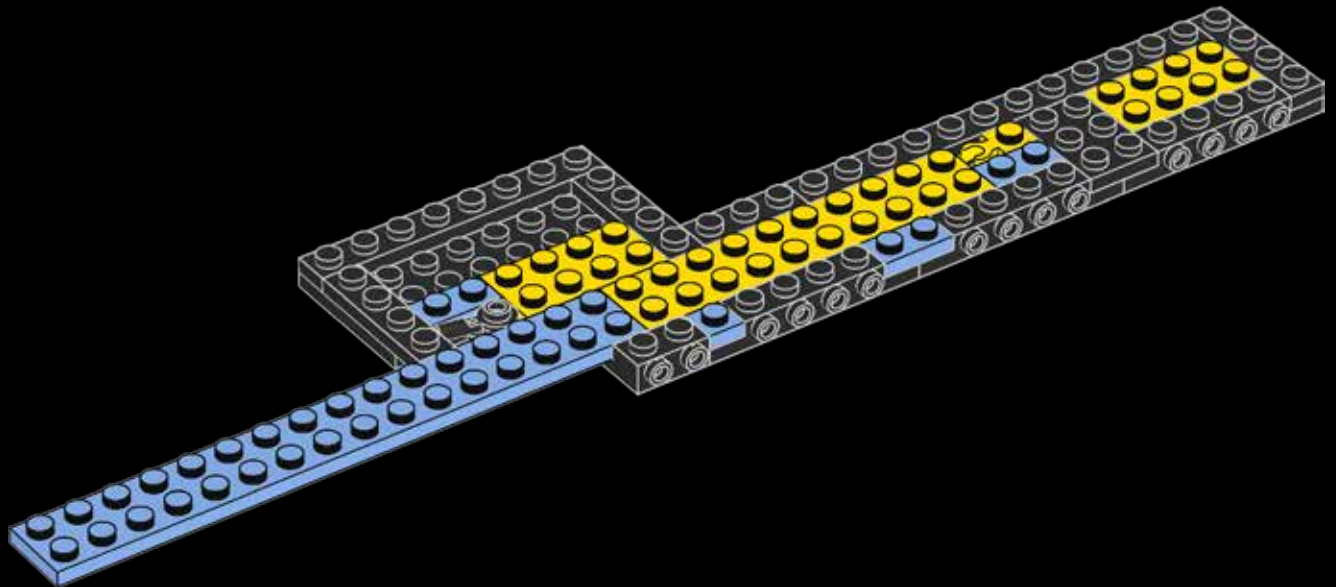

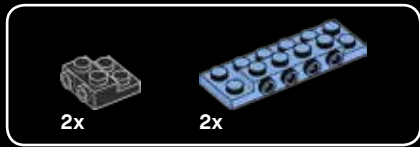

13

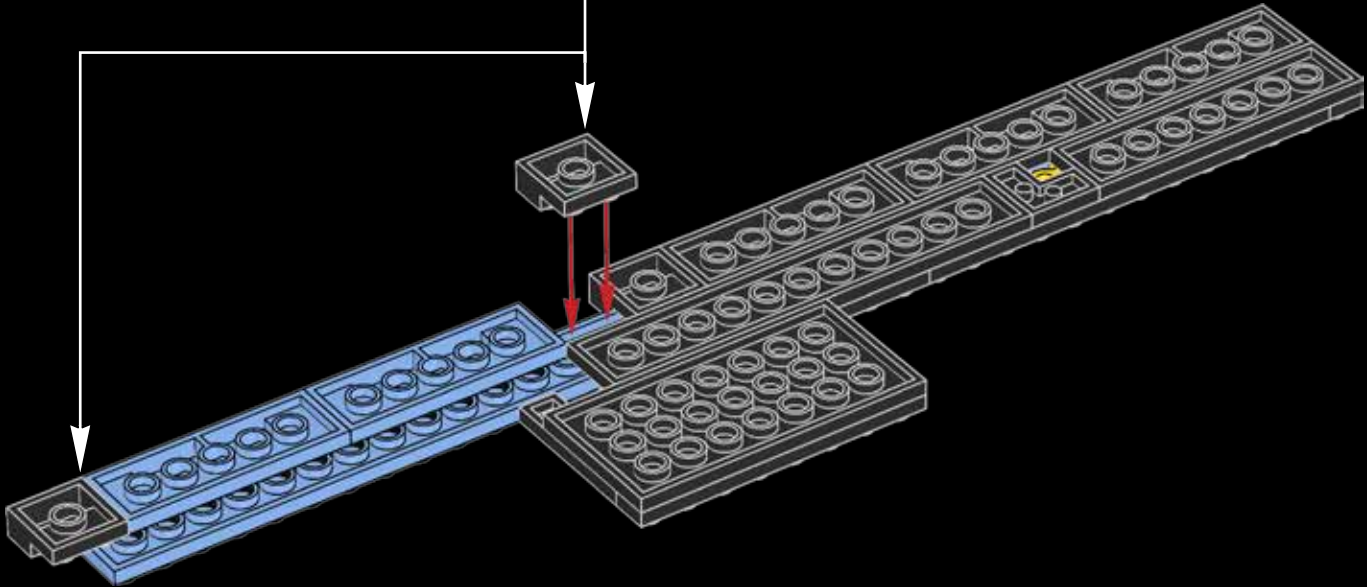
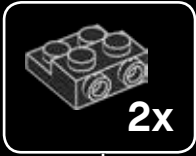

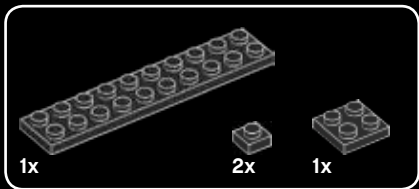

14

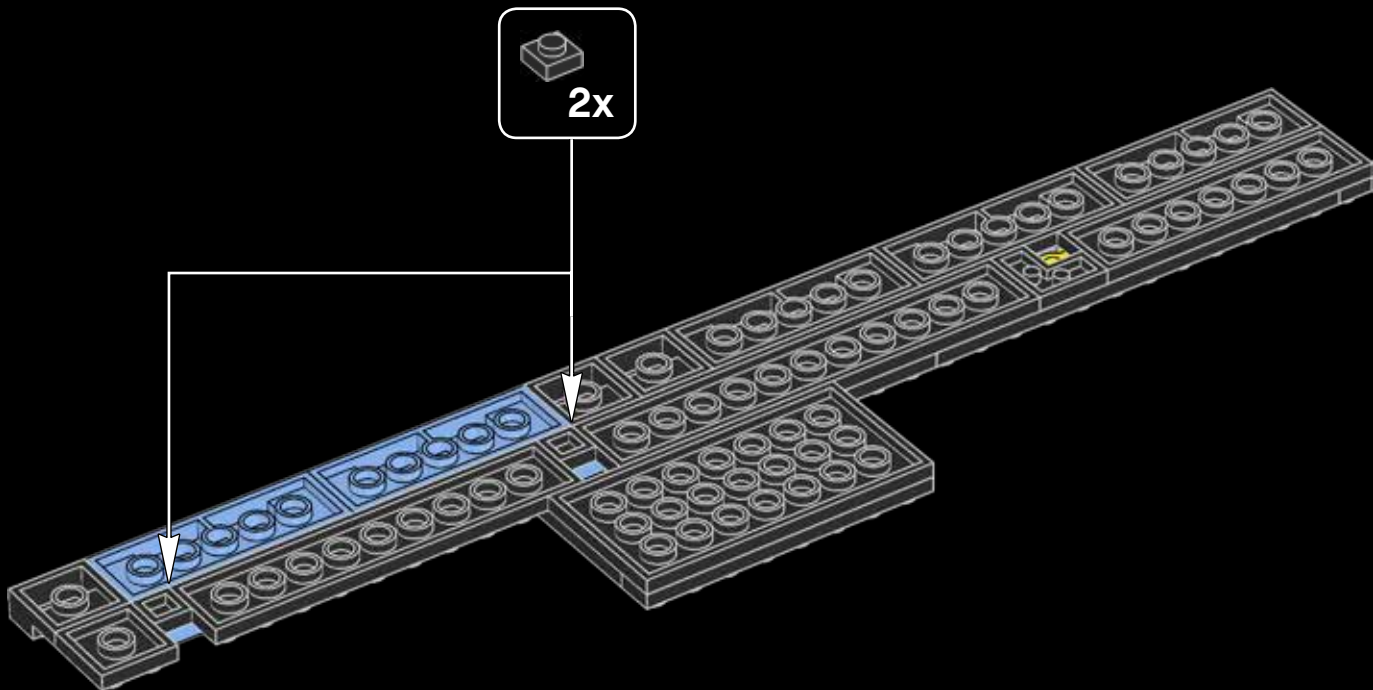



15

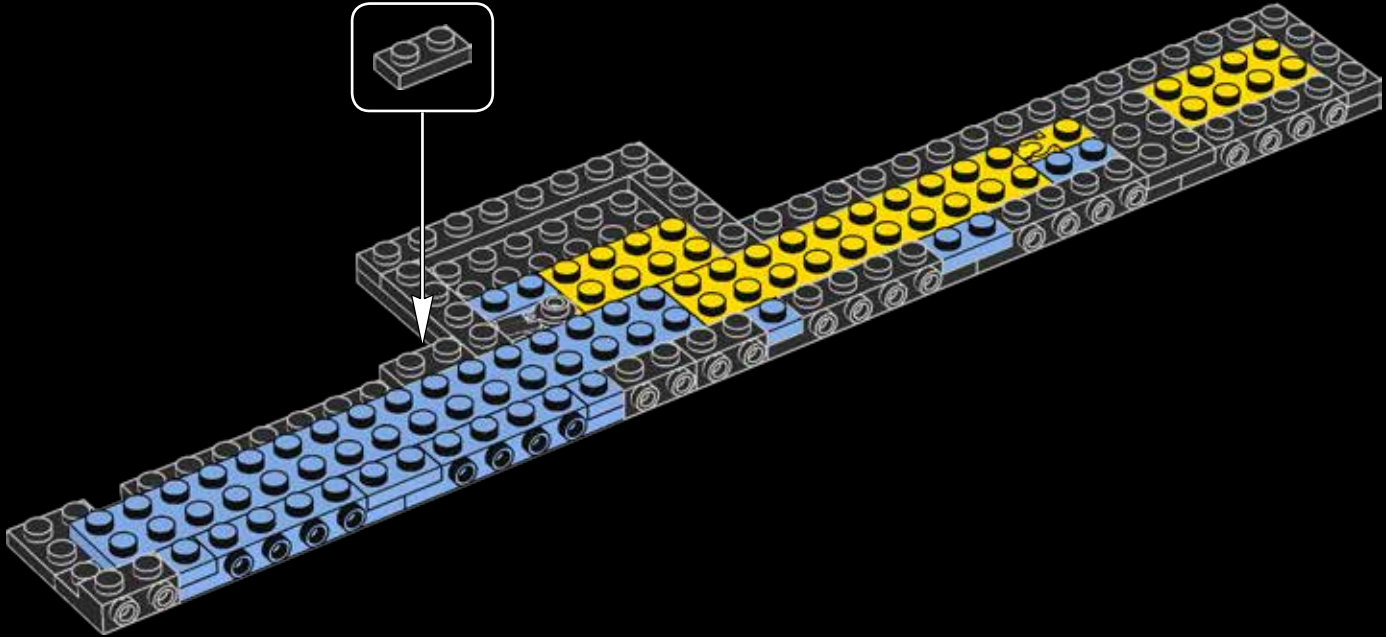



16

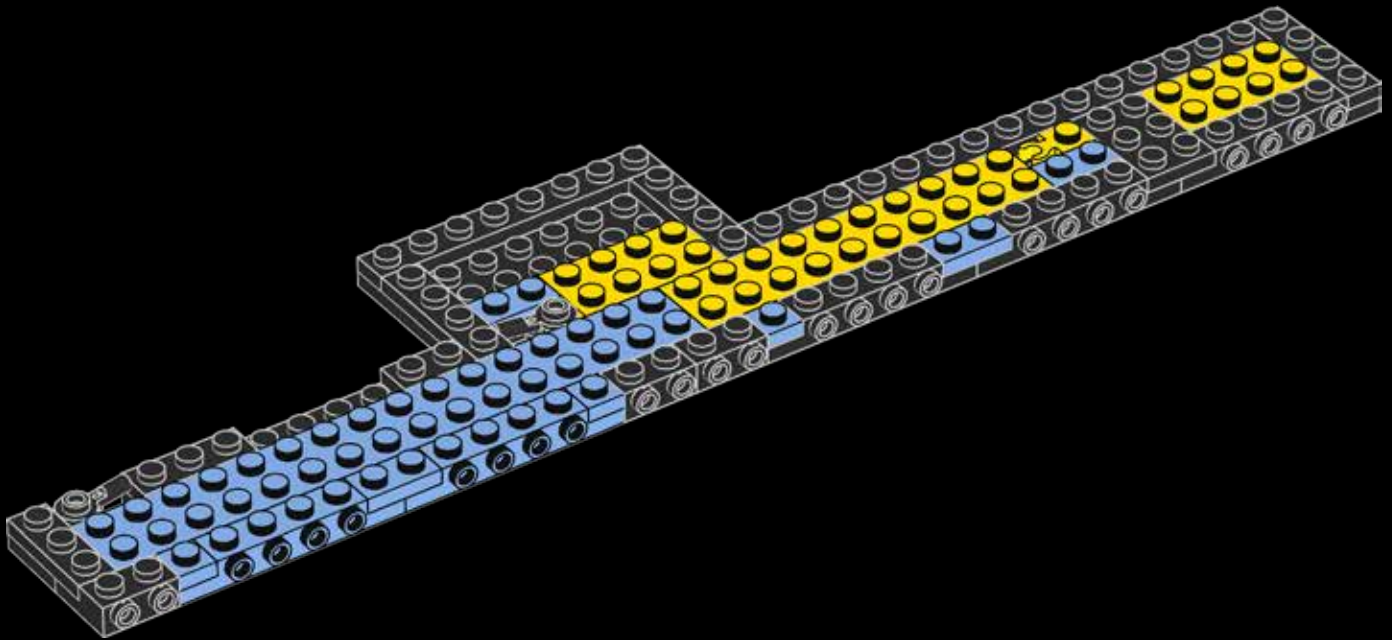
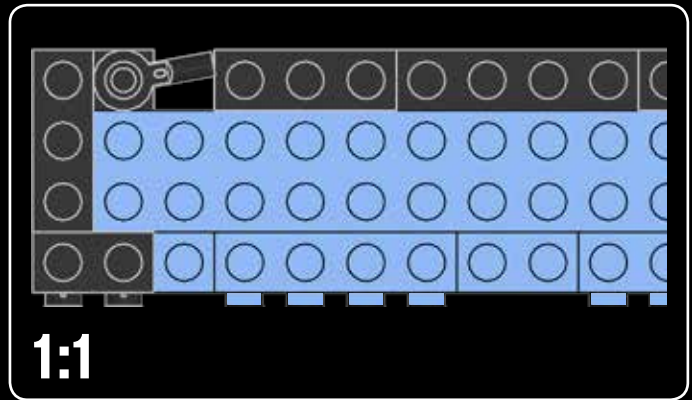

17

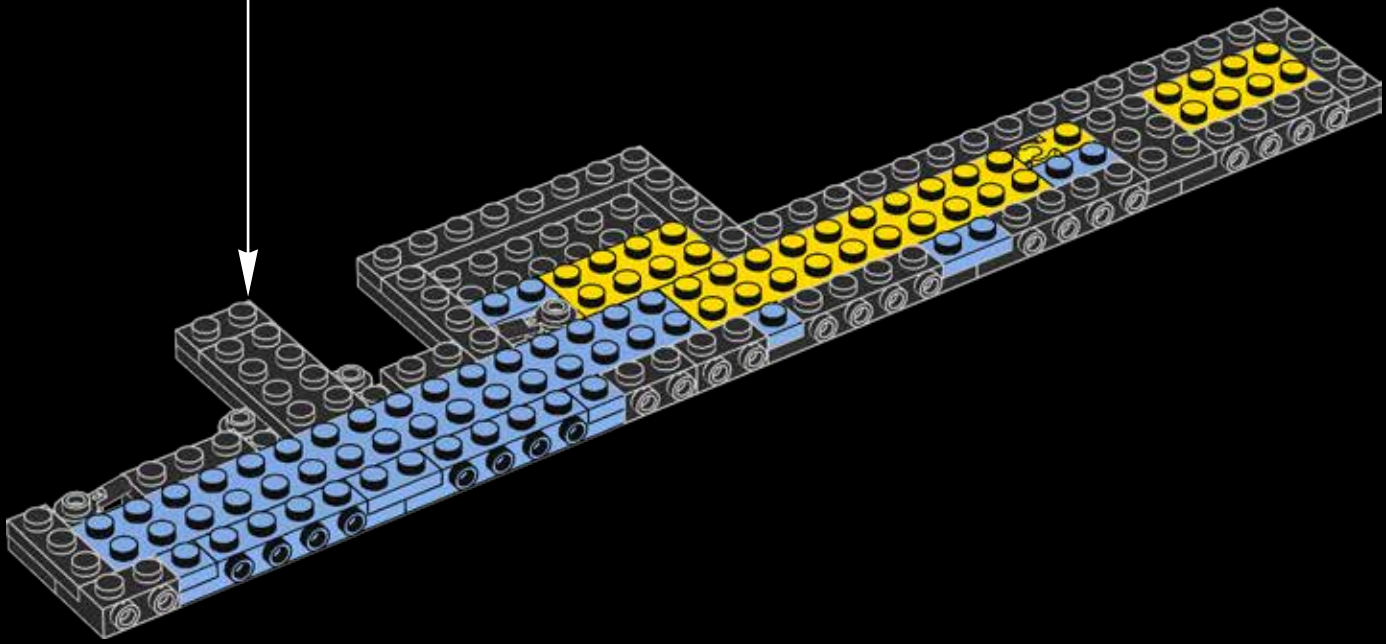
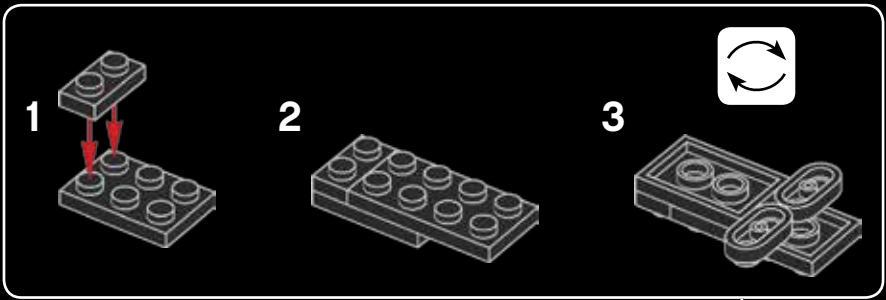
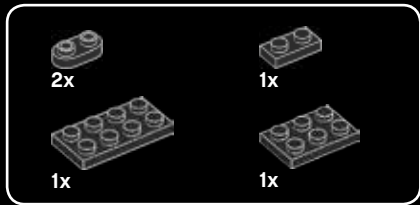



2x

18

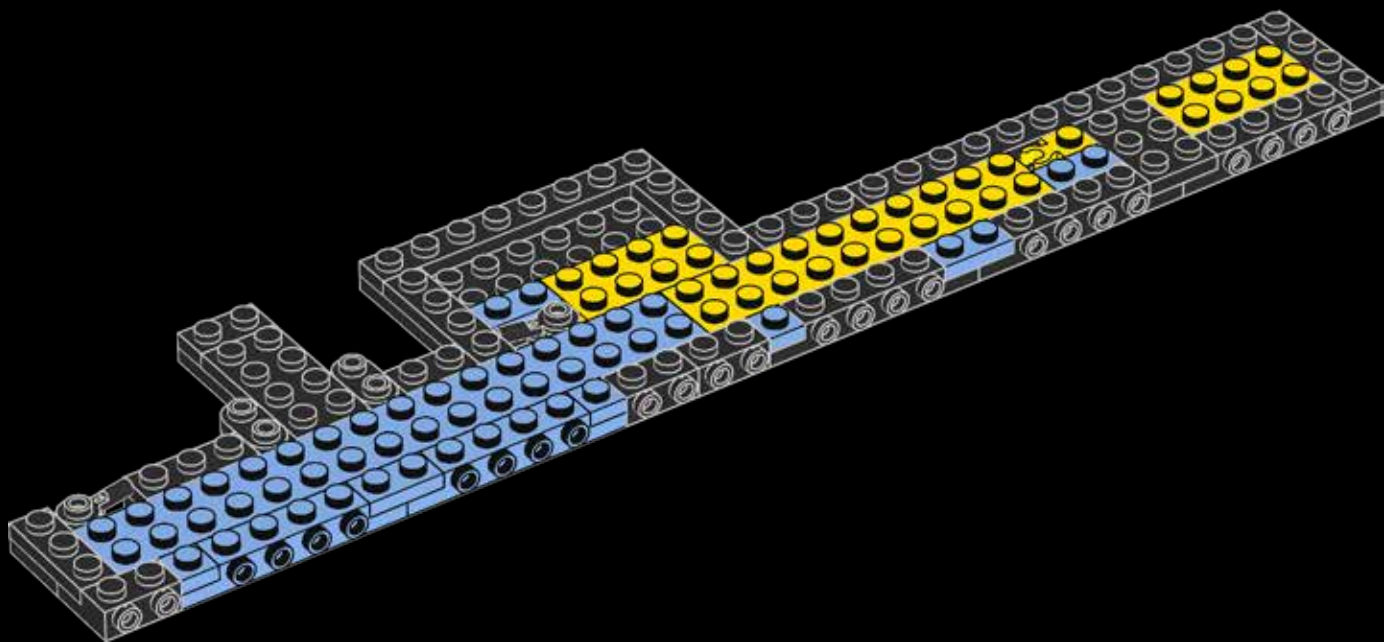

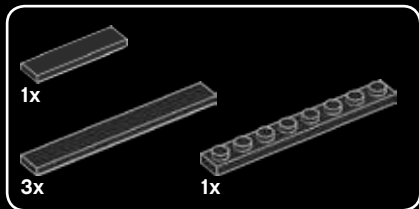

19

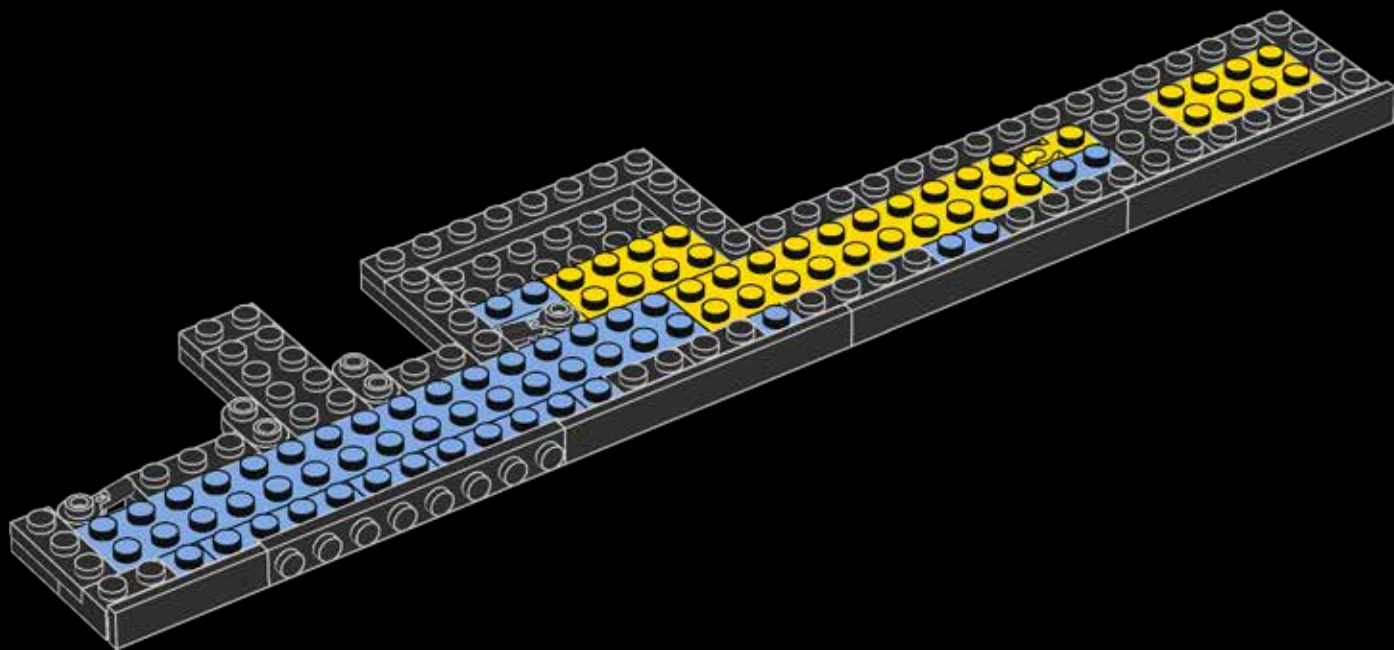

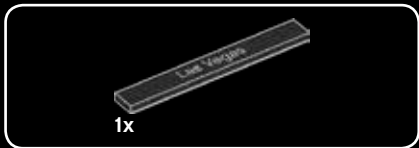

20

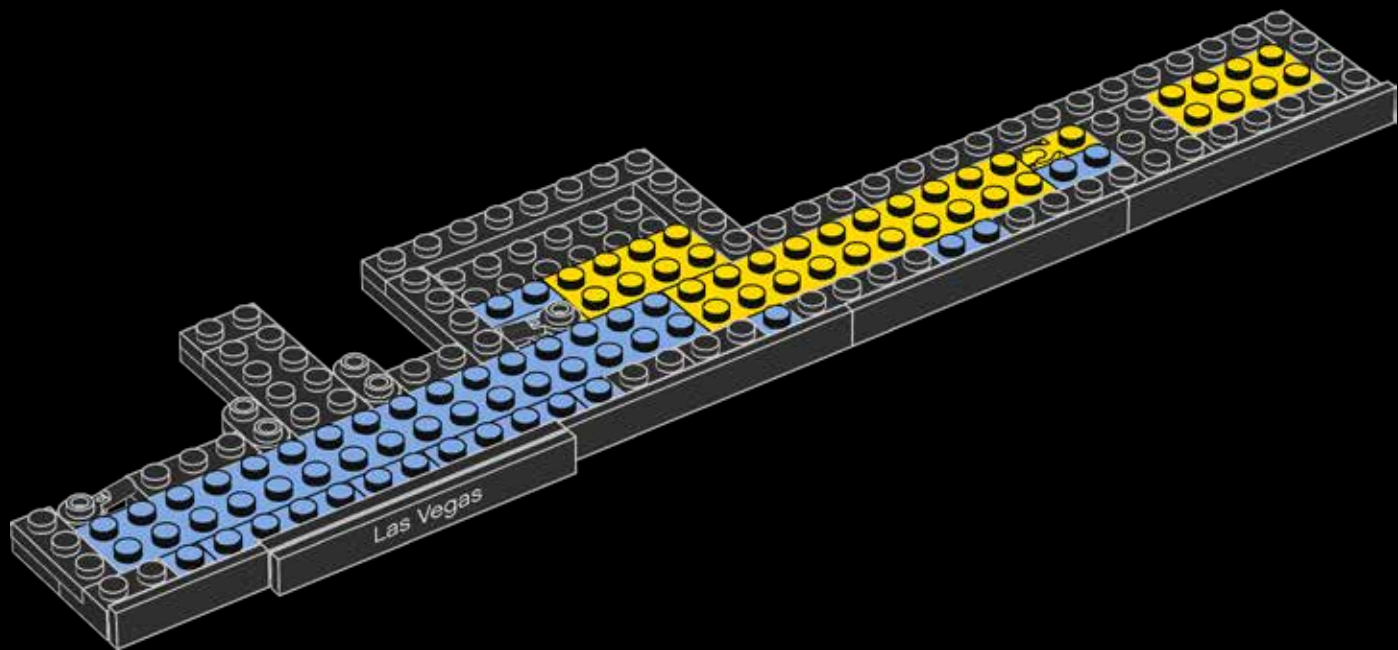



24

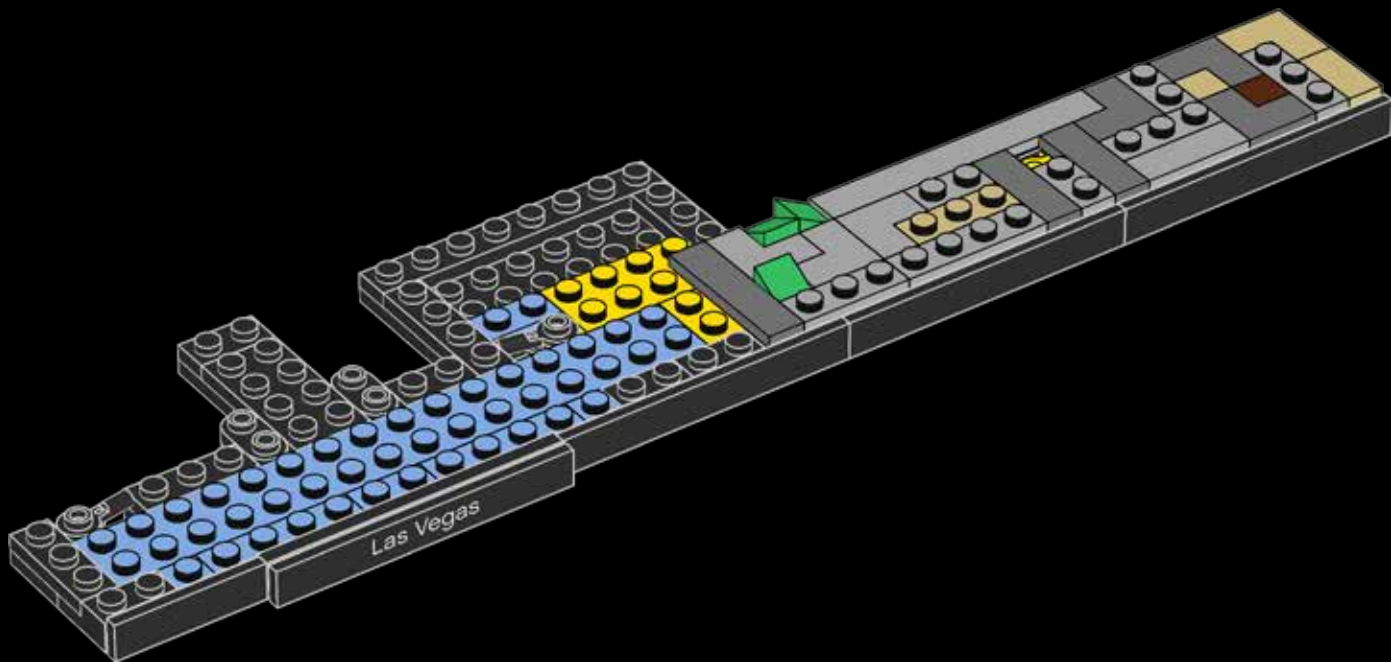

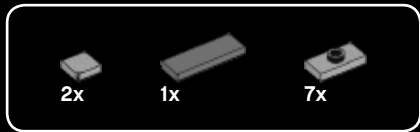

25

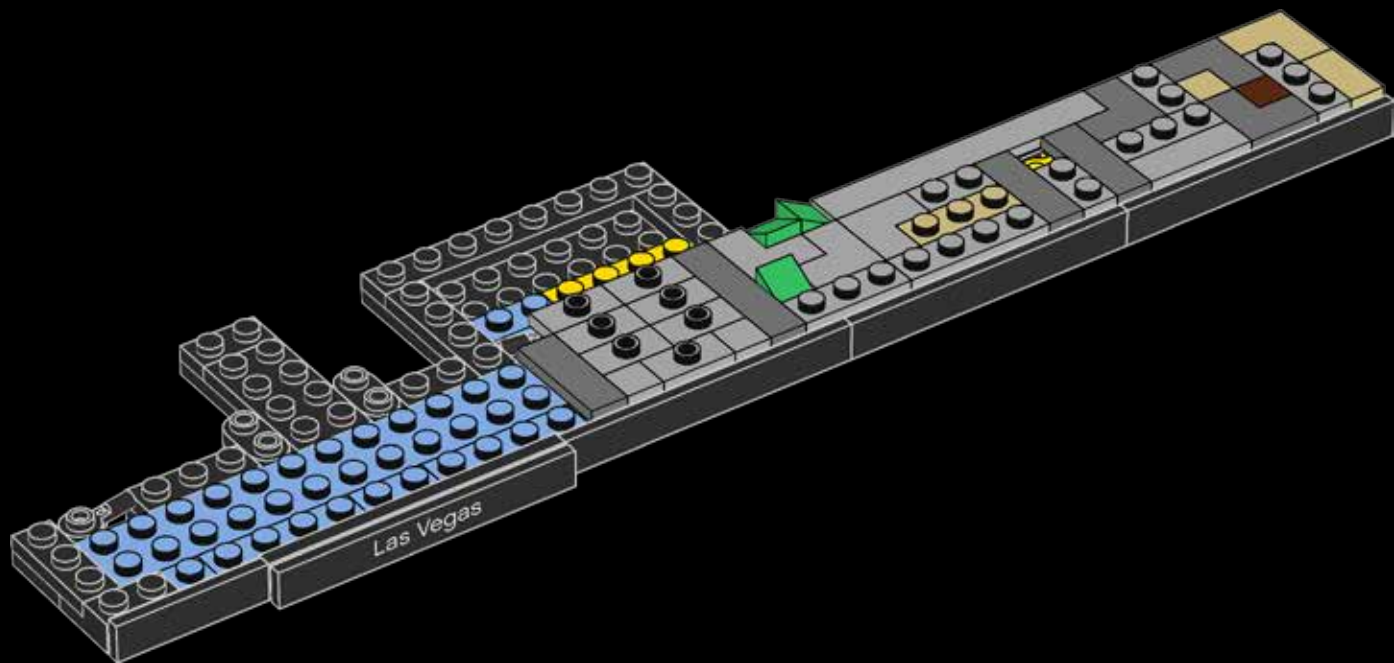



10x



4x

27





28

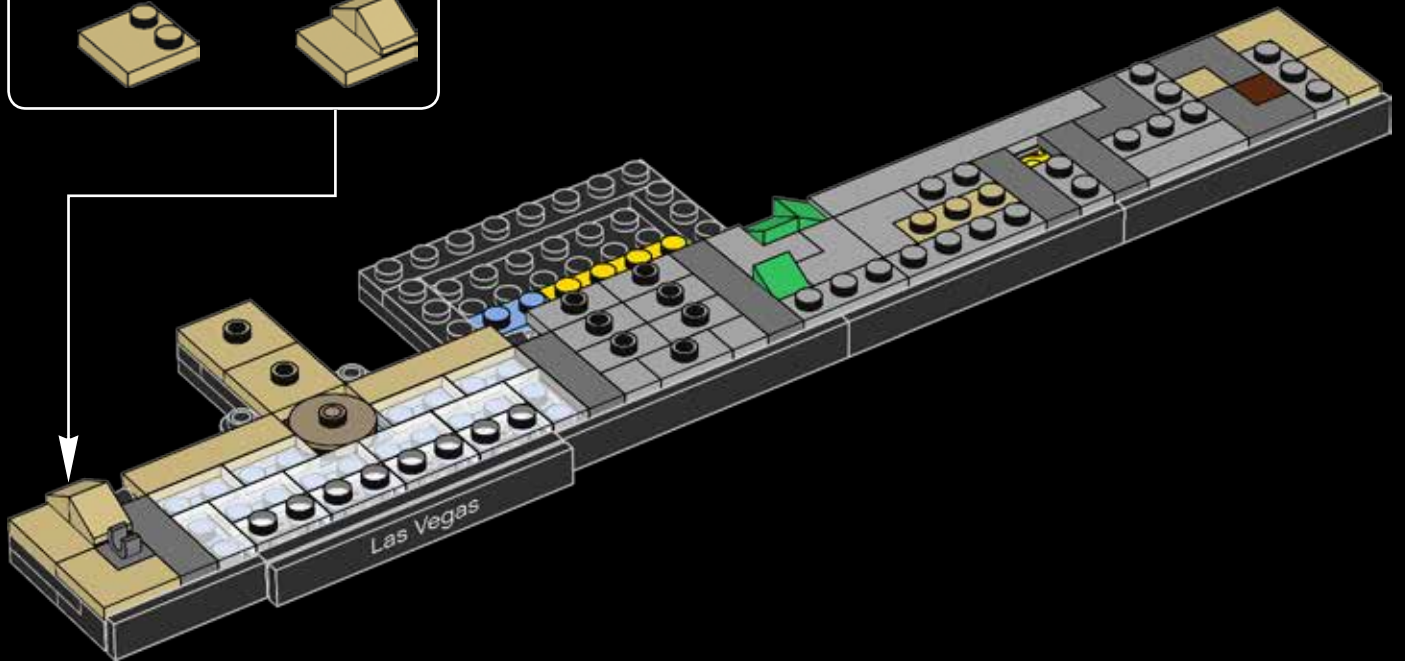
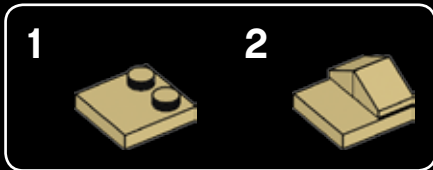



29

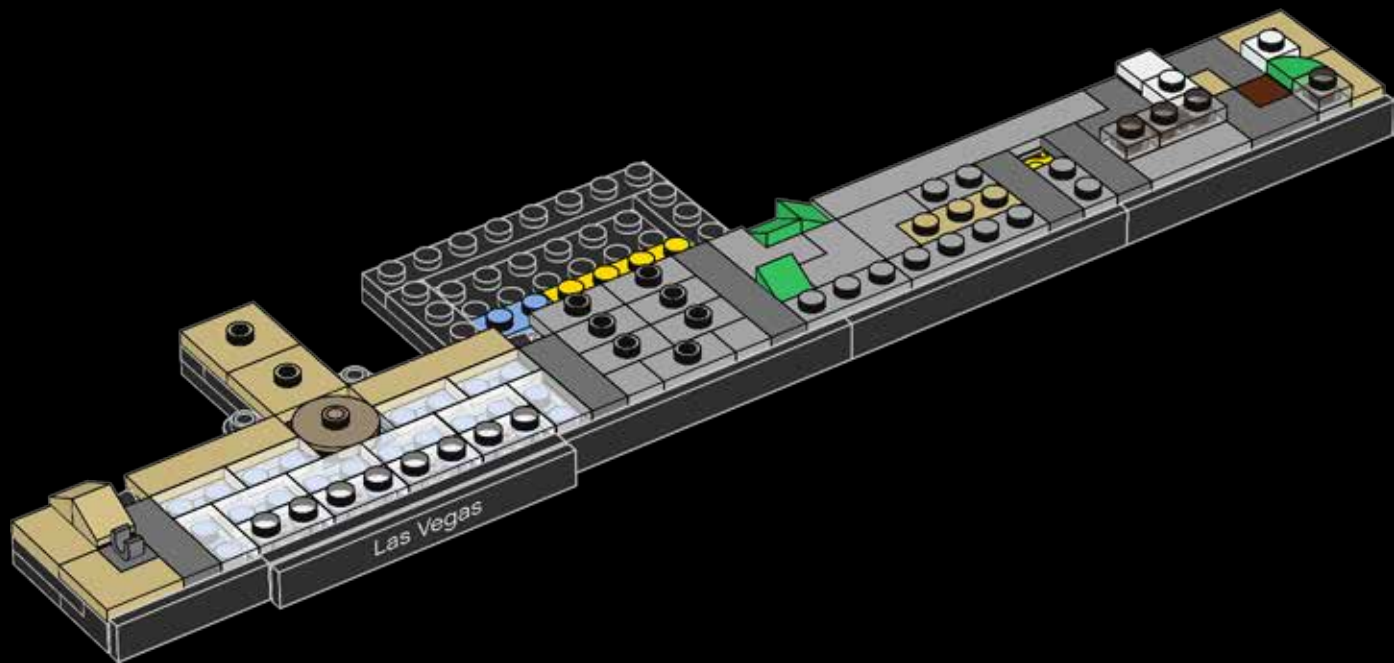



30

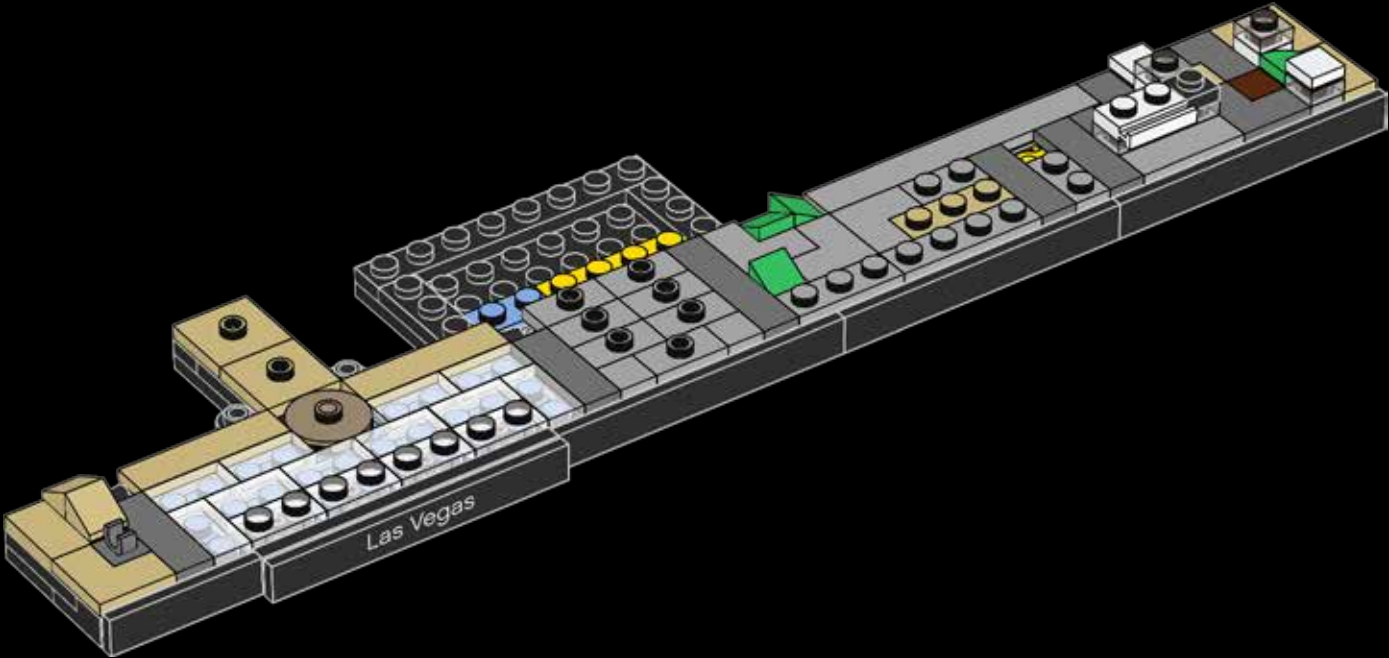



31

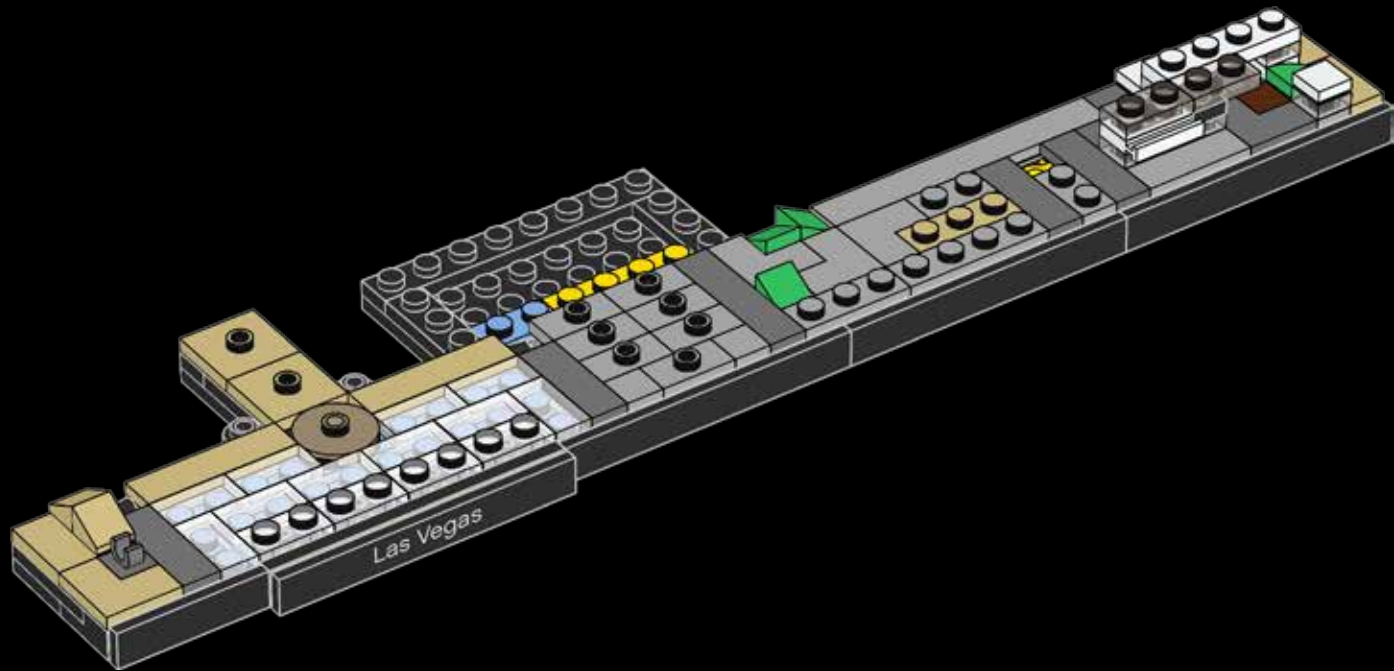



32

The Viva Vision screen that hangs above Fremont Street is the largest in the world and contains 12.5 million LED lights.

L'écran Viva Vision suspendu au-dessus de Fremont Street est le plus grand du monde et contient 12,5 millions de lumières à DEL.

La pantalla Viva Vision que cuelga sobre Fremont Street es la más grande del mundo y contiene 12,5 millones de luces LED.

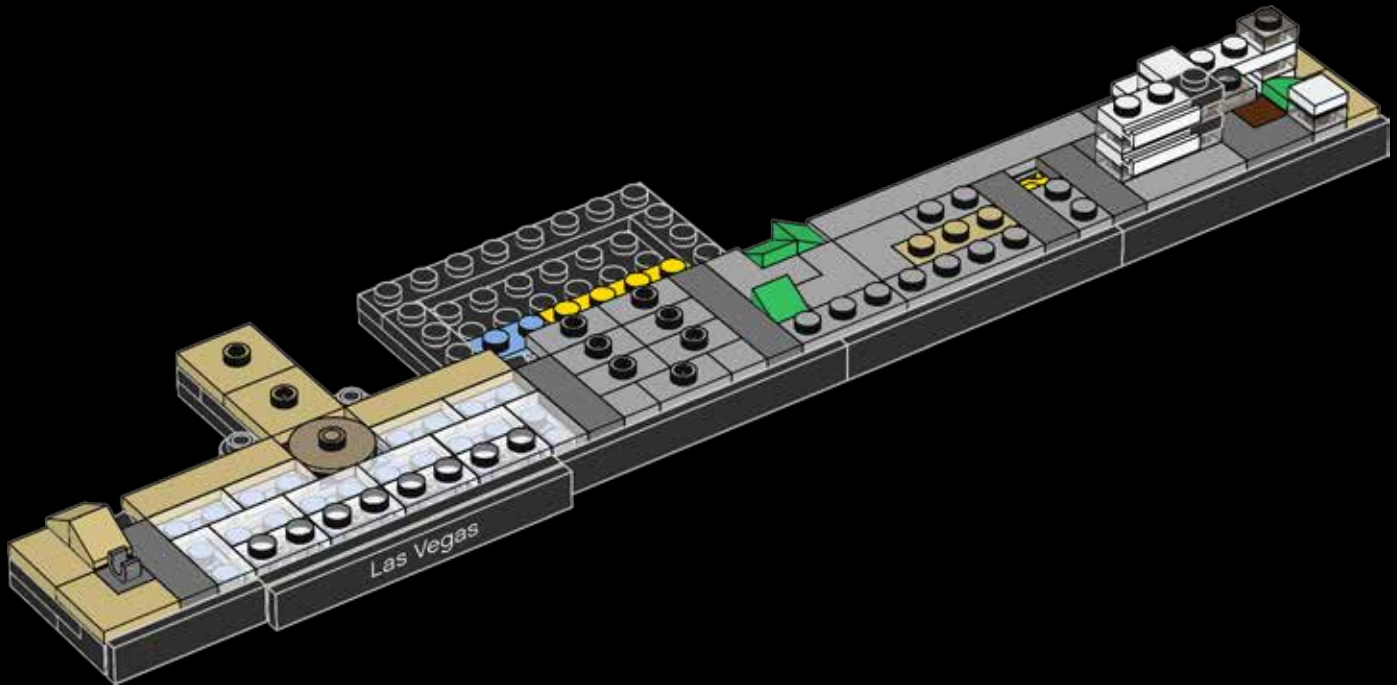



33

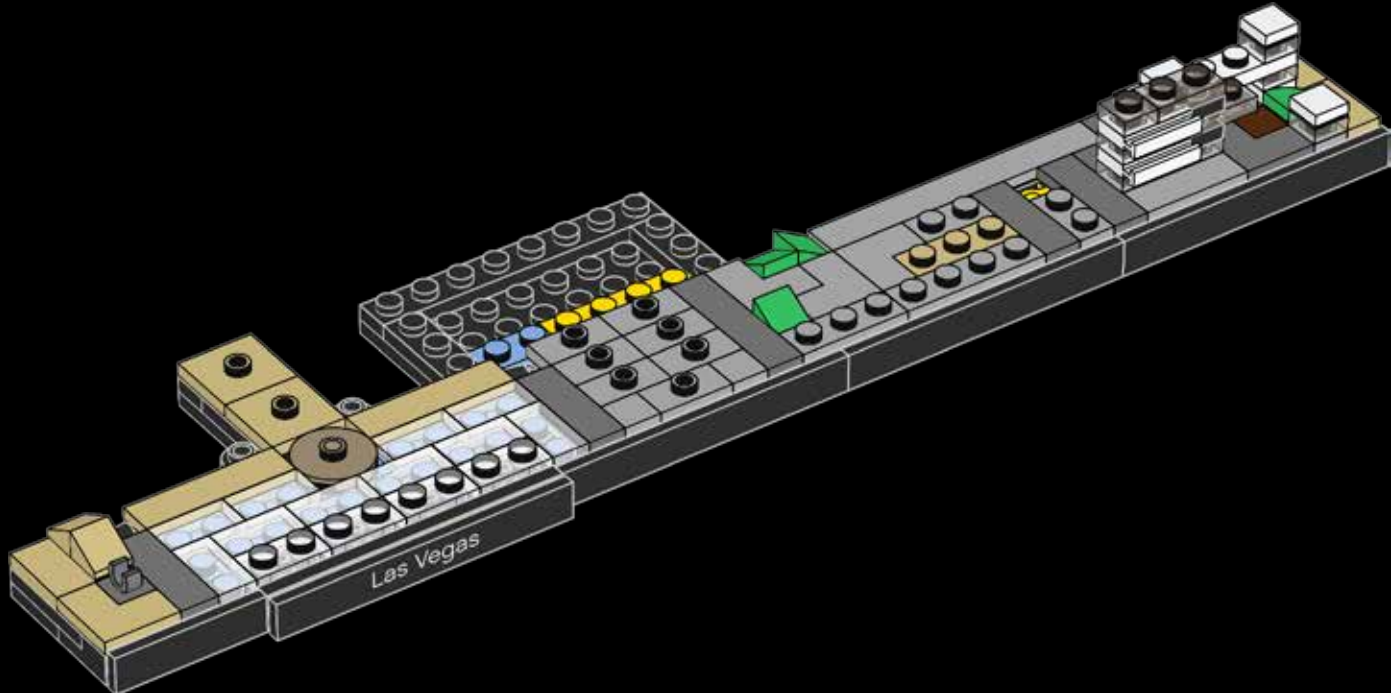



34

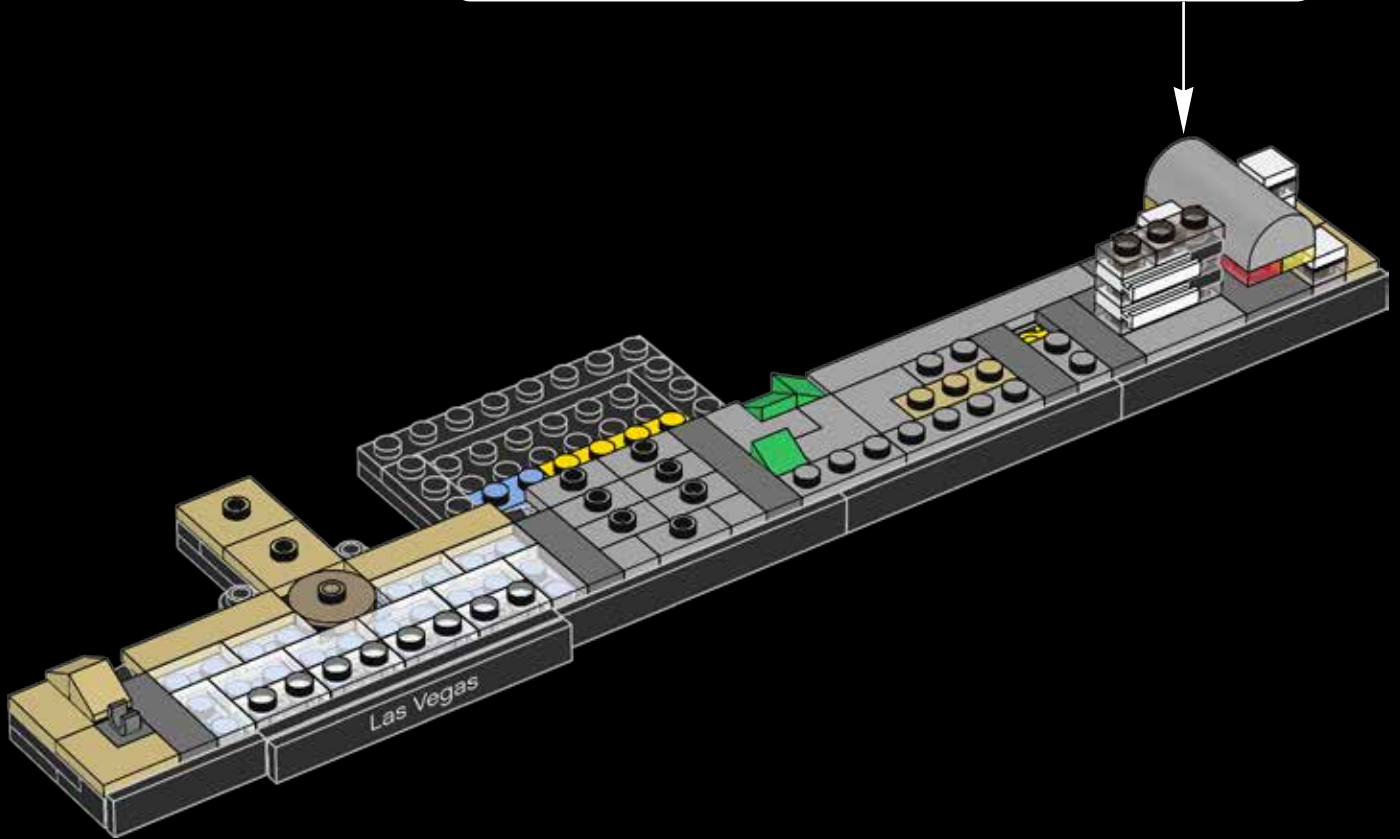
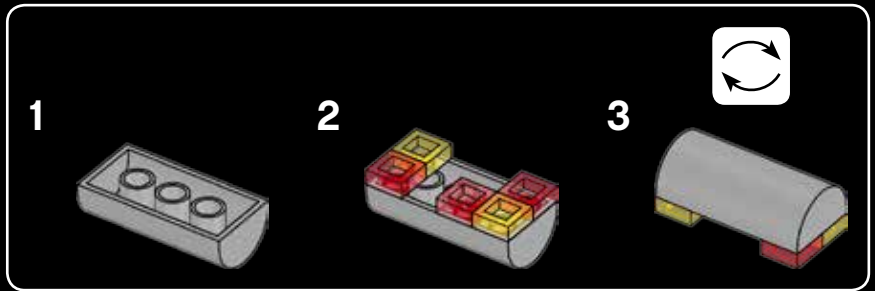



35

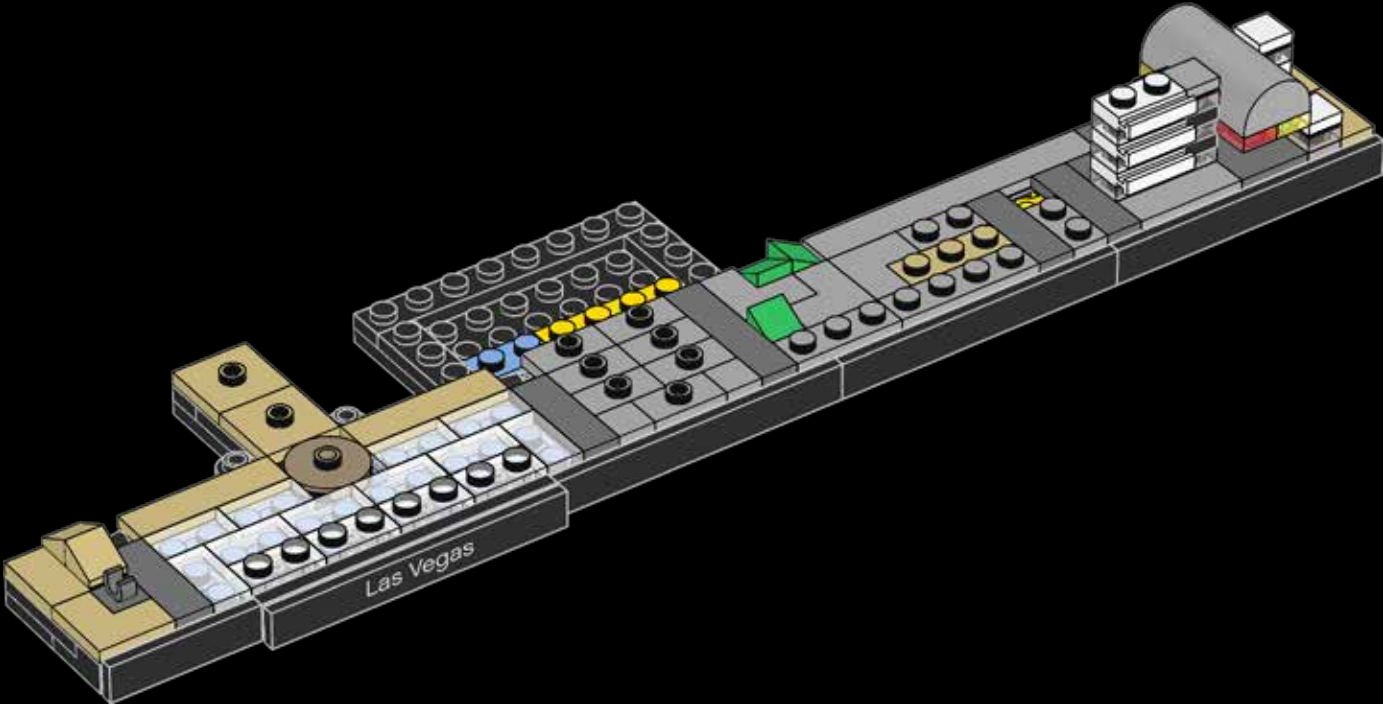



37

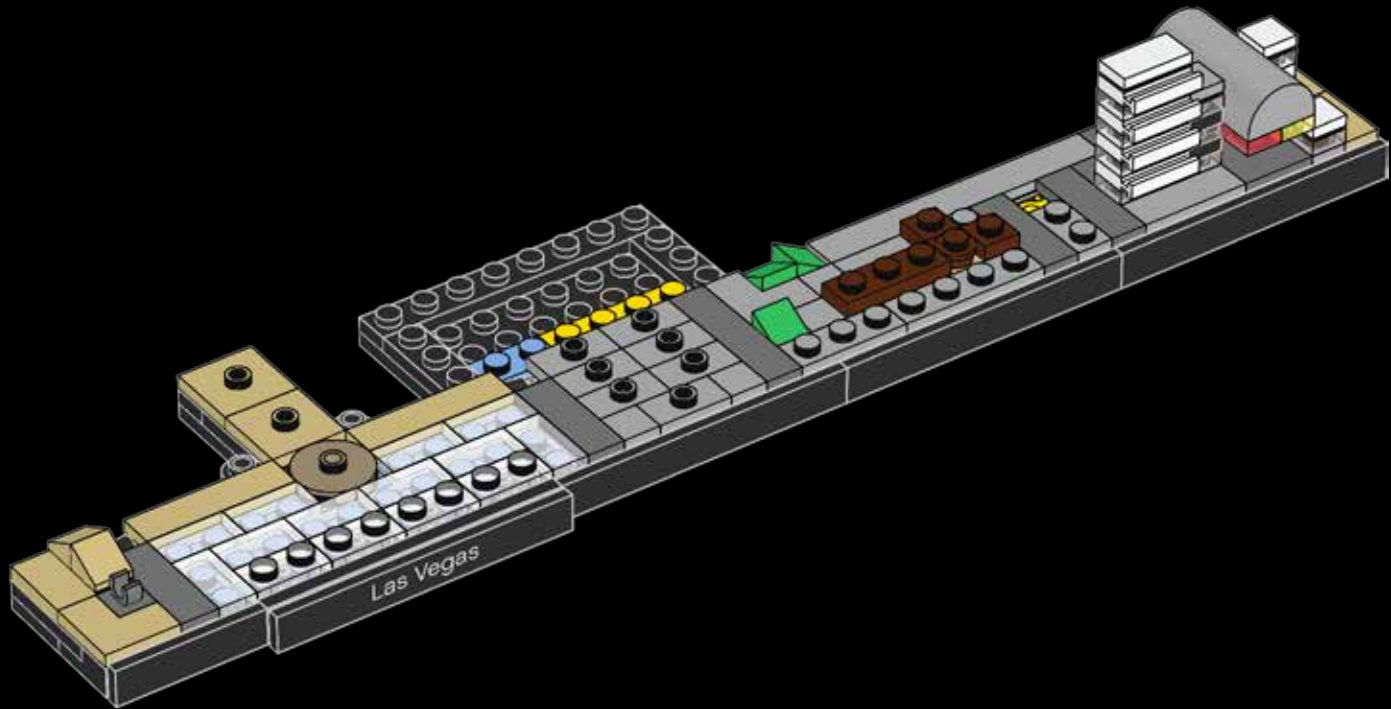



1x



7x

38

Fremont Street was nicknamed "Glitter Gulch" due to the number of its colorful neon signs.

Fremont Street était surnommée « le ravin scintillant » en raison de ses nombreuses enseignes de néon colorées.

Fremont Street fue apodada «Glitter Gulch» por su gran número de anuncios de neón de colores.

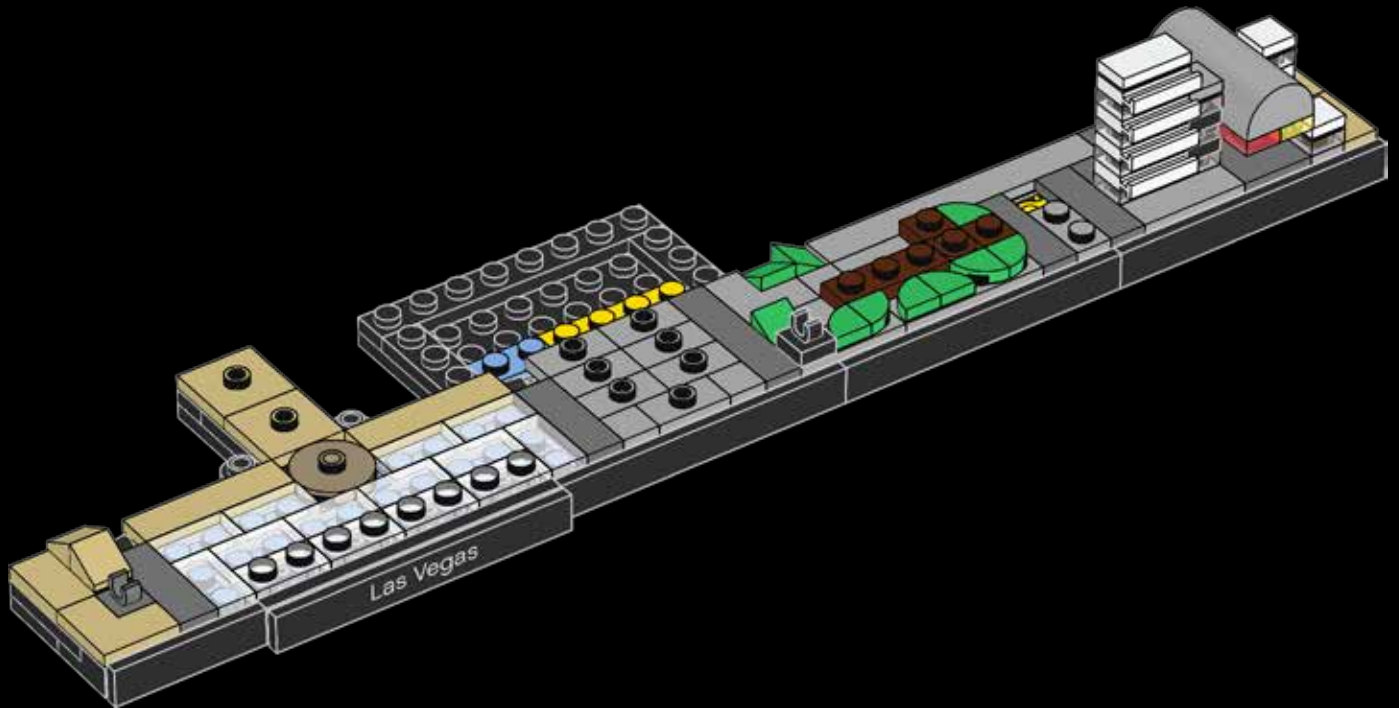

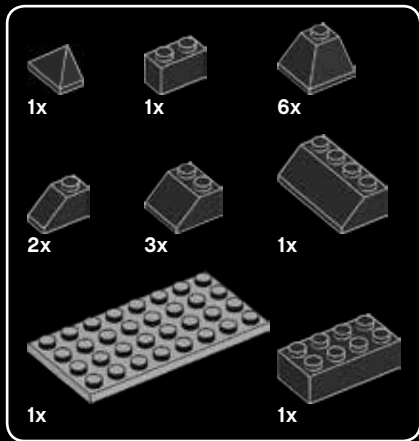

39

1

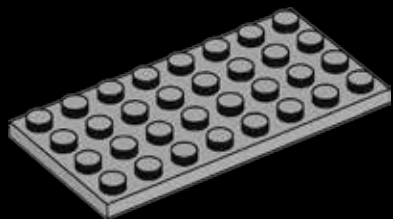

2

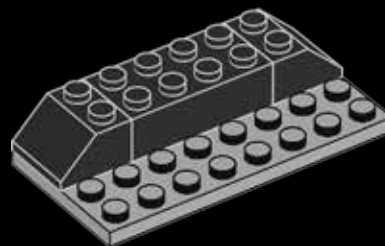

3

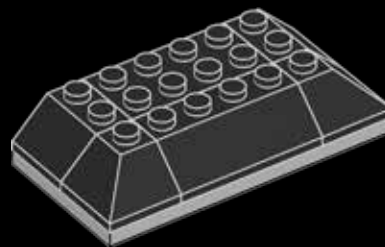

4

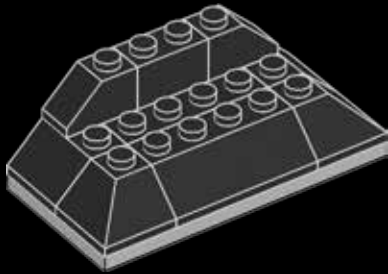

5

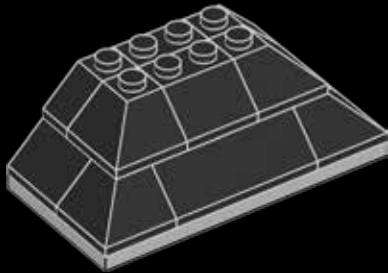

6

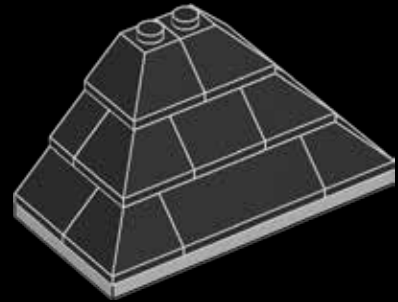

7

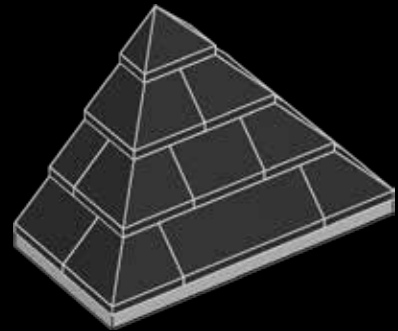

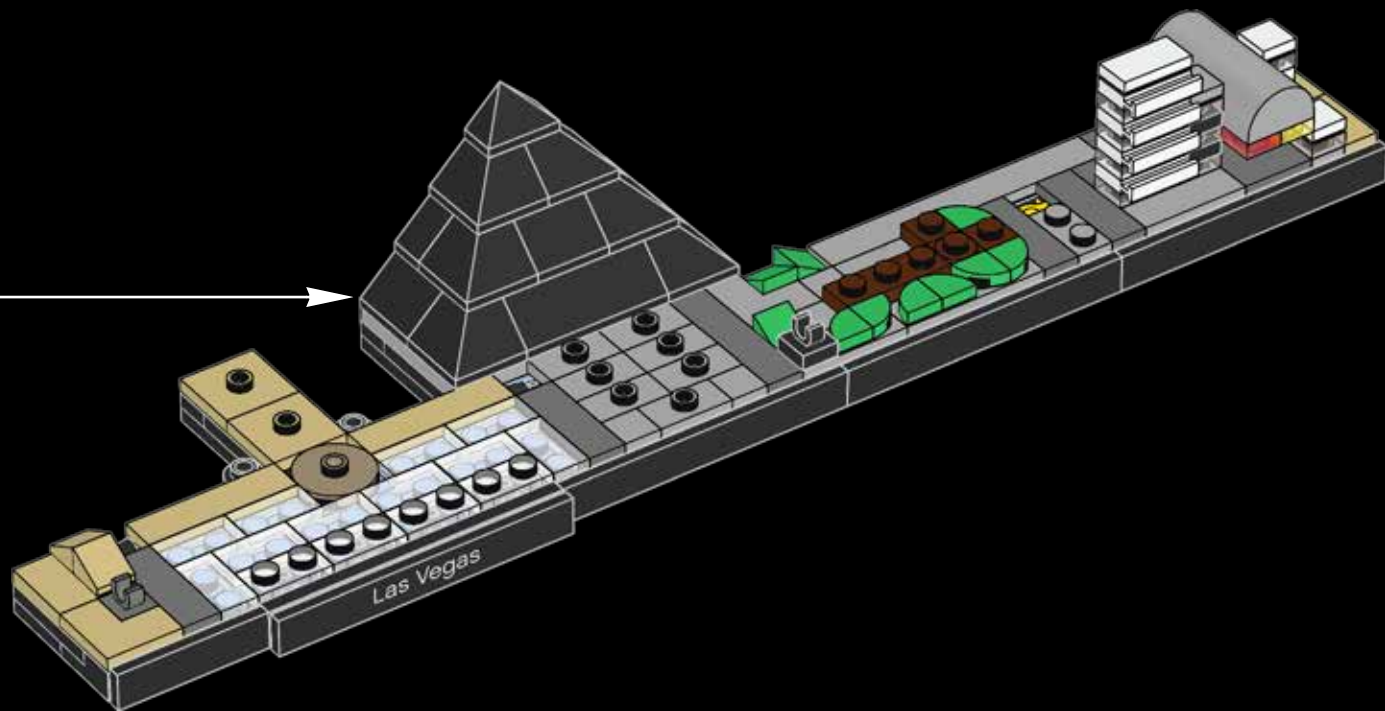



40

The Luxor Las Vegas includes special elevators, known as Inclinator, to run along its diagonal sides.

Le Luxor Las Vegas comprend des ascenseurs spéciaux qui grimpent en diagonale sur les arêtes de la pyramide.

El Luxor Las Vegas cuenta con elevadores especiales conocidos como «inclinadores» que recorren sus caras diagonales.

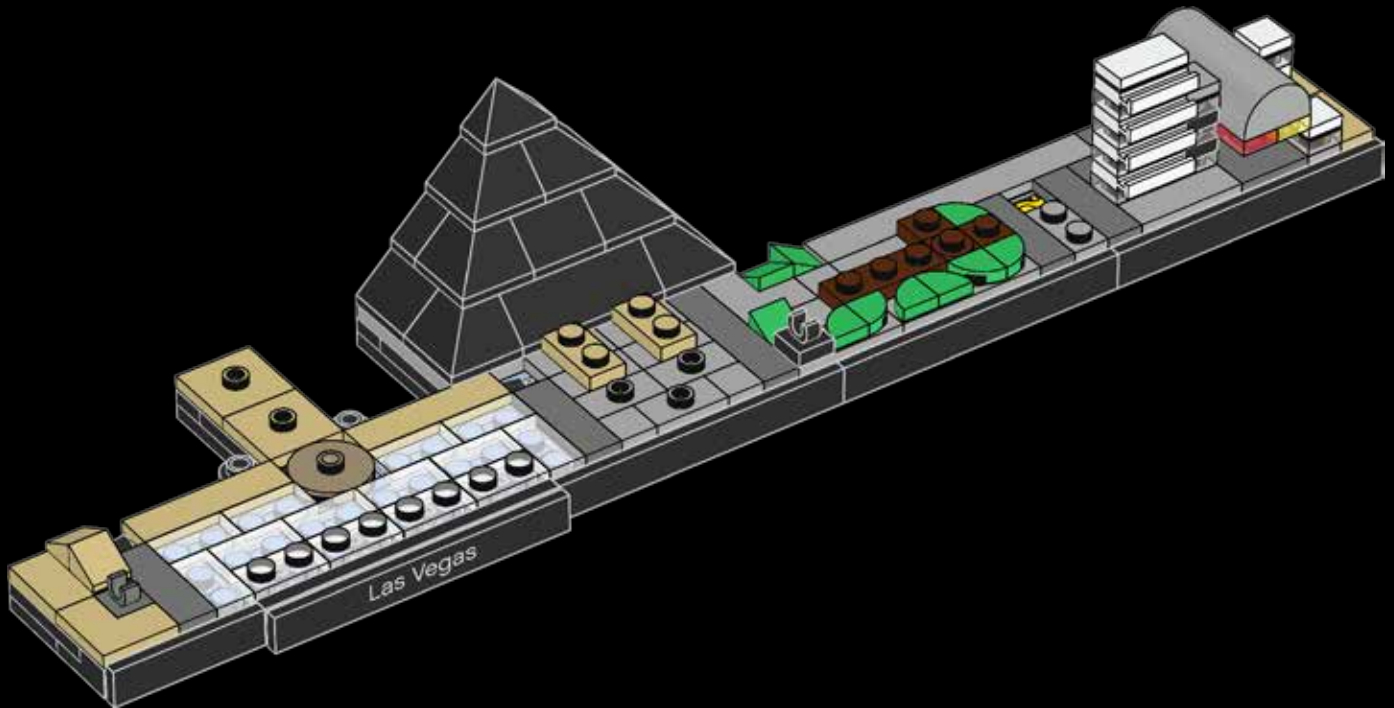



41

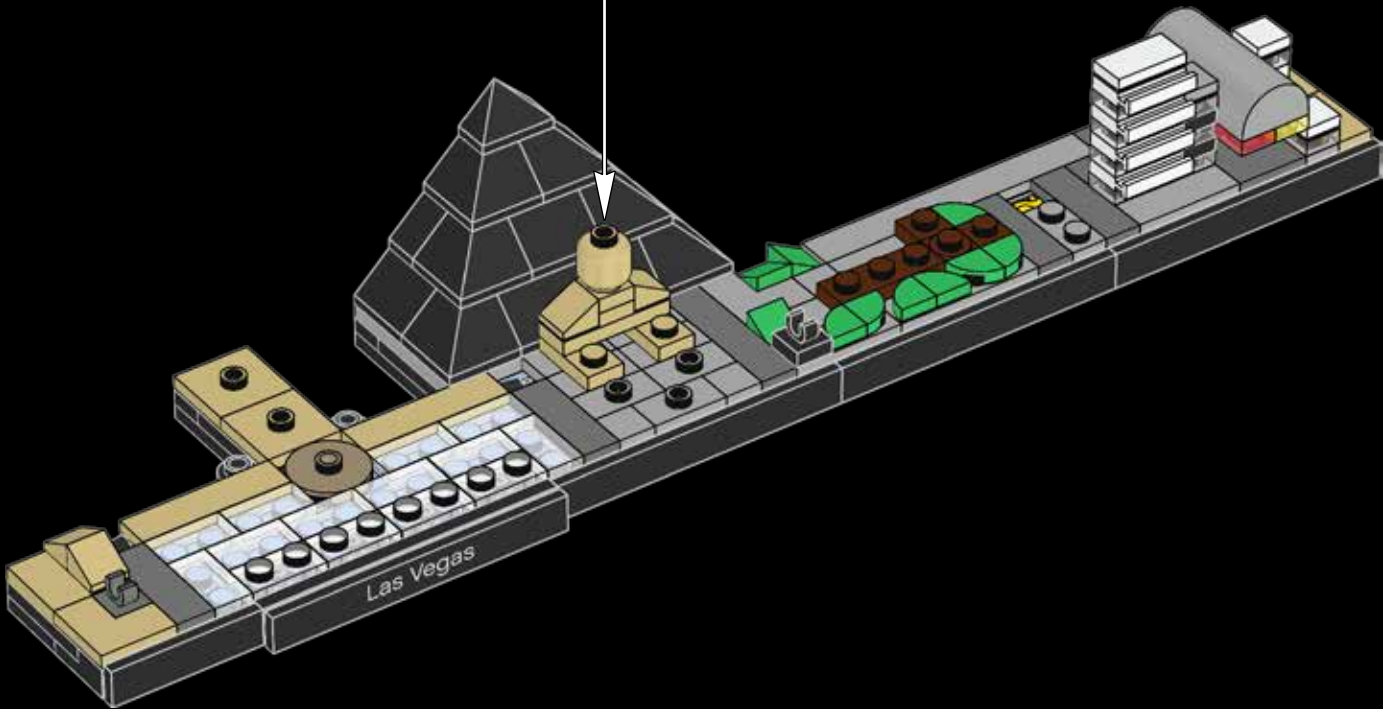
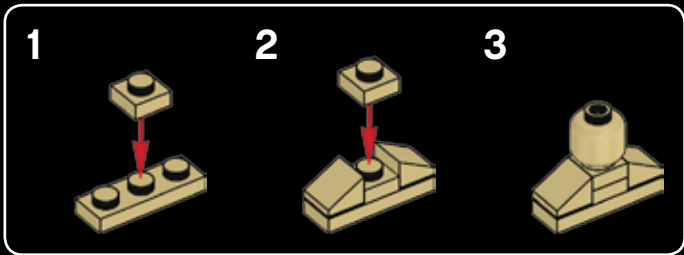



2x



2x

42

The Luxor Las Vegas' Sphinx, a re-creation of the Great Sphinx of Giza, is 101 ft. (30.8 m) high, 32.9 ft. (10 m) taller than the original.

Le sphinx du Luxor Las Vegas est une reproduction du grand sphinx de Gizeh. À 30,8 m de hauteur, il est 10 m plus haut que l'original.

La esfinge del Luxor Las Vegas recrea la Gran Esfinge de Guiza y mide 30,8 m de altura, 10 m más que la original.

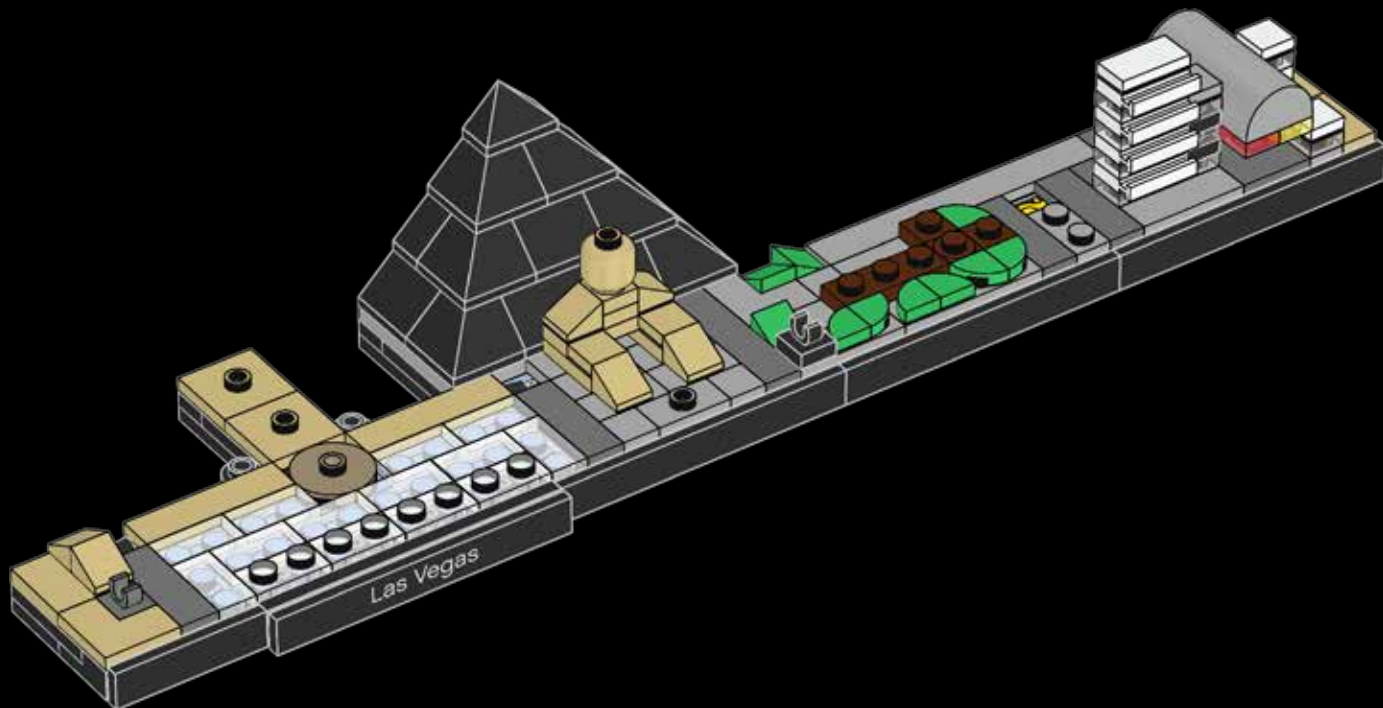



1x

43

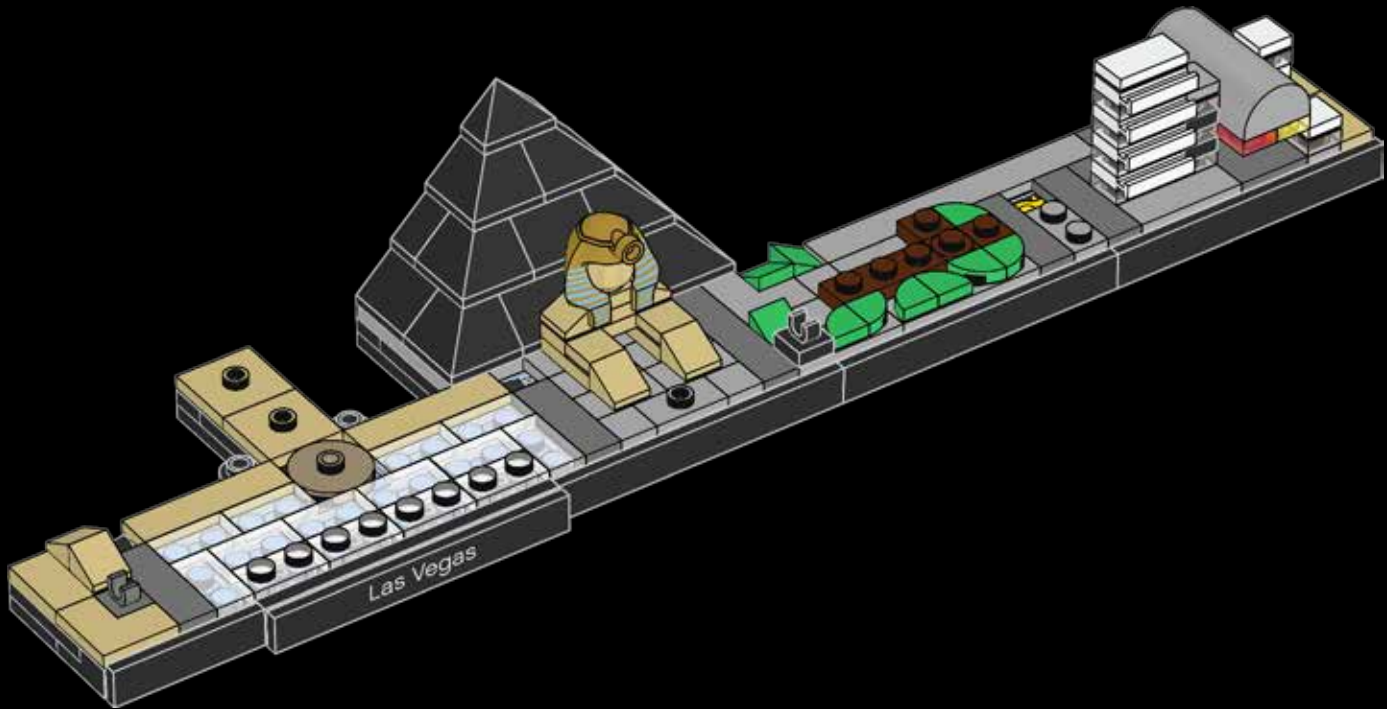



44

1



2

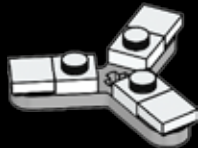

3



4



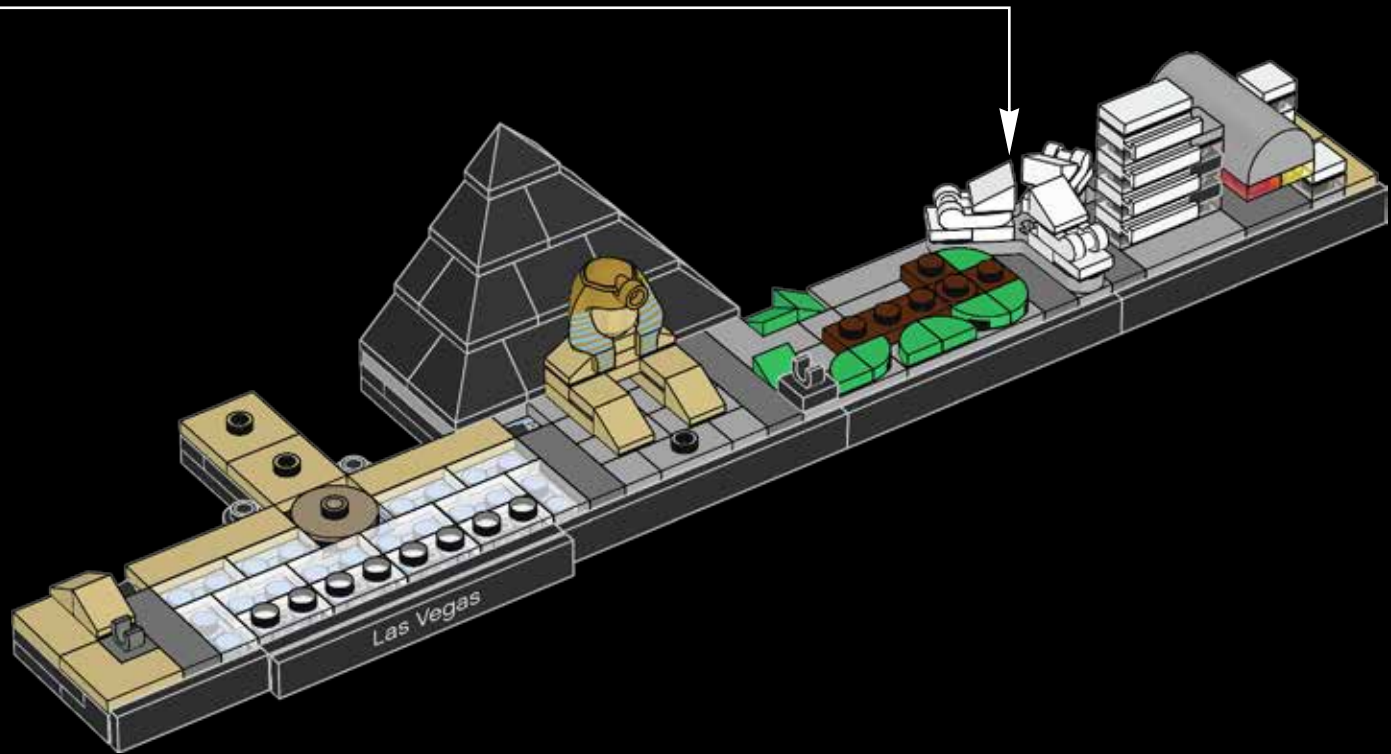



45

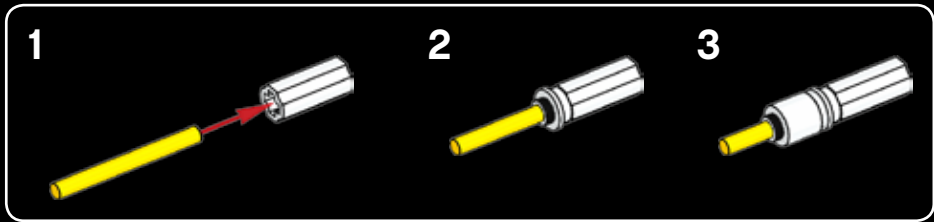

Construction on the tower began in February 1992. It was completed in April 1996, at a cost of \$32 million.

La construction de la tour a commencé en février 1992. Elle s'est achevée en avril 1996, pour un coût total de 32 millions de dollars.

La construcción de la torre comenzó en febrero de 1992. Fue terminada en abril de 1996 y costó 32 millones de dólares.

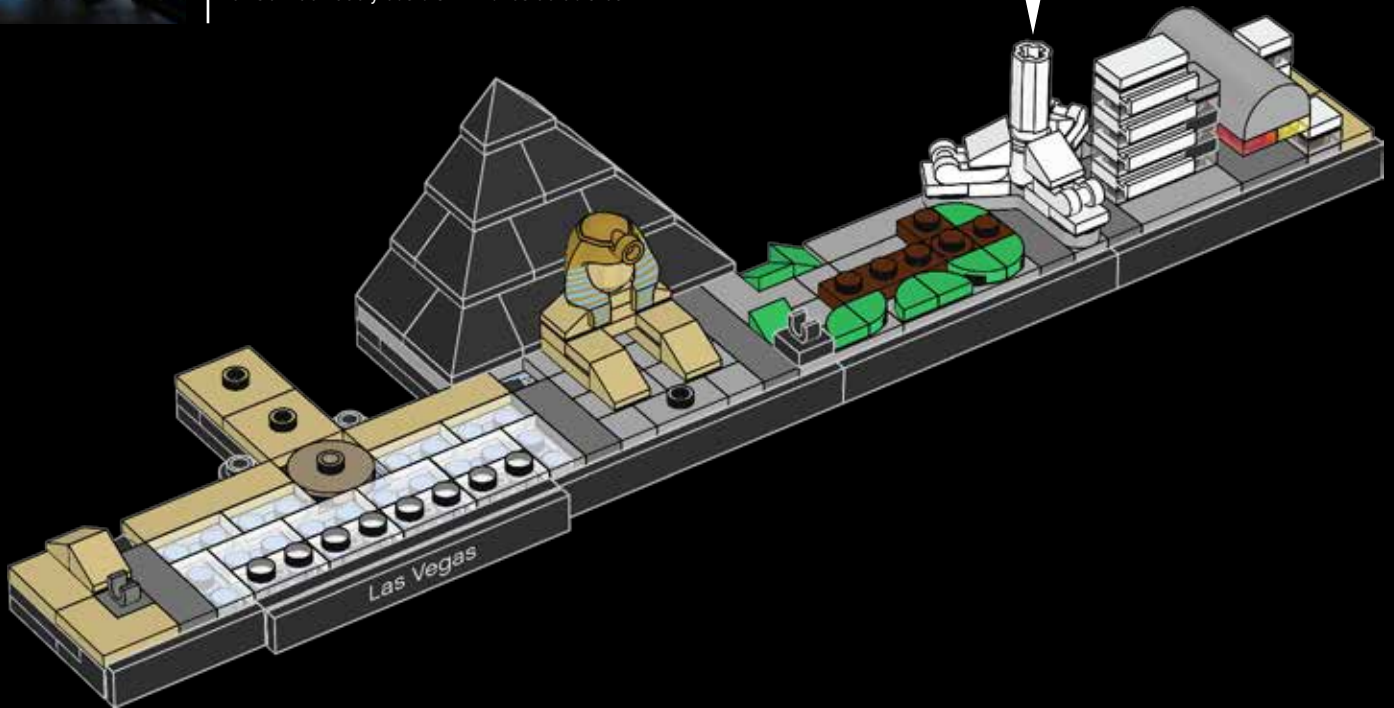

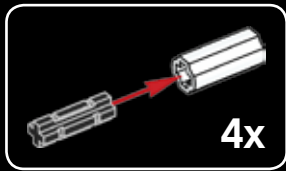

46

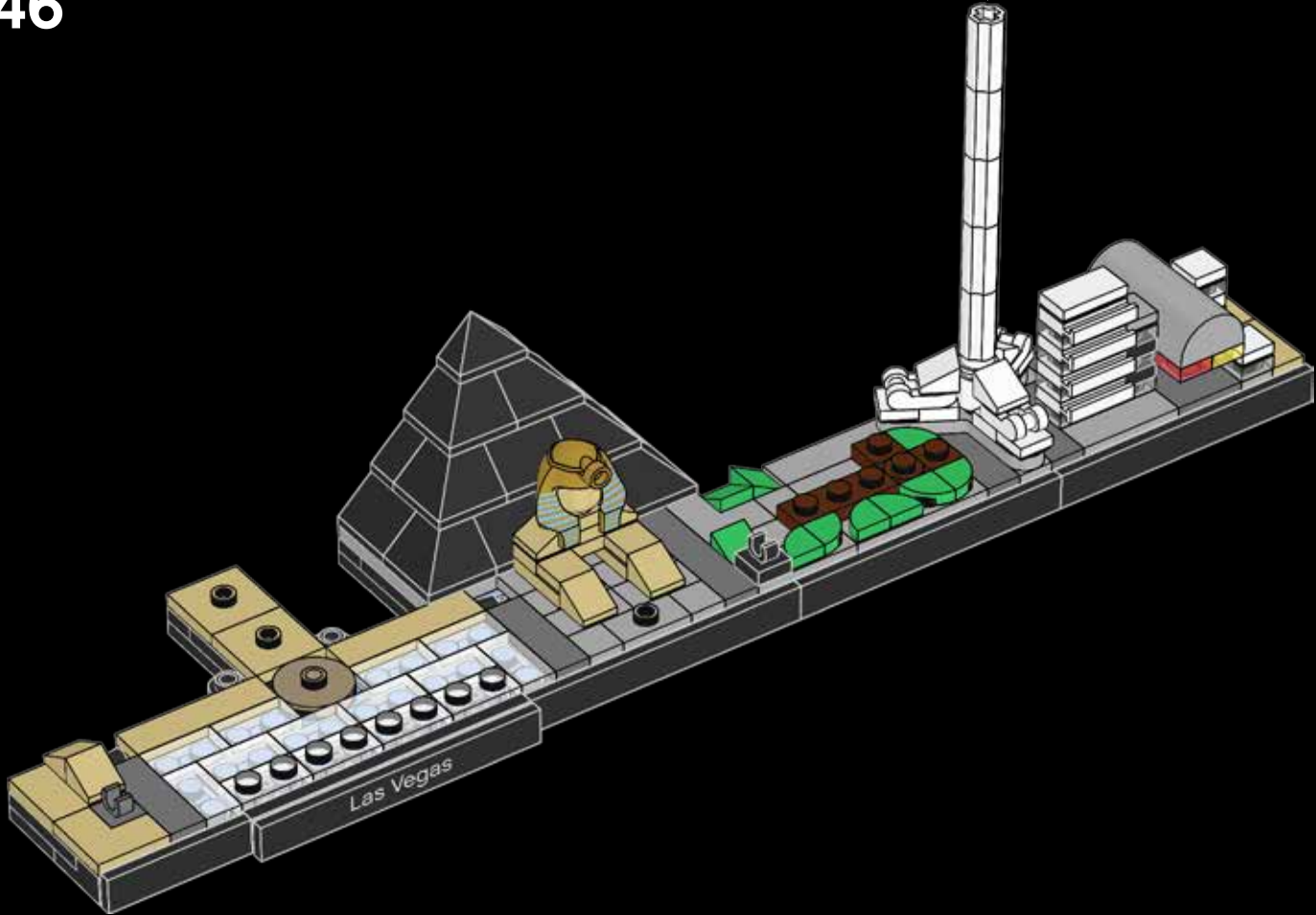

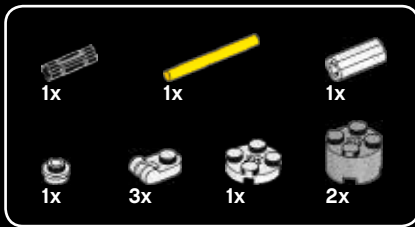

47

1



2



3

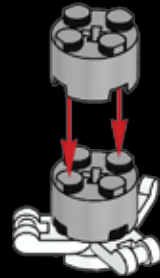

1

2



4

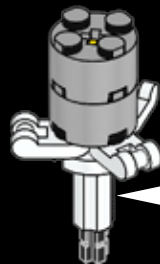

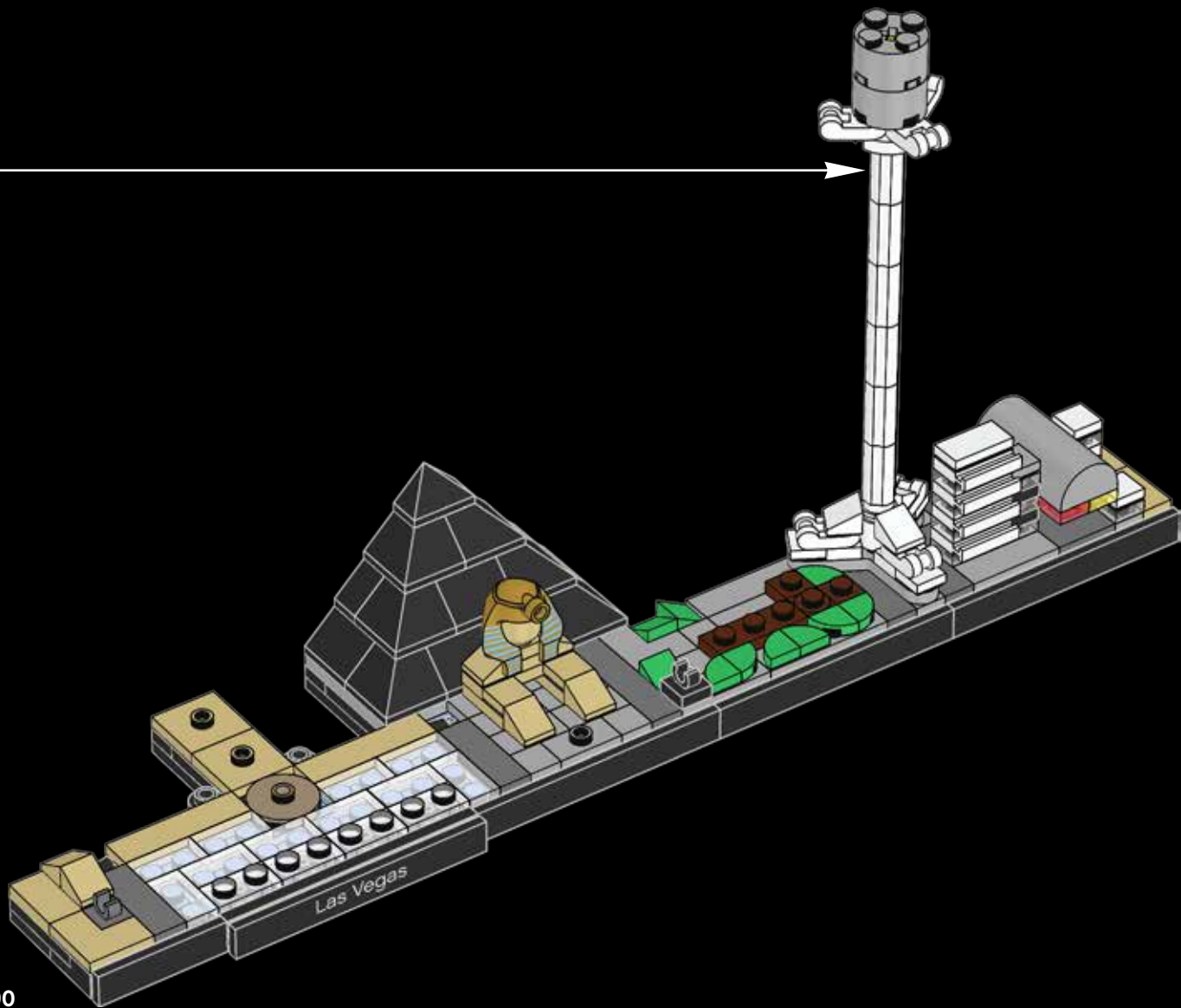



48

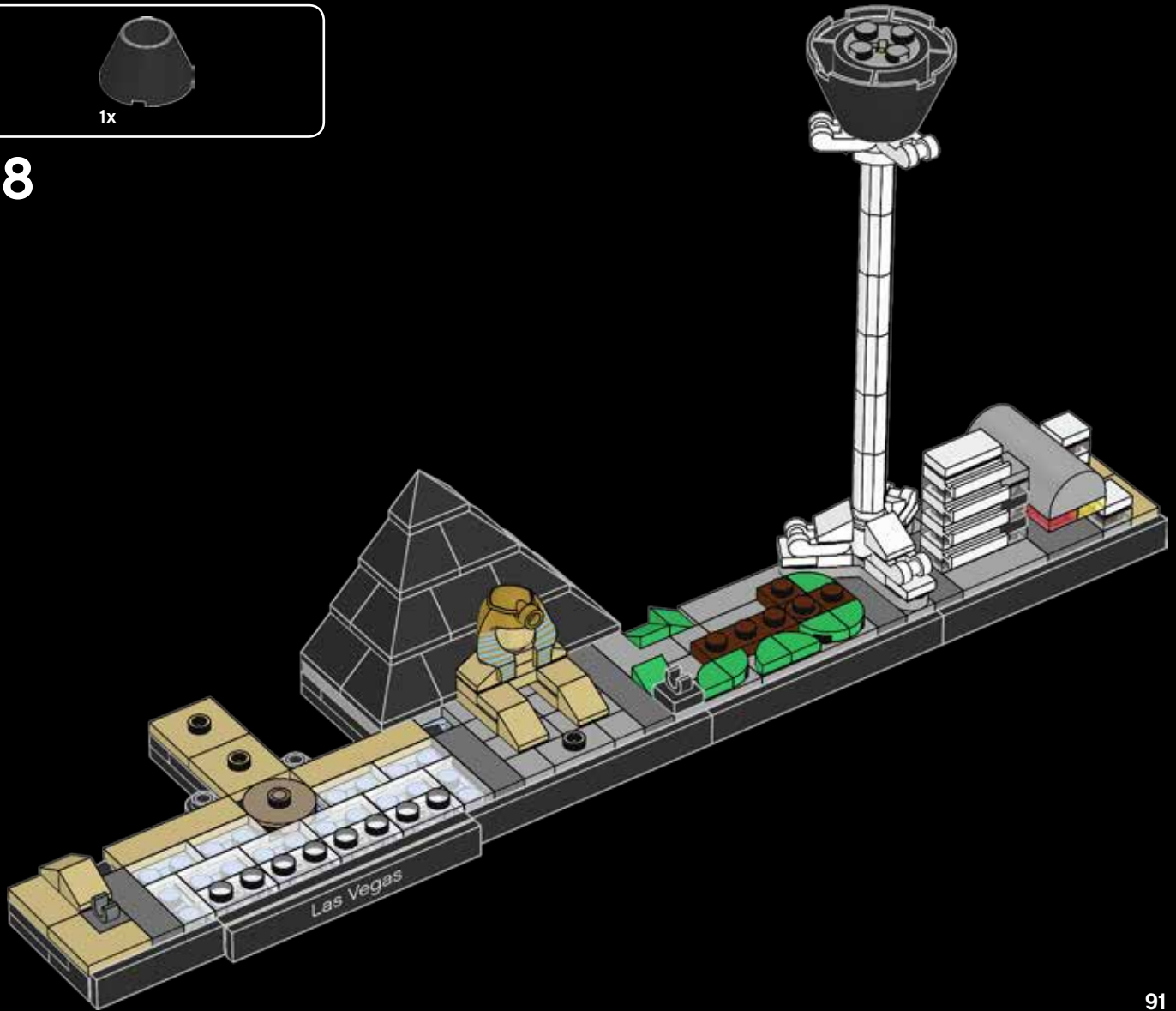



49

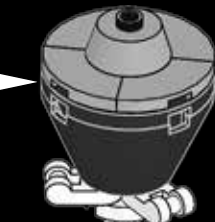
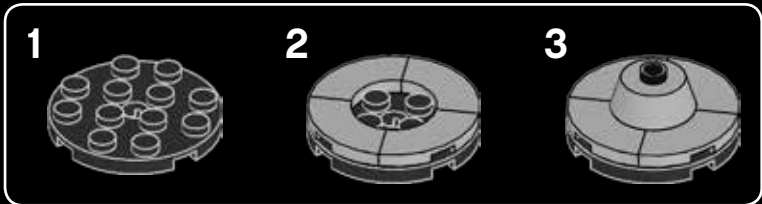



50

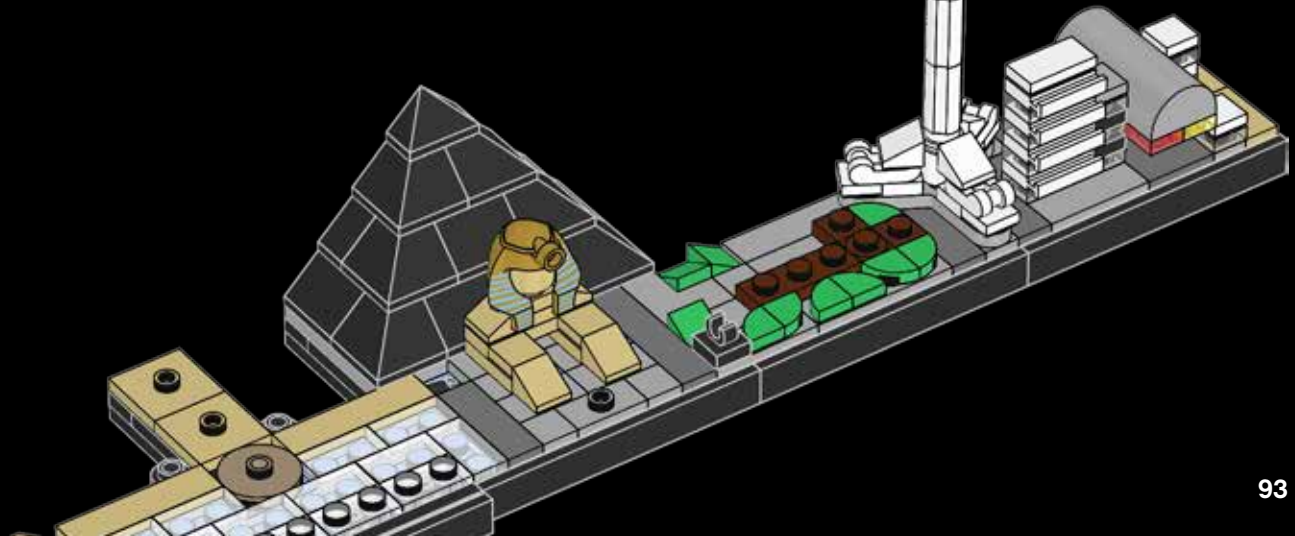
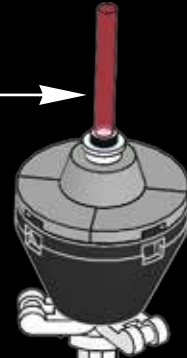
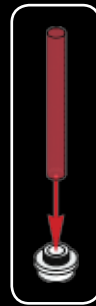

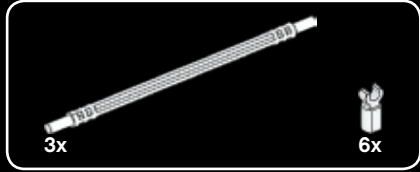

51



2

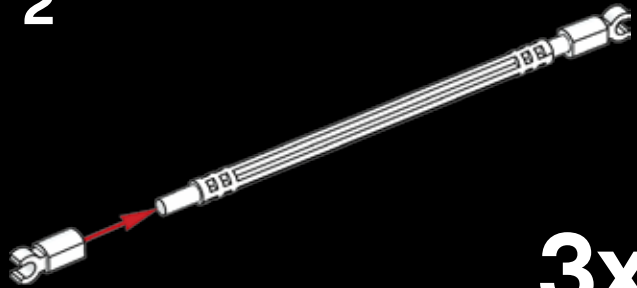

3x

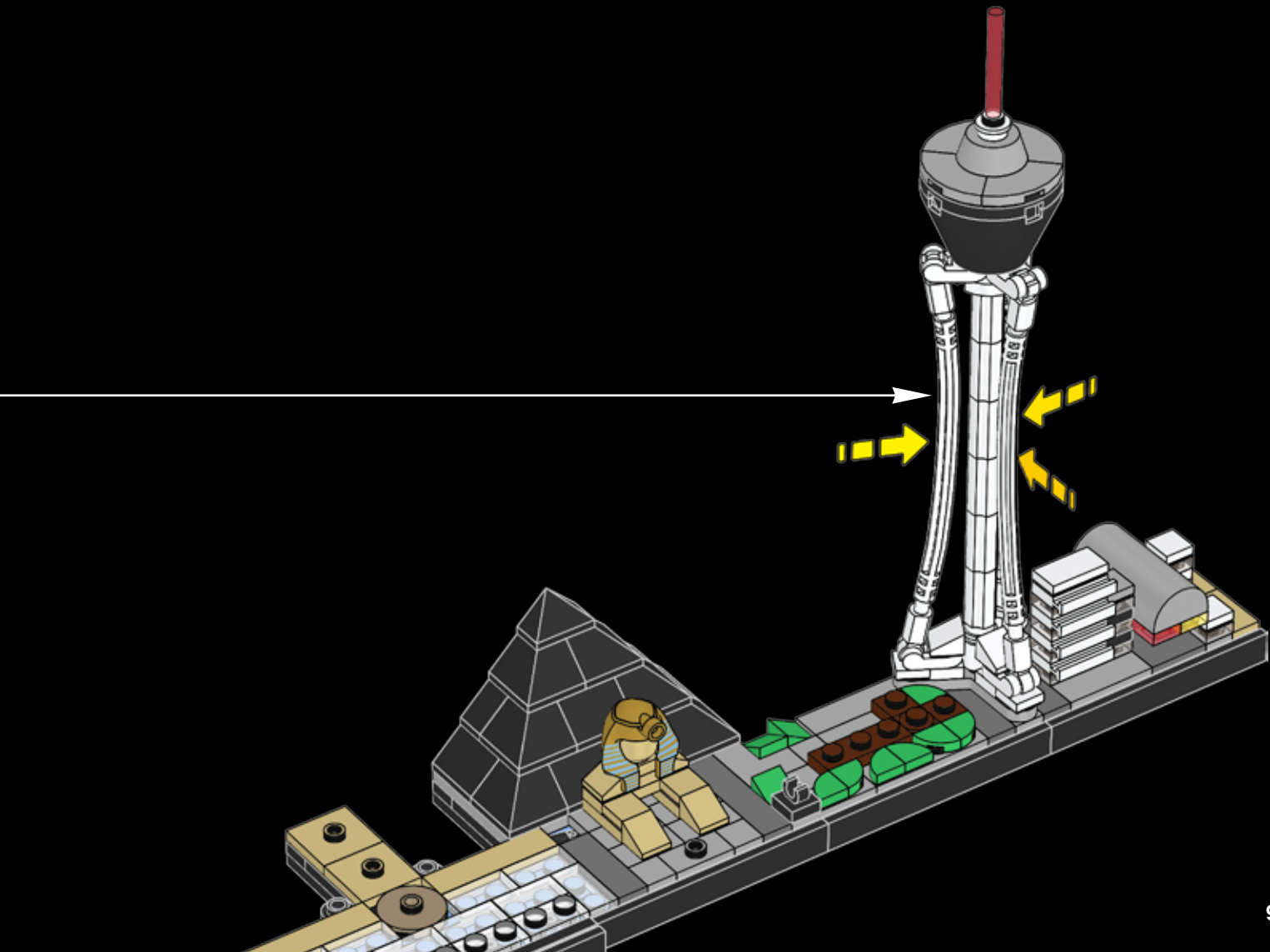



52

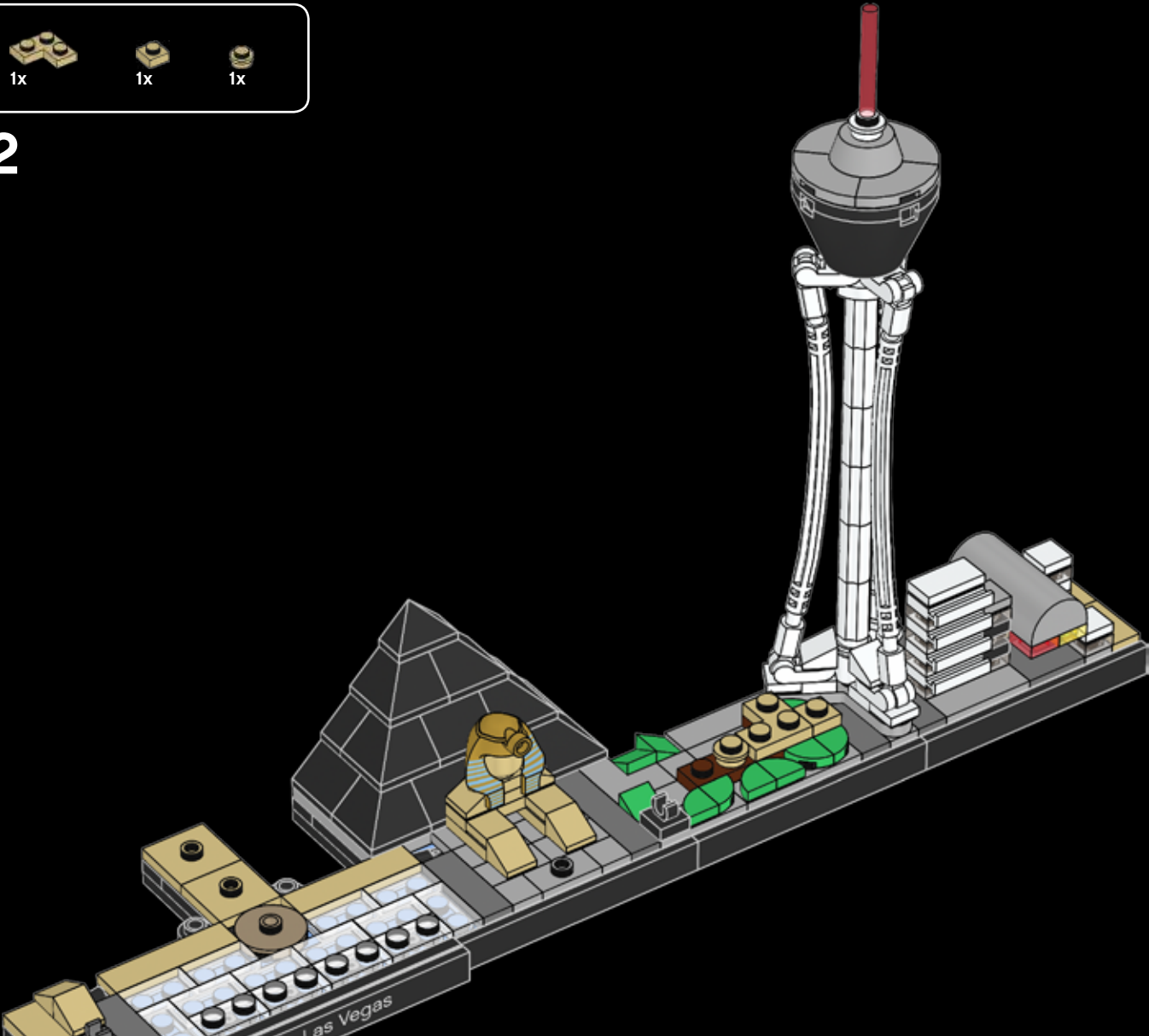



53

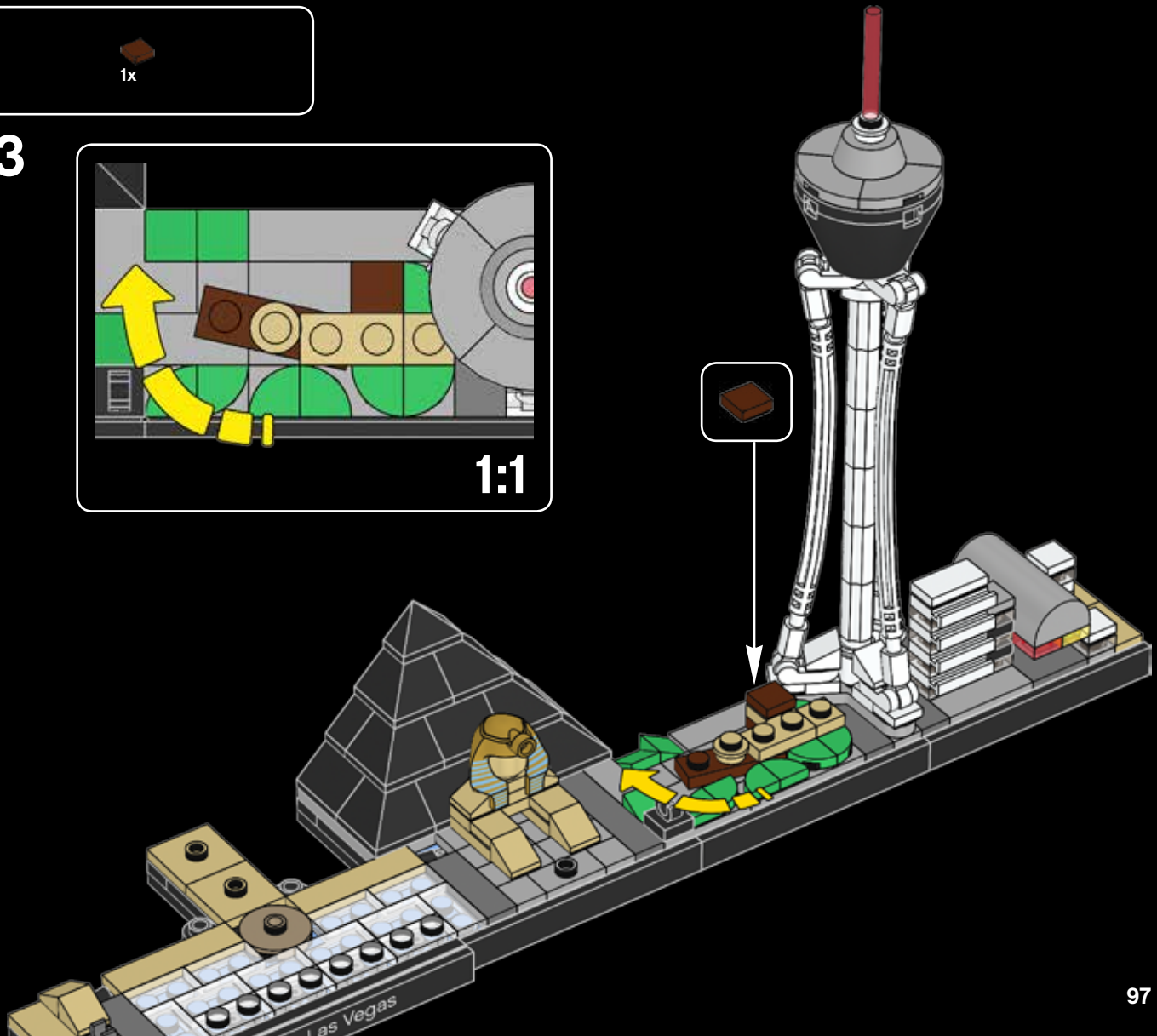
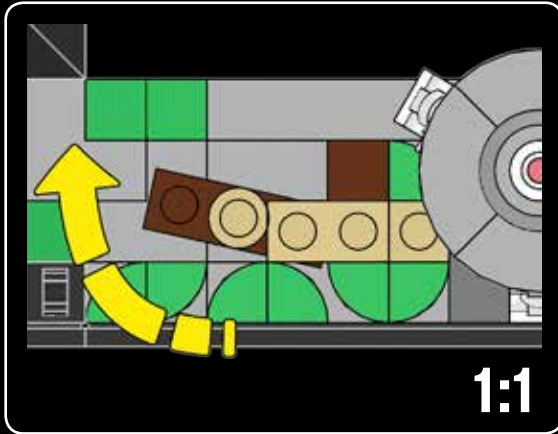



54

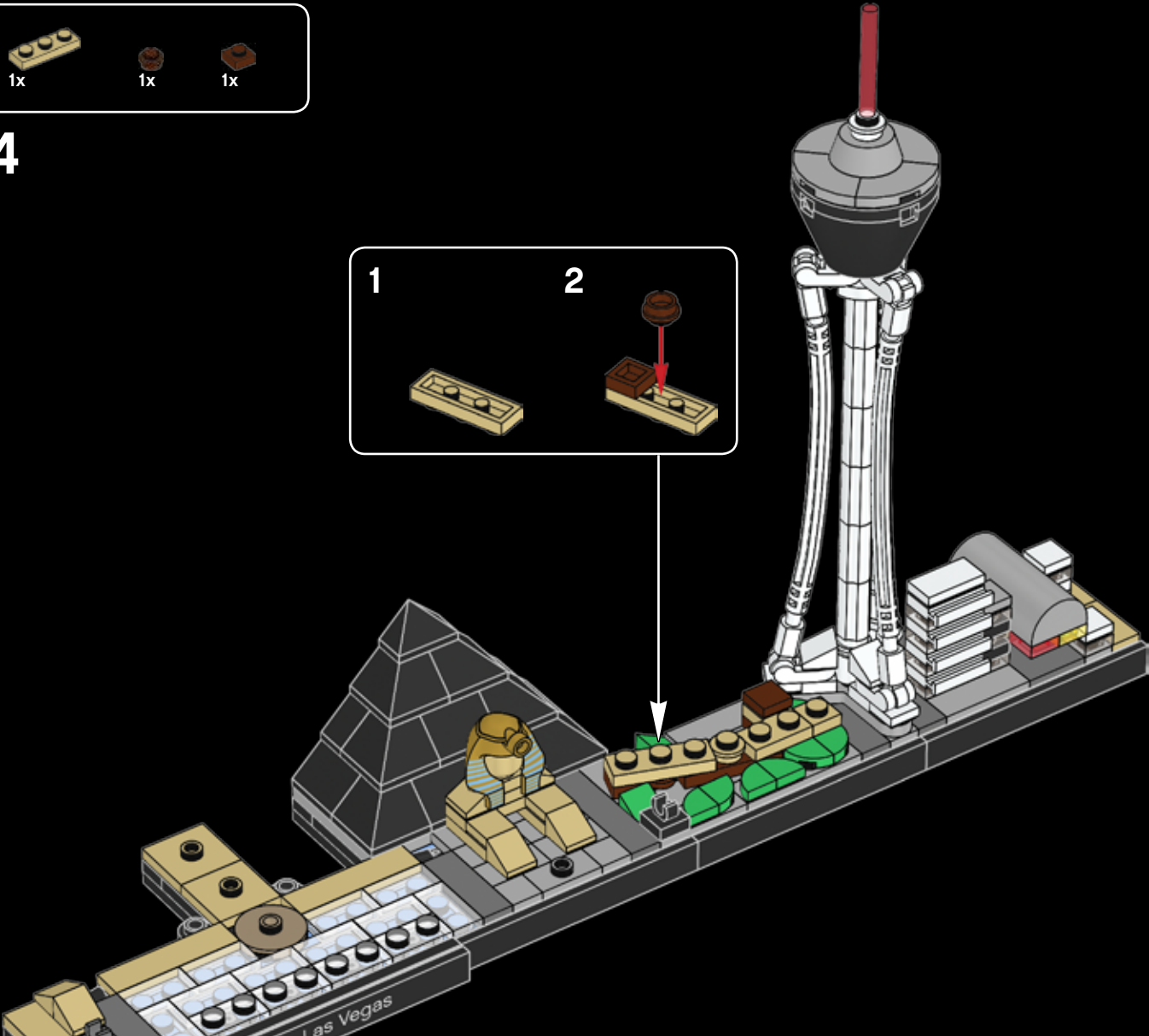
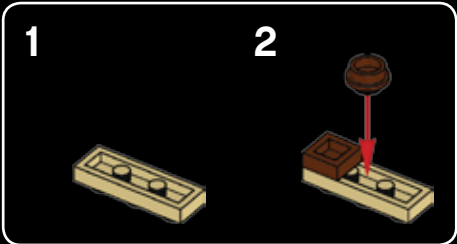



55

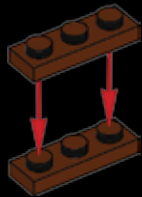

56

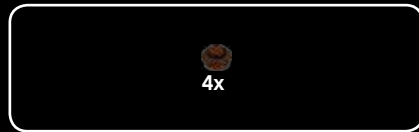
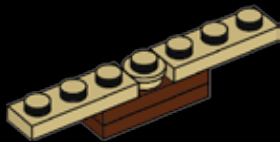

57

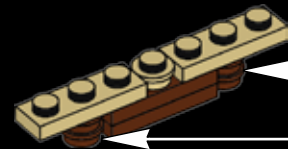
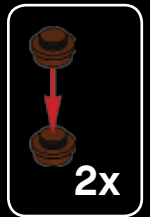

58

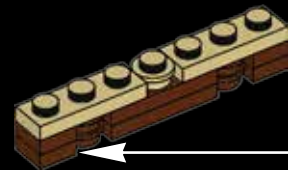
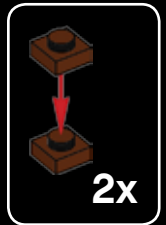

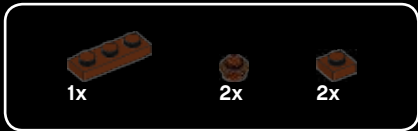

59



60



61

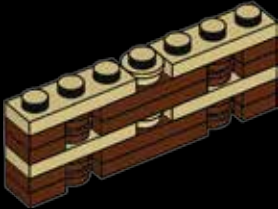

62

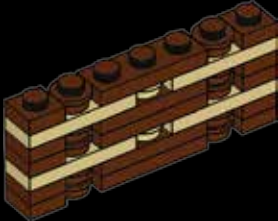

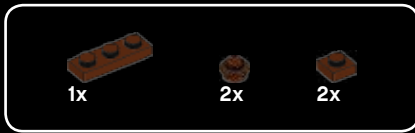

63



64



65



66





67



68



69



70



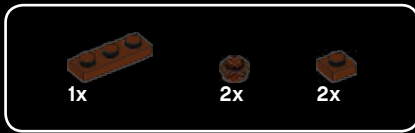

71

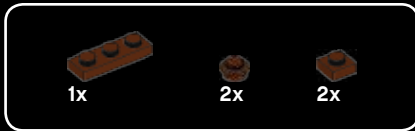

72



73

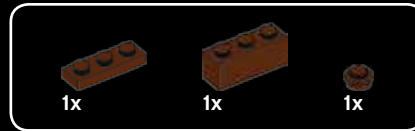
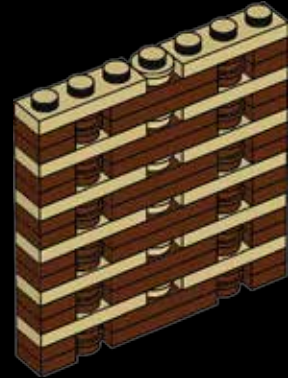

74





75

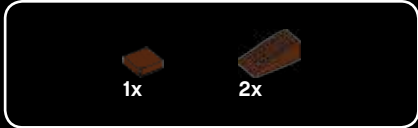

76



77

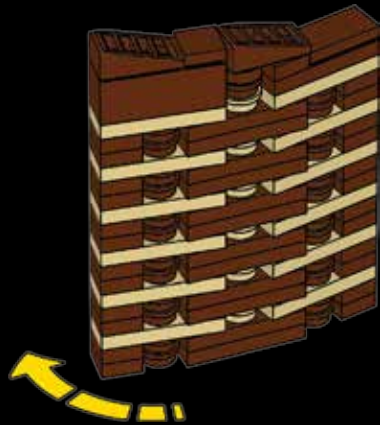
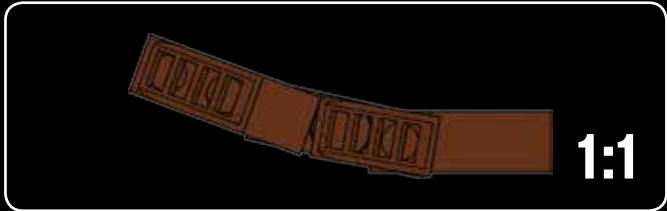



The Encore at the Wynn includes a 60,000 ft² (5574 m²) beach club and a 18-hole golf course on the resort ground.

Le complexe du Encore at the Wynn comprend un club de plage de 5 574 m² et un parcours de golf de 18 trous.

El Encore at the Wynn cuenta con un club de playa de 5.574 m² y un campo de golf de 18 hoyos dentro del complejo.

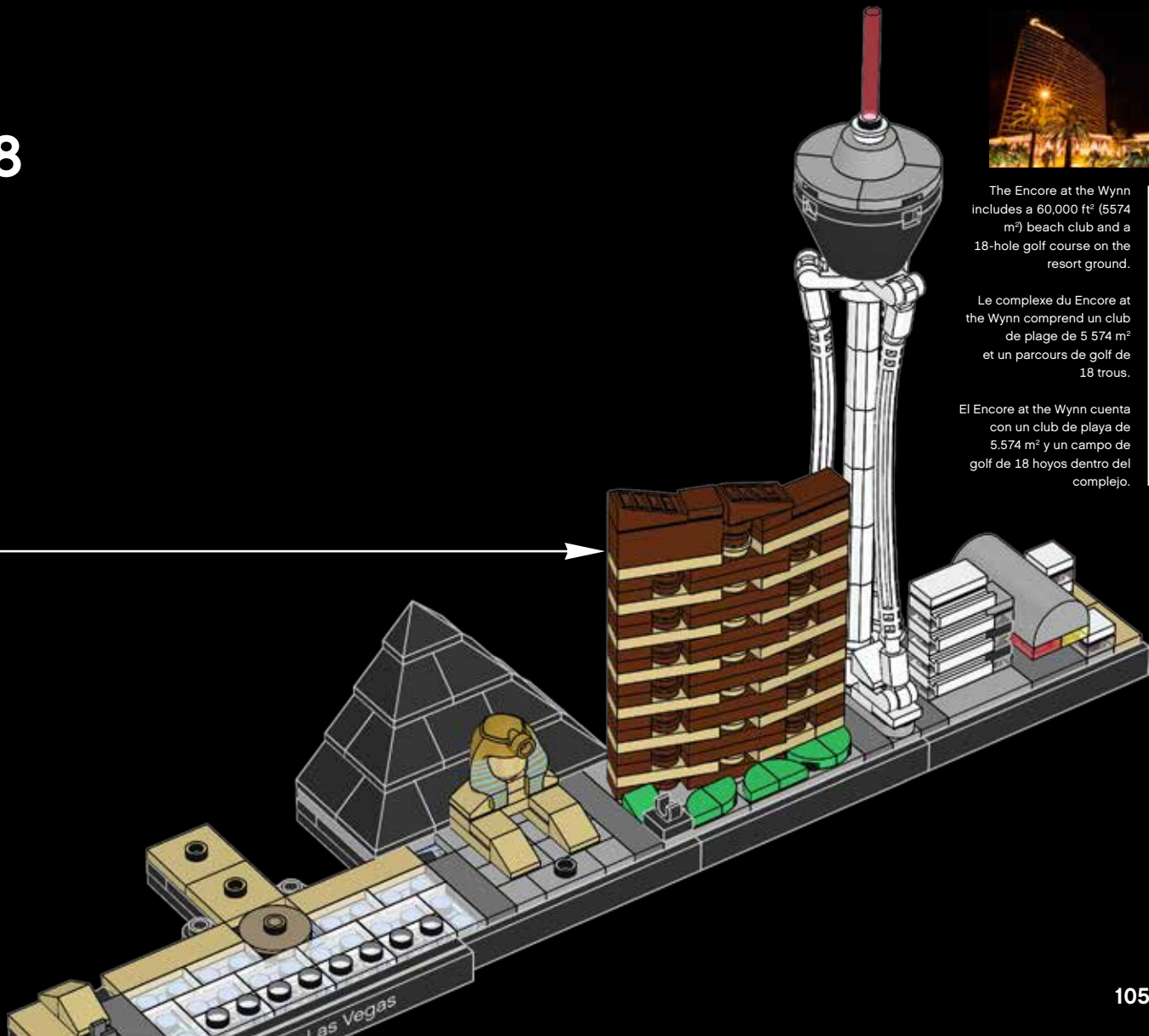

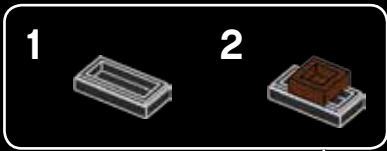
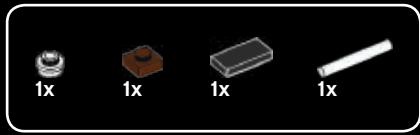

79

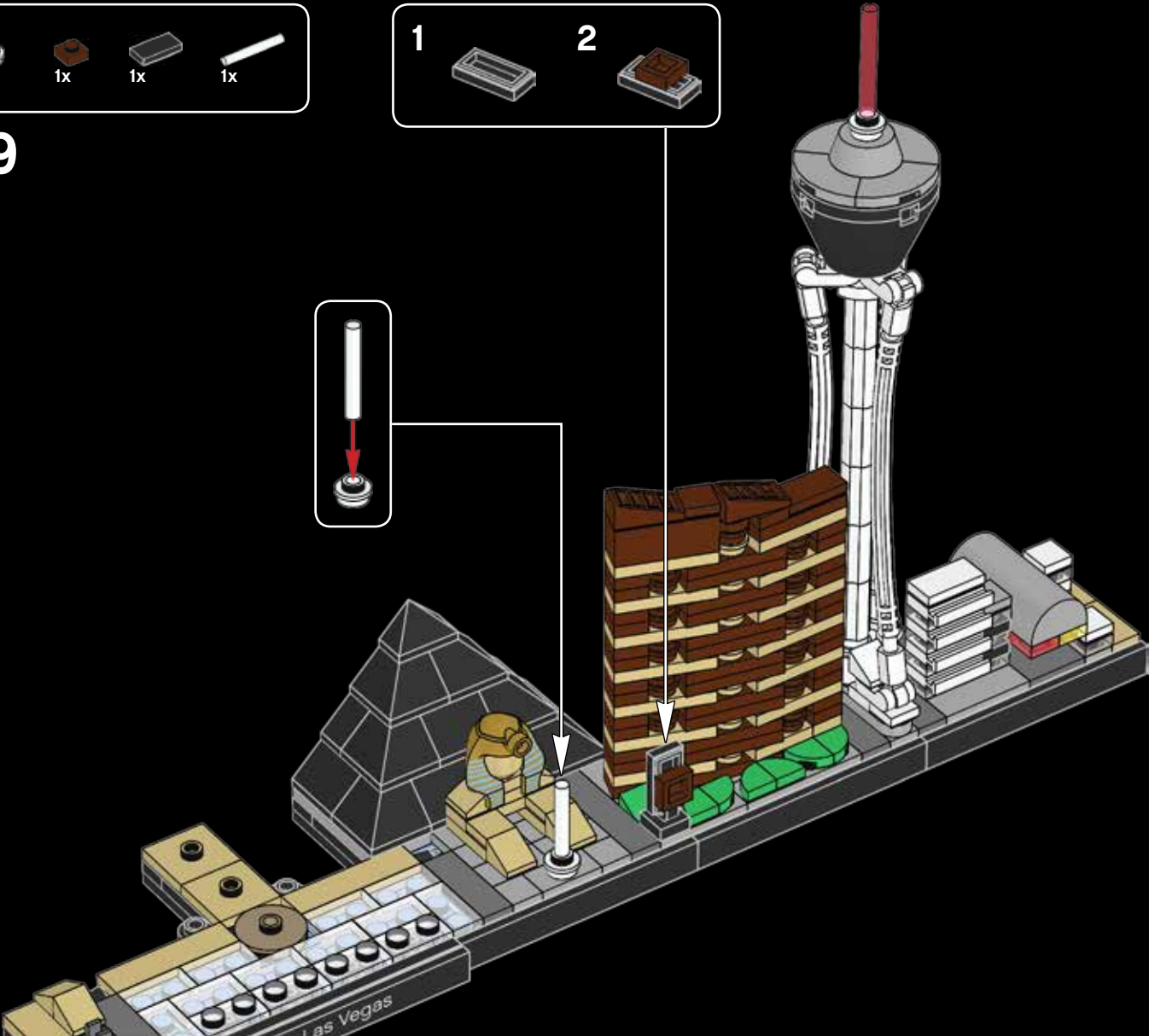

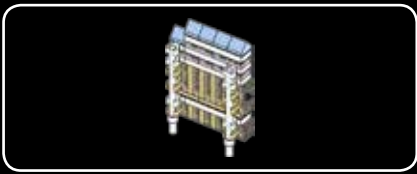

80



81

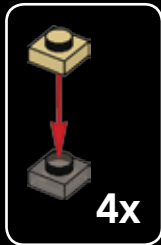

82

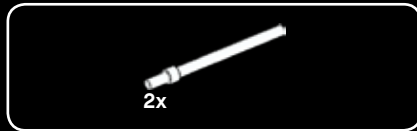
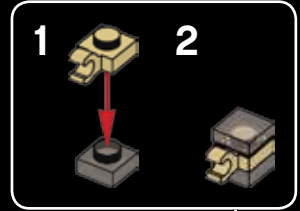

83

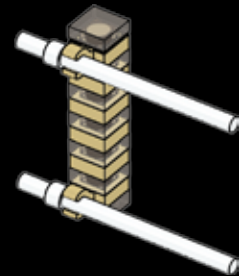



84

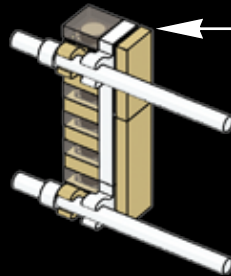
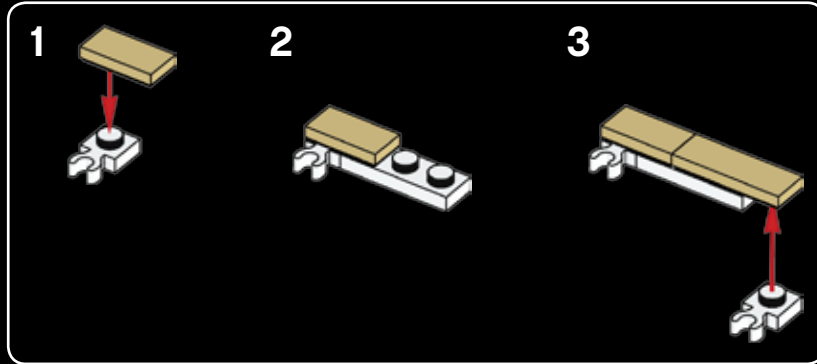



85



86



87

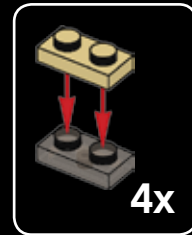



88



89

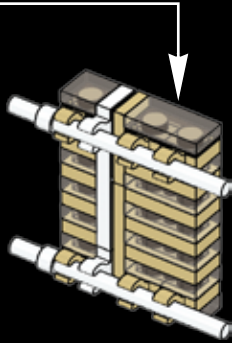



90



91

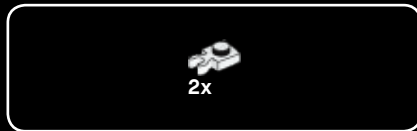

92

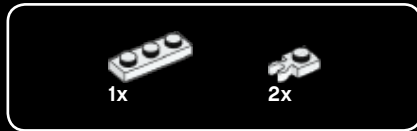

93





94

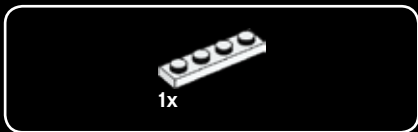
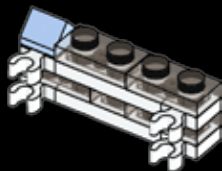

95

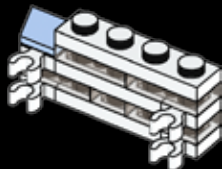

96

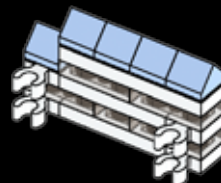

97

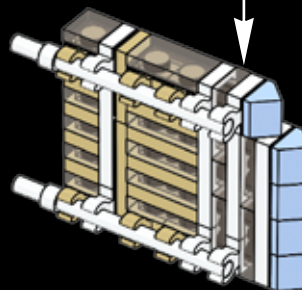

98

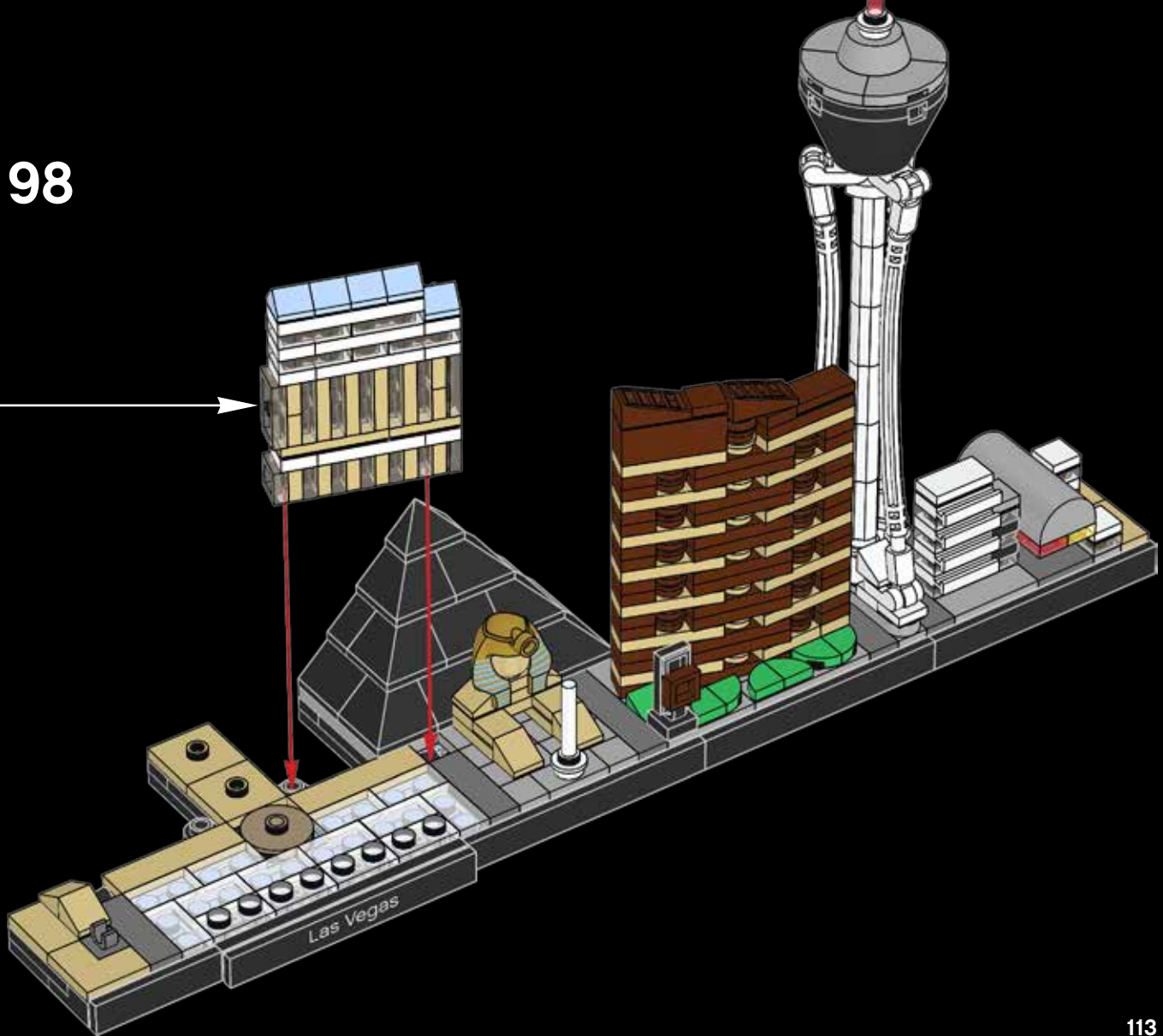



1x

99



1x

1x

100

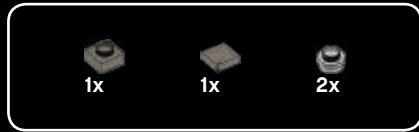

1x

1x

2x

101

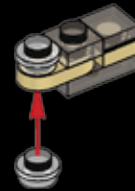

1x

102





103



104

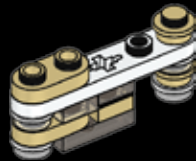

105

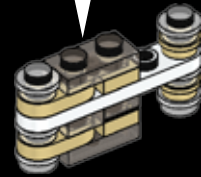
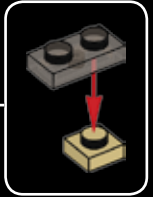

106

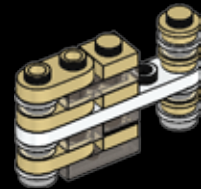



107

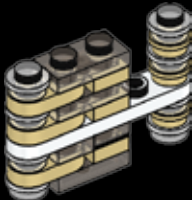

108

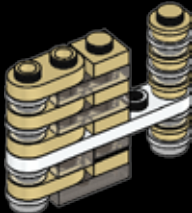

109

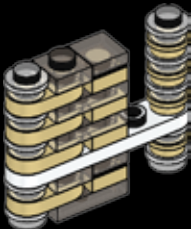

110

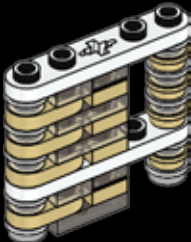



111

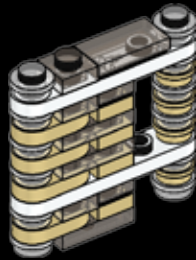

112

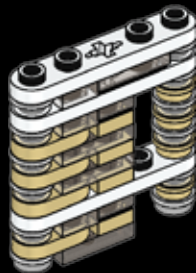

113

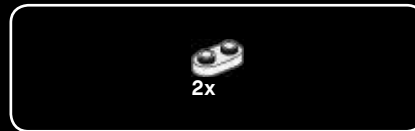
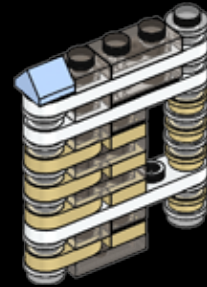

114

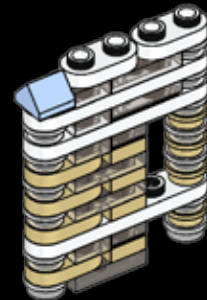



1x



1x



3x



1x

115

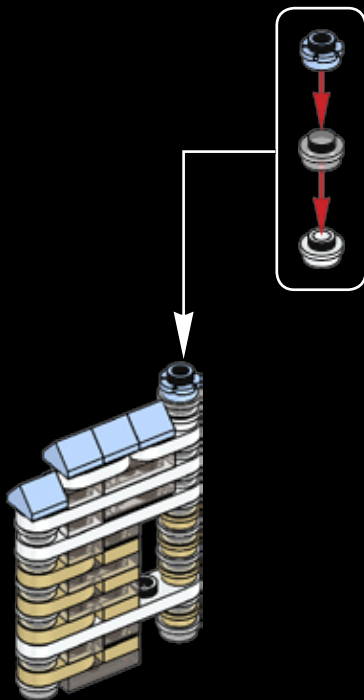

116

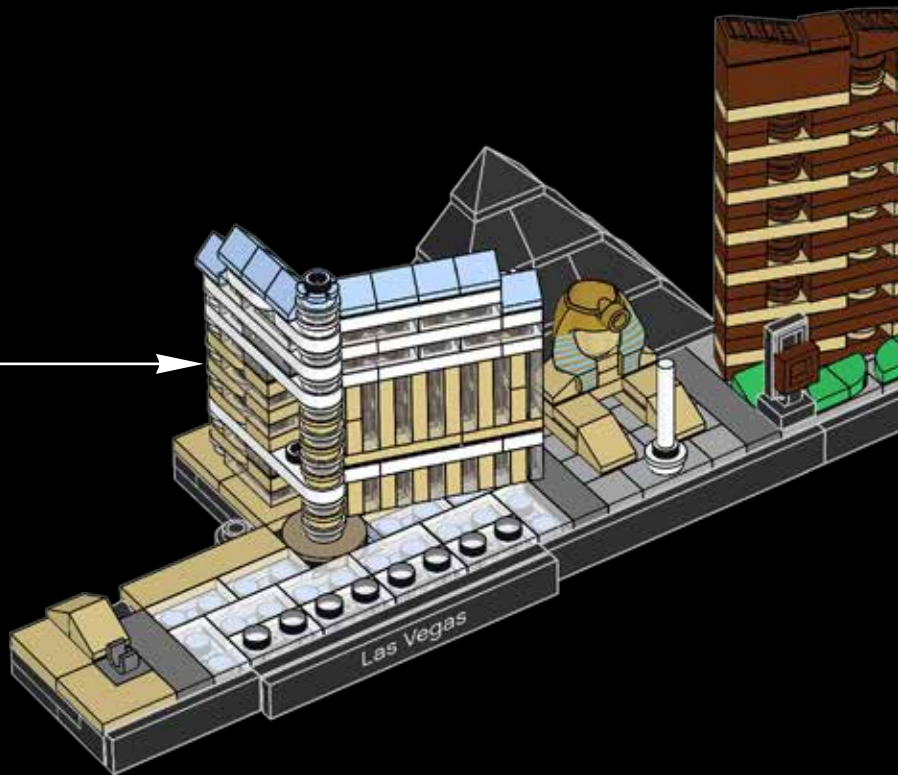



117



118

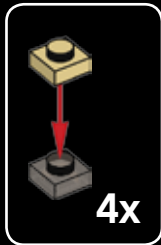

119

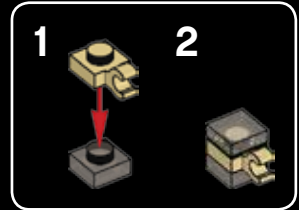

120

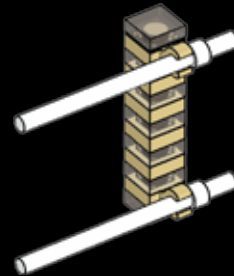



121

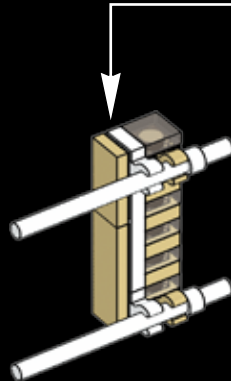
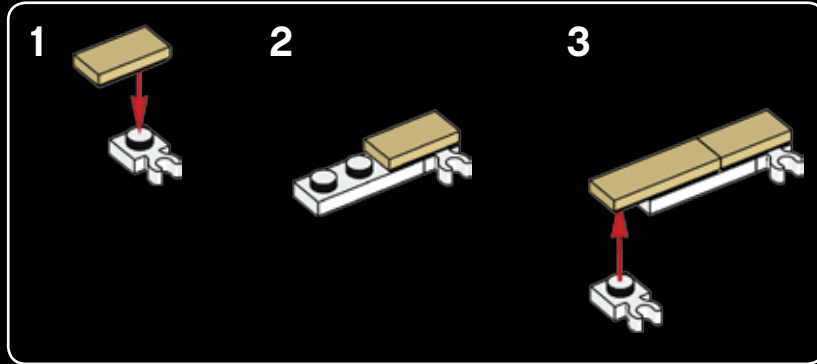



122



123

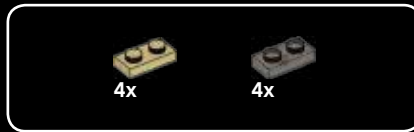

124

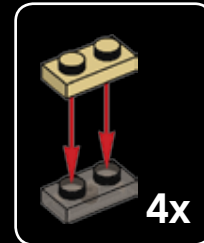



125

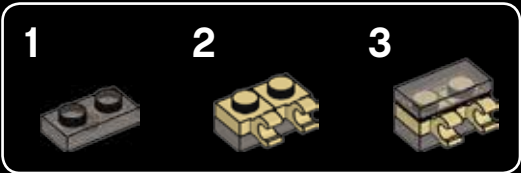

126

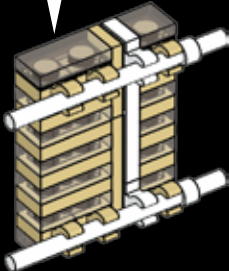



127



128

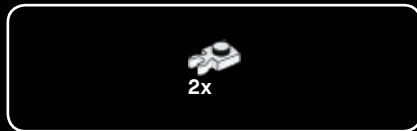

129

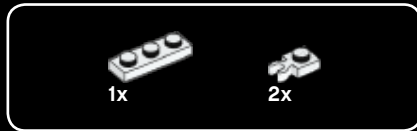

130

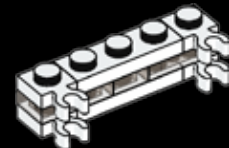



131

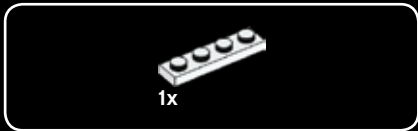
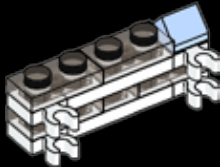

132

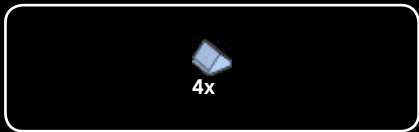
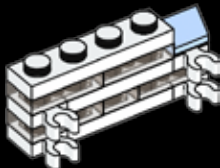

133

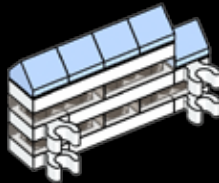

134

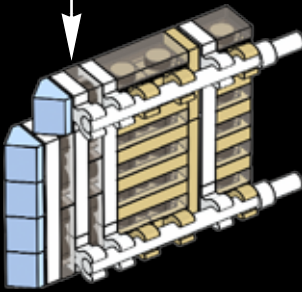

135



The famous Fountains of Bellagio span more than 1,000 ft. (305m), with water soaring as high as 460 ft. (140m) into the air.

Les célèbres fontaines du Bellagio s'étendent sur plus de 305 m et projettent de l'eau jusqu'à 140 m dans les airs.

Las famosas Fuentes de Bellagio se extienden a lo largo de más de 305 m y el agua que lanzan alcanza hasta 140 m de altura en el aire.

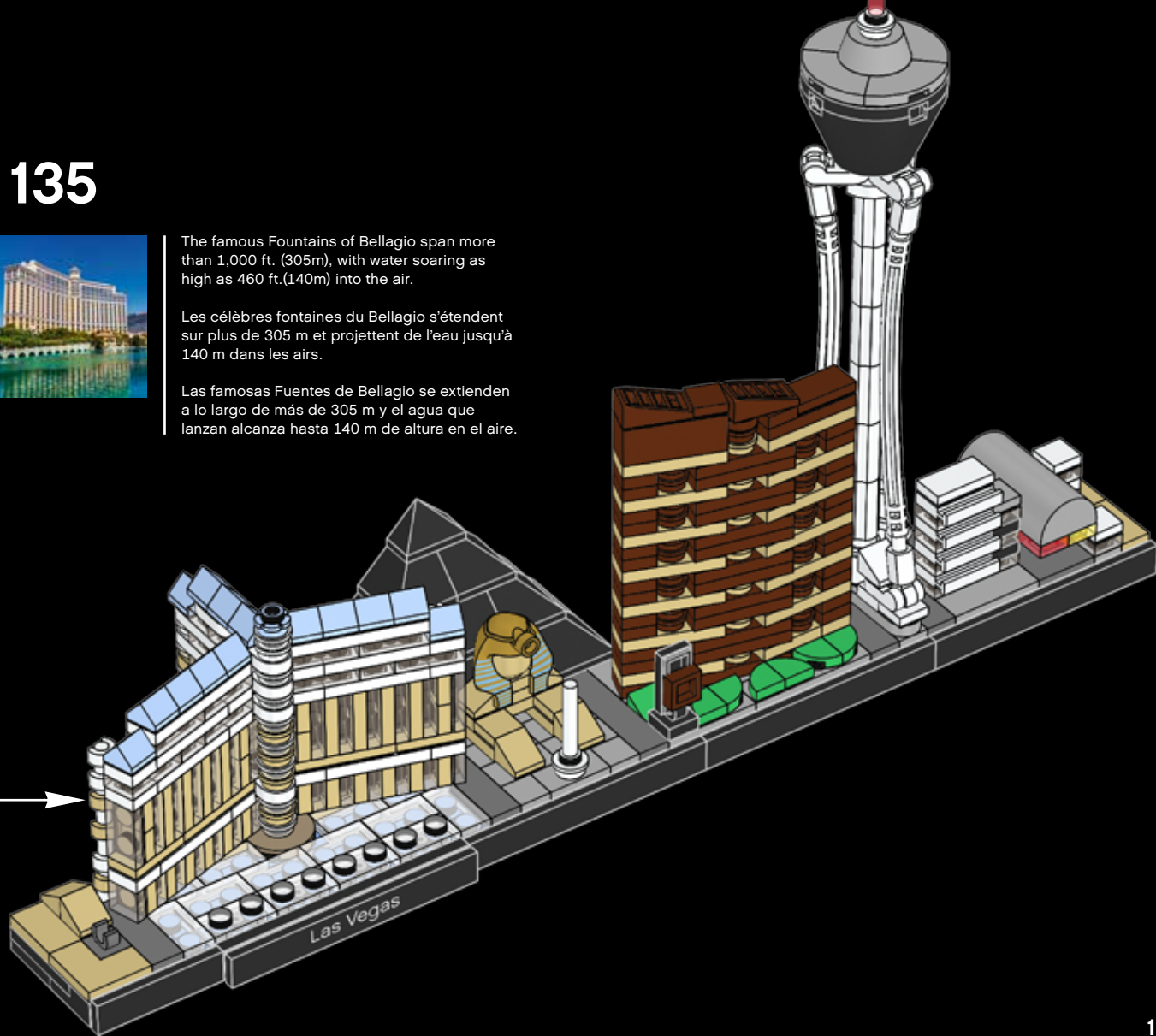



2x



2x

136





137

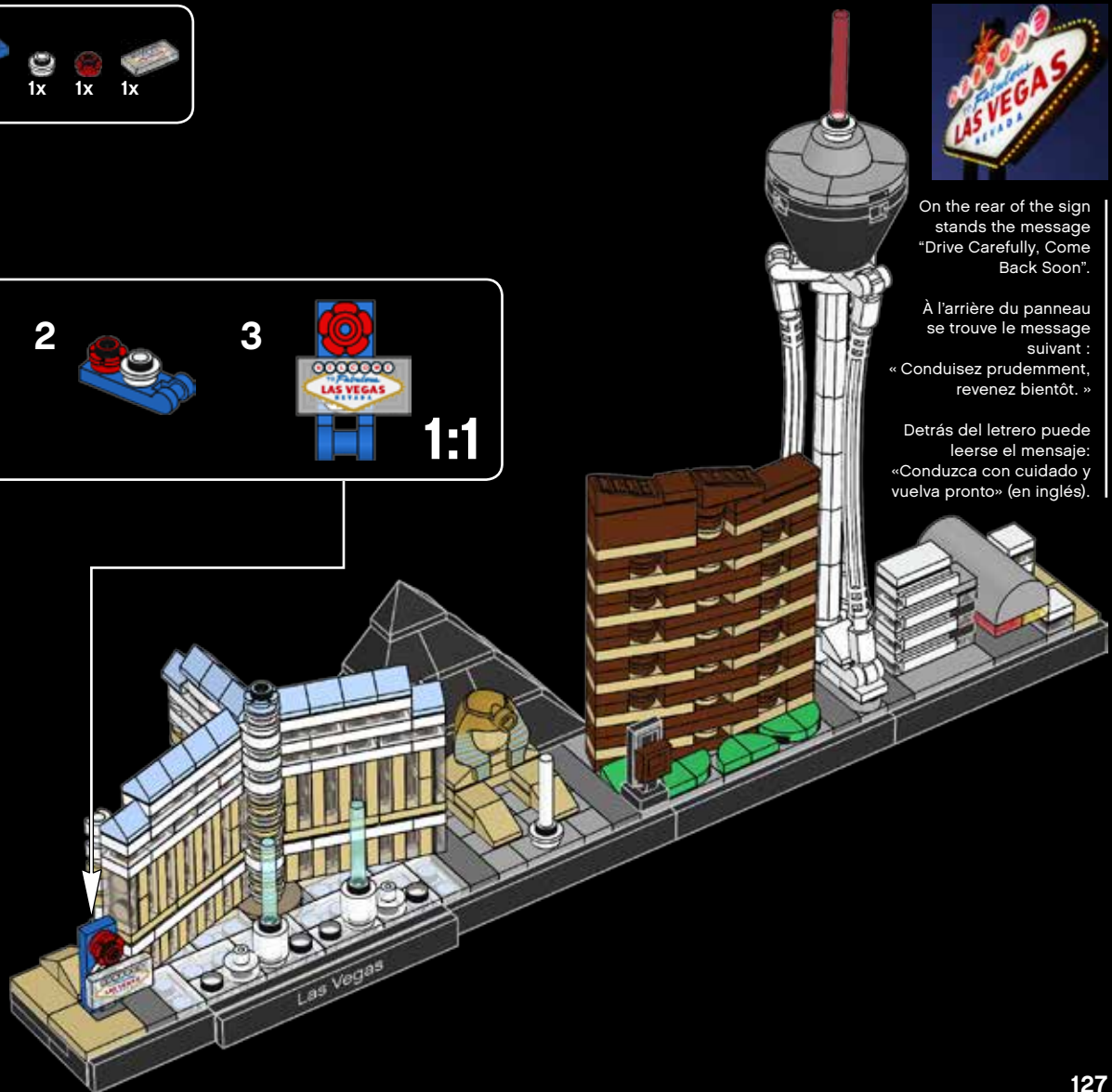
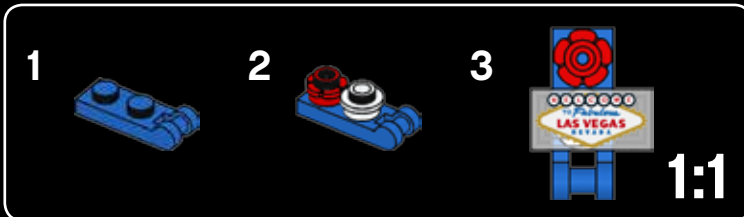

On the rear of the sign stands the message "Drive Carefully, Come Back Soon".

À l'arrière du panneau se trouve le message suivant :
« Conduisez prudemment, revenez bientôt. »

Detrás del letrero puede leerse el mensaje:
«Conduzca con cuidado y vuelva pronto» (en inglés).



LEGO® Architecture – do you like it?

The LEGO Group would like your opinion on the new product you have just purchased. Your feedback will help shape the future development of this product series. Please visit:

[LEGO.com/productfeedback](https://www.lego.com/productfeedback)

By completing our short feedback survey, you will be automatically entered into a drawing to win a LEGO® prize.

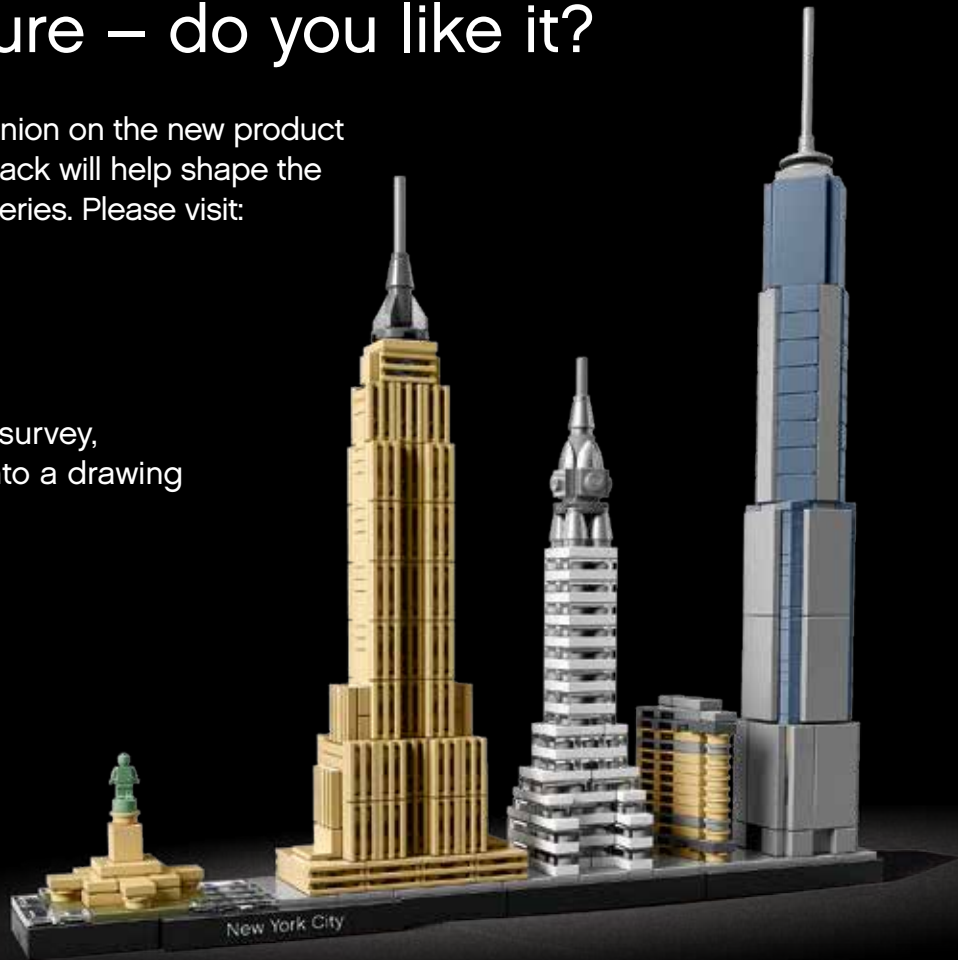

Aimez-vous LEGO® Architecture ?

Le Groupe LEGO aimerait connaître votre opinion sur le produit que vous venez d'acheter. Vos commentaires nous aideront à concevoir les futurs produits de cette gamme. Veuillez visiter :

[LEGO.com/productfeedback](https://www.lego.com/productfeedback)

En remplissant ce court sondage sur le produit, vous serez automatiquement inscrit à un tirage au sort pour gagner un prix LEGO®.

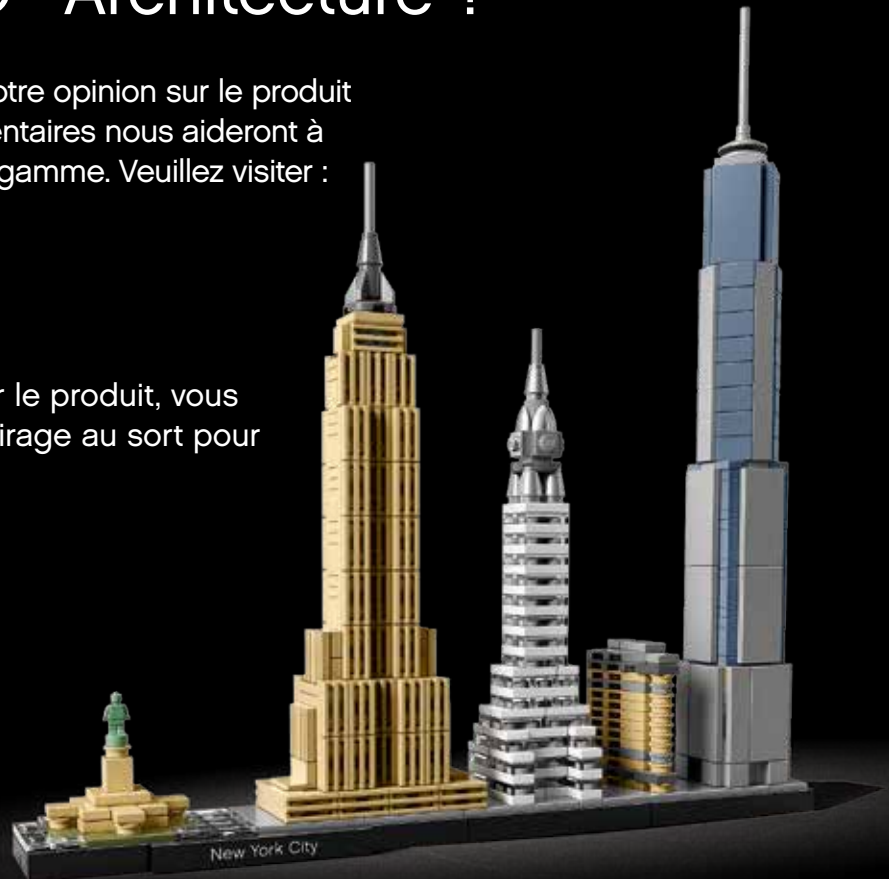

LEGO® Architecture: ¿te gusta?

The LEGO Group quiere conocer tu opinión acerca del nuevo producto que acabas de comprar. Tus comentarios nos ayudarán a dar forma a los futuros productos de esta serie. Visita:

[LEGO.com/productfeedback](https://www.lego.com/productfeedback)

Al contestar este breve cuestionario de opinión, participarás automáticamente en el sorteo de un producto LEGO®.





Sujeto a términos y condiciones.

LEGO® Architecture

The LEGO® Architecture series creatively captures the essence of many of the world's most iconic landmarks while giving you an enjoyable and engaging LEGO building experience.

Whether your interest is in travel, design, history or architecture, these sets are a physical memento of a great trip abroad, a famous building you know well, or a city you still dream of visiting.

Every LEGO Architecture set is designed to be displayed. Much more than just a photo, building and displaying your model on your desk, in the bookcase or on the shelf, lets you be transported every time you admire the view.

Follow us on  

Adam Reed Tucker is the co-developer of the LEGO Architecture product line.





LEGO® Architecture

La série LEGO® Architecture capture l'essence de nombreux monuments parmi les plus célèbres du monde tout en vous offrant une expérience agréable et stimulante de construction LEGO.

Que votre intérêt porte sur les voyages, le design, l'histoire ou l'architecture, ces ensembles constituent un souvenir tangible d'un voyage mémorable, d'un célèbre bâtiment que vous connaissez bien ou d'une ville que vous rêvez de visiter.

Chaque ensemble LEGO Architecture est conçu pour être exposé. Construire votre modèle et l'exposer sur votre bureau, une bibliothèque ou une tablette vous fera voyager à chaque coup d'œil, bien plus qu'une simple photo ne pourrait le faire.

Suivez-nous sur  



Adam Reed Tucker est le codéveloppeur de la gamme de produits LEGO Architecture.

LEGO® Architecture

La línea LEGO® Architecture captura con creatividad la esencia de muchos de los monumentos más populares del mundo y pone a tu alcance una experiencia de construcción gratificante y cautivadora con el sello característico de LEGO.

Ya sea que sientas atracción por los viajes, el diseño, la historia o la arquitectura, estos sets expresan físicamente tus recuerdos de aquel fantástico viaje al extranjero, ese famoso edificio que conoces tan bien o la ciudad que sueñas con visitar algún día.

Todos los sets LEGO Architecture están diseñados para exhibirse. Mucho más que una simple fotografía, construir y exponer un modelo en tu escritorio, un librero o una repisa te traslada a otro lugar al admirar las vistas.

Síguenos en  

Adam Reed Tucker es el codesarrollador de la línea de productos LEGO Architecture.



Celebrate the world of architecture and collect all the models
Célébrez le monde de l'architecture et collectionnez tous les modèles
Celebra el mundo de la arquitectura y colecciona todos los modelos

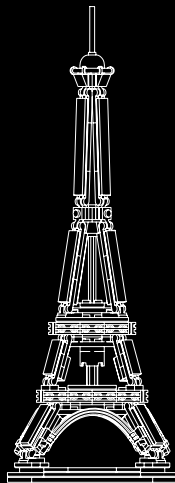

21019
The Eiffel Tower
La tour Eiffel
La Torre Eiffel



21028
New York City
New York
Nueva York

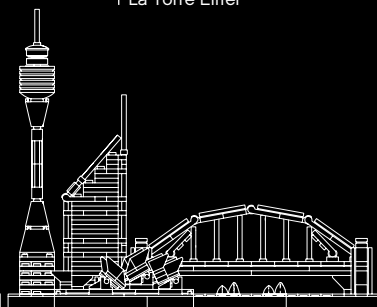

21032
Sydney
Sidney

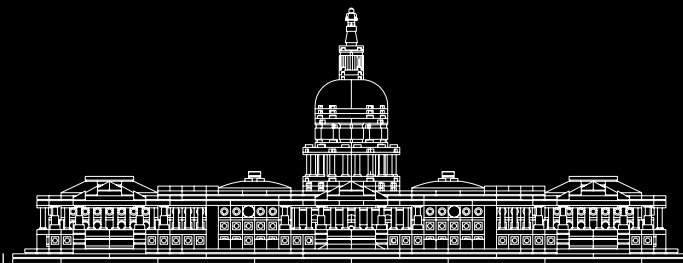

21030
United States Capitol Building
Le Capitole des États-Unis
Edificio del Capitolio de Estados Unidos



21033
Chicago

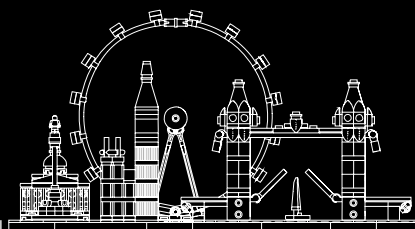

21034
London
Londres

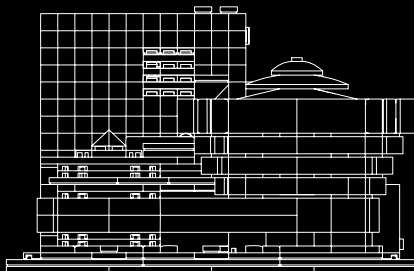

21035
Solomon R. Guggenheim Museum®
Musée Solomon R. Guggenheim®
Museo Solomon R. Guggenheim®

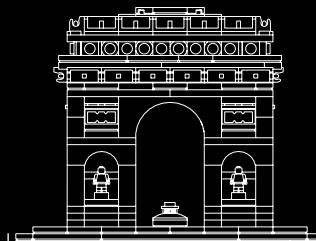

21036
Arc De Triomphe
L'Arc de Triomphe
Arco del Triunfo

References

Références

Referencias

Pictures -

Images -

Fotografías -

© Shutterstock

© Stratosphere Casino, Hotel & Tower

© Fremont Street Experience

Text -

Texte -

Texto -

www.lasvegas.com

www.vegasexperience.com

www.stratospherehotel.com

Customer Service
Kundenservice
Service Consommateurs
Servicio Al Consumidor
LEGO.com/service or dial

00800 5346 5555 : 
1-800-422-5346 : 

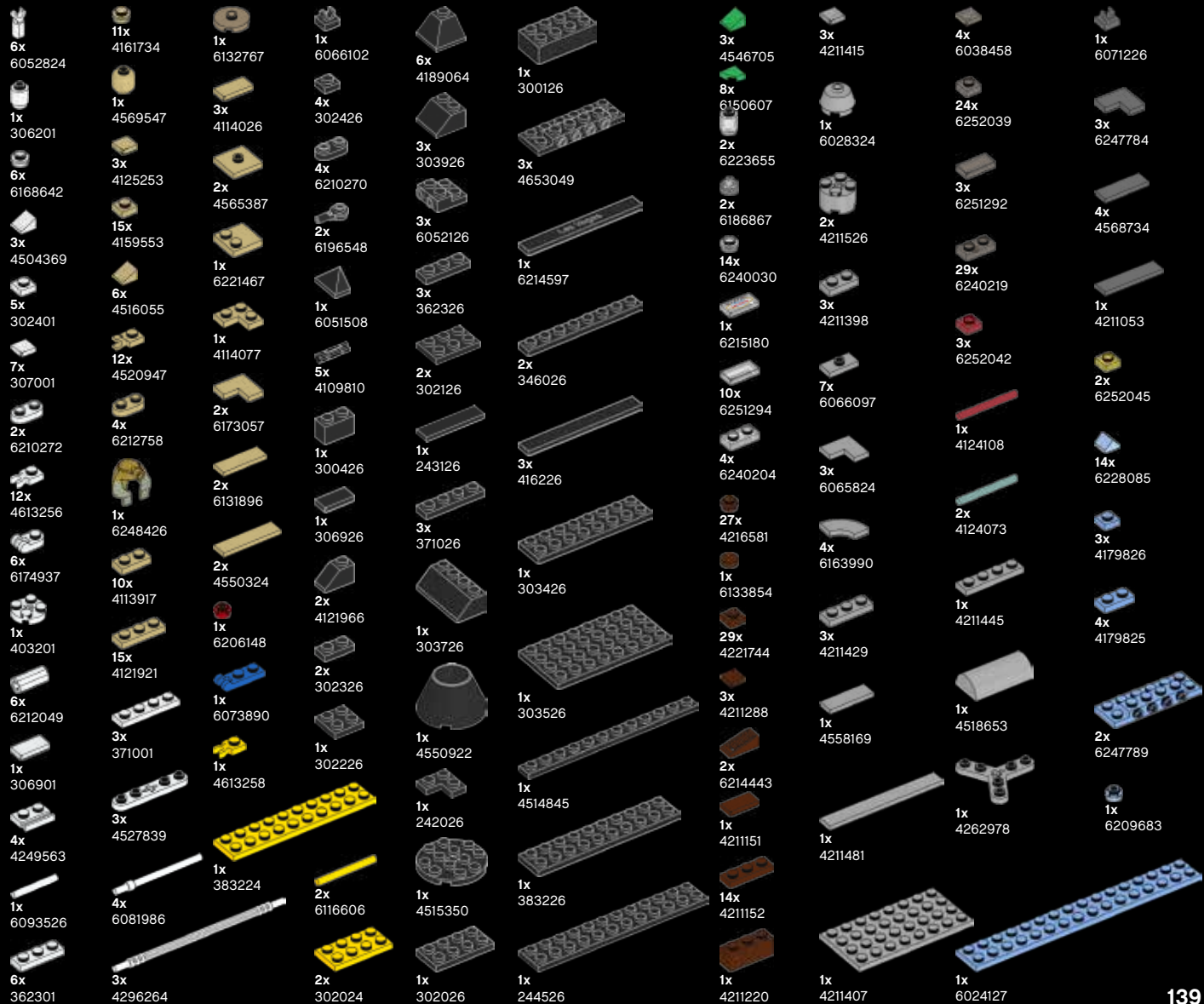

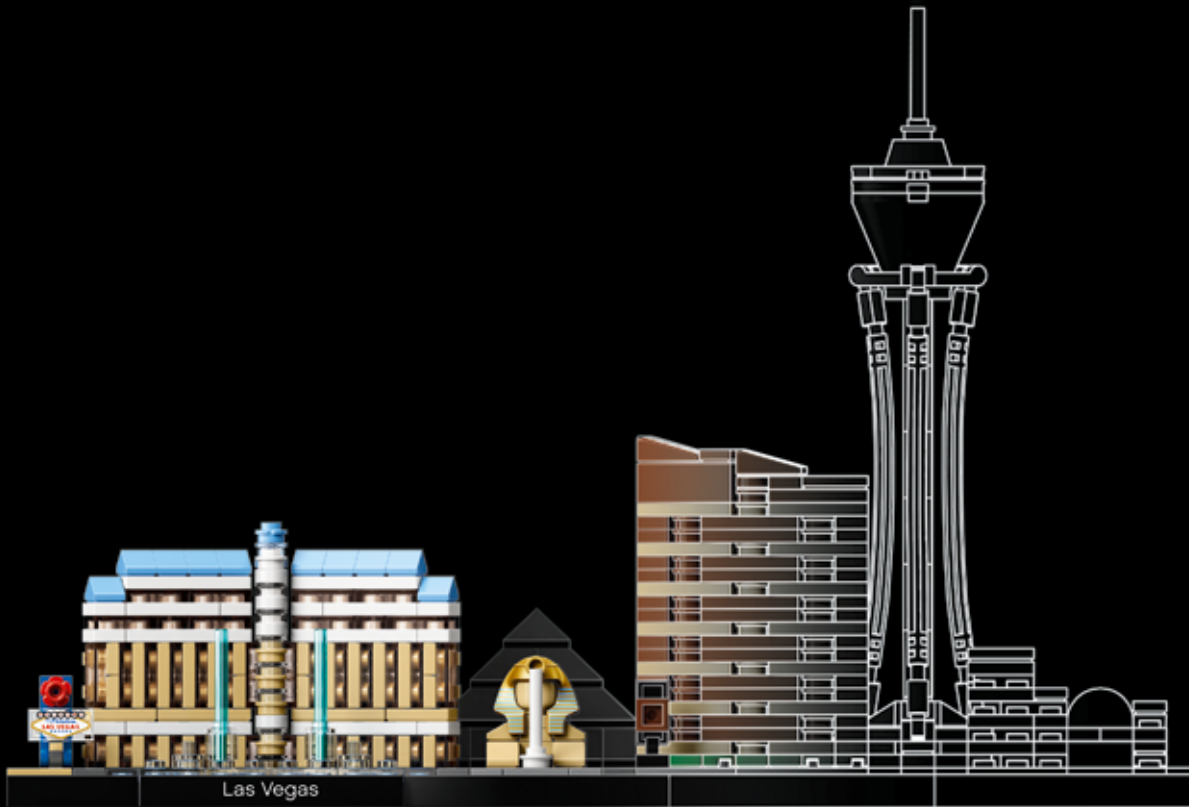

LEGO and the LEGO logo are trademarks of the/sont des marques de commerce du/son marcas registradas de LEGO Group.
©2018 The LEGO Group. 6254671

Copyright 2018 Fremont Street Experience, LLC. All rights reserved.
Copyright © 2018 Wynn Resorts Holdings, LLC. All rights reserved.
Copyright © 2018 MGM Resorts International. All rights reserved.
Copyright © 2018 Stratosphere Casino, Hotel & Tower. All Rights Reserved.

Follow LEGO® Architecture on
Suivez LEGO® Architecture sur
Sigue a LEGO® Architecture en

