

LEGO

Architecture

Shanghai

China

Shanghai

Chine

Shanghái

(China)

21039

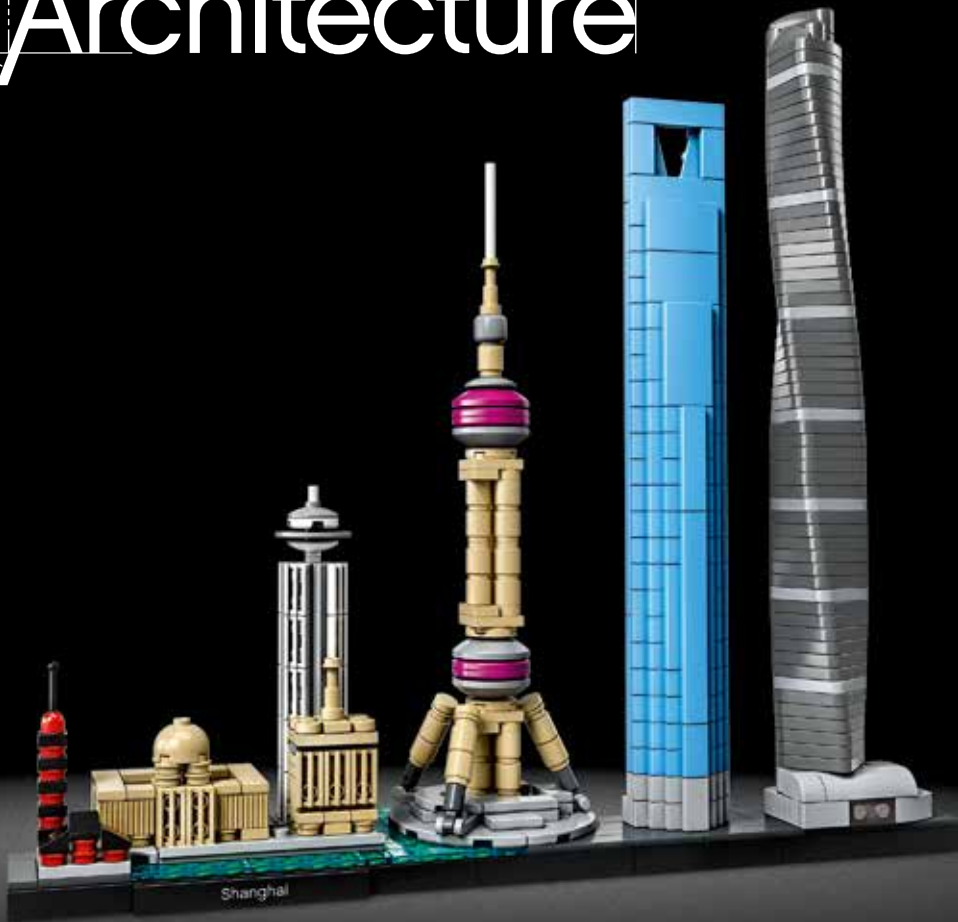

The Pearl of the Orient

Sitting on the Yangtze River and bordered by the East China Sea, the city of Shanghai has re-emerged over the past decades to become one of the biggest cities and the busiest port in the world.

Nowhere is this dramatic development more evident than in the city's architecture. Shanghai's rich collection of Art Deco buildings from the 1920s and 1930s now stand side-by-side with an ever-increasing number of awe-inspiring, contemporary structures.

This is a city where the skyline is constantly evolving and every new structure appears to be an attempt to out-do previous ones in size, choice of materials or ambitious design. In an ever-changing world, Shanghai's architecture is stepping confidently into the future.

"New York may be the city that never sleeps, but Shanghai doesn't even sit down"

Patricia Marx





Chenghuang Miao Temple



There's a popular saying in Shanghai that states, "if you want to know the city well, you must visit the Chenghuang Miao Temple". The temple sits in one of the most popular traditional areas of the city and is the site of Shanghai's largest and oldest monastery, dating back to the 10th century. The present version of the temple dates from the 15th century and although much restored, is still considered the most authentic one in the city.

Longhua Pagoda



The Longhua Pagoda stands in Longhua Park at the south end of the city and is where the modern Shanghai meets its traditional past. The classical pagoda is the best known of the 16 historic pagodas that still stand within the city. The seven-story structure consists of a hollow, tube-like brick core surrounded by a wooden staircase. The exterior is decorated with balconies, banisters and upturned eaves. The original structure dates back to 977 AD and, due to the fragile nature of its wooden components, is no longer open to the public.







The Bund

Originally a waterfront area outside the old walled city of Shanghai, The Bund was home to numerous international banks and trading houses. Many of the magnificent Beaux Arts buildings were constructed in the early part of the 20th century as the area developed into a major financial center.



HSBC Building (No. 12, The Bund)

This six-floor, neo-classical style building was designed by a British architecture firm and completed in 1923. At the time, it was called “the most luxurious building between the Suez Canal and the Bering Strait”. Its central dome was famously decorated with frescos depicting the twelve signs of the zodiac. It served as the HSBC headquarters until 1955, when it then became known as the Municipal Government Building. Today the building houses the Shanghai Pudong Development Bank.

Customs House (No. 13, The Bund)

Built in 1927 on the site of a traditional Chinese-style customs house, the building cost 4.3 million taels of silver to construct and still functions as a customs house today. The eastern section is eight stories tall, faces the Huangpu River and is topped by a 300 ft. (90 m) clock tower. The clock tower offers views over the entire Bund and Shanghai city center. The clock and bell itself were built in England and are an imitation of Big Ben.



"To my child's eyes, which had seen nothing else, Shanghai was a waking dream where everything I could imagine had already been taken to its extreme."

J. G. Ballard

Radisson Blu Hotel Shanghai New World

This 682 ft. (208 m) tall hotel stands in the city's Huangpu district. The original structure was completed in 2001, while the dome was added in 2005. The building is known for its revolving restaurant on the 45th floor and the bar at the top of the dome that sits under the hotel's iconic glass ceiling.



Oriental Pearl Tower

Situated on The Bund, this 1,535 ft. (468 m) tall TV and radio tower has become an iconic landmark for the city, especially as its futuristic style stands out against the area's other diverse architectural styles. Completed in 1994, the tower is made up of 11 bigger and smaller spheres, the largest one with a diameter of 164 ft. (50 m) that is supported by legs that reach far into the ground. The tower sits on the edge of the riverbank and has 15 observatory levels, the highest of which is at 1,148 ft. (350 m).

"And Shanghai is amazing. I'm a fan of science fiction so when you're there in the night with all the lights and all this modernity, it's like a set in a movie."

Berenice Marlohe







Shanghai World Financial Center

Given the task of creating a building that would symbolize Shanghai's emergence as a global capital, the architect, William Pedersen, chose to make a bold statement using two sweeping arcs and a square prism – shapes that also represent ancient Chinese symbols of heaven and earth.

Known locally as “the Bottle Opener,” the 1,614 ft. (492 m) tall structure is a mini vertical city containing 62 office floors, conference facilities, retail and dining spaces, and a 174-room five-star Hotel at the top. The Center's design has received much critical acclaim since its completion in 2008, with one architectural judging committee stating the building is “nothing short of genius”.





Shanghai Tower

Building tall in Shanghai comes with its own set of challenges: the city sits upon sandy river delta soil and is often buffeted by tropical typhoons. So when the architects and engineers wanted to build the tallest building in China, they had to be innovative. They placed the entire structure upon massive 200 ft. (70 m) long concrete piles to provide the perfect foundation, while the tower's elegant spiralling cylindrical shape is also aerodynamic, reducing wind loads by 24%.

With a height of 2,073 ft. (632 meters), Shanghai Tower is the second tallest building in the world, but has the world's highest observation deck at 1,840 ft. (561 m) and the fastest elevators that can speed up and down the building at 40 mph (65 km/h).





La perle de l'Orient

Sise aux abords du fleuve Yangzi Jiang et bordée par la mer de Chine orientale, Shanghai a refait surface ces dernières décennies pour se hisser parmi les plus grandes villes du monde et devenir celle comptant le port le plus achalandé.

Nulle part cette évolution spectaculaire n'est plus évidente que dans l'architecture de la ville. La riche collection de bâtiments *Art déco* de Shanghai des années 1920 et 1930 côtoie désormais un nombre croissant de majestueuses structures contemporaines.

Voici une ville dont la silhouette est en mouvement perpétuel et où chaque nouvelle structure semble être une occasion d'éclipser la précédente tant par la taille que par le choix des matériaux ou le design ambitieux. Dans un monde en constante évolution, l'architecture de Shanghai est résolument orientée vers l'avenir.

« New York est peut-être bien la ville qui ne dort jamais, mais Shanghai n'arrête jamais, même pour s'asseoir. »

Patricia Marx





Temple du dieu de la ville



Il y a un dicton populaire à Shanghai qui dit ceci : « Si vous souhaitez bien connaître la ville, vous devez visiter le temple du dieu de la ville. » Le temple est situé dans l'une des régions traditionnelles les plus populaires de la ville, et son monastère datant du X^e siècle est le plus grand et le plus ancien de Shanghai. Le temple dans sa version actuelle remonte au XV^e siècle et est considéré comme le plus authentique dans la ville même s'il a été largement restauré.

Pagode Longhua



La pagode Longhua est située dans le parc de Longhua, à l'extrémité sud de la ville, là où le côté moderne de Shanghai côtoie son passé traditionnel. Cette pagode classique est la plus connue des 16 pagodes historiques toujours présentes dans la ville. La structure de sept étages se compose d'un tube creux de briques entouré d'un escalier en bois. L'extérieur est décoré de balcons, de balustrades et d'avant-toits retroussés. La structure d'origine remonte à l'an 977, et comme ses composants en bois sont fragiles de nature, le site n'est plus ouvert au public.







Le Bund

À l'origine une zone riveraine située à l'extérieur de l'ancienne ville fortifiée de Shanghai, le Bund compte aujourd'hui de nombreuses banques internationales et maisons de commerce. Bon nombre des magnifiques bâtiments de style Beaux-Arts ont été construits au début du XX^e siècle, moment où le secteur est devenu un important centre financier.



Bâtiment HSBC (n° 12, le Bund)

Ce bâtiment néo-classique de six étages conçu par une société britannique d'architecture a été terminé en 1923. À l'époque, il était appelé « le bâtiment le plus luxueux entre le canal de Suez et le détroit de Béring ». Son dôme central est orné d'une fresque célèbre dépeignant les douze signes du zodiaque. Le bâtiment a abrité le siège social de la HSBC jusqu'en 1955, avant de devenir le siège de l'administration municipale. Il est aujourd'hui occupé par la Shanghai Pudong Development Bank.

Bureau de douane (n° 13, le Bund)

Construit en 1927 sur le site d'un bureau de douane de style traditionnel chinois, ce bâtiment a été construit au coût de 4,3 millions de taels d'argent. Il sert toujours de bureau de douane aujourd'hui. La partie est donnant sur le fleuve Huangpu compte huit étages et est surmontée d'un clocher de 90 m de hauteur. La vue dans la tour de l'horloge se déploie sur l'ensemble du Bund et du centre-ville de Shanghai. L'horloge et la cloche ont été construites en Angleterre et sont une imitation de Big Ben.





« Dans mes yeux d'enfant, qui n'avaient rien vu d'autre, Shanghai était un rêve éveillé où tout ce que je pouvais imaginer avait déjà été porté à son paroxysme. »

J. G. Ballard

Radisson Blu Hotel Shanghai New World

Cet hôtel de 208 m de hauteur se trouve dans le district de Huangpu. La structure d'origine a été achevée en 2001, tandis que le dôme a été ajouté en 2005. Le bâtiment est connu pour son restaurant tournant au 45^e étage et son bar en haut du dôme, sous le célèbre plafond en verre de l'hôtel.



Tour de la perle de l'Orient

Située sur le Bund, cette tour de télévision et de radio de 468 m de hauteur est devenue un monument emblématique de la ville, d'autant que son style futuriste se démarque des différents styles architecturaux présents dans le secteur. Achèvement en 1994, la tour est composée de 11 sphères de tailles variées. La plus grande a un diamètre de 50 m et est soutenue par des pieds qui s'enracinent profondément dans le sol. La tour est érigée près de la rive et compte 15 niveaux d'observation, dont le plus élevé est situé à 350 m de hauteur.

« Shanghai est incroyable. Je suis une amatrice de science-fiction. La nuit, au cœur de toutes ces lumières et de cette modernité, c'est comme le plateau de tournage d'un film. »

Bérénice Marlohe







Shanghai World Financial Center

Ayant reçu le mandat de créer un bâtiment qui allait symboliser l'émergence de Shanghai en tant que capitale d'envergure mondiale, l'architecte William Pedersen a choisi de faire une forte impression en utilisant deux arcs majestueux et un prisme carré, des formes qui représentent les symboles chinois anciens du ciel et de la terre.

Appelée localement « l'ouvre-bouteille », la structure de 492 m de hauteur est une mini ville verticale contenant 62 étages de bureaux, des salles de conférence, des espaces de commerce de détail et de restauration, de même qu'un hôtel cinq étoiles de 174 chambres dans la partie supérieure. La conception du bâtiment achevé en 2008 a fait l'objet de plusieurs éloges. Un panel de juges en architecture a même indiqué qu'elle relevait « du génie, rien de moins ».





Tour Shanghai

À Shanghai, construire en hauteur comporte son lot de défis. La ville repose sur le sol sablonneux du delta et est souvent balayée par des ouragans. Ainsi, lorsque les architectes et les ingénieurs ont décidé de construire le bâtiment le plus élevé en Chine, ils ont dû innover. Ils ont déposé toute la structure sur d'énormes pieux en béton de 70 m de longueur, ce qui représentait une base idéale, et ont donné à la tour une élégante forme cylindrique montée en spirale, dont l'aérodynamisme réduit la charge du vent de 24 %.

D'une hauteur de 632 m, la tour Shanghai occupe le deuxième rang des plus hauts bâtiments du monde. Par contre, sa terrasse d'observation à 561 m de hauteur est la plus élevée et ses ascenseurs gravissant les étages de la tour à une vitesse de 65 km/h sont les plus rapides du monde.





La Perla de Oriente

Emplazada en la desembocadura del río Yangtsé y bordeada por el mar de la China Oriental, la ciudad de Shanghái ha resurgido a lo largo de las últimas décadas hasta convertirse en una de las mayores ciudades y el puerto más activo del mundo.

En ningún otro aspecto es tan evidente este fenomenal desarrollo como en la arquitectura de la ciudad. Su abundante colección de edificios *art déco* de las décadas de 1920 y 1930 convive hoy hombro a hombro con un número creciente de impresionantes estructuras contemporáneas.

Es una ciudad cuyo horizonte evoluciona constantemente y en la que cada nueva estructura parece desafiar a las anteriores en cuanto a tamaño, materiales o audacia en el diseño. En un mundo en perpetuo cambio, la arquitectura de Shanghái avanza con confianza hacia el futuro.

«Nueva York puede ser la ciudad que nunca duerme, pero Shanghái ni siquiera se sienta».

Patricia Marx





Templo Ciudad de Dios



Hay un dicho popular en Shanghái: «si quieres conocer bien la ciudad, tienes que visitar el Templo Ciudad de Dios». El templo se ubica en una de las zonas tradicionales más populares de la ciudad y es el hogar del monasterio más grande y antiguo de Shanghái, fundado en el siglo X. La versión actual del templo data del siglo XV y, aunque ha sido restaurado en numerosas ocasiones, sigue considerándose el más auténtico de la ciudad.

Pagoda de Longhua



La Pagoda de Longhua se encuentra en el parque Longhua, al sur de la ciudad, y es donde la moderna Shanghái se reúne con su pasado tradicional. De estilo clásico, esta es la más conocida de las 16 pagodas históricas que aún adornan la ciudad. La estructura, de siete pisos, consiste en un núcleo tubular hueco de ladrillo rodeado por una escalera de madera. El exterior está decorado con balcones, barandales y cornisas orientales. El edificio original data del año 977 d. C. y, debido a la fragilidad de sus componentes de madera, el acceso al público ya no está permitido.







El Bund

Originalmente un área marítima situada fuera de la antigua ciudad amurallada de Shanghái, el Bund fue el hogar de numerosos bancos internacionales y firmas comerciales. Muchos de sus magníficos edificios *beaux arts* se construyeron a principios del siglo XX, mientras la zona se convertía en un importante centro financiero.



Edificio del HSBC (n.º 12, el Bund)

Este edificio neoclásico de seis pisos fue diseñado por una firma de arquitectura británica y terminado en 1923. En aquel entonces fue descrito como «el edificio más lujoso entre el canal de Suez y el estrecho de Bering». La cúpula central fue célebremente decorada con frescos dedicados a los doce signos del zodiaco. Sirvió como sede central del HSBC hasta 1955, cuando comenzó a ser conocido como Edificio del Gobierno Municipal. En la actualidad, el edificio alberga las instalaciones del Shanghai Pudong Development Bank.

Casa de Aduanas (n.º 13, el Bund)

Construido en 1927 en el mismo lugar que ocupaba un puesto aduanero tradicional de estilo chino, el edificio costó 4,3 millones de taeles de plata y todavía funciona como oficina de aduanas. La sección oriental tiene ocho pisos de altura, mira hacia el río Huangpu y está coronada por una torre con reloj de 90 m. La torre del reloj ofrece unas fantásticas vistas de todo el Bund y el centro de la ciudad de Shanghái. El mecanismo del reloj y la campana se construyeron en Inglaterra y son una imitación del Big Ben.





*«Para mis ojos de niño, que no habían visto nada más,
Shanghái era como despertar en un sueño en el que
todo lo que pudiera imaginar ya se había llevado
al extremo».*

J. G. Ballard

Hotel Radisson Blu Shanghai New World

Este hotel de 208 m de altura se encuentra en el distrito Huangpu de la ciudad. La estructura original se terminó en 2001, aunque la cúpula no se agregó hasta 2005. El edificio es conocido por el restaurante giratorio del piso 45 y el bar situado debajo de la emblemática cúpula de vidrio del hotel.



Torre de la Perla Oriental

Situada en el Bund, esta torre de radio y televisión de 468 m de altura se ha convertido en un referente de la ciudad, especialmente por su carácter futurista, que destaca frente a los diversos estilos arquitectónicos de la zona. Terminada en 1994, la torre se compone de 11 esferas de diferentes tamaños, la más grande de las cuales mide 50 m de diámetro y se apoya en varias patas que llegan hasta el suelo. La torre se encuentra junto al río y cuenta con 15 observatorios en diferentes pisos, el más alto de ellos a 350 m de altura.

*«Y Shanghái es asombrosa.
Me encanta la ciencia ficción,
así que cuando estoy allí, en la
noche, con todas las luces y
toda esa modernidad, es como
estar en el escenario de una
película».*

Berenice Marlohe





Shanghai World Financial Center

Encargado de crear un edificio que simbolizara el carácter emergente de Shanghái como capital internacional, el arquitecto William Pedersen apostó por dos arcos contrapuestos y un prisma cuadrado: formas que también representan los antiguos símbolos chinos del cielo y la tierra.

Conocida localmente como «el Destapador», la estructura, de 492 m de altura, es una miniciudad vertical con 62 pisos de oficinas, salas de conferencias, comercios y restaurantes, y cuenta con un hotel de cinco estrellas y 174 habitaciones en la parte superior. El diseño del edificio ha recibido grandes elogios de la crítica desde que fuera terminado en 2008: un jurado arquitectónico llegó a declarar que era «una absoluta genialidad».





Torre de Shanghái

Construir a lo alto en Shanghái implica una serie de desafíos: la ciudad se asienta en el arenoso suelo del delta de un río y es azotada con frecuencia por tifones tropicales. Con tantos obstáculos por superar, cuando los arquitectos e ingenieros quisieron construir el edificio más alto de China, tuvieron que ser innovadores. Apoyaron la estructura completa en enormes pilares de concreto de 70 m de longitud para lograr los cimientos perfectos; asimismo, la forma cilíndrica en espiral de la torre no sólo es elegante, sino también aerodinámica (reduce las cargas de viento en un 24 %).

Con una altura de 632 m, la Torre de Shanghái es el segundo edificio más alto del mundo. No obstante, cuenta con la plataforma de observación más alta, a 561 m de altura, y los elevadores más rápidos, capaces de recorrer el edificio hacia arriba y hacia abajo a 65 km/h.





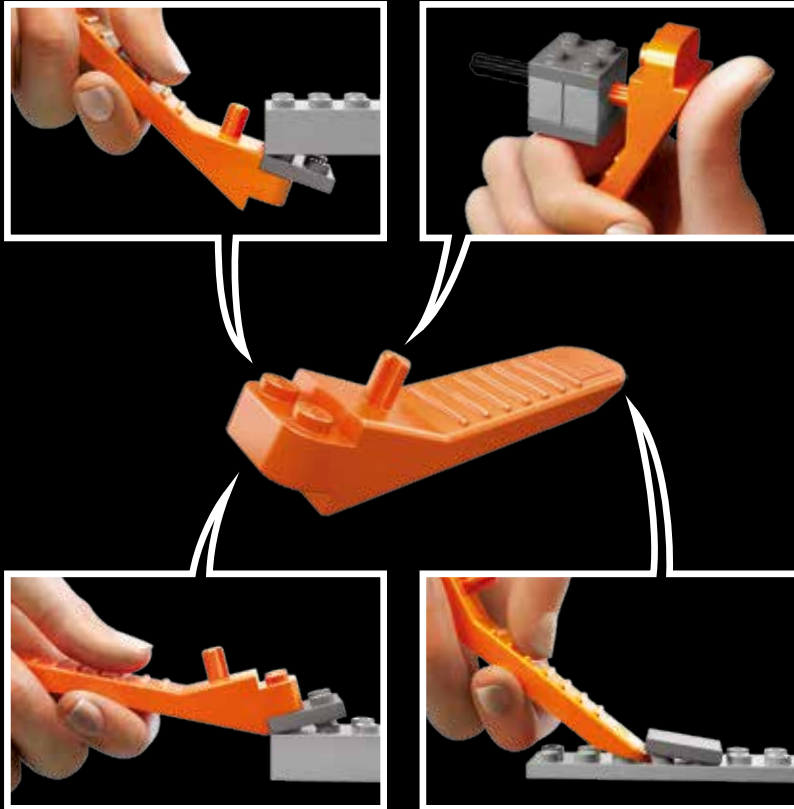

LEGO.com/brickseparator

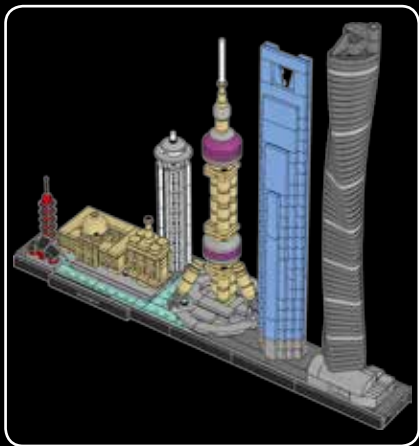

1

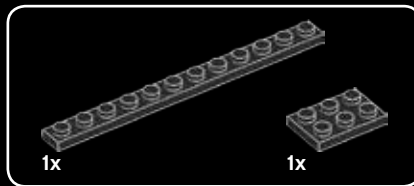
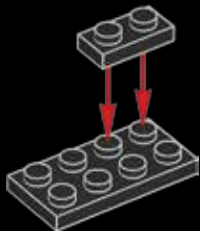

2

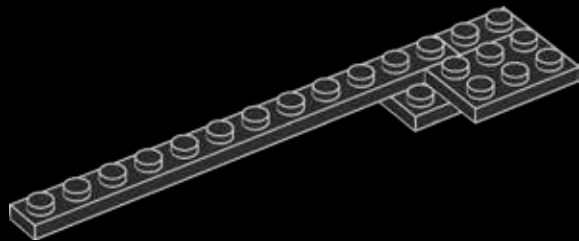



2x

3

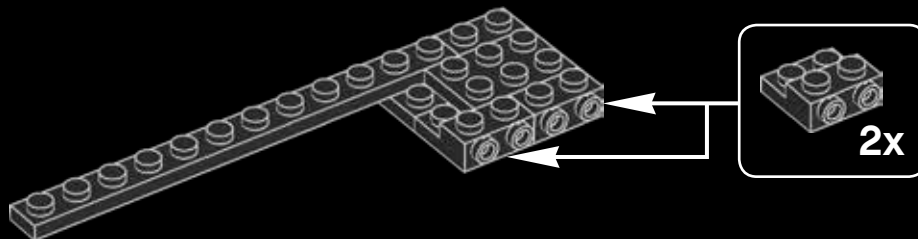

2x

4

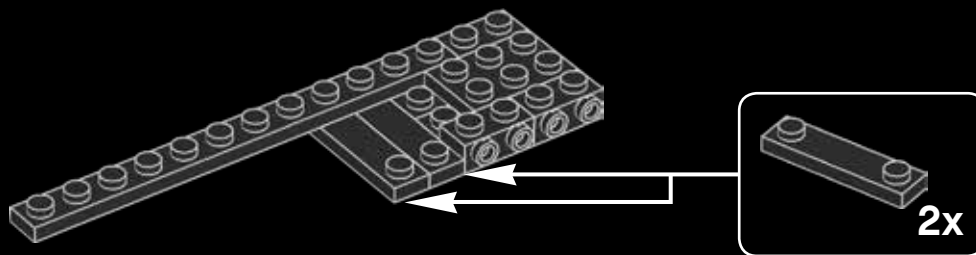



5

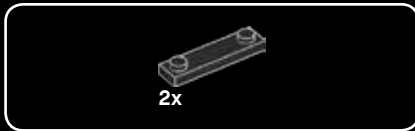
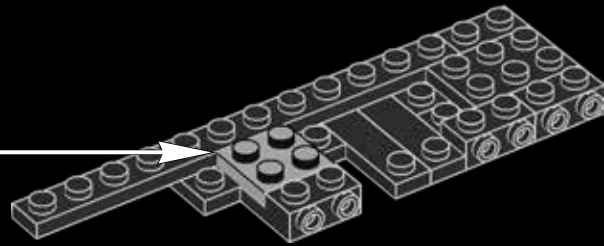
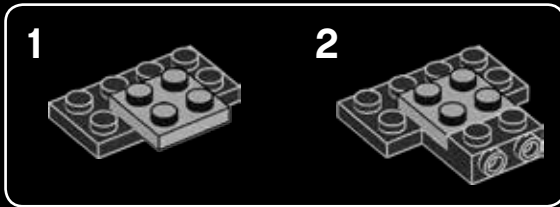

6

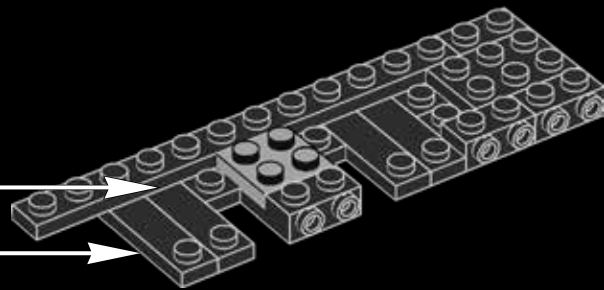
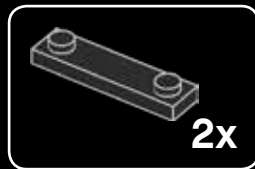



7

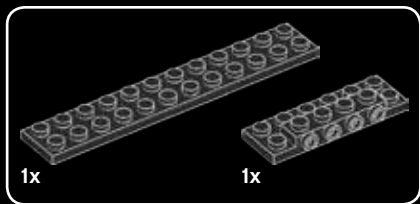
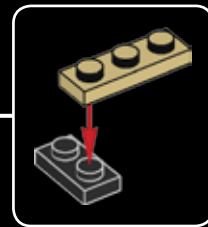
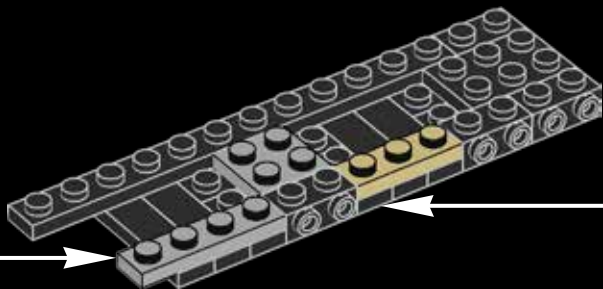
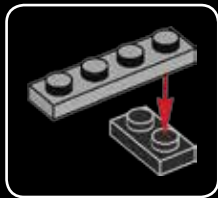

8

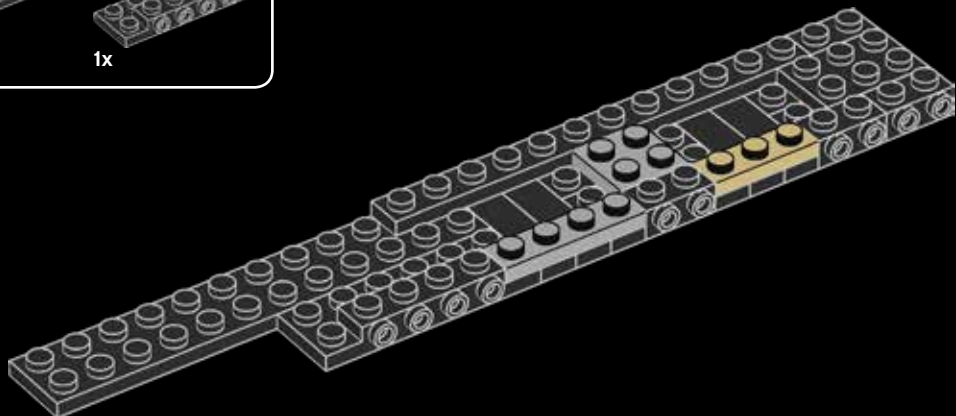

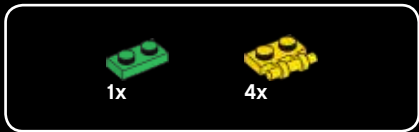

9

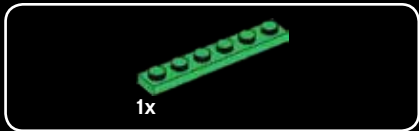
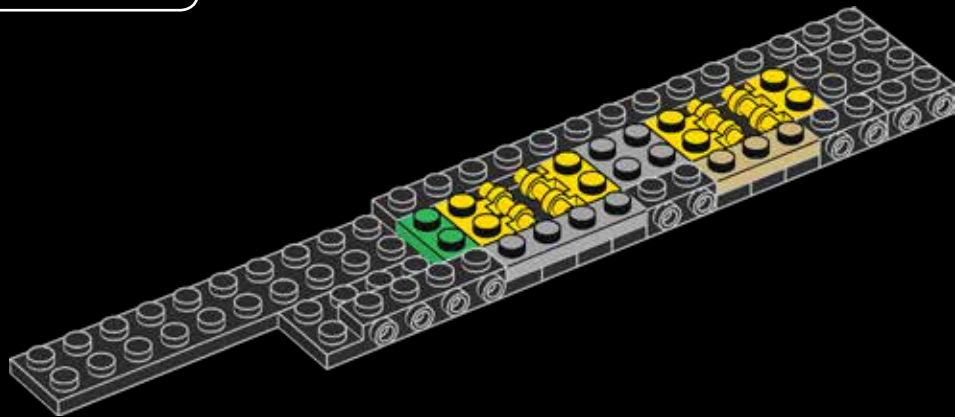

10

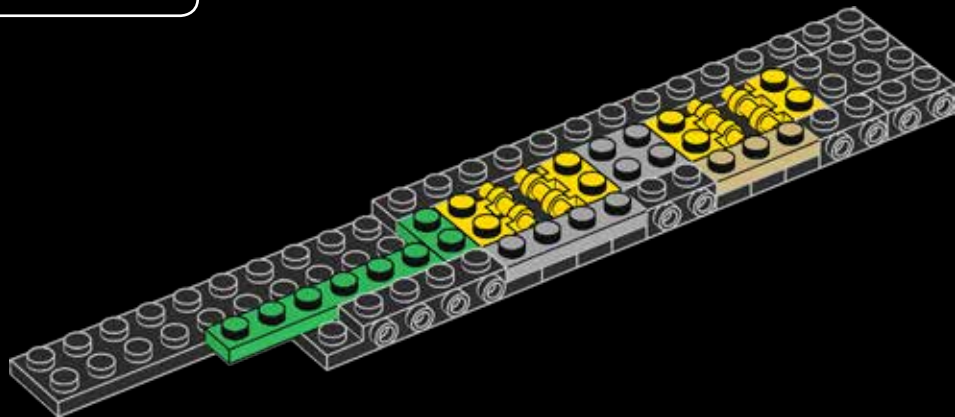

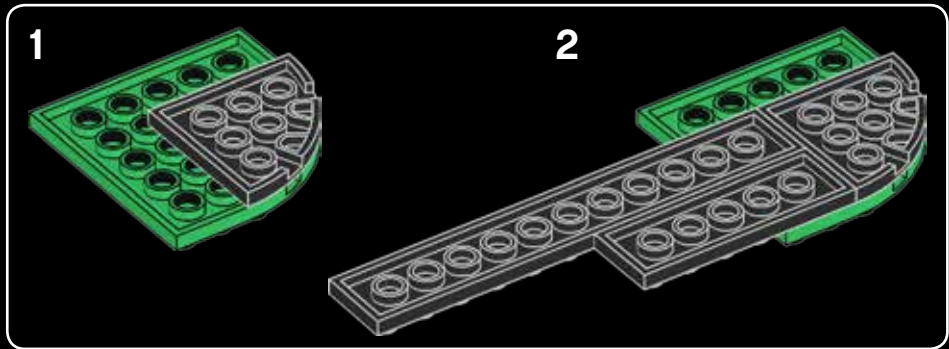
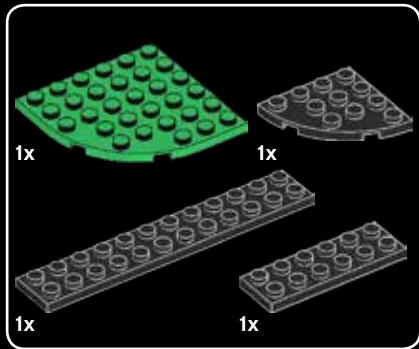

11

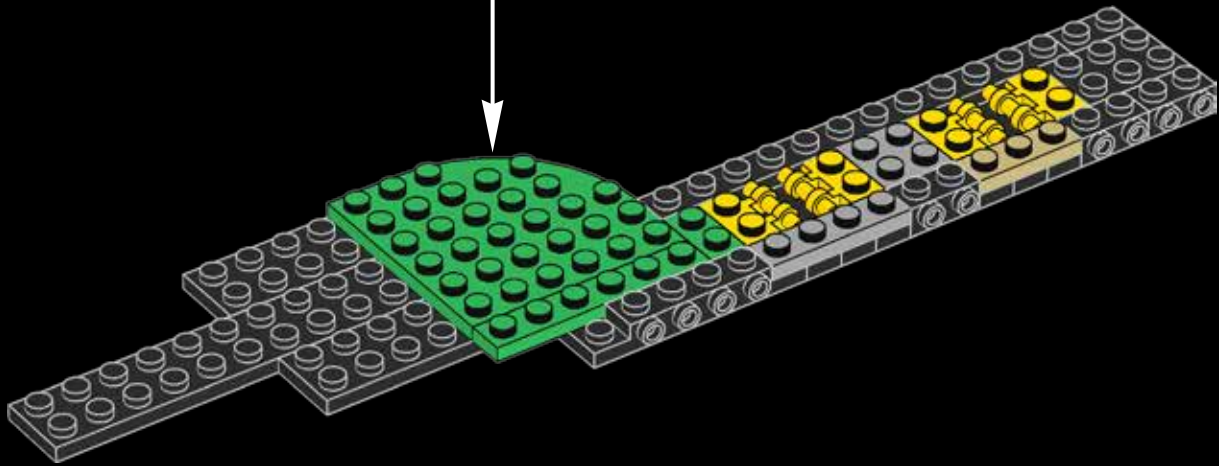

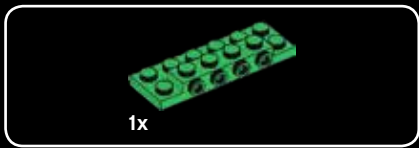

12

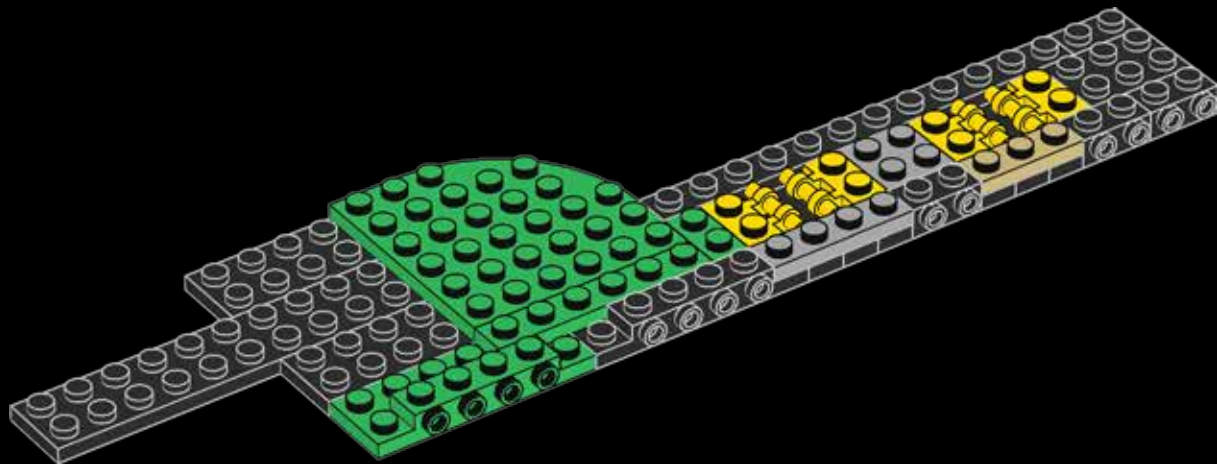

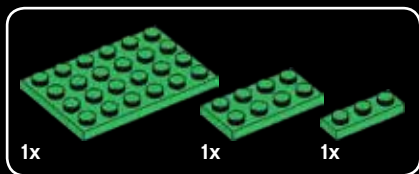

13

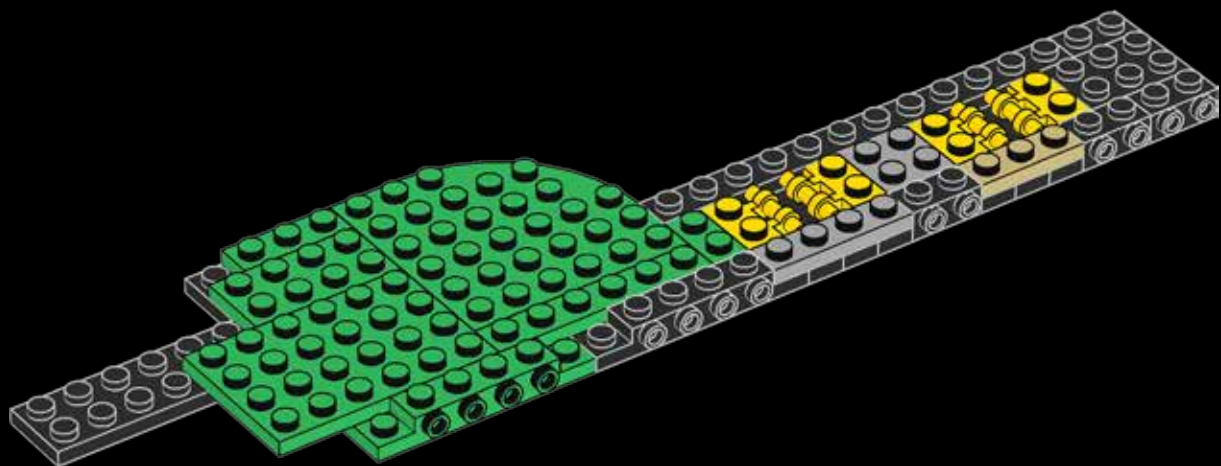

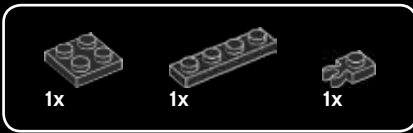

14

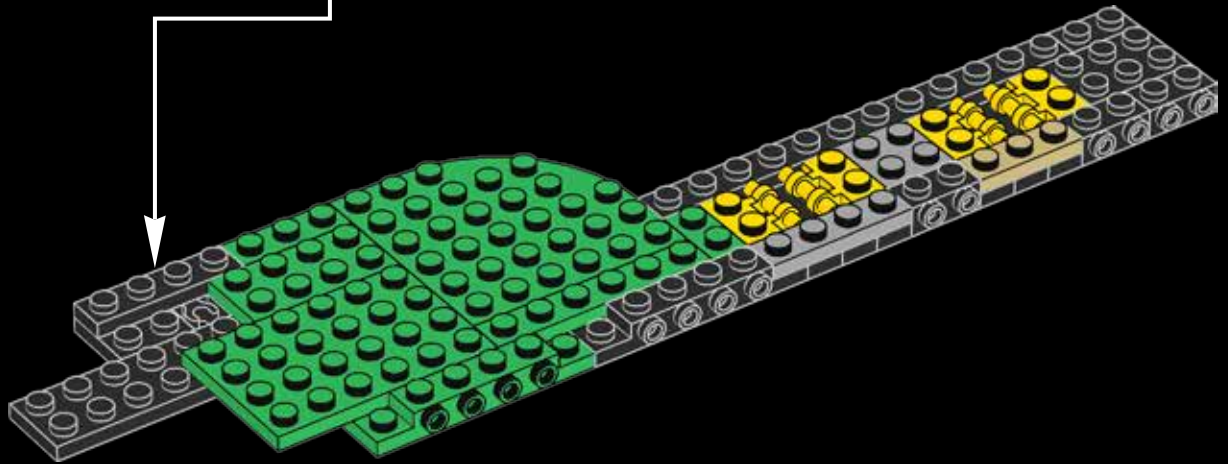
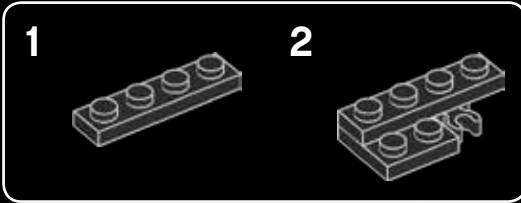



1x



1x

15

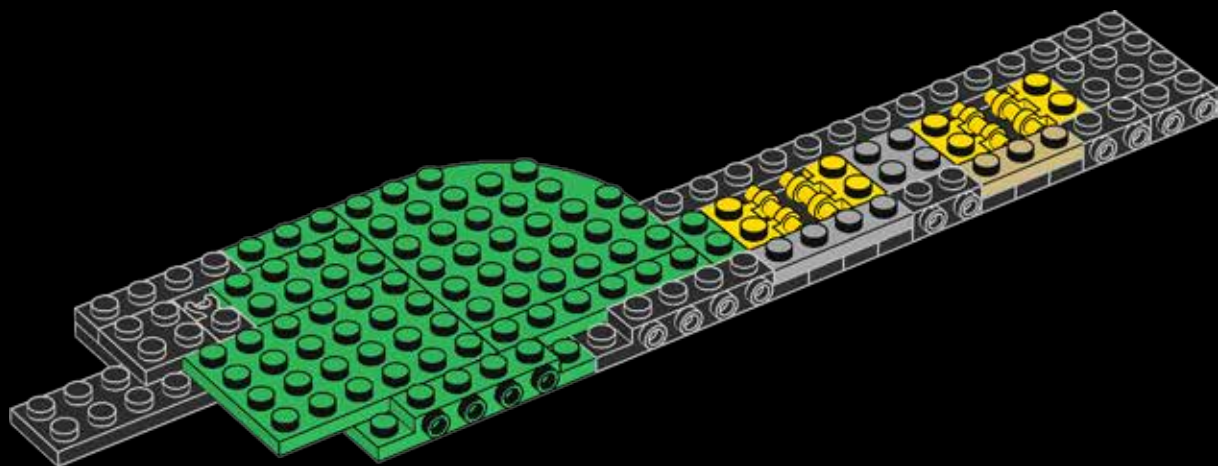

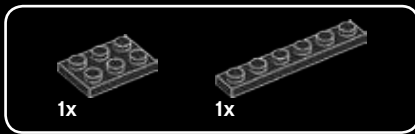

16

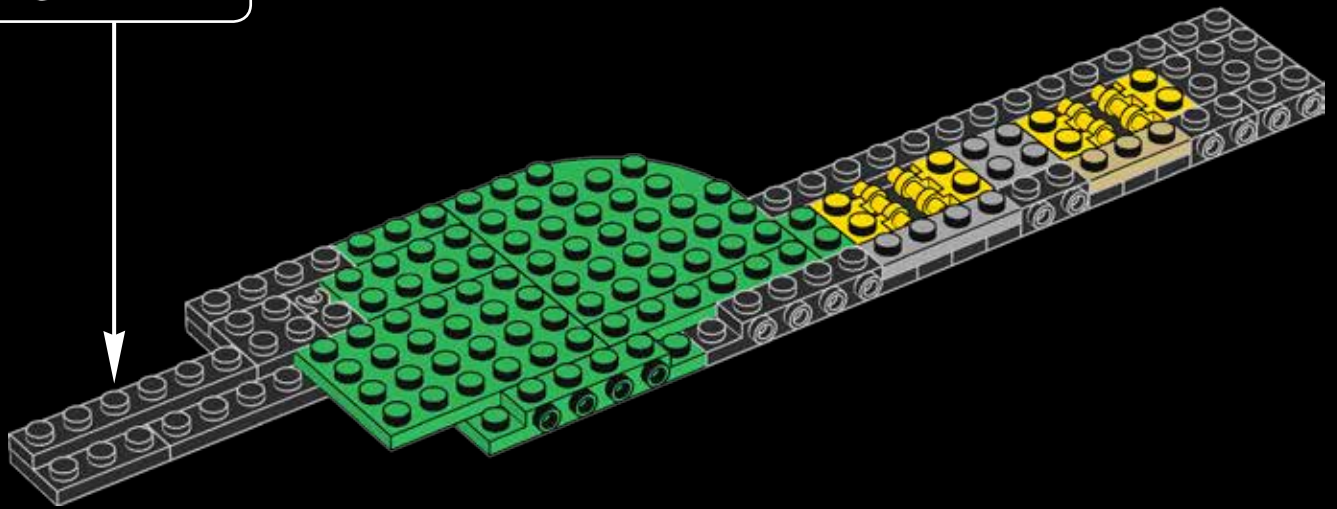
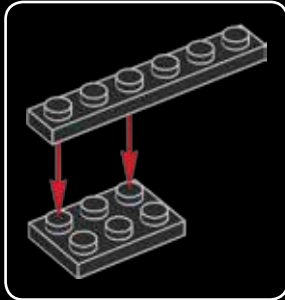

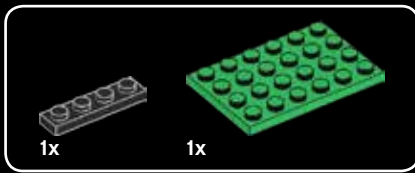

18

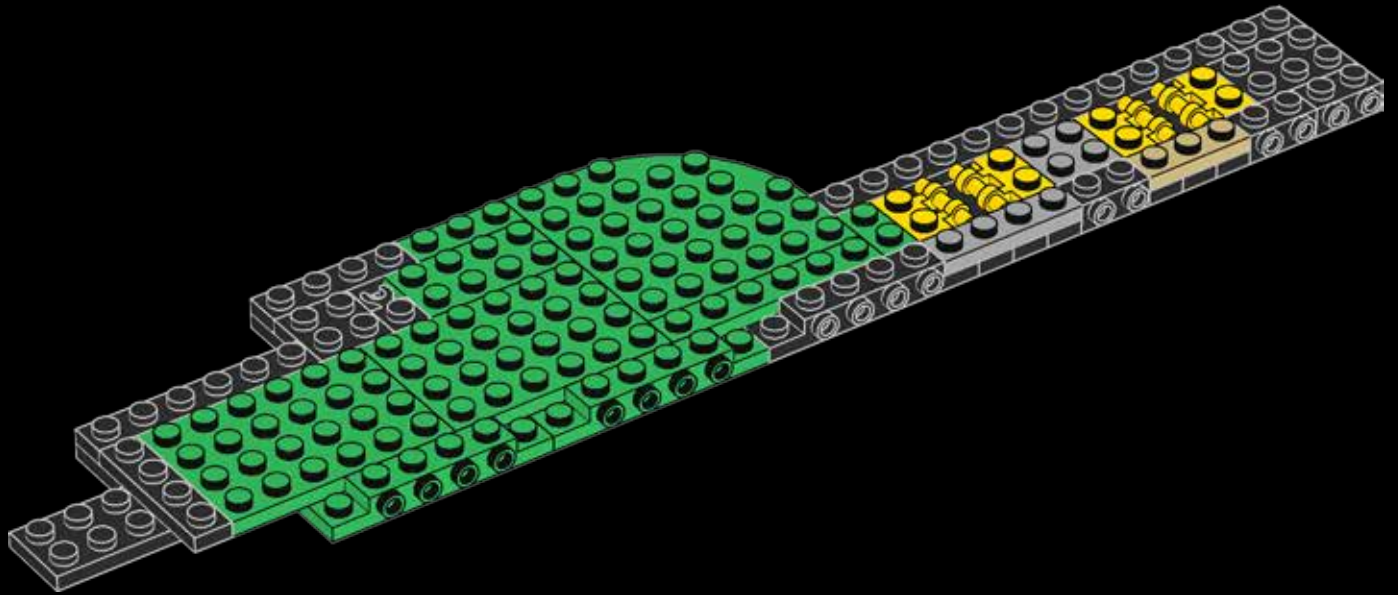



19

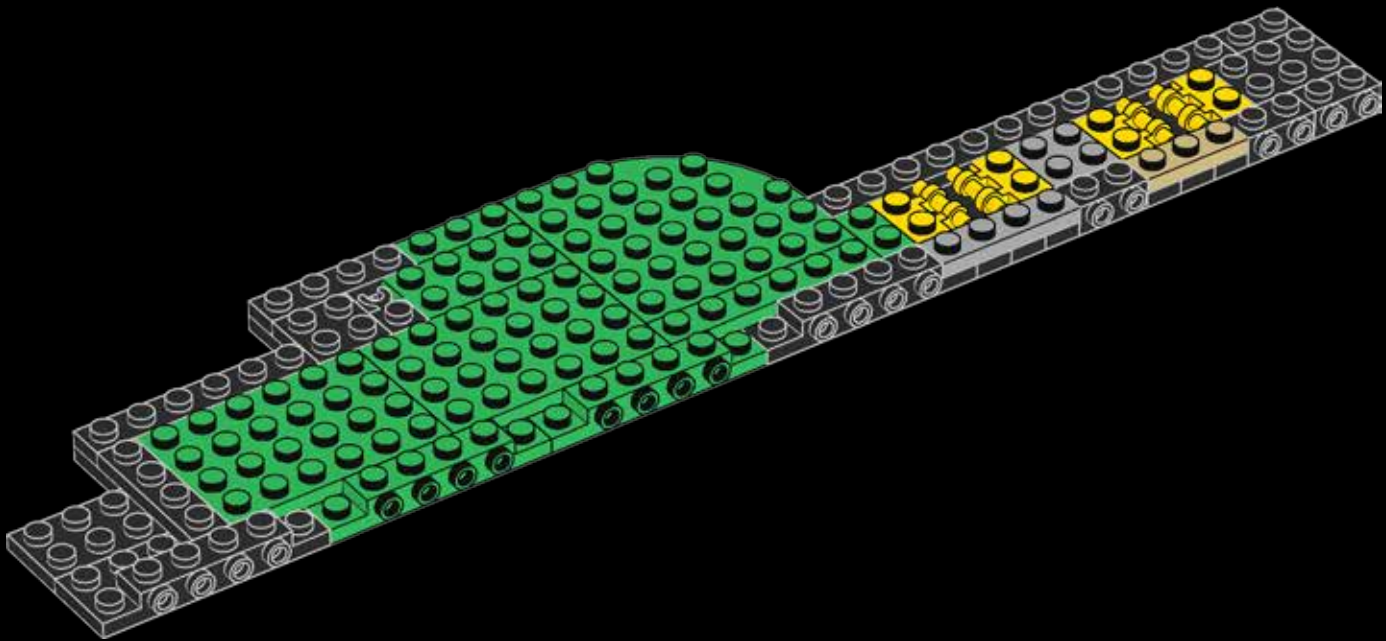

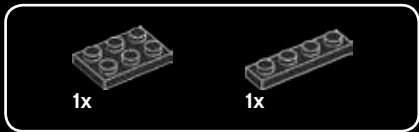

20

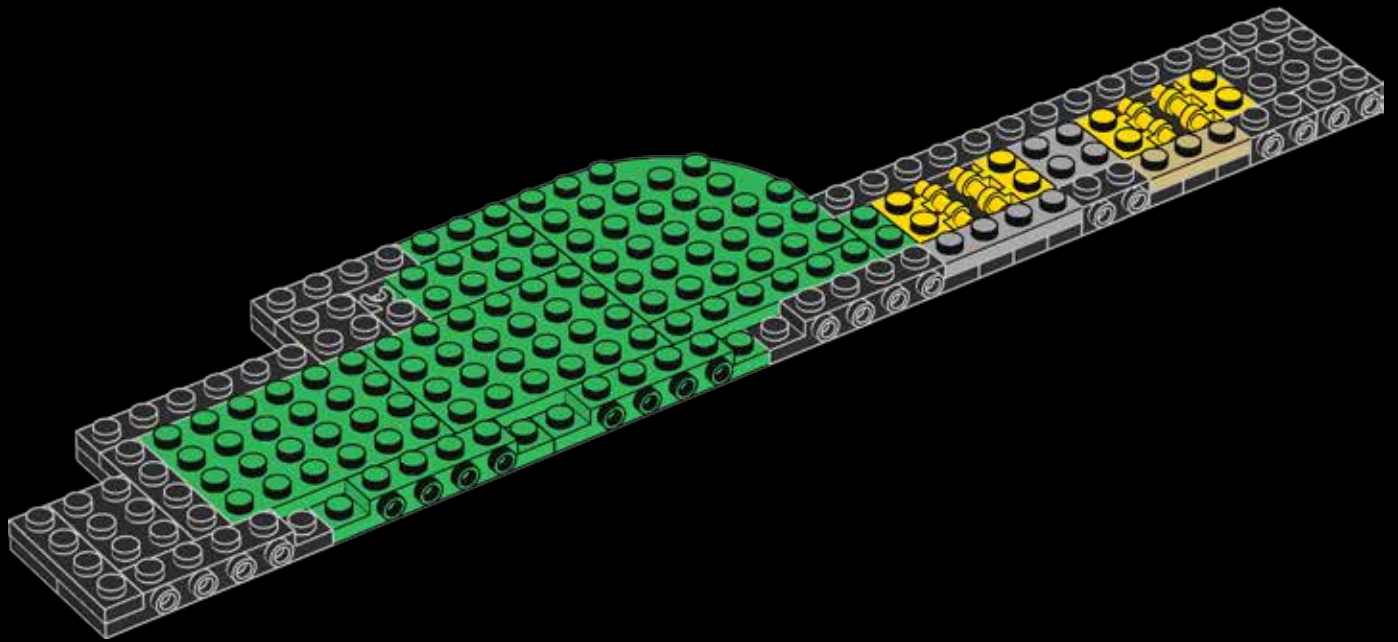

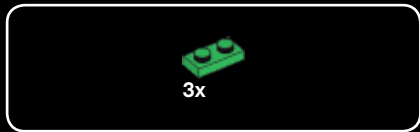

21

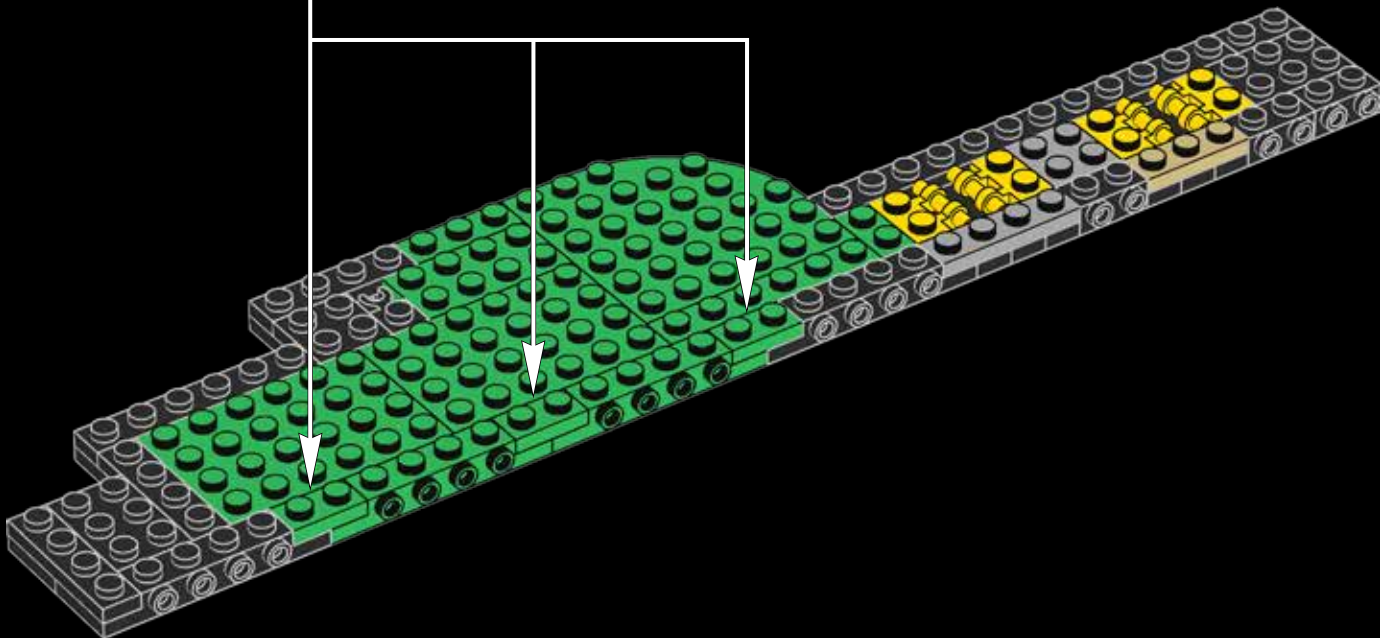
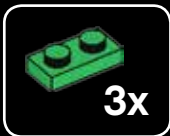

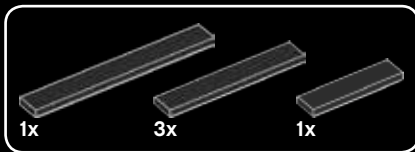

22

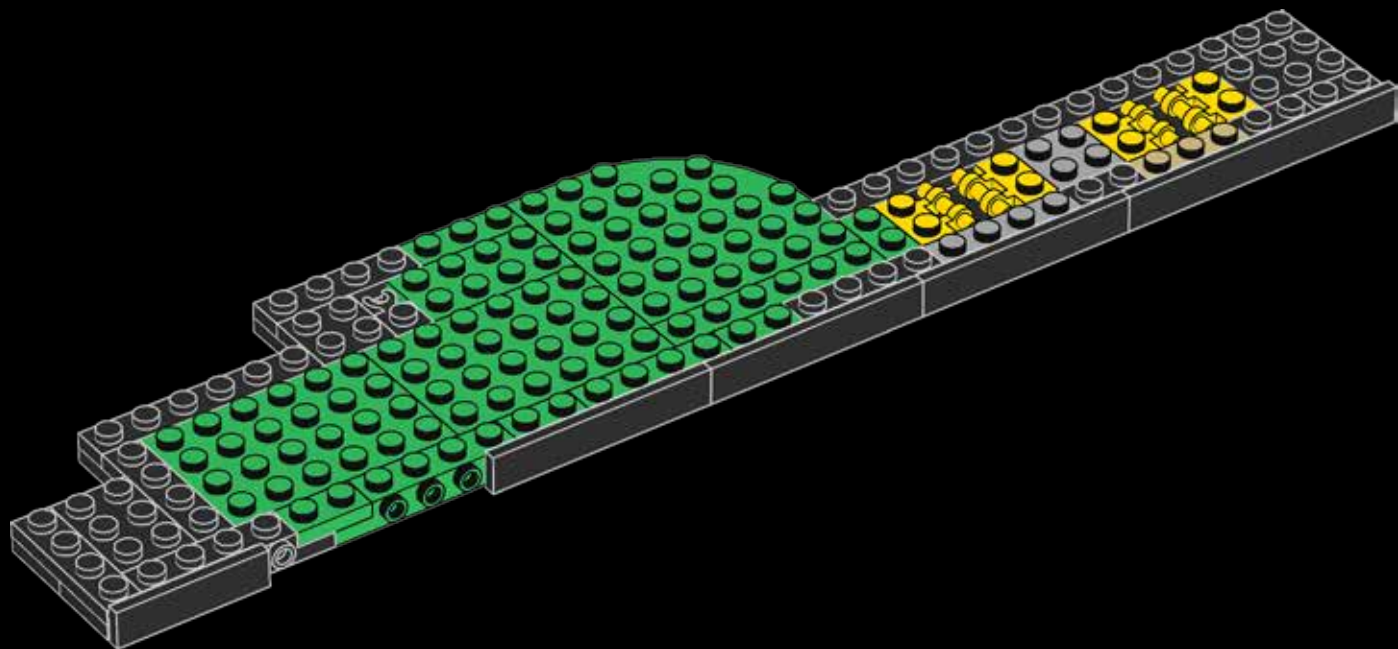

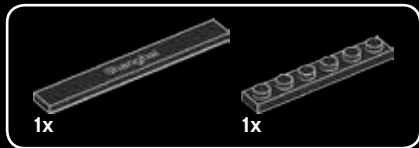

23

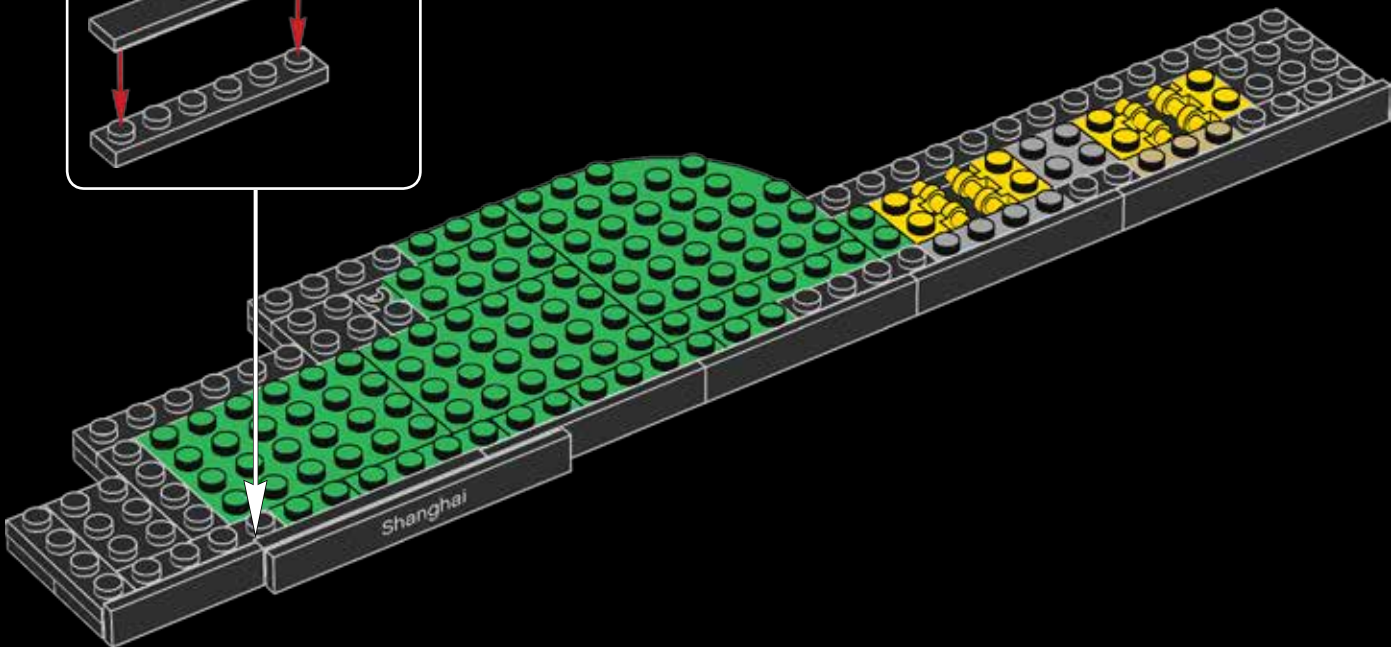
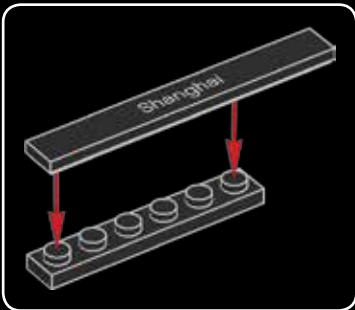

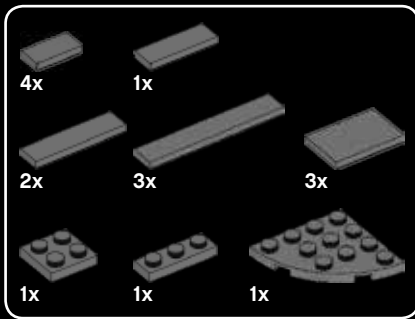

24

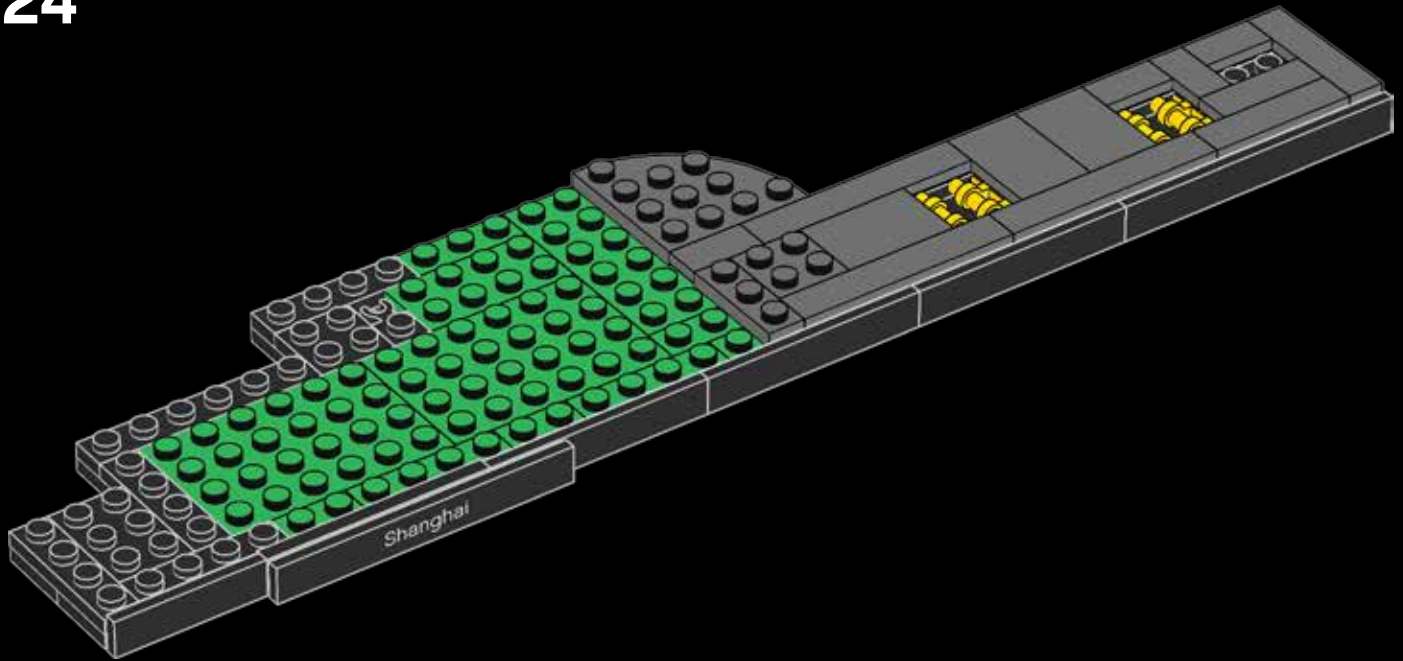

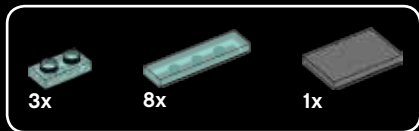

25

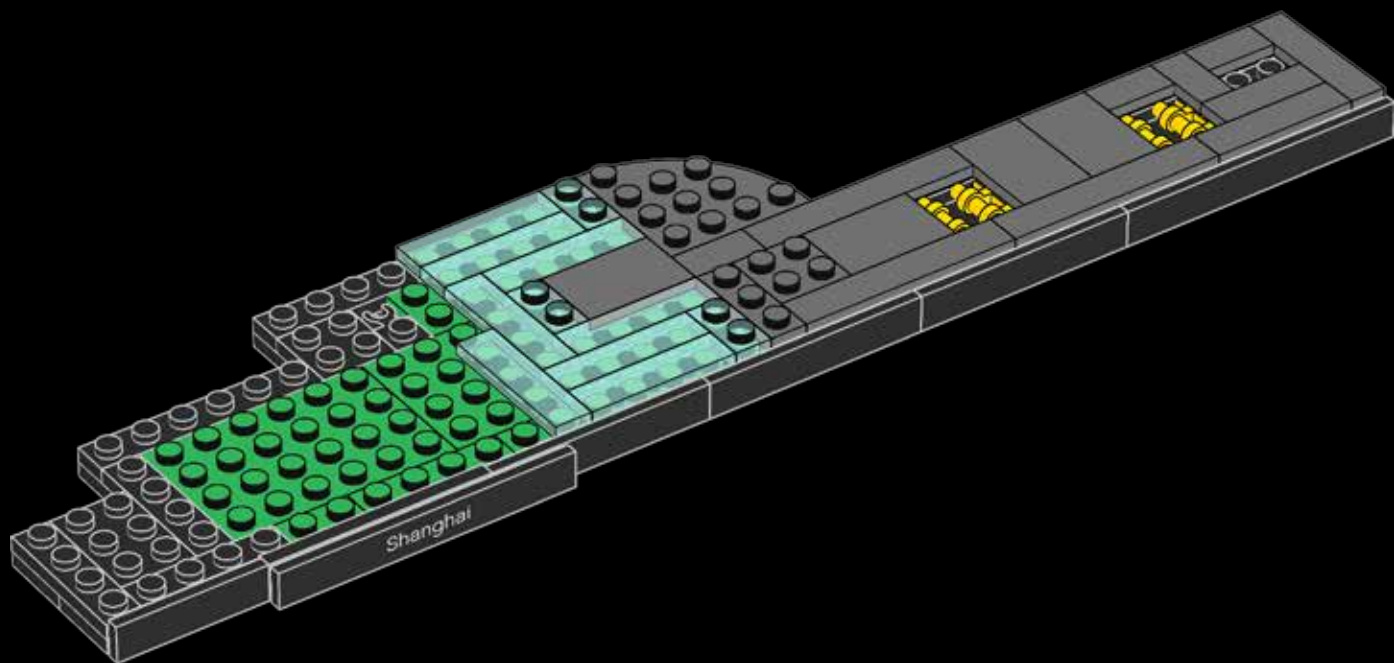

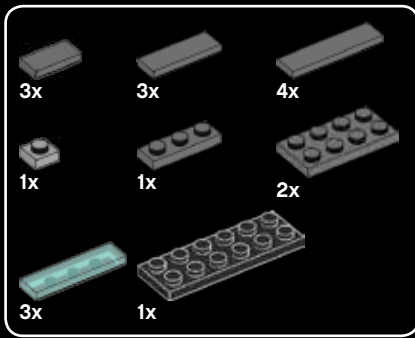

26

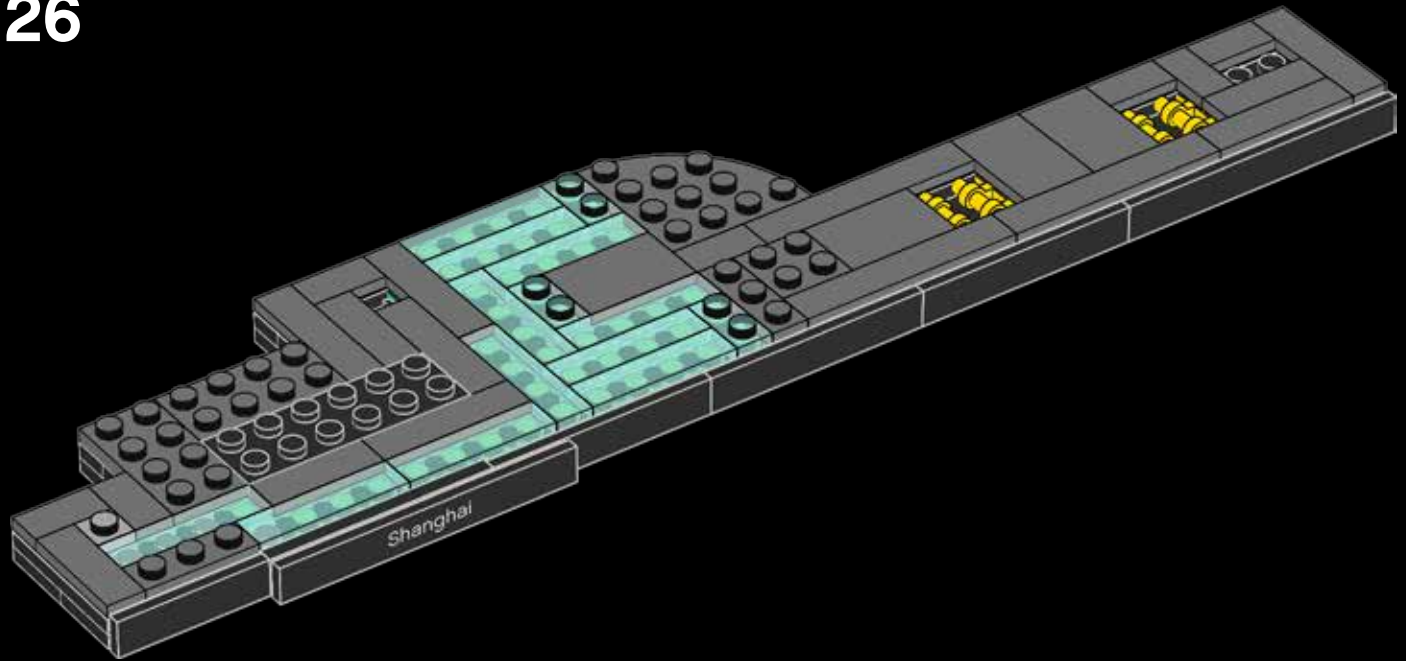

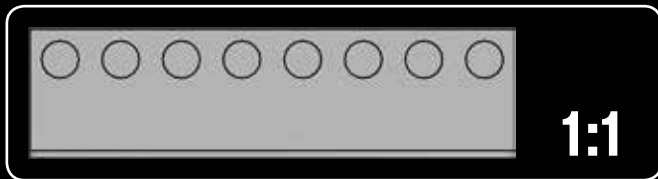
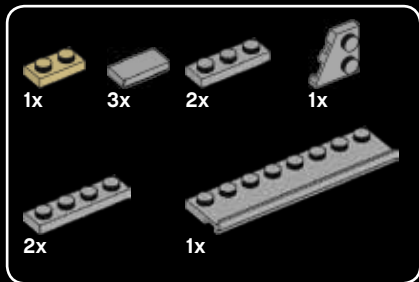

27

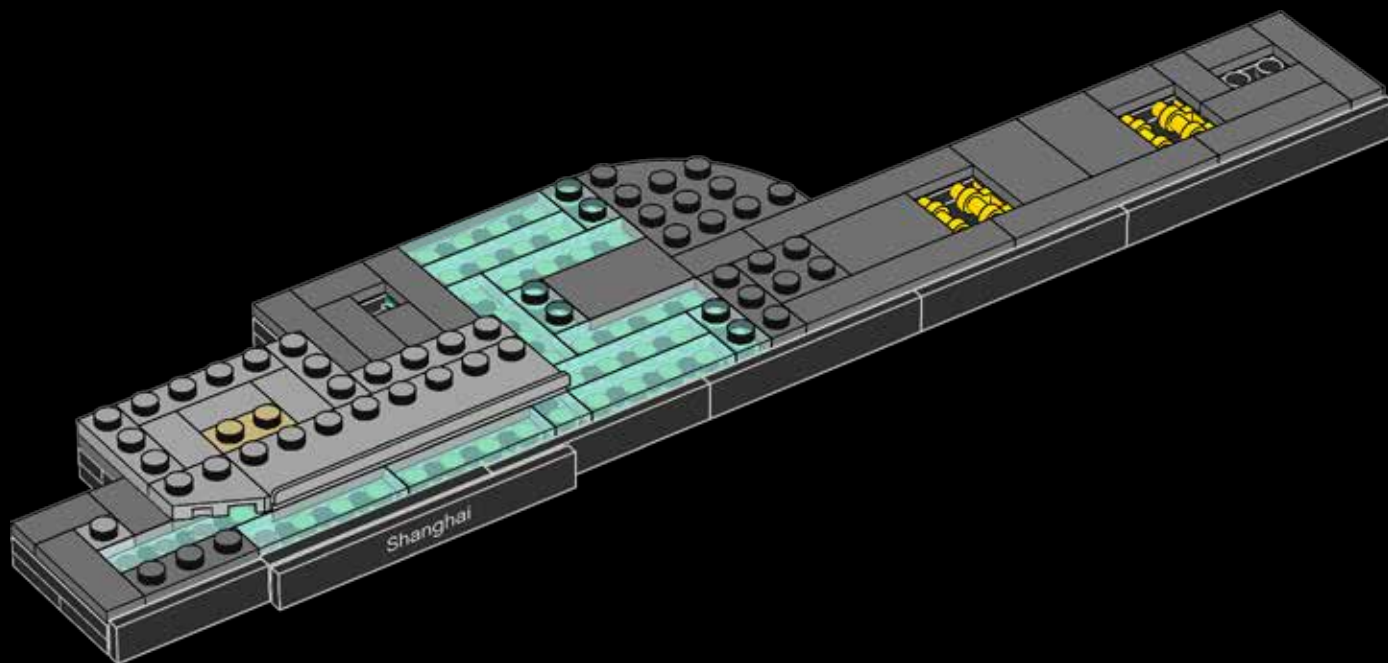



28

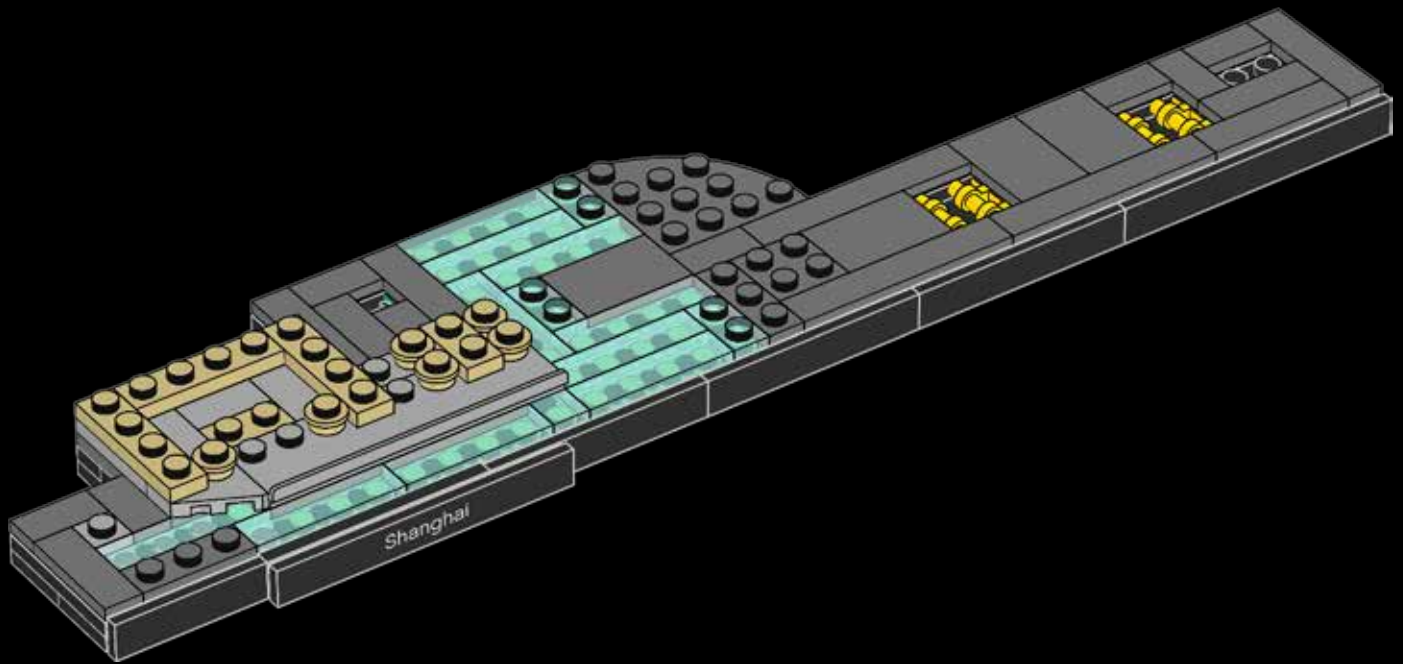



3x

29

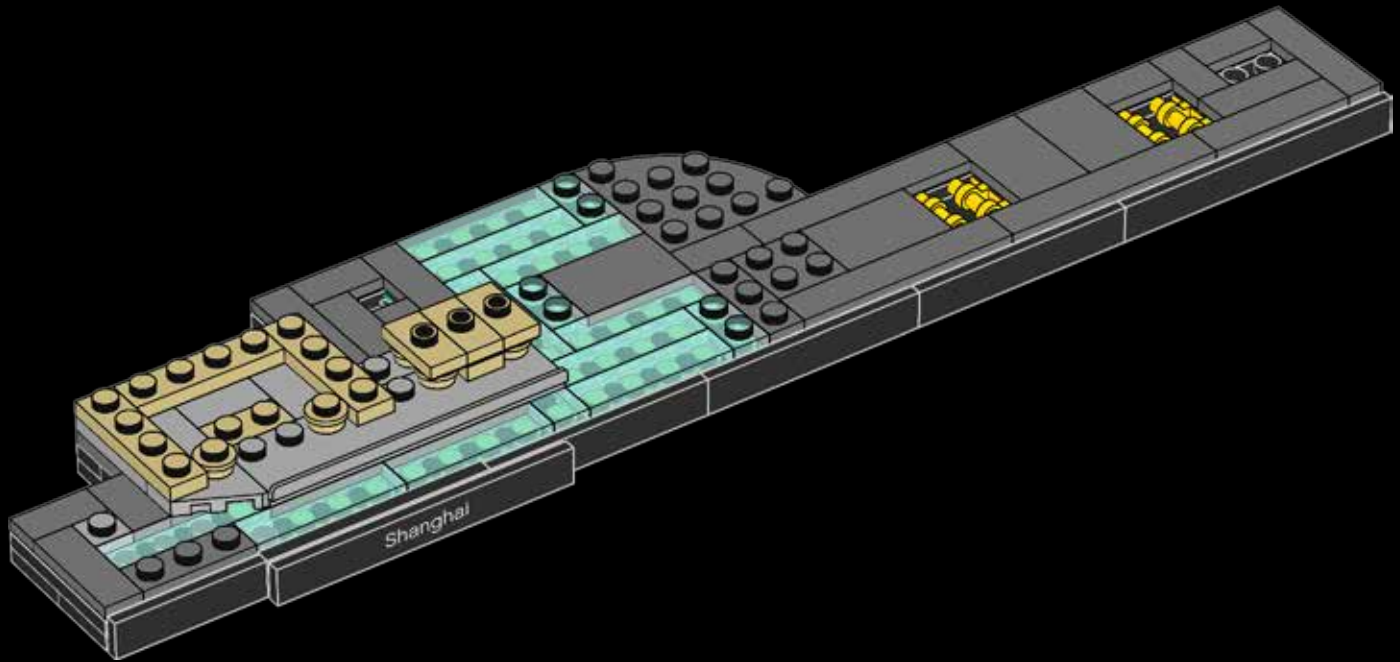



3x

30

The Customs House clock remains the largest one in Asia today.

Le clocher du bureau de douane demeure à ce jour le plus grand en Asie.

El reloj de la Casa de Aduanas sigue siendo el más grande de Asia en la actualidad.

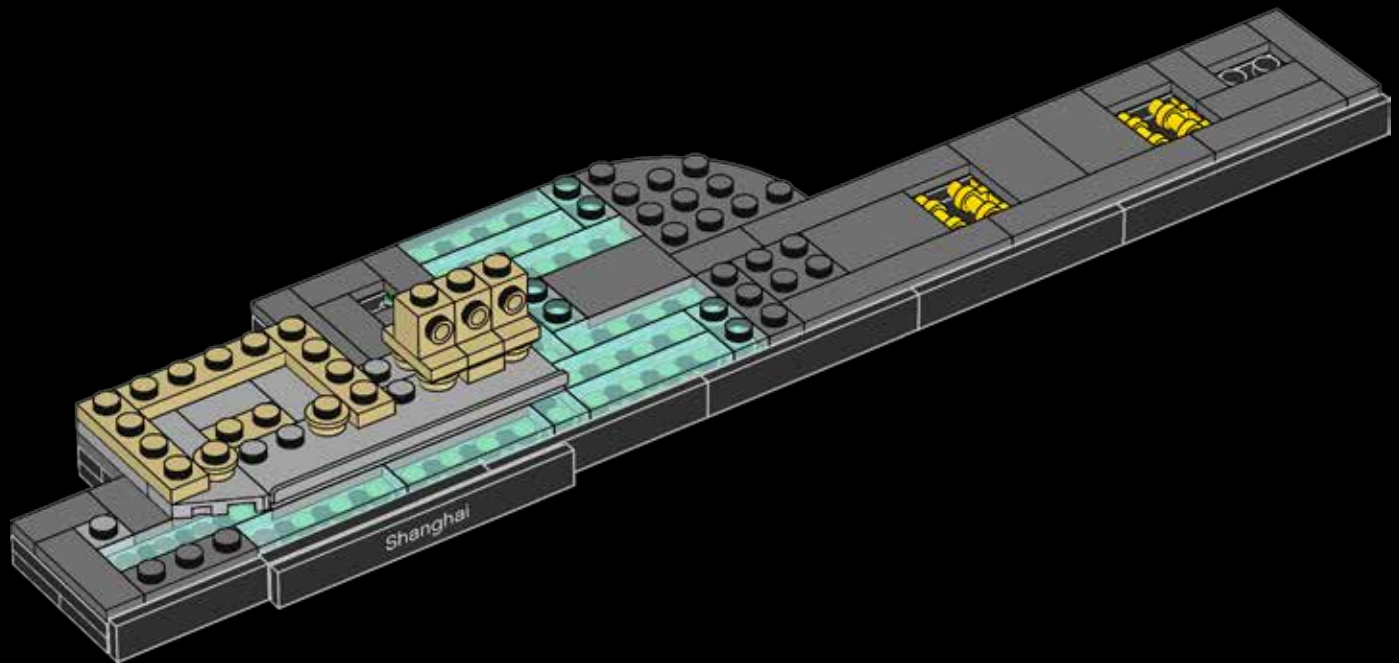

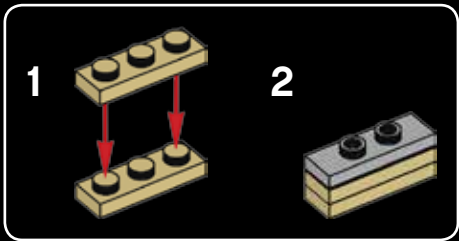

31

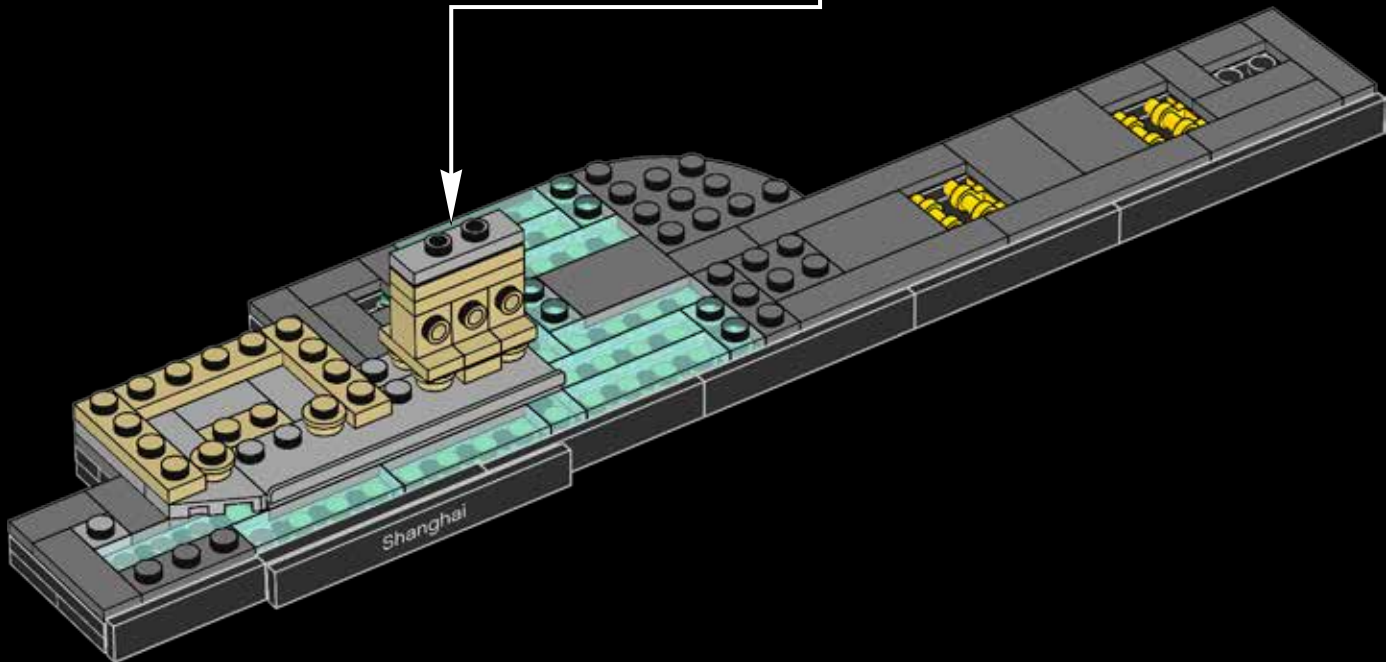



32

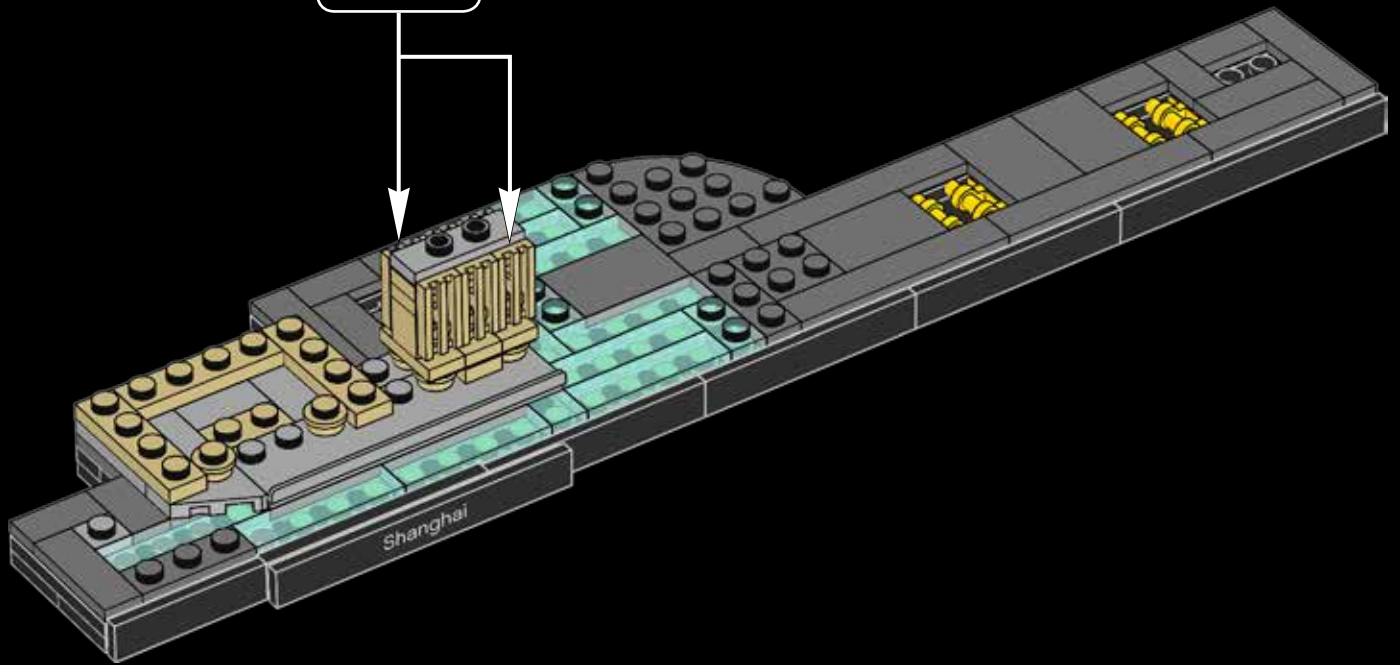
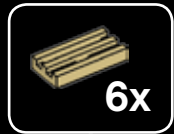



33

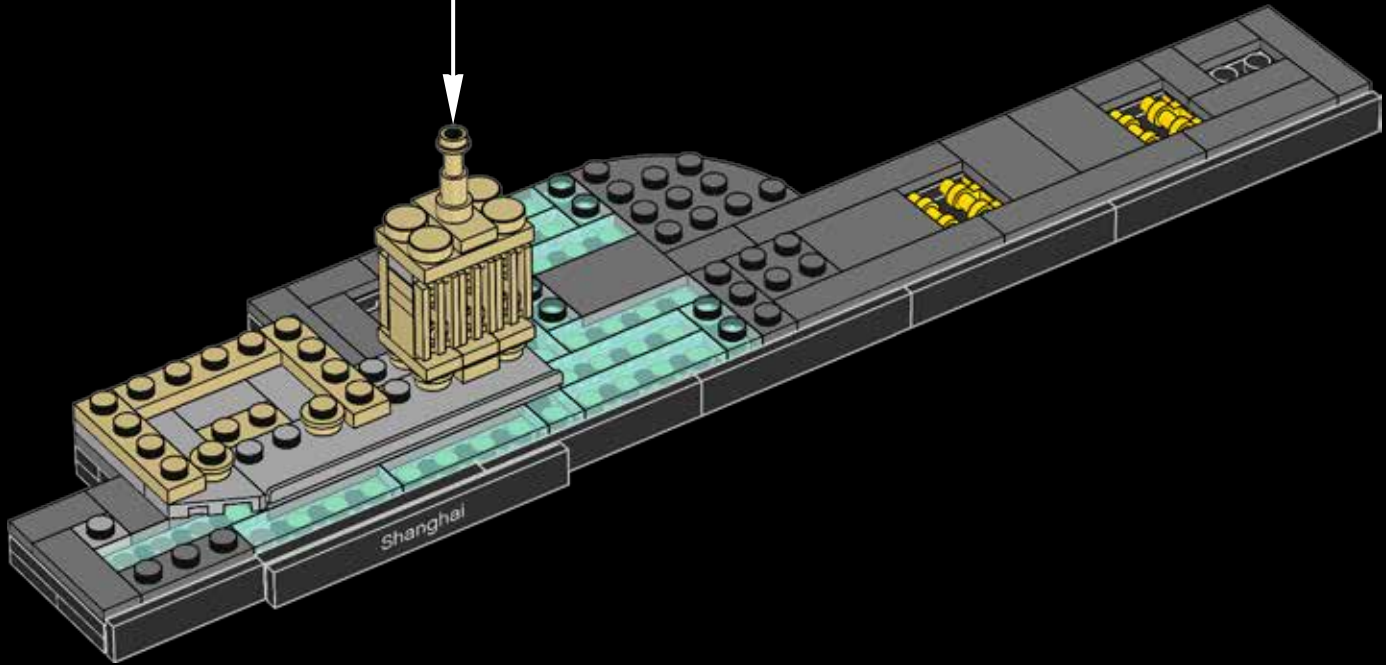
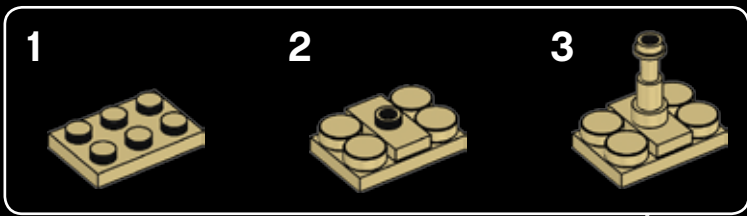



34

Each of the four clock faces in the clock tower has a diameter of 17 ft. (5.3 m) and is made up of 100 pieces of glass.

Chacune des quatre horloges de la tour a un diamètre de 5,3 m et est composée de 100 pièces de verre.

Cada una de las cuatro esferas del reloj de la torre tiene un diámetro de 5,3 m y se compone de hasta 100 piezas de vidrio.

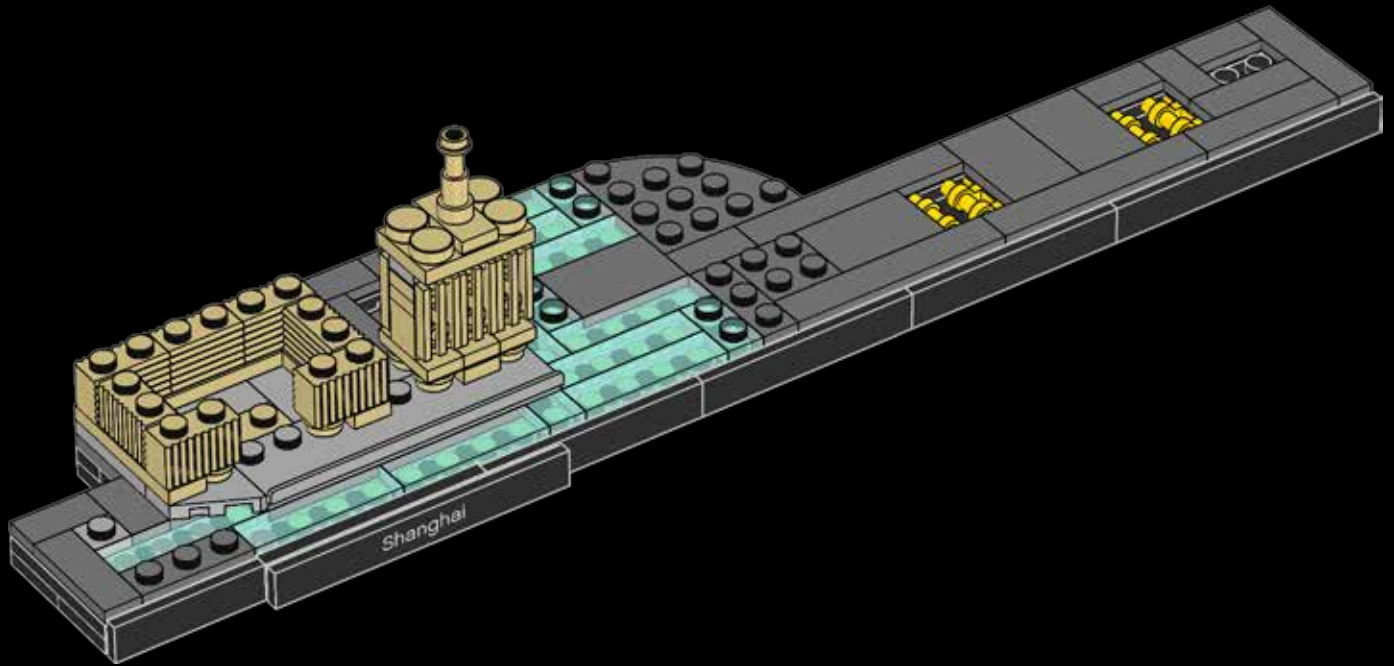



35

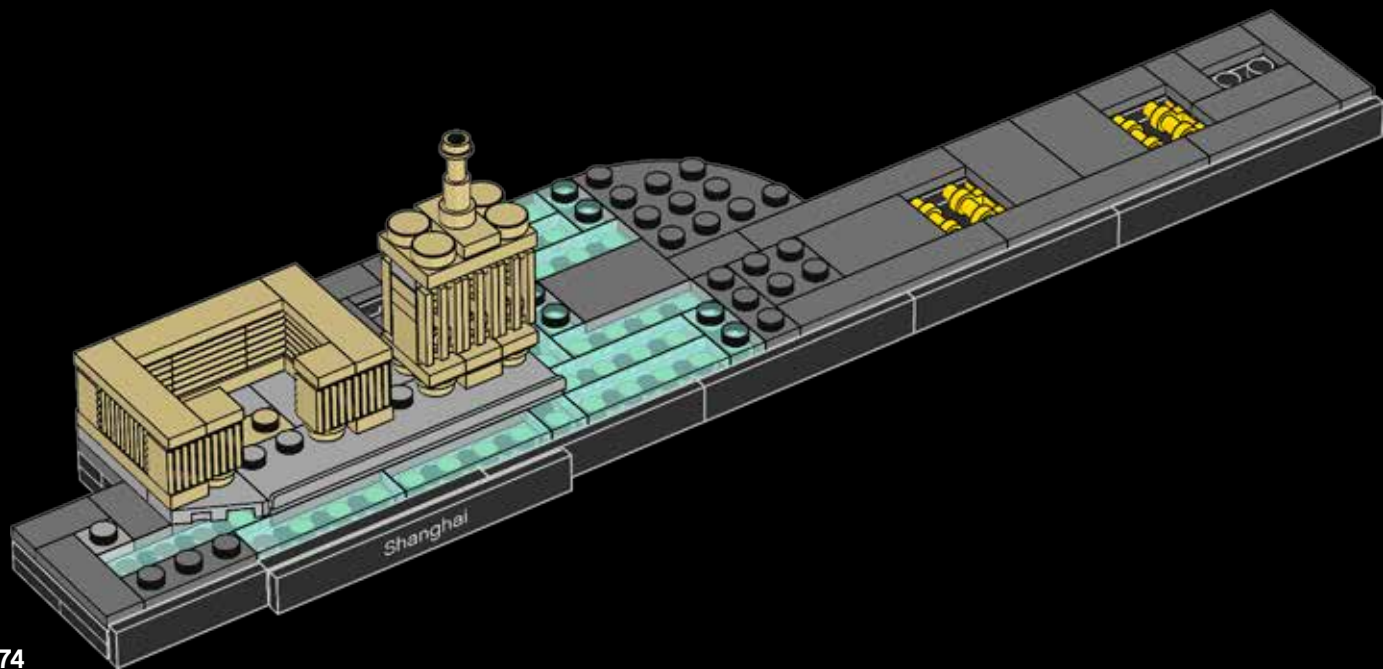

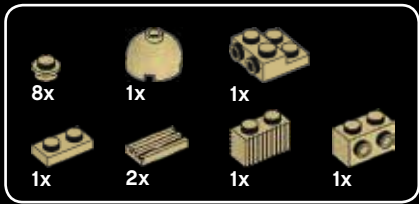

36

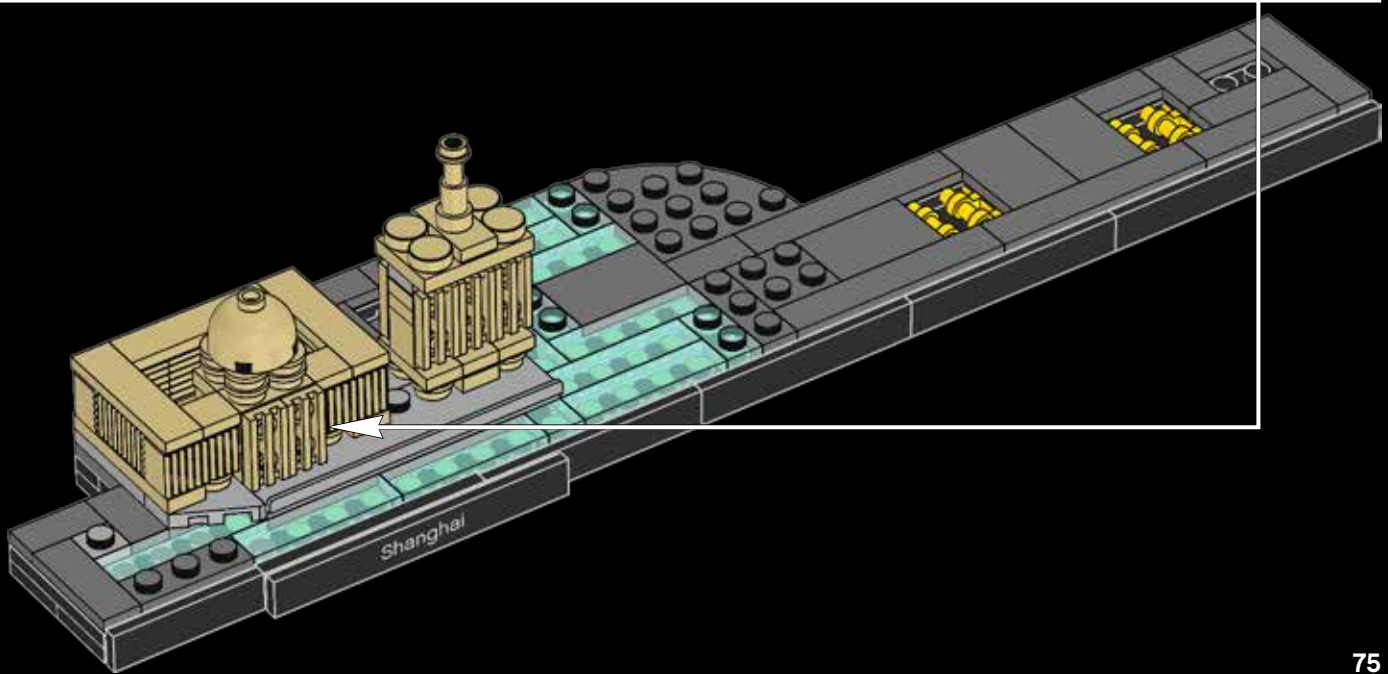
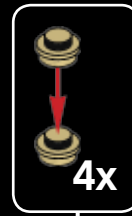
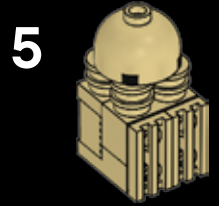
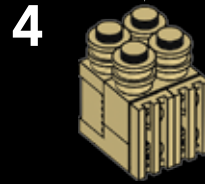
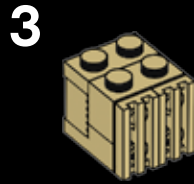
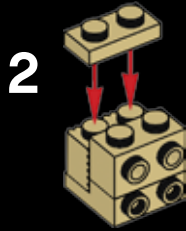
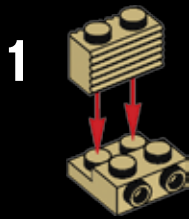

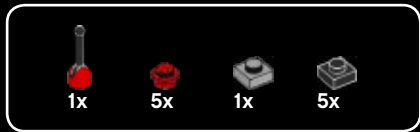

37

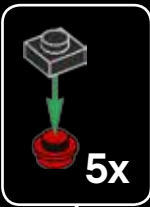

1



2



3

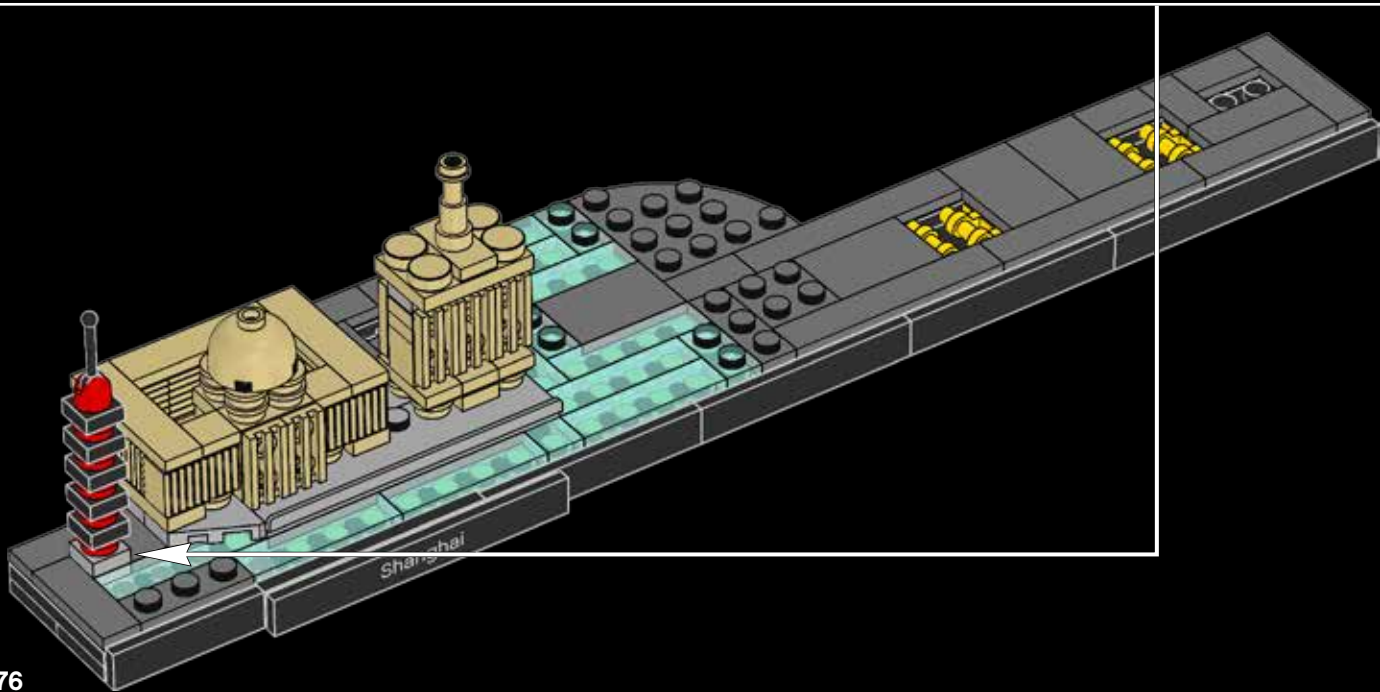



Many Shanghai residents frequent the temple to offer incense before their favorite local god, hoping for good fortune in return.

Bon nombre des résidents de Shanghai fréquentent le temple pour y faire des offrandes d'encens à leur dieu local favori. Ils souhaitent ainsi attirer la chance sur eux.

Muchos habitantes de Shangháí visitan el templo con frecuencia para ofrecerle incienso a su dios local preferido, esperando recibir a cambio buena suerte.



38

1



2



3

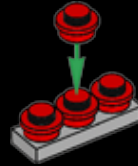

4

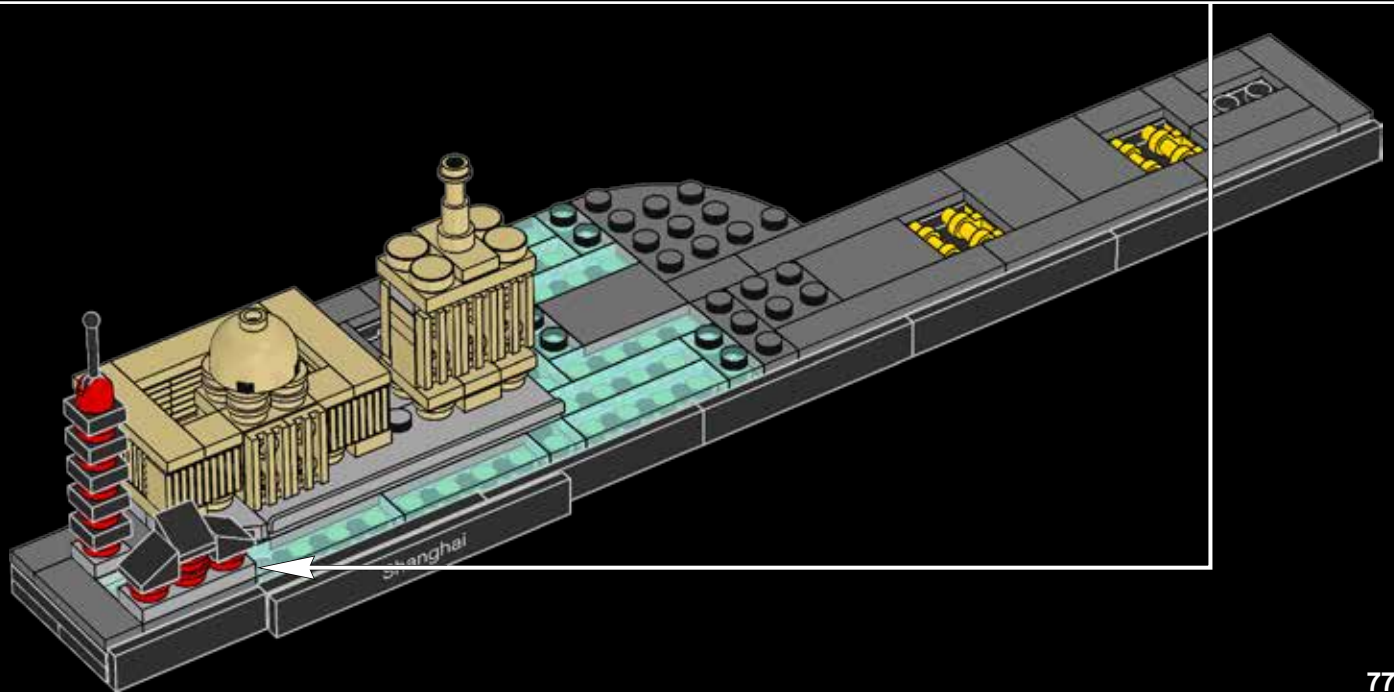

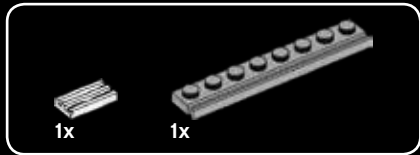

1x

1x

39

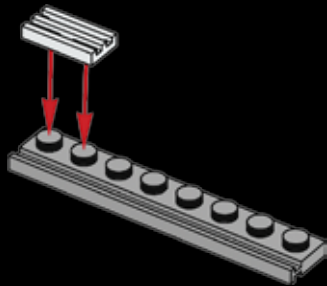

3x

40

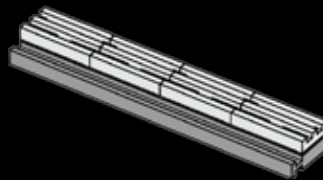



41

1



2



3



4



5



6

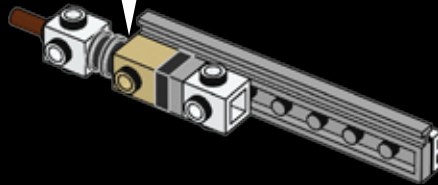

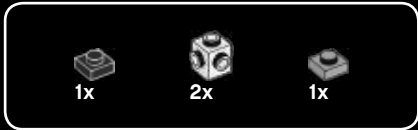

42

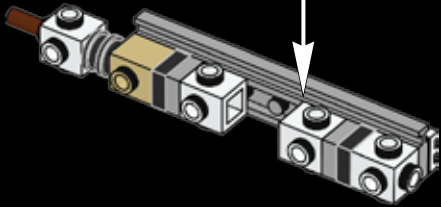
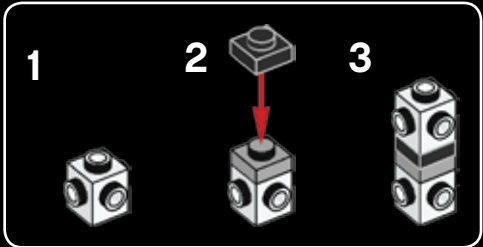

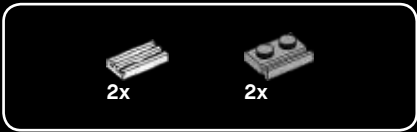

43

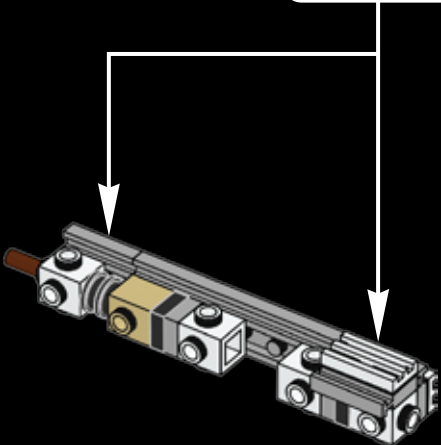
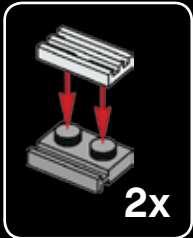

44

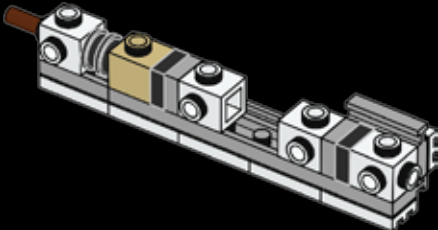

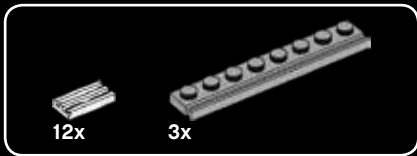

45

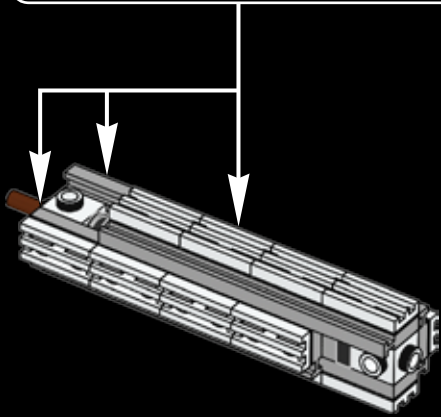
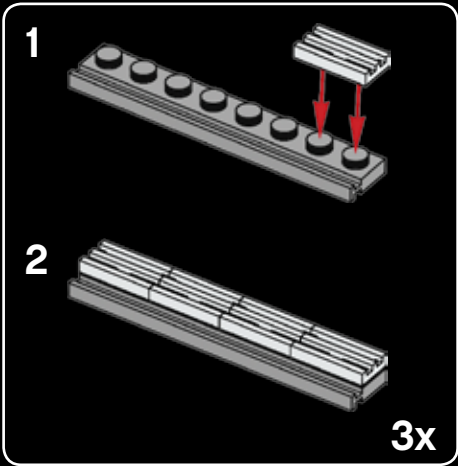

46

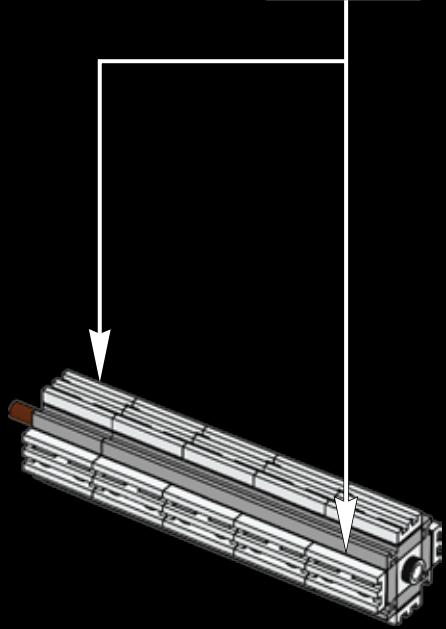
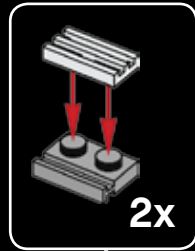

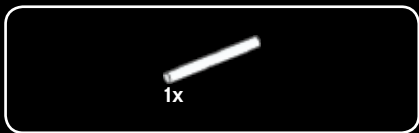

47

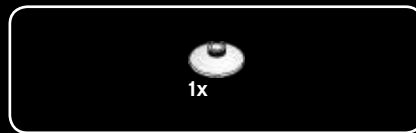
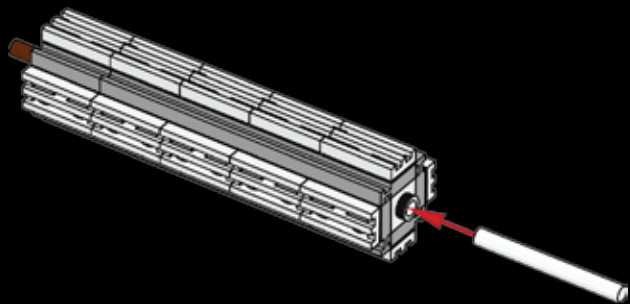

48

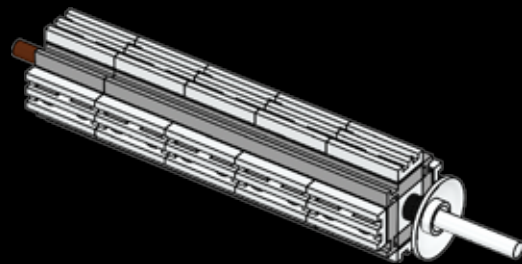

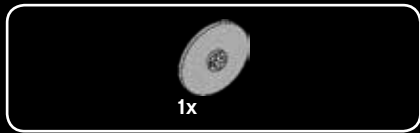

49

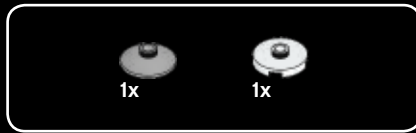
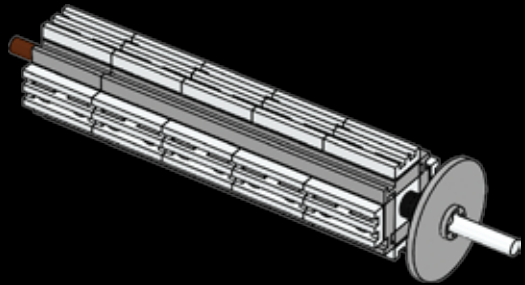

50

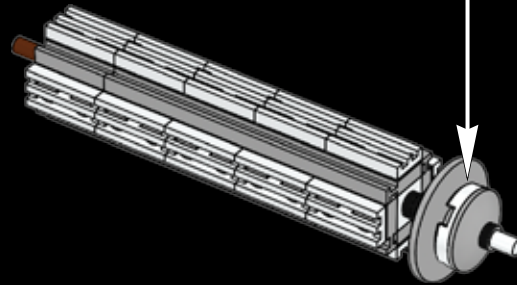

51

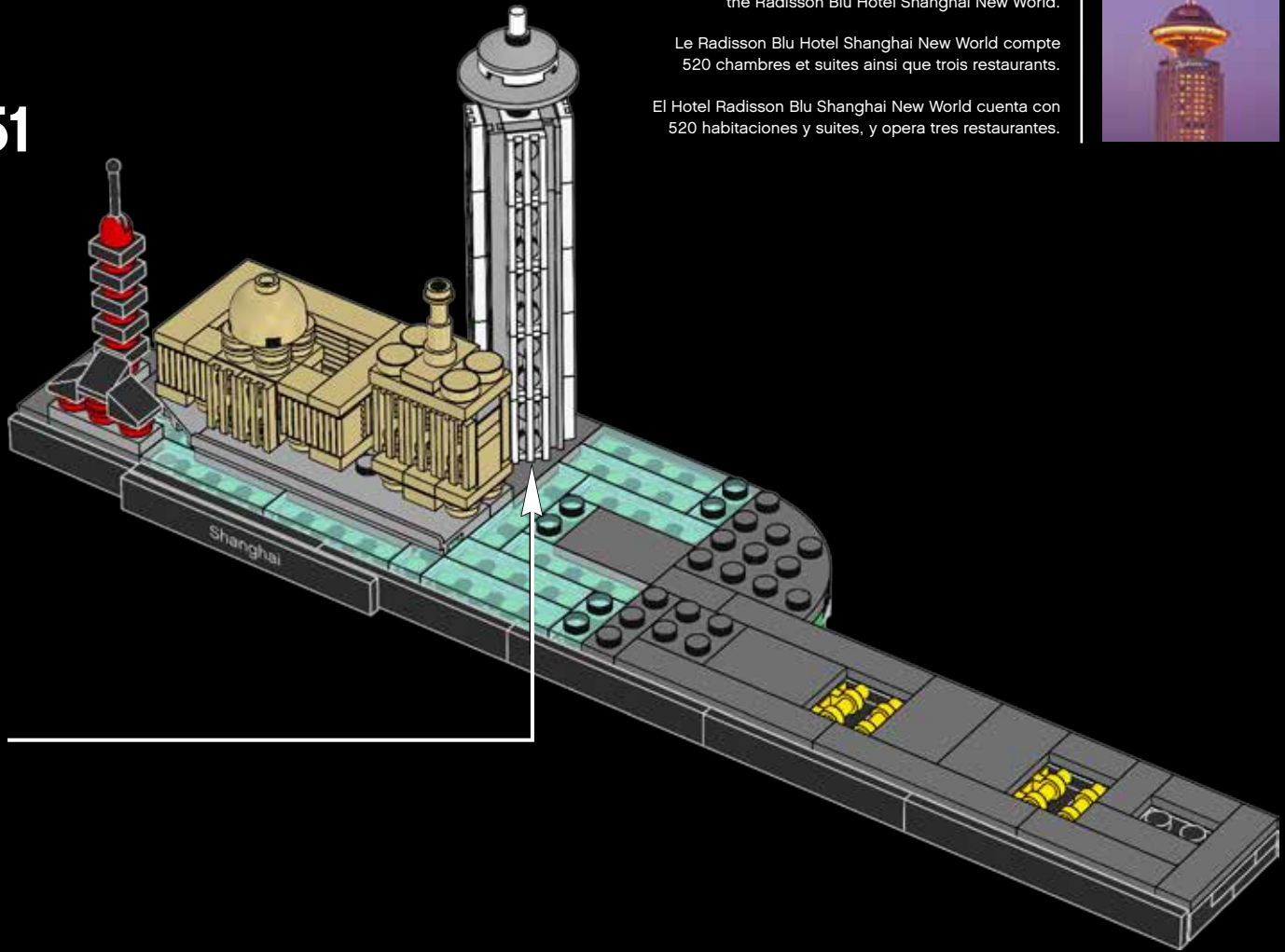

There are 520 rooms and suites, plus three restaurants in the Radisson Blu Hotel Shanghai New World.

Le Radisson Blu Hotel Shanghai New World compte 520 chambres et suites ainsi que trois restaurants.

El Hotel Radisson Blu Shanghai New World cuenta con 520 habitaciones y suites, y opera tres restaurantes.





4x

52

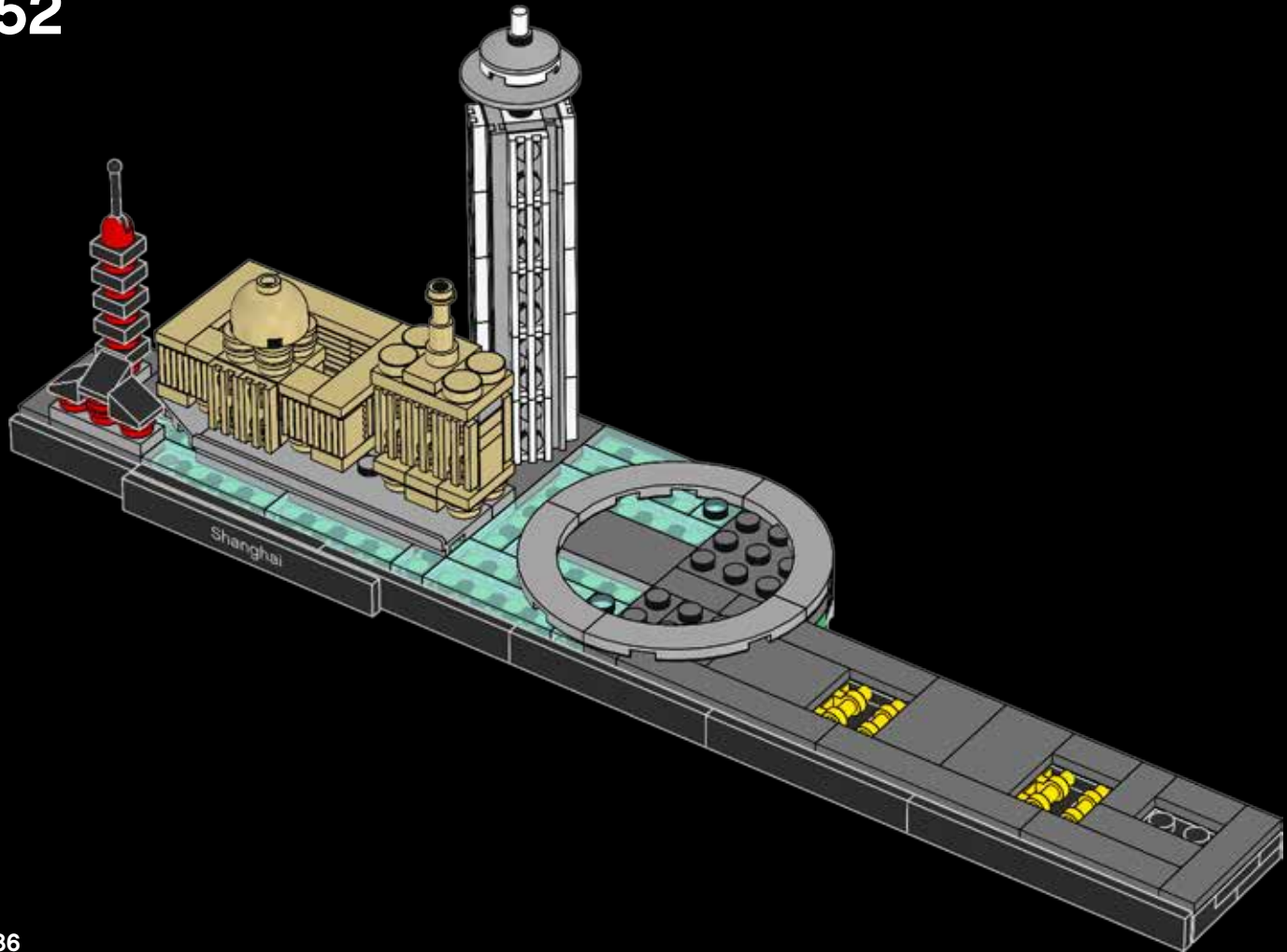

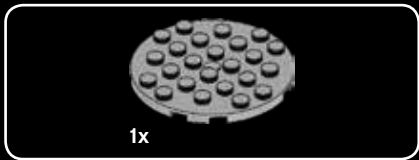

53

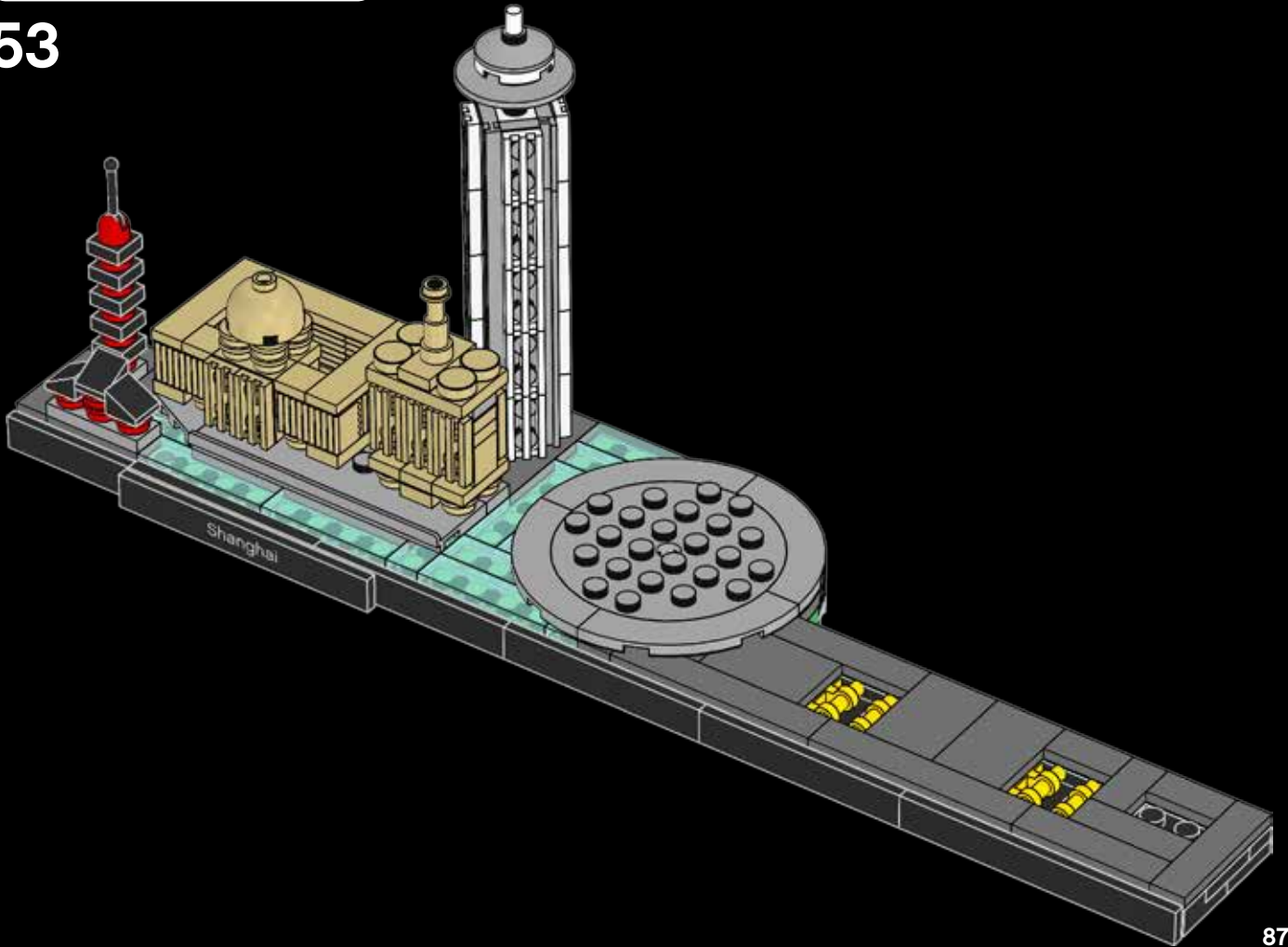



54

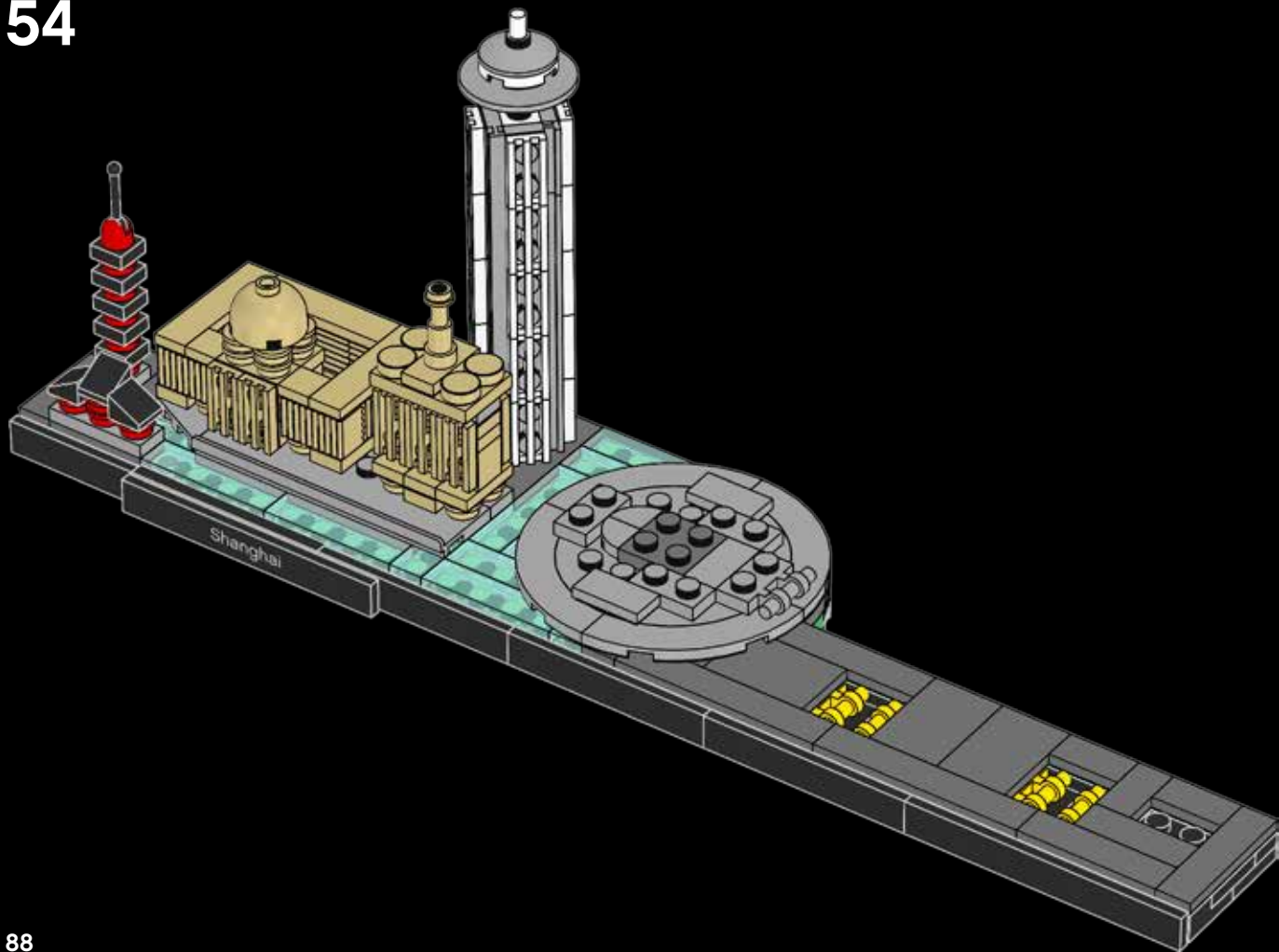



55

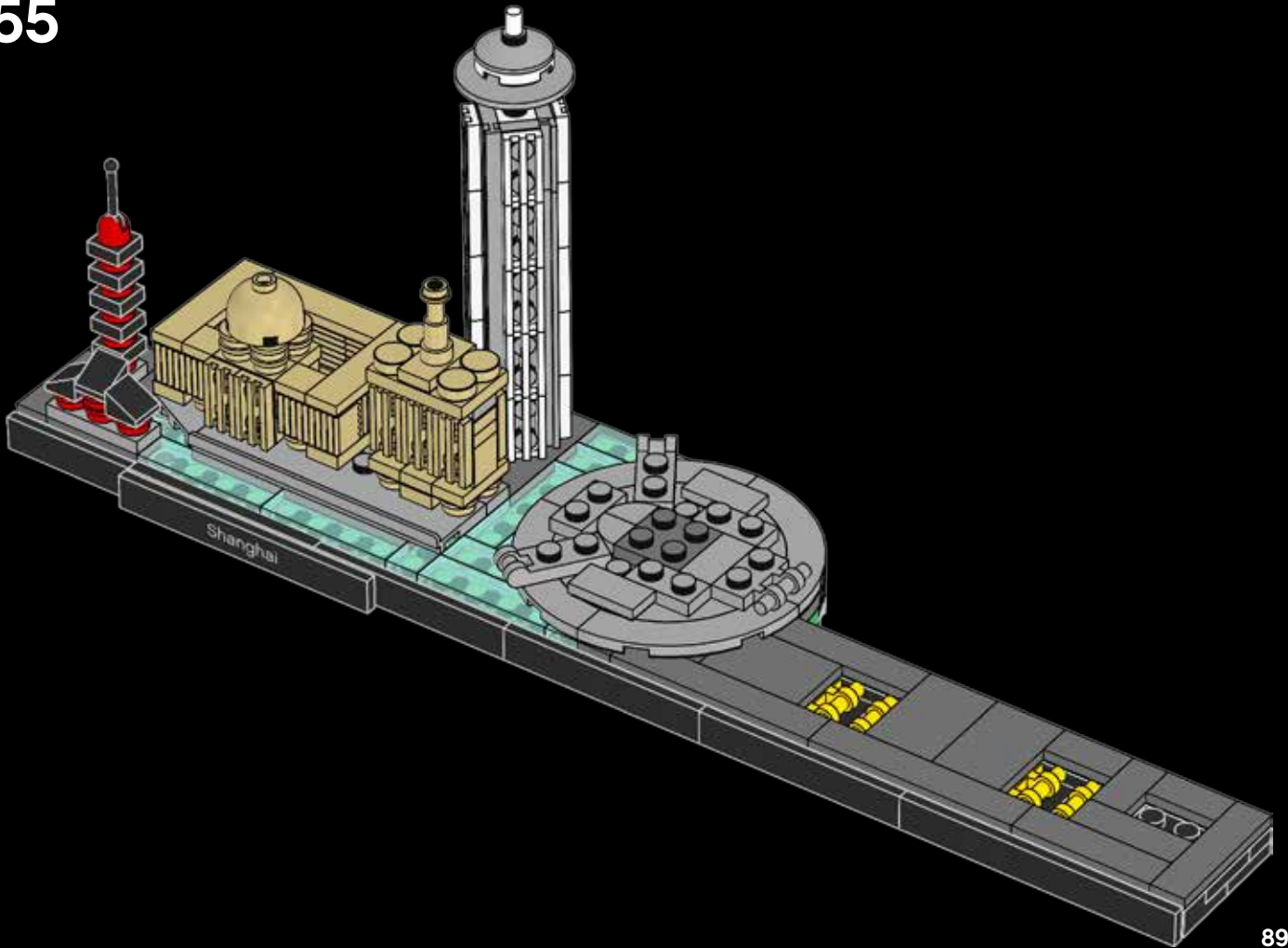



56

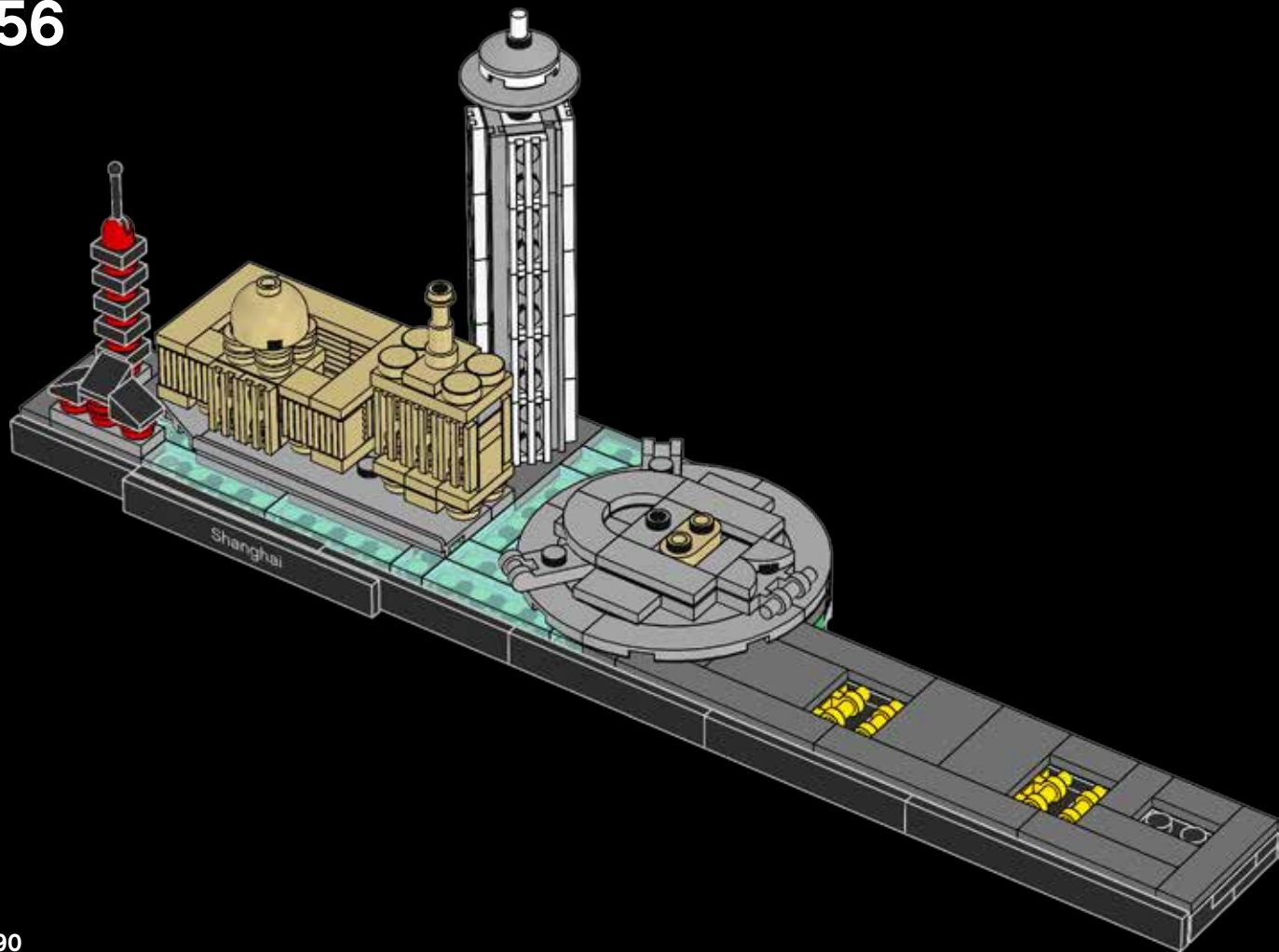



57

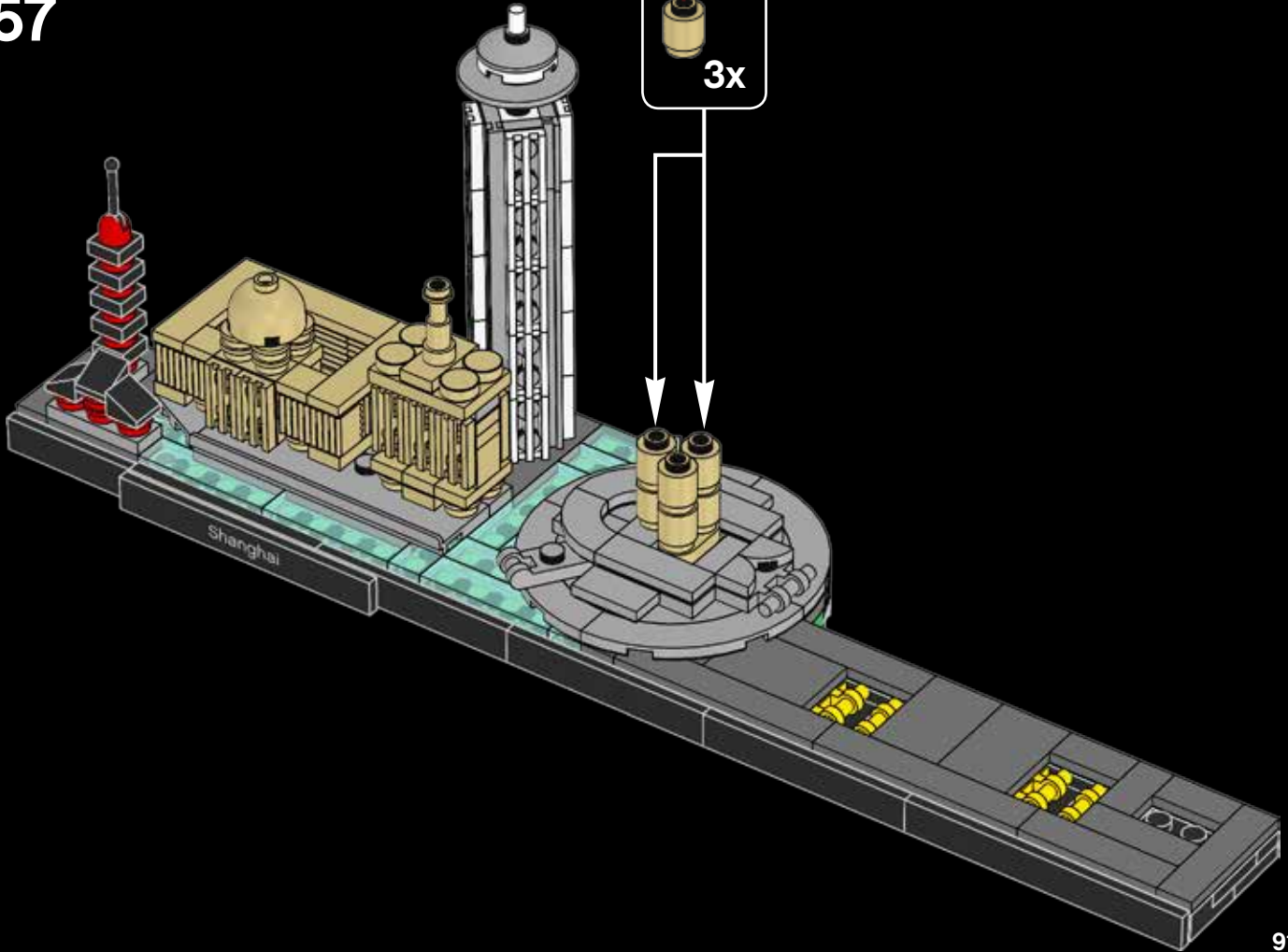
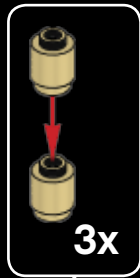



58

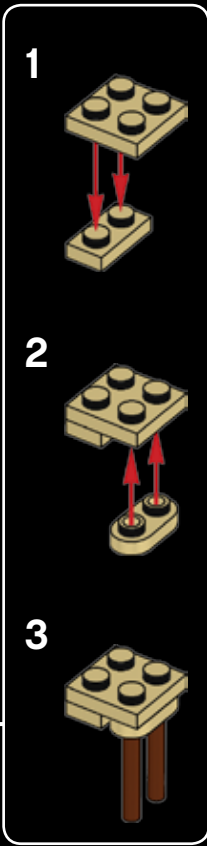
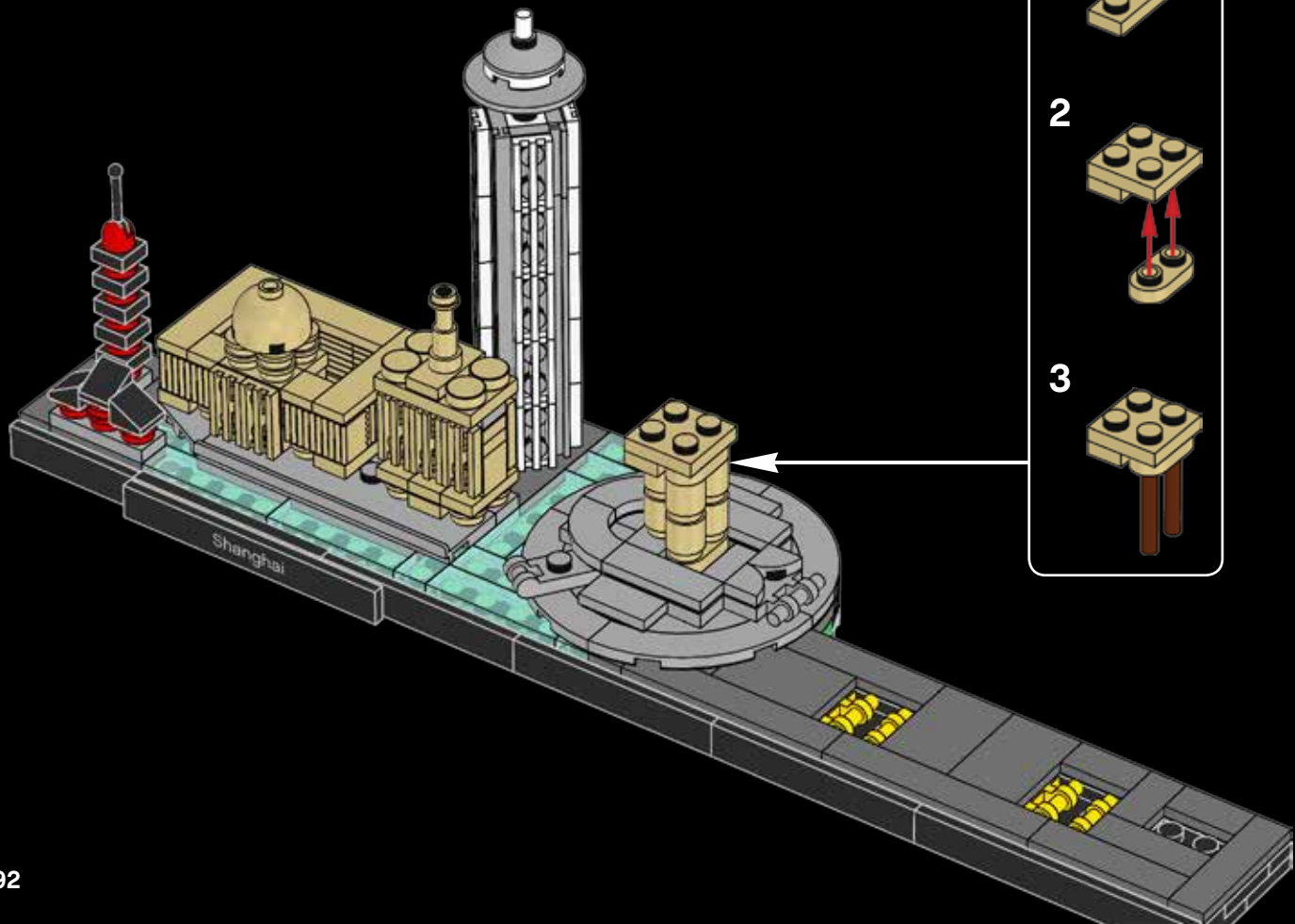



59

The Tower contains a revolving restaurant, an exhibition center and a small 20-room hotel.

La tour contient un restaurant tournant, un centre d'exposition et un petit hôtel de 20 chambres.

La torre contiene un restaurante giratorio, un centro de exposiciones y un pequeño hotel de 20 habitaciones.



1



2

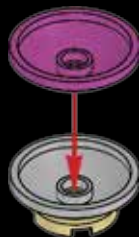

3



4



5

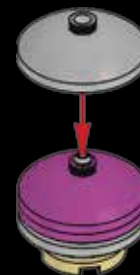

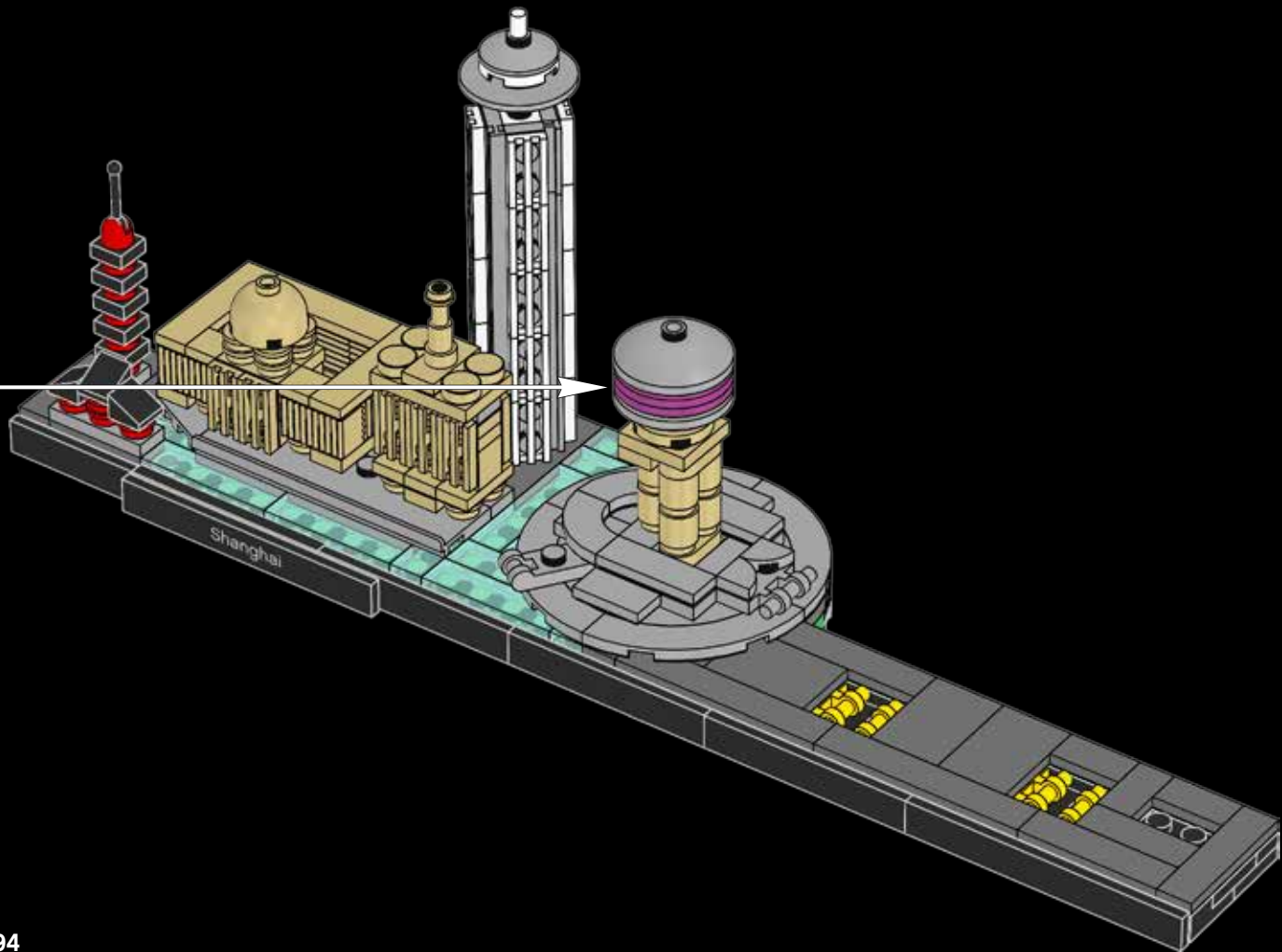



60

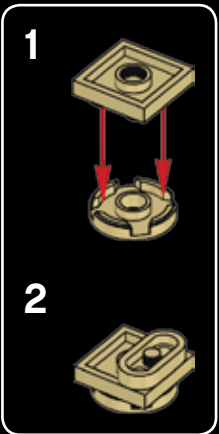
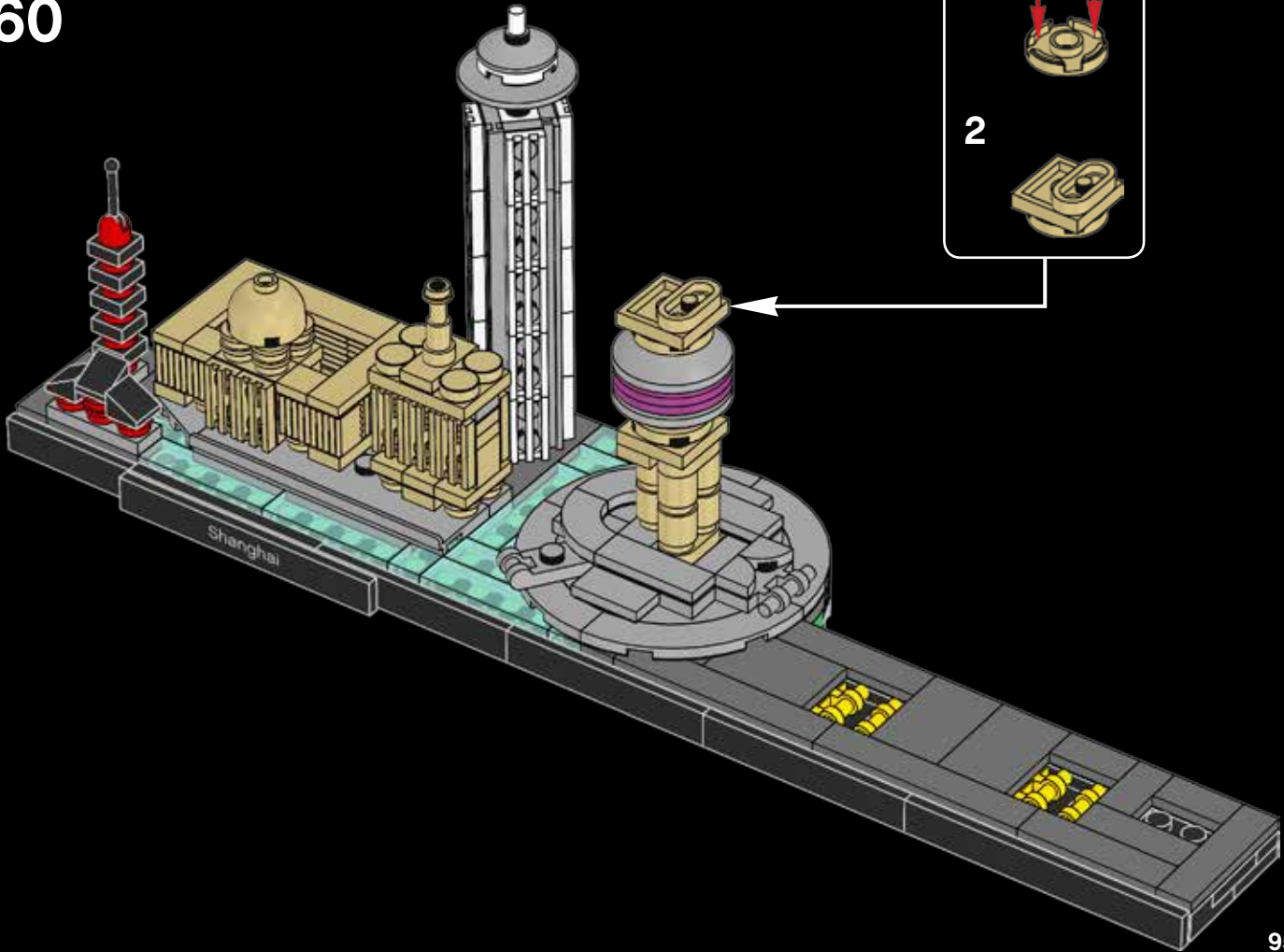



61

1



2



3



4





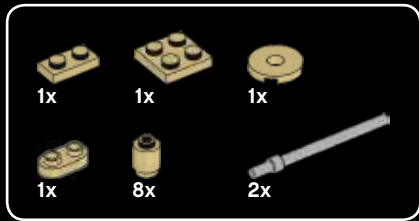

62

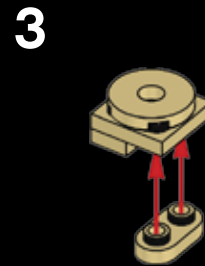
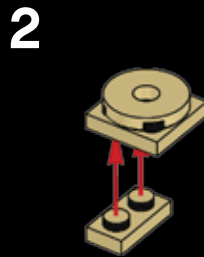
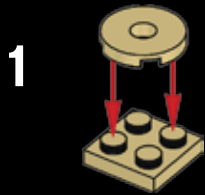

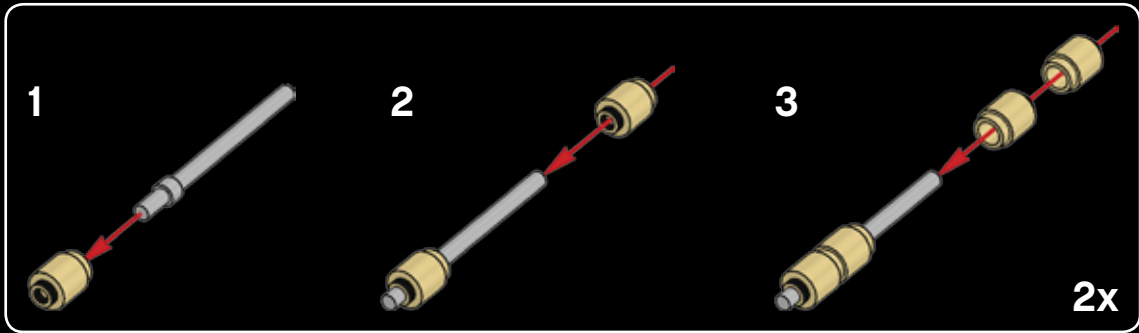

4

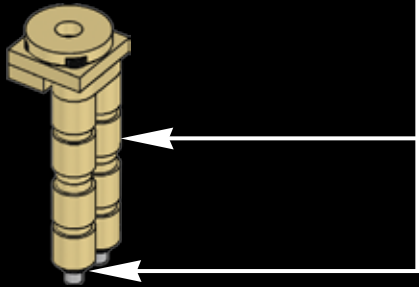

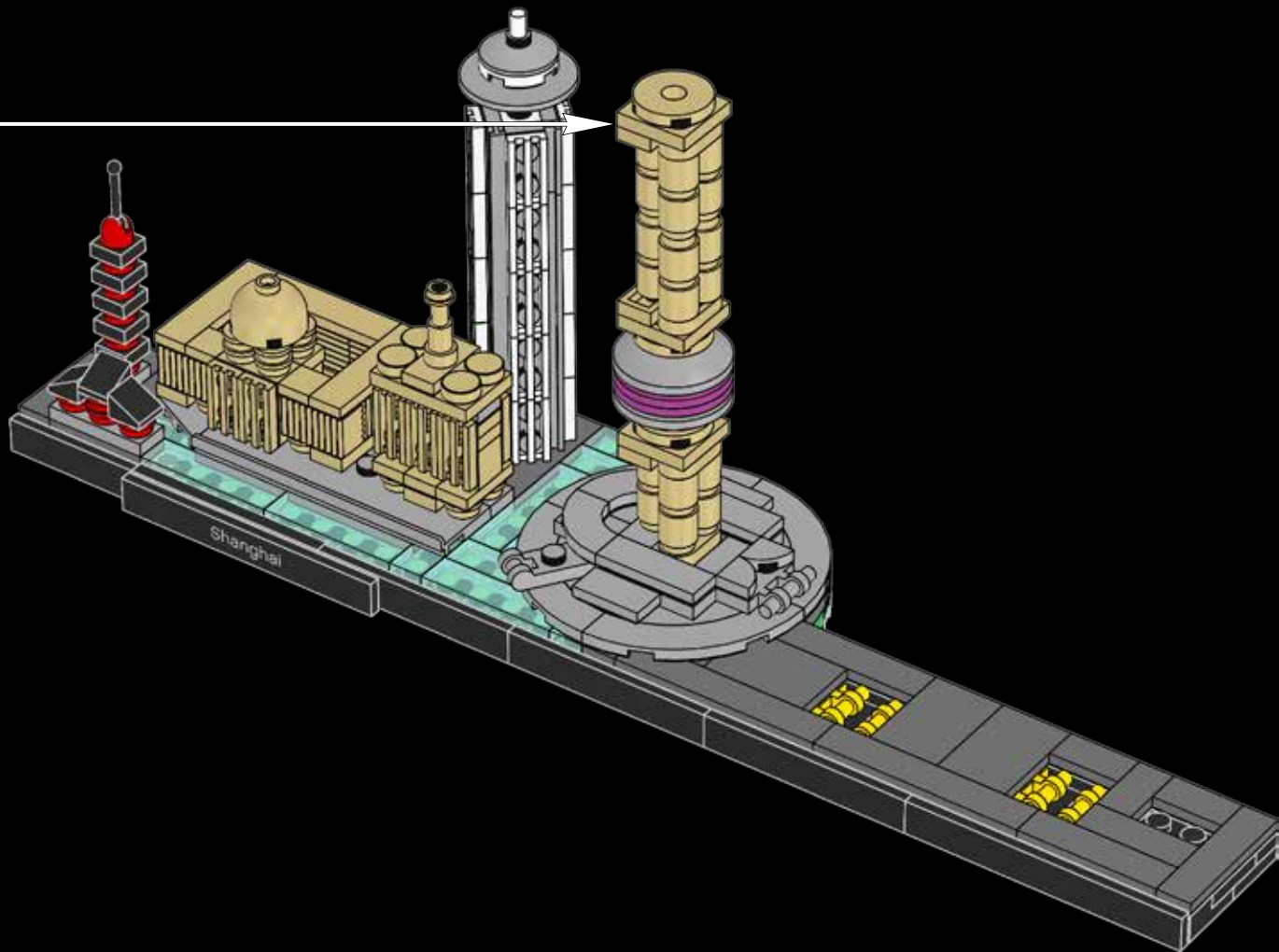

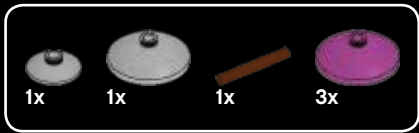

63

1

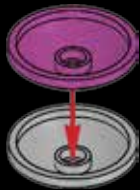

2



3



4



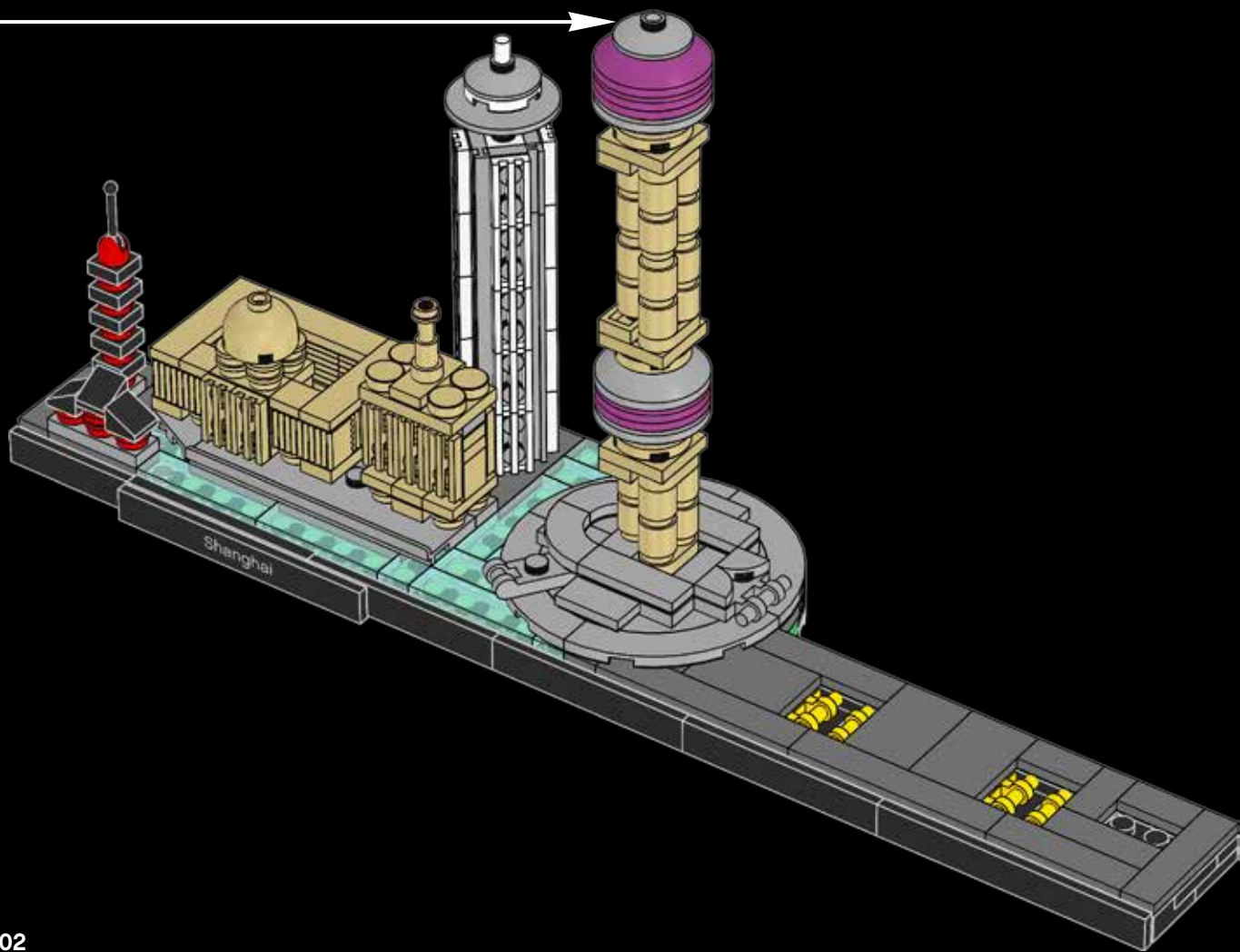



64

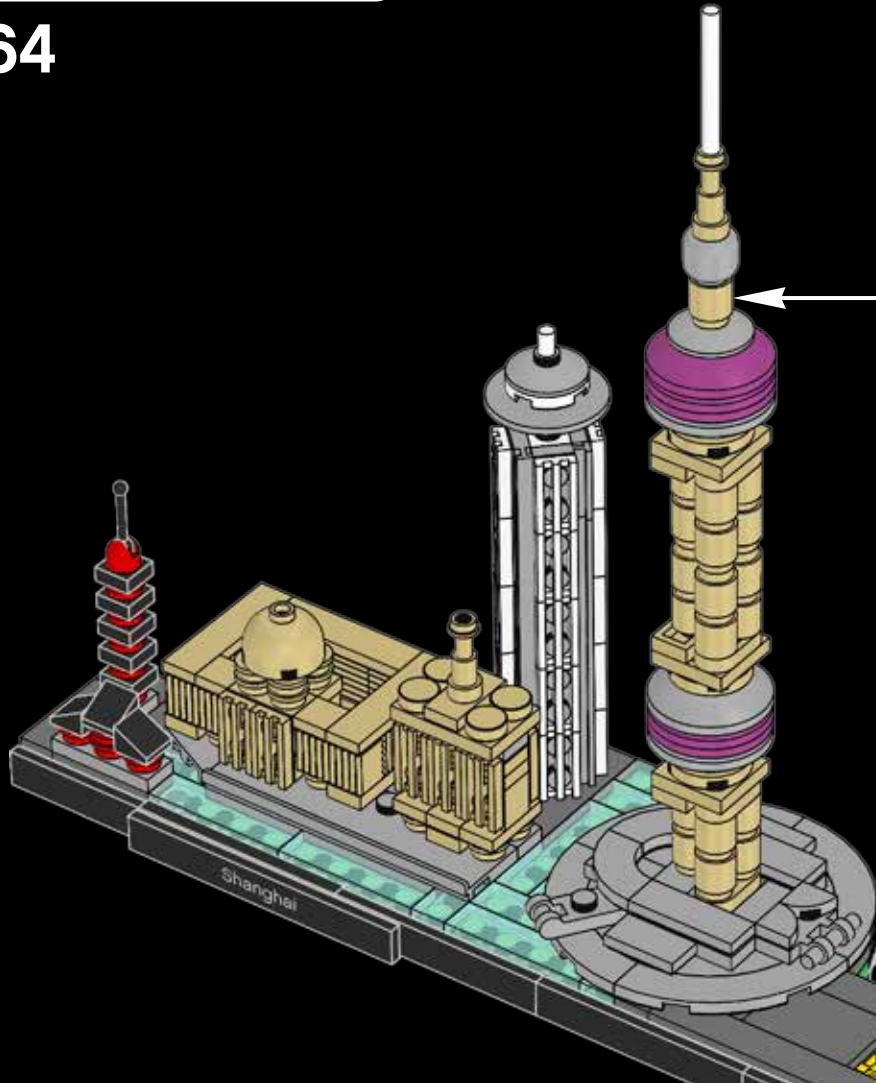
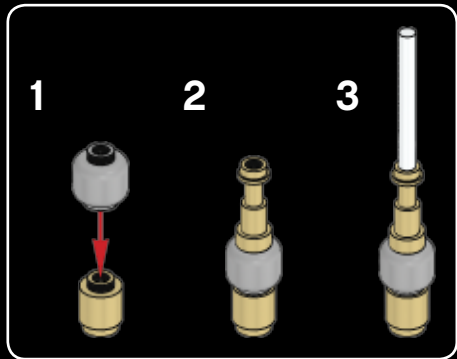

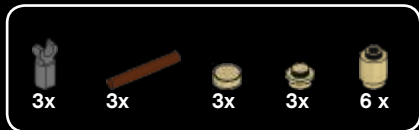

65



1

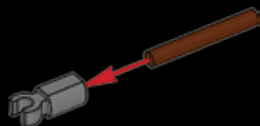

2

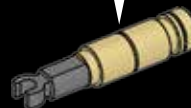

3x

The Oriental Pearl Tower was the tallest structure in China until 2007.

La tour de la perle de l'Orient a été la structure la plus haute de la Chine jusqu'en 2007.

La Torre de la Perla Oriental fue la estructura más alta de China hasta 2007.

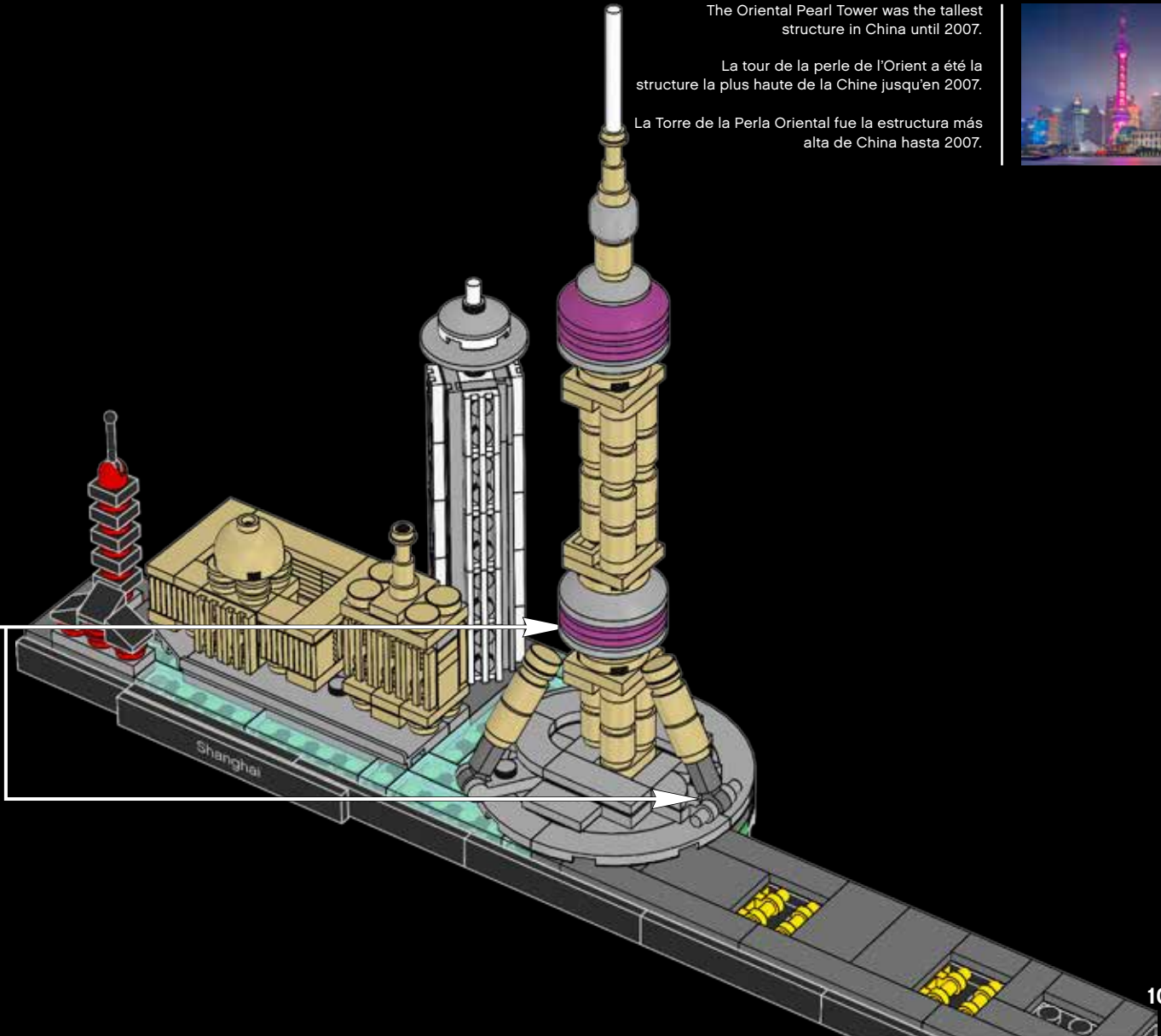

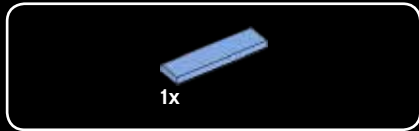
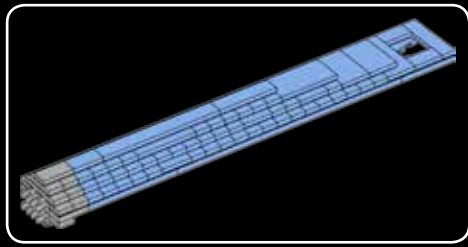

66

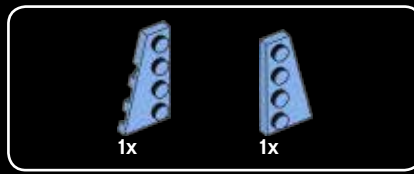
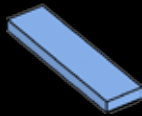

67

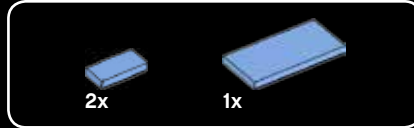
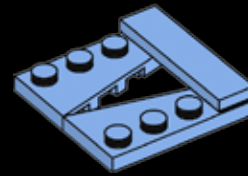

68

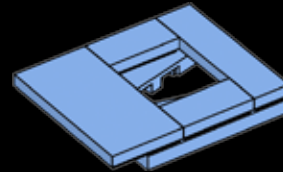

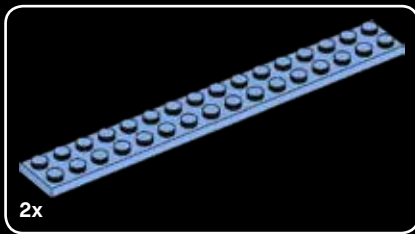

69

The square aperture at the top was originally designed to be circular.

À l'origine, l'ouverture carrée dans le haut devait être circulaire.

La abertura superior cuadrada se diseñó originalmente con forma circular.

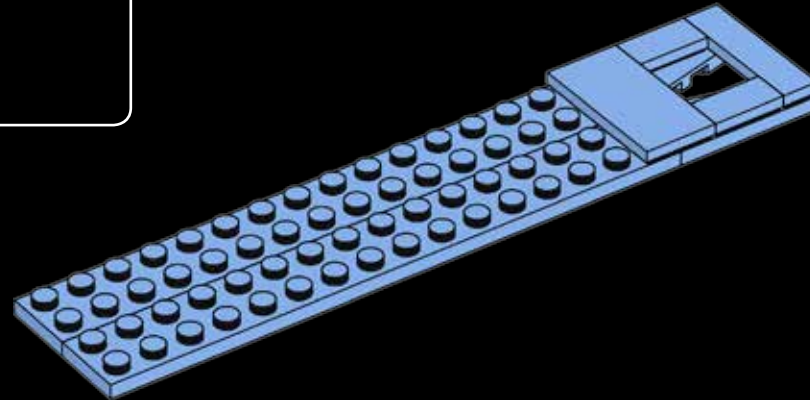

70

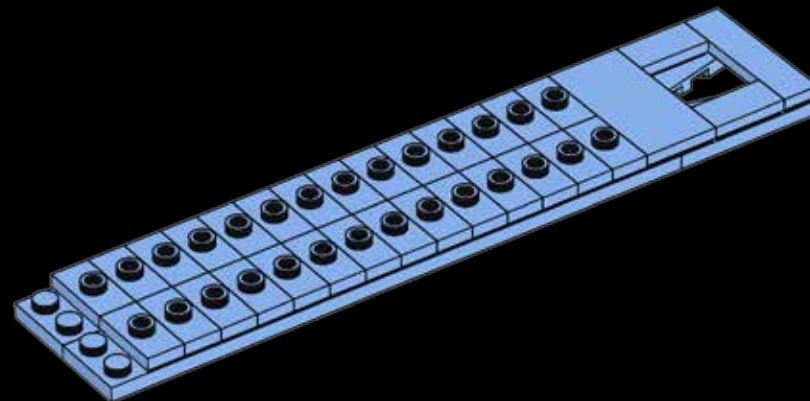



73

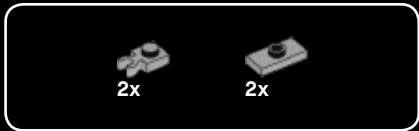
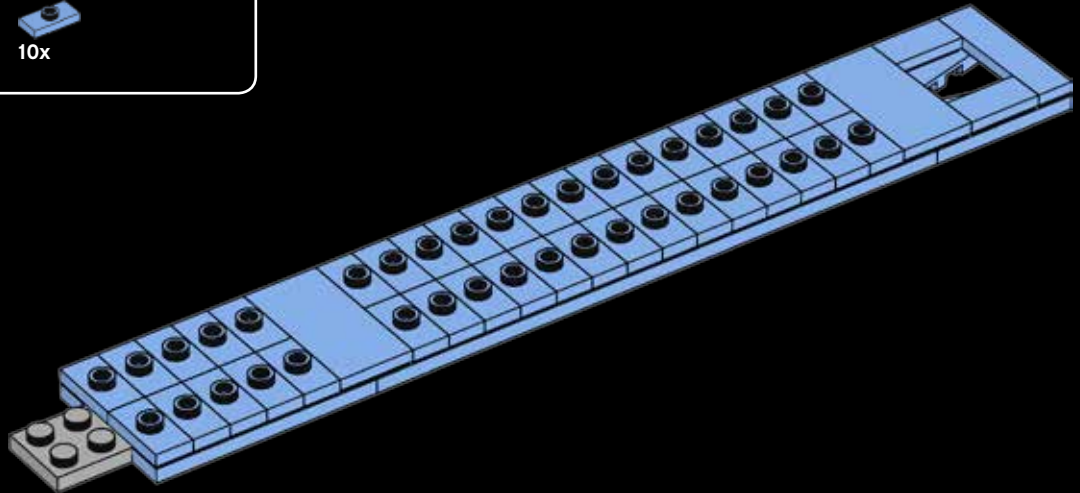

74

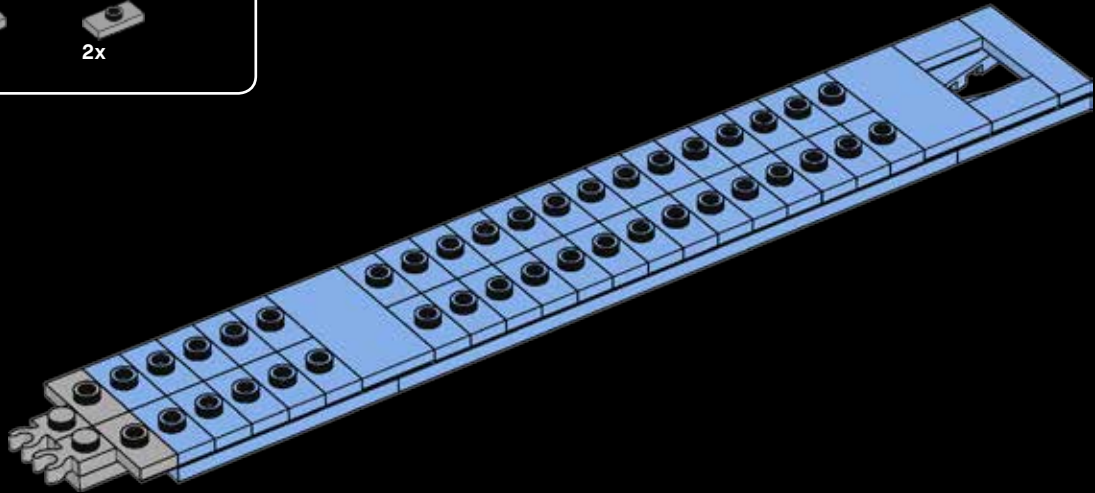



75

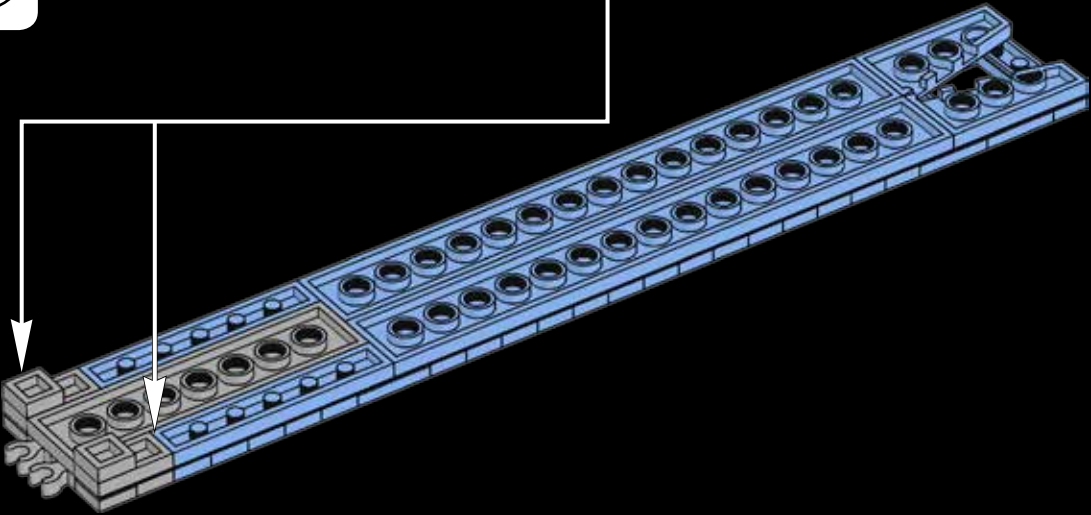
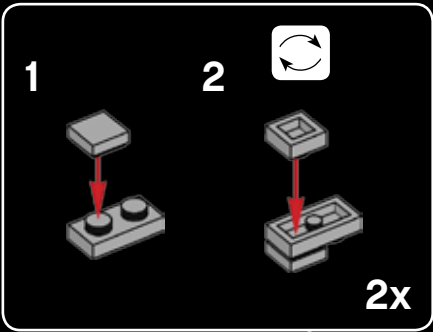



76

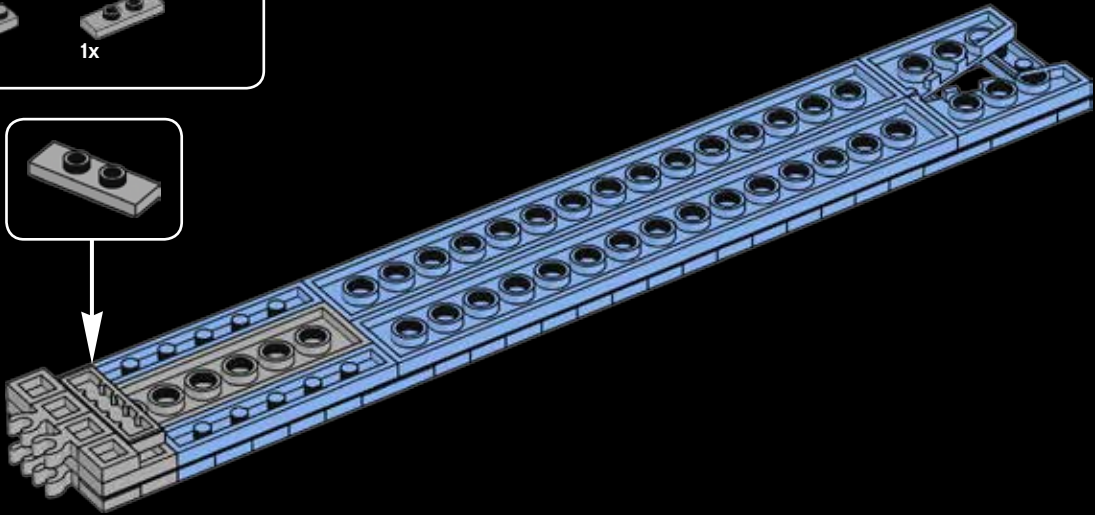

77

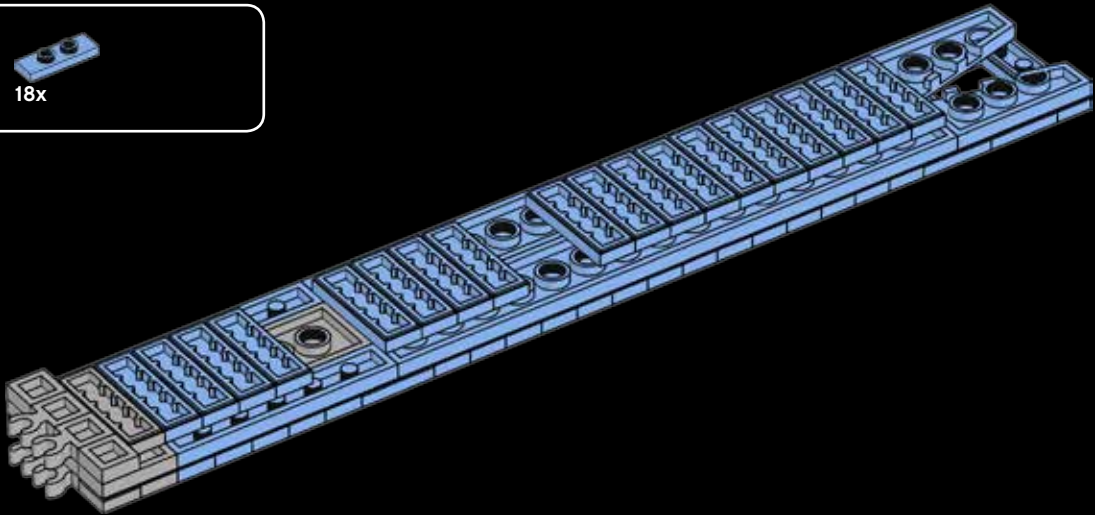



78

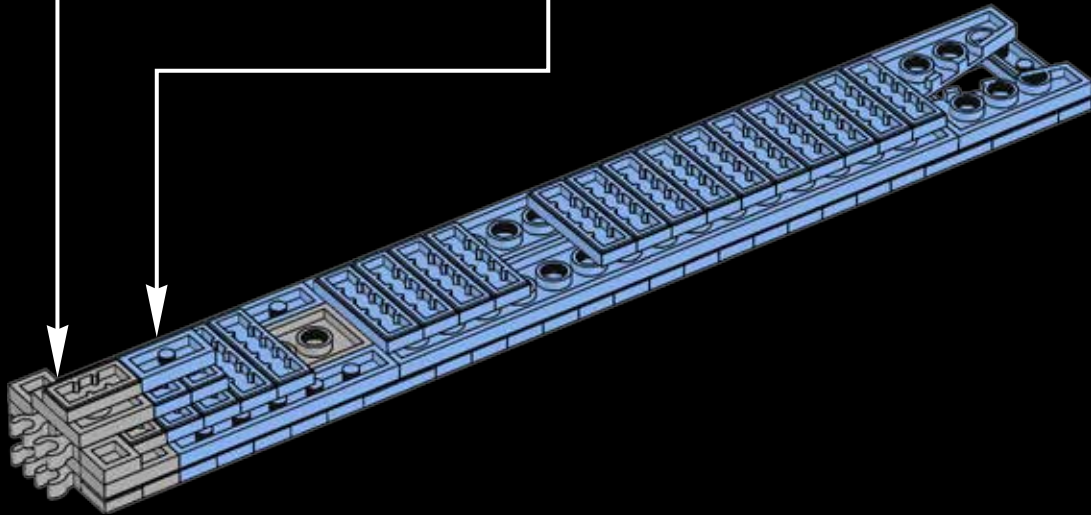
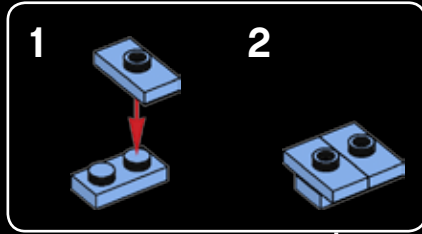
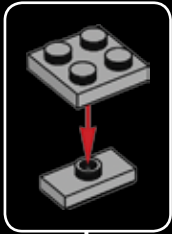



79

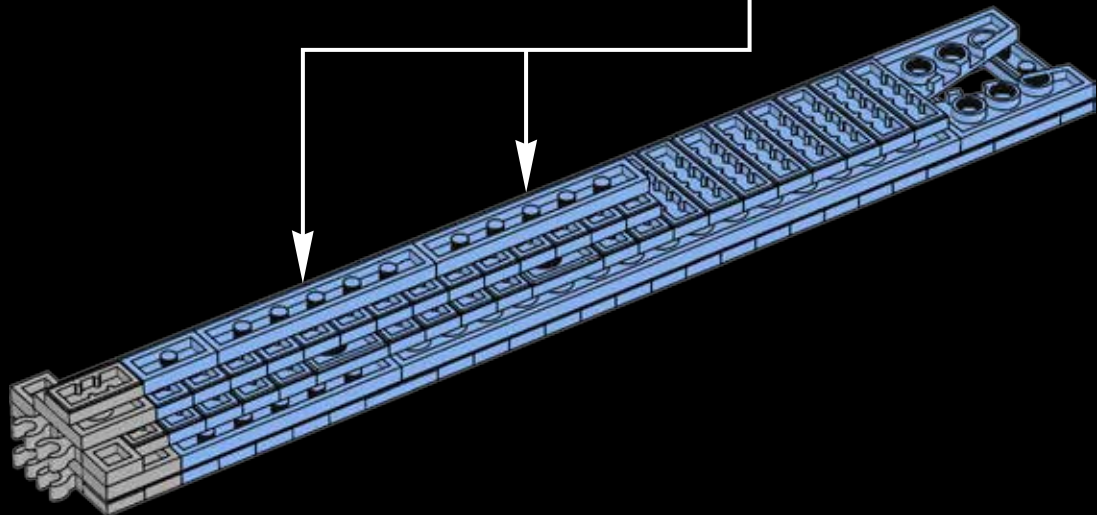
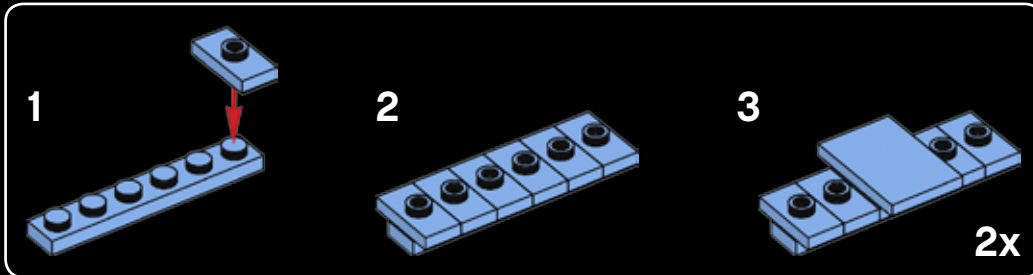



2x

80

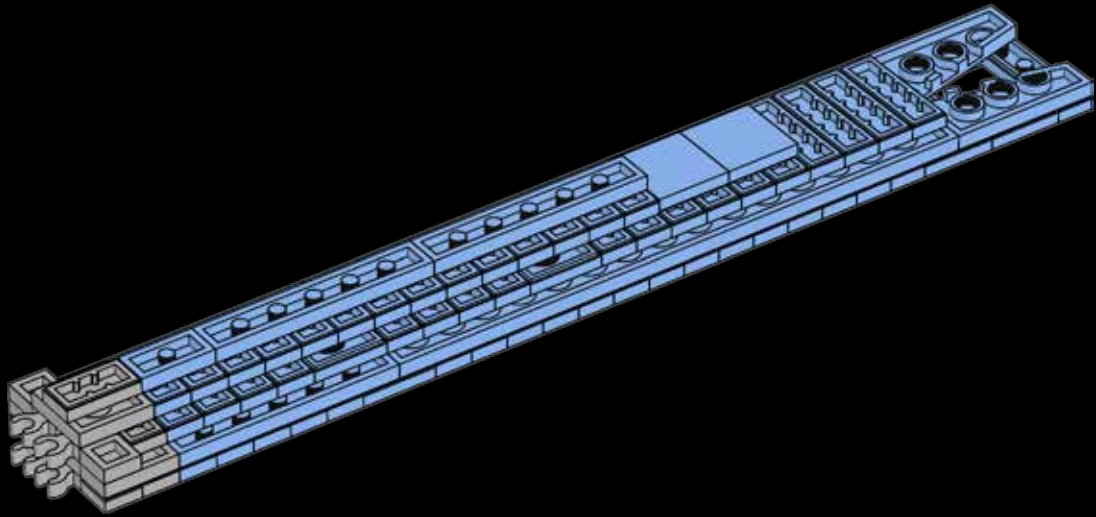



81

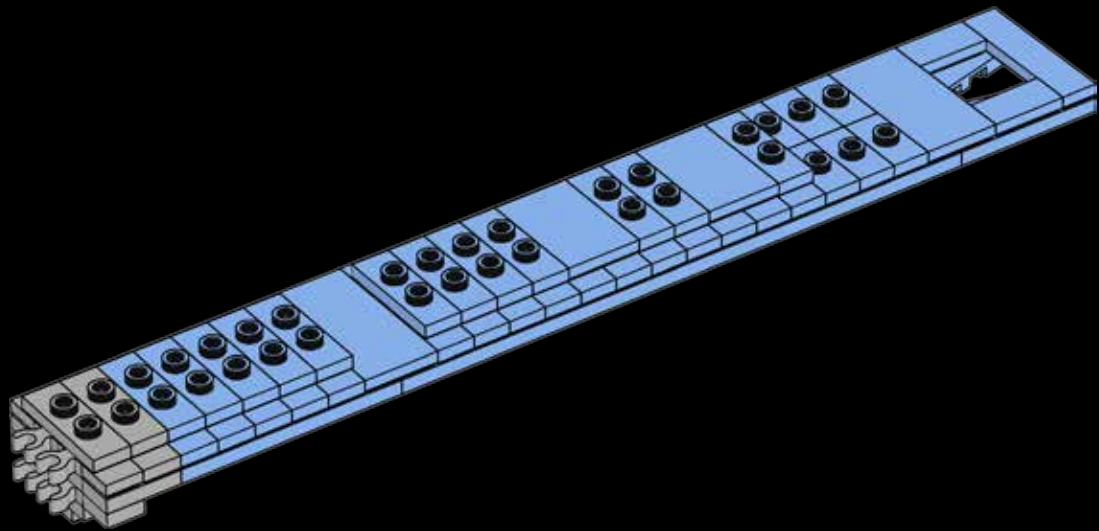
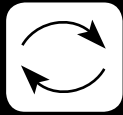

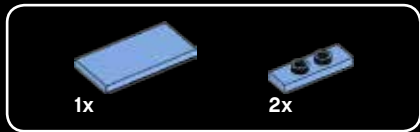

82

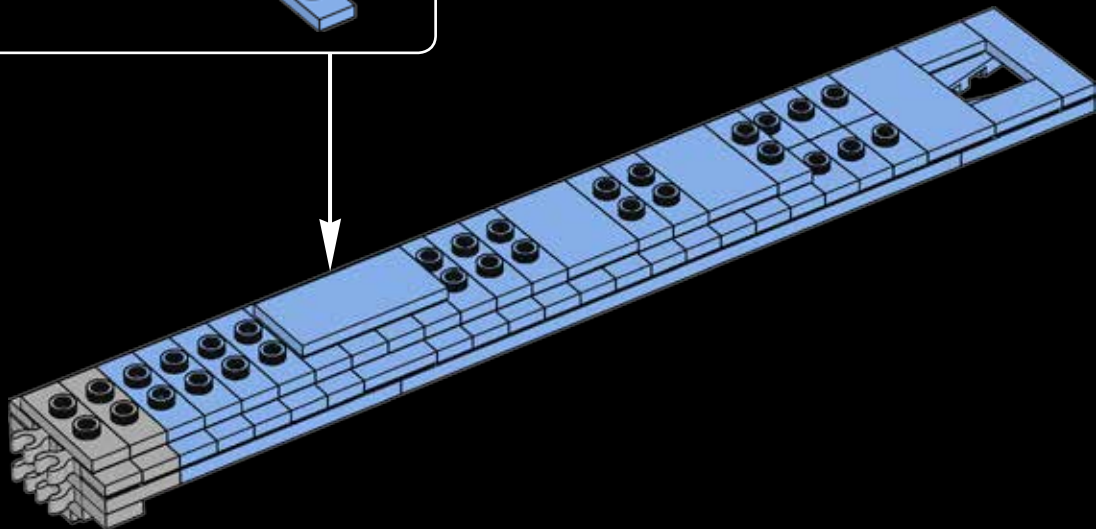
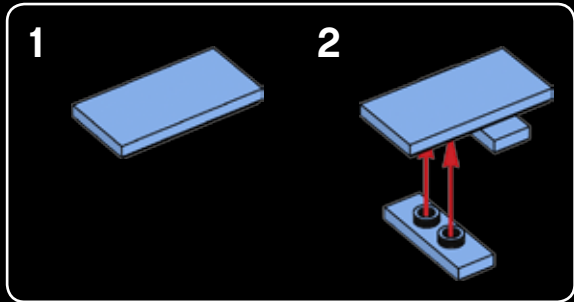

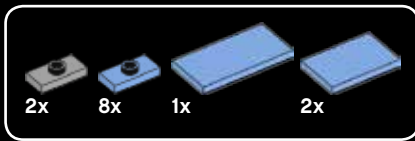

83

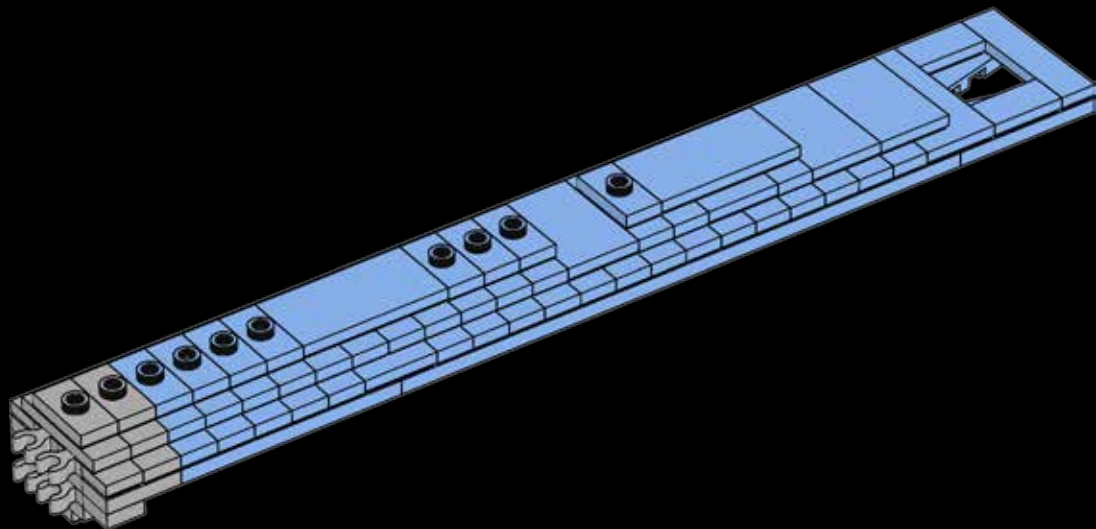

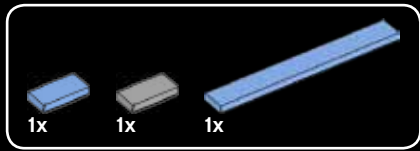

84

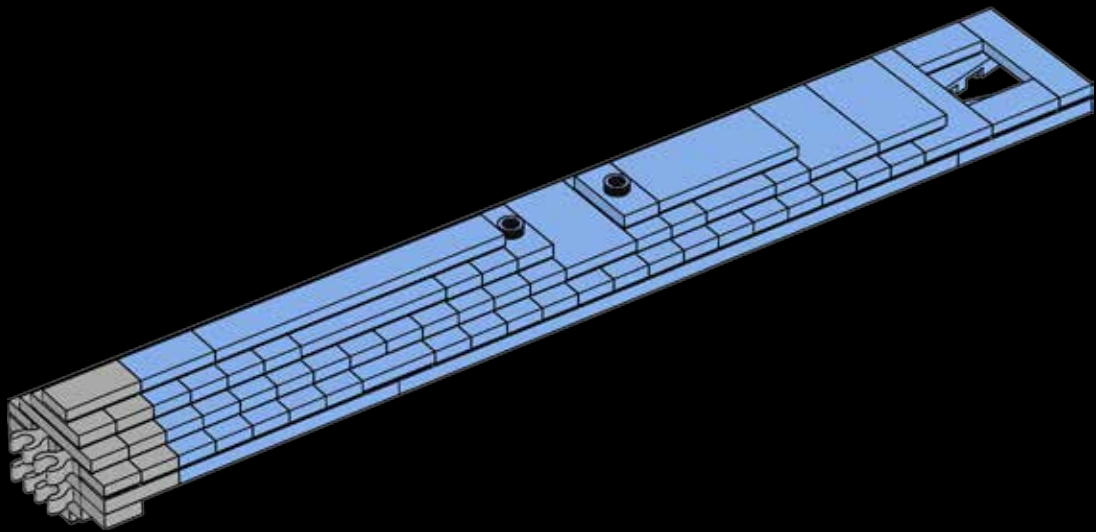

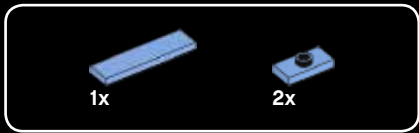

85

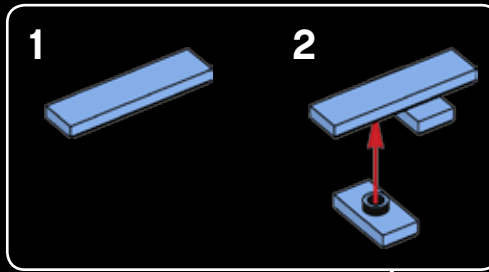

The building was designed in a modular system that repeats itself after every 13 floors.

Le bâtiment a été conçu comme un système modulaire qui se répète tous les 13 étages.

El edificio se construyó empleando secciones modulares que se repiten cada 13 pisos.

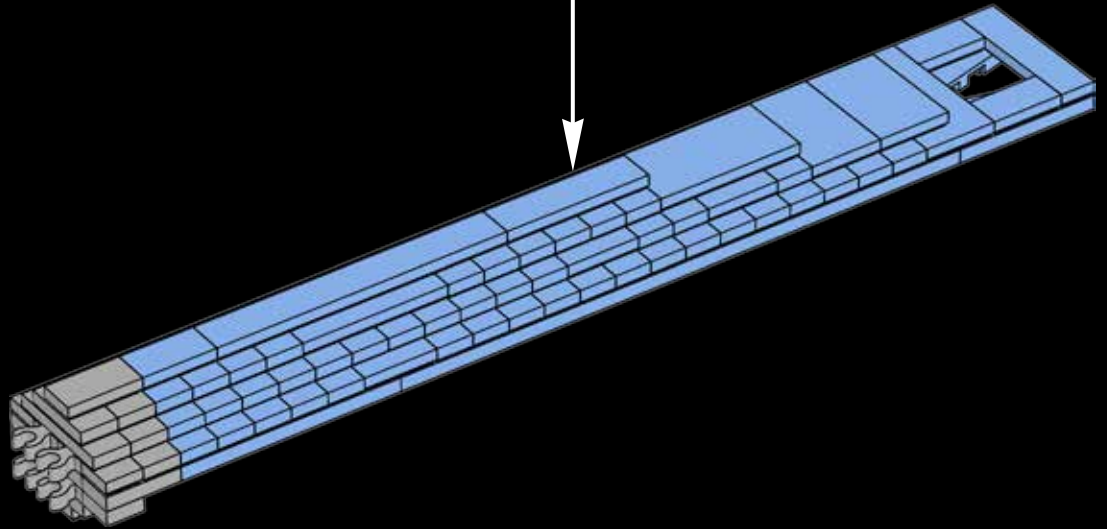

86

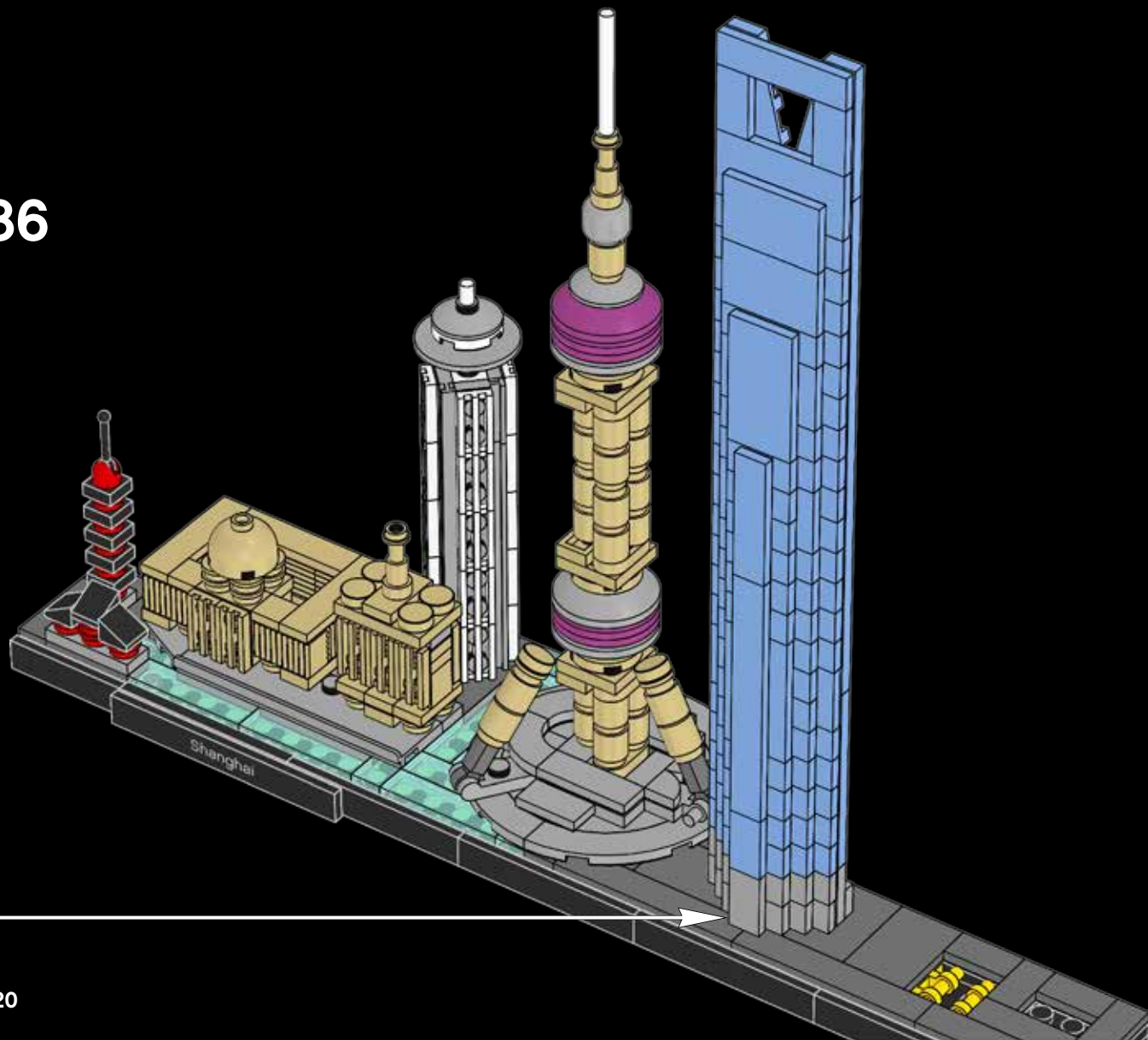

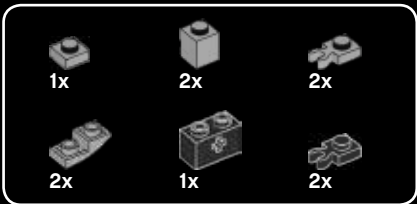

87

1



2



3

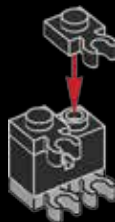

4

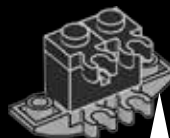

5

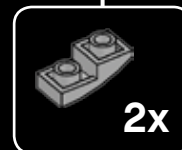
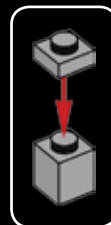
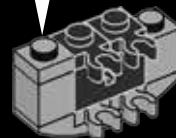

2x

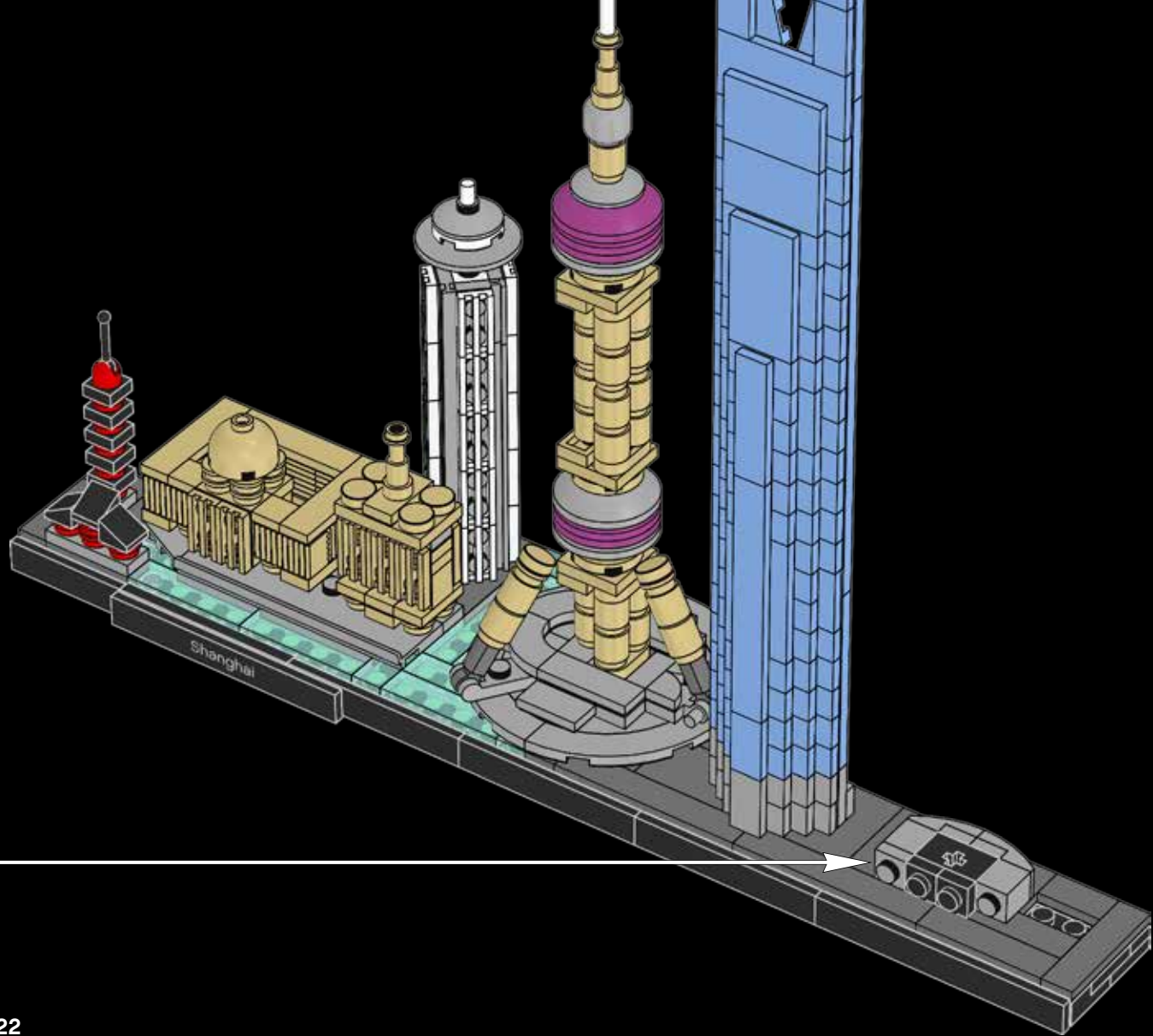

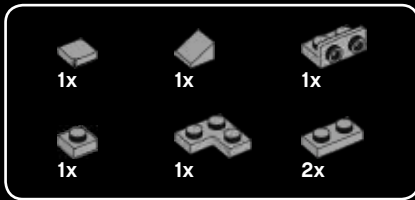

88

1

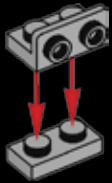

2

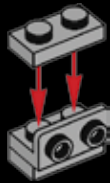

3



4



5



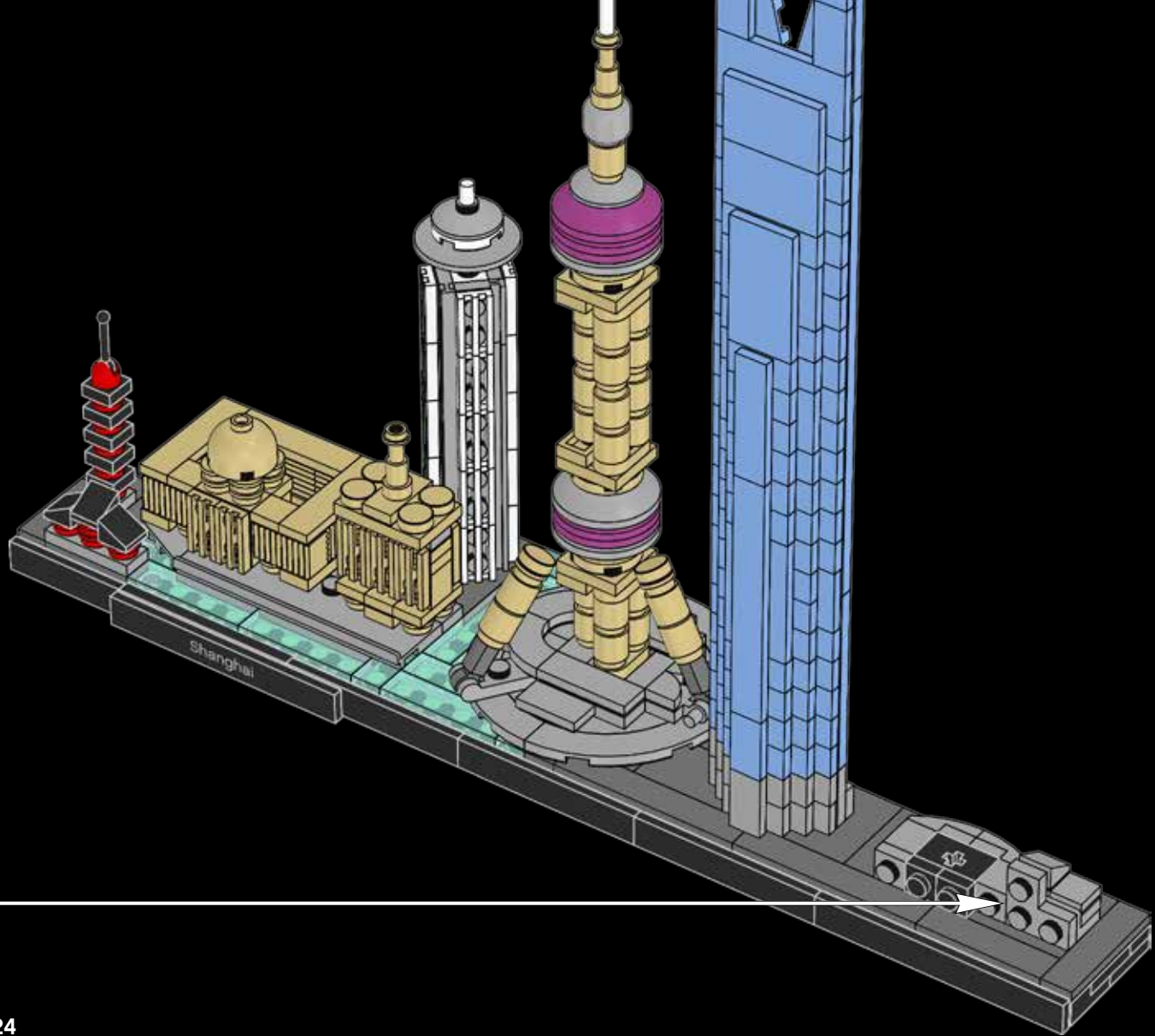

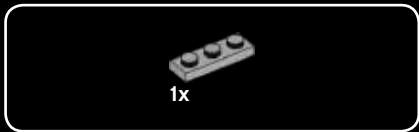

89

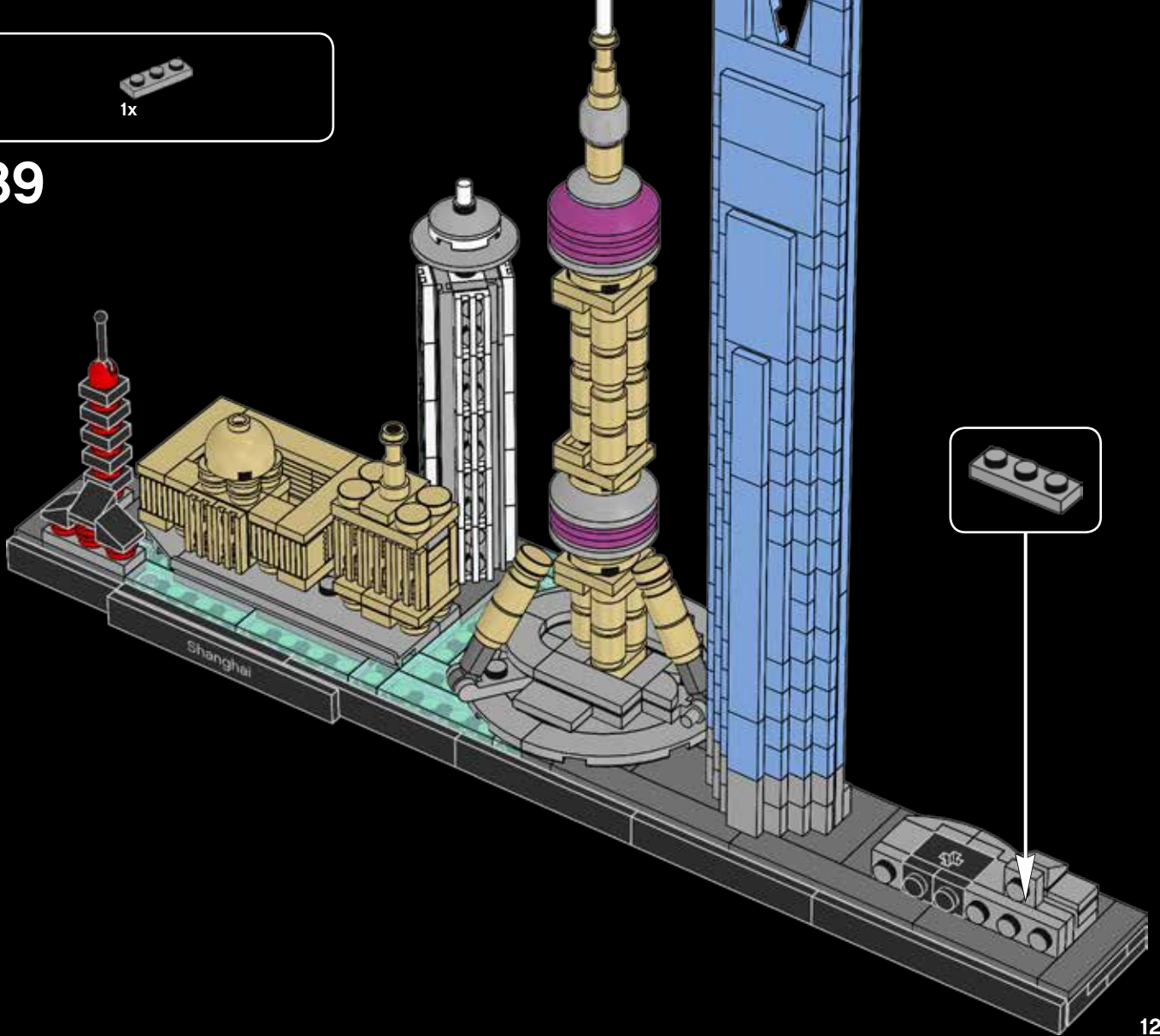

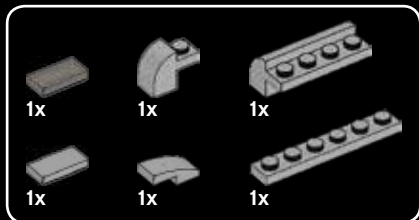

90

1

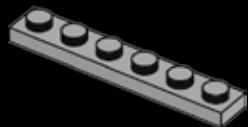

2

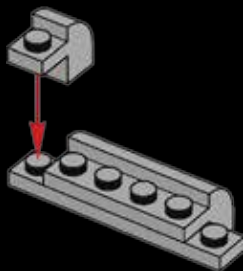

3

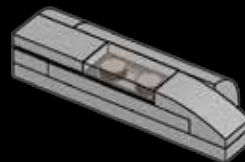

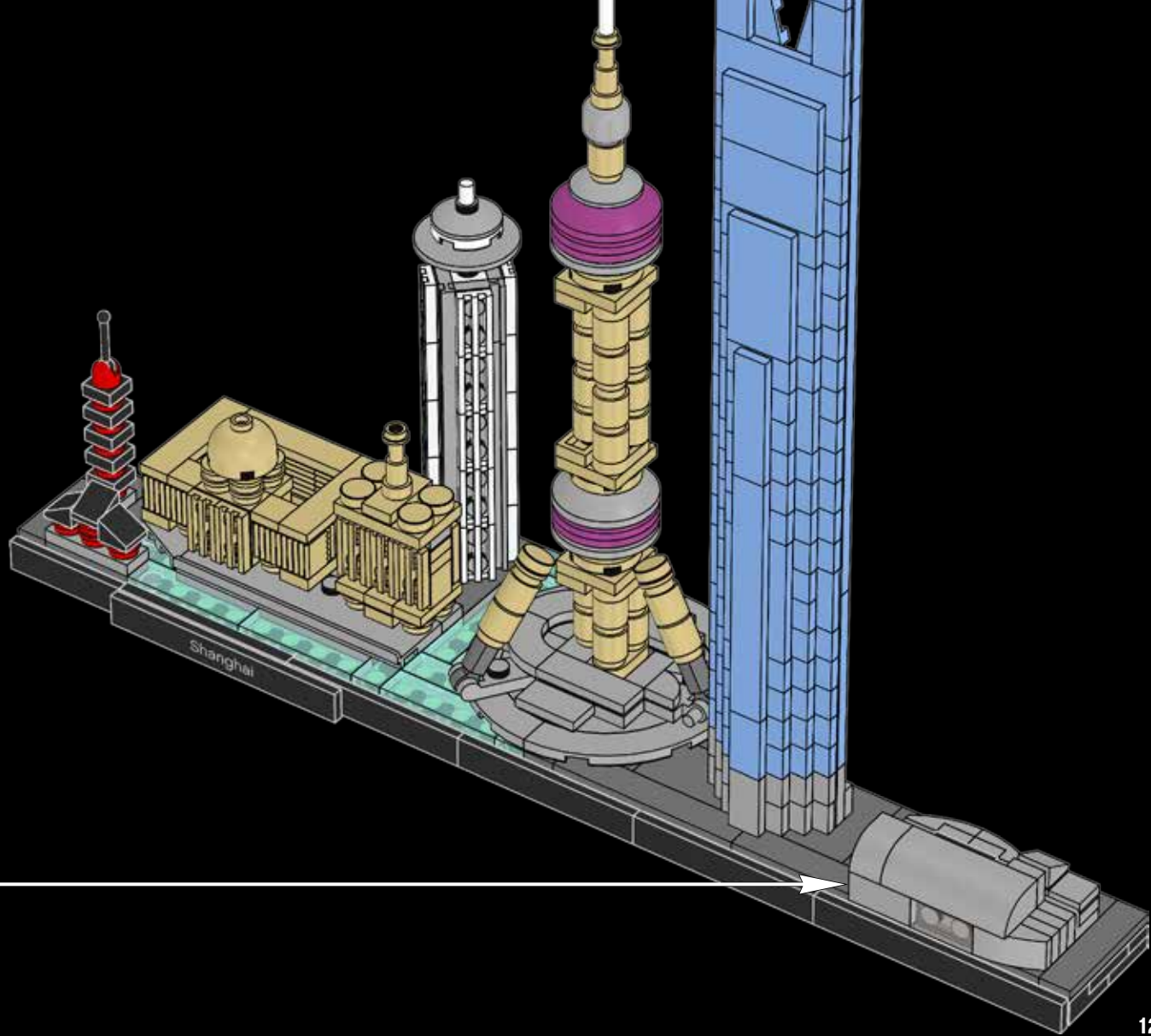

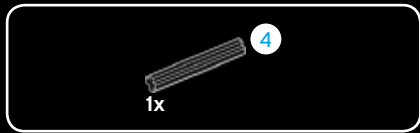

91

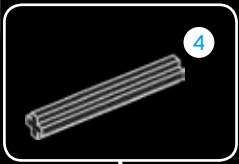
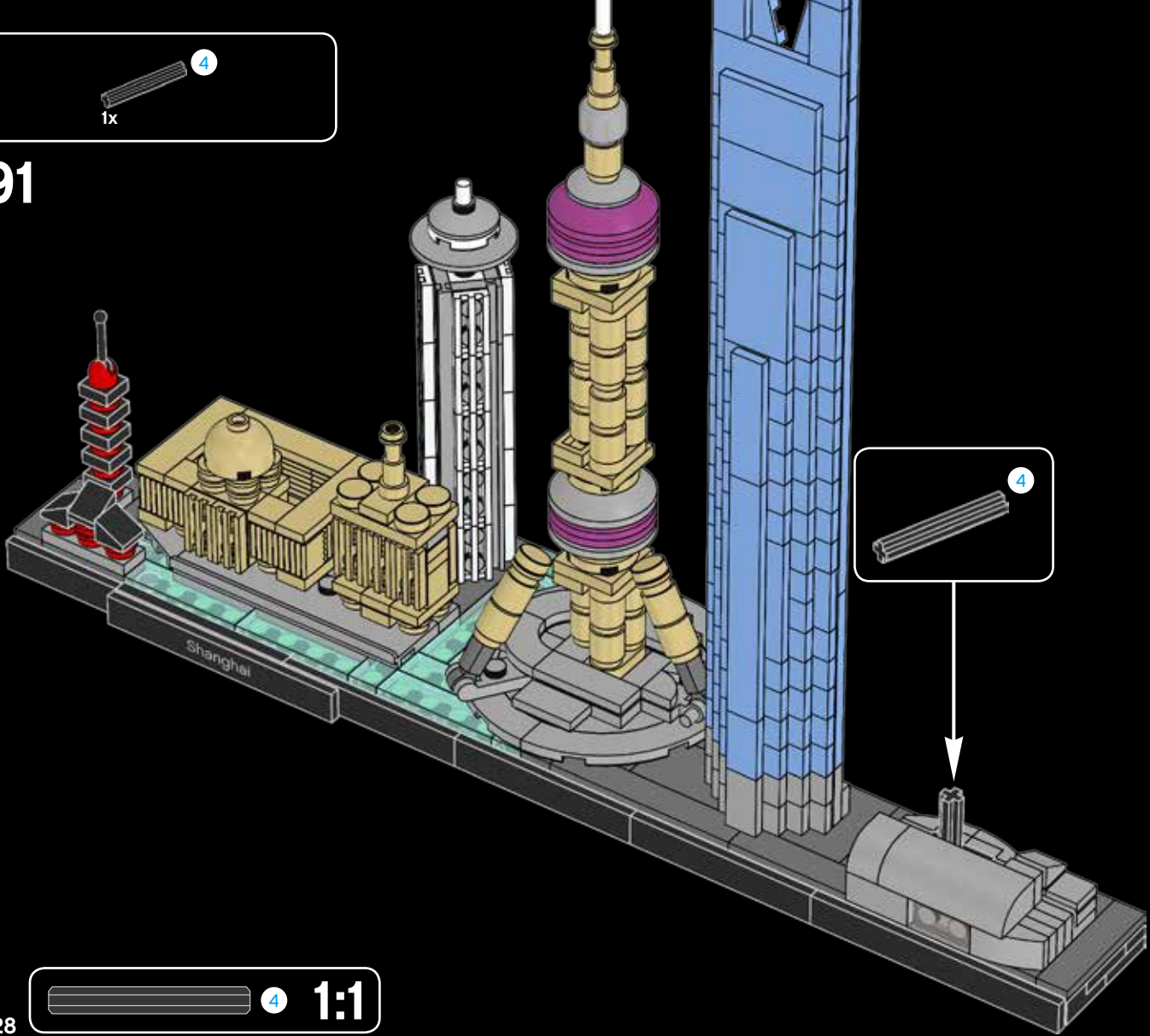



92

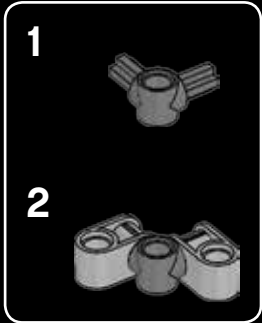
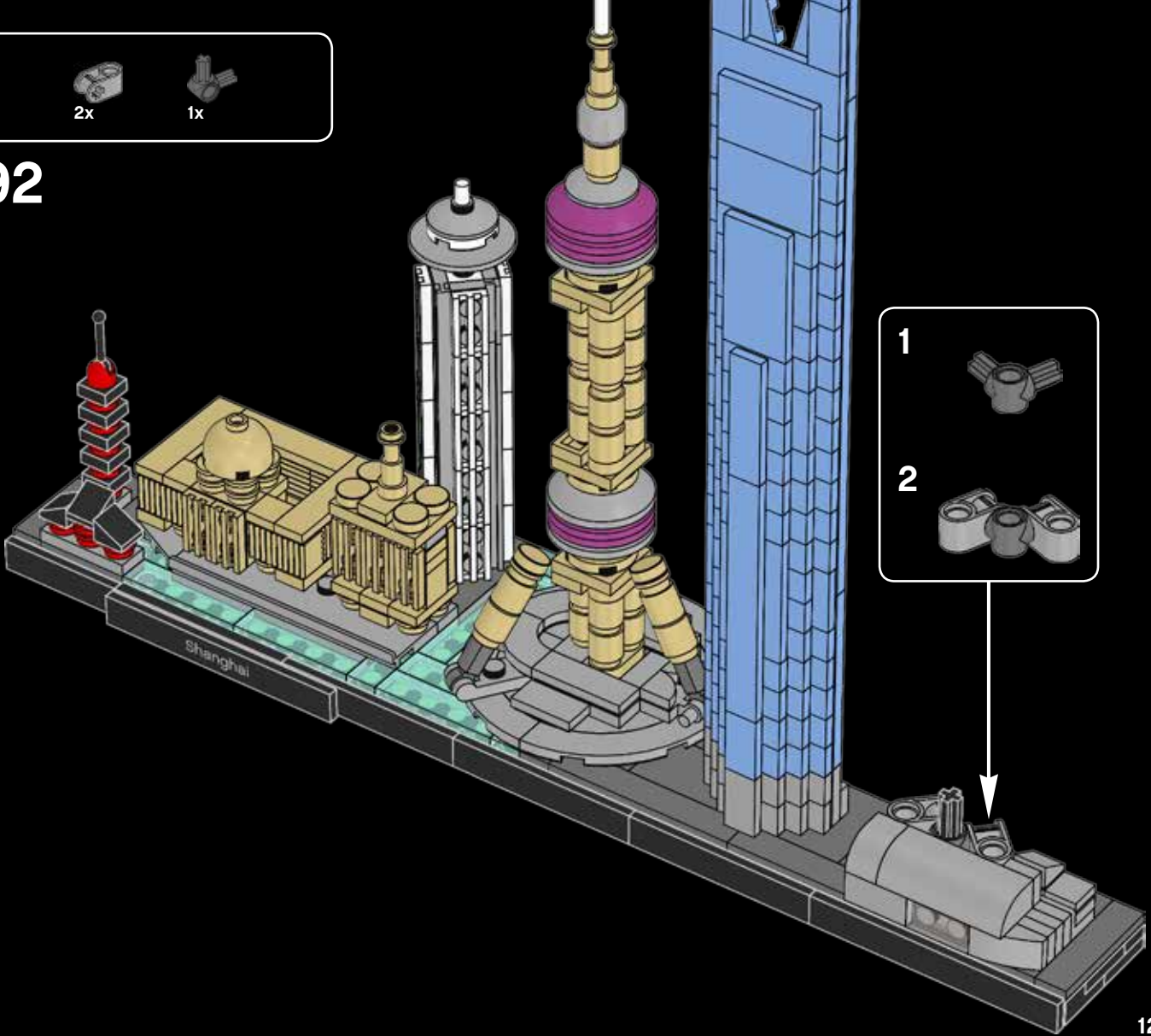



93

1

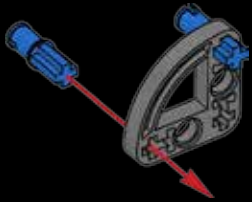

2

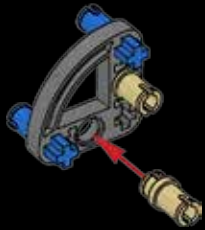

3



4



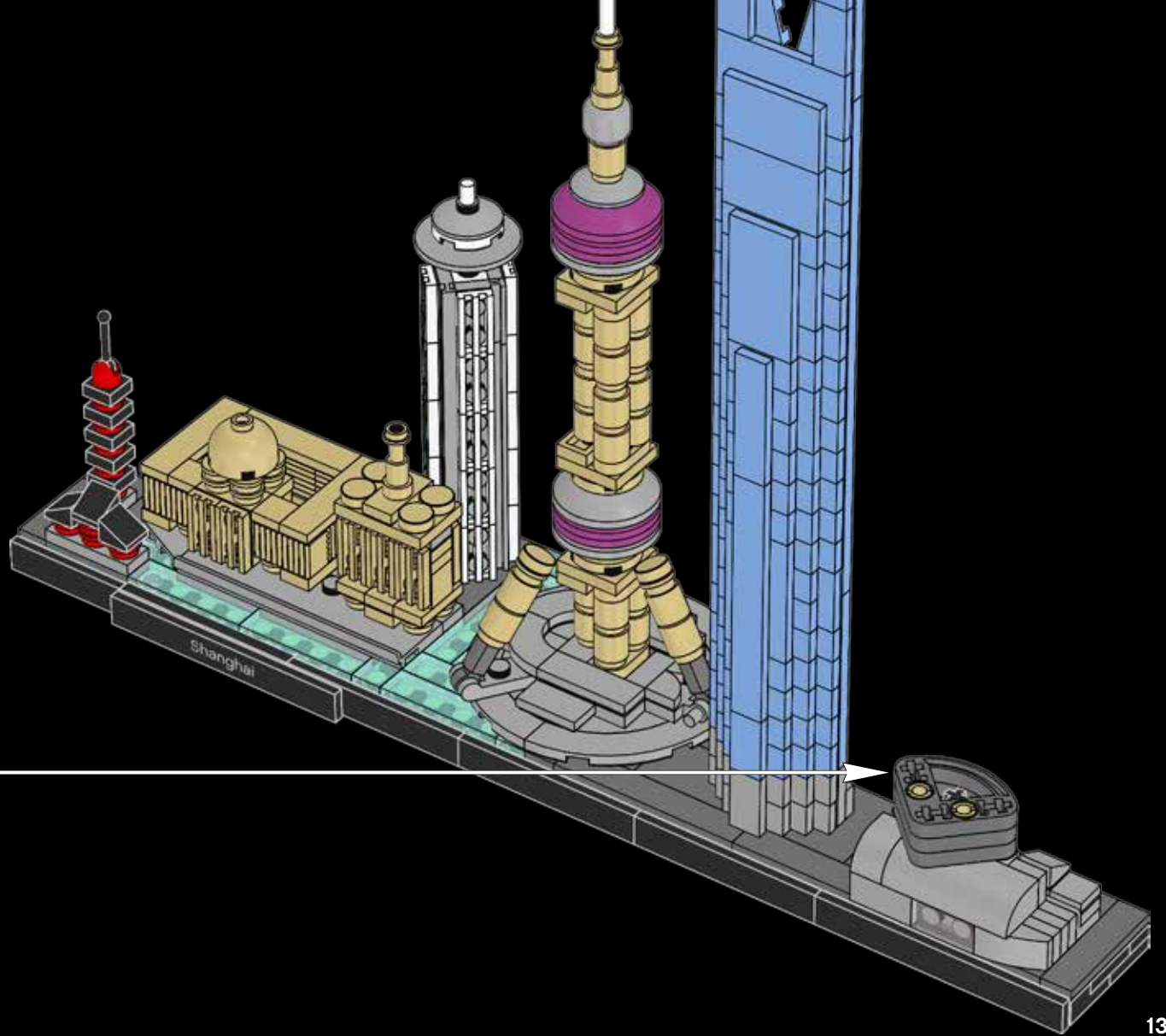

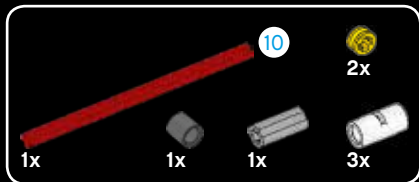

94

1

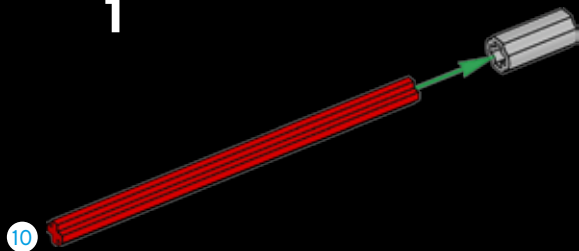

2

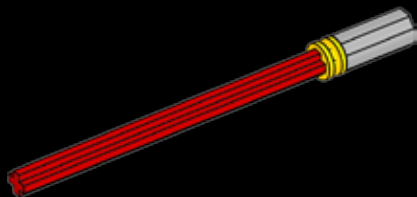

3

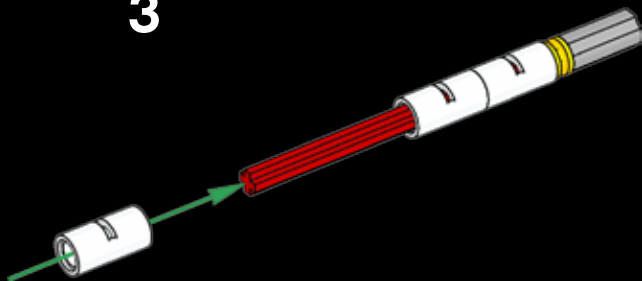

4

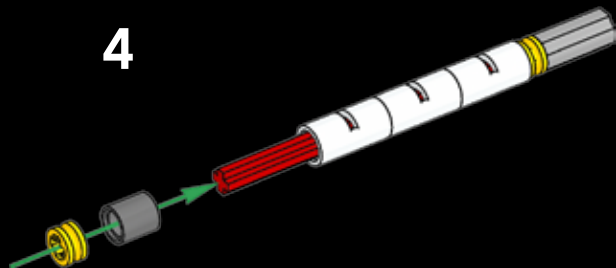

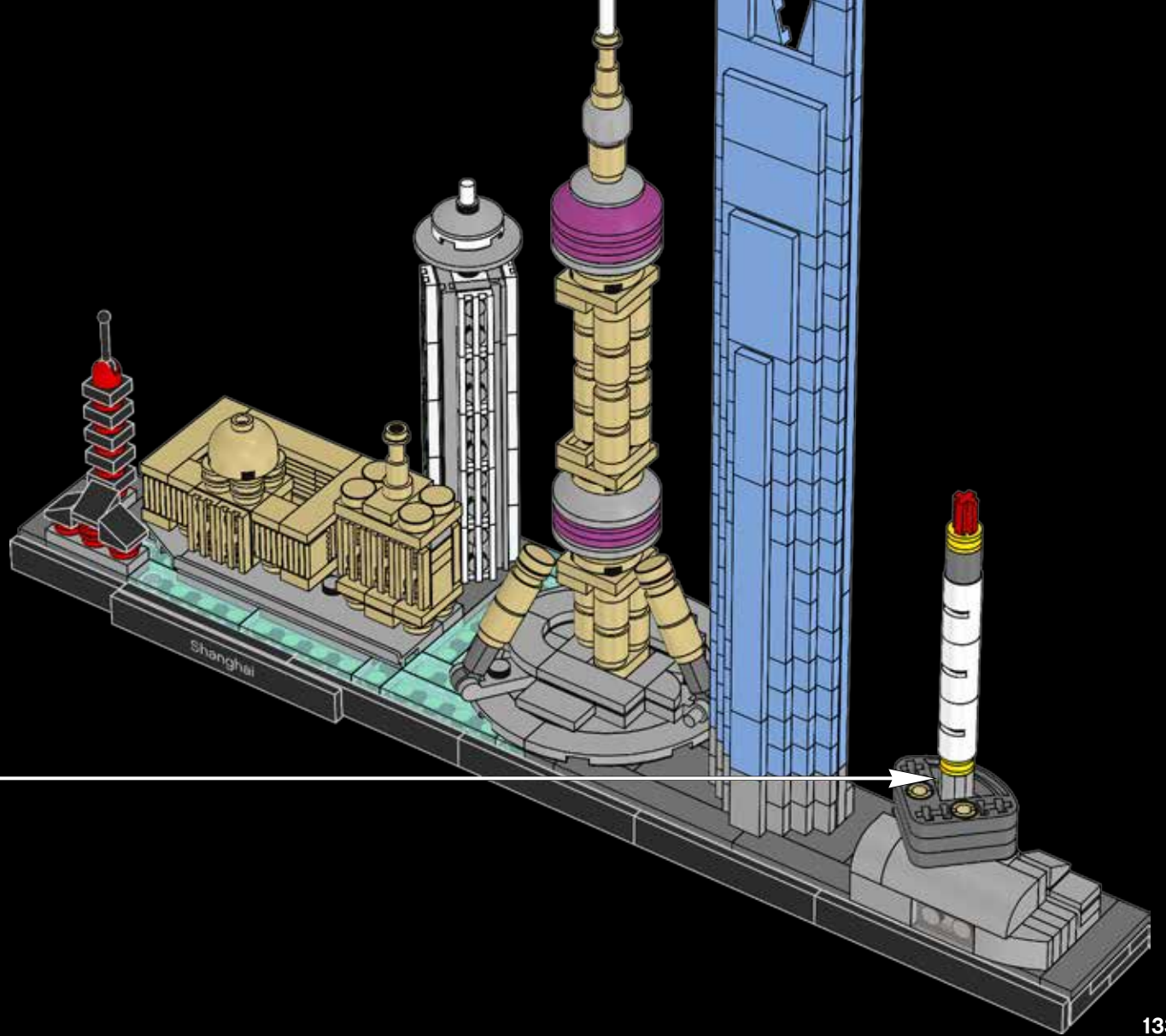

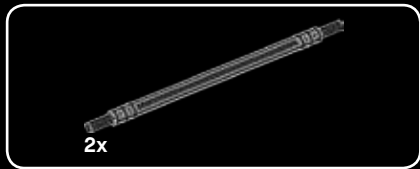

95

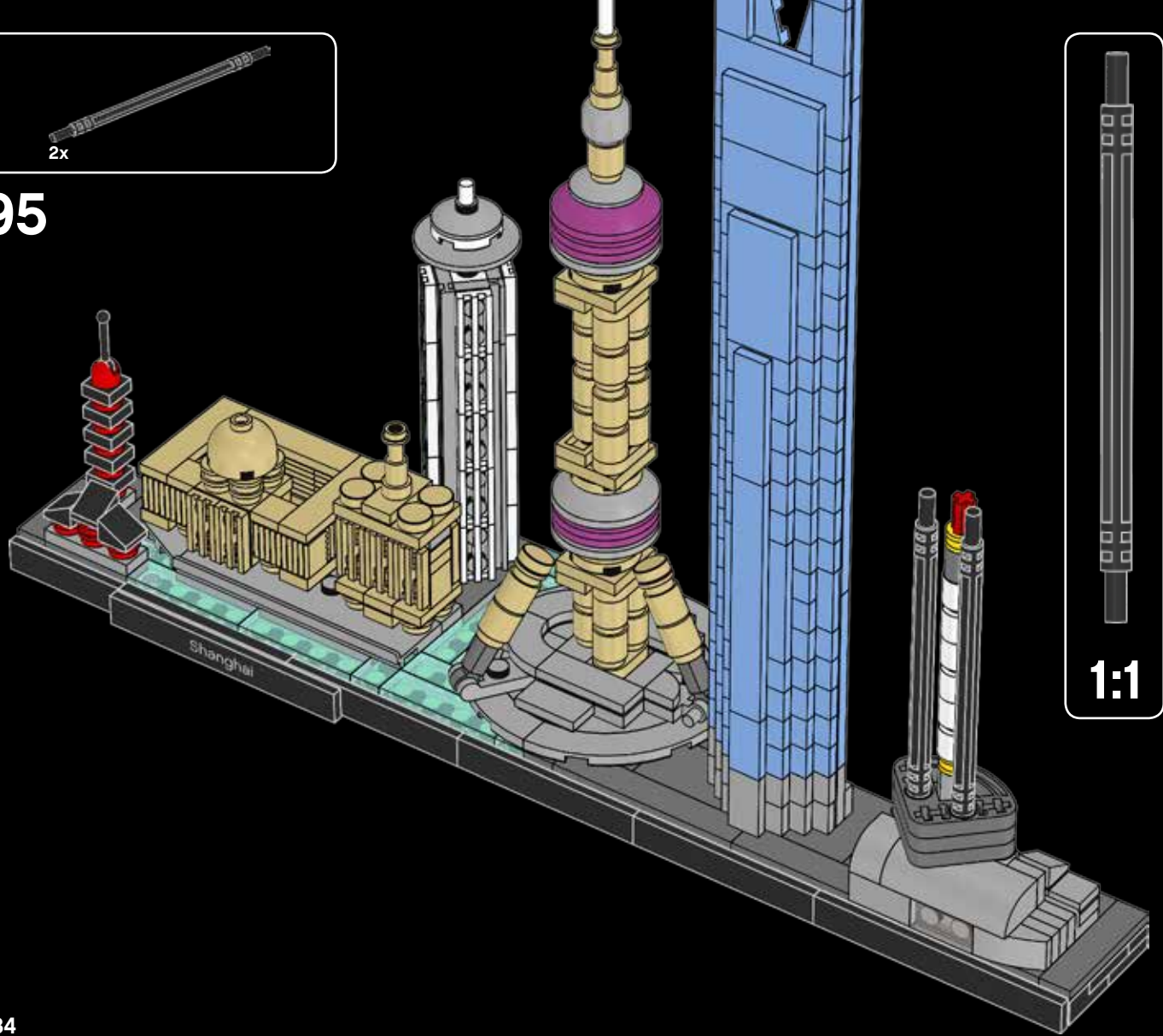

1:1



96

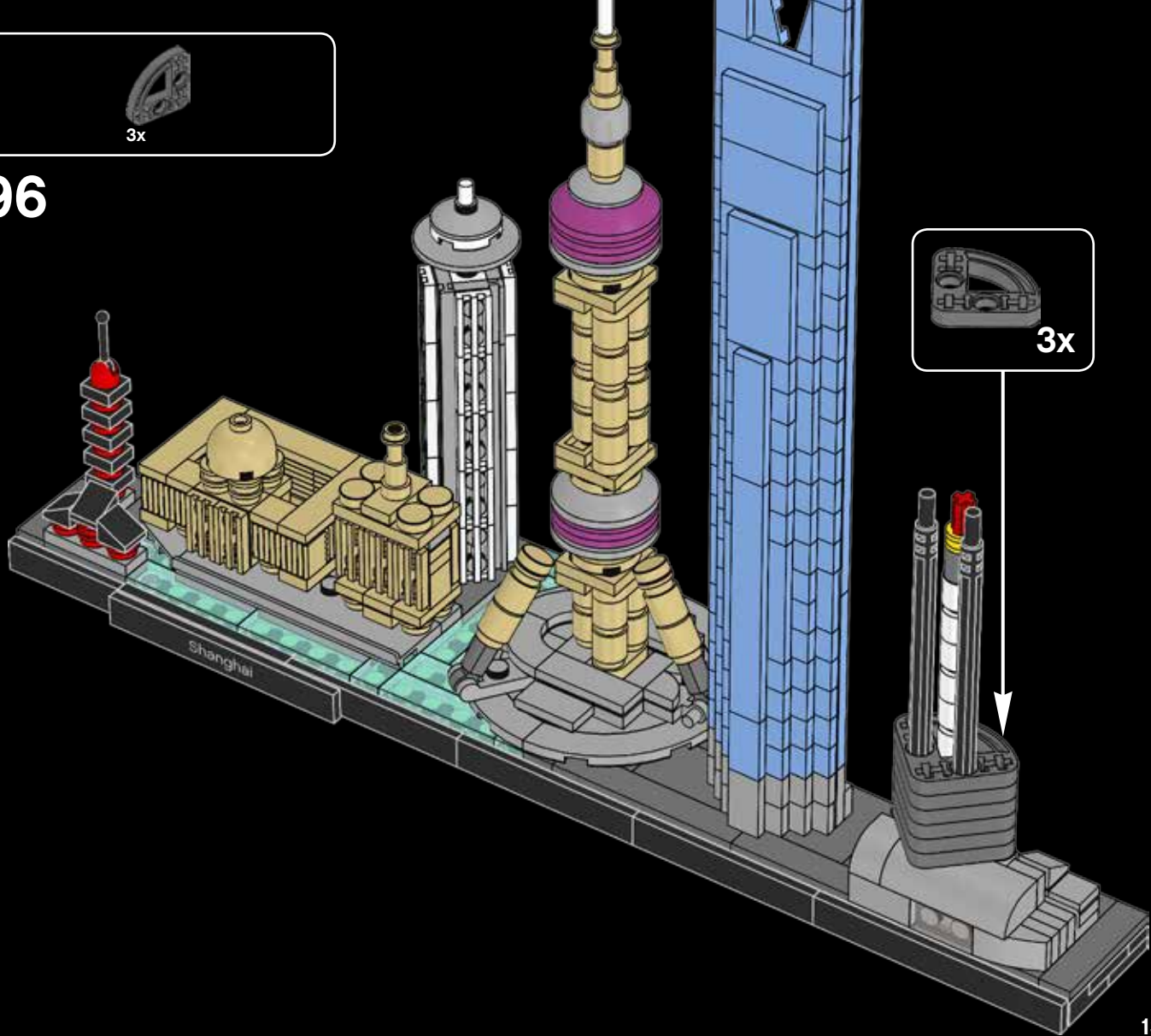



97

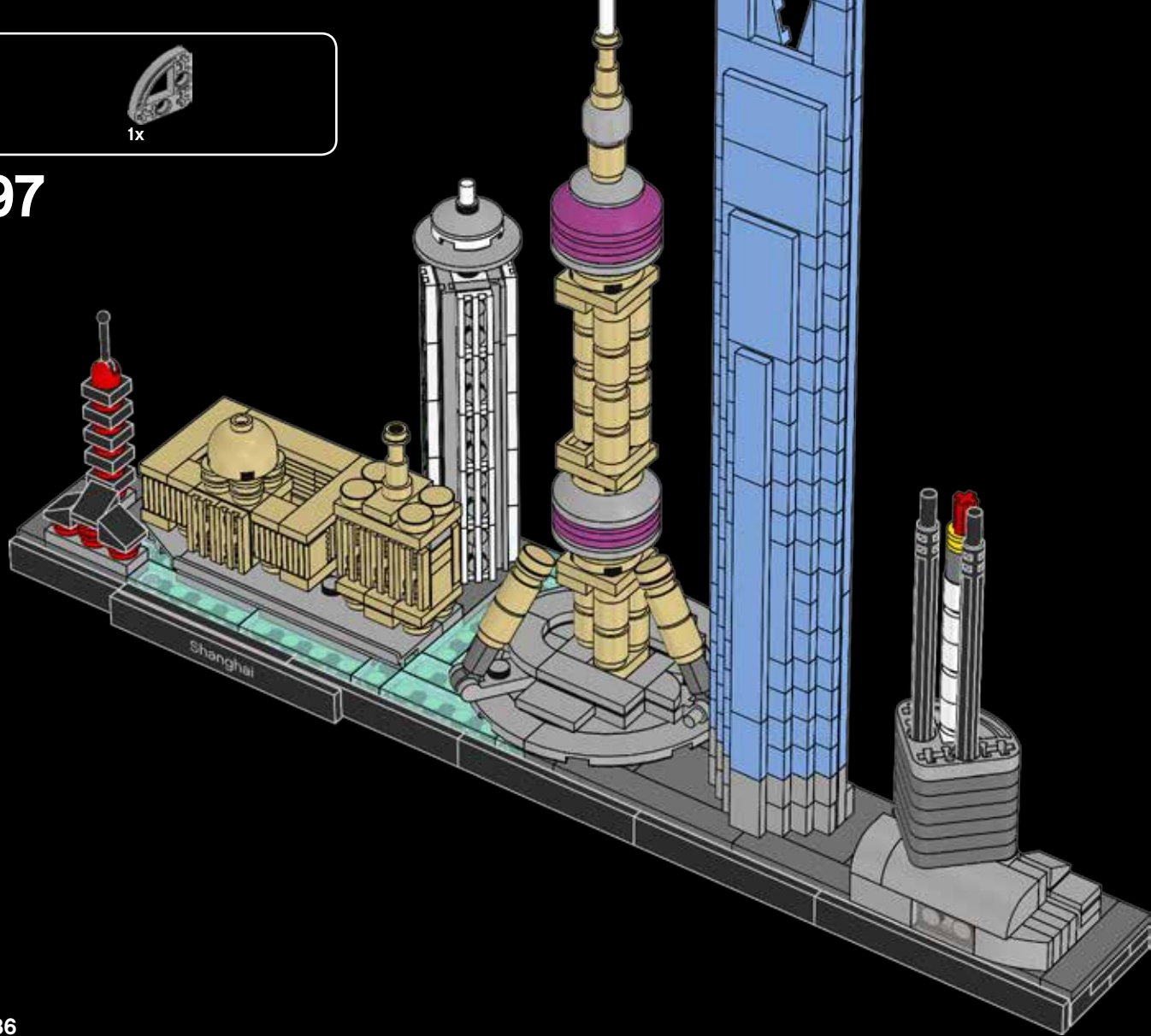



98

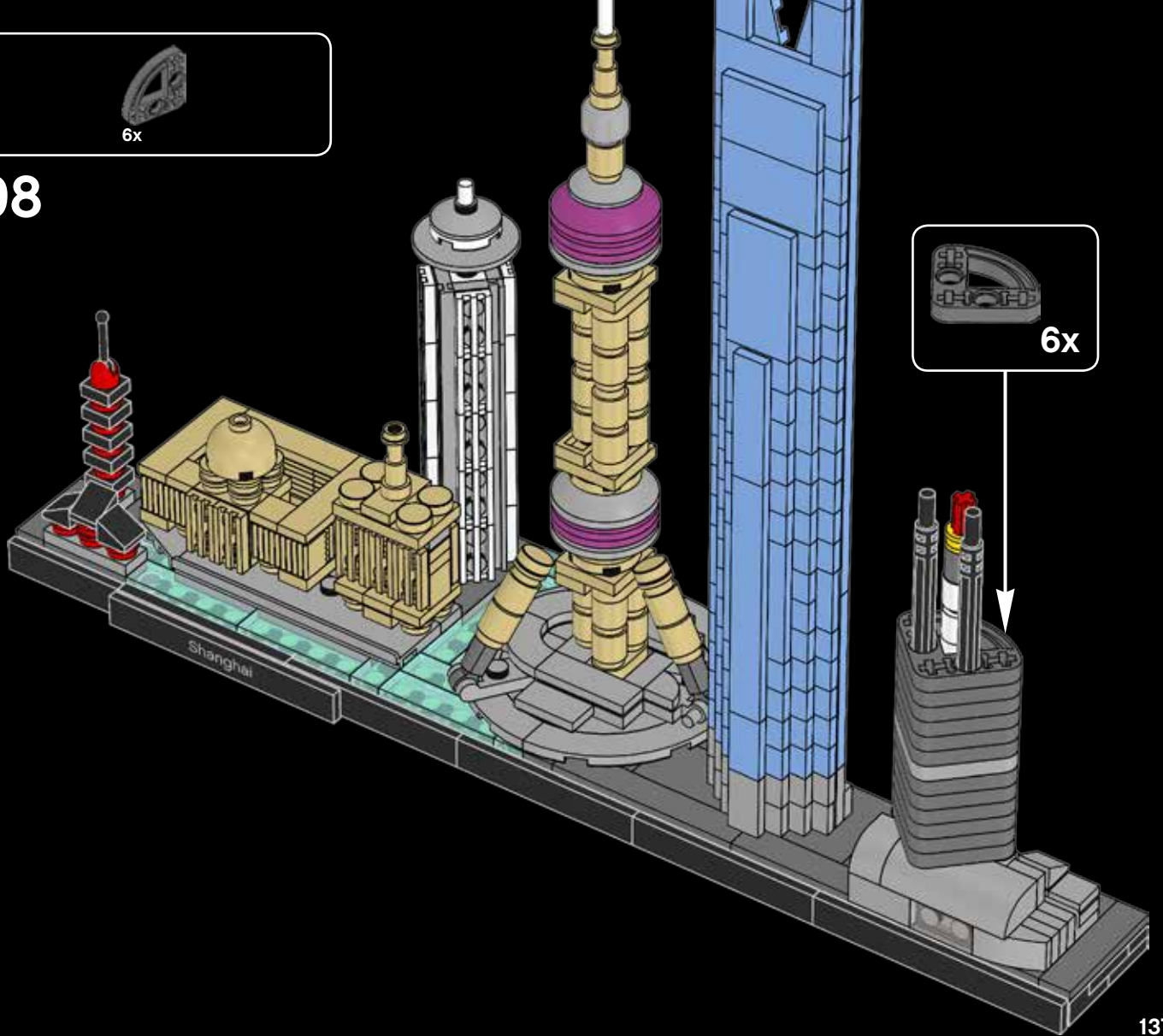



99

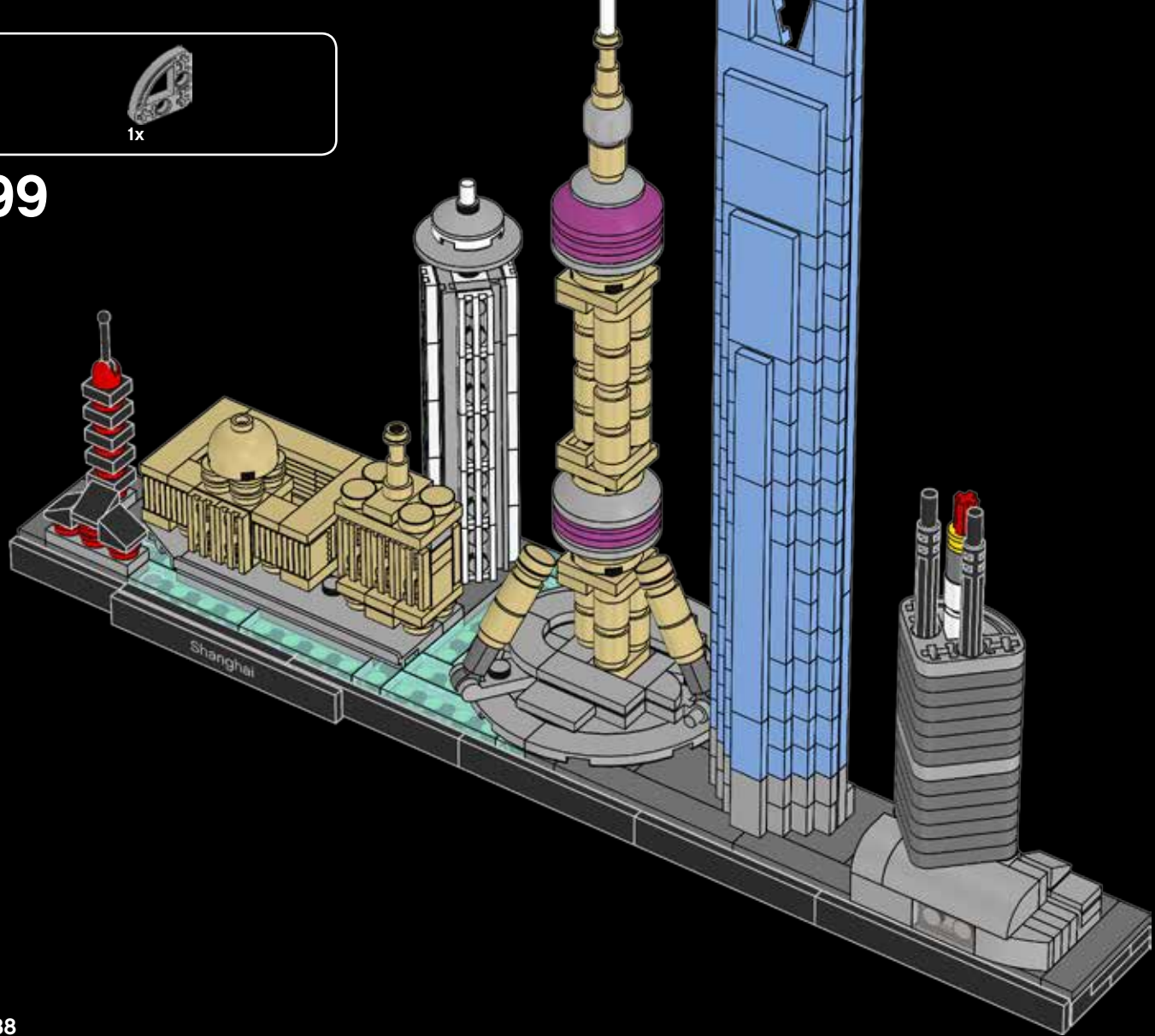



100

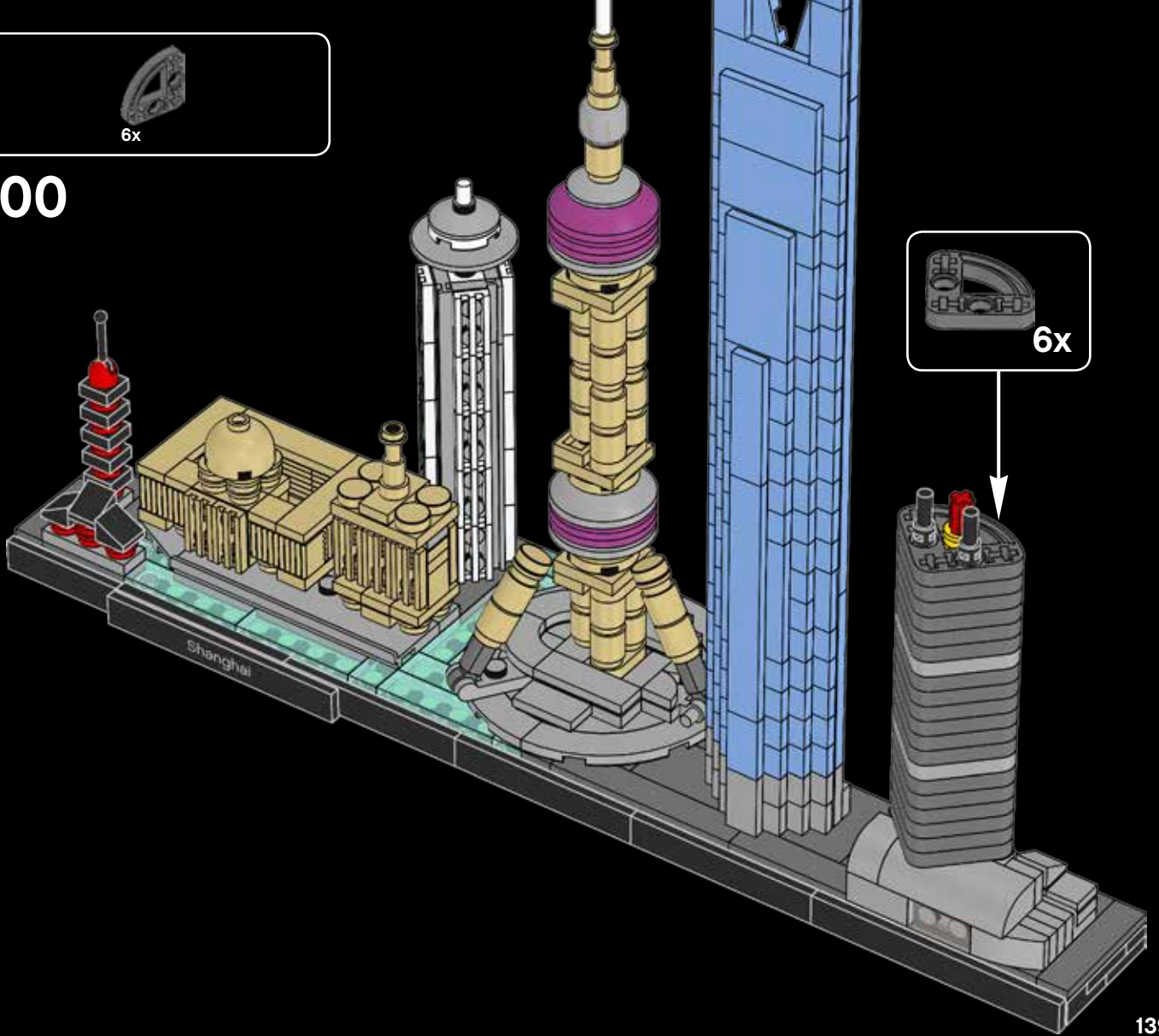



101

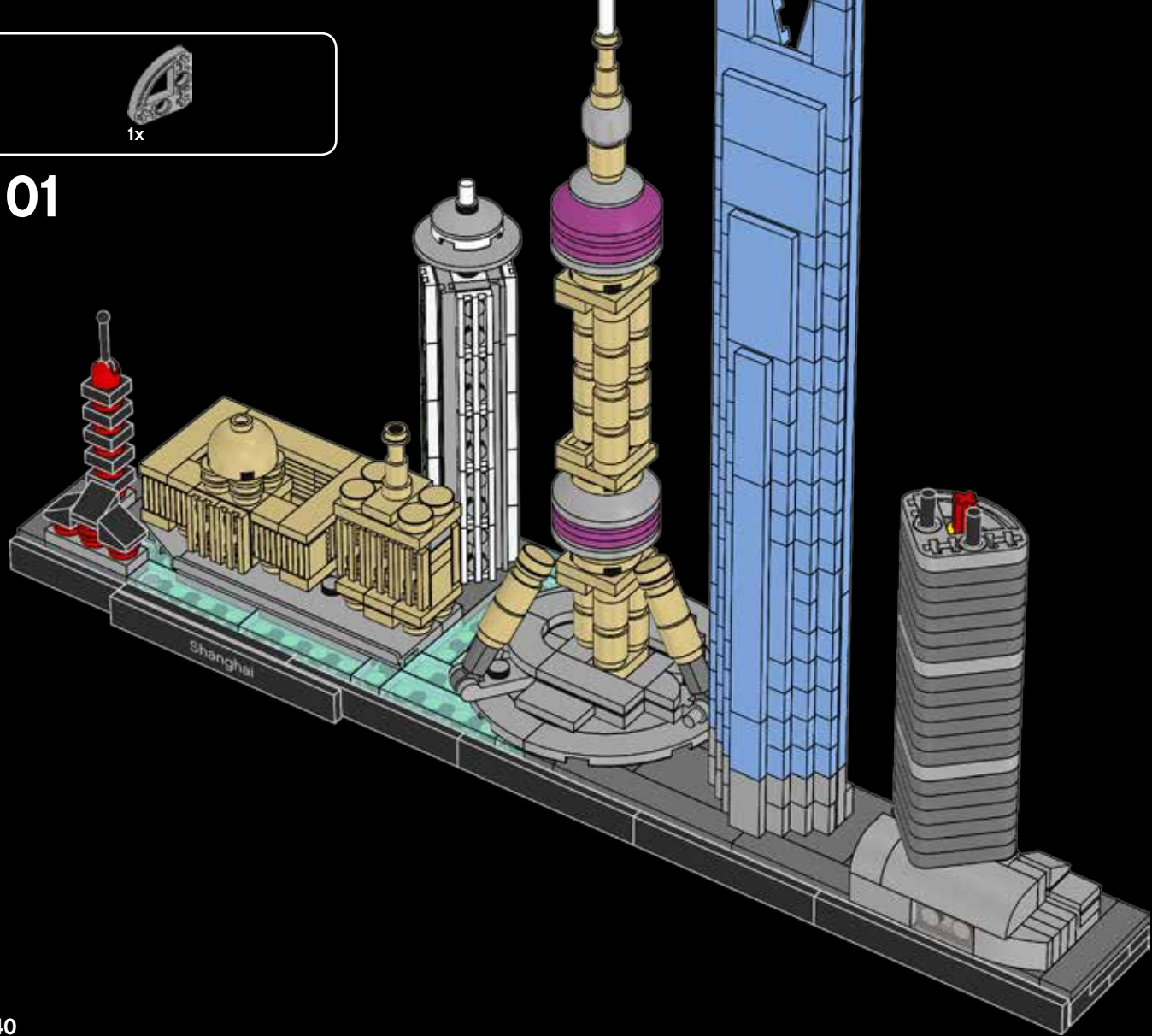

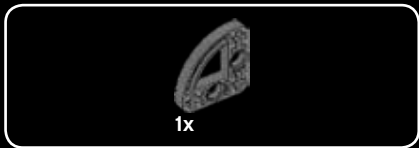

102

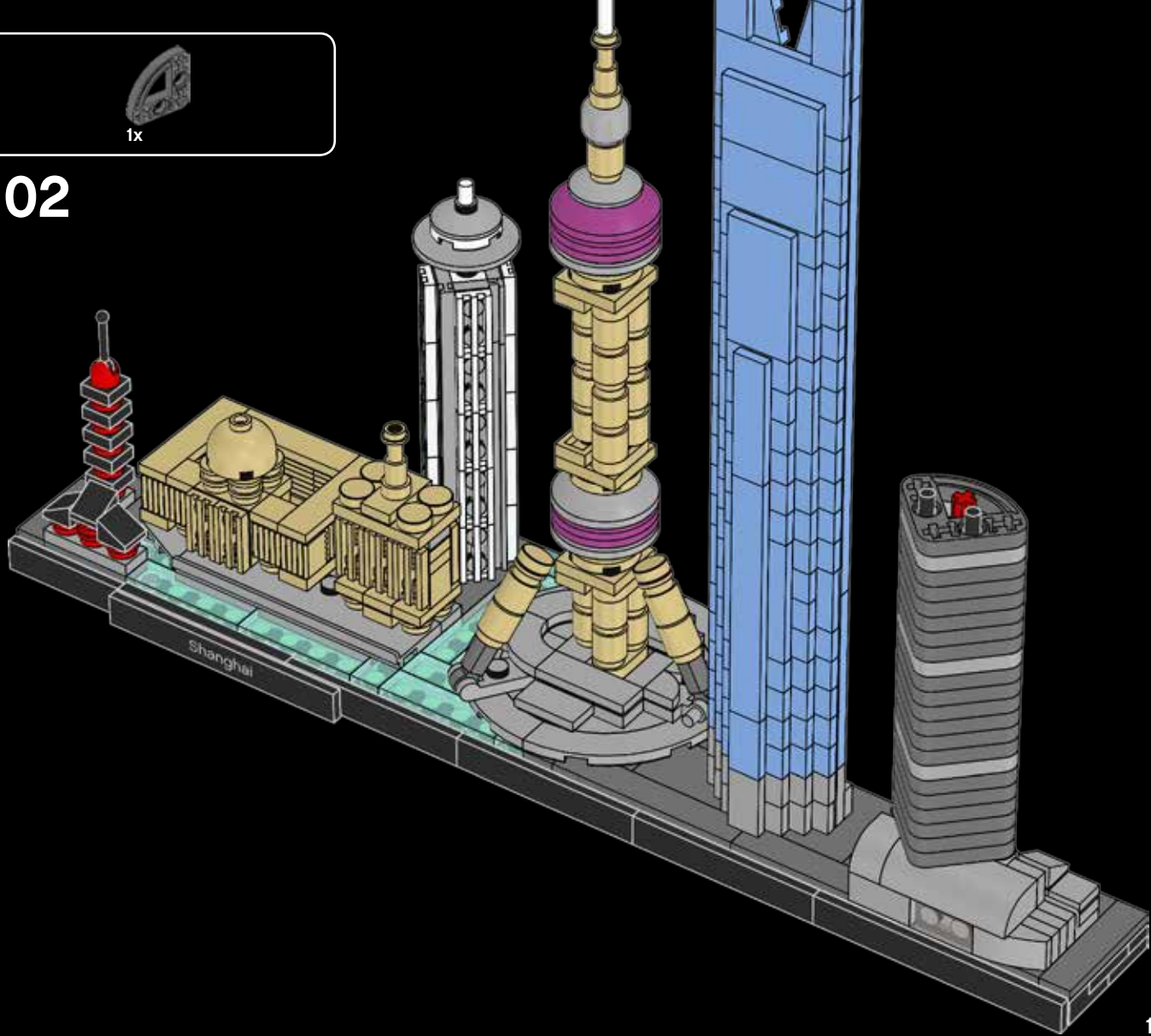



1x

103

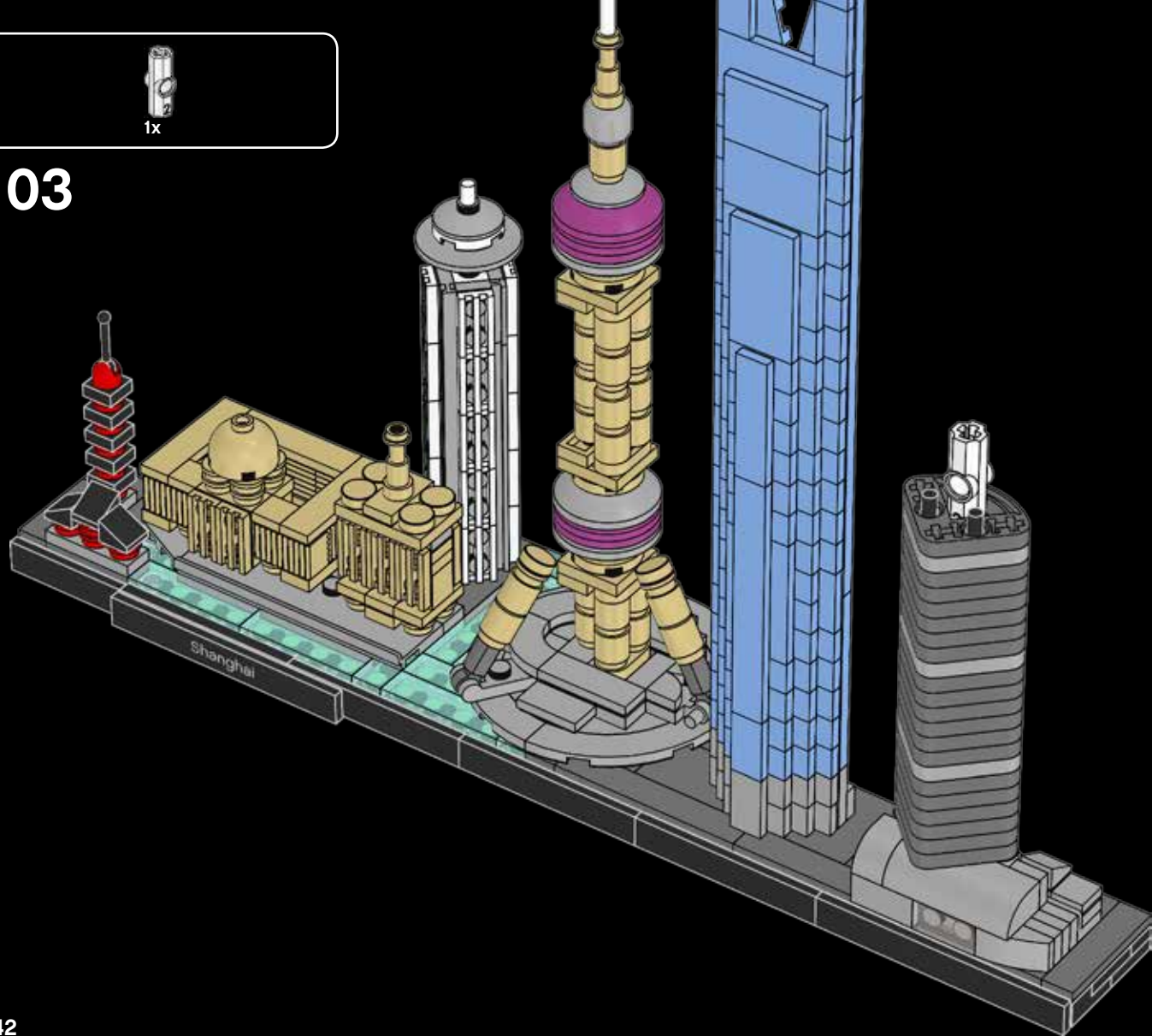

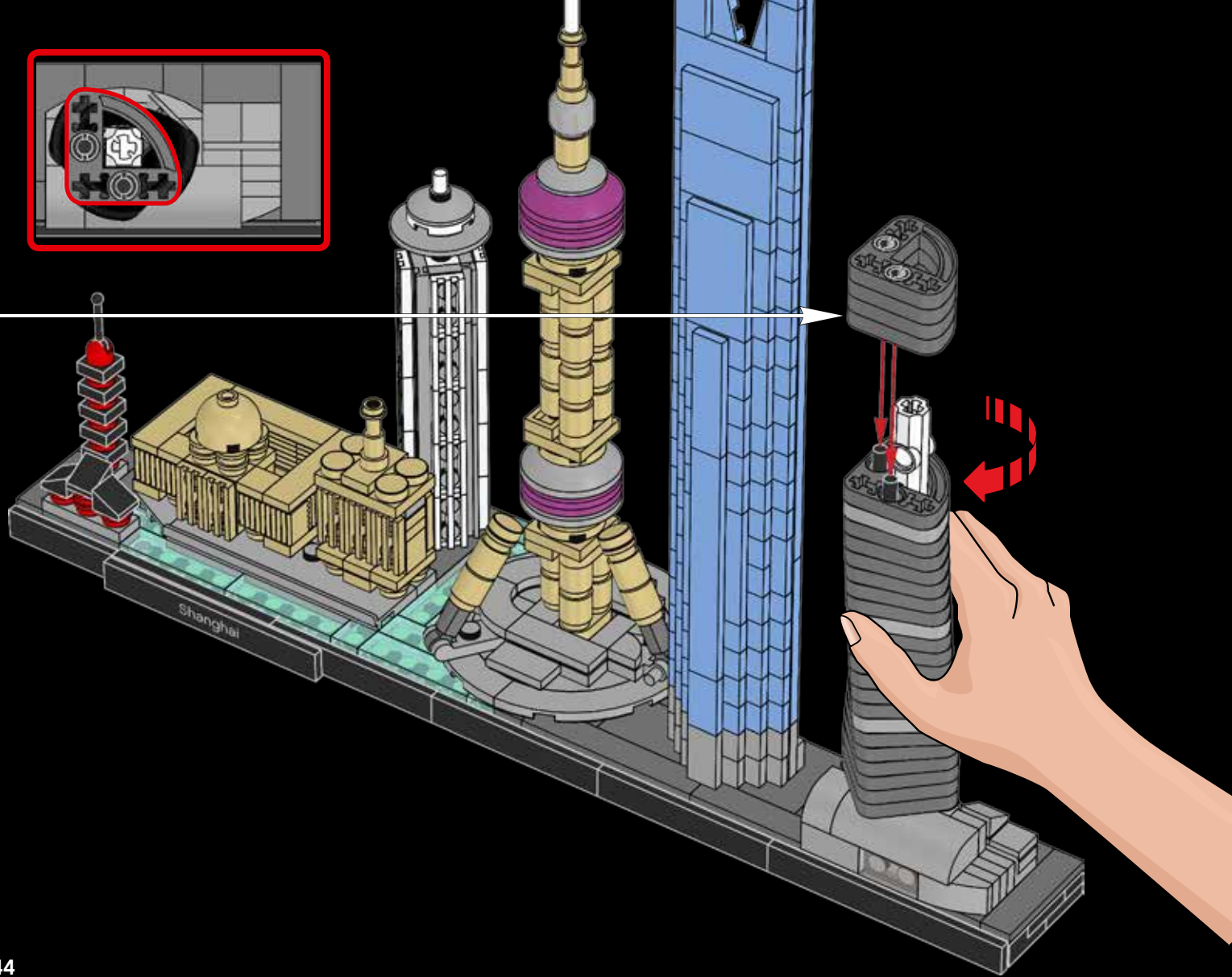
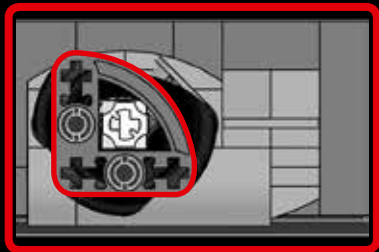

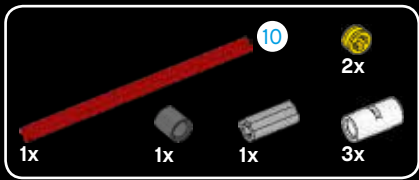

105

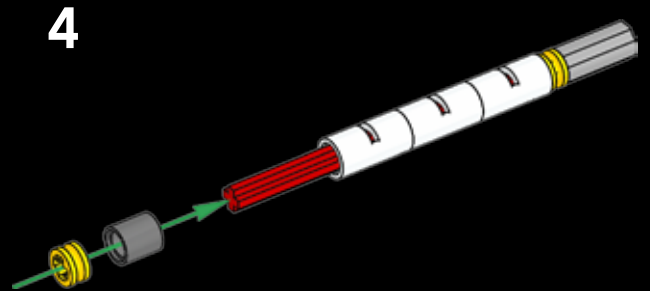
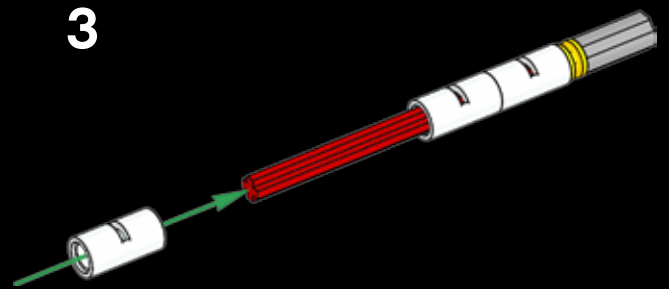
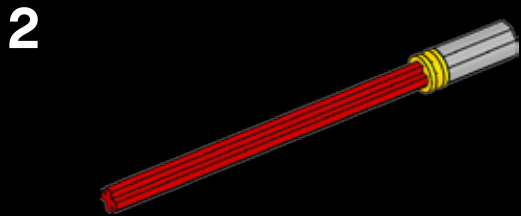
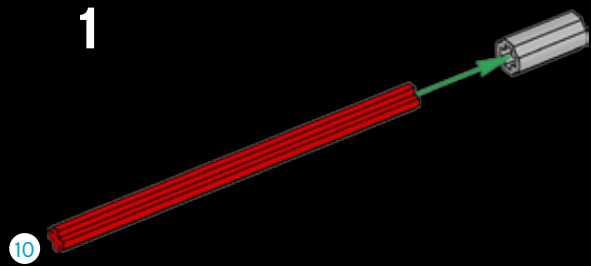

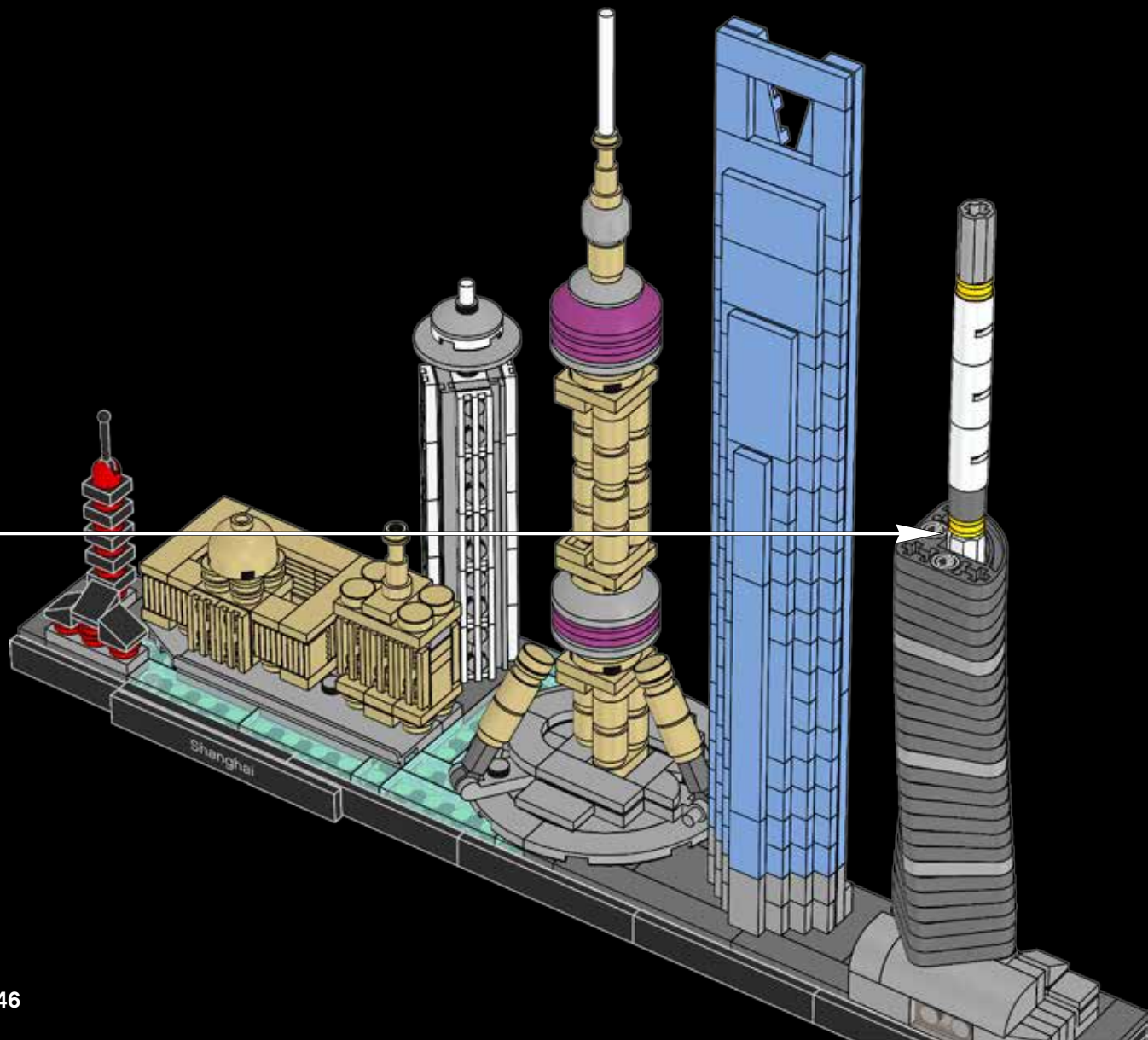

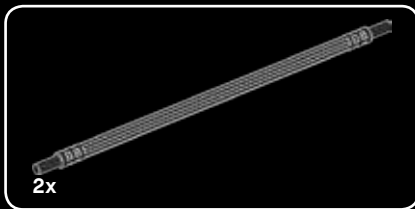

106

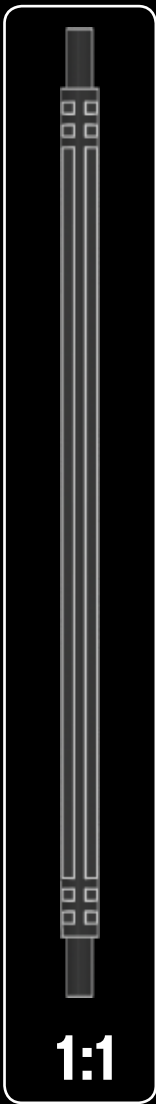
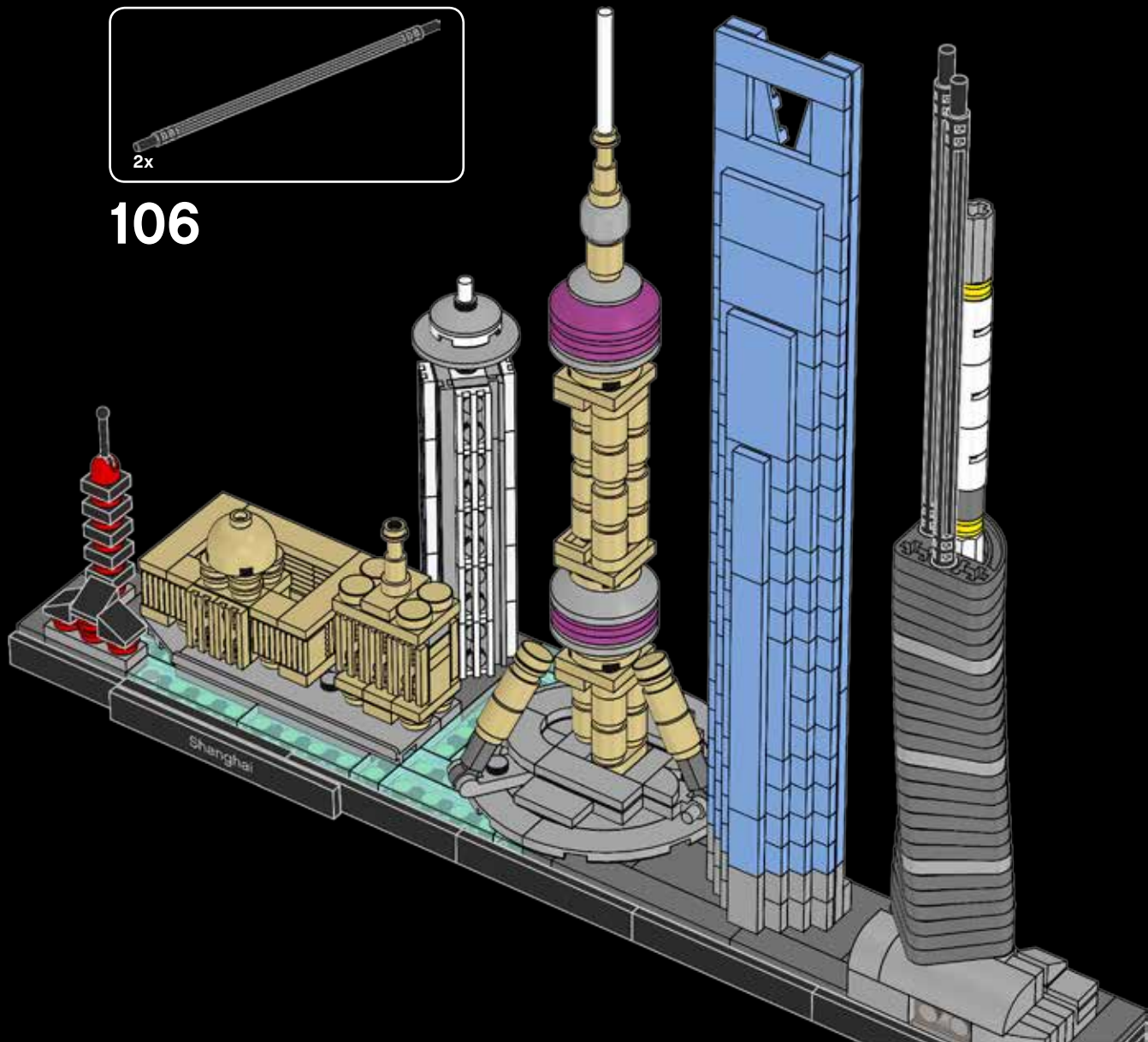



107

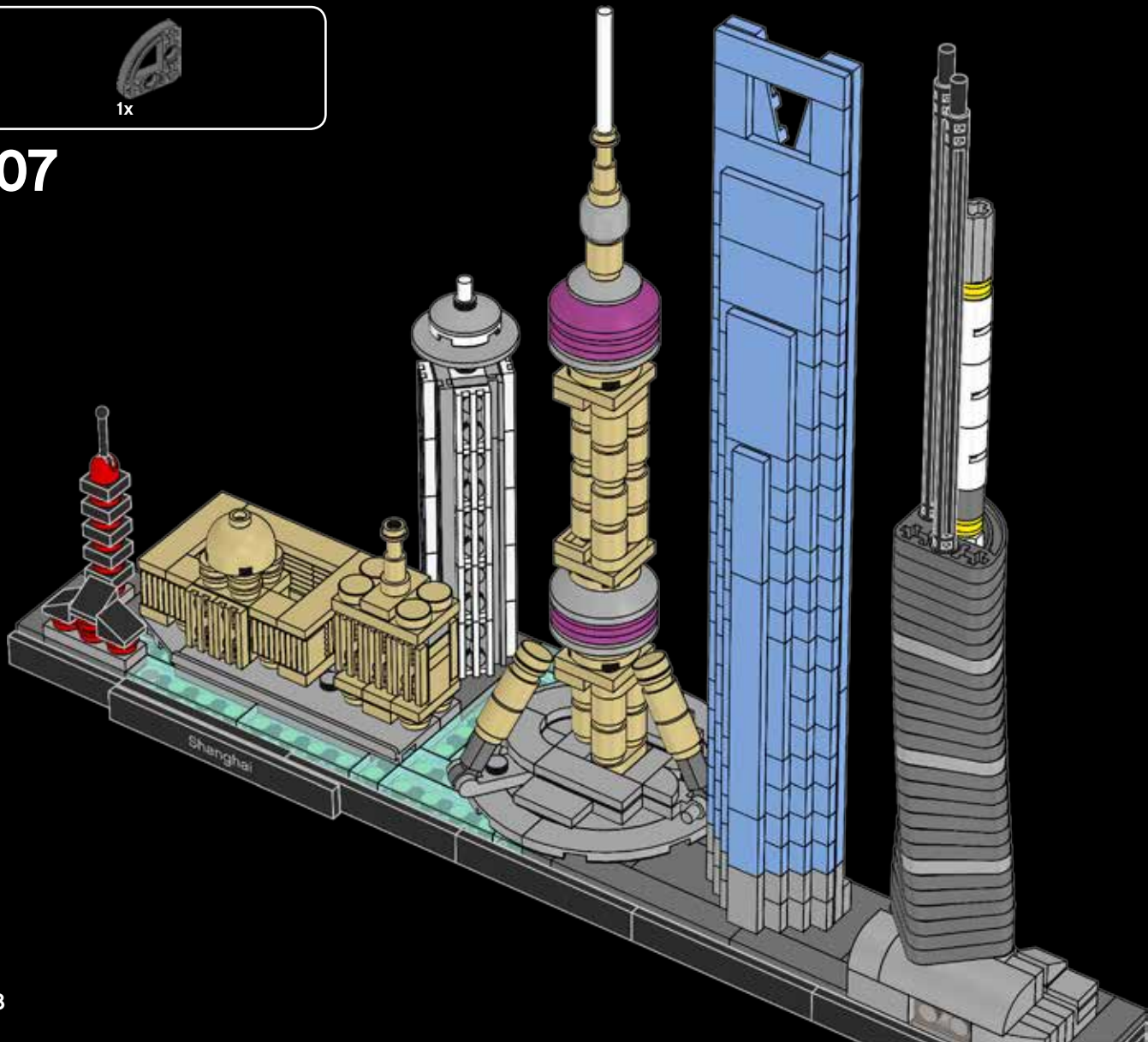



108

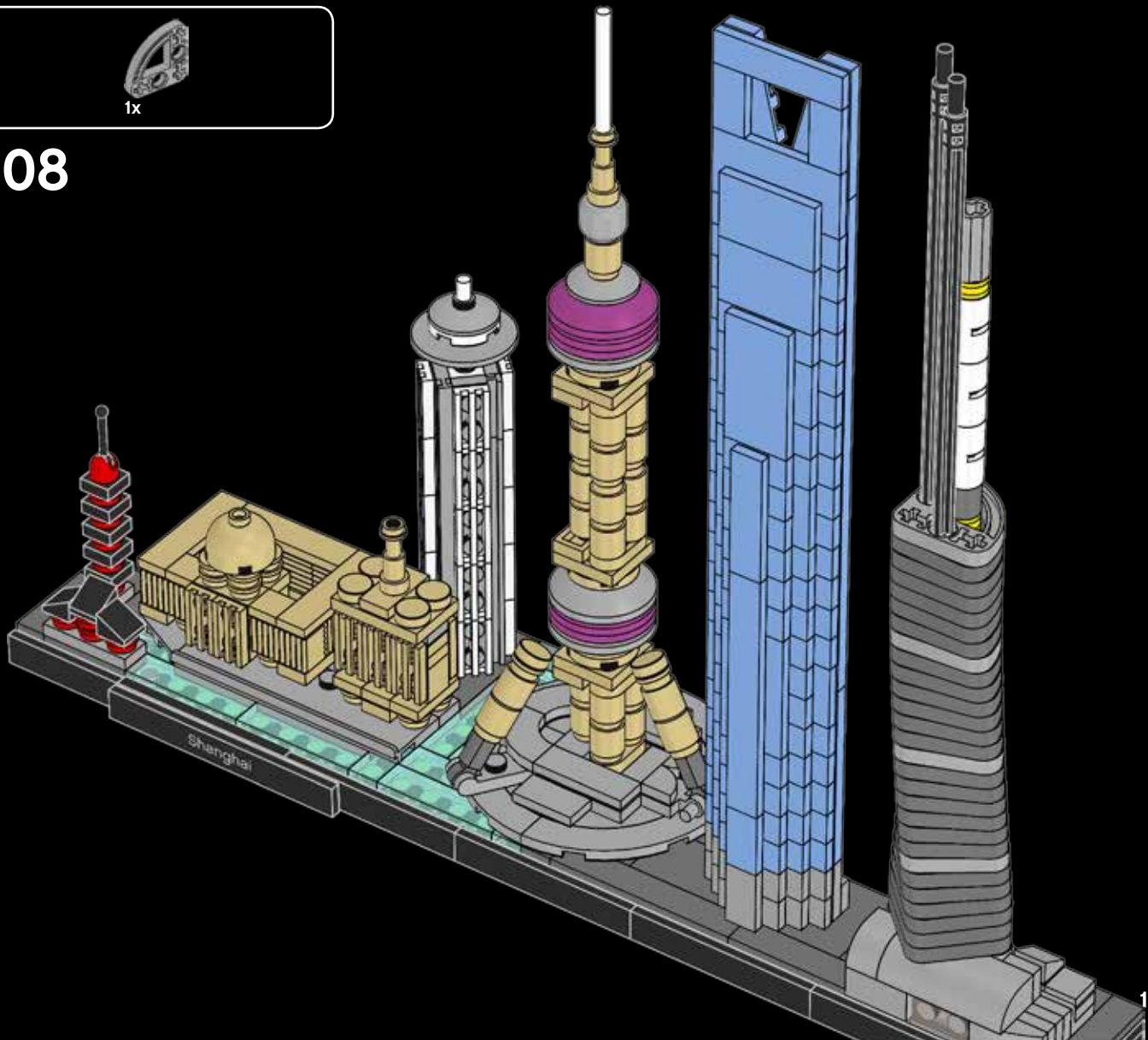



109

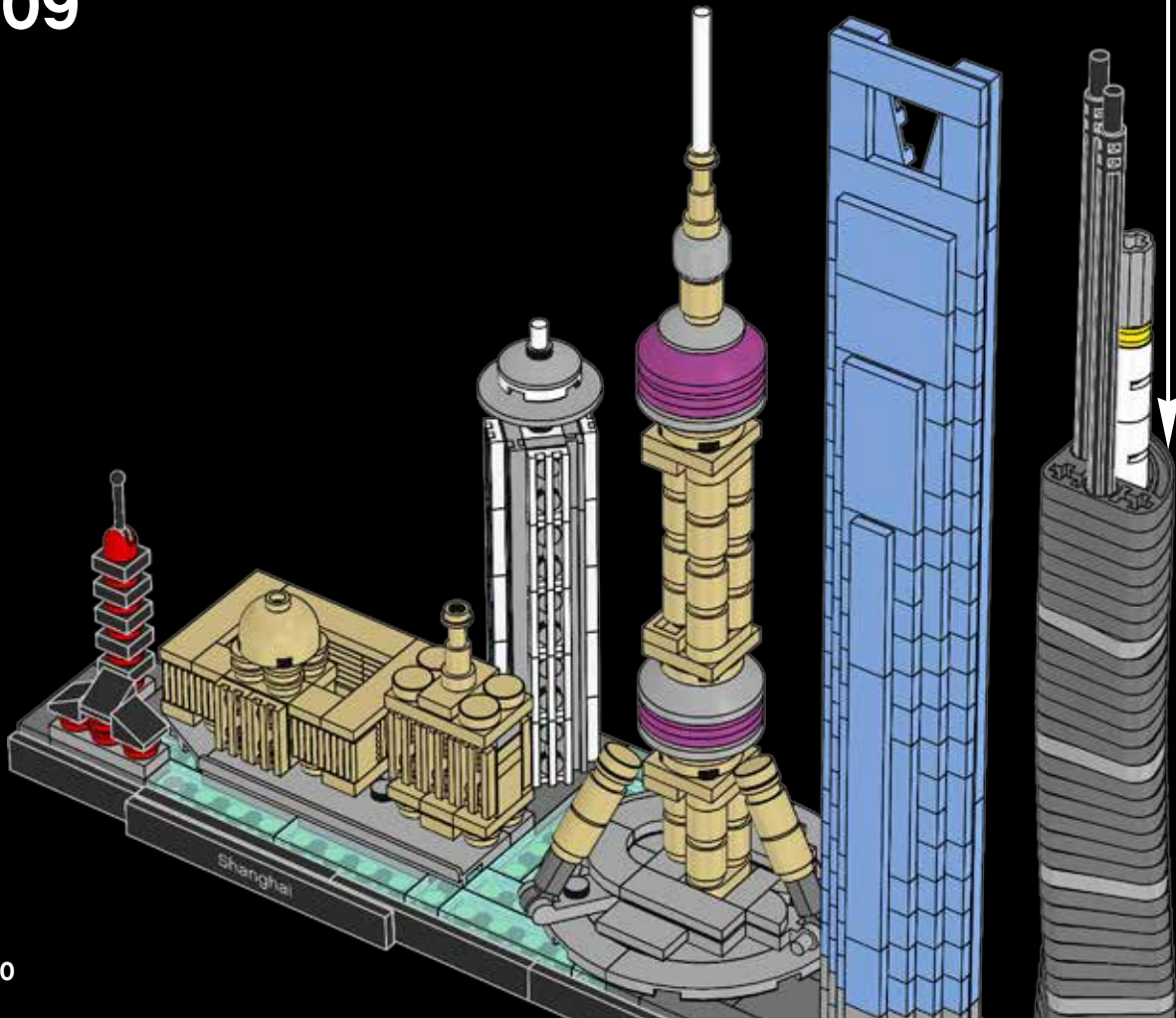



110

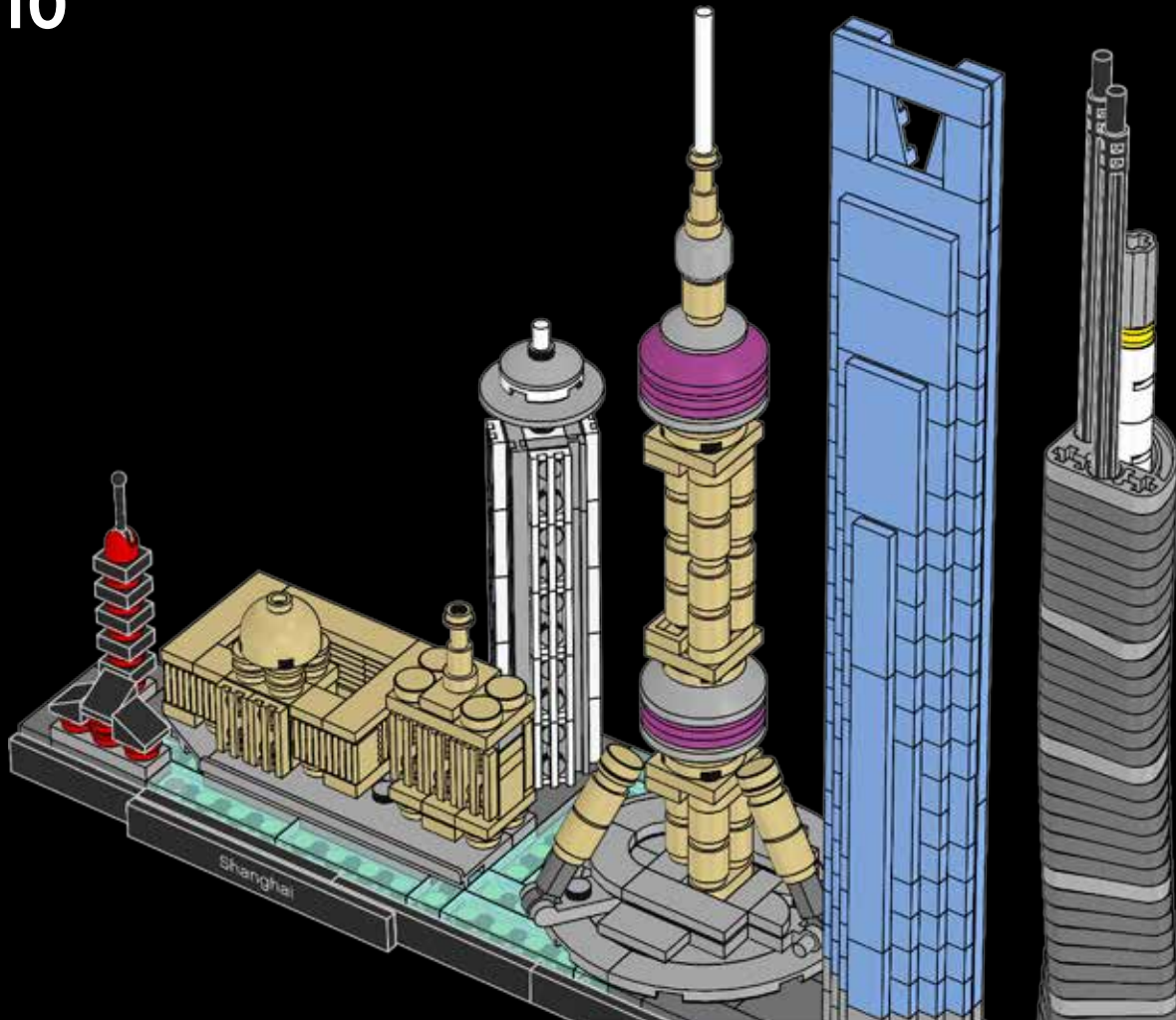



111

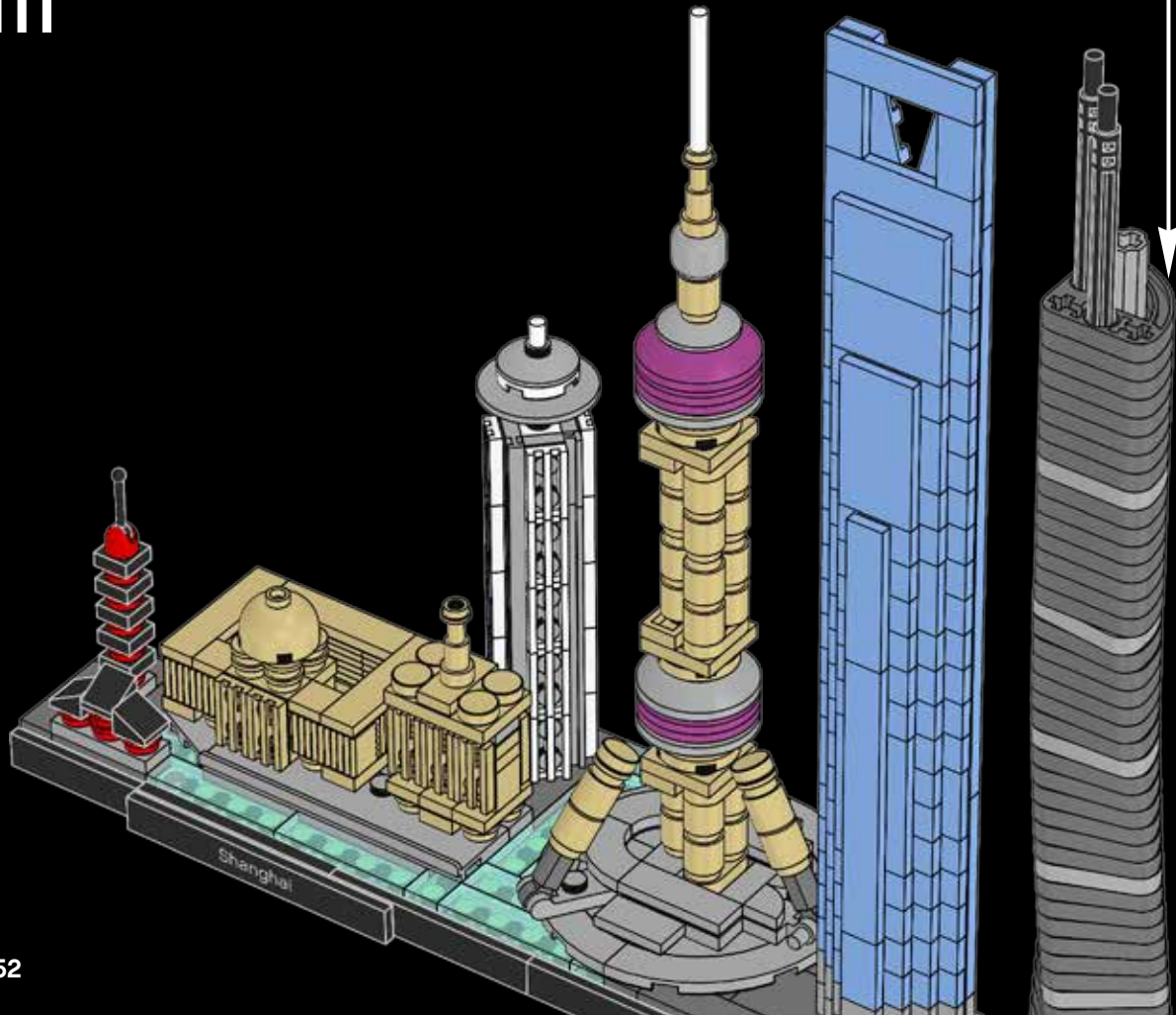



112

Instead of the traditional steel girder framework for a skeleton, the tower is constructed around a thick concrete core.

Plutôt que de compter sur une armature traditionnelle de poutres d'acier, la tour est construite autour d'un épais noyau en béton.

En lugar de usar la tradicional estructura de vigas de acero como esqueleto, la torre se construyó alrededor de un grueso núcleo de concreto.

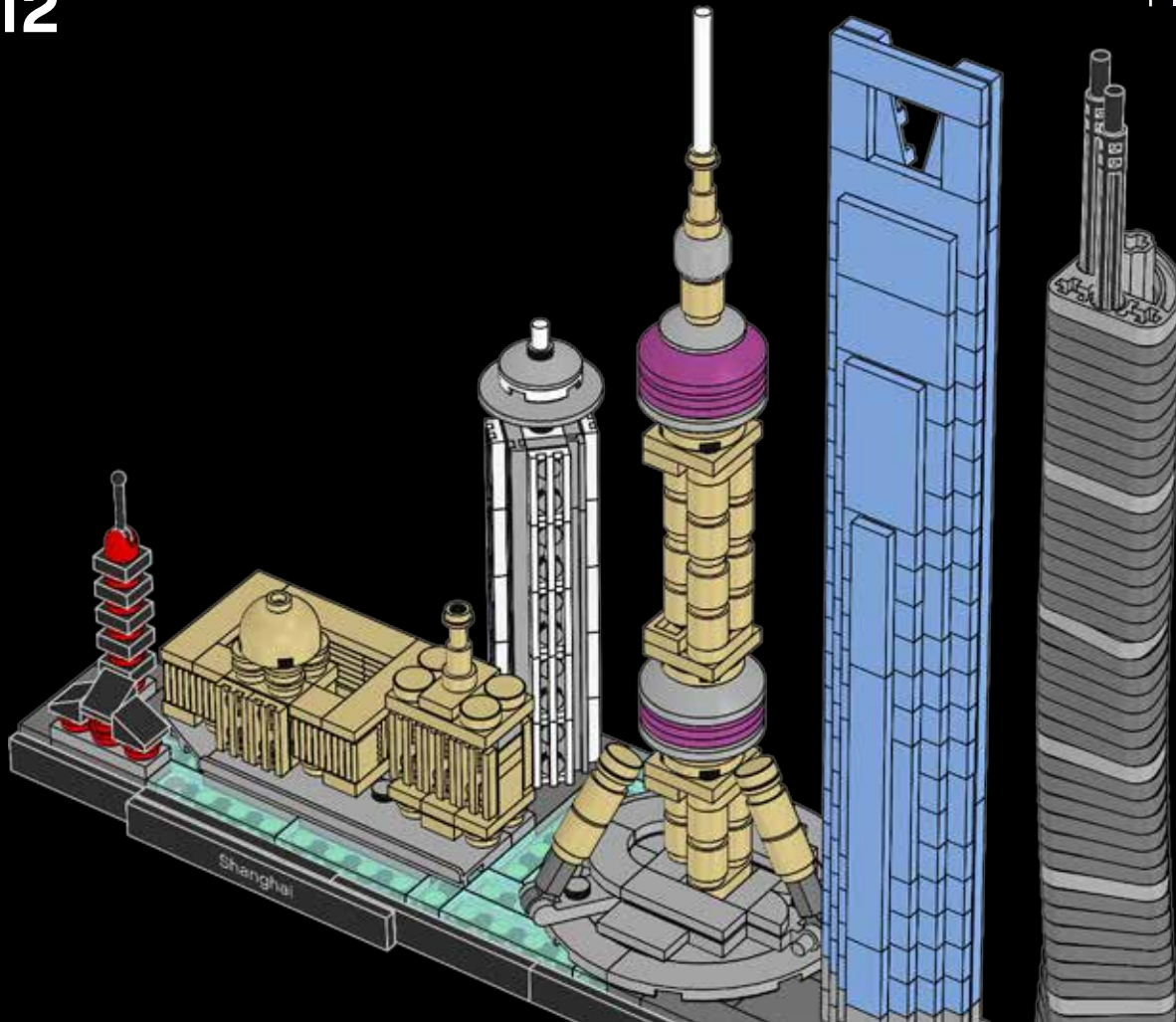

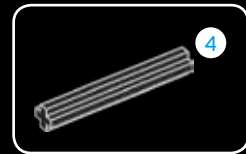
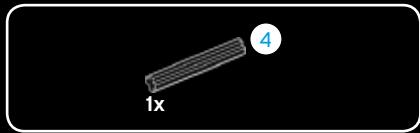

113

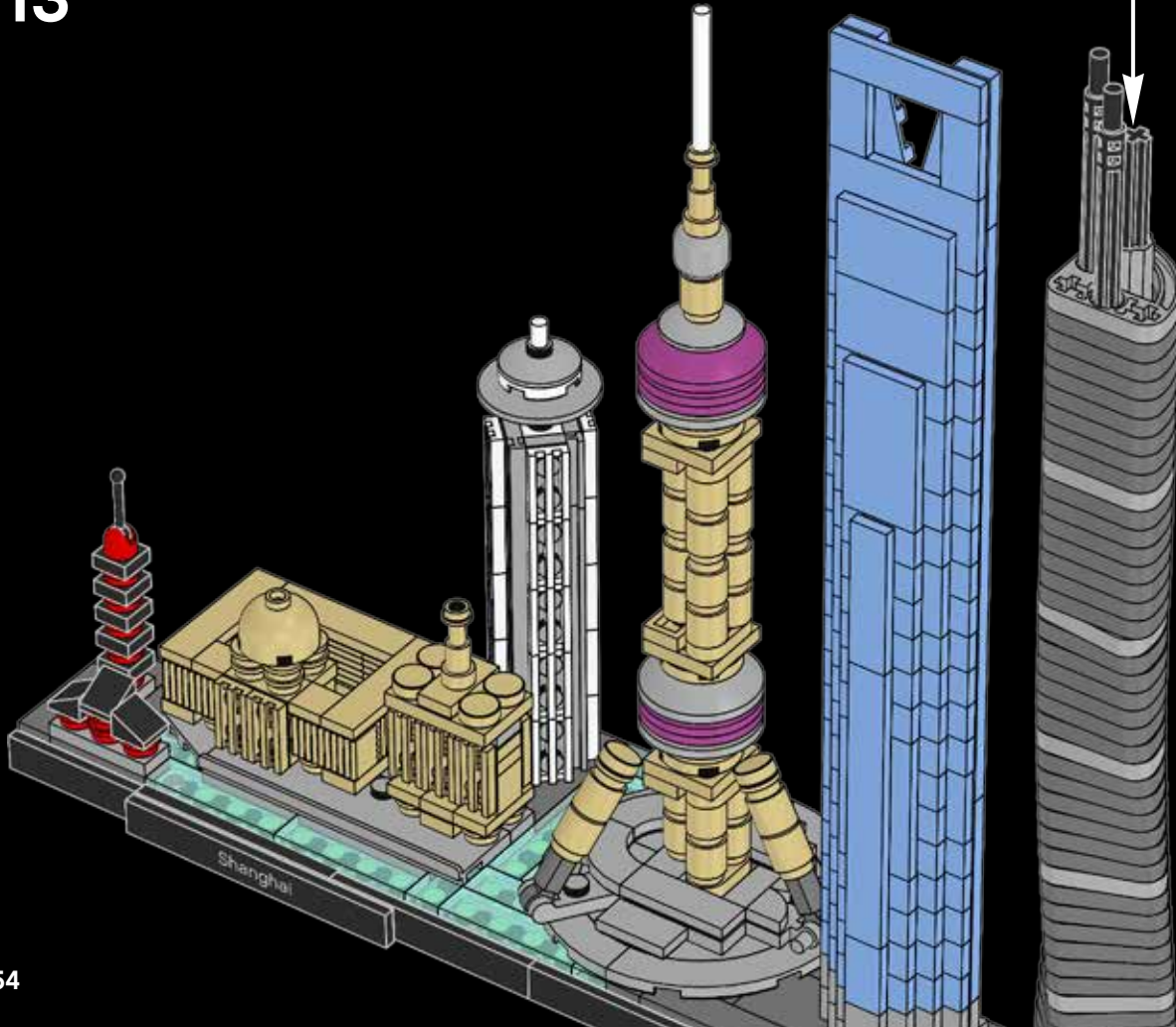



114





1x

115

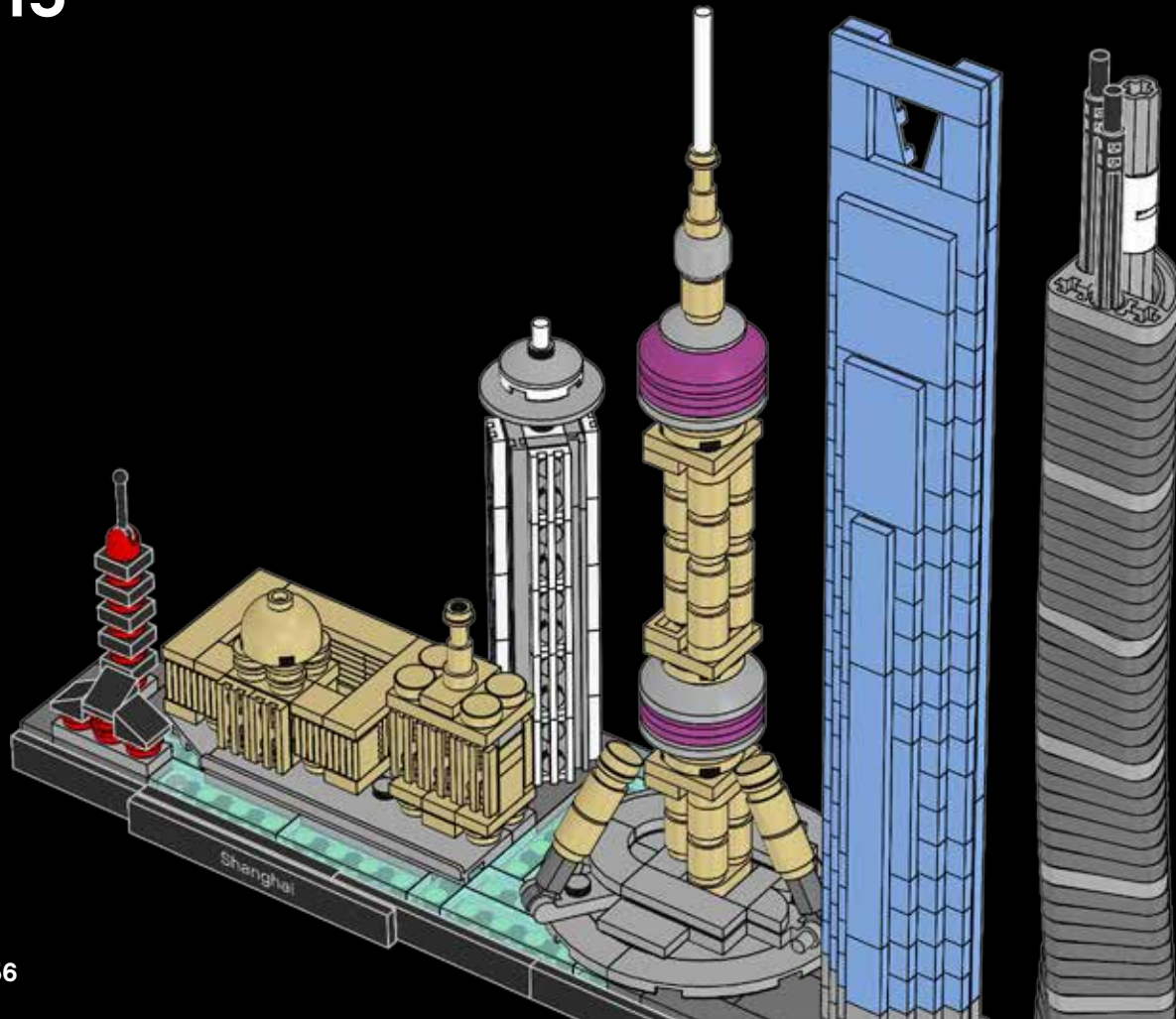

156



116

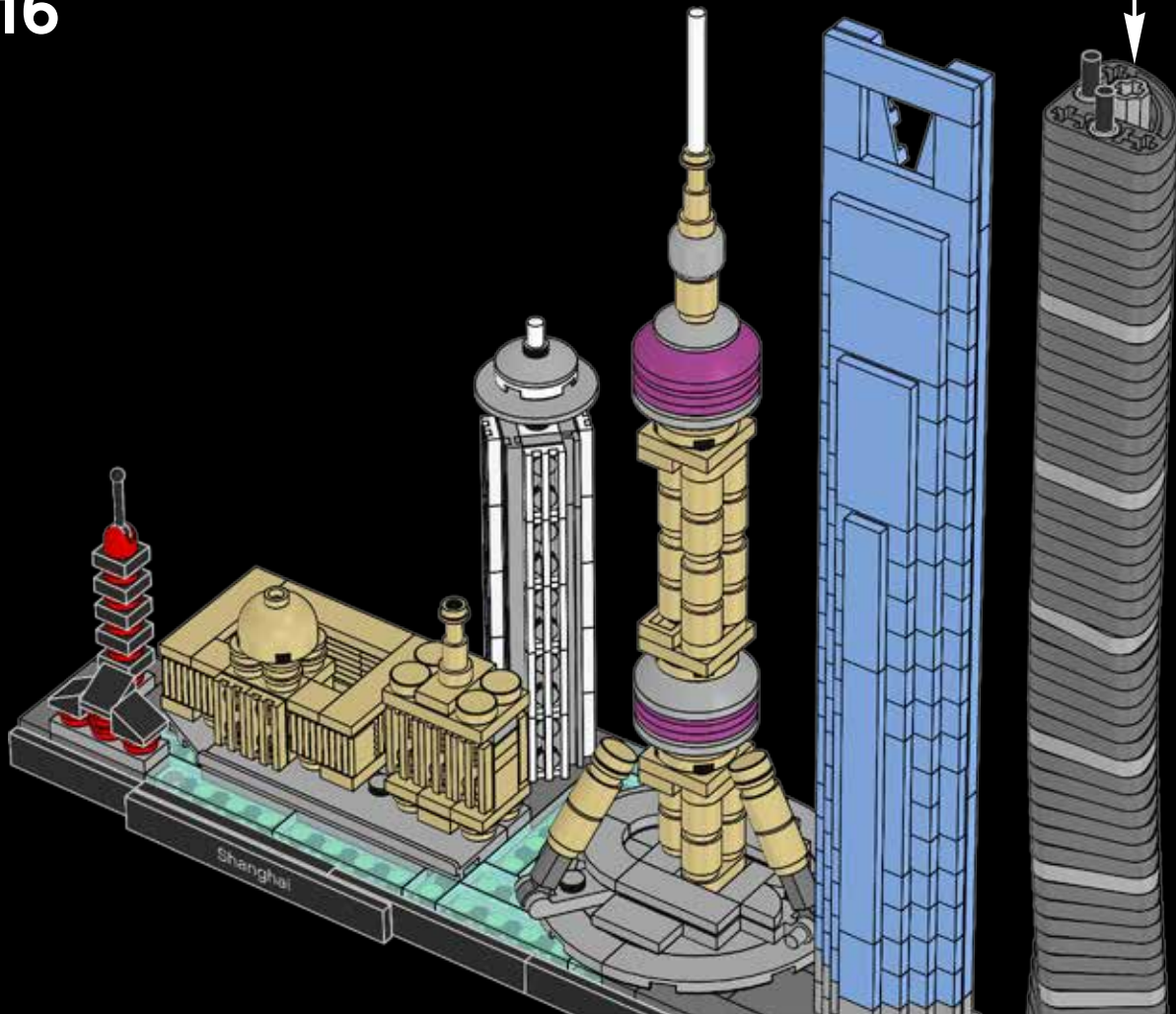



1x

117

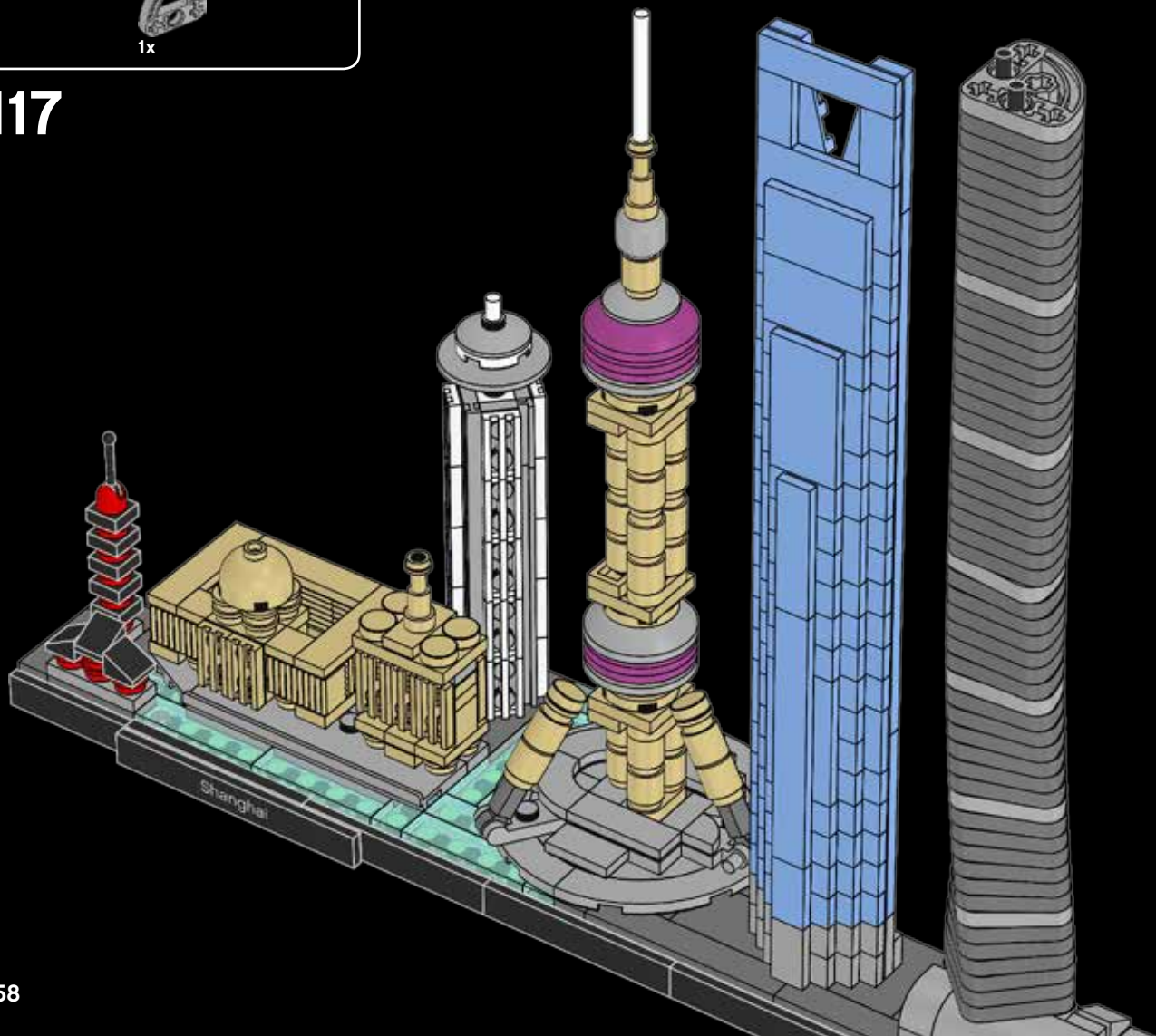



118

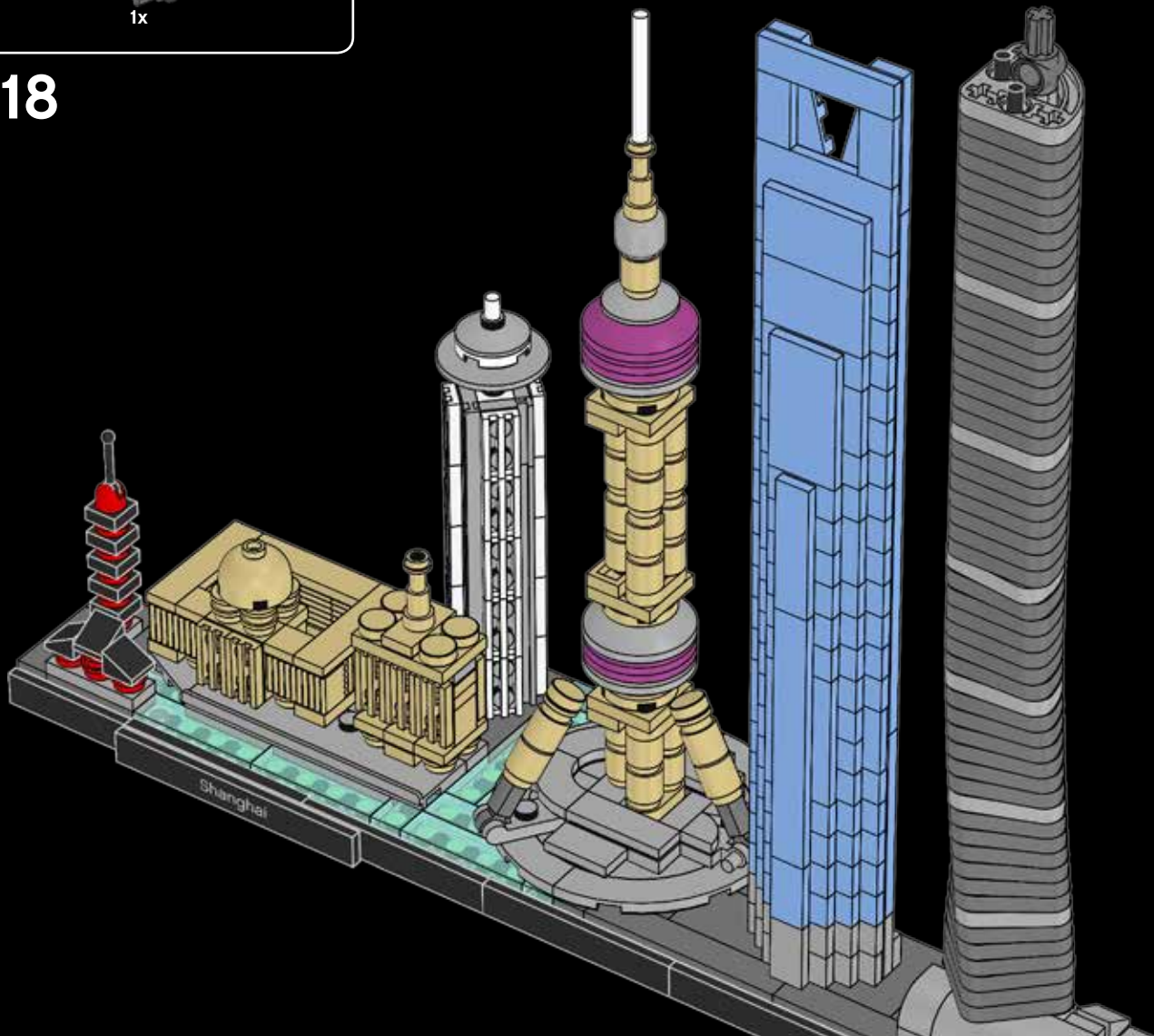

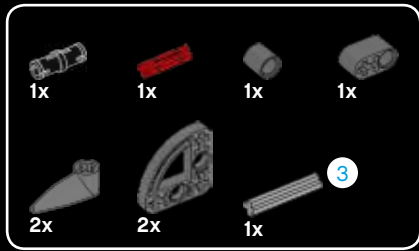

119

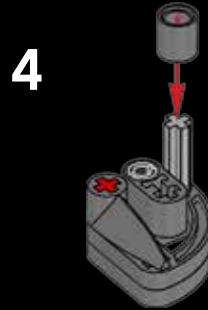
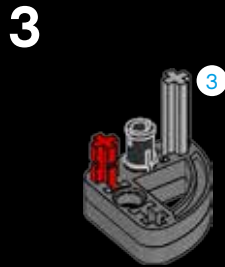
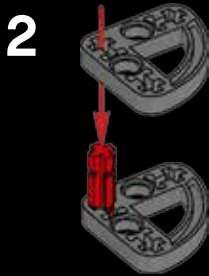
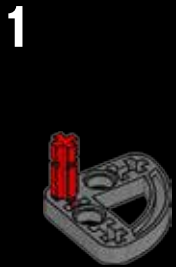

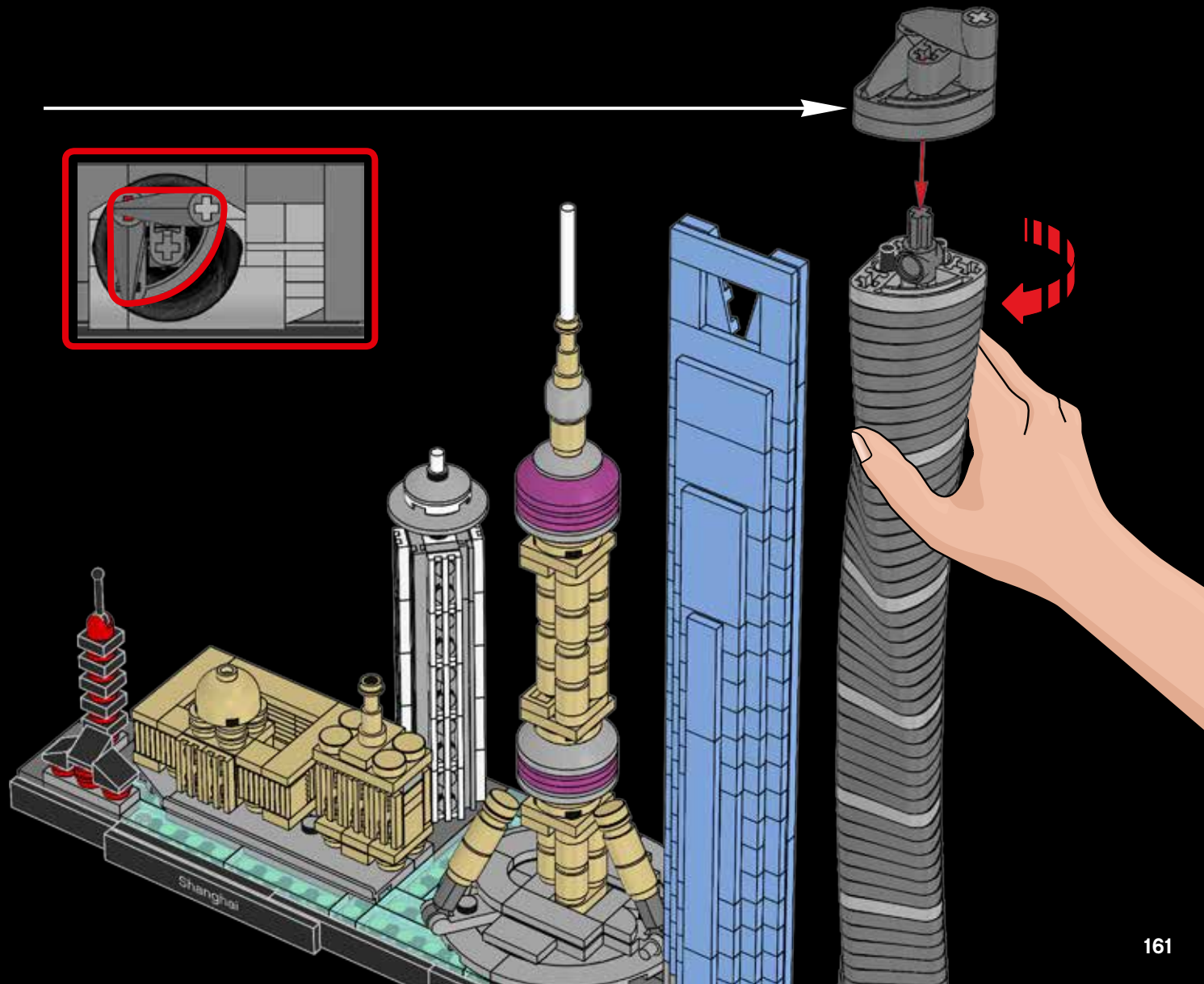

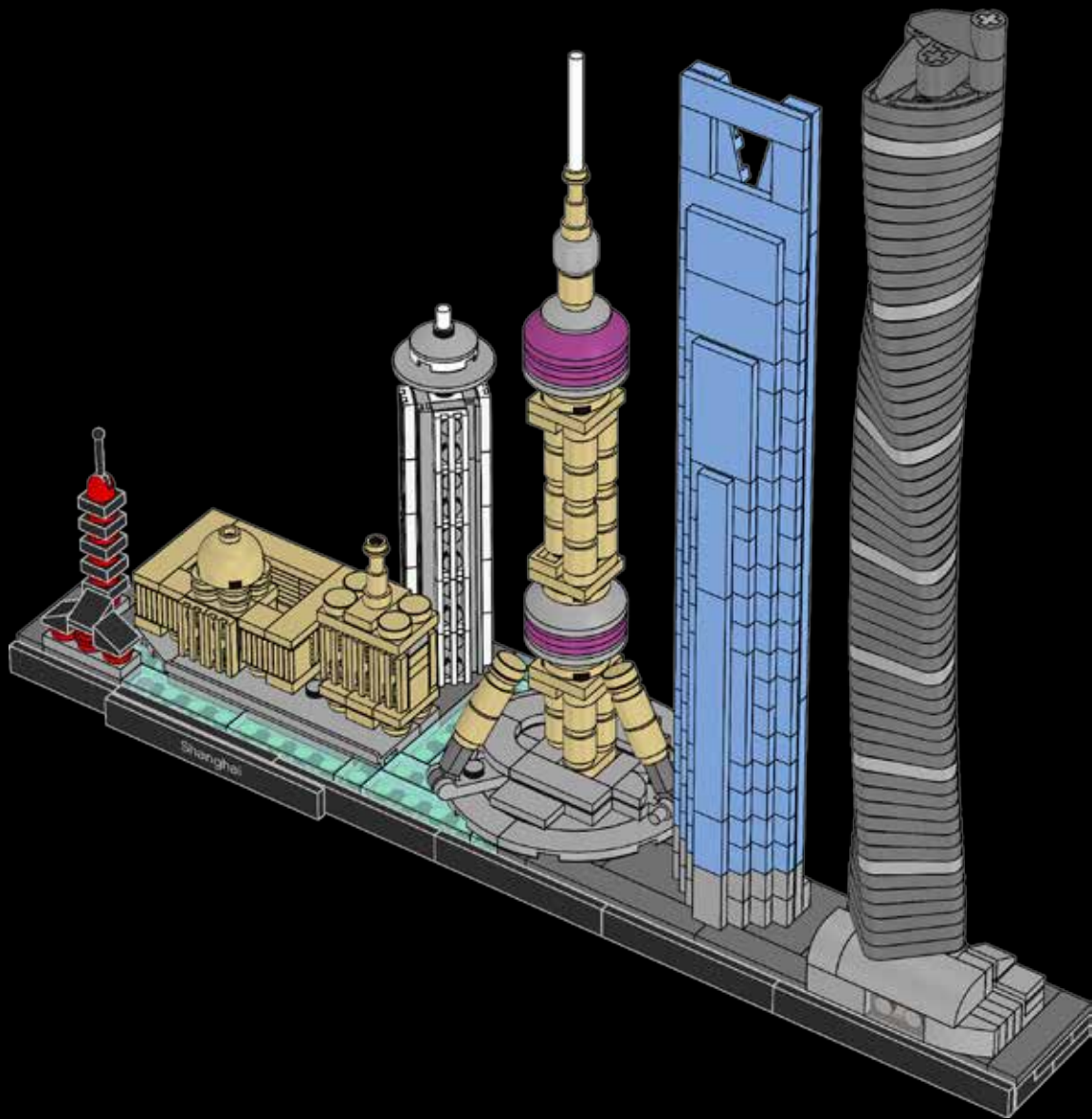



LEGO® Architecture – do you like it?

The LEGO Group would like your opinion on the new product you have just purchased. Your feedback will help shape the future development of this product series. Please visit:

[LEGO.com/productsurvey](https://www.lego.com/productsurvey)

By completing our short feedback survey, you will be automatically entered into a drawing to win a LEGO® prize.

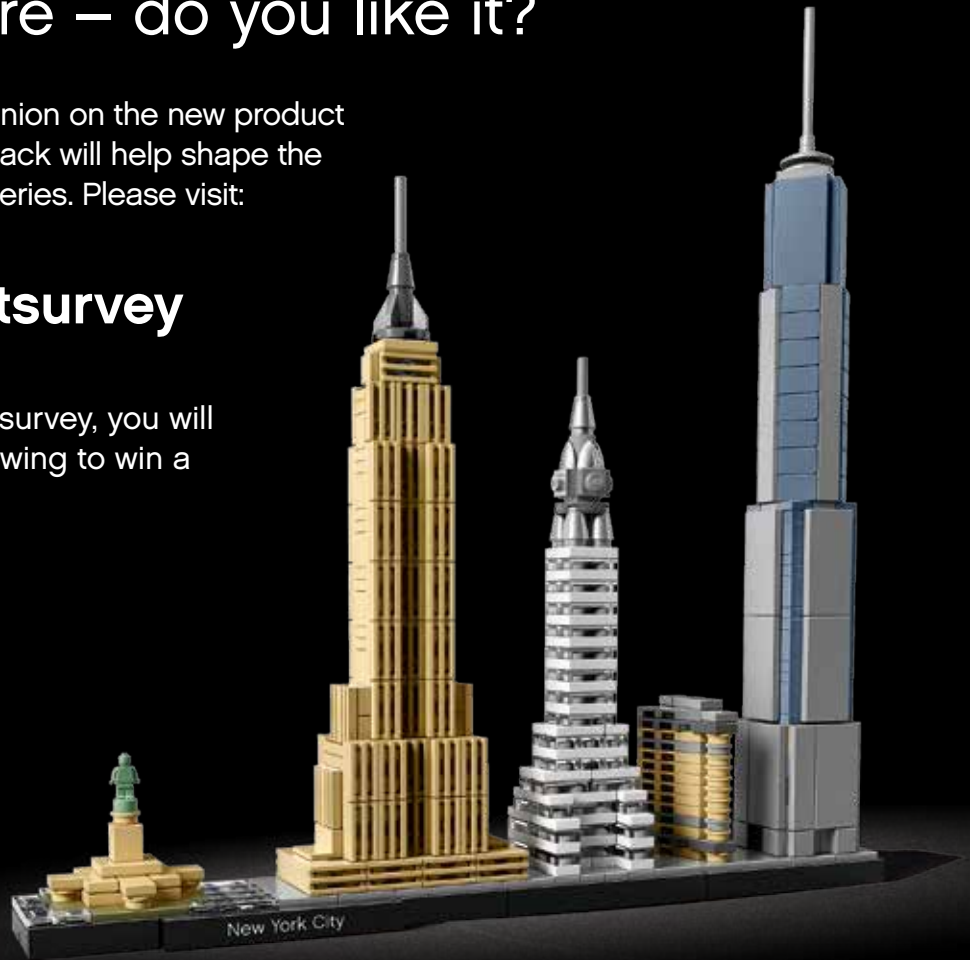

See website for official rules and details. Open to all countries where not prohibited.

Aimez-vous LEGO® Architecture ?

Le Groupe LEGO aimerait connaître votre opinion sur le produit que vous venez d'acheter. Vos commentaires nous aideront à concevoir les futurs produits de cette gamme. Veuillez visiter :

[LEGO.com/productsurvey](https://www.lego.com/productsurvey)

En remplissant ce court sondage sur le produit, vous serez automatiquement inscrit à un tirage au sort pour gagner un prix LEGO®.



Consultez le site Web pour obtenir le règlement officiel et les détails. Ouvert à tous les résidents des pays autorisés.

LEGO® Architecture: ¿te gusta?

The LEGO Group quiere conocer tu opinión acerca del nuevo producto que acabas de comprar. Tus comentarios nos ayudarán a dar forma a los futuros productos de esta serie.

Visita:

[LEGO.com/productsurvey](https://www.lego.com/productsurvey)

Al contestar esta breve encuesta de opinión, participarás automáticamente en el sorteo de un producto LEGO®.



Consulta las reglas oficiales y demás información en el sitio web.
Válido en todos los países en los que esta actividad no esté prohibida.

References

Références

Referencias

*Pictures -
Images -
Fotografias -*

© Shutterstock

© Offset

@ Radisson Blu Hotel Shanghai New World

@ Shanghai World Financial Center

@ Shanghai Tower

*Text -
Texte -
Textos -*

www.china.org

www.swfc-shanghai.com

Customer Service
Kundenservice
Service Consommateurs
Servicio Al Consumidor
LEGO.com/service or dial



00800 5346 5555 : 



1-800-422-5346 : 

LEGO® Architecture

The LEGO® Architecture series creatively captures the essence of many of the world's most iconic landmarks while giving you an enjoyable and engaging LEGO building experience.

Whether your interest is in travel, design, history or architecture, these sets are a physical memento of a great trip abroad, a famous building you know well, or a city you still dream of visiting.

Every LEGO Architecture set is designed to be displayed. Much more than just a photo, building and displaying your model on your desk, in the bookcase or on the shelf, lets you be transported every time you admire the view.

Follow us on  

Adam Reed Tucker is the co-developer of the LEGO Architecture product line.





LEGO® Architecture

La série LEGO® Architecture capture l'essence de nombreux monuments parmi les plus célèbres du monde tout en vous offrant une expérience agréable et stimulante de construction LEGO.

Que votre intérêt porte sur les voyages, le design, l'histoire ou l'architecture, ces ensembles constituent un souvenir tangible d'un voyage mémorable, d'un célèbre bâtiment que vous connaissez bien ou d'une ville que vous rêvez de visiter.

Chaque ensemble LEGO Architecture est conçu pour être exposé. Construire votre modèle et l'exposer sur votre bureau, une bibliothèque ou une tablette vous fera voyager à chaque coup d'œil, bien plus qu'une simple photo ne pourrait le faire.

Suivez-nous sur  



Adam Reed Tucker est le codéveloppeur de la gamme de produits LEGO Architecture.

LEGO® Architecture

La línea LEGO® Architecture captura con creatividad la esencia de muchos de los monumentos más populares del mundo y pone a tu alcance una experiencia de construcción gratificante y cautivadora con el sello característico de LEGO.

Ya sea que sientas atracción por los viajes, el diseño, la historia o la arquitectura, estos sets expresan físicamente tus recuerdos de aquel fantástico viaje al extranjero, ese famoso edificio que conoces tan bien o la ciudad que sueñas con visitar algún día.

Todos los sets LEGO Architecture están diseñados para decorar. Mucho más que una simple fotografía, construir y exponer un modelo en tu escritorio, un librero o una repisa te traslada a otro lugar al admirar las vistas.

Síguenos en  

Adam Reed Tucker es el codesarrollador de la línea de productos LEGO Architecture.



Celebrate the world of architecture and collect all the models

Célébrez le monde de l'architecture et collectionnez tous les modèles

Celebra el mundo de la arquitectura y colecciona todos los modelos

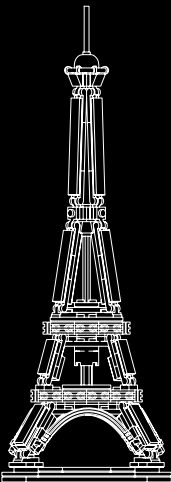

21019
The Eiffel Tower
La tour Eiffel
La Torre Eiffel

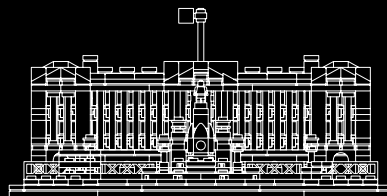

21029
Buckingham Palace
Le palais de Buckingham
Palacio de Buckingham

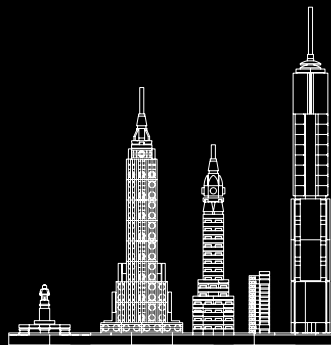

21028
New York City
New York
Nueva York



21032
Sydney
Sidney

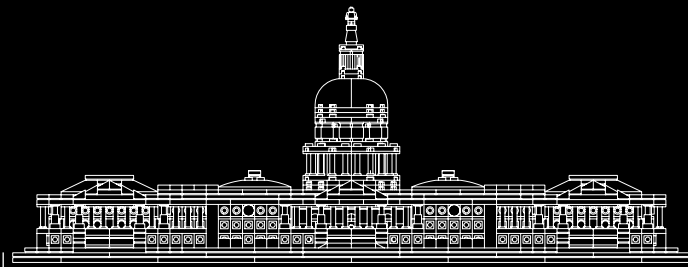

21030
United States Capitol Building
Le Capitole des États-Unis
Edificio del Capitolio de Estados Unidos



21033
Chicago

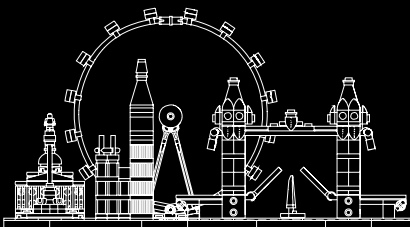

21034
London
Londres

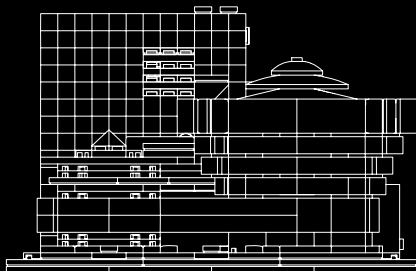

21035
Solomon R. Guggenheim Museum®
Musée Solomon R. Guggenheim®
Museo Solomon R. Guggenheim®

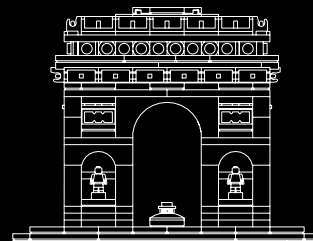

21036
Arc De Triomphe
L'Arc de Triomphe
Arco del Triunfo



1x
4125554



4x
4111971



1x
474001



1x
6093053



20x
241201



7x
6173116



3x
6116602



25x
4117070



17x
4161734



7x
6139649



4x
4213568



2x
6013938



4x
6212758



3x
6115248



2x
4125253



1x
6191654



8x
4655900



8x
4124456



4x
6092587



1x
6024495



6x
4113917



2x
6060850



3x
4114084



1x
6132769



3x
4121921



1x
4118790



3x
4113233



3x
4550324



9x
614121



1x
4142865



2x
6130005



2x
4206482



4x
4239601



4x
4140587



1x
74335



3x
6188646



3x
4504382



7x
302426



4x
4550017



3x
4121715



1x
6178922



3x
302326



2x
302226



3x
6052126



3x
302126



2x
370526



1x
243126



4x
4599499



3x
371026



2x
302026



2x
366626



3x
663626



1x
6101857



2x
379526



2x
4653049



1x
6215388



1x
416226

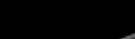

2x
4234438

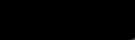

1x
4514845

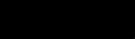

3x
244526

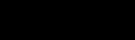

2x
6057525

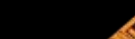

1x
4654448



4x
302328



1x
4107758



1x
302028



1x
366628



2x
6000070



2x
4116671



1x
6021999



5x
6217587



7x
6075208



3x
6051918



11x
4586557



1x
6172408



1x
6172410



1x
4179825



3x
4168345



62x
6092601



2x
6133855



32x
6211970



6x
6211973



2x
4597999



4x
6146503



4x
4179829



1x
6117716

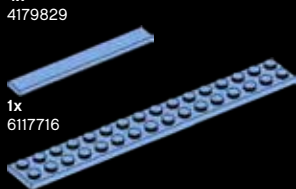

2x
6024127



1x
4211585



4x
6176433



1x
4521921



8x
4211399



2x
4211389



3x
4211415



1x
6004990



4x
4211568



1x
6163478



6x
4594238



2x
4211512



2x
4531184



2x
4211775



3x
4512360



2x
6144138



1x
6028813



2x
6163990



6x
6066097



1x
4211519



7x
4211398



8x
4211414



1x
6004990



4x
4211568



1x
4667578



1x
4211445



1x
4260409



2x
6081975



1x
4211438



4x
6163989



1x
6015349



1x
6015349



1x
6015349



1x
6015349



1x
6015349

3



1x
4211815



2x
4515369



3x
6070564



4x
6211969



4x
4211429



2x
4558169



3x
4211445



1x
4260409



2x
6081975



1x
4211438



4x
6163989



1x
6015349



1x
6015349



1x
6015349



1x
6015349



1x
6015349



1x
6015349



4x
4211498



1x
4211406



1x
4222019



3x
6015890



3x
6100030



1x
6005331



1x
6006141



7x
4211052



2x
6217813



50x
6093835



2x
4211094



1x
6167281



2x
4211133



4x
4568734



4x
6187008



6x
4211053



2x
4211065



3x
4210651



1x
4222042



1x
4529685

Customer Service
Kundenservice
Service Consommateurs
Servicio Al Consumidor
LEGO.com/service or dial



: 00800 5346 5555

: 1-800-422-5346

