



Architecture

21032

Sydney

Australia

Sydney

Australie

Sídny

Australia



LEGO.com/architecture/booklet

Sydney

As Australia's largest and most famous city, Sydney encompasses both striking modern architecture and many of the country's most important historical landmarks.

Founded as a colony in 1788, the city now stretches around the world's largest natural harbor, reaching towards the stunning Blue Mountains in the west.

One third of the city's growing population of 4.8 million inhabitants were born overseas, making Sydney one of the most varied and vibrant cities in the world and a magnet for over three million international visitors every year.

*["If Paris is the city of lights,
Sydney is the city of fireworks."]*

Baz Luhrmann









Ralph Alphonso

Sydney Opera House

The Sydney Opera House is a masterpiece of modern architecture, and one of the most celebrated buildings of the 20th century. Set against the stunning backdrop of Sydney Harbor, its shells appear like billowing sails filled by the sea winds. Since its opening in 1973, the Opera House has become one of the world's busiest performing arts centers, welcoming over 8 million visitors a year and staging almost 2,000 performances annually.



Sydney Harbour Bridge

The Sydney Harbour Bridge, also affectionately known as the 'Coathanger', was opened on March 19th, 1932, after six years of construction. This famous Sydney symbol is constructed in steel and contains six million hand-driven rivets. The top of

the arch is 439 ft. (134 m) above sea level. The 160 ft. (49 m) wide deck makes Sydney Harbour Bridge the widest long-span bridge in the world.



Sydney Tower

The Sydney Tower has been an integral part of the Sydney skyline for over 30 years. The 1,014 ft. (309 m) tall tower is the tallest structure in Sydney and its 420 windows allow the perfect view of the city. If you spent the whole day in the tower's observation deck, you would be the first person to see the sun rise over Sydney and the last to see it set.







Deutsche Bank Place

Although a recent addition to the Sydney skyline, the Deutsche Bank Place is nevertheless one of the city's most distinctive structures. Completed in 2005, its unusual design was guided by a narrow building site and the need to ensure sufficient sunlight for the surrounding public spaces. Constructed in concrete, glass and steel, the 790 ft. (240 m) building was designed by the internationally renowned architects Foster + Partners.



Photo courtesy of Investa

Sydney

Sydney, la plus grande et la plus célèbre ville d'Australie, réunit une architecture moderne spectaculaire et nombre des édifices historiques les plus importants du pays.

Fondée en tant que colonie en 1788, la ville s'étend aujourd'hui autour de la plus grande baie naturelle du monde vers les spectaculaires montagnes Bleues à l'ouest.

Un tiers de la population croissante de cette ville de 4,8 millions d'habitants est né à l'étranger, faisant de Sydney l'une des villes les plus cosmopolites et les plus dynamiques au monde, attirant plus de trois millions de visiteurs internationaux chaque année.

[« *Si Paris est la ville lumière,
Sydney est la ville
feux d'artifice.* »]

Baz Luhrmann









Ralph Alphonso

Sydney Opera House

Le Sydney Opera House est un chef-d'œuvre de l'architecture moderne et l'un des bâtiments les plus célèbres du 20^e siècle. Avec comme toile de fond la spectaculaire baie de Sydney, ses coquilles ressemblent à des voiles ondulantes gonflées par les vents marins. Depuis son inauguration en 1973, le Sydney Opera House est devenu l'une des salles de spectacles les plus actives au monde, accueillant plus de 8 millions de visiteurs par an et organisant presque 2 000 représentations chaque année.



Le pont du port de Sydney

Le pont du port de Sydney, aussi appelé affectueusement le « cintre », a été inauguré le 19 mars 1932 après six ans de construction. Ce célèbre symbole de Sydney est construit en acier et contient six millions de rivets fixés à la main. Le

haut de l'arche s'élève à 134 m au-dessus du niveau de la mer. Sa largeur de 49 m fait du pont du port de Sydney le pont à longue portée le plus large du monde.



La tour de Sydney

La tour de Sydney fait partie intégrante du paysage de Sydney depuis plus de 30 ans. Cette tour de 309 m est la structure la plus haute à Sydney et ses 420 fenêtres permettent d'avoir une vue imprenable sur la ville. Si vous passiez toute la journée dans le poste d'observation de la tour, vous seriez la première personne à voir le soleil se lever sur Sydney et la dernière à le voir se coucher.







Deutsche Bank Place

Ajout récent au paysage de Sydney, la Deutsche Bank Place est néanmoins l'une des structures les plus caractéristiques de la ville. Terminée en 2005, sa conception inhabituelle fut imposée par le site de construction étroit et le besoin d'assurer que les espaces publics aux alentours aient assez de lumière naturelle. Construit en béton, verre et acier, ce bâtiment haut de 240 m fut conçu par les architectes de renommée internationale Foster + Partners.



Sídney

Sídney, la ciudad más grande y popular de Australia, posee una notable arquitectura moderna y alberga también muchos de los monumentos históricos más importantes del país.

Fundada como colonia en 1788, la ciudad se extiende hoy día alrededor del mayor puerto natural del mundo, llegando hasta las impresionantes Montañas Azules por el oeste.

Un tercio de su creciente población, formada actualmente por 4,8 millones de habitantes, nació en otro país, lo que hace de Sídney una de las ciudades más variadas y vibrantes del mundo, y un foco de atracción para más de tres millones de visitantes internacionales cada año.

[*«Si París es la ciudad de las luces, Sídney es la ciudad de los fuegos artificiales».*]

Baz Luhrmann









Ralph Alphonso

Sydney Opera House

El Sydney Opera House es una auténtica obra maestra de la arquitectura moderna y uno de los edificios más celebrados del siglo XX. Con un telón de fondo tan magnífico como el puerto de Sídney, sus caparazones se asemejan a velas que ondean henchidas por los vientos marinos. Desde su inauguración en 1973, el Sydney Opera House se ha convertido en uno de los centros artísticos más activos del mundo, con más de 8 millones de visitantes recibidos cada año y casi 2.000 obras representadas anualmente.



Puente de la Bahía de Sídney

El Puente de la Bahía de Sídney, cariñosamente apodado «el perchero», fue inaugurado el 19 de marzo de 1932 tras seis años de construcción. Este popular símbolo de Sídney está hecho de acero y contiene seis millones de remaches

colocados a mano. La parte superior del arco alcanza 134 m sobre el nivel del mar. Los 49 m de ancho de su tablero lo convierten en el puente de trazado largo más ancho del mundo.



Torre de Sídney

La Torre de Sídney forma parte integral del horizonte de la ciudad desde hace más de 30 años. Esta construcción, de 309 m de altura, es la estructura más alta de Sídney, y sus 420 ventanas brindan una vista perfecta de la ciudad. Si alguien pasara un día entero en el mirador de la torre, sería la primera persona en ver salir el sol en Sídney y la última en verlo ponerse.



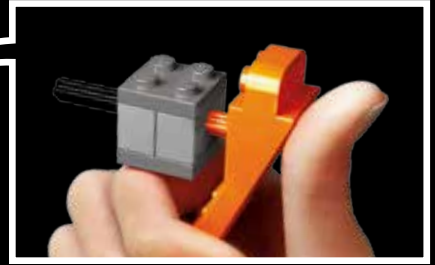
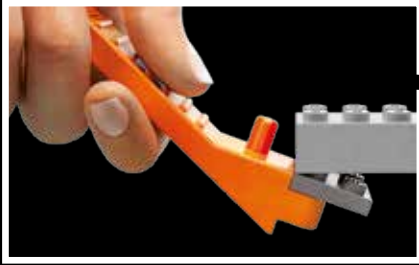




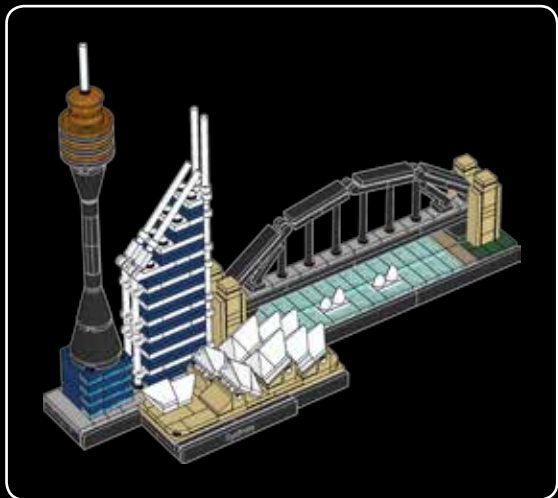
Deutsche Bank Place

A pesar de tratarse de una incorporación reciente al horizonte de Sídney, el Deutsche Bank Place es ya una de las estructuras más características de la ciudad. Completado en 2005, buena parte de su peculiar diseño se debe a la estrechez de su emplazamiento y a la necesidad de garantizar suficiente luz solar para los espacios públicos que lo rodean. Construido en concreto, cristal y acero, este edificio de 240 m fue diseñado por el estudio de arquitectos Foster + Partners, célebre a nivel internacional.



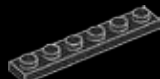
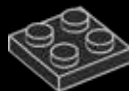


LEGO.com/brickseparator



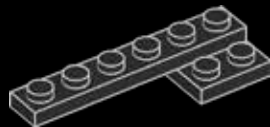
1x

1



1x

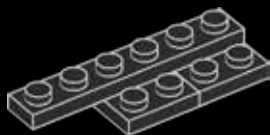
2

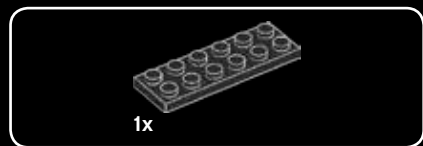




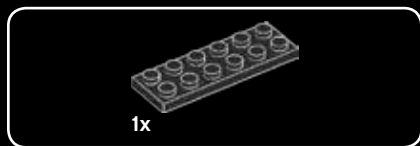
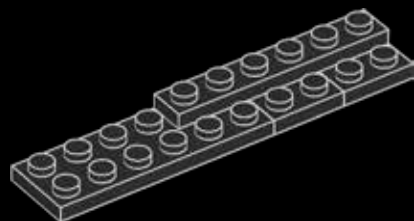
1x

3

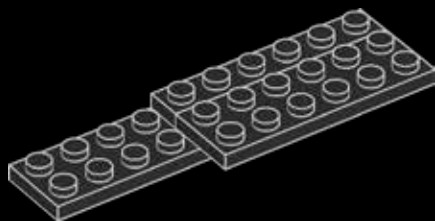




4



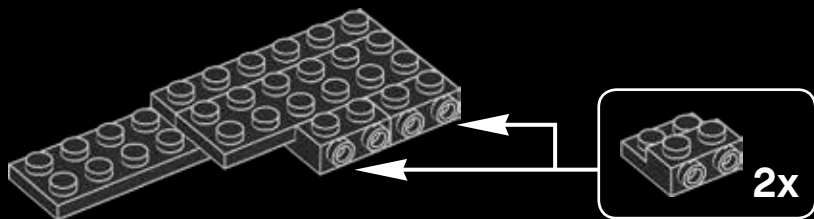
5





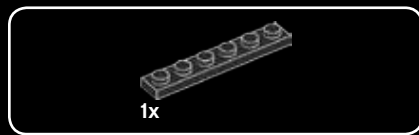
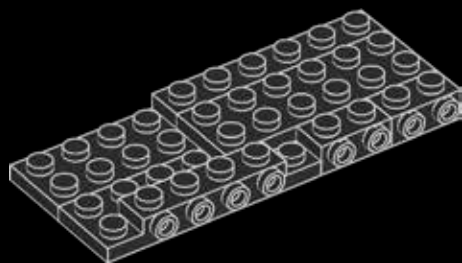
2x

6

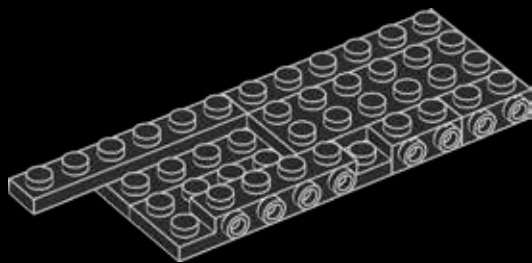


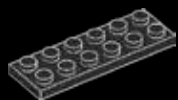


7



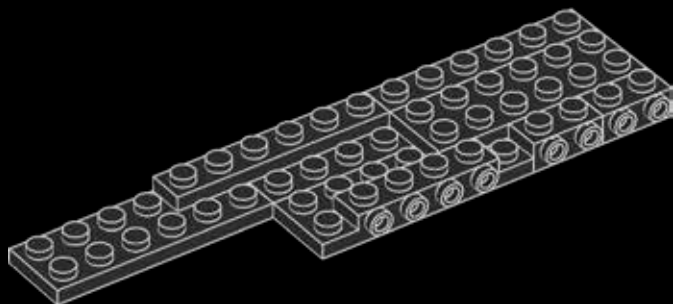
8

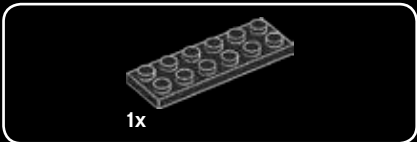




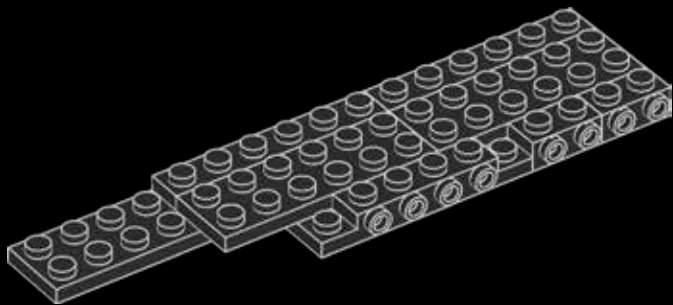
1x

9





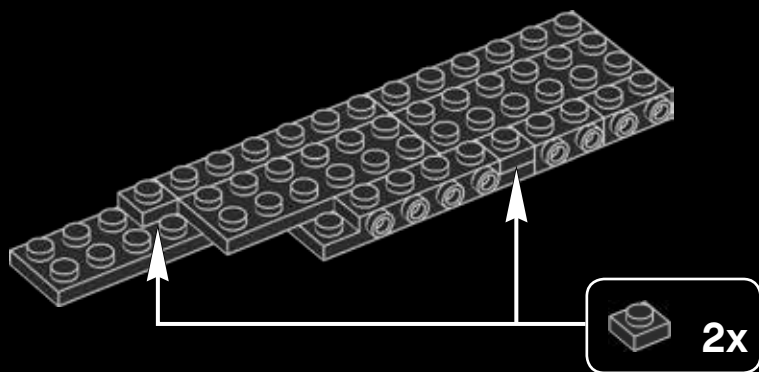
10

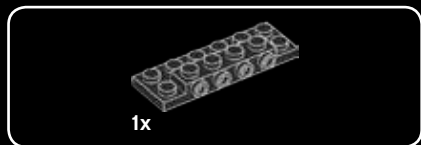




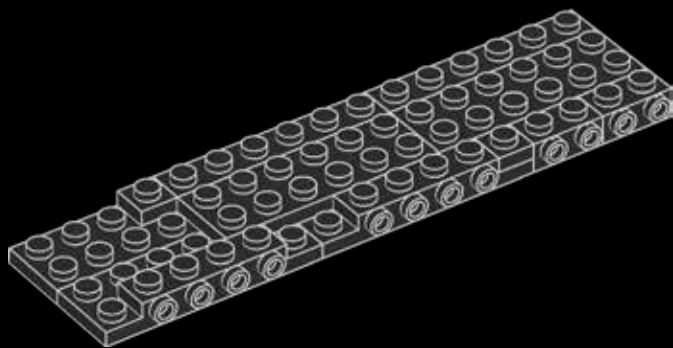
2x

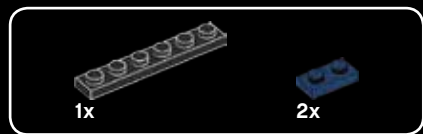
11



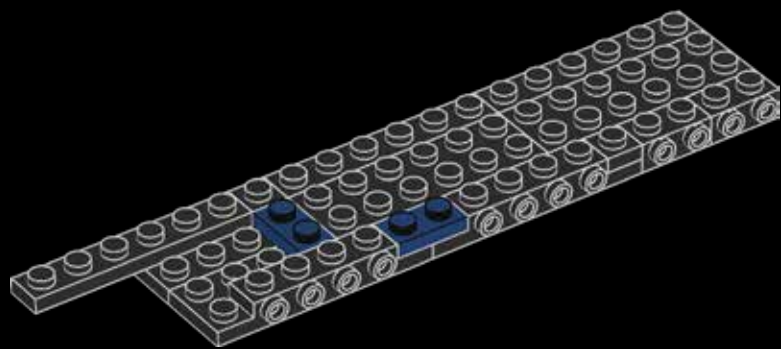


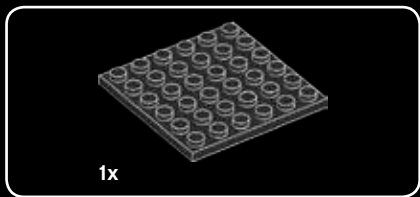
12



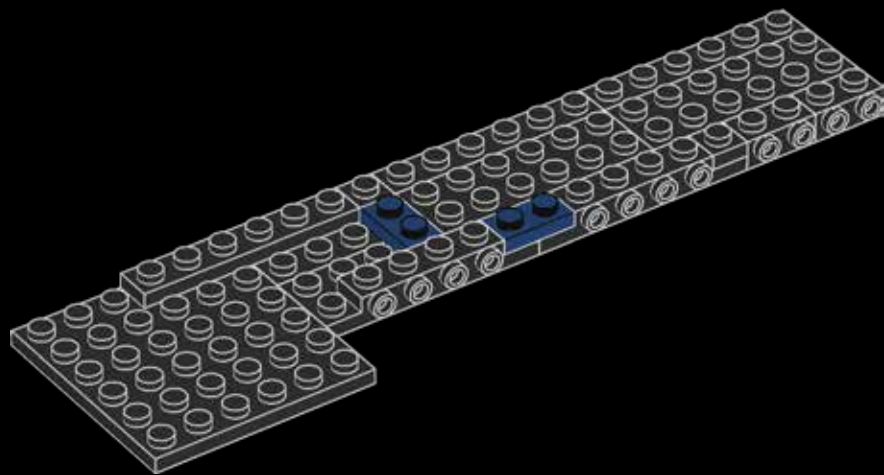


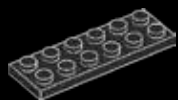
13





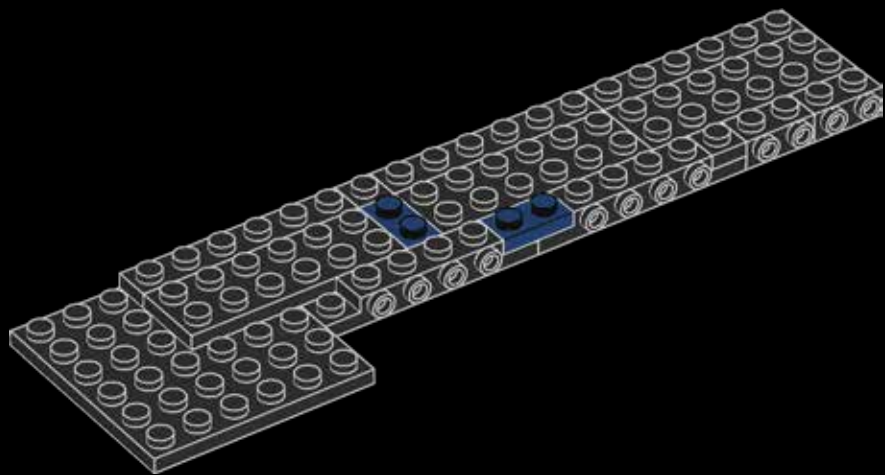
14

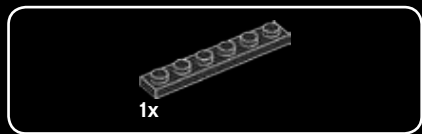




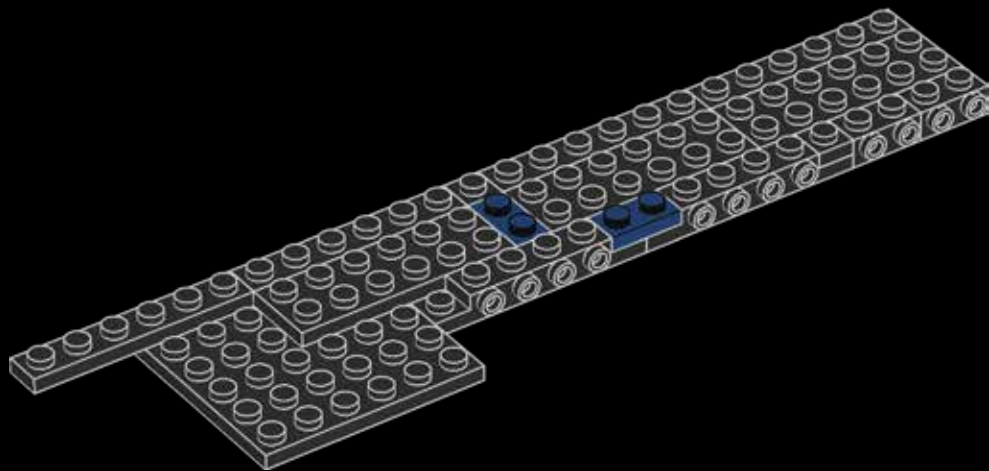
1x

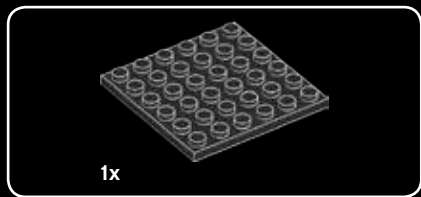
15



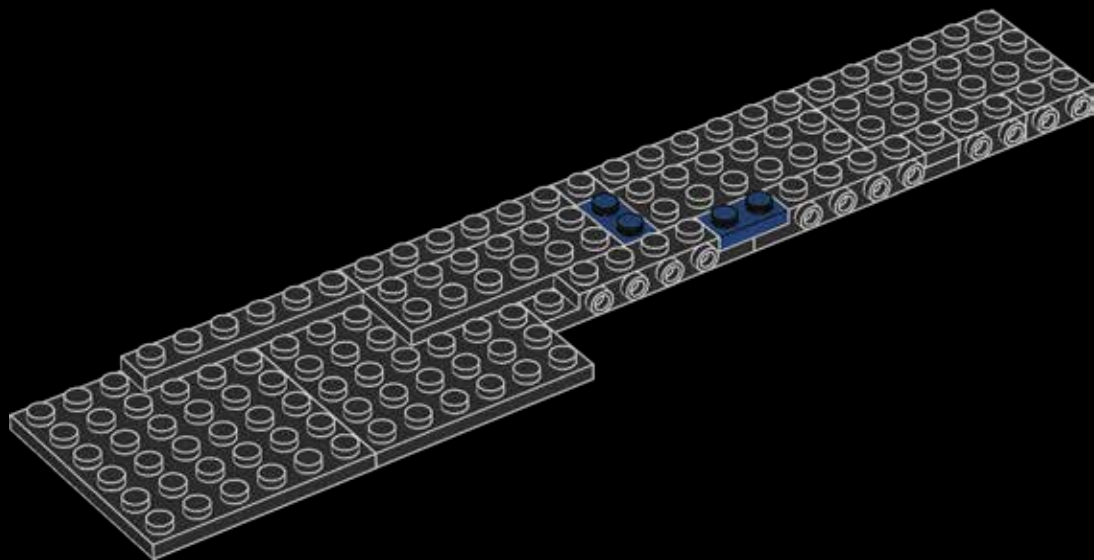


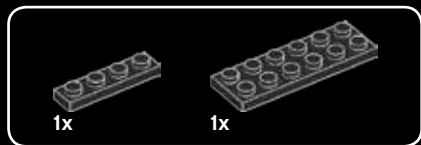
16



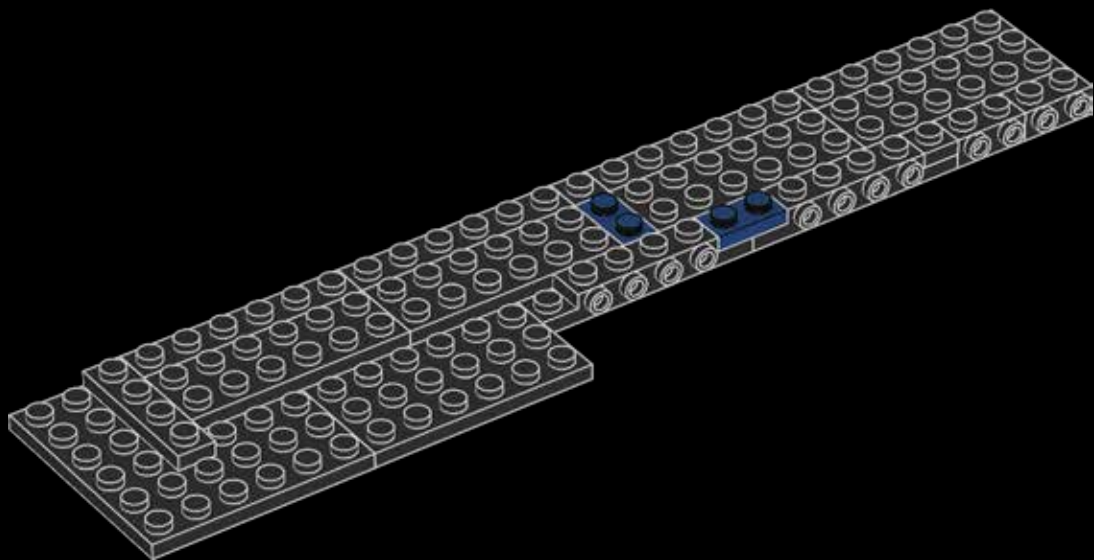


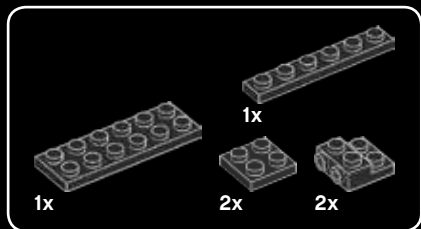
17





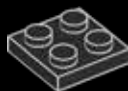
18



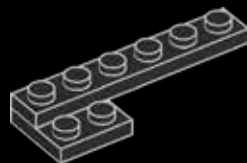


19

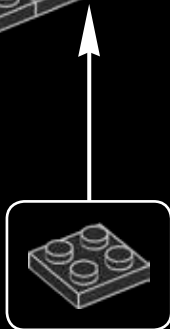
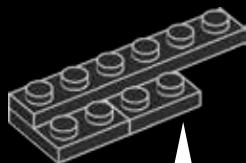
1



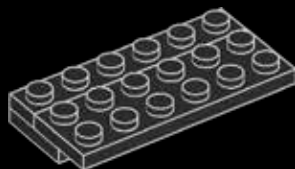
2



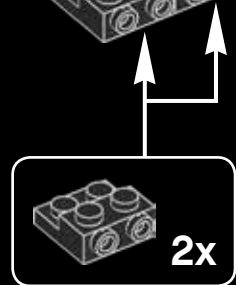
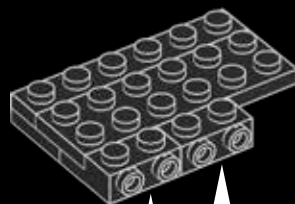
3

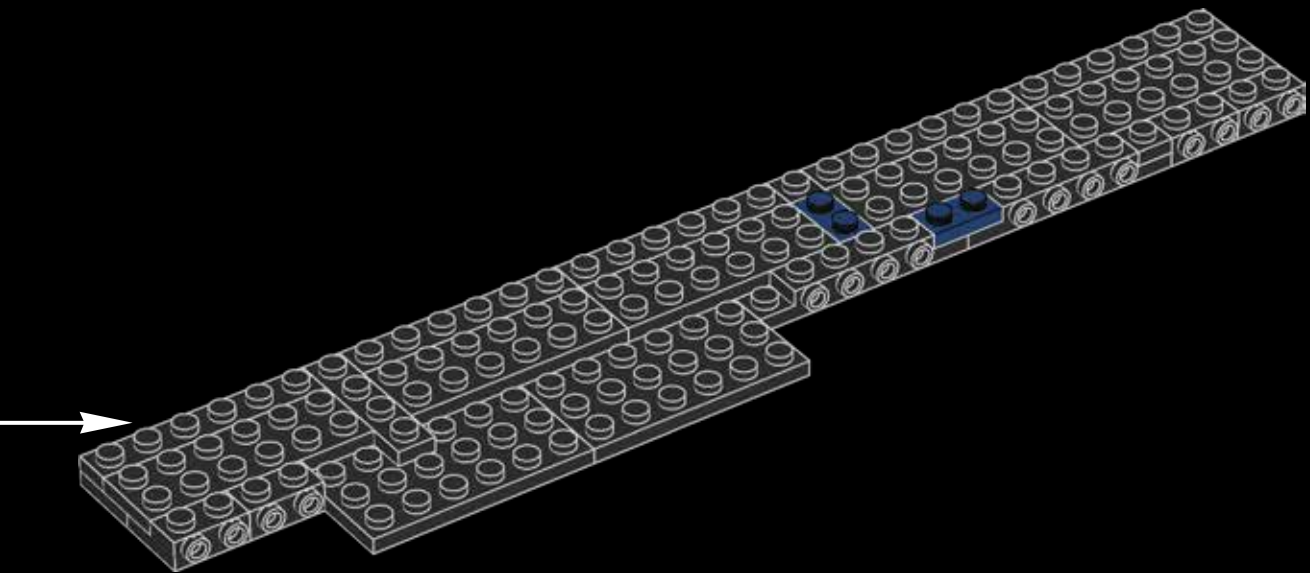


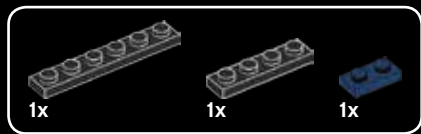
4



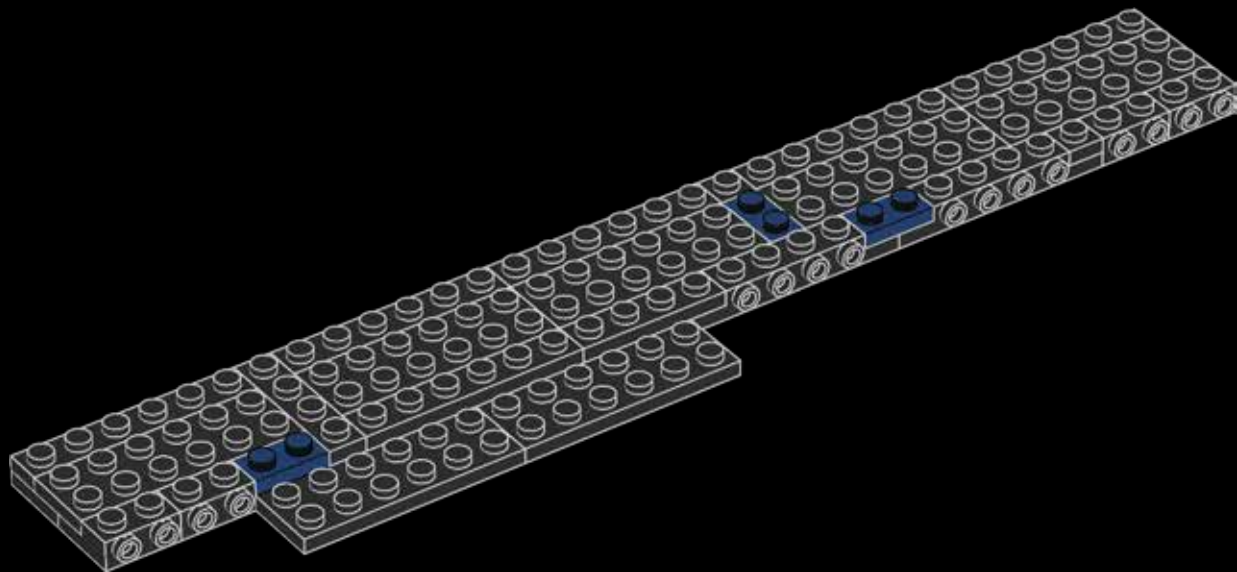
5







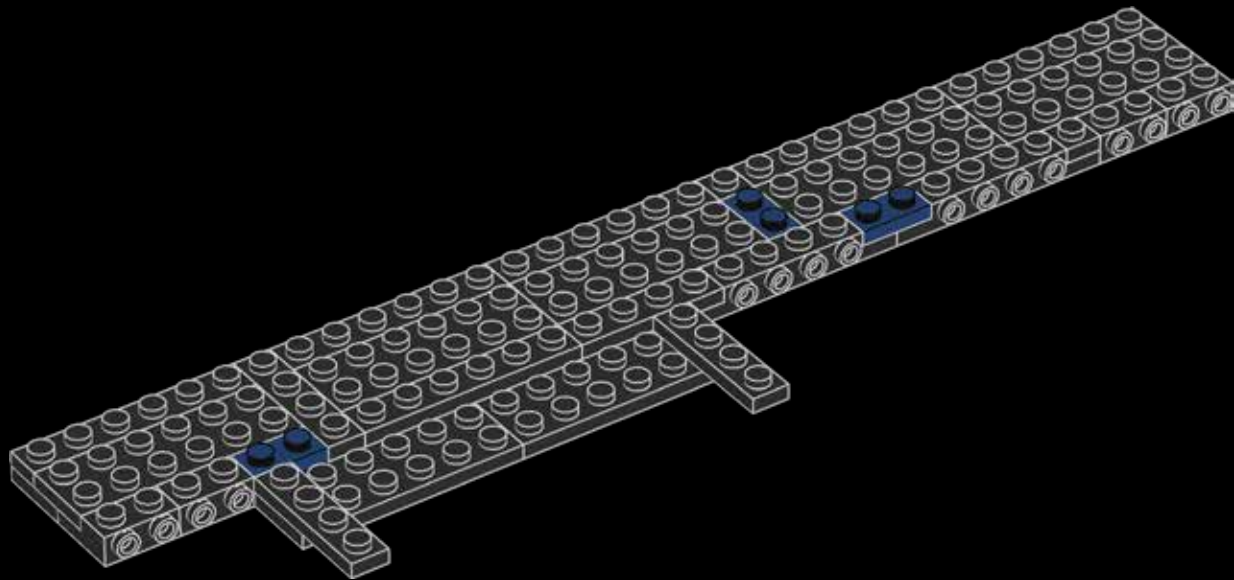
20

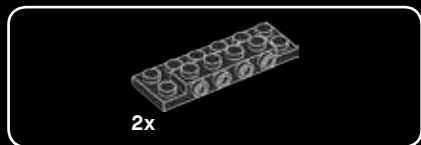




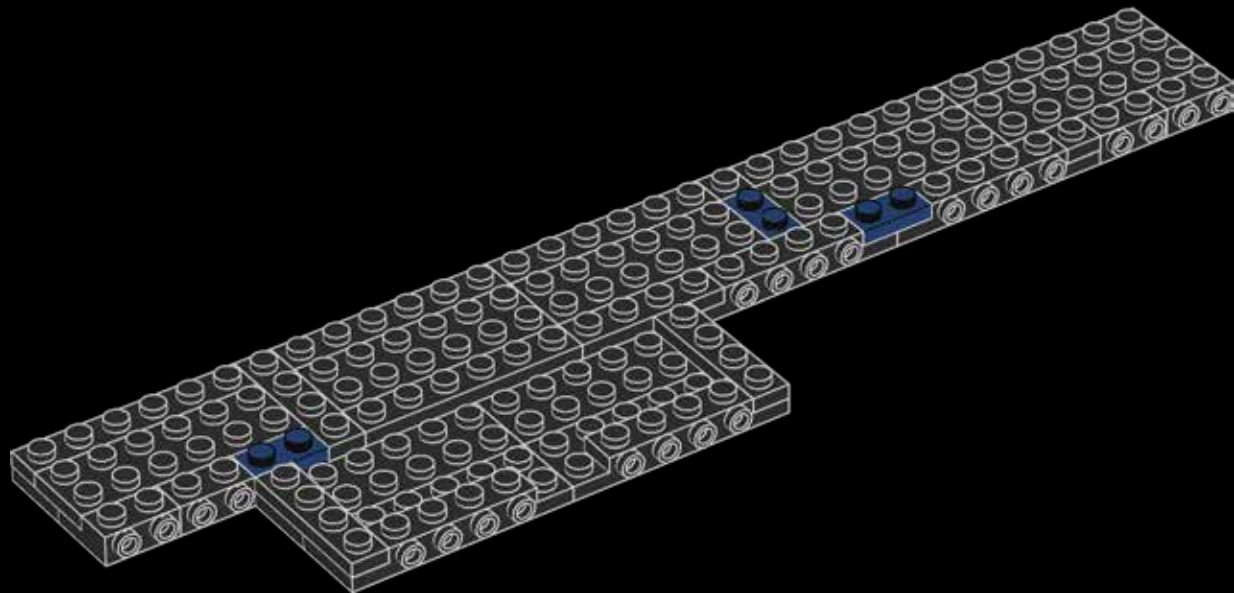
2x

21





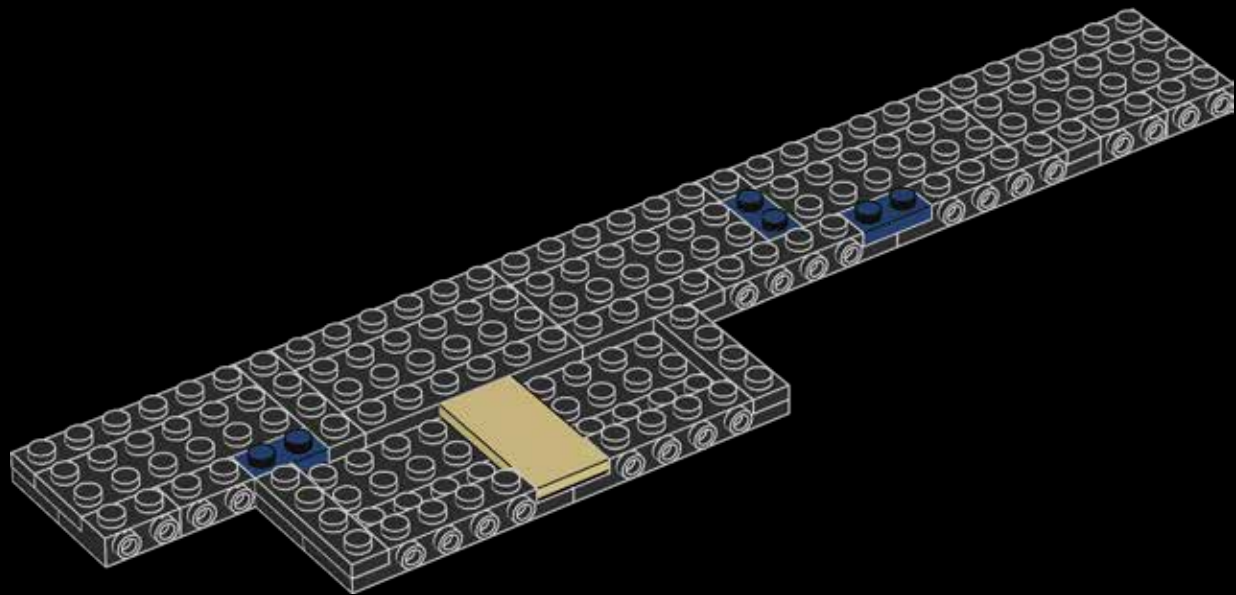
22



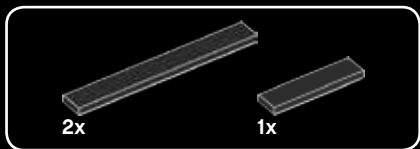


1x

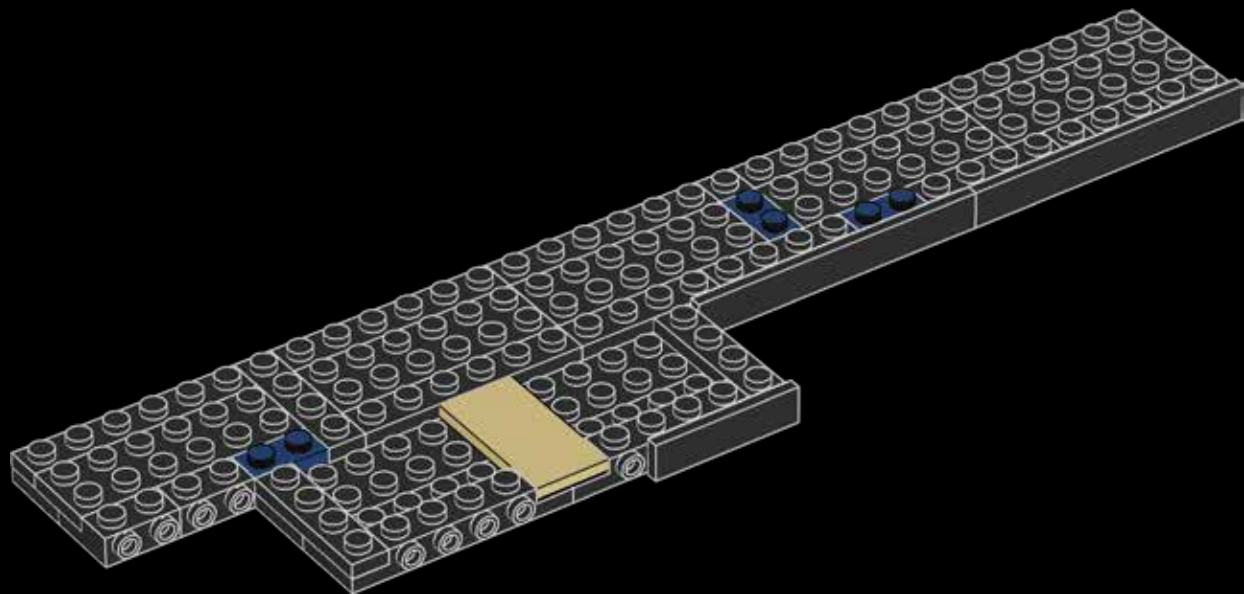
23

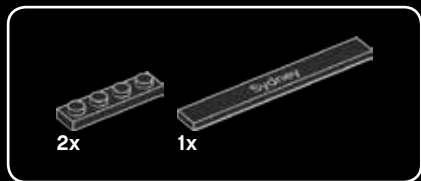


54



24





25

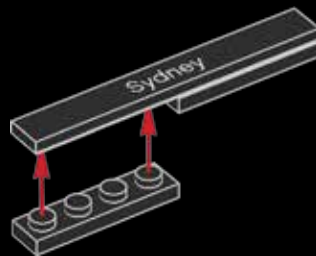
1

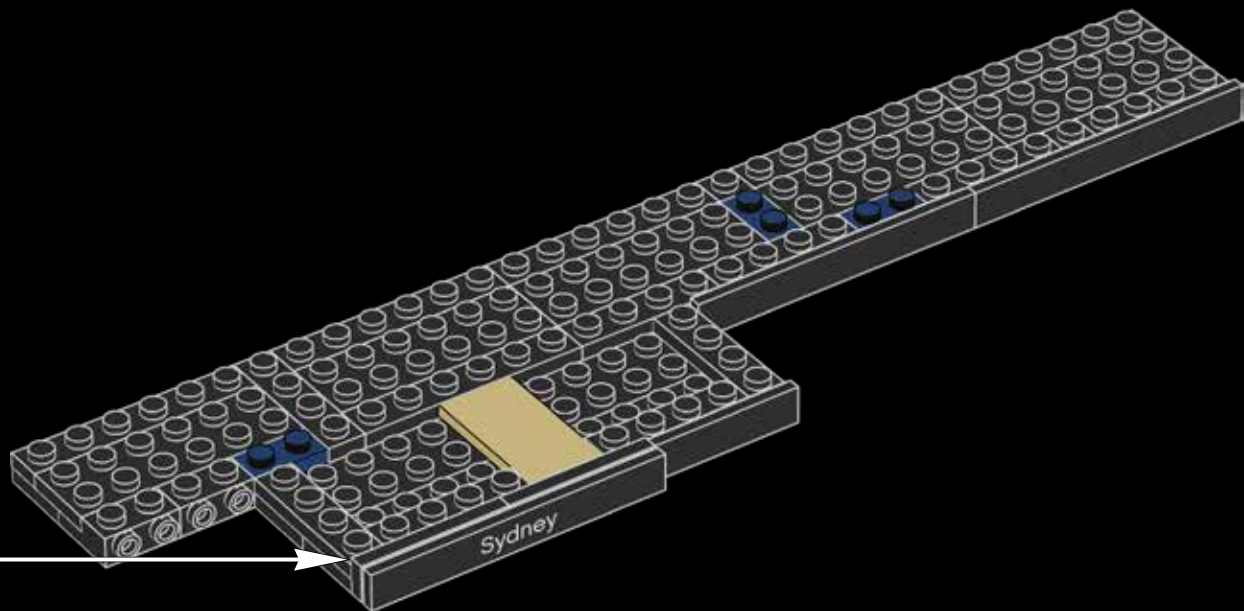


2



3

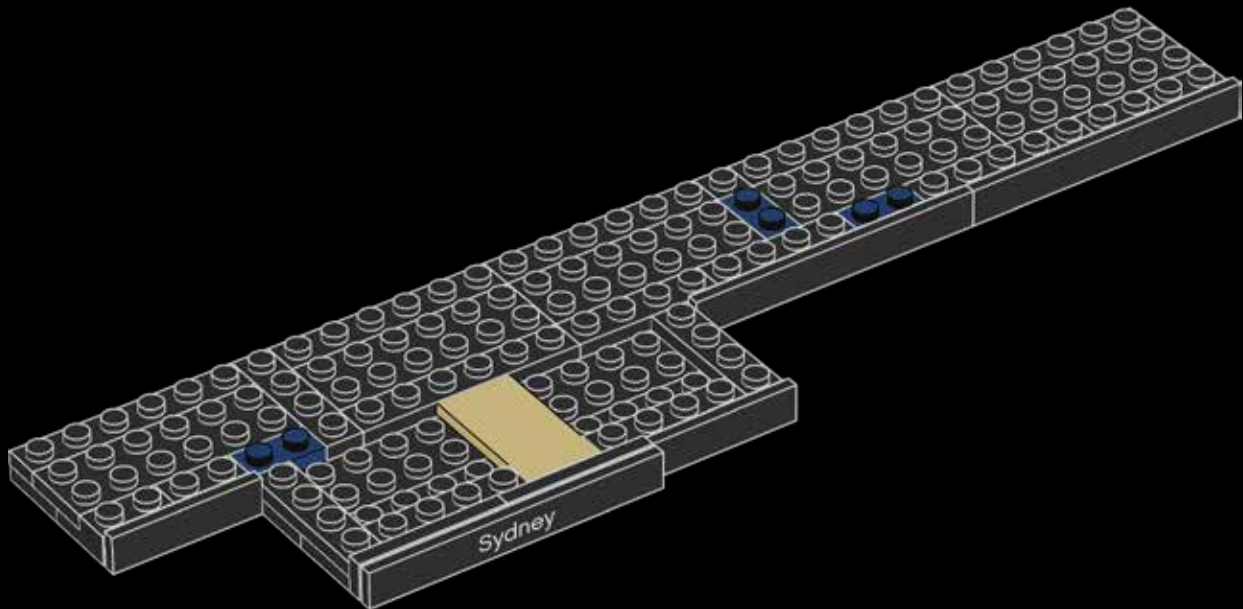




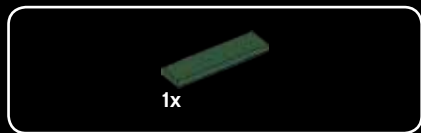


1x

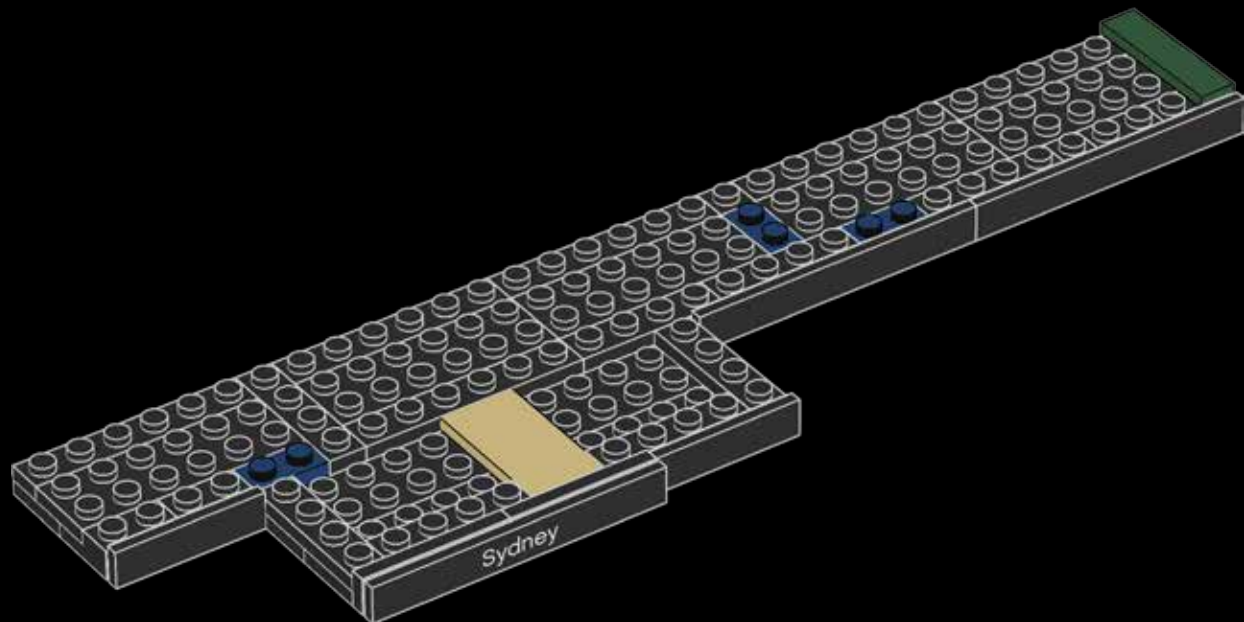
26

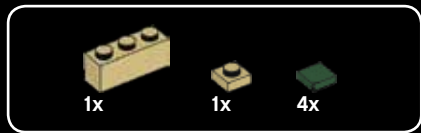


58

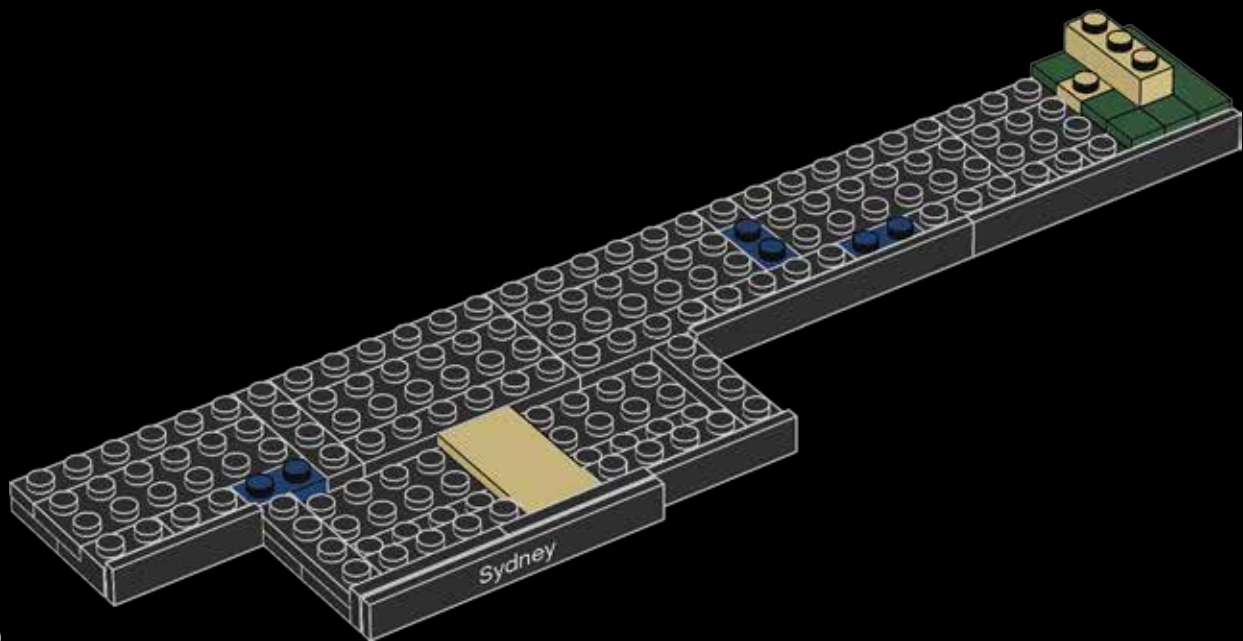


27





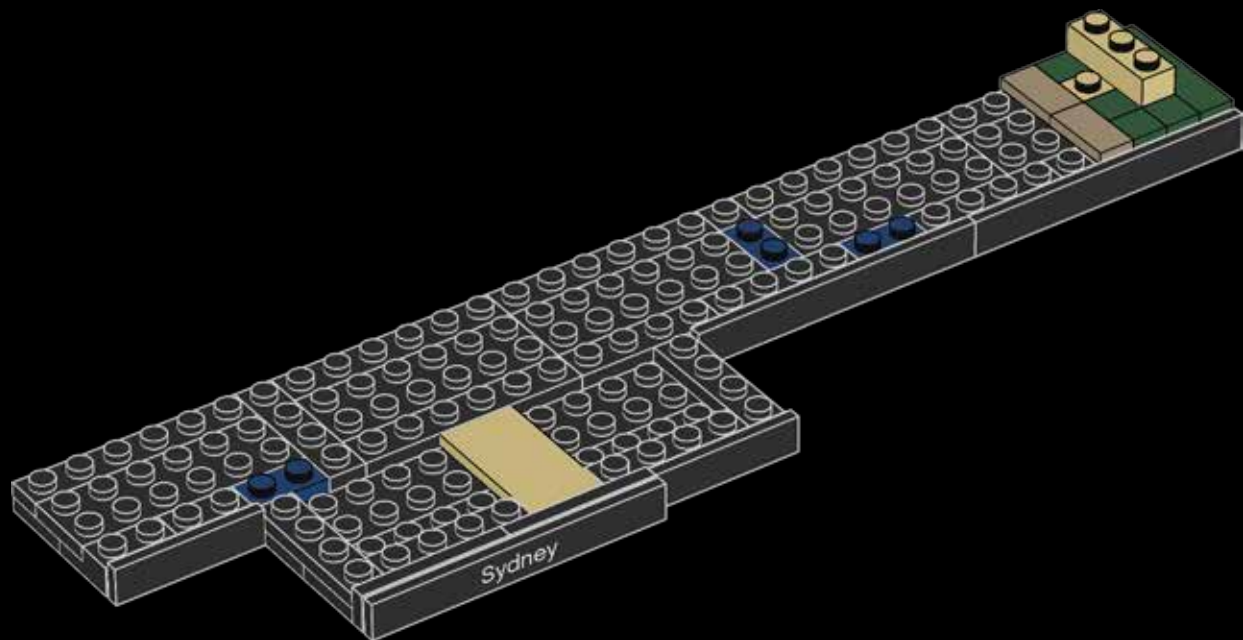
28





2x

29



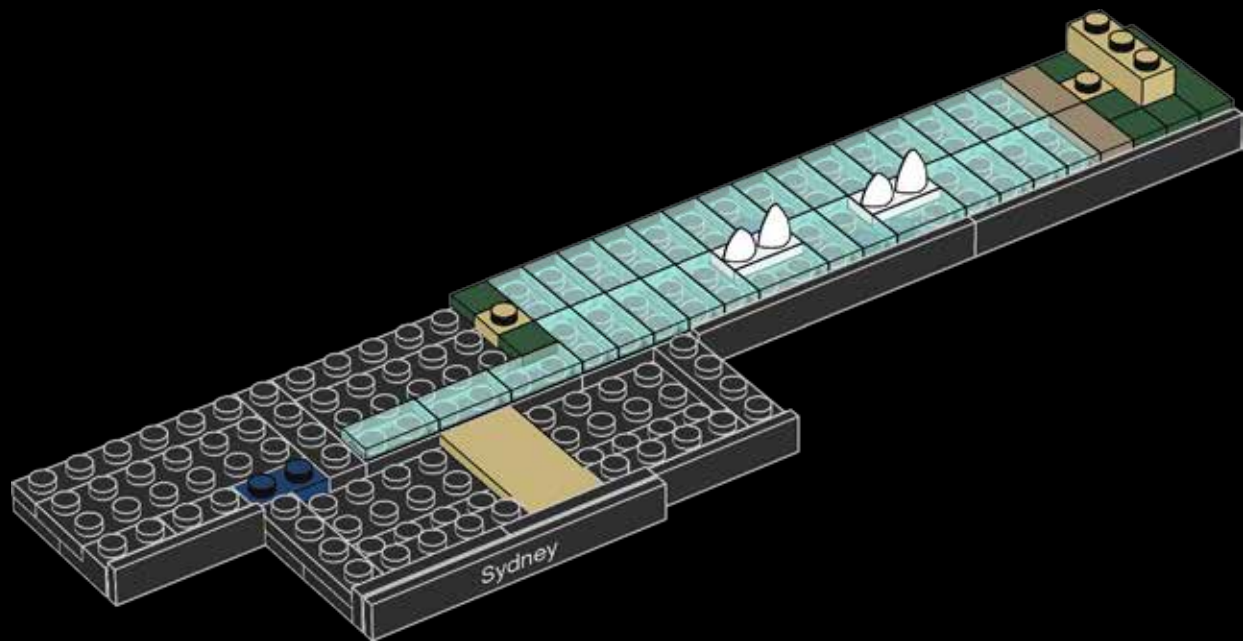


1x



2x

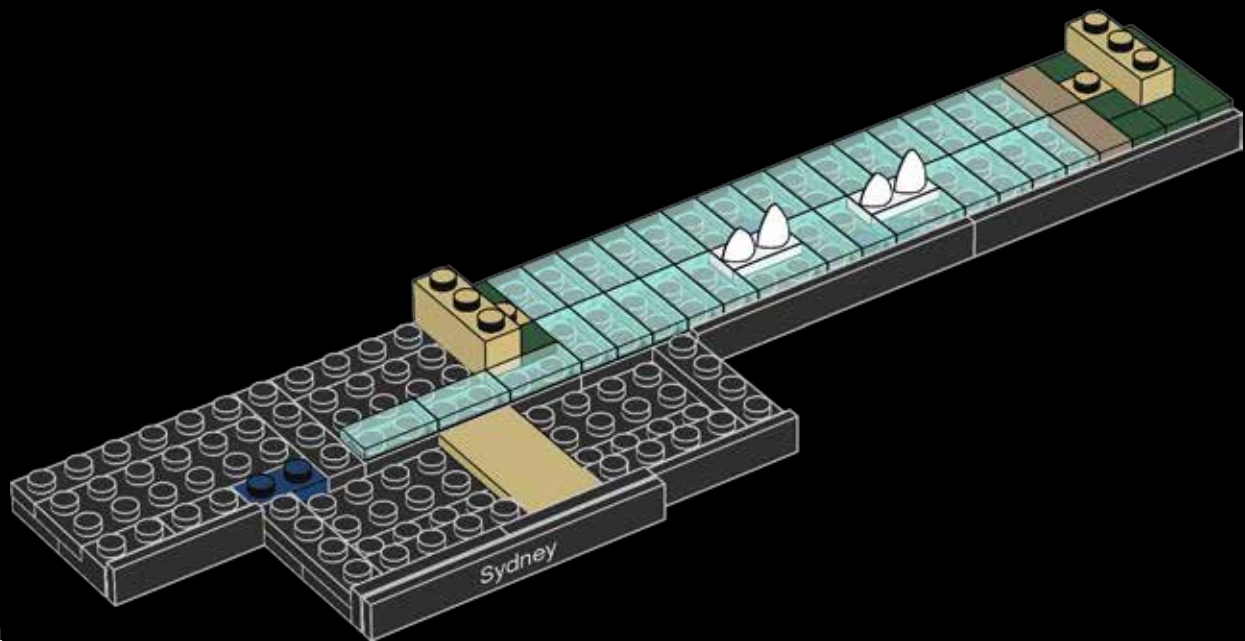
31





1x

32





4x

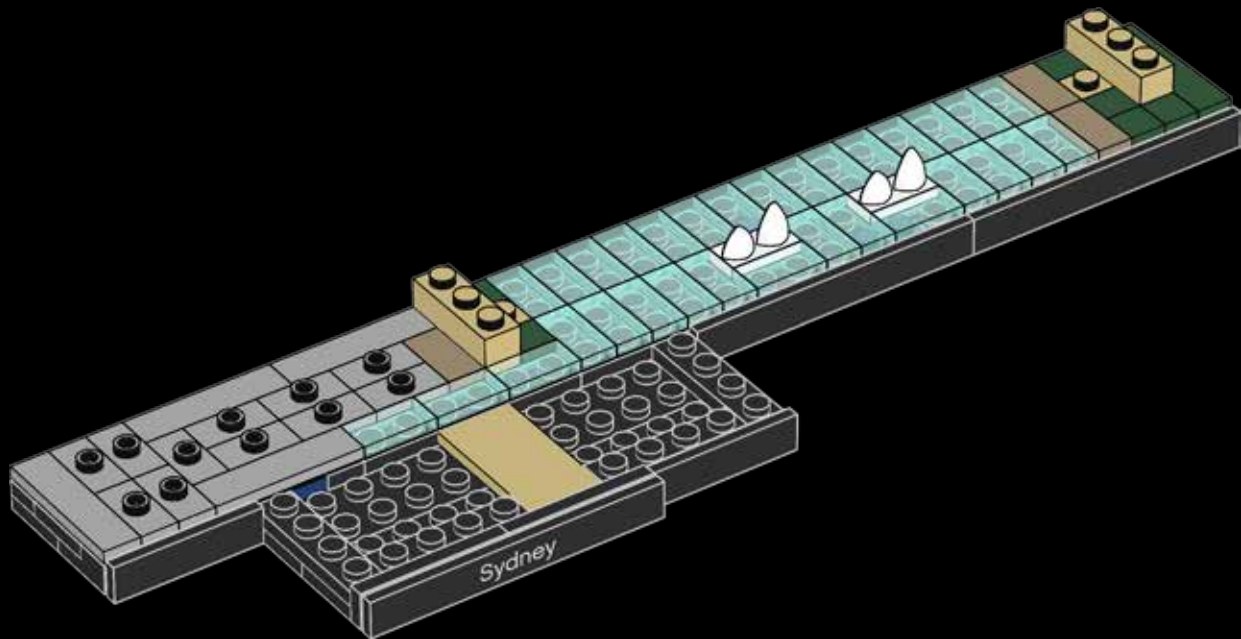


1x



11x

33





2x

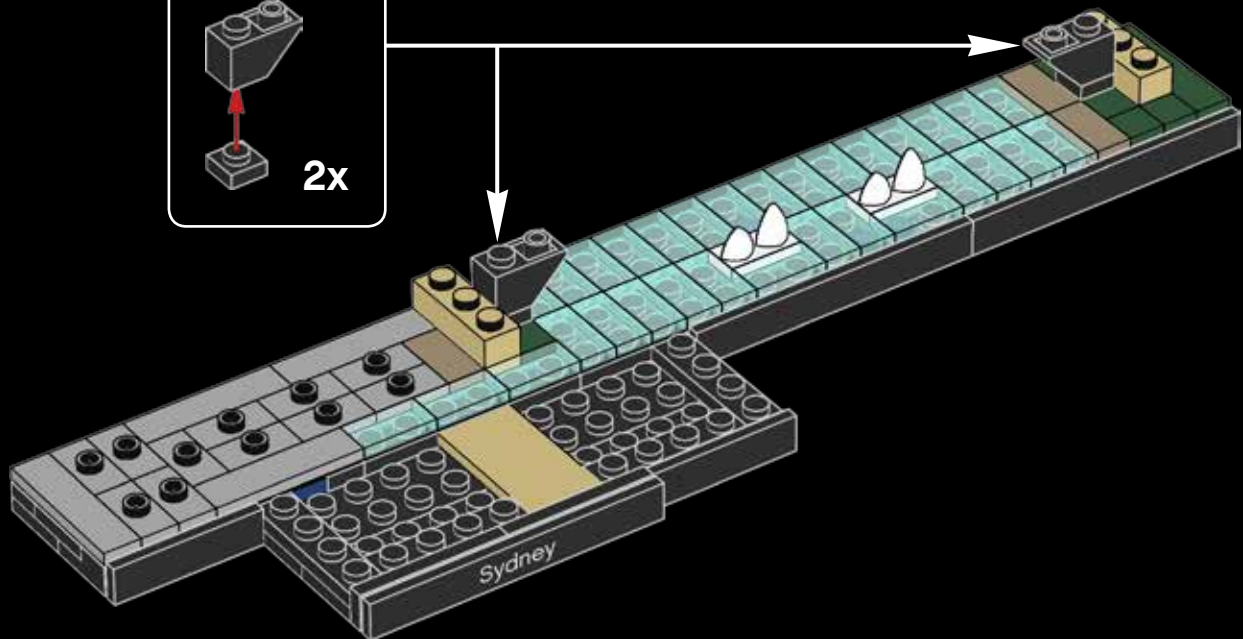


2x

34



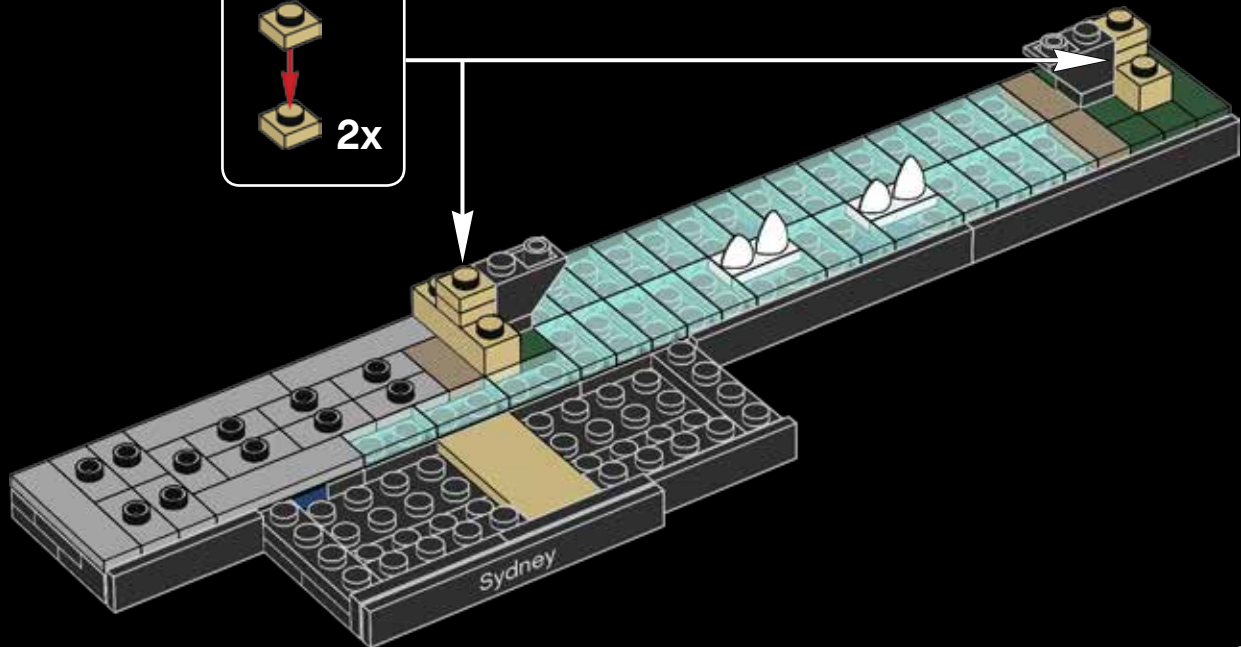
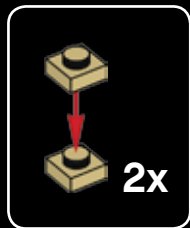
2x

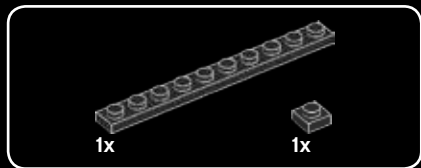
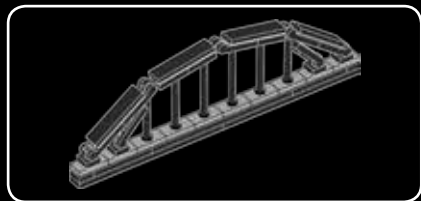


Sydney

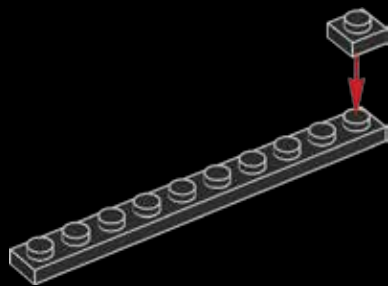


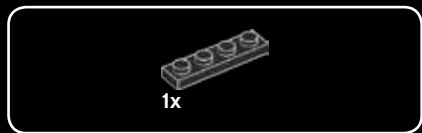
35



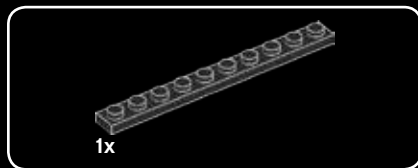
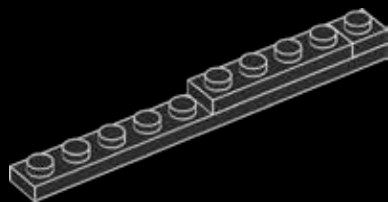


36

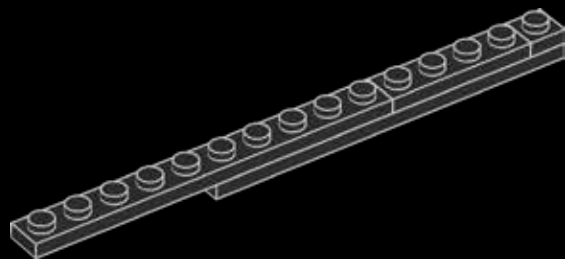


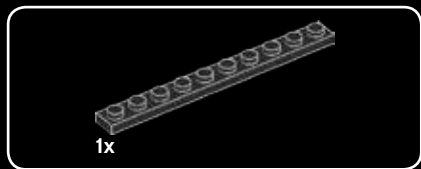


37

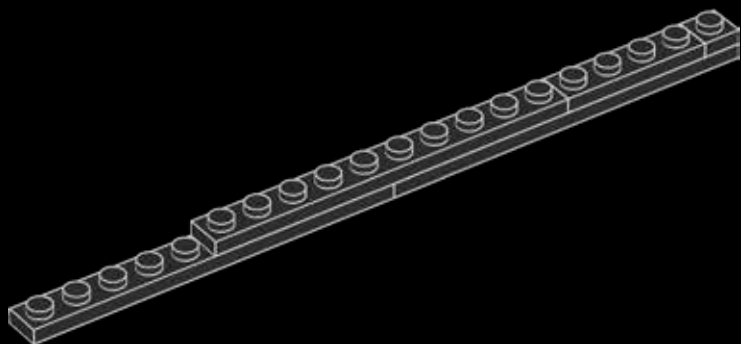


38





39



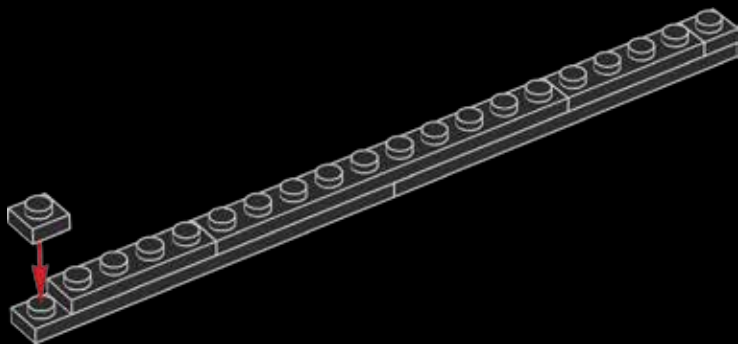


1x



1x

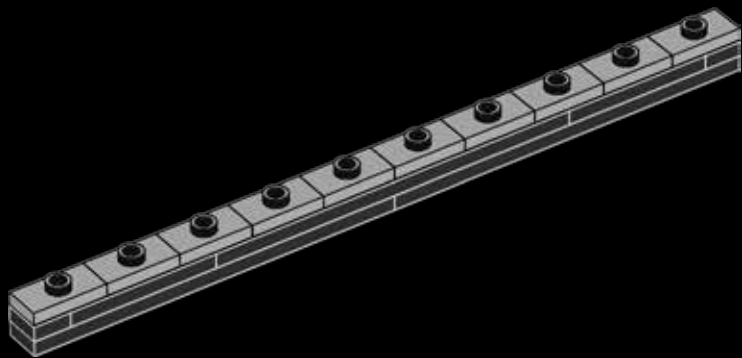
40





10x

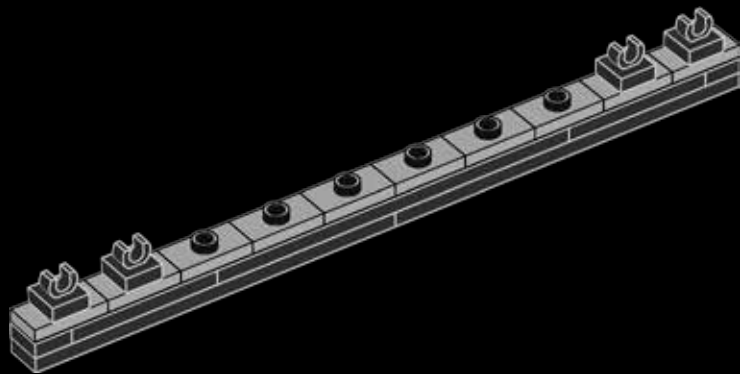
41

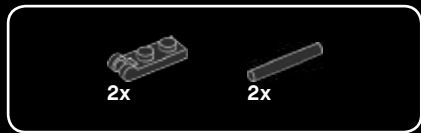




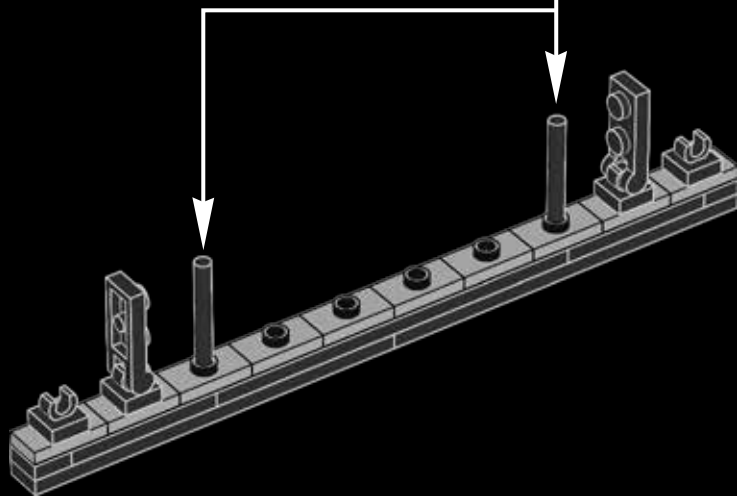
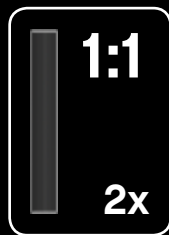
4x

42





43

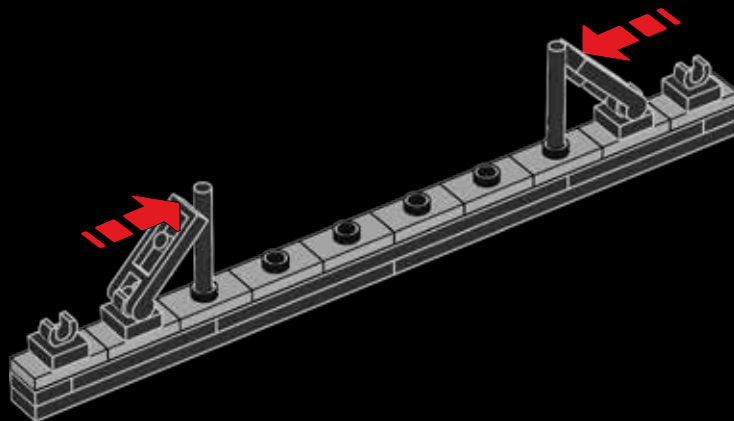


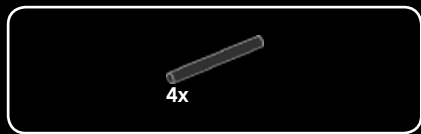
44

71,862 US Gallons (272,000 liters) of paint were used for the first three coats of the bridge.

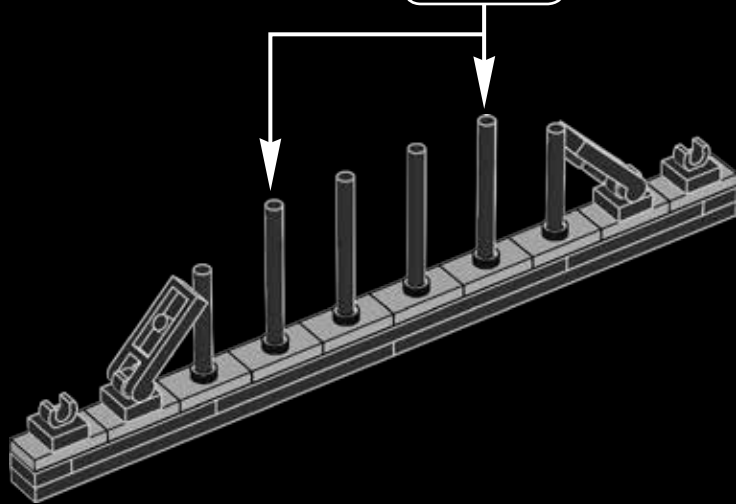
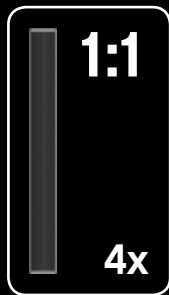
Il a fallu 272 000 litres de peinture pour peindre les 3 premières couches du pont.

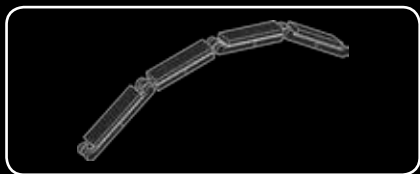
Para cubrir el puente con las tres primeras manos de pintura se necesitaron 272.000 litros.





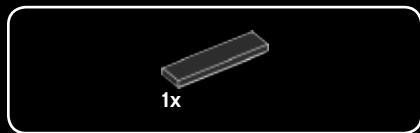
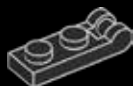
45





1x

46



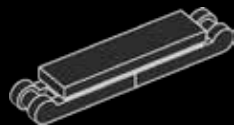
1x

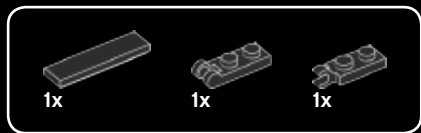
47



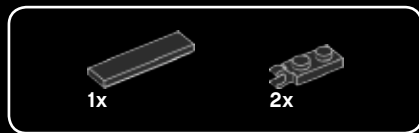
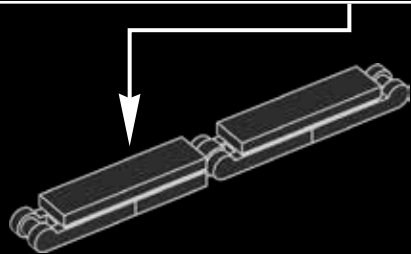
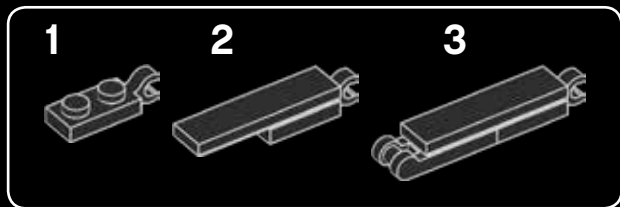
1x

48

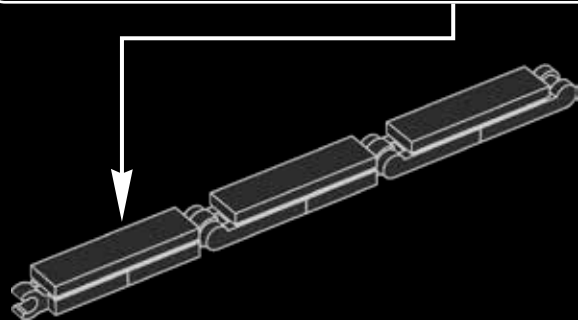
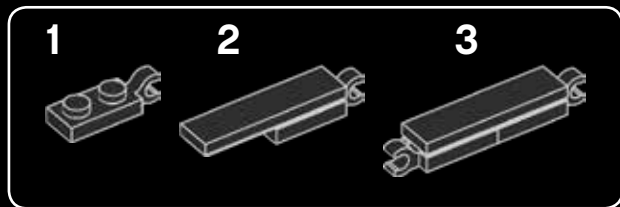




49

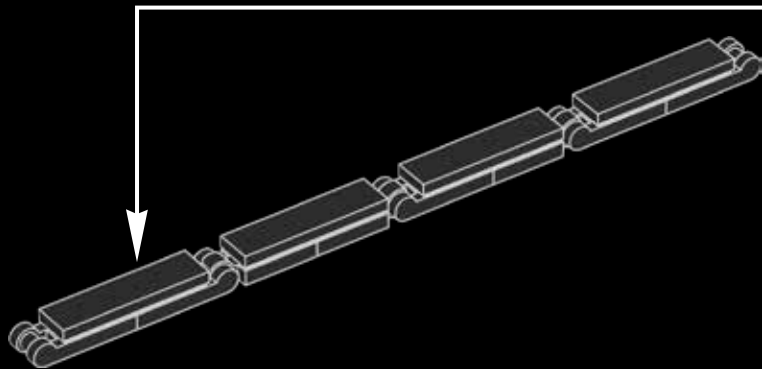
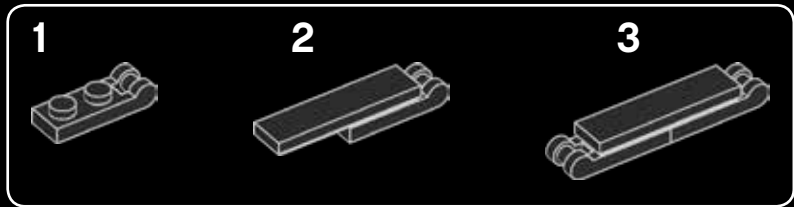


50

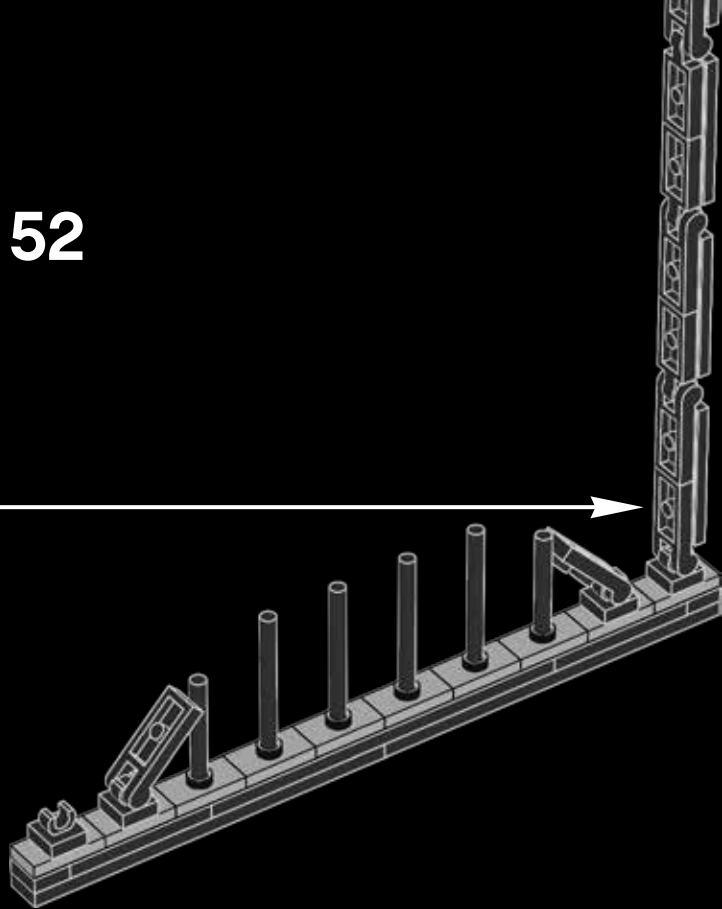




51



52

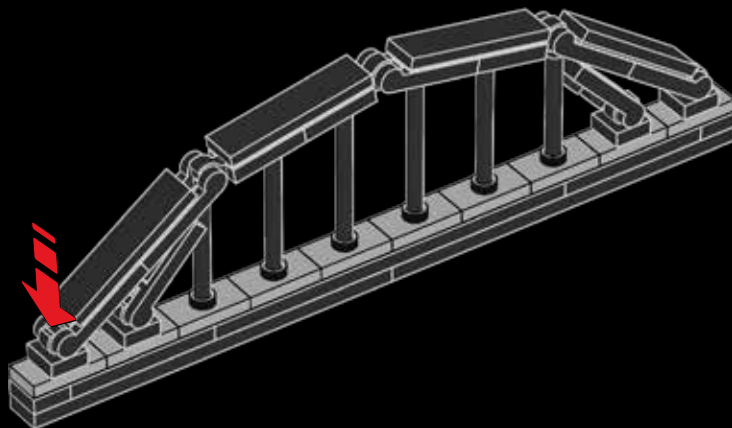


53

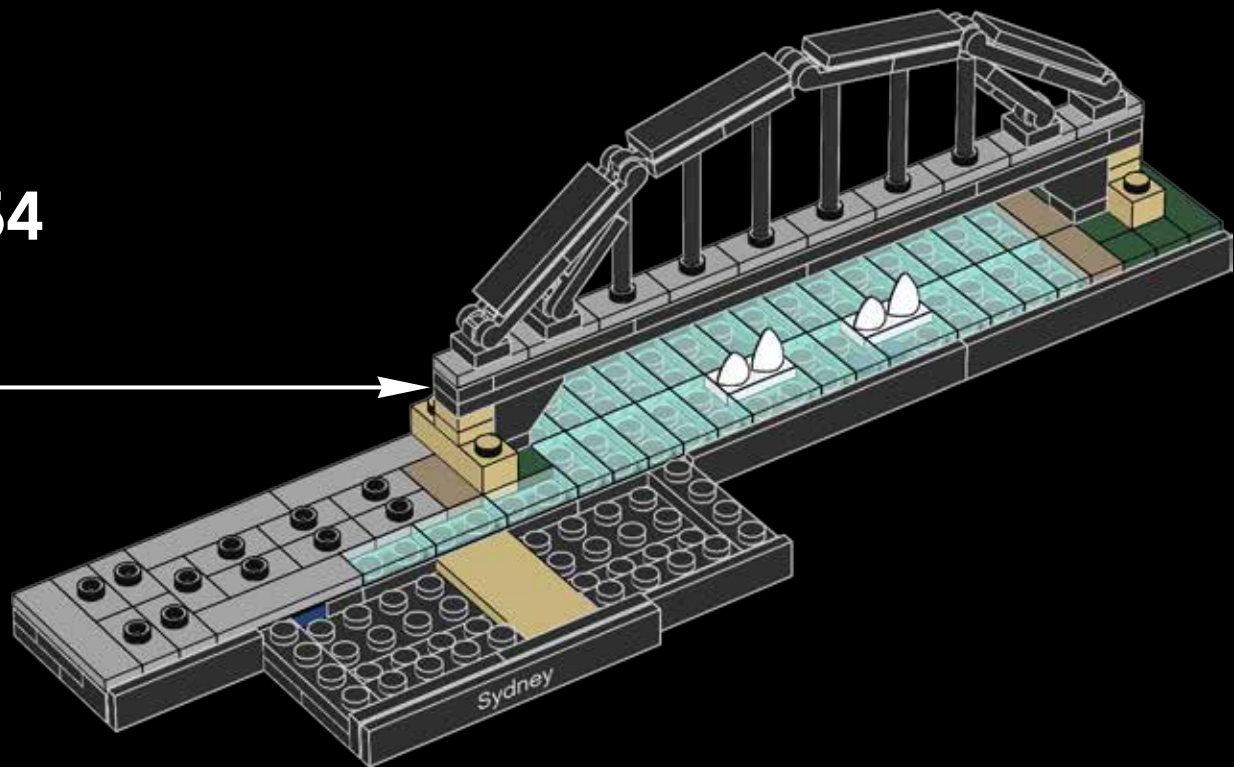
Before the bridge opened, 96 steam locomotives were positioned in various ways to test its load capacity.

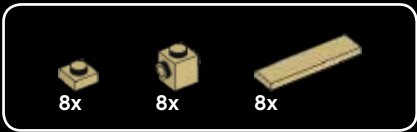
Avant l'ouverture du pont, 96 locomotives à vapeur furent placées stratégiquement pour tester sa capacité de charge.

Antes de que abriera, se colocaron 96 locomotoras de vapor en distintas posiciones para poner a prueba su capacidad de carga.



54





55

1



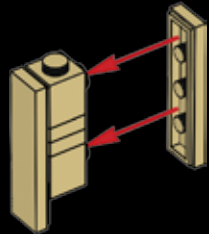
2



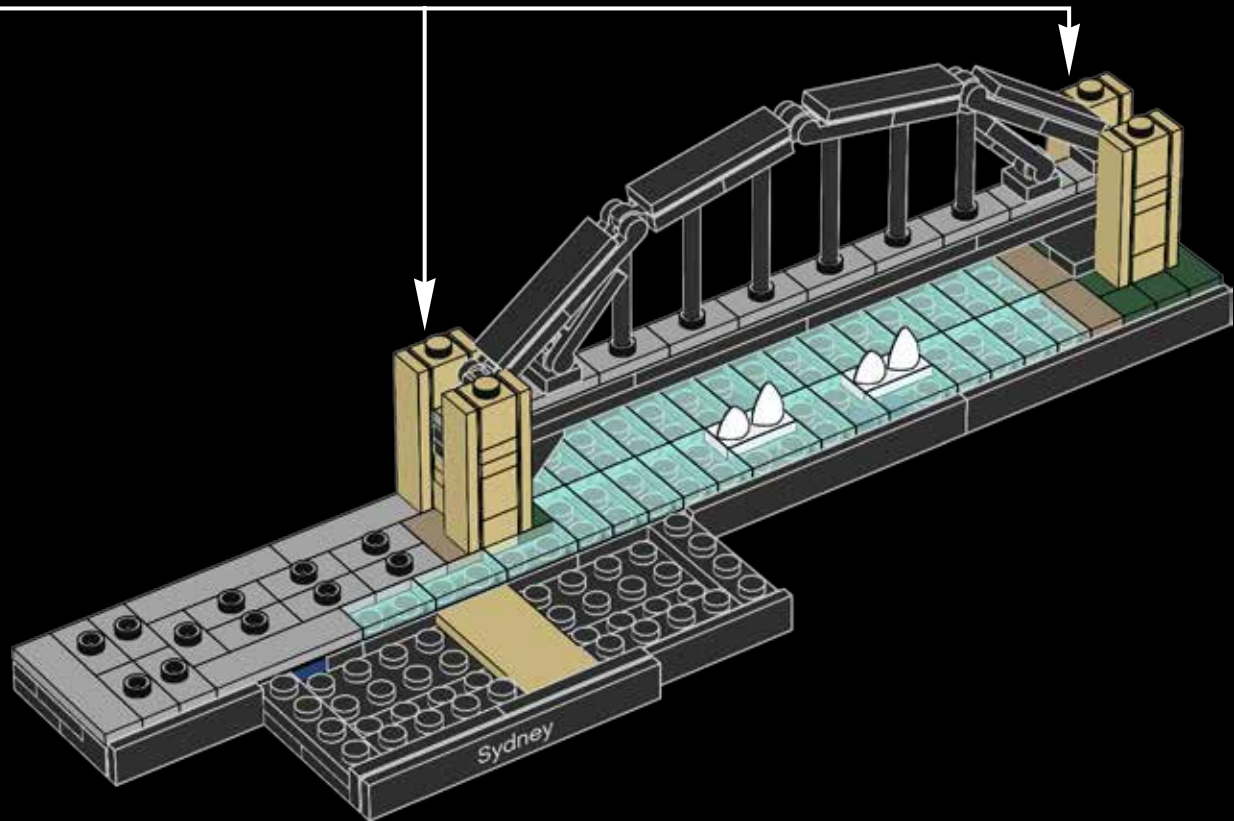
3



4



4x



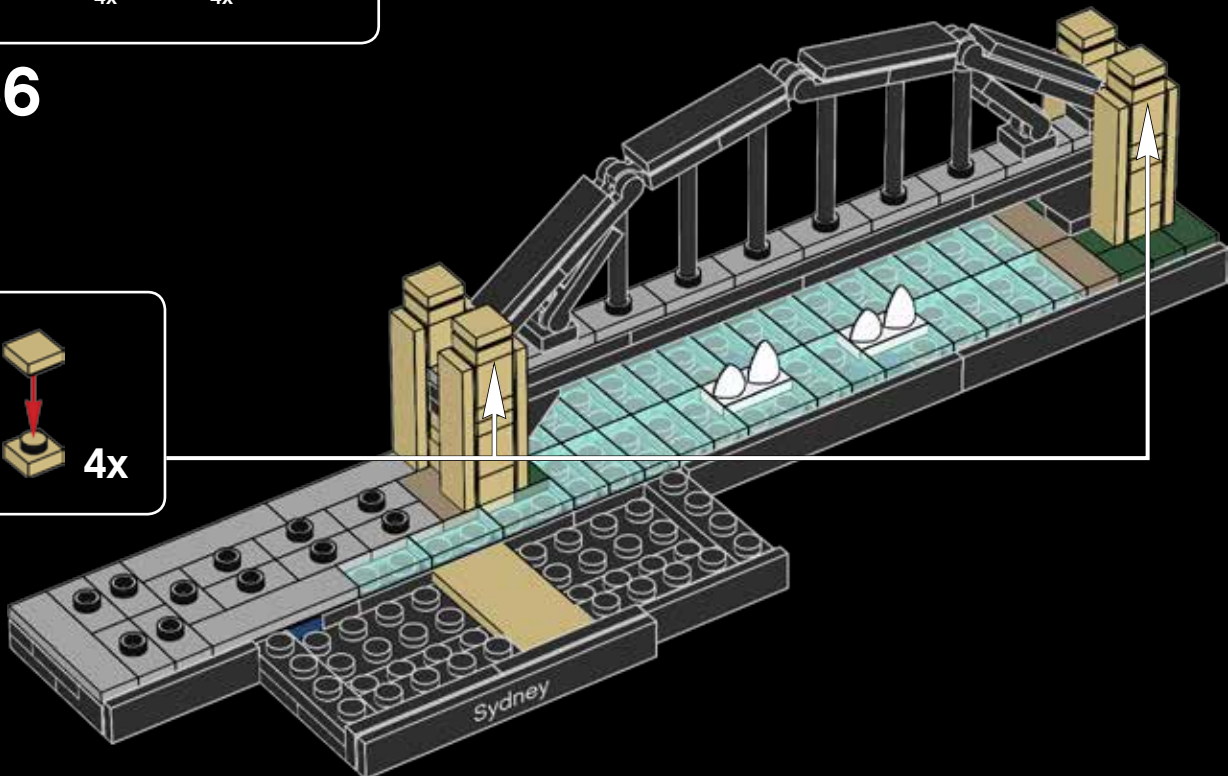


4x

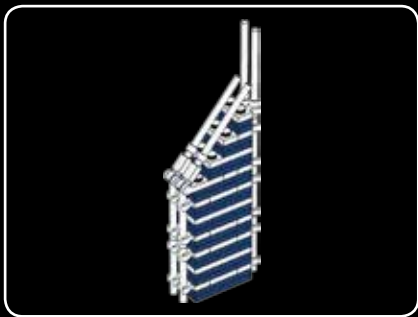


4x

56



4x



57

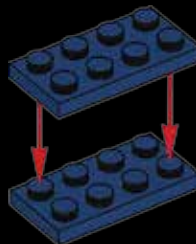
The building has a hollow core that provides air and light throughout the building.

Le bâtiment a un centre vide qui donne de l'air et de la lumière à tout le bâtiment.

El edificio tiene un núcleo hueco que brinda aire y luminosidad a toda la estructura.

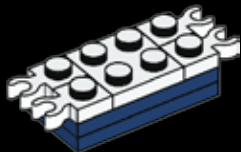


Photo courtesy of Investra

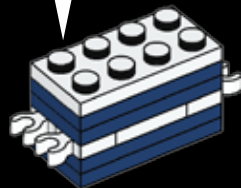
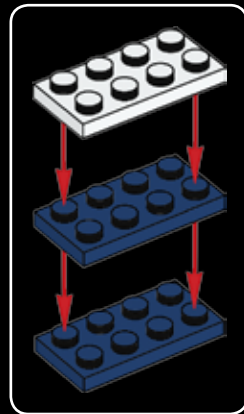




58

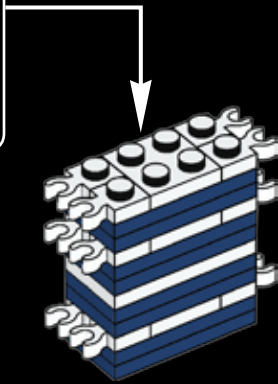
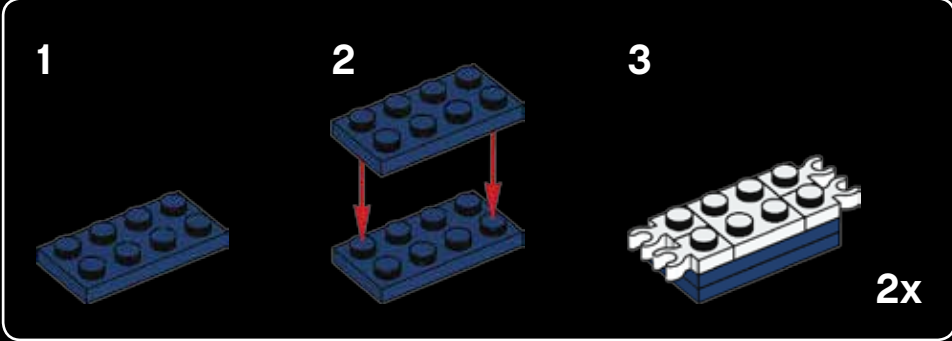


59



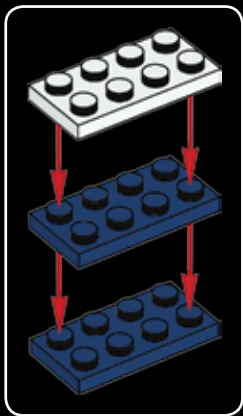


60



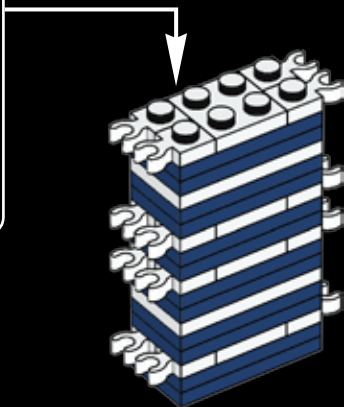
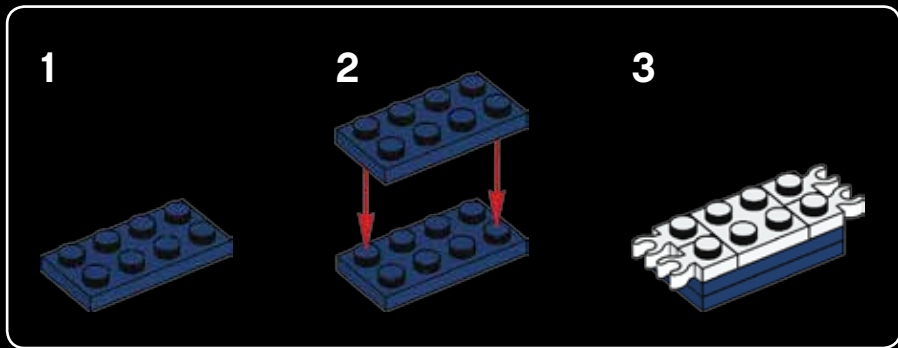


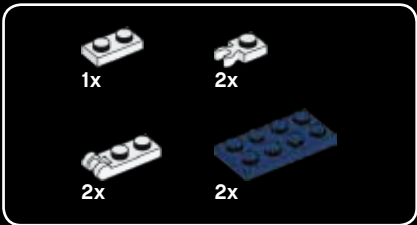
61





62





With only 39 floors, Deutsche Bank Place is the second-tallest building in the world with fewer than 40 floors.

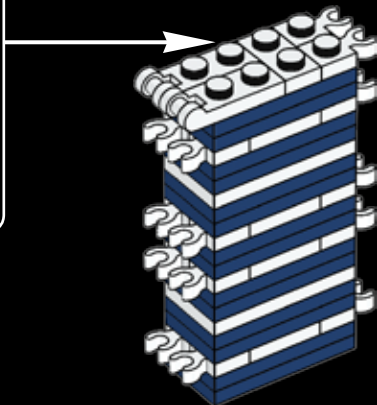
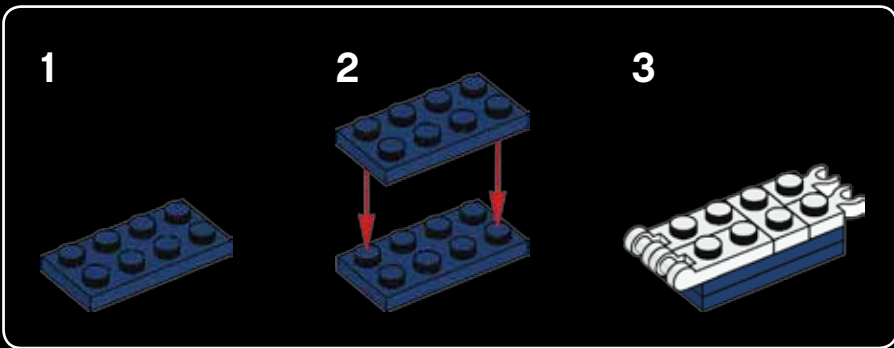
Avec seulement 39 étages, Deutsche Bank Place est le deuxième bâtiment de moins de 40 étages le plus haut du monde.

Con sólo 39 plantas, el Deutsche Bank Place es el segundo edificio más alto del mundo de menos de 40 plantas.



Photo courtesy of Investia

63



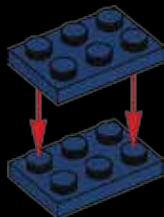


64

1



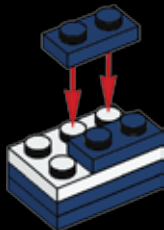
2



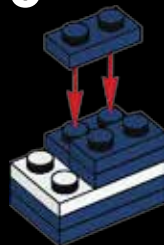
3

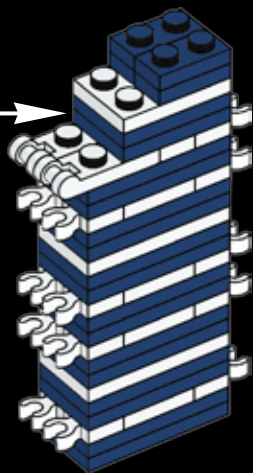


4

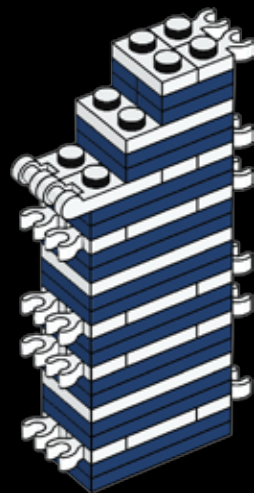


5





65





2x



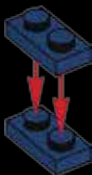
2x

66

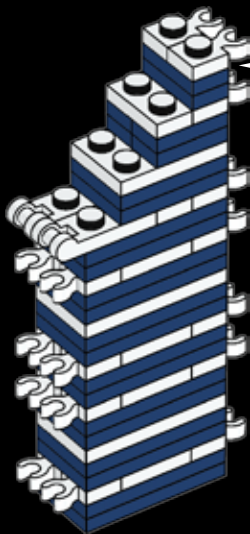
1



2



3



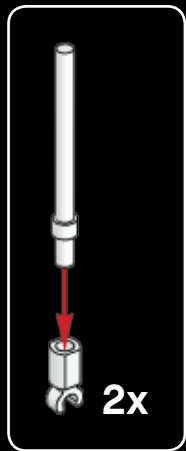


2x

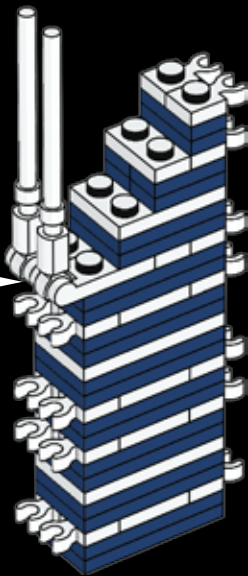


2x

67

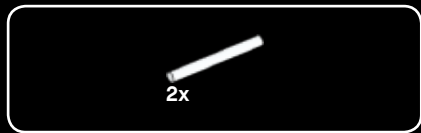


2x

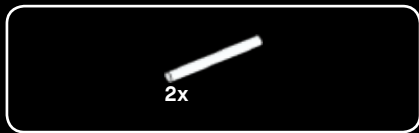
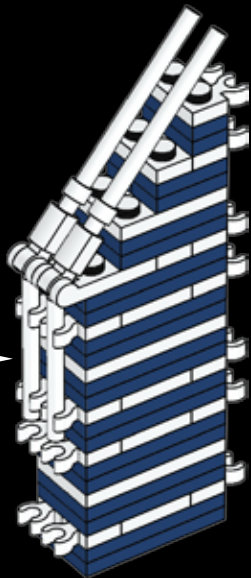
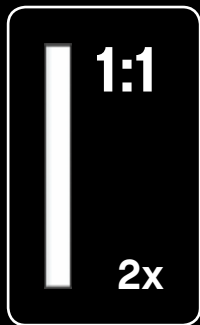


68

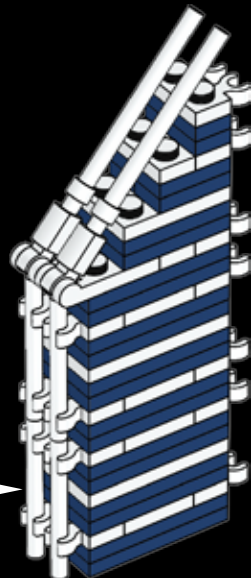
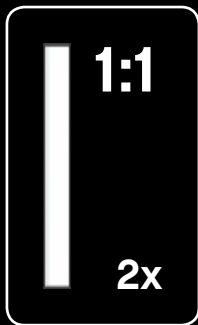




69



70





71



72





2x

73



1:1

2x



2x

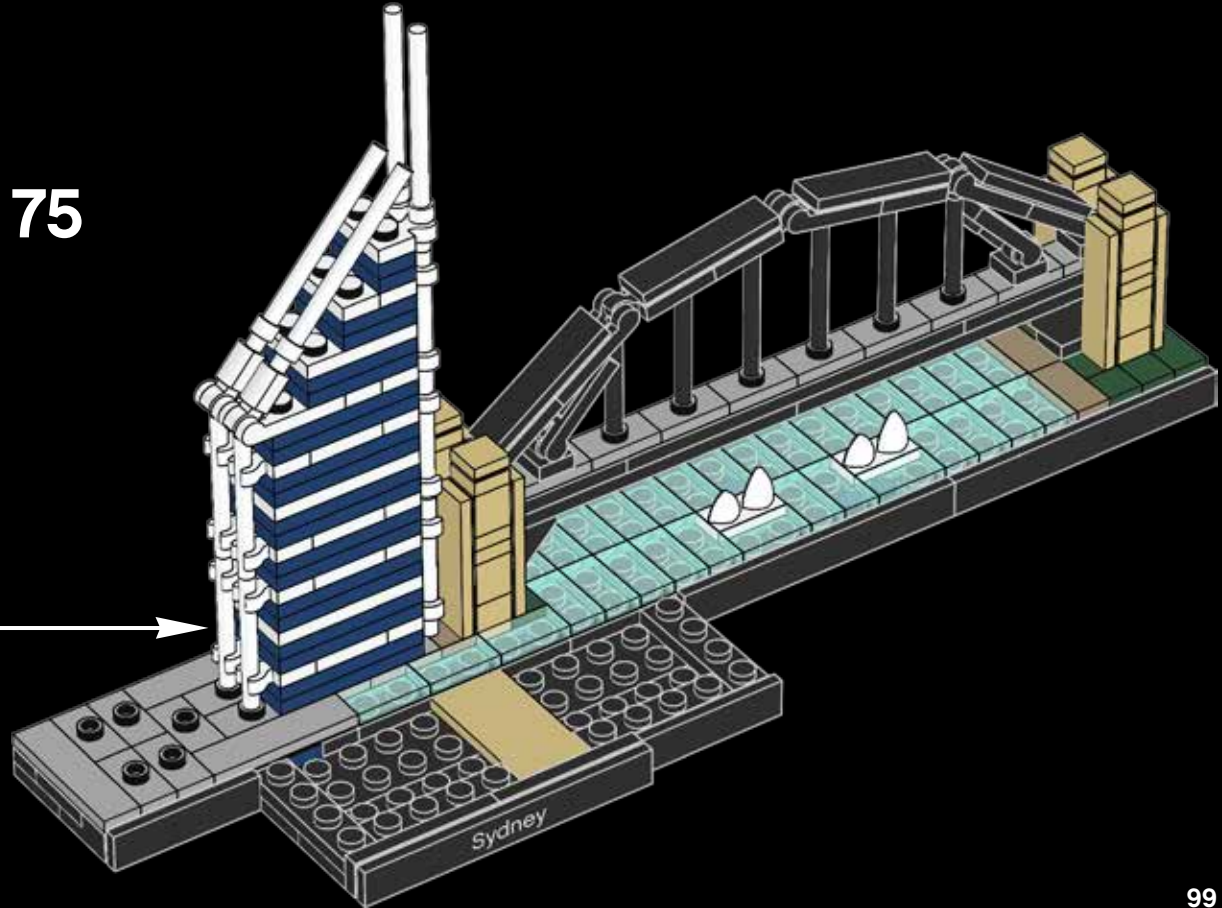
74

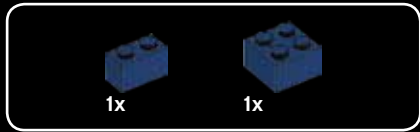


1:1

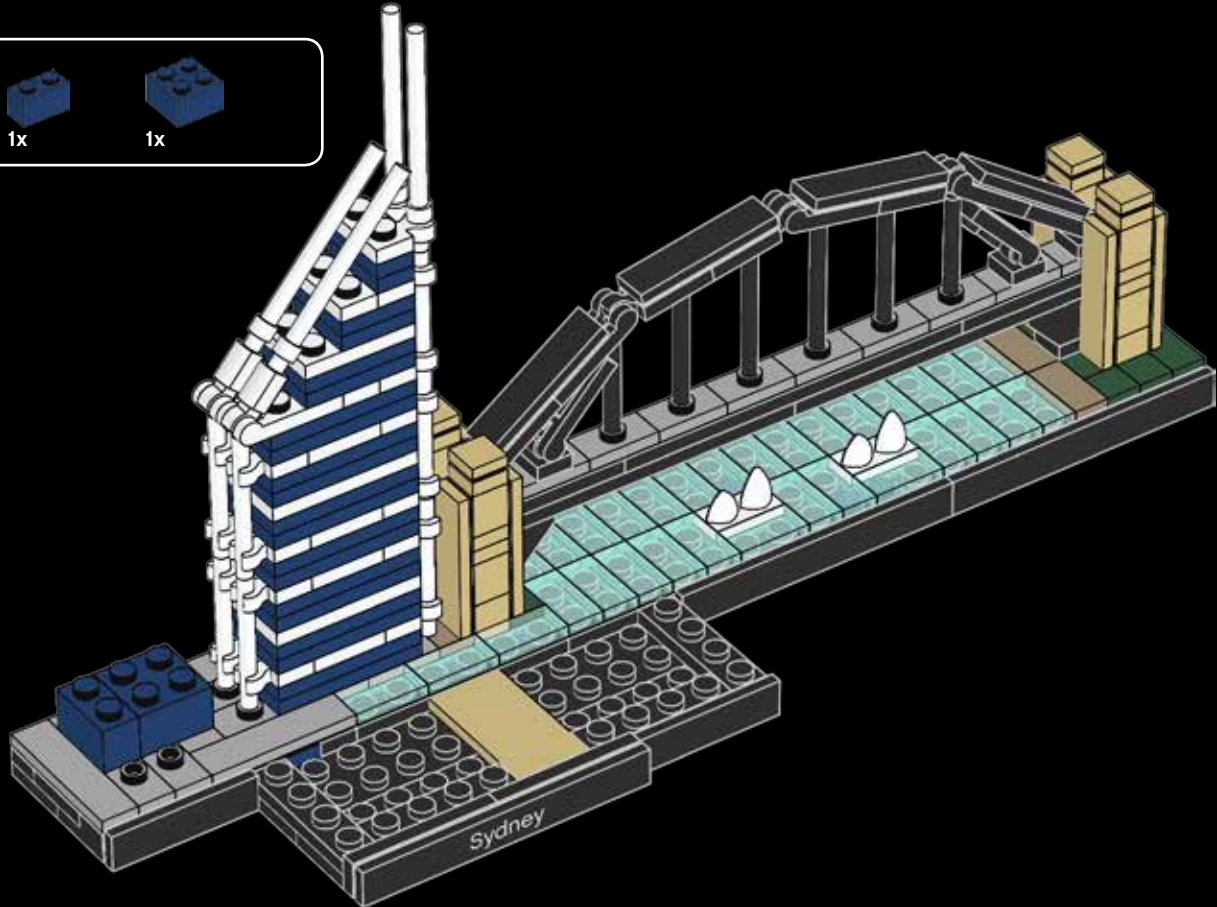
2x

75





76





2x



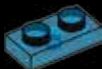
2x



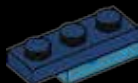
1x

77

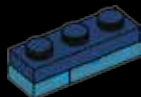
1



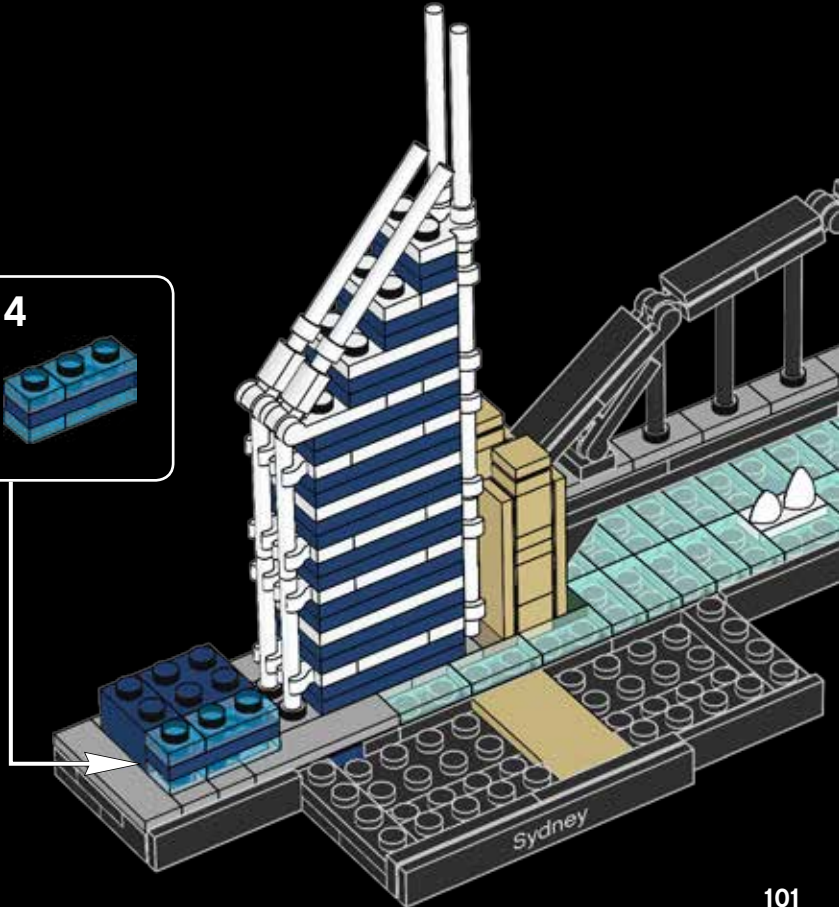
2



3



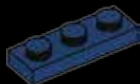
4





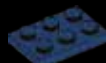
1x

78



1x

79



1x

80





1x



1x



1x

81



1x

82



1x



1x

83



1x

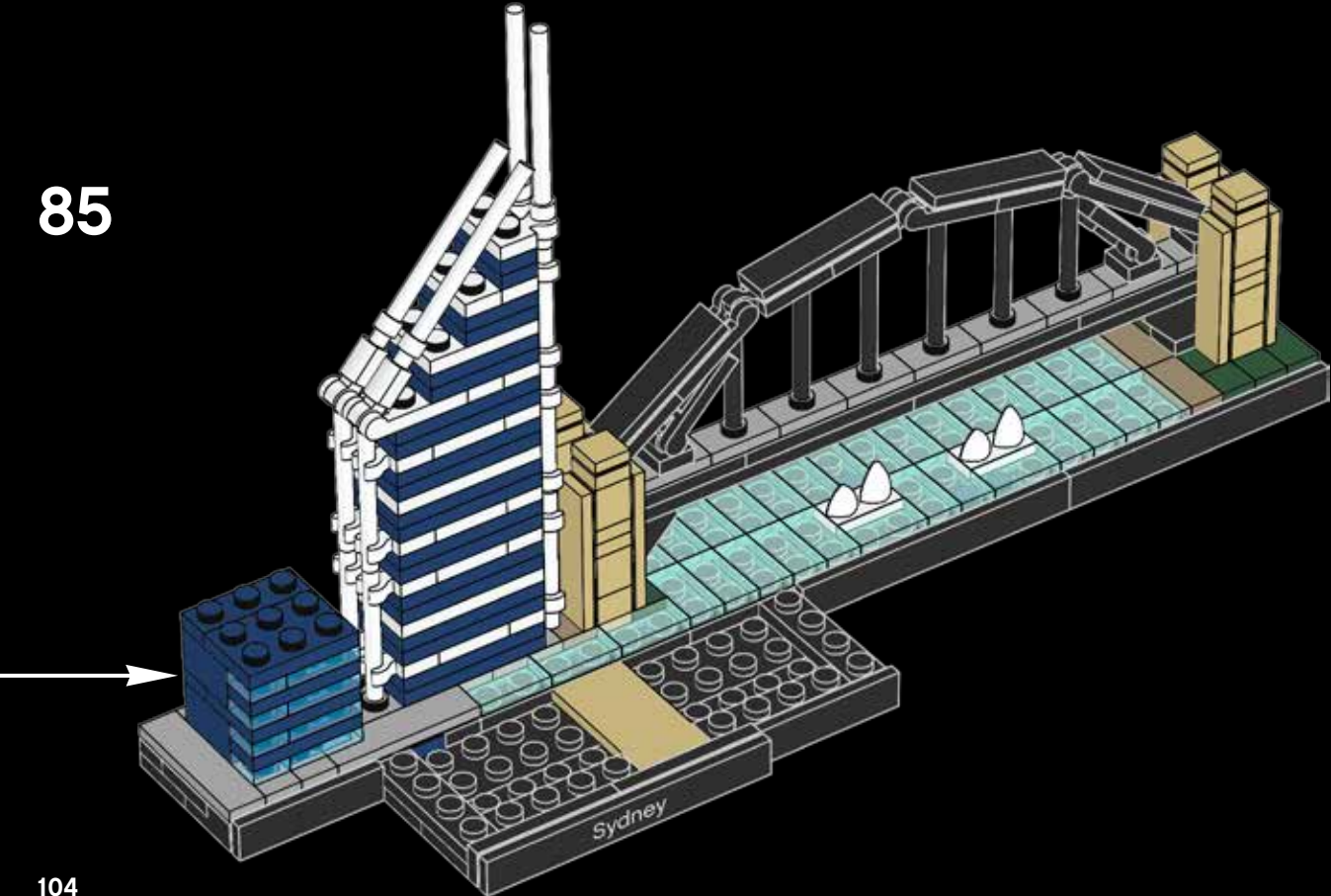


1x

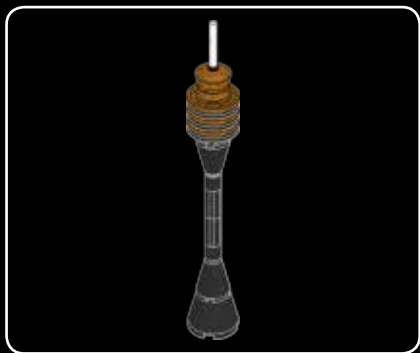
84



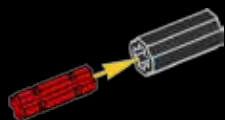
85



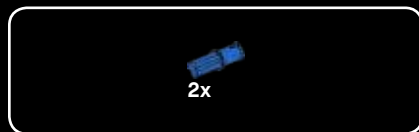
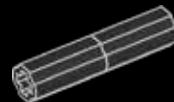
104



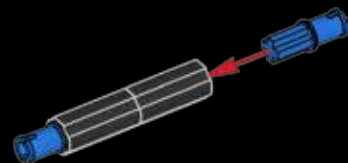
86



87



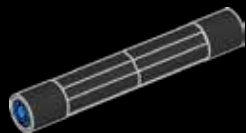
88





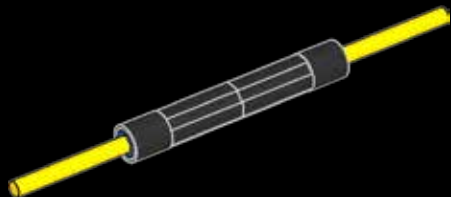
2x

89



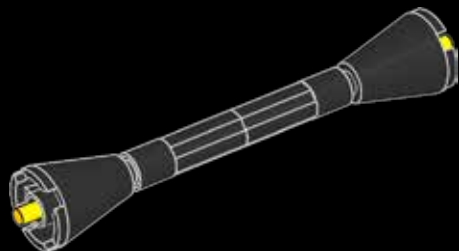
2x

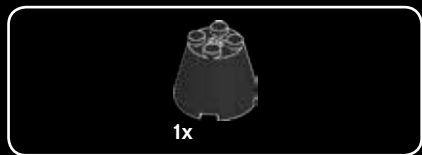
90



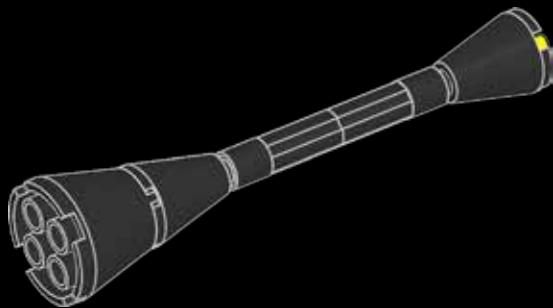
2x

91

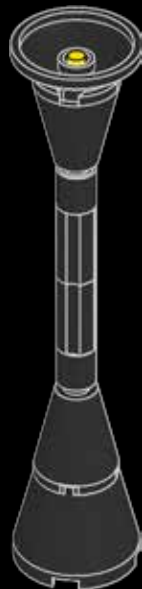




92

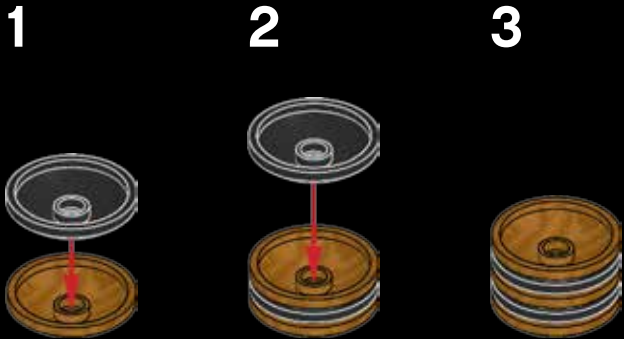


93





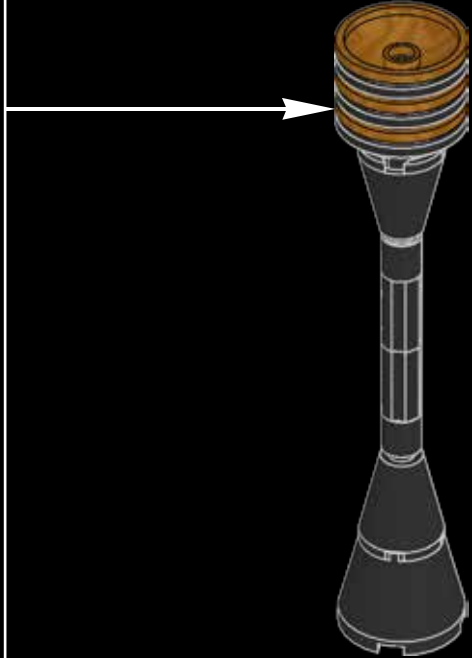
94



The spire located above the Tower is used for telecommunications and navigation purposes.

L'antenne située au-dessus de la tour est utilisée pour les télécommunications et la navigation.

El remate que corona la torre se usa para telecomunicaciones y navegación.





95

1



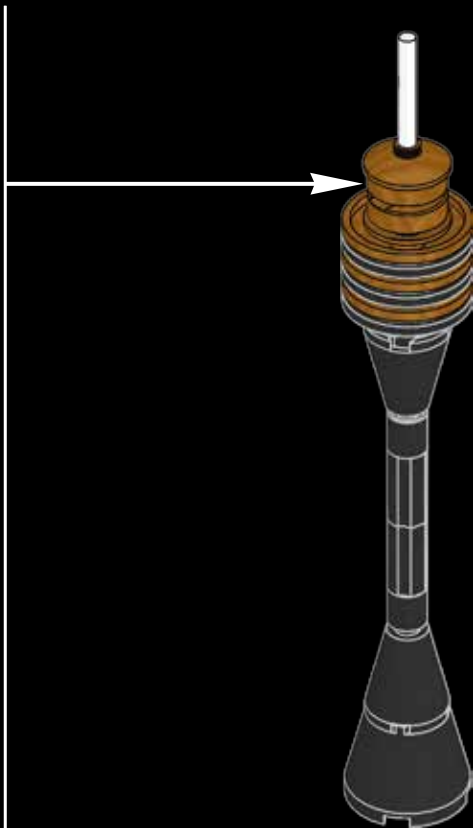
2



3



4

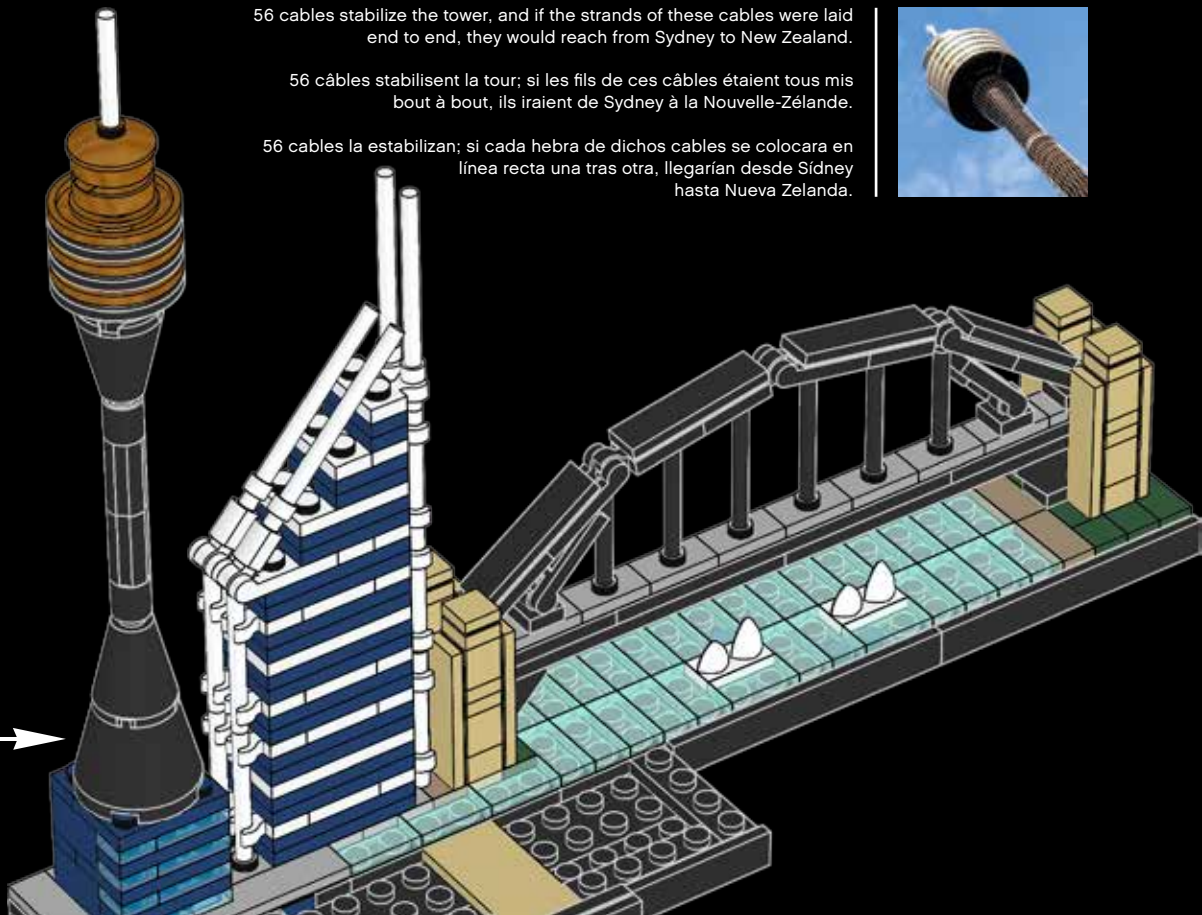


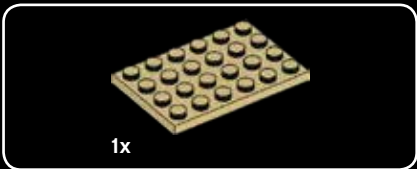
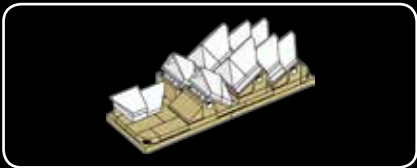
96

56 cables stabilize the tower, and if the strands of these cables were laid end to end, they would reach from Sydney to New Zealand.

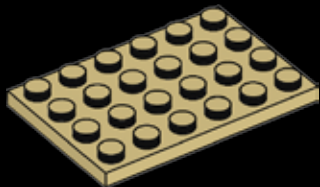
56 câbles stabilisent la tour: si les fils de ces câbles étaient tous mis bout à bout, ils iraient de Sydney à la Nouvelle-Zélande.

56 cables la estabilizan; si cada hebra de dichos cables se colocara en línea recta una tras otra, llegarían desde Sidney hasta Nueva Zelanda.



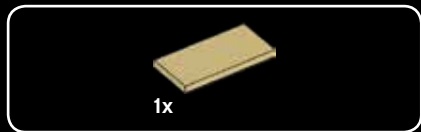


97

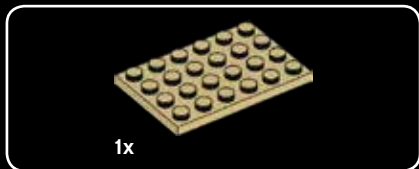


98

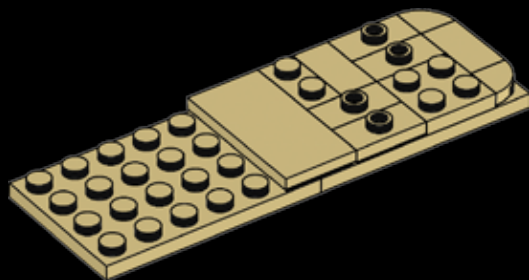




99



100





2x



3x

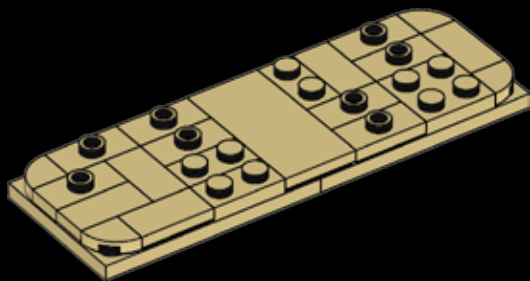


4x



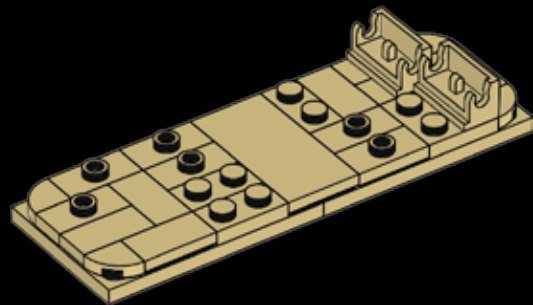
2x

101



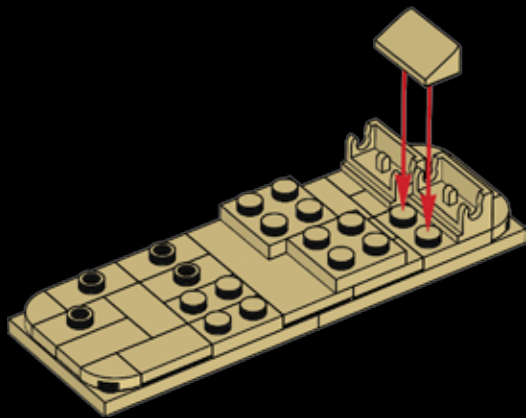
2x

102

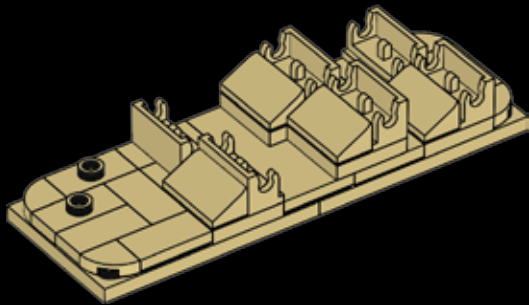




103



104





2x



2x



2x

105

1



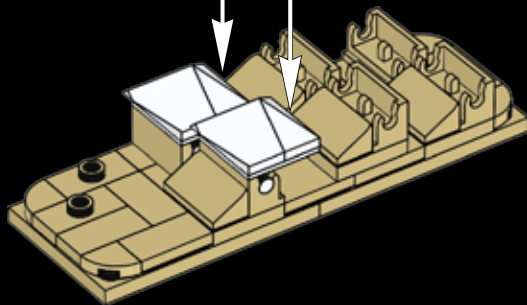
2



3



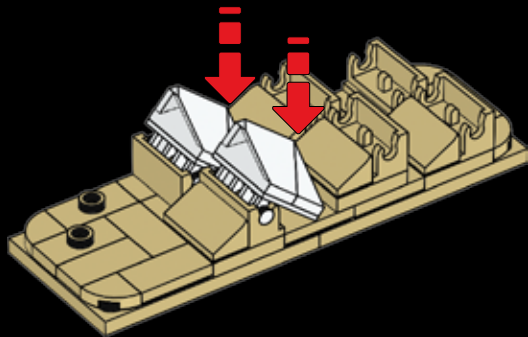
2x



The original Architect, Jørn Utzon, was re-engaged with the project in 1999 and developed a set of design principles that act as a guide for all future development of the building.

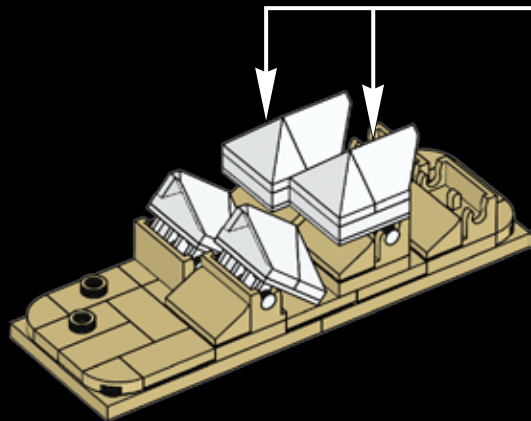
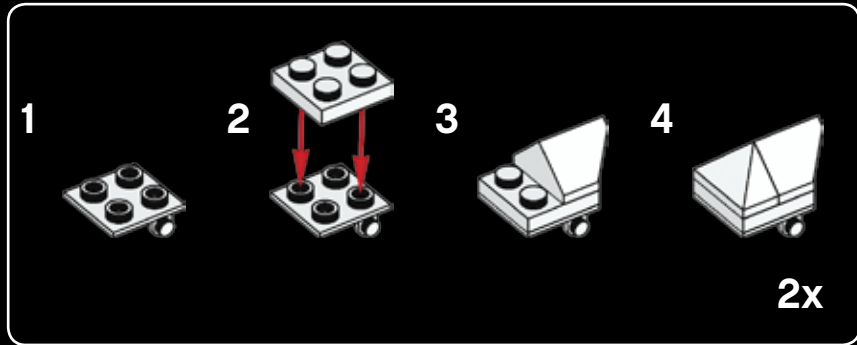
L'architecte d'origine, Jørn Utzon, fut réengagé en 1999 afin d'élaborer un ensemble de principes de design qui serviront de guide pour tout développement futur du bâtiment.

En 1999, el arquitecto original, Jørn Utzon, volvió a involucrarse en el proyecto, desarrollando un conjunto de principios de diseño a modo de guía para cualquier desarrollo futuro del edificio.

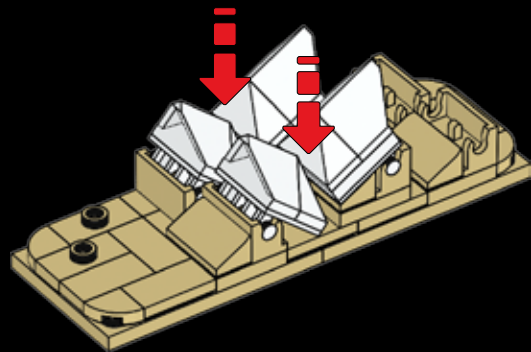




107

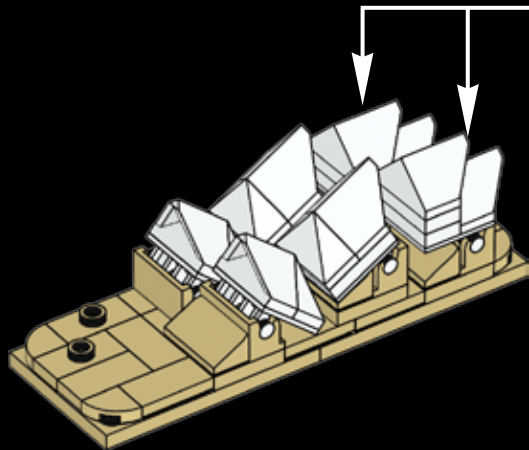
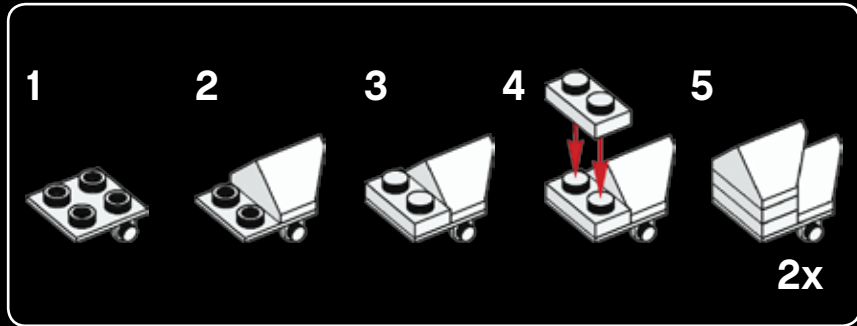


108





109



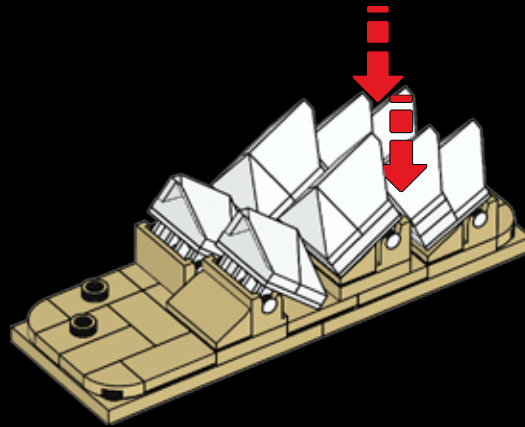
In 2007, the Sydney Opera House became the youngest cultural site to ever be included on the World Heritage List and one of only two cultural sites to be listed during the lifetime of its architect, Jørn Utzon (1918-2008).

En 2007, le Sydney Opera House devint le plus jeune site culturel à être inscrit sur la liste du Patrimoine mondial et l'un des deux sites culturels à y être inclus du vivant de son architecte, Jørn Utzon (1918 - 2008).

En 2007, el Sydney Opera House se convirtió en el emplazamiento cultural más joven de la lista de la UNESCO, y uno de los dos únicos centros culturales que entraron en la lista durante la vida de su arquitecto, Jørn Utzon (1918-2008).



110



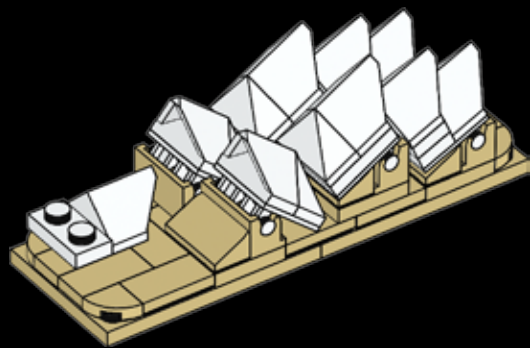


1x



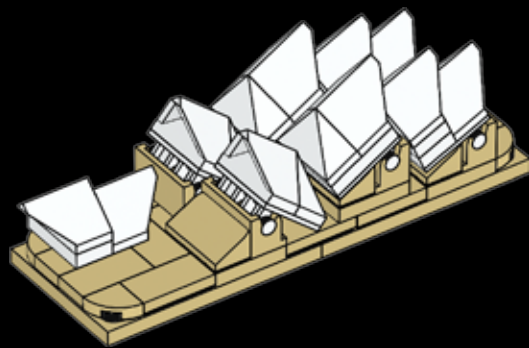
1x

111

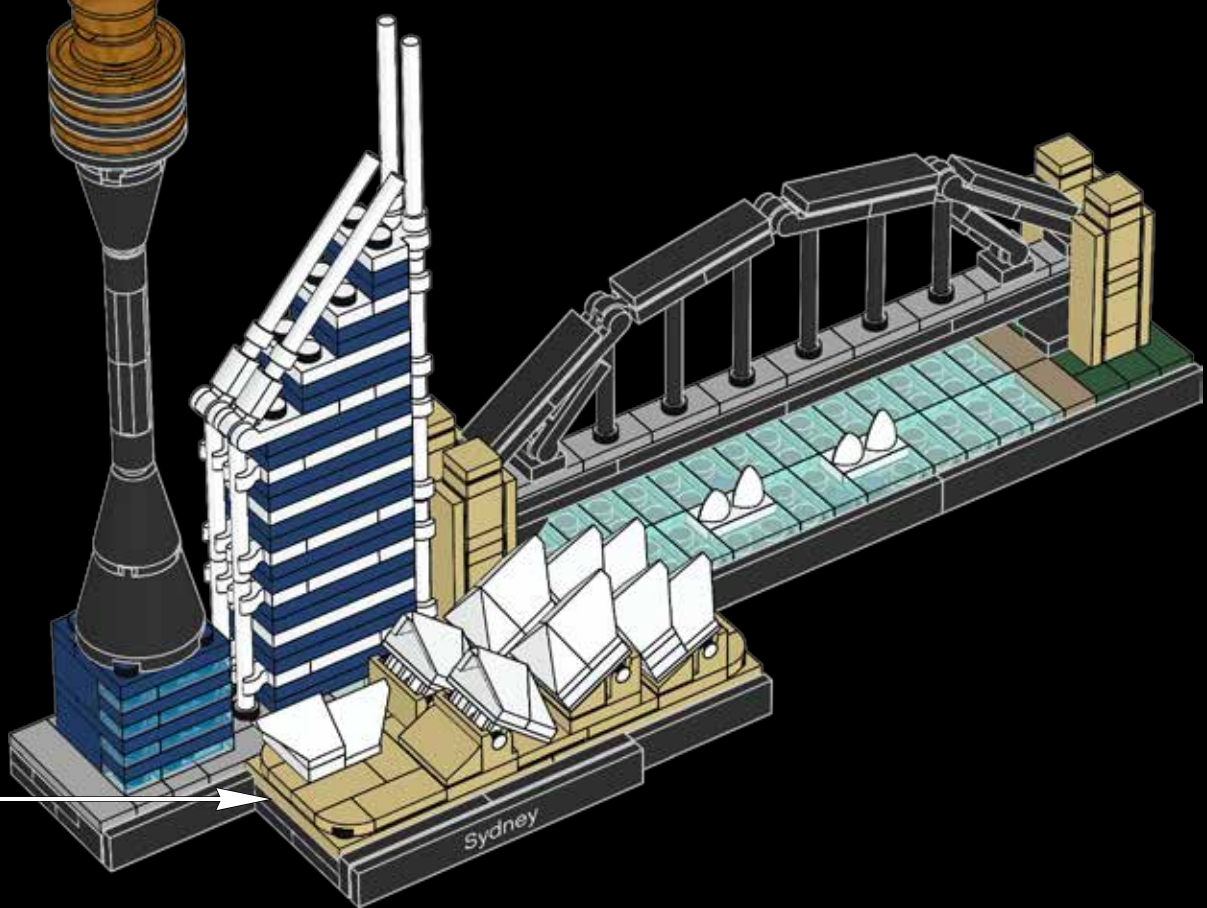


1x

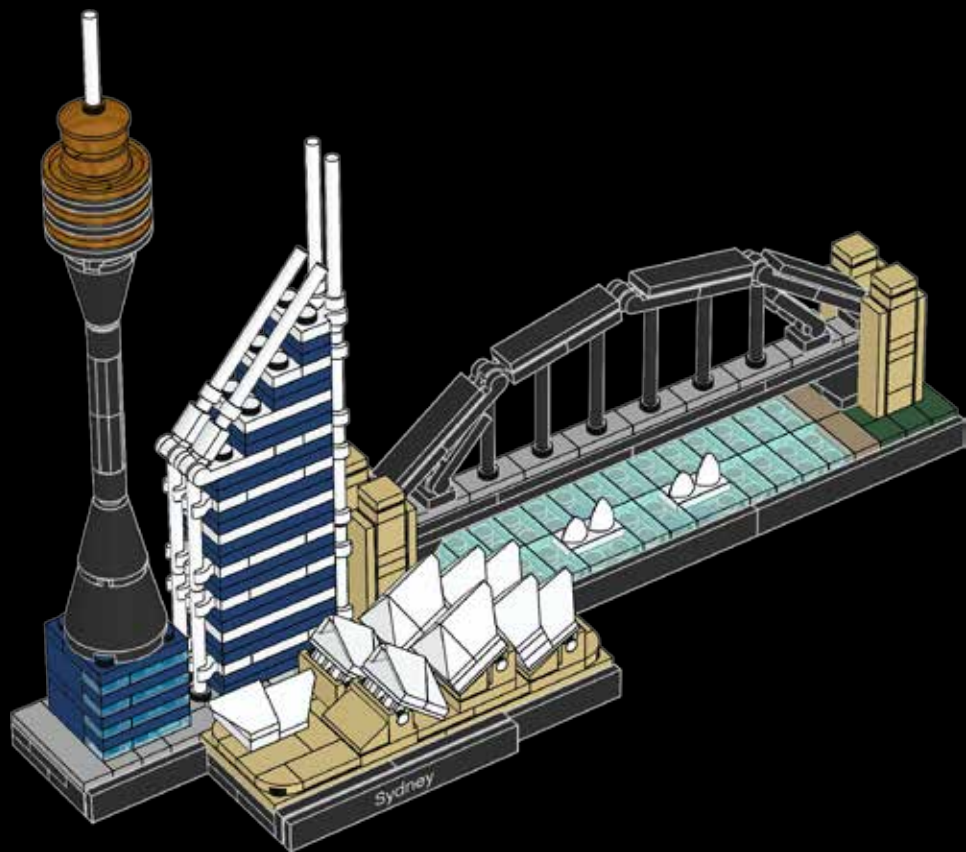
112



113



122





LEGO® Architecture – do you like it?

The LEGO Group would like your opinion on the new product you have just purchased. Your feedback will help shape the future development of this product series. Please visit:

[LEGO.com/productsurvey](https://www.lego.com/productsurvey)

By completing our short feedback survey, you will be automatically entered into a draw to win a LEGO® prize.



See website for official rules and details. Open to all countries where not prohibited.

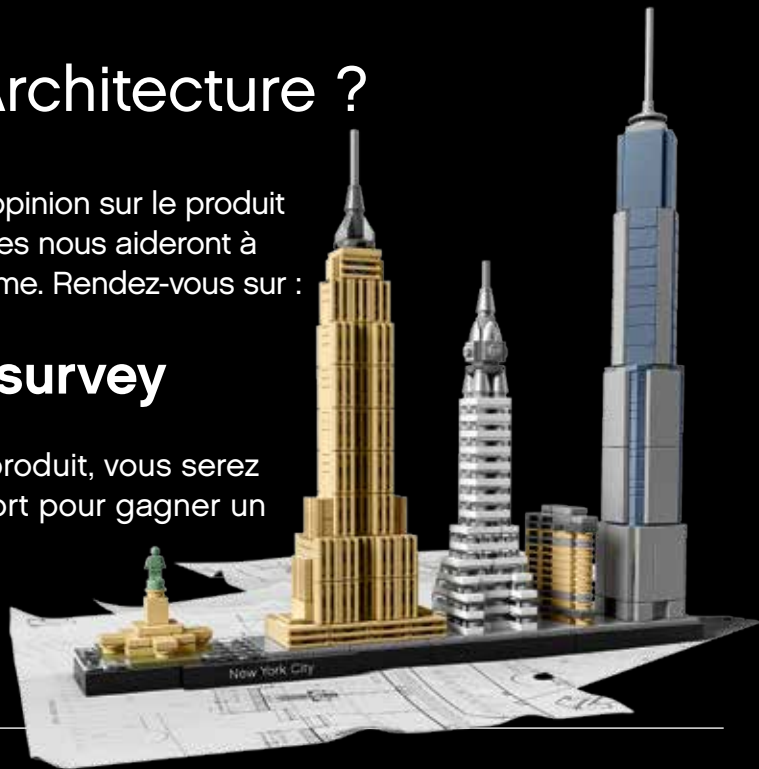
LEGO and the LEGO logo are trademarks of the/son des marques de commerce du/son marcas registradas de LEGO Group. ©2017 The LEGO Group.

Aimez-vous LEGO® Architecture ?

Le Groupe LEGO aimerait connaître votre opinion sur le produit que vous venez d'acheter. Vos commentaires nous aideront à concevoir les futurs produits de cette gamme. Rendez-vous sur :

[LEGO.com/productsurvey](https://www.lego.com/productsurvey)

En remplissant ce court sondage sur le produit, vous serez automatiquement inscrit à un tirage au sort pour gagner un prix LEGO®.



Consultez le site Web pour obtenir le règlement officiel et les détails. Ouvert à tous les résidents des pays autorisés.

LEGO and the LEGO logo are trademarks of the/son des marques de commerce du/son marcas registradas de LEGO Group. ©2017 The LEGO Group.

LEGO® Architecture: ¿te gusta?

The LEGO Group quiere conocer tu opinión acerca del nuevo producto que acabas de comprar. Tus comentarios nos ayudarán a dar forma a los futuros productos de esta serie. Visita:

[LEGO.com/productsurvey](https://www.lego.com/productsurvey)

Al rellenar esta breve encuesta de opinión, participarás automáticamente en el sorteo de un producto LEGO®.



Consulta las reglas oficiales y demás información en el sitio web. Válido en todos los países en los que esta actividad no esté prohibida.

LEGO and the LEGO logo are trademarks of the/son des marques de commerce du/son marcas registradas de LEGO Group. ©2017 The LEGO Group.

LEGO® Architecture—then and now

There has always been a natural connection between the LEGO® brick and the world of architecture. Fans who build with LEGO elements instinctively develop an interest in the form and function of the structures they create. At the same time, many architects have discovered that LEGO bricks are the perfect way of physically expressing their creative ideas.

This connection was confirmed in the early 1960s with the launch of the LEGO 'Scale Model' line. It matched the spirit of the age where modern architects were redefining how houses look and people were taking an active interest in the design of their new homes. These sets were designed to be different from the normal, brightly colored LEGO boxes; they also included a book on architecture as a source of inspiration.

Decades later, architect and LEGO fan Adam Reed Tucker, revived the idea of expressing architecture using LEGO bricks and in partnership with the LEGO Group, launched the LEGO Architecture line that we know today.

His first models, and the original sets in the current LEGO Architecture series, were interpretations of famous skyscrapers from his hometown of Chicago. Since then LEGO Architecture has developed and evolved, first with well-known buildings from other cities in the United States, and now with iconic structures from Europe, the Middle East and Asia.

The introduction of our LEGO Architecture Studio set echoes the ambitions of the earlier LEGO 'Scale Model' line and widens the potential of the LEGO Architecture series. Now you can enjoy building and learning about specific landmark buildings, or create exciting architectural models from your own fantasy. An inspiring 270-page book, featuring a number of renowned architects from around the world, guides you through the principles of architecture and encourages you in your own creative building.

LEGO® Architecture – Hier et aujourd'hui

Il y a toujours eu une connexion naturelle entre la brique LEGO® et le monde de l'architecture. Les fans qui construisent avec des éléments LEGO développent instinctivement un intérêt pour la forme et la fonction des structures qu'ils créent. De nombreux architectes ont quant à eux découvert que les briques LEGO sont la façon idéale de matérialiser leurs idées de création.

Cette connexion a été confirmée au début des années 1960 avec le lancement de la gamme « Maquettes à l'échelle » LEGO. Cette gamme correspondait à l'esprit de l'époque, alors que les architectes modernes redéfinissaient les maisons, et que les gens s'intéressaient activement à la conception de leur résidence. Ces ensembles originaux étaient conçus pour être différents des boîtes LEGO habituelles aux couleurs vives, et incluaient aussi « un livret d'architecture » comme source d'inspiration.

Quelques décennies plus tard, l'architecte et fan de LEGO Adam Reed Tucker a fait revivre l'idée d'exprimer l'architecture en utilisant des briques LEGO. En partenariat avec le Groupe LEGO, il lança la gamme LEGO Architecture que nous connaissons aujourd'hui.

Ses premiers modèles, et les ensembles originaux de la gamme LEGO Architecture actuelle, étaient des interprétations de célèbres gratte-ciel de sa ville natale de Chicago. La gamme LEGO Architecture a depuis évolué et s'est élargie, tout d'abord avec des bâtiments célèbres d'autres villes des États-Unis, puis avec de célèbres monuments d'Europe, du Moyen-Orient et d'Asie.

L'introduction de notre ensemble LEGO Architecture Studio fait écho aux ambitions de la précédente gamme « Maquettes à l'échelle » LEGO et accroît le potentiel de la gamme LEGO Architecture. Vous pouvez maintenant découvrir et construire des monuments célèbres ou créer de passionnants modèles architecturaux nés de votre imagination. Un livret d'inspiration de 270 pages, présentant plusieurs architectes célèbres du monde entier, vous guide parmi les principes de l'architecture et vous encourage dans votre propre construction créatrice.

LEGO® Architecture: entonces y ahora

Siempre ha existido una conexión natural entre el brick LEGO® y el mundo de la arquitectura. Los fans que construyen con elementos LEGO desarrollan instintivamente un interés por la forma y las funciones de las estructuras que crean. Al mismo tiempo, muchos arquitectos han descubierto que los bricks LEGO son una forma perfecta de expresar físicamente sus ideas creativas.

Esta relación se confirmó a principios de la década de 1960, con el lanzamiento de la línea «Scale Model» de LEGO. Encajaba bien con el espíritu de la época: un tiempo en el que los arquitectos modernos redefinían el aspecto de las casas y la gente se interesaba cada vez más por el diseño de su nuevo hogar. Los sets se diseñaron para que se diferenciaban de los normales, que se comercializaban en cajas de brillosos colores, e incluían un libro sobre la arquitectura que proporcionaba inspiración a sus usuarios.

Décadas más tarde, el arquitecto y fan de LEGO Adam Reed Tucker reavivó la idea de expresar la arquitectura usando bricks LEGO y, en colaboración

con The LEGO Group, lanzó la línea LEGO Architecture que hoy conocemos.

Sus primeros modelos, y los sets originales de la actual serie LEGO Architecture, eran interpretaciones de los rascacielos más famosos de su ciudad natal, Chicago. Desde entonces, LEGO Architecture se ha desarrollado y ha evolucionado, primero incorporando edificios célebres de otras ciudades de Estados Unidos y, ahora, estructuras emblemáticas de Europa, Oriente Próximo y Asia.

La introducción del set LEGO Architecture Studio recupera las ambiciones de la antigua línea «Scale Model» de LEGO y amplía el potencial de la serie LEGO Architecture. Hoy puedes disfrutar mientras construyes y aprendes sobre edificios célebres, o crear tus propios modelos arquitectónicos a partir de tu imaginación. Un instructivo libro de 270 páginas con materiales creados por arquitectos internacionales de gran reputación te guiará a través de los principios de la arquitectura y te animará a dar tus primeros pasos en el mundo de la construcción creativa.



21050
Studio

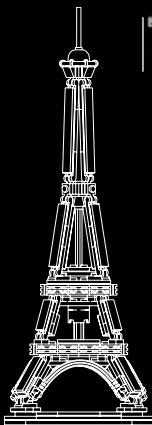
Celebrate the world of architecture and collect all the models
Célébrez le monde de l'architecture et collectionnez tous les modèles
Celebra el mundo de la arquitectura y colecciona todos los modelos



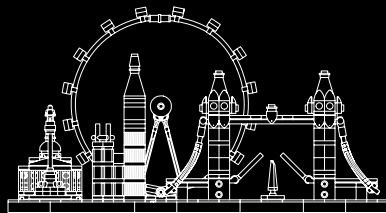
21024
Louvre



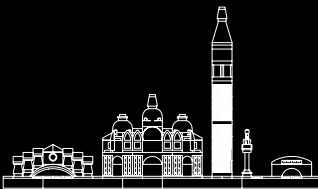
21030
United States Capitol Building
Le Capitole des États-Unis
Edificio del Capitolio de Estados Unidos



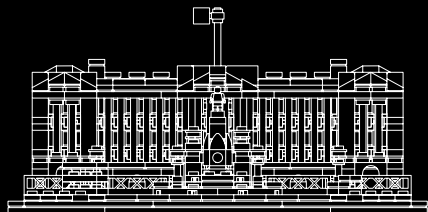
21019
The Eiffel Tower
La tour Eiffel
La torre Eiffel



21034
London
Londres



21026
Venice
Venise
Venecia



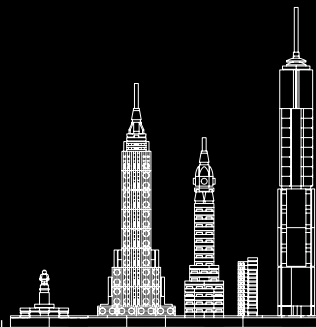
21029
Buckingham Palace
Le palais de Buckingham
Palacio de Buckingham



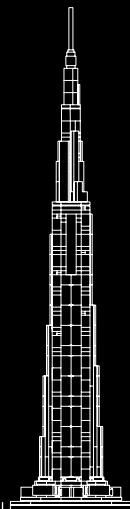
21033
Chicago



21027
Berlin
Berlin



21028
New York City
New York
Nueva York



21031
Burj Khalifa

References

Pictures -

© Shutterstock

Michael Moy

Ralph Alphonso

Text -

www.sydneyoperahouse.com

www.sydneyharbourbridge.info

www.sydneytowereye.com.au

www.fosterandpartners.com

www.sydneylivingmuseums.com.au

Références :

Images -

© Shutterstock

Michael Moy

Ralph Alphonso

Texte -

www.sydneyoperahouse.com

www.sydneyharbourbridge.info

www.sydneytowereye.com.au

www.fosterandpartners.com

www.sydneylivingmuseums.com.au

Referencias:

Fotografías -

© Shutterstock

Michael Moy

Ralph Alphonso

Texto -

www.sydneyoperahouse.com

www.sydneyharbourbridge.info

www.sydneytowereye.com.au

www.fosterandpartners.com

www.sydneylivingmuseums.com.au

Customer Service

Kundenservice

Service Consommateurs














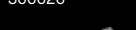











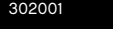











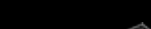







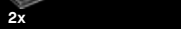











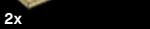


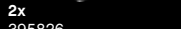













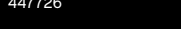

Servicio Al Consumidor

LEGO.com/service or dial



00800 5346 5555 :

1-800-422-5346 :

 2x 6052824	 8x 6116602	 5x 4114026	 2x 4206482	 4x 302226	 6x 366626	 4x 4266417	 1x 4543949
 22x 4613256	 1x 302101	 8x 6092587	 2x 6116606	 4x 6052126	 7x 379526	 4x 4260426	 21x 6066097
 4x 6097801	 2x 302001	 3x 4113917	 2x 6121485	 7x 4515368	 4x 4653049	 3x 4496699	 4x 4211356
 10x 6059271	 5x 6081986	 3x 4114084	 4x 6066102	 1x 4500978	 2x 416226	 2x 4249891	 2x 6078236
 2x 6046384	 4x 6145570	 2x 4162465	 6x 302426	 3x 4180087	 2x 416226	 9x 4528981	 1x 6189102
 7x 302301	 18x 4159553	 8x 4550324	 2x 6092664	 2x 6174627	 2x 395826	 2x 4296785	 3x 6189071
 2x 6093526	 4x 4125253	 2x 6122047	 2x 4512363	 4x 6116604	 3x 447726	 4x 4177735	
 6x 302201	 8x 4213568	 2x 4114001	 2x 366526	 6x 243126	 31x 4667222	 4x 4530028	
 6x 4612342	 4x 4624086	 2x 4114001	 3x 4535739	 8x 371026	 3x 447726	 14x 4667595	
 2x 4515364	 6x 6174919	 1x 4142865	 2x 6093525	 8x 371026	 31x 4667222	 6x 6055171	

