

1

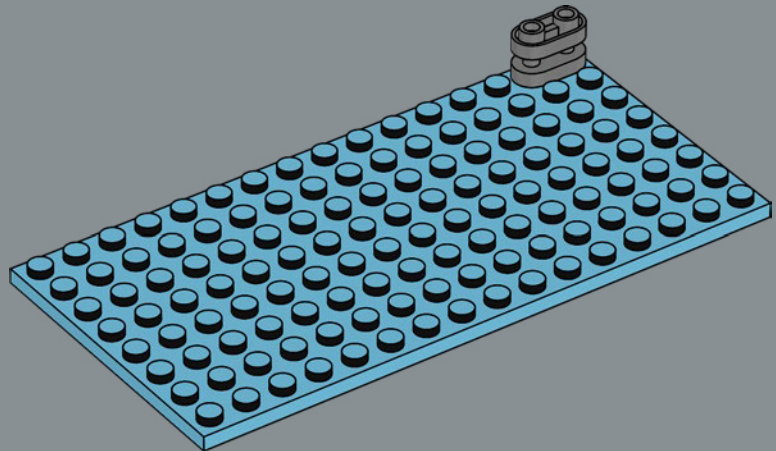

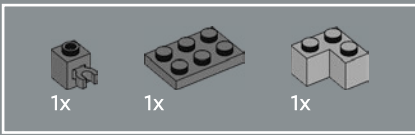

2

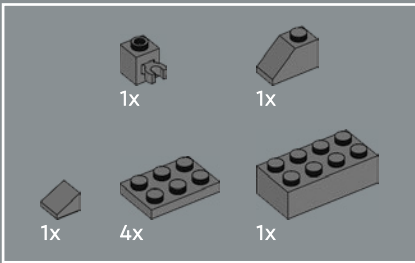
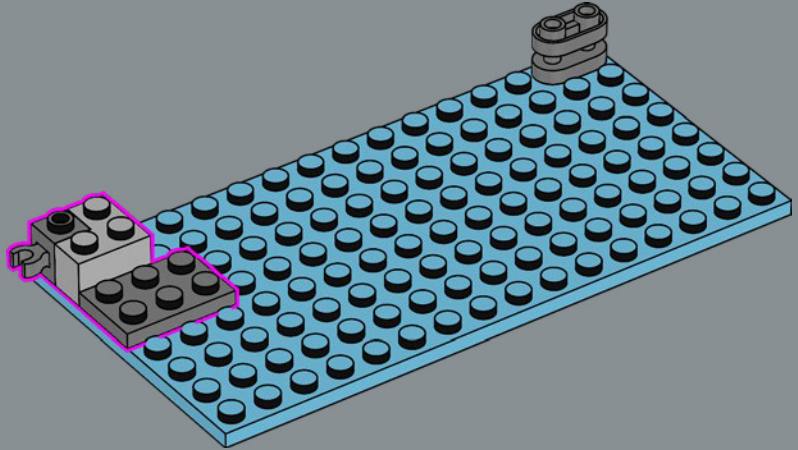

3

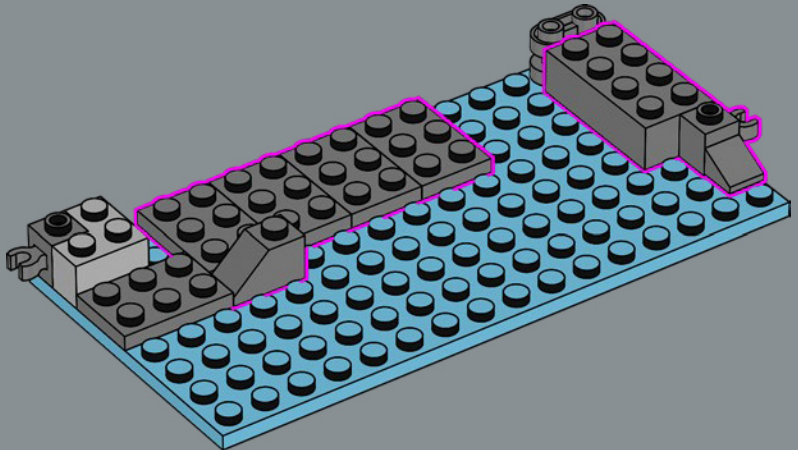

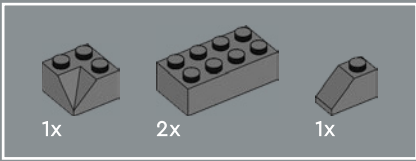

4

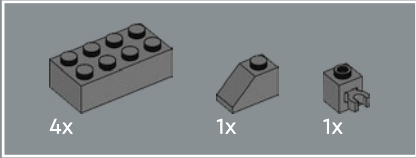
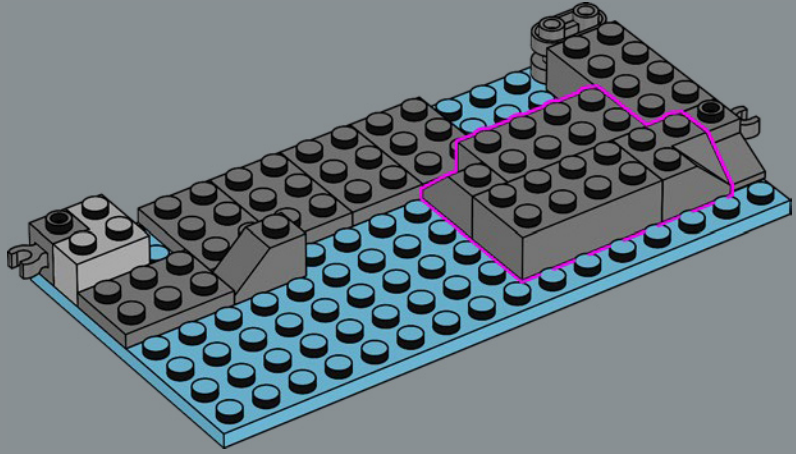

5

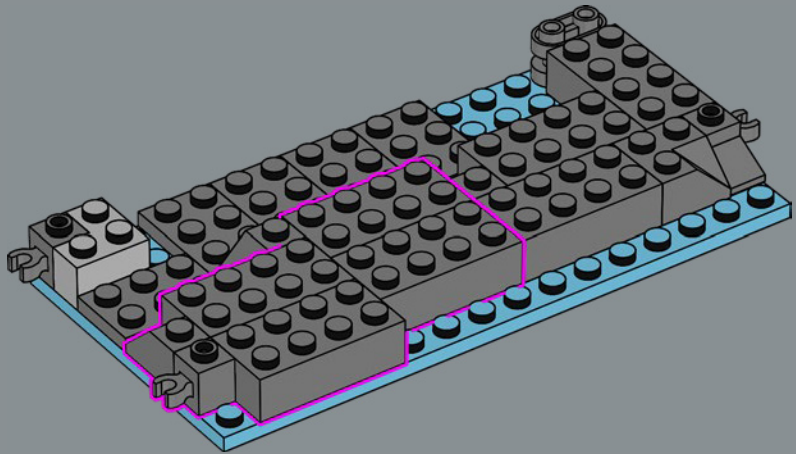

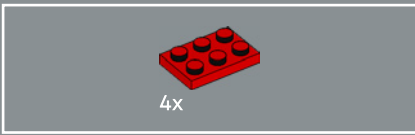

6

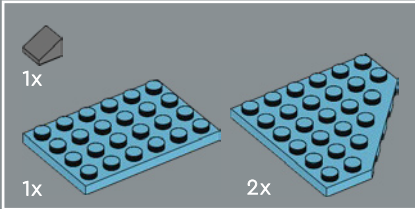
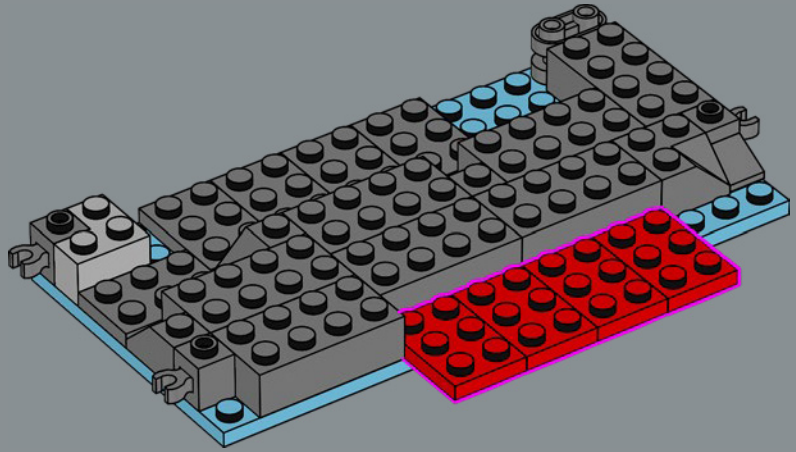

7

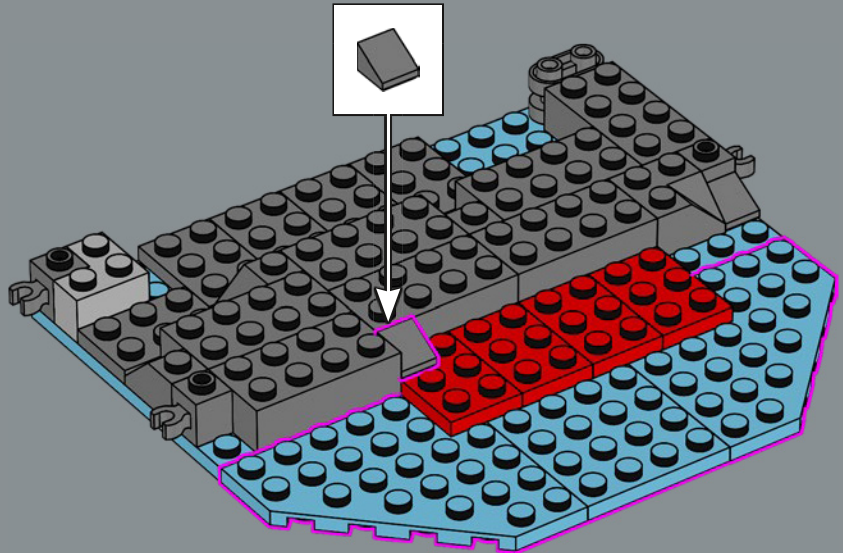

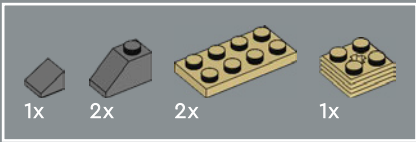

8

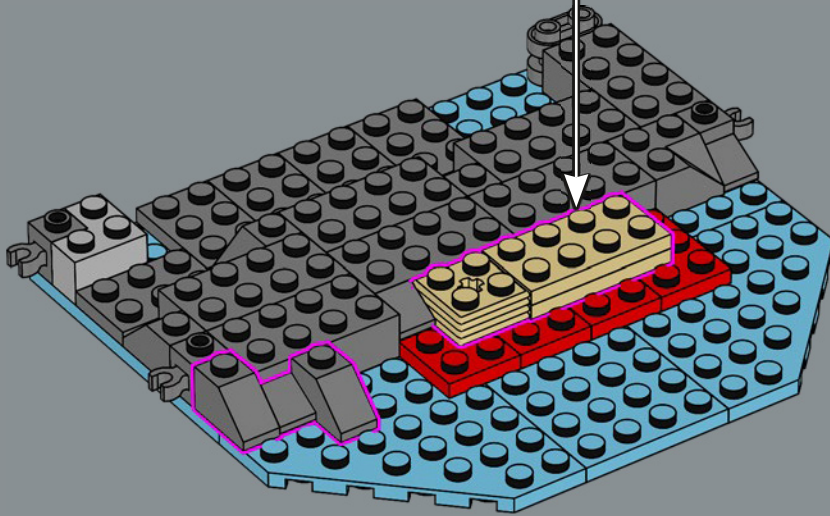
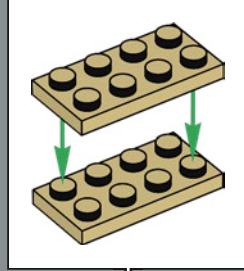





9

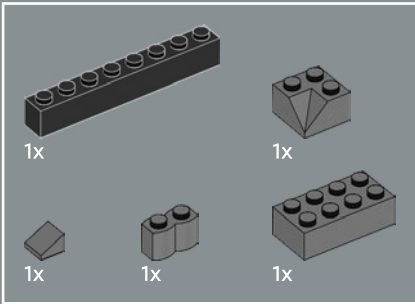
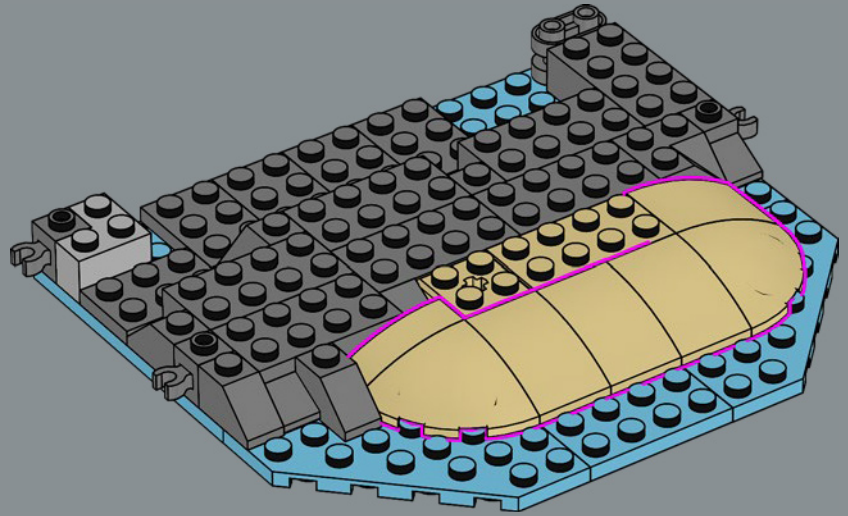

10

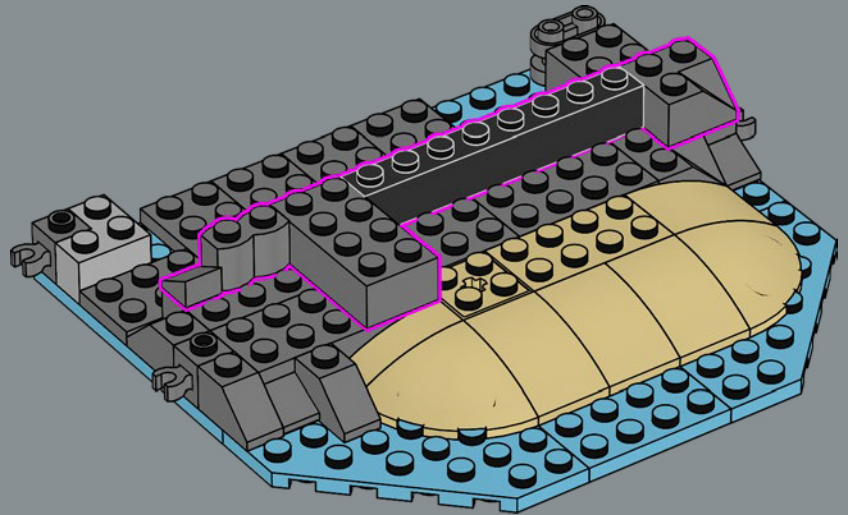

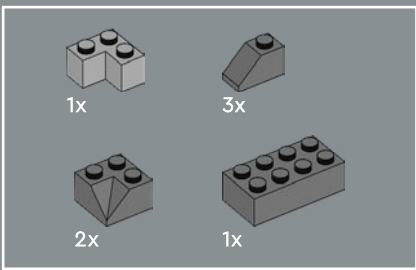

11

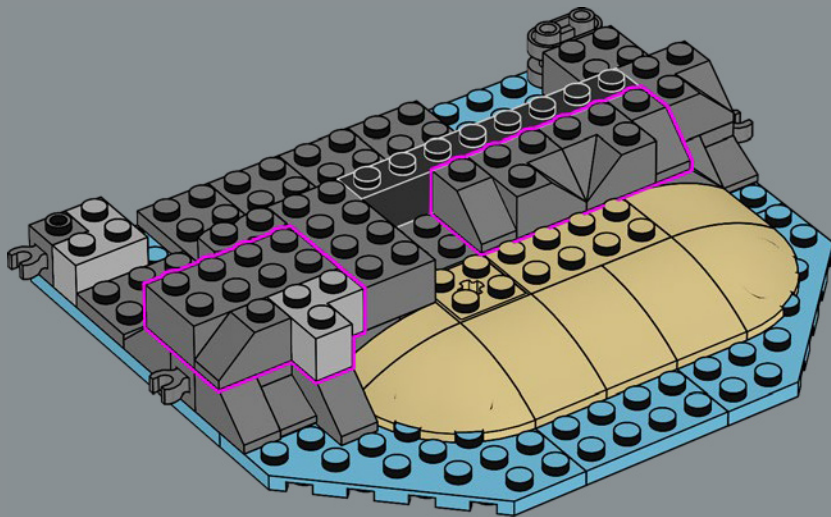

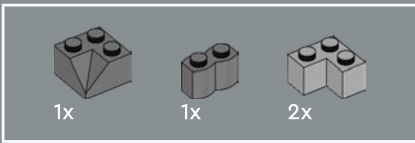

12

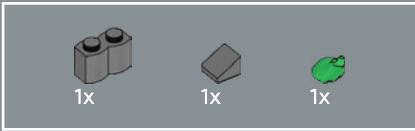
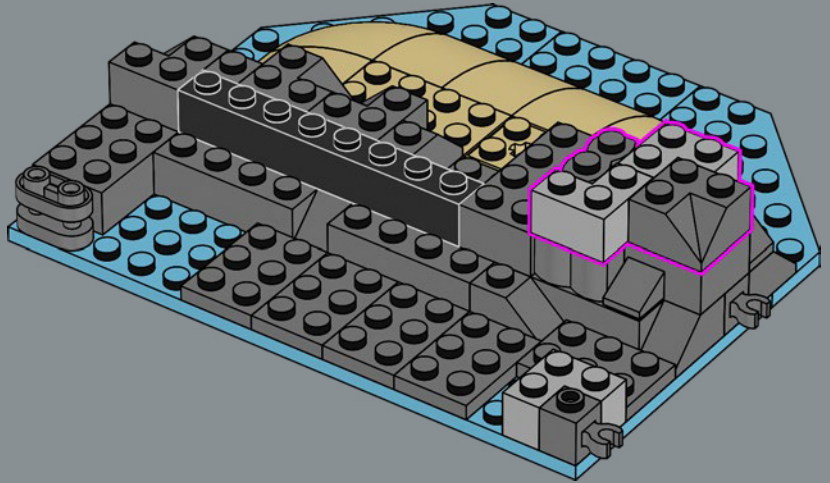

13

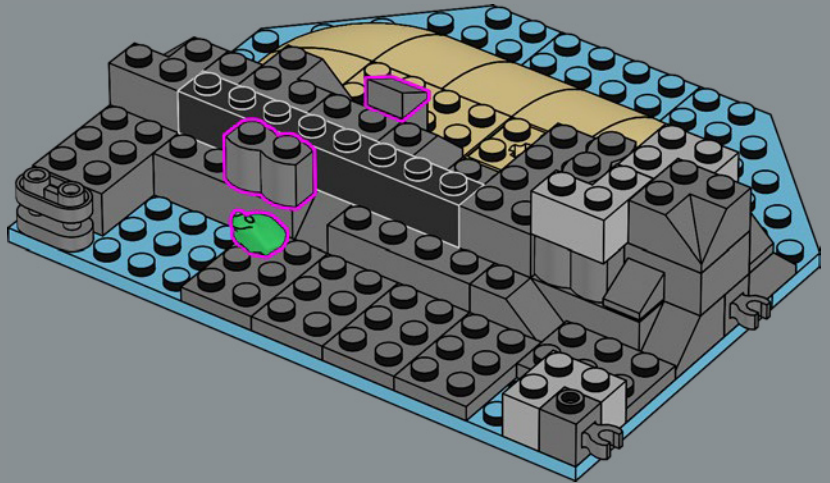

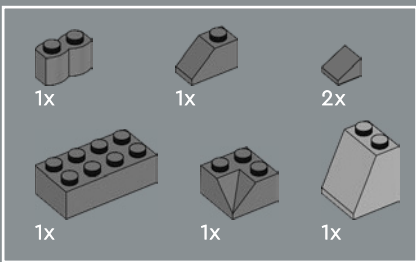

14

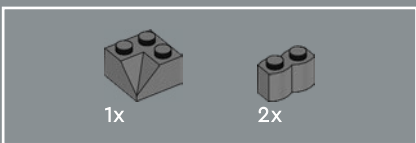
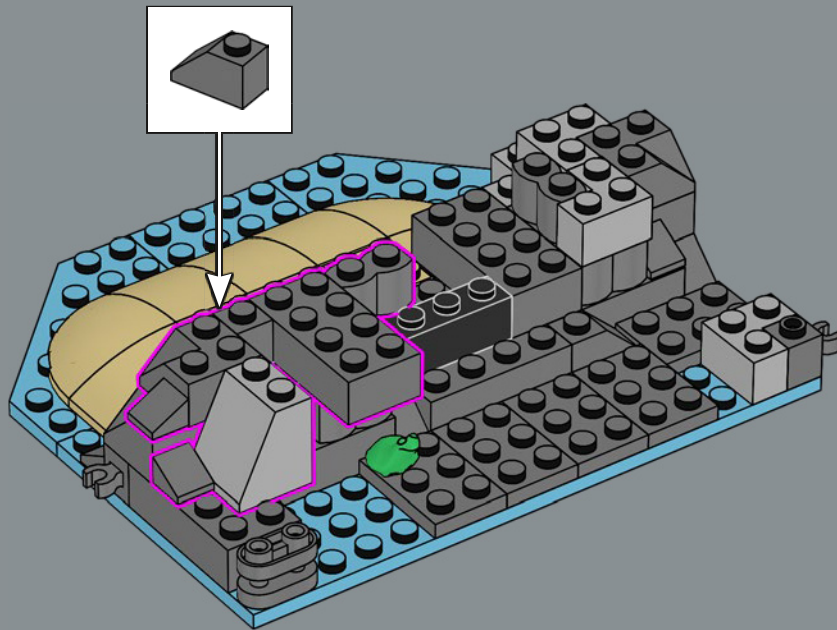

15

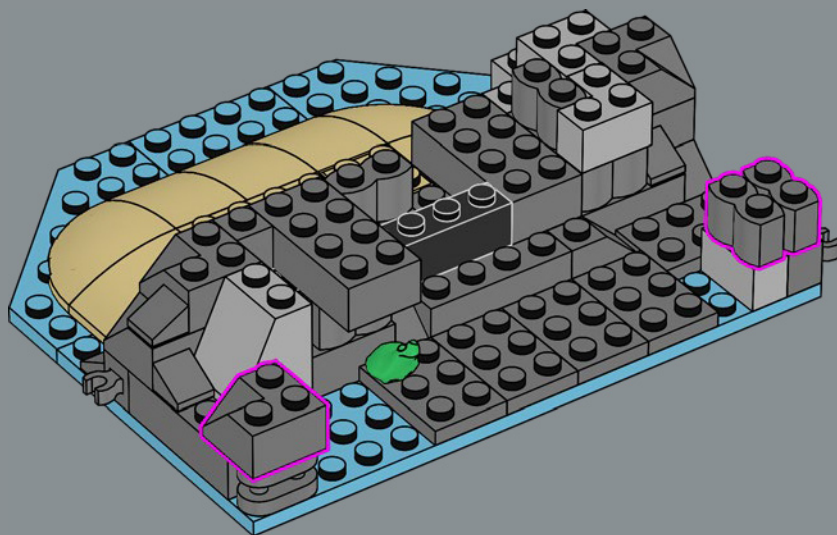

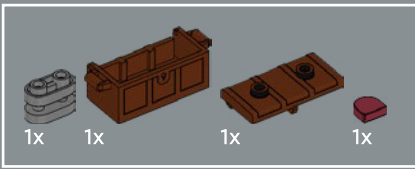

16

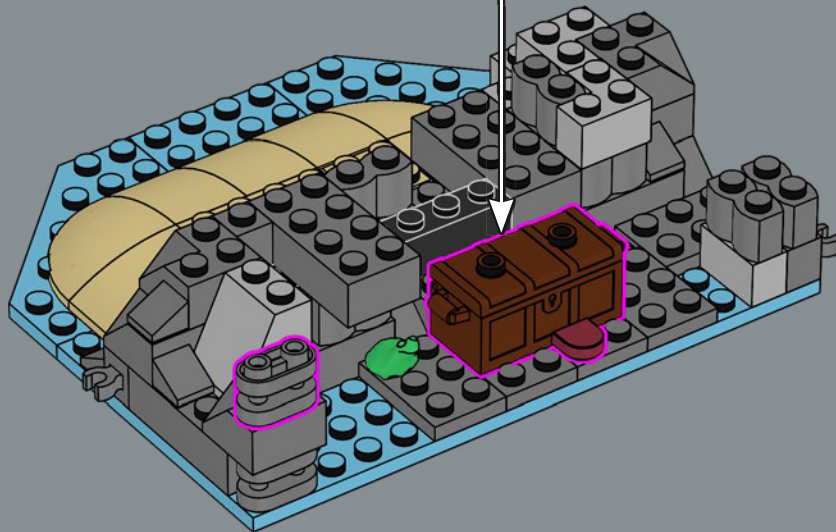
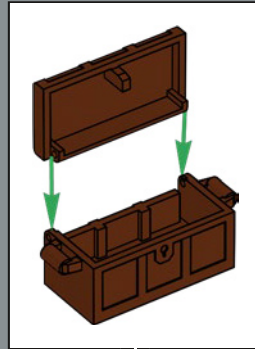

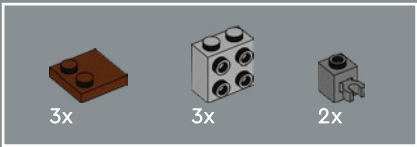

17

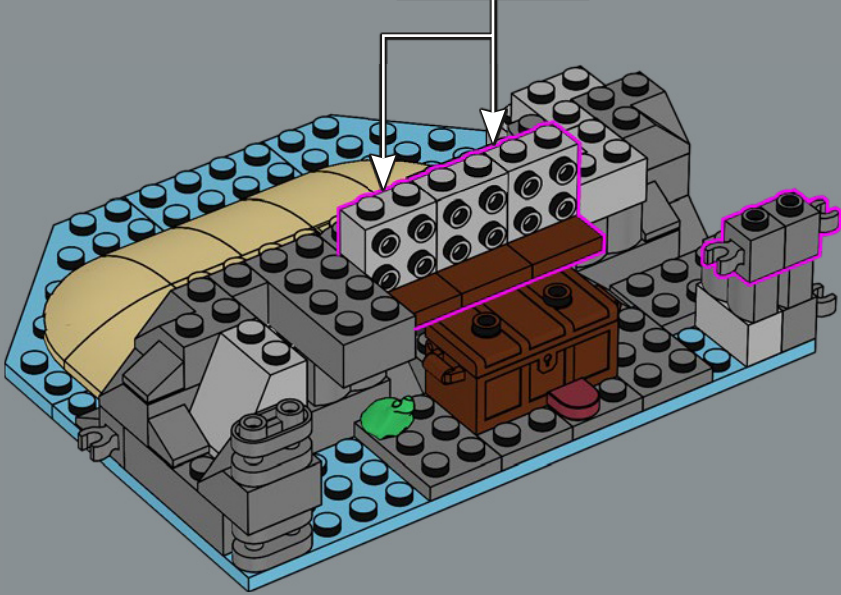
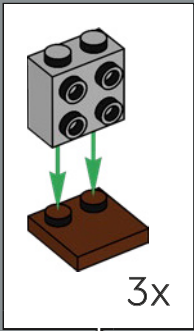



18

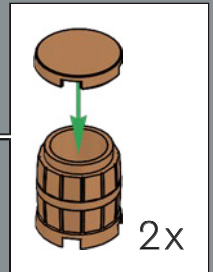
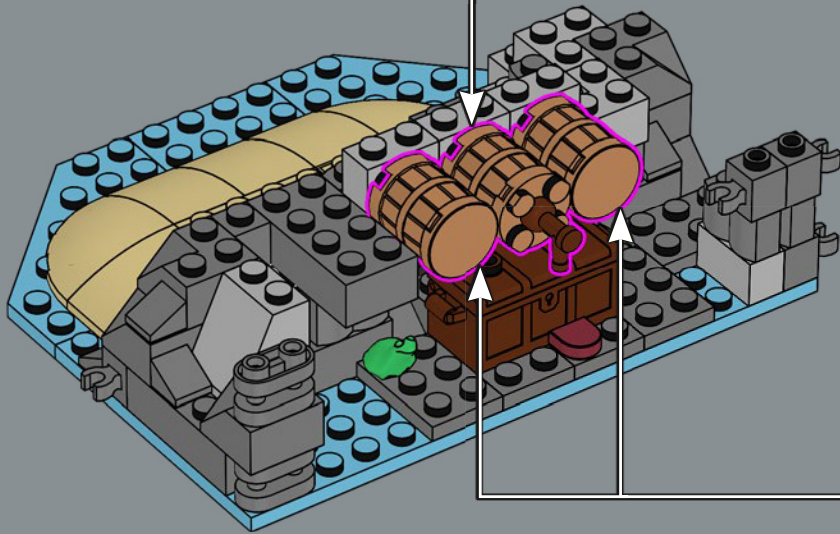
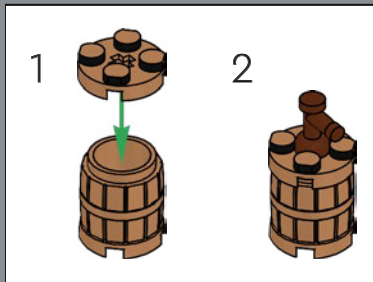

La botte perde. Forse i pirati avrebbero dovuto esercitarsi a sparare altrove...

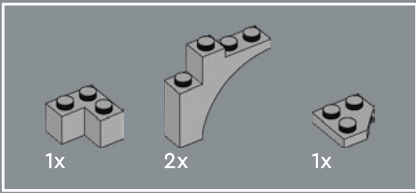

17

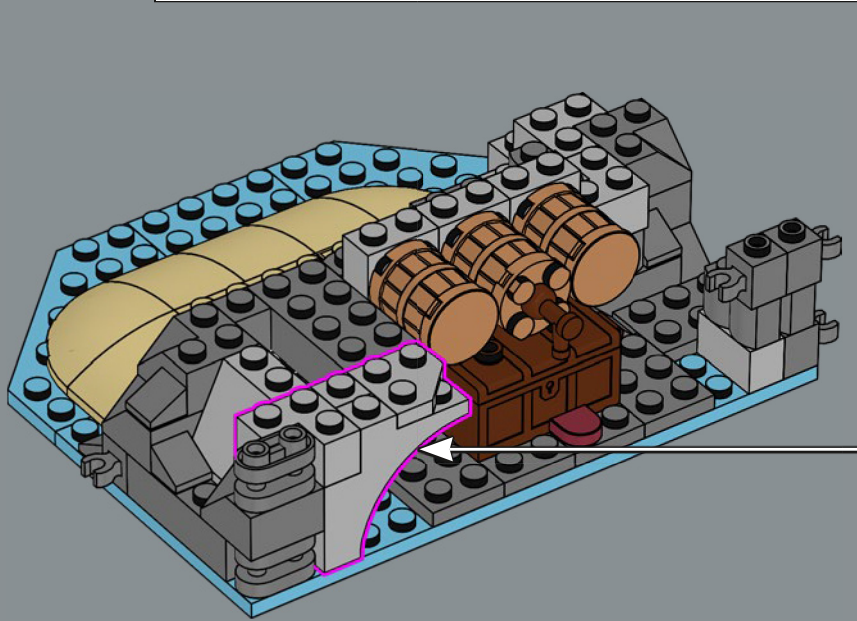
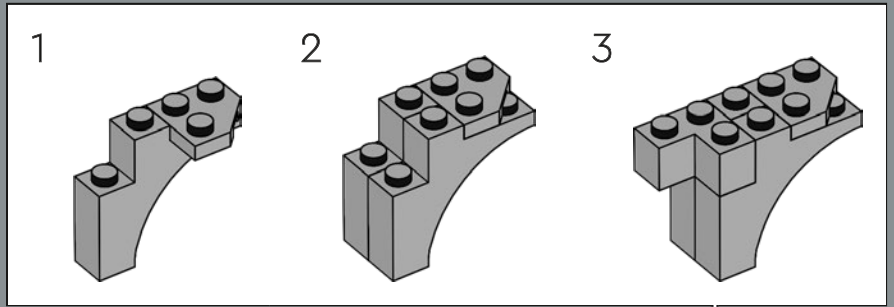



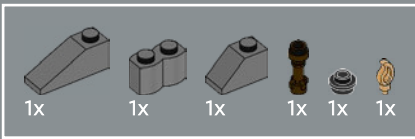

20

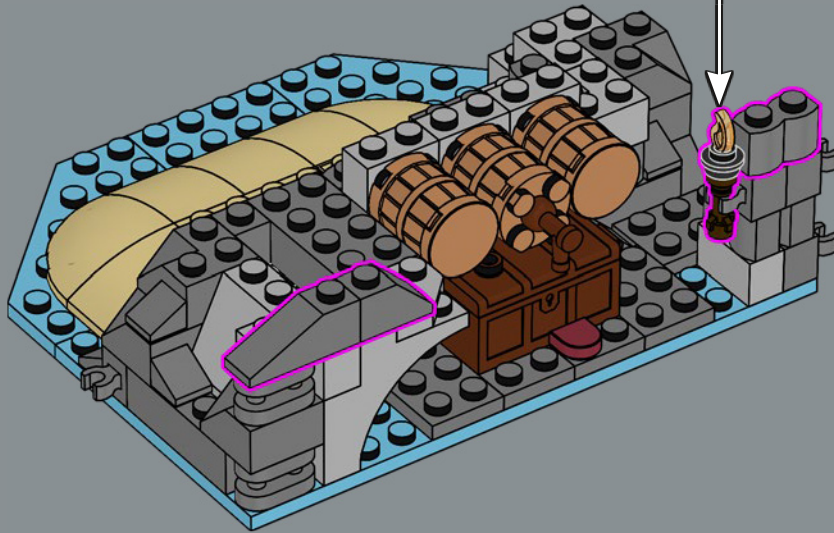
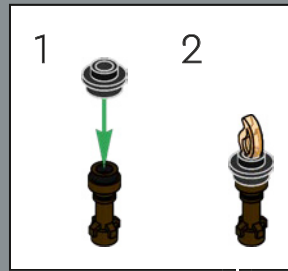

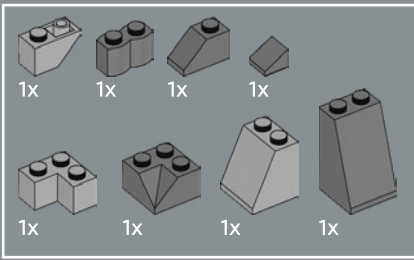

21

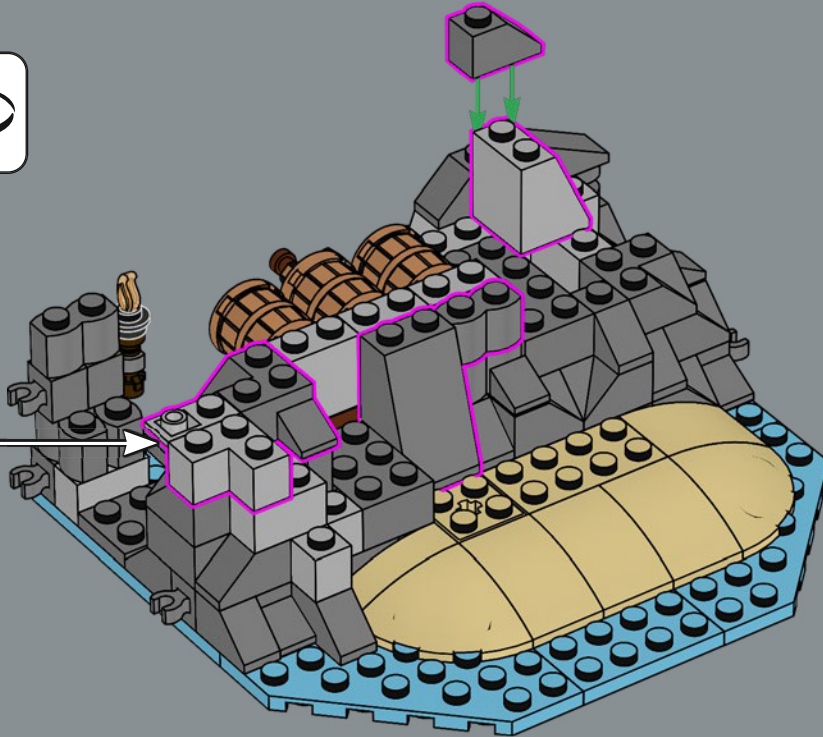
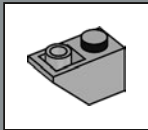

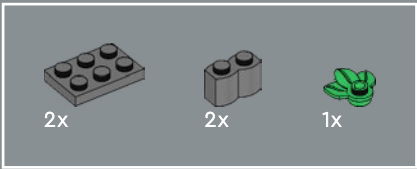

22

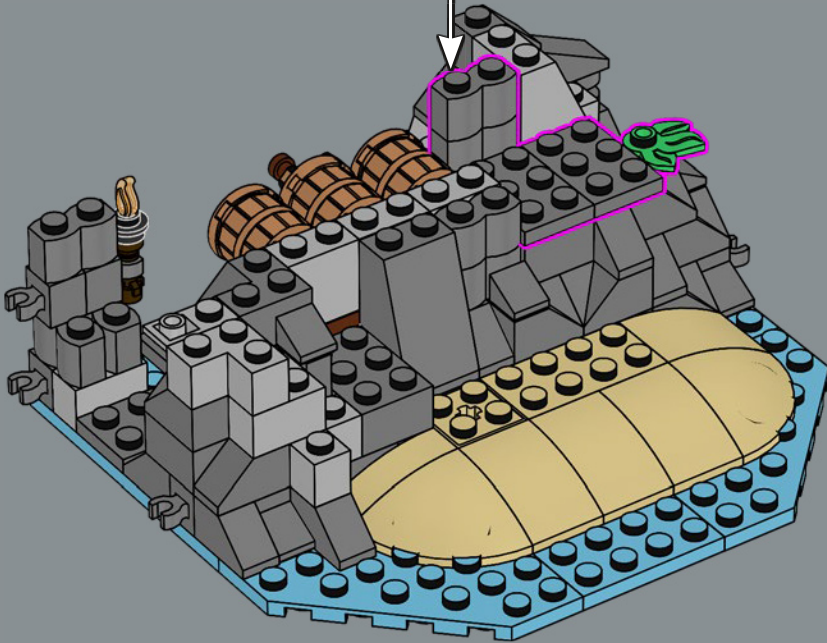
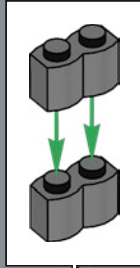

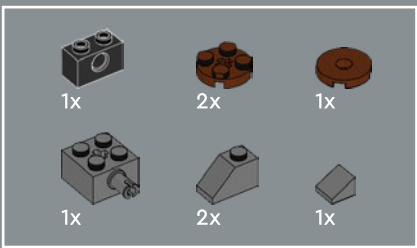

23

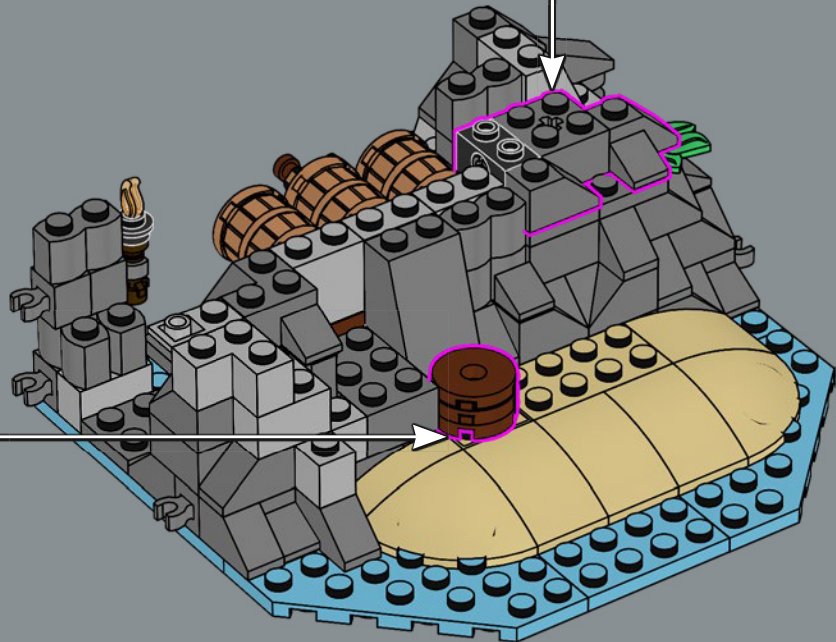
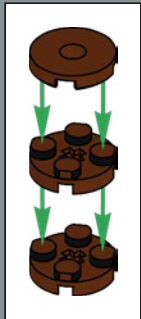
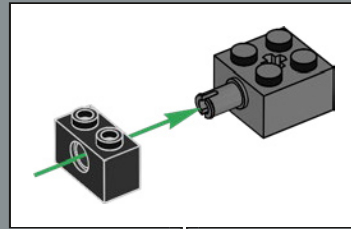

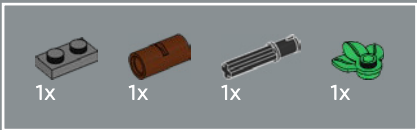

24

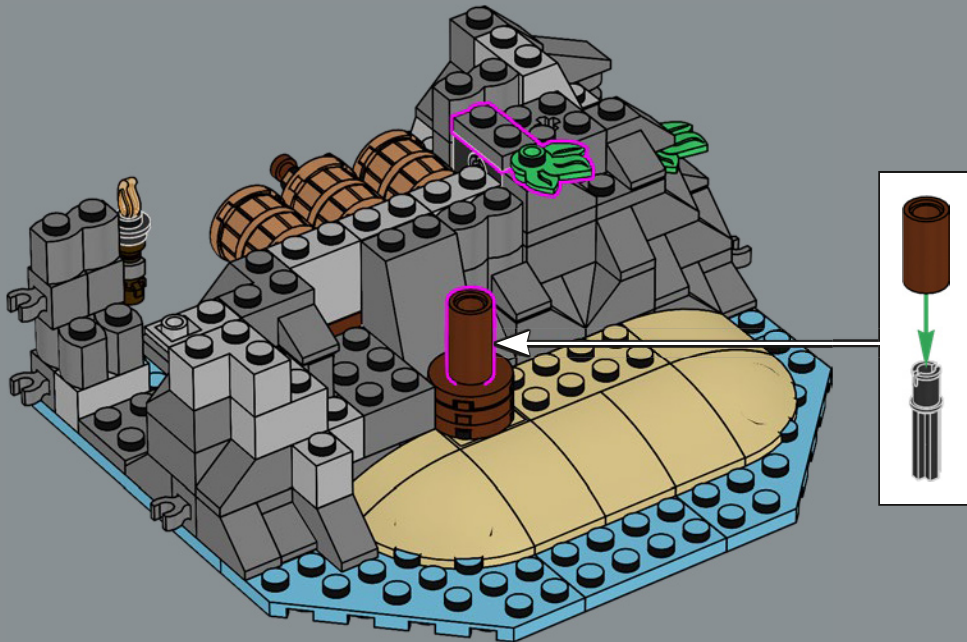

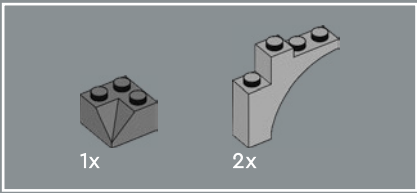

25

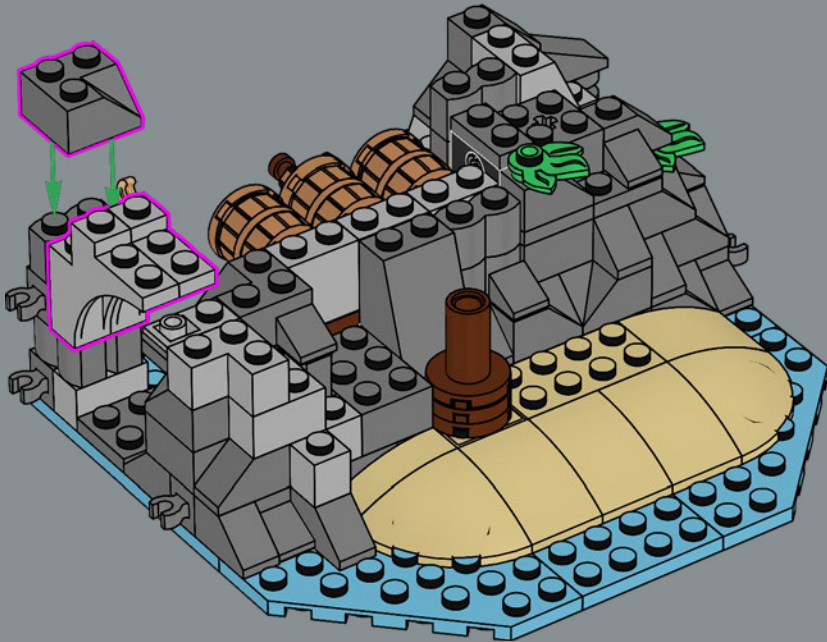

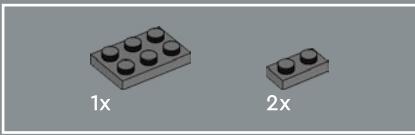

26

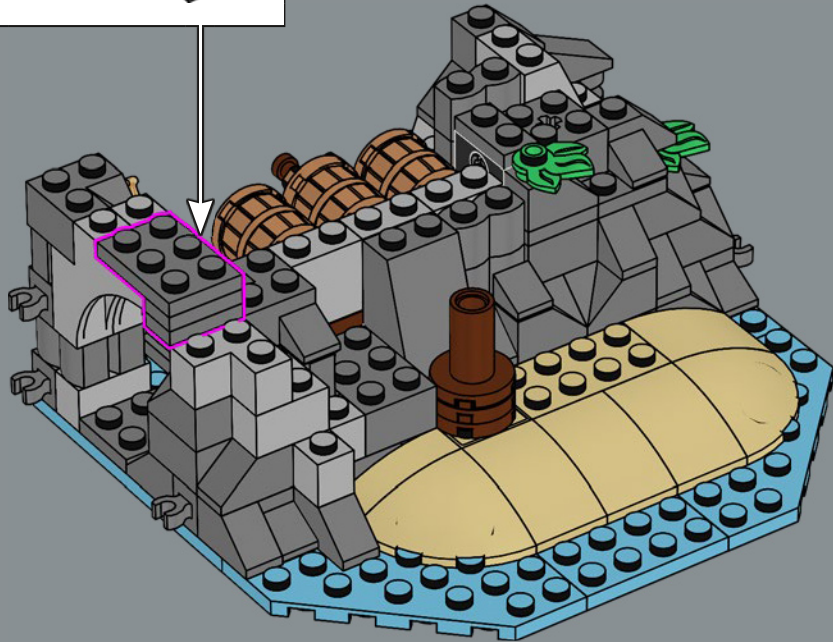
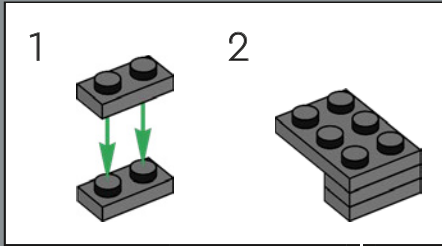

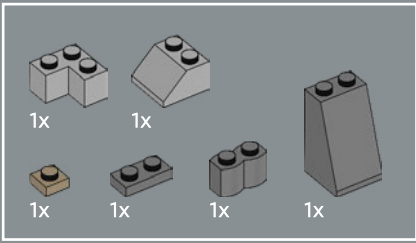

27

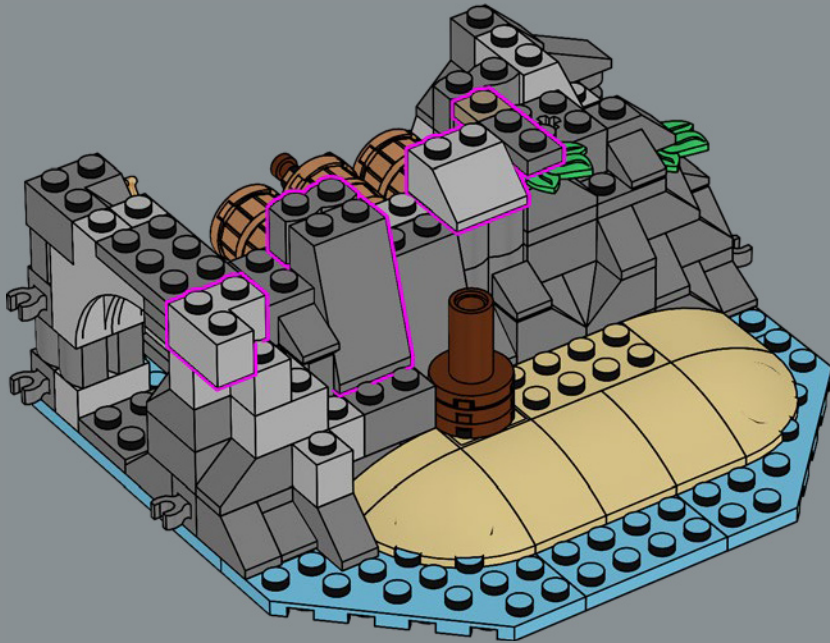



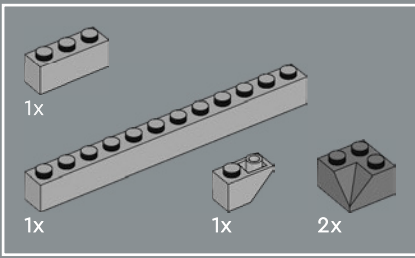

28

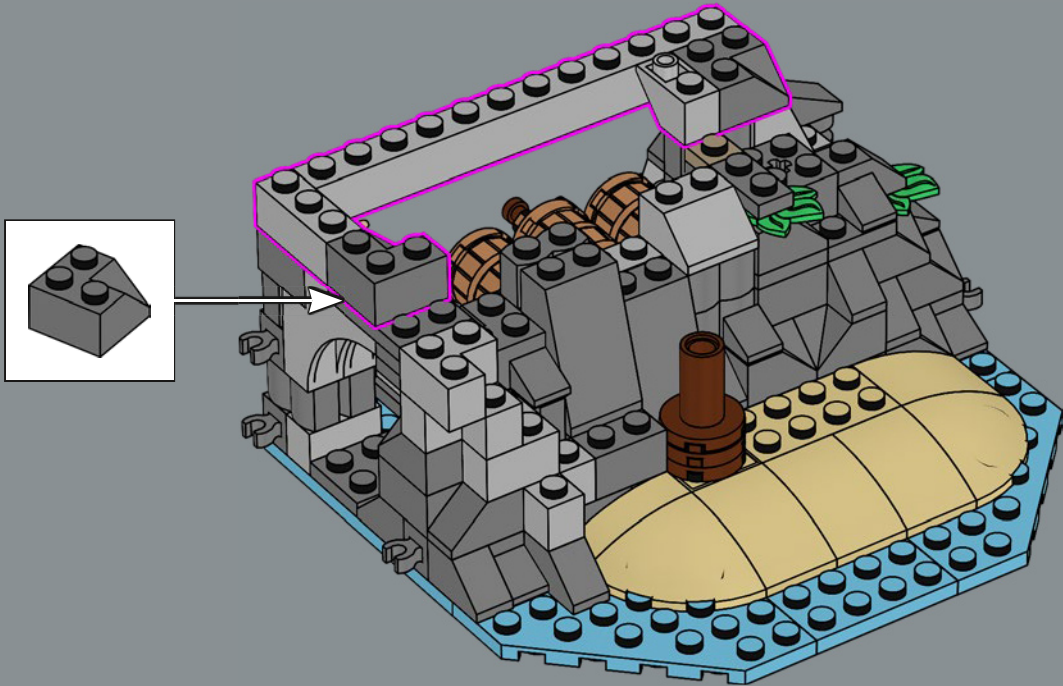

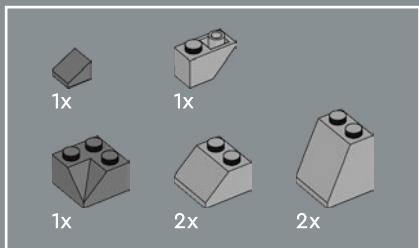

29

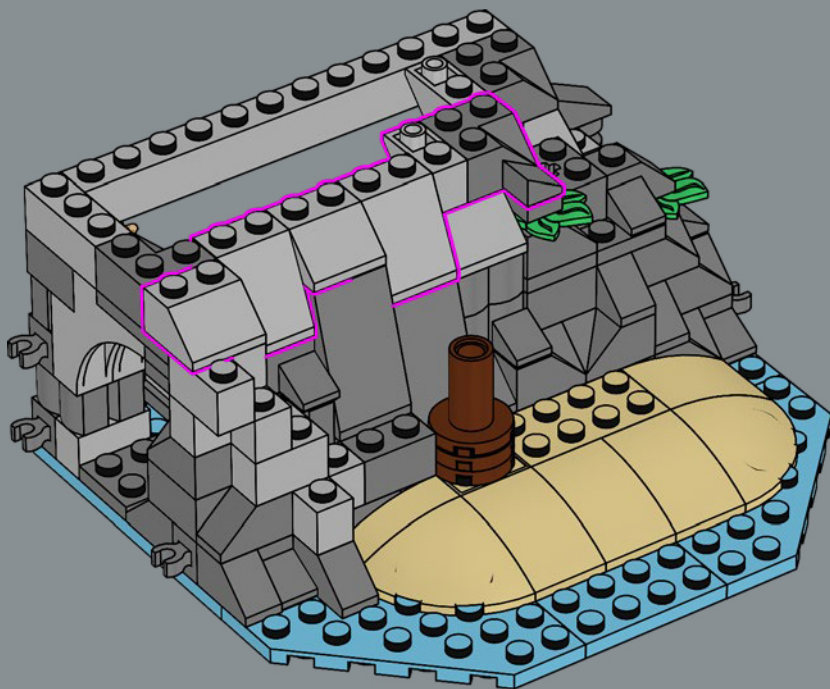

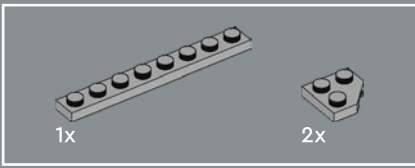

30

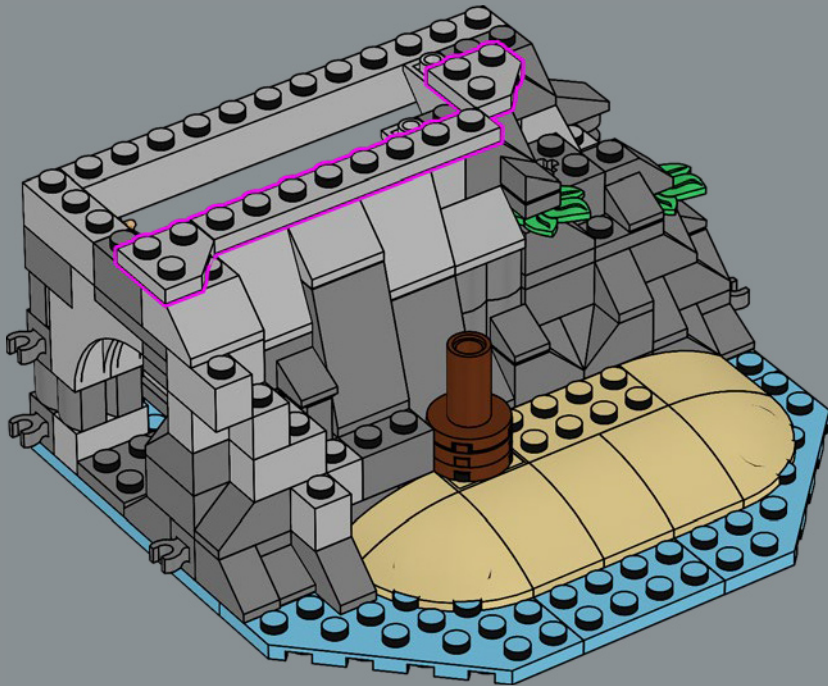

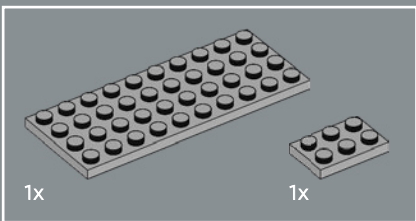

31

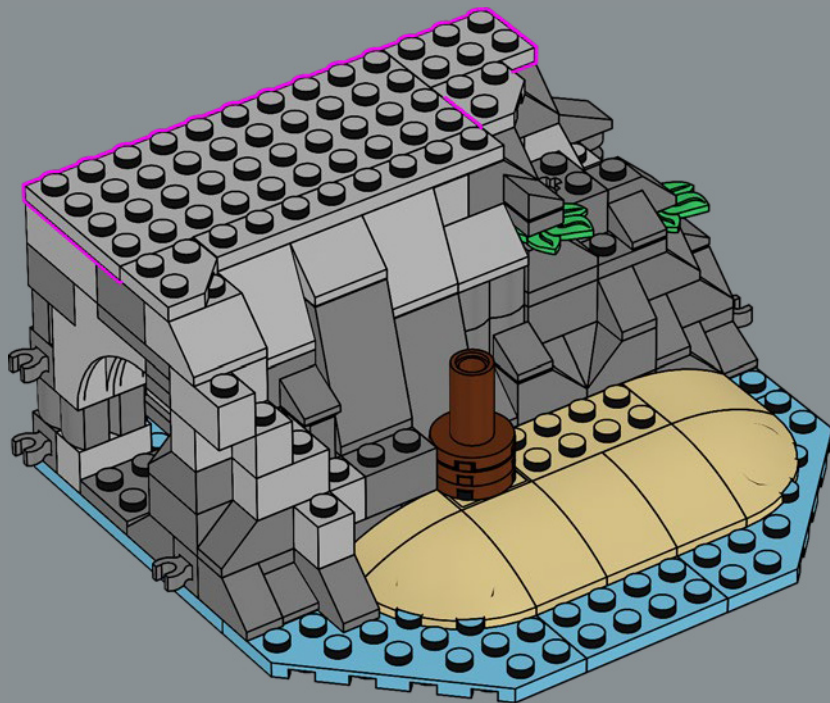

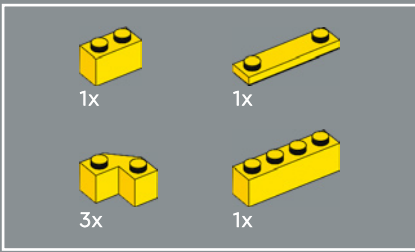

32

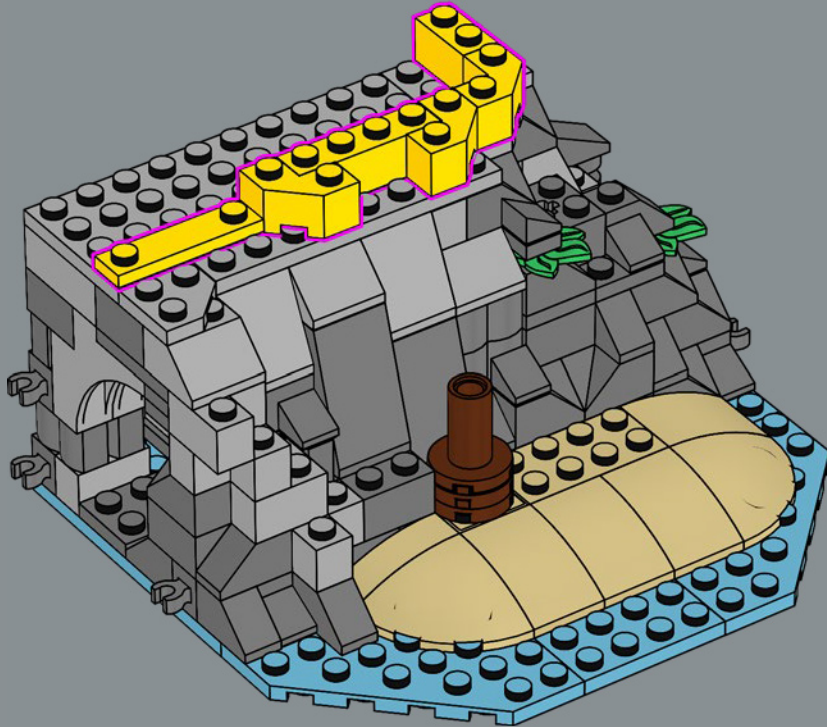



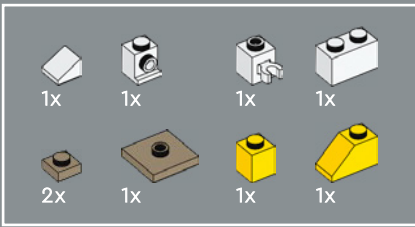

34

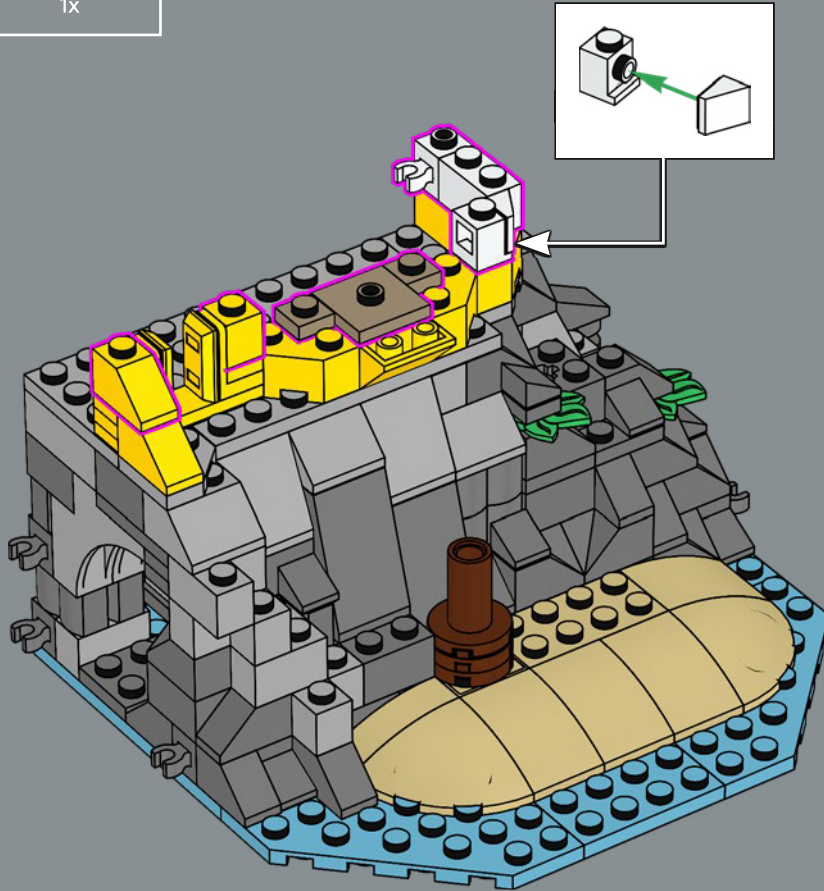

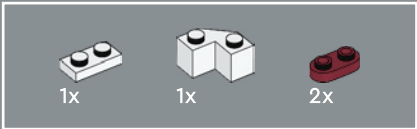

35

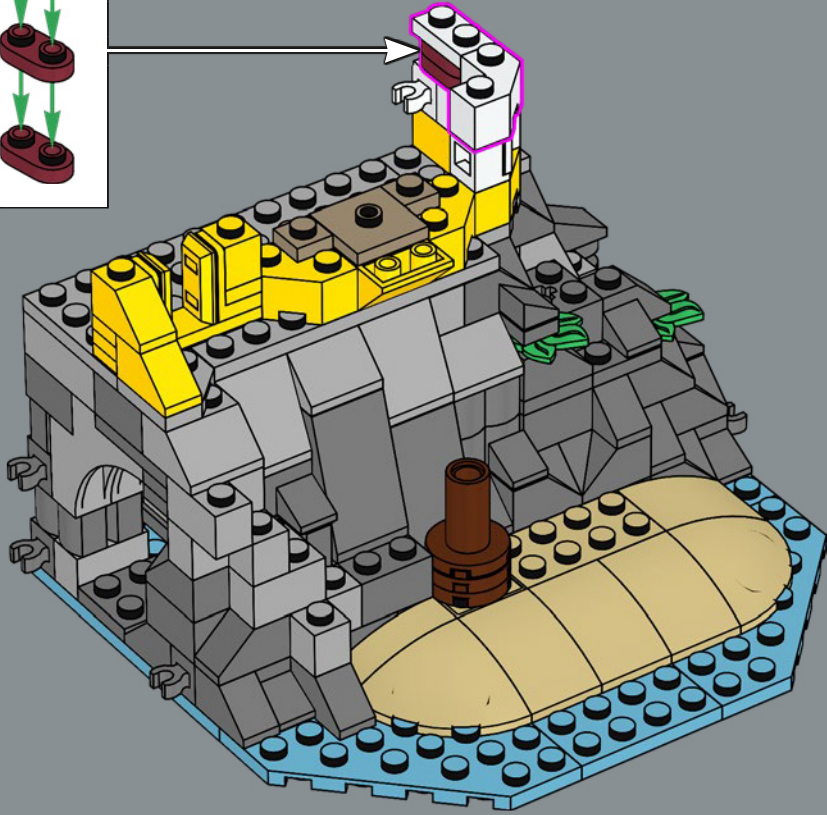
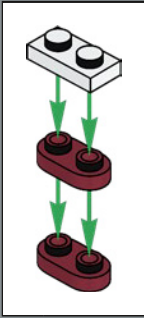



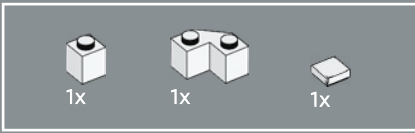

36

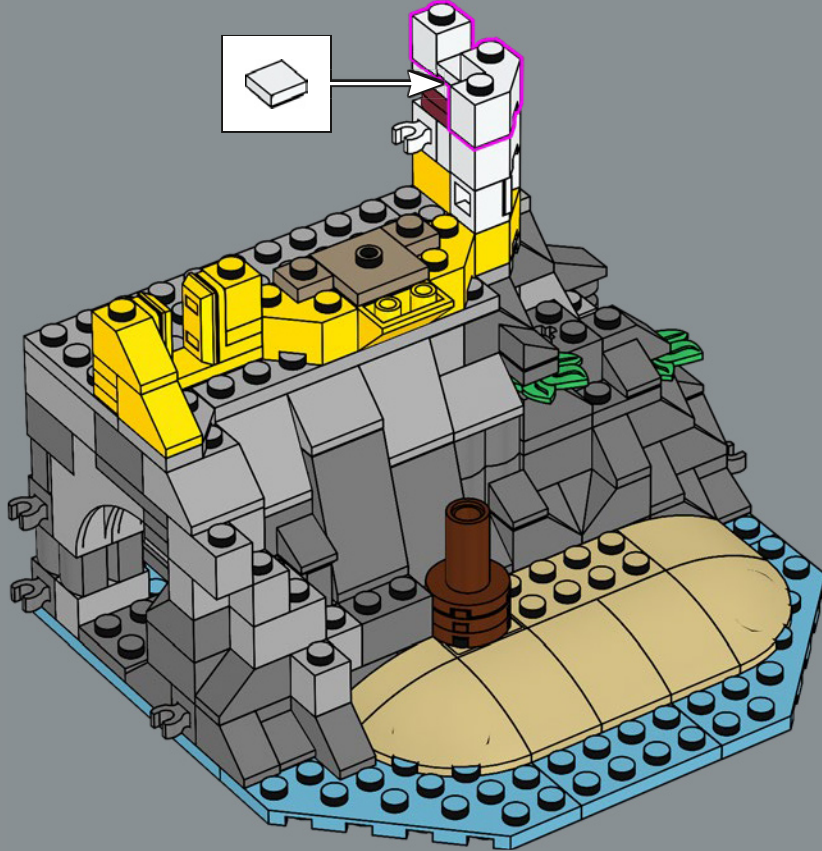

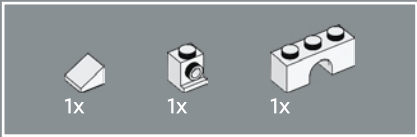

37

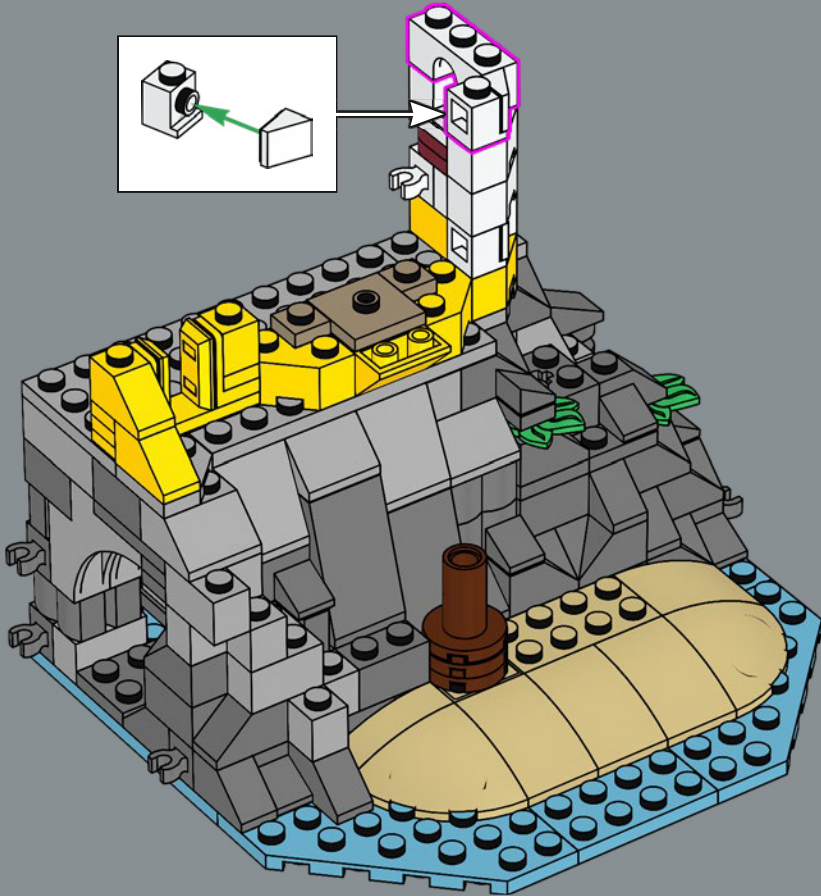

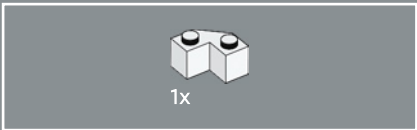

38

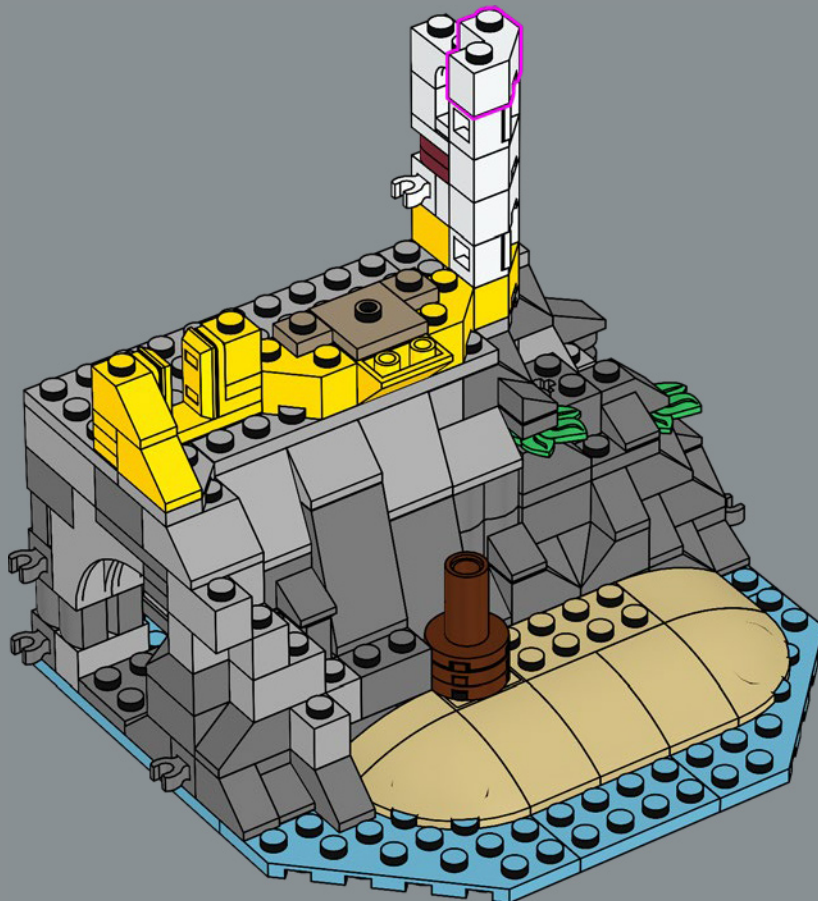

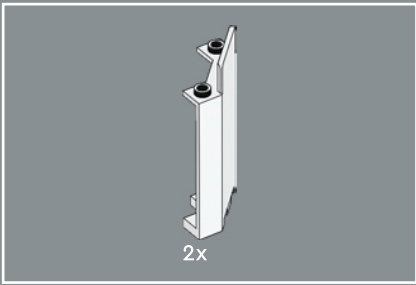

39

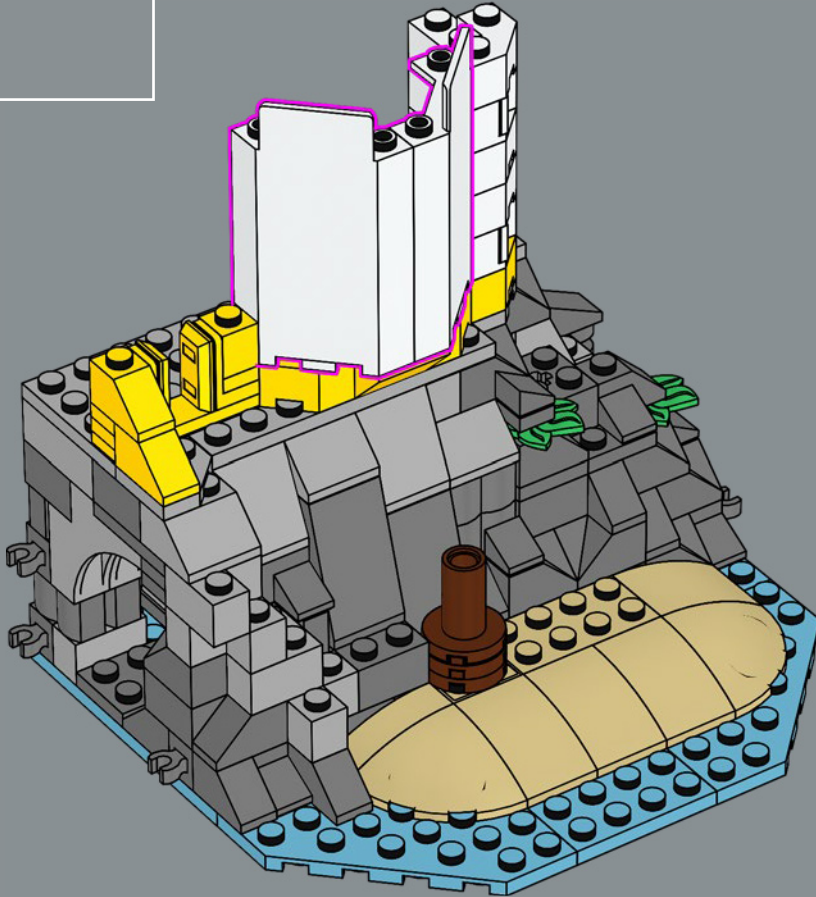



40

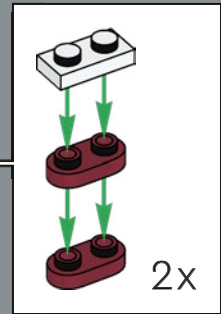
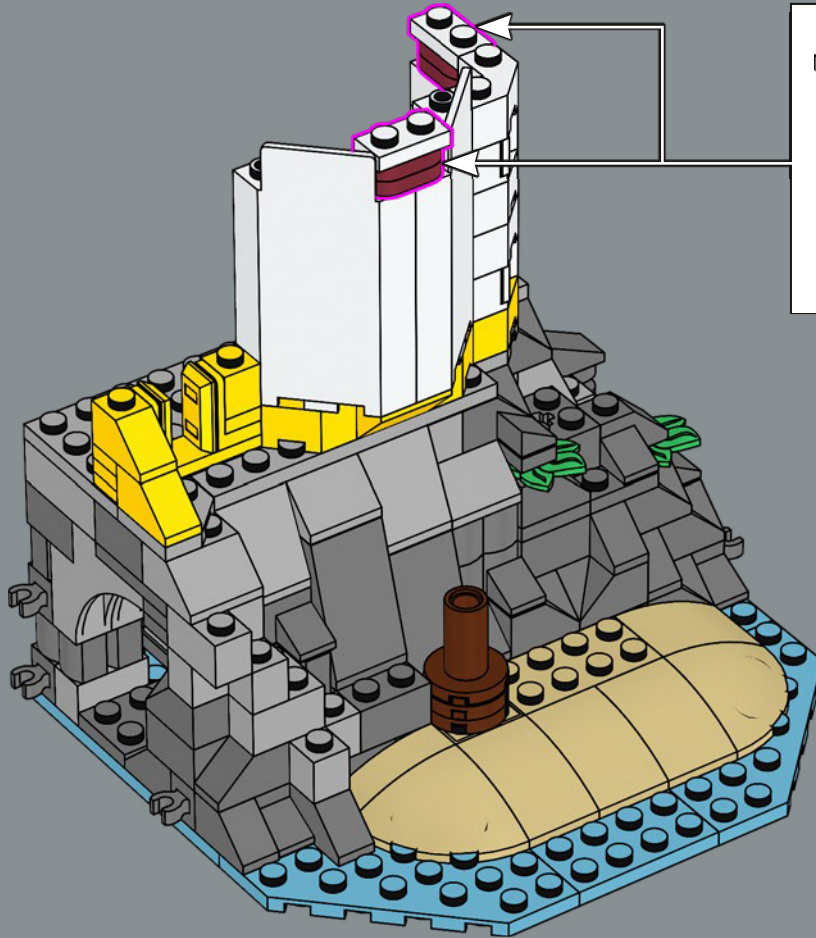

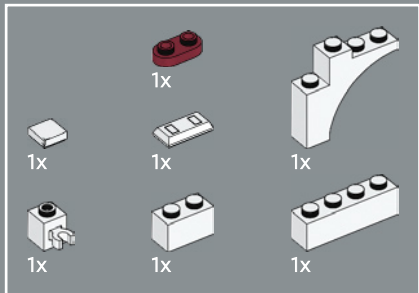

41

1

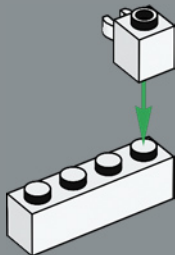

2

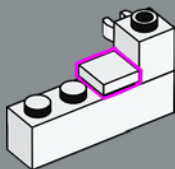

3

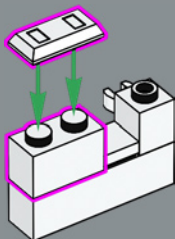

4

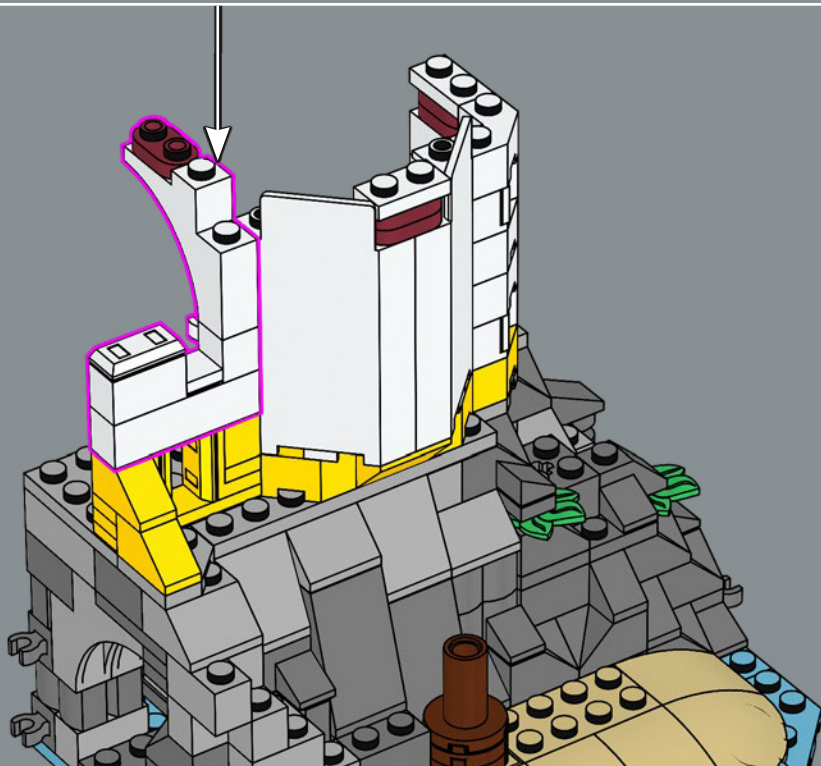
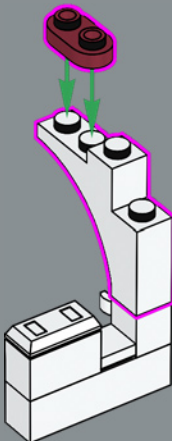

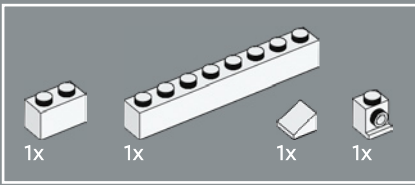

42

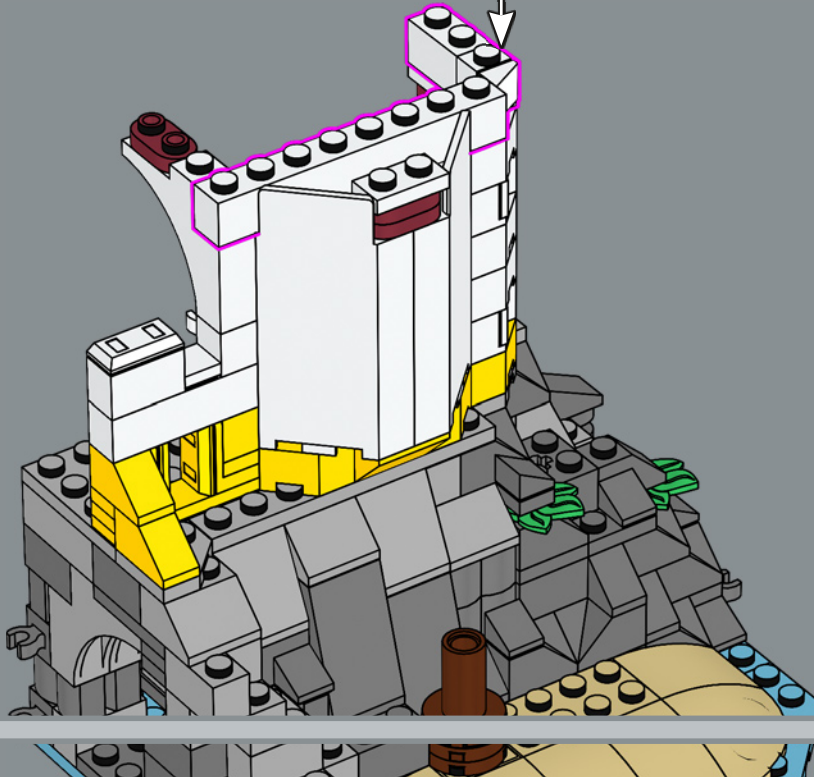
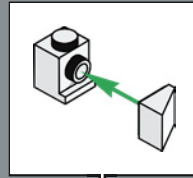

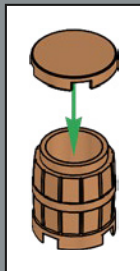
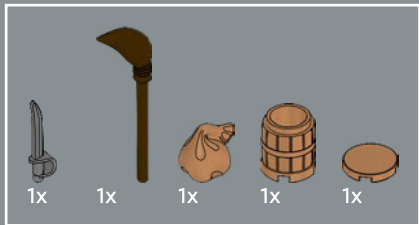

43

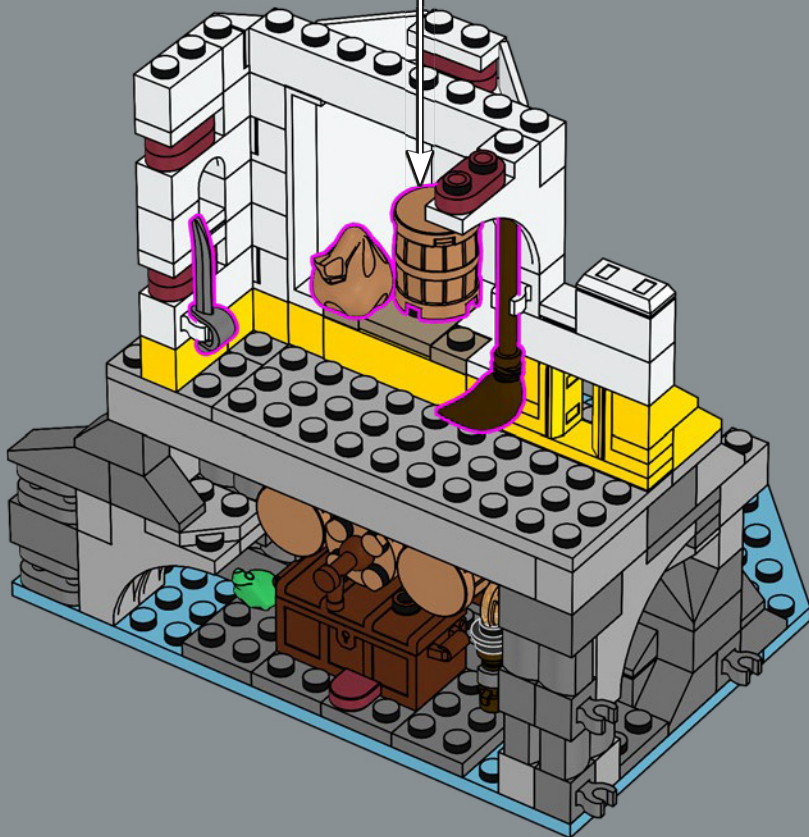



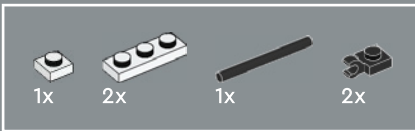

44

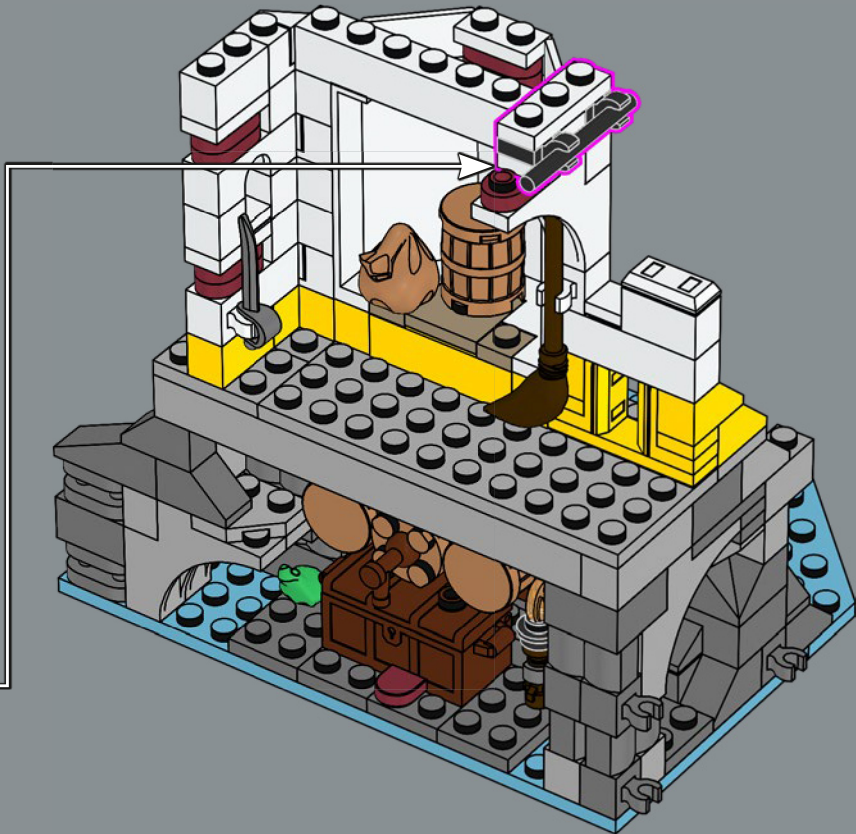
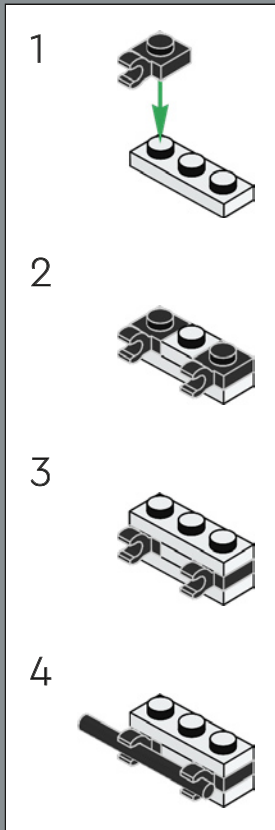

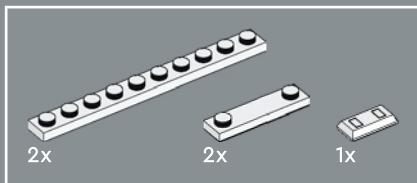

45

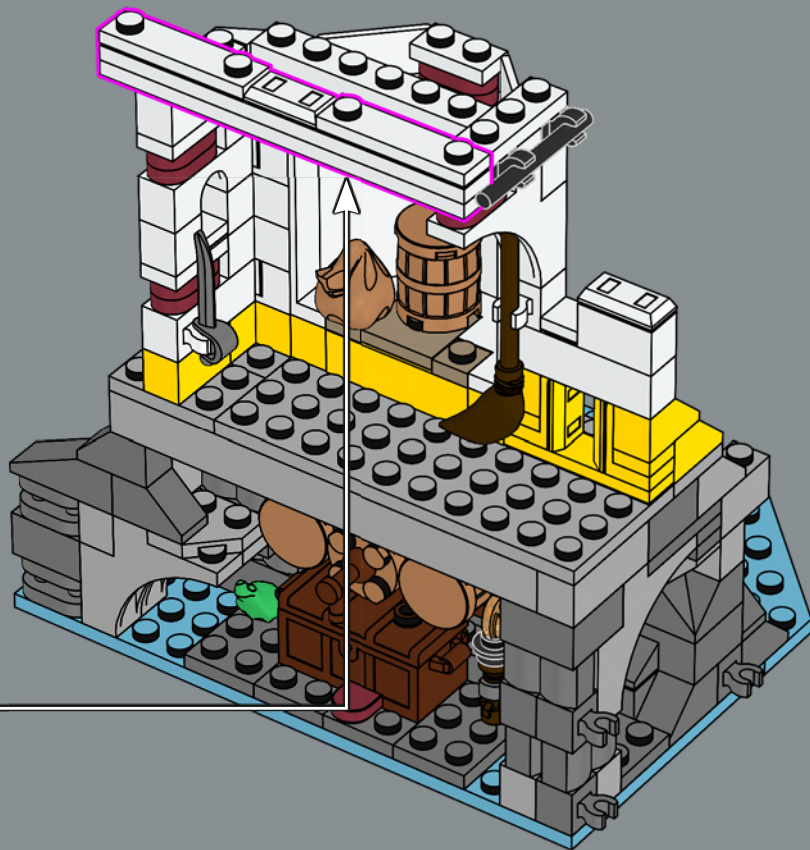
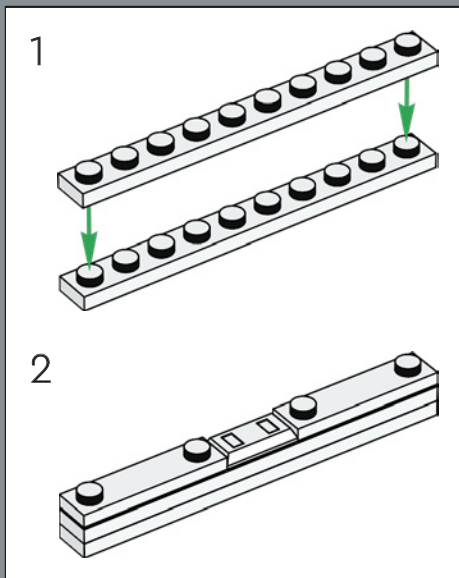

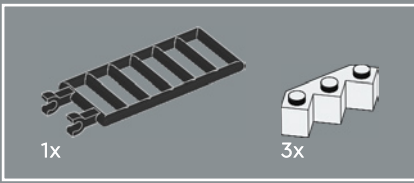

46

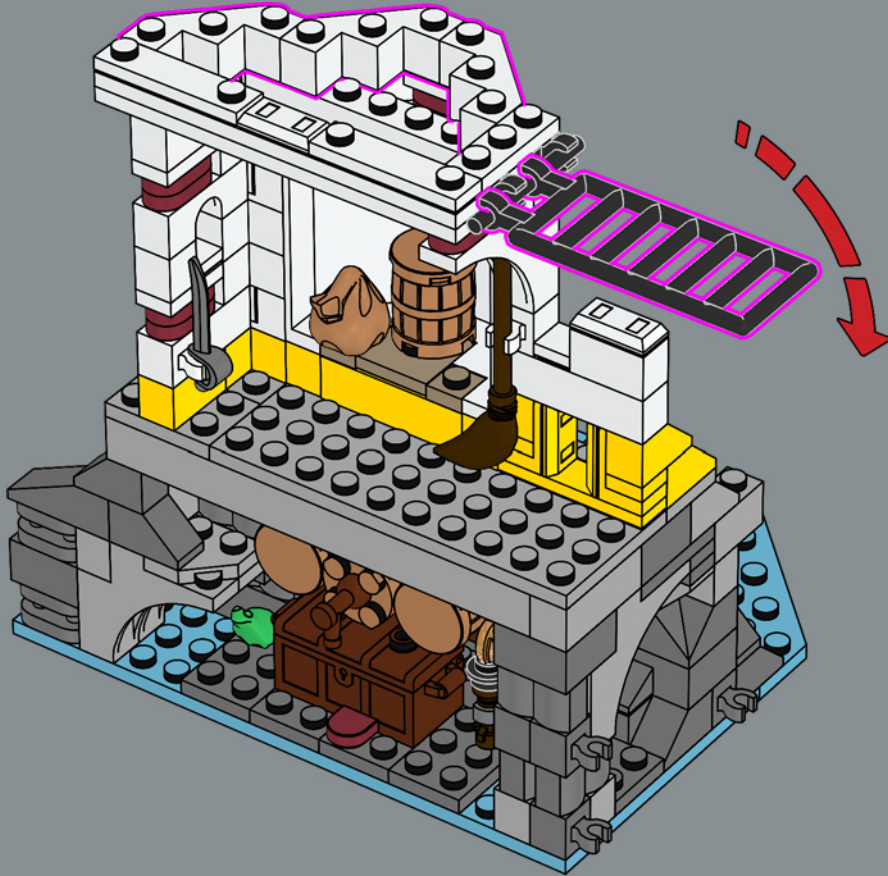

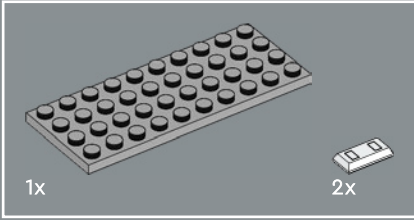
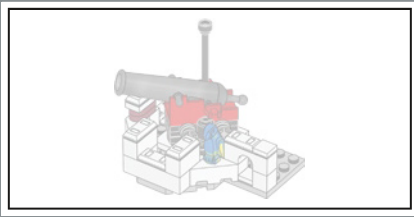

47

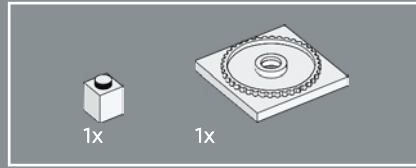
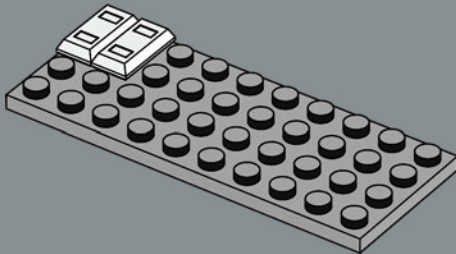

48

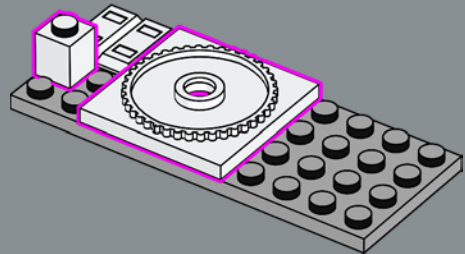

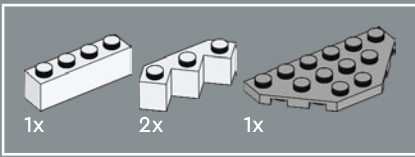

49

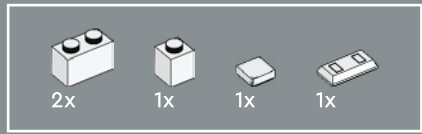
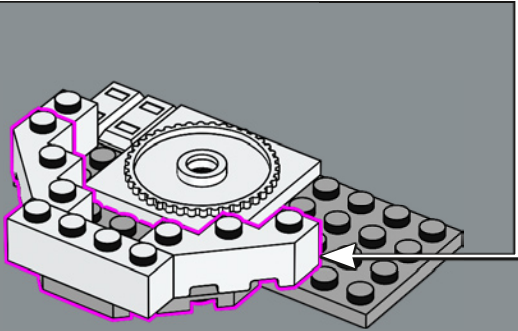
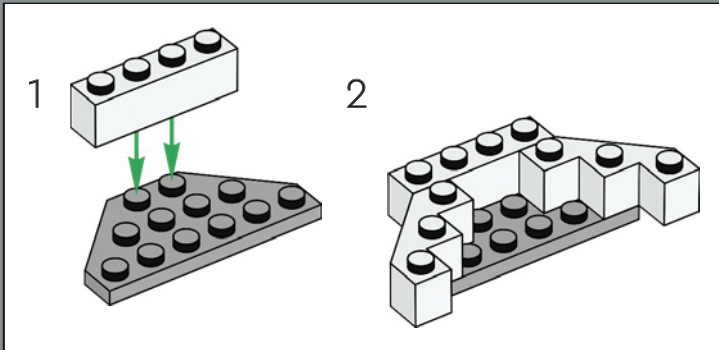

50

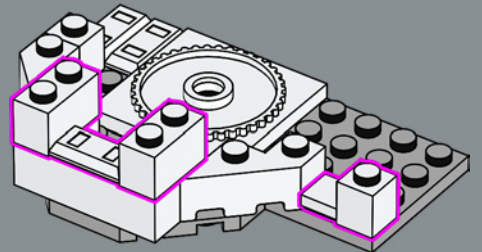

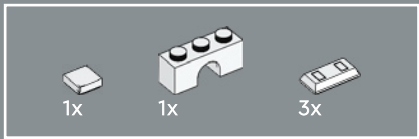

51

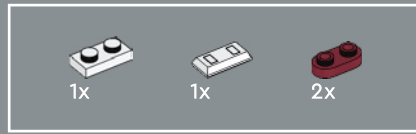
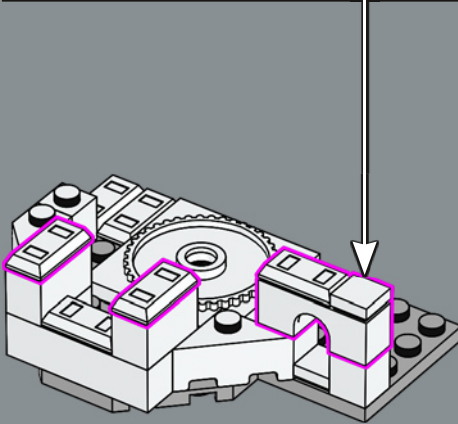
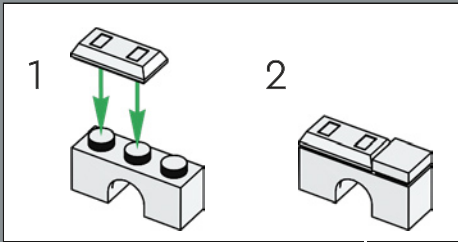

52

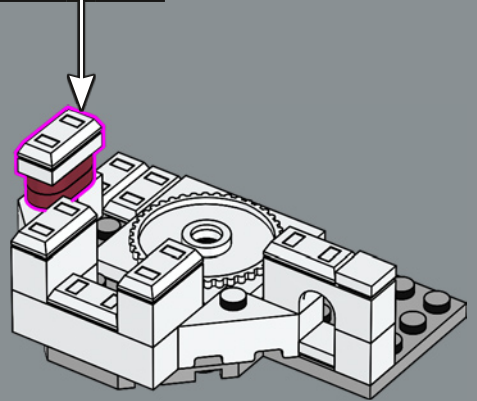
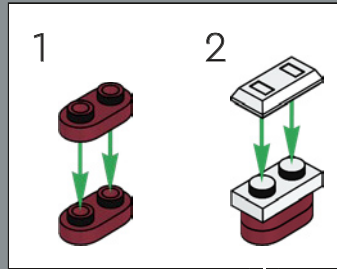

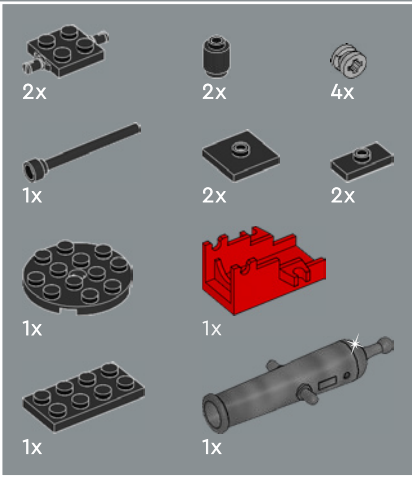
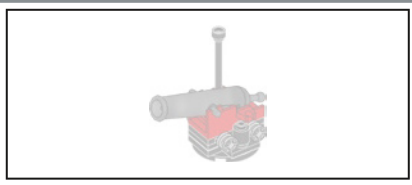

53

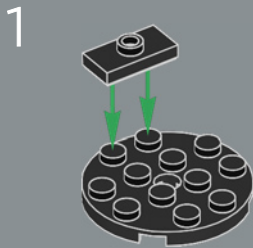

2

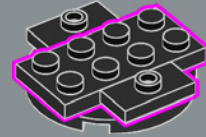

3

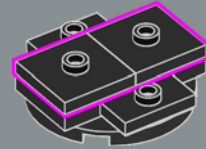

4

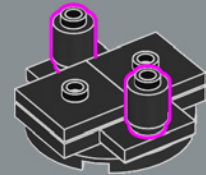



Vuoi attaccare i dispettosi pirati da un'angolazione diversa? È possibile spostare i cannoni sulle torri avanti e indietro per girarli o muoverli in altre aree della fortezza.

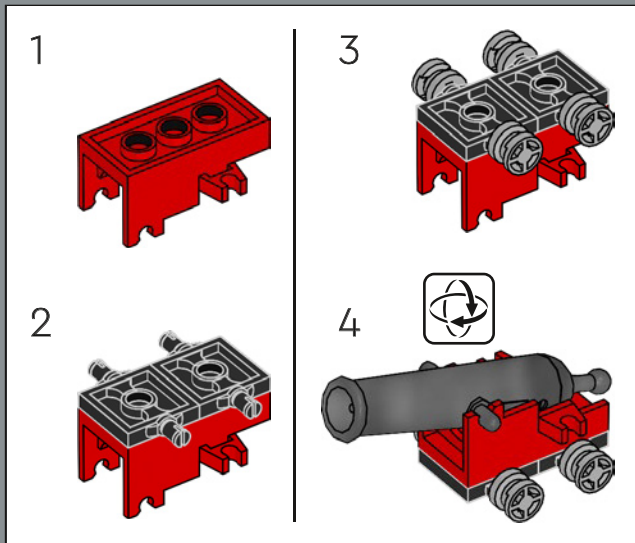

5

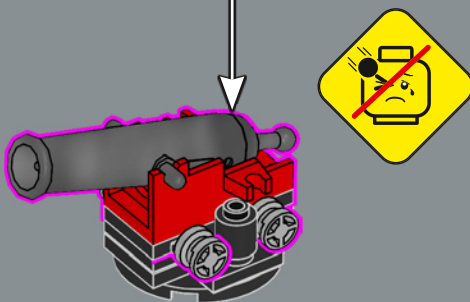

6

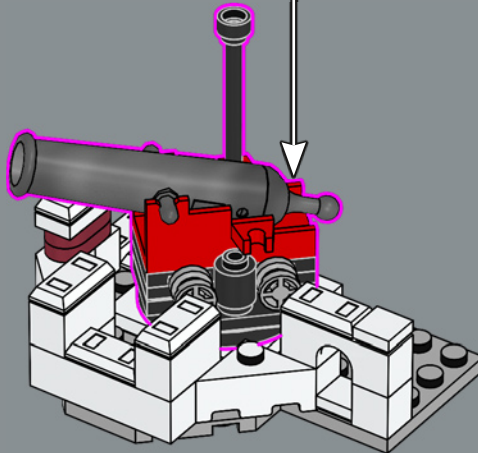
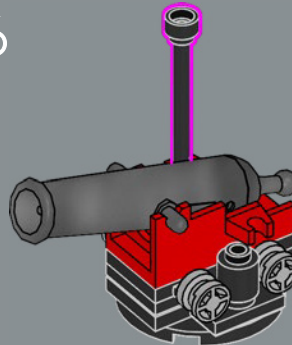





54

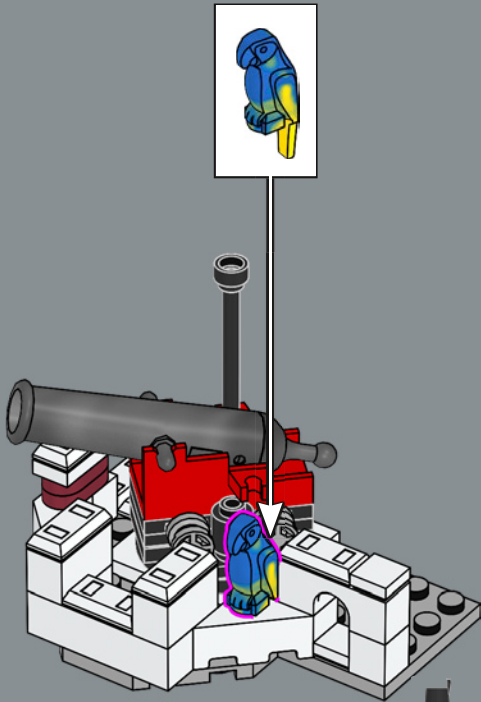

55

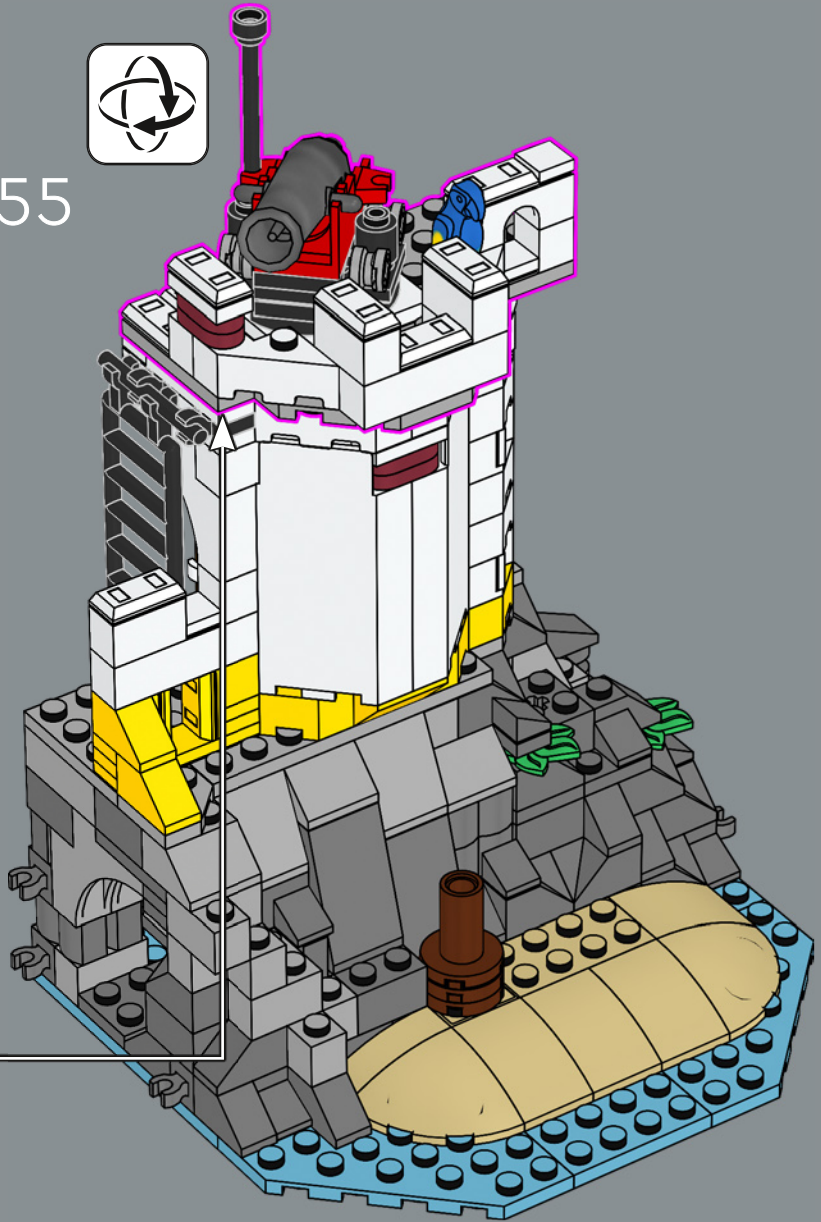

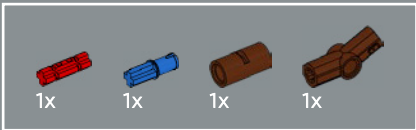

56

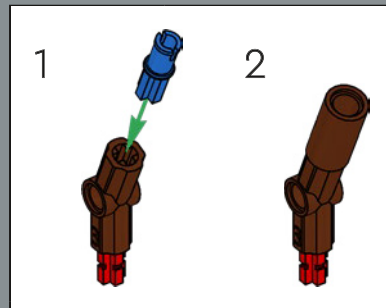
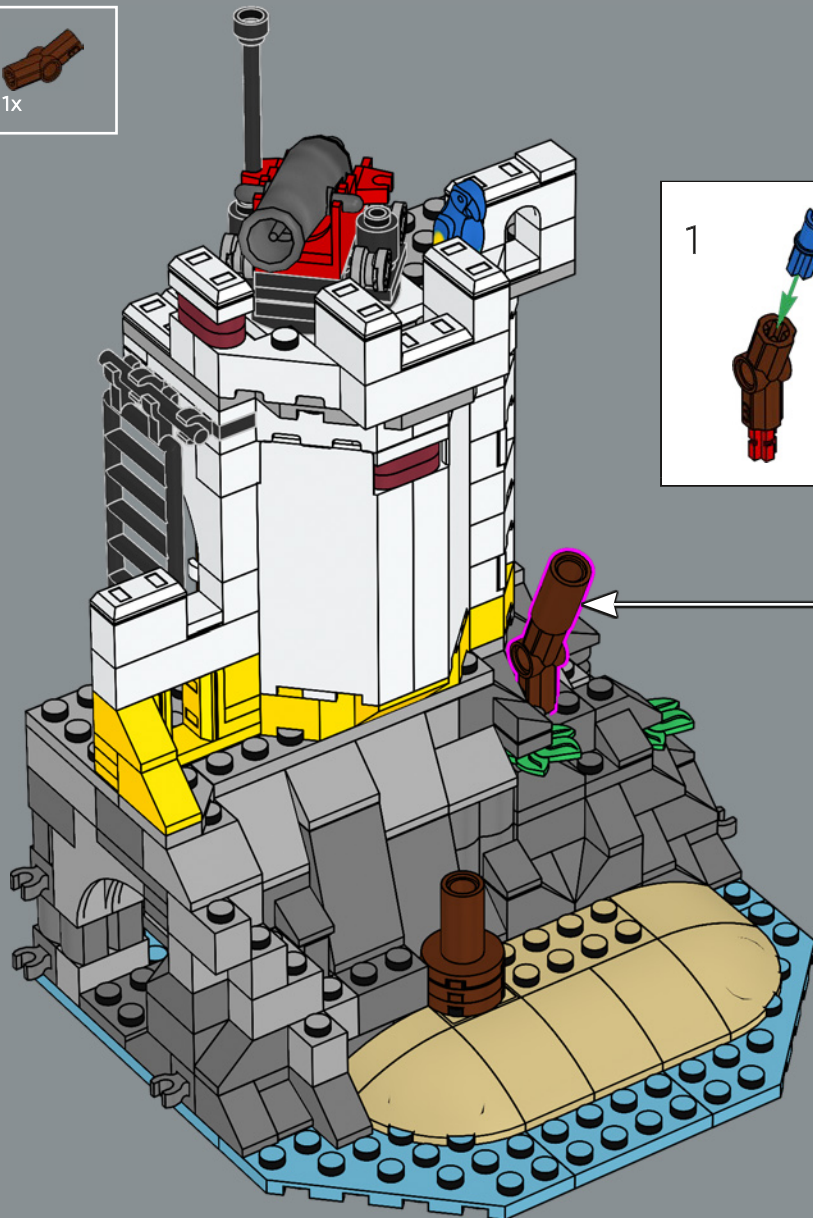

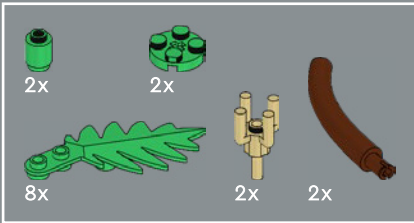
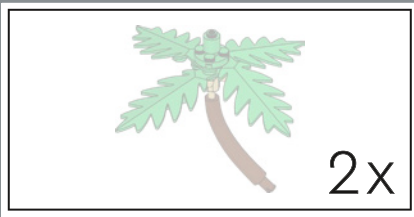

57

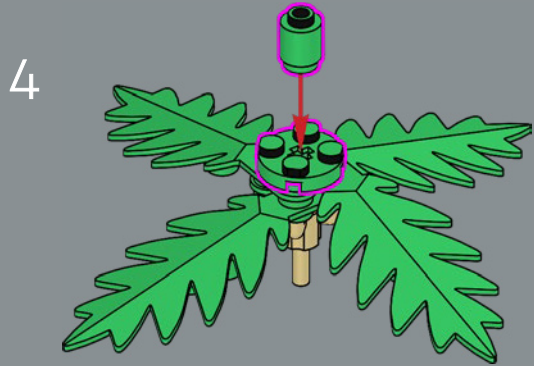
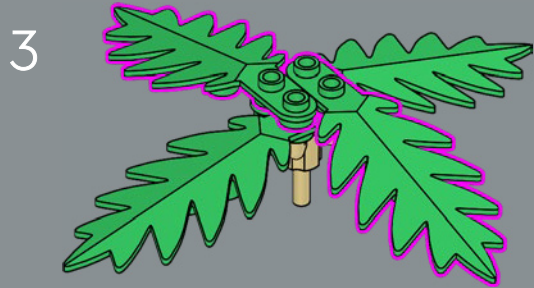
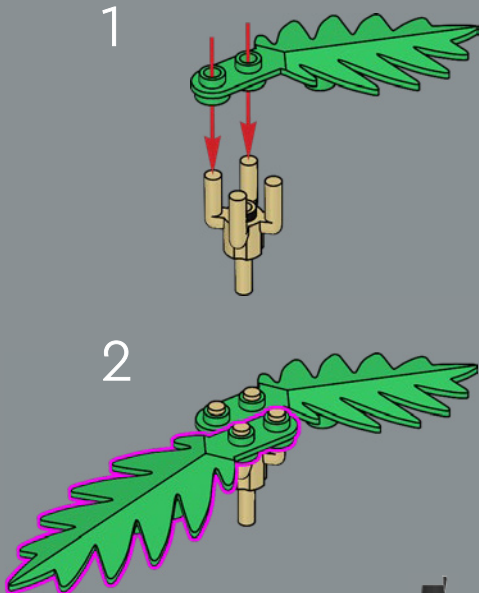

2x

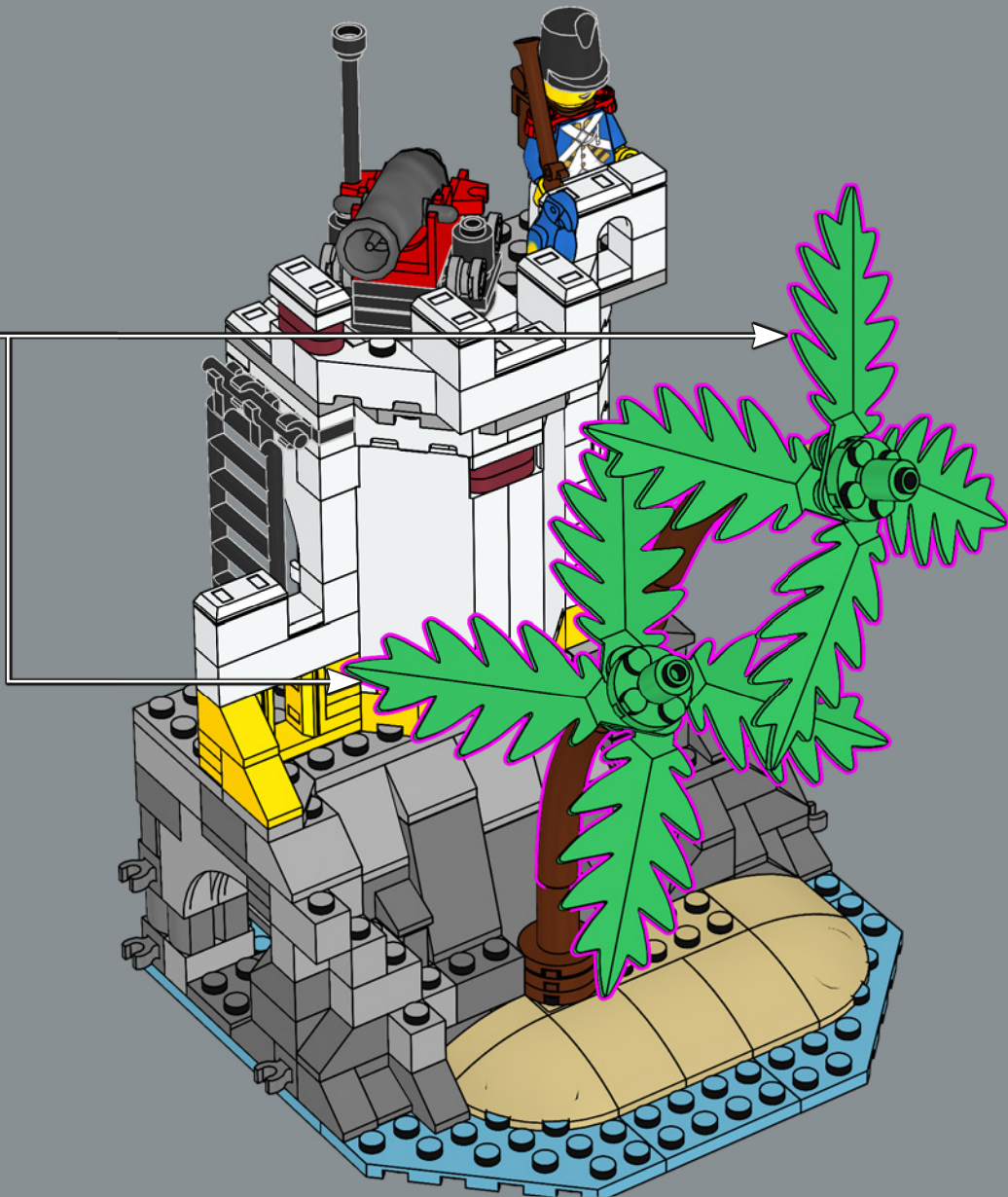

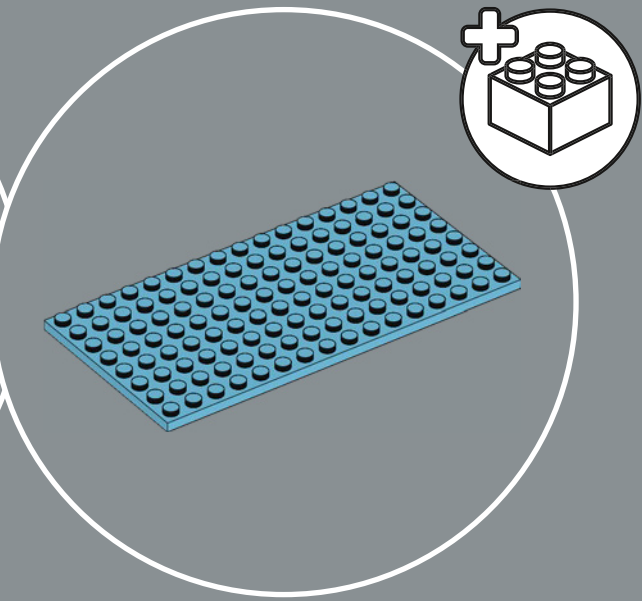

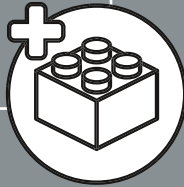
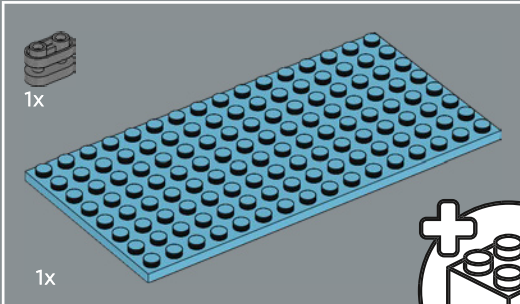
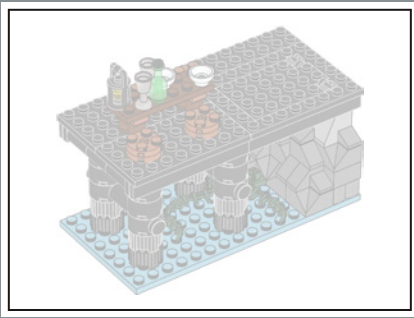

58

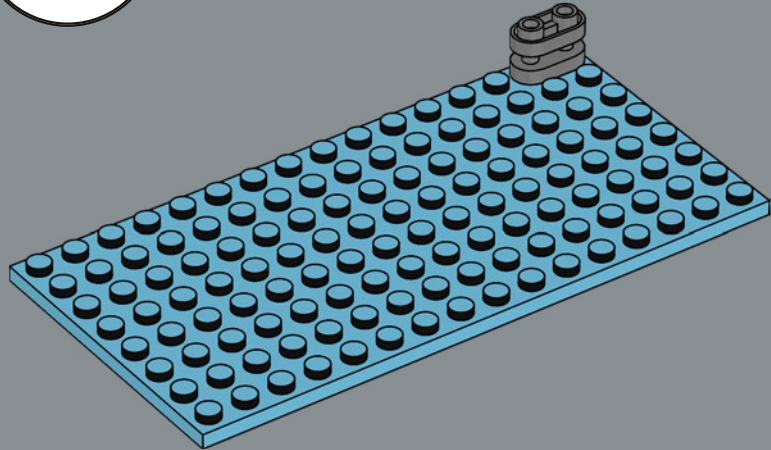

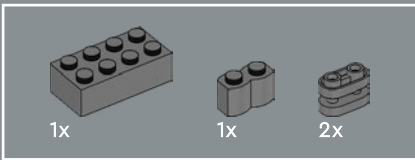

59

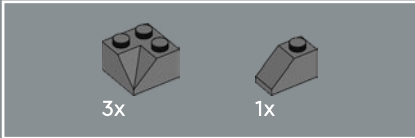
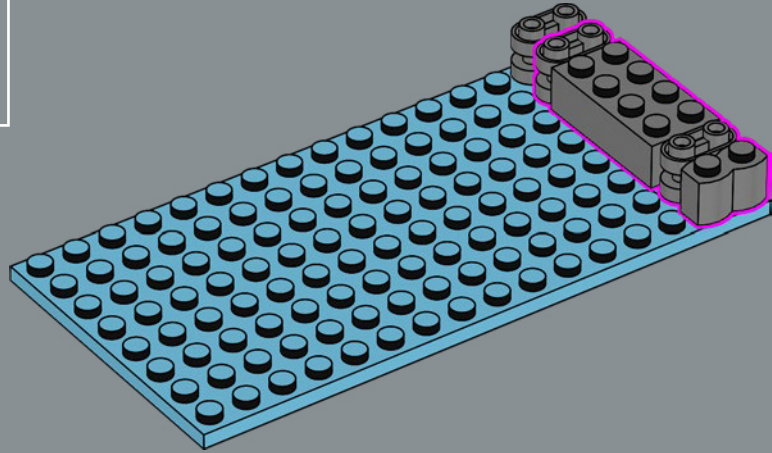

60

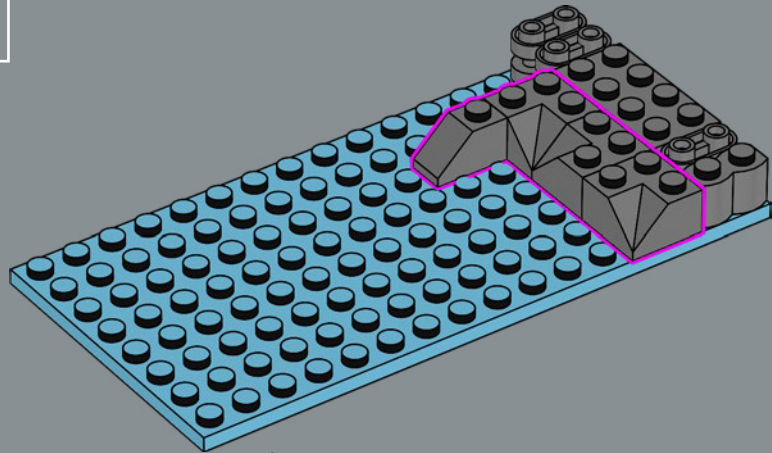



61

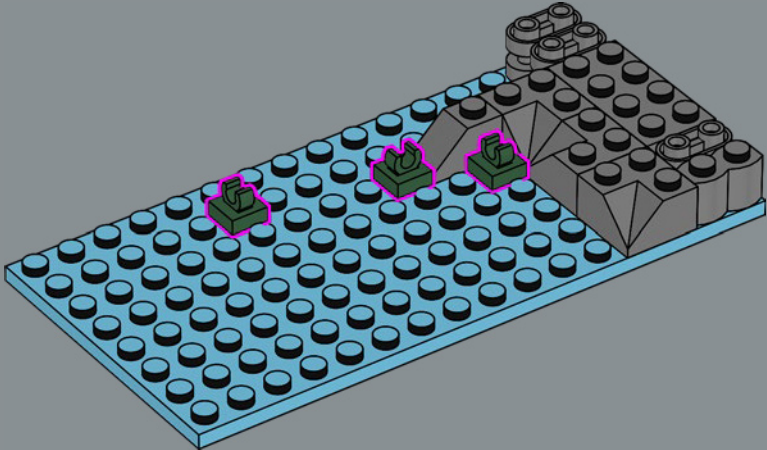

62

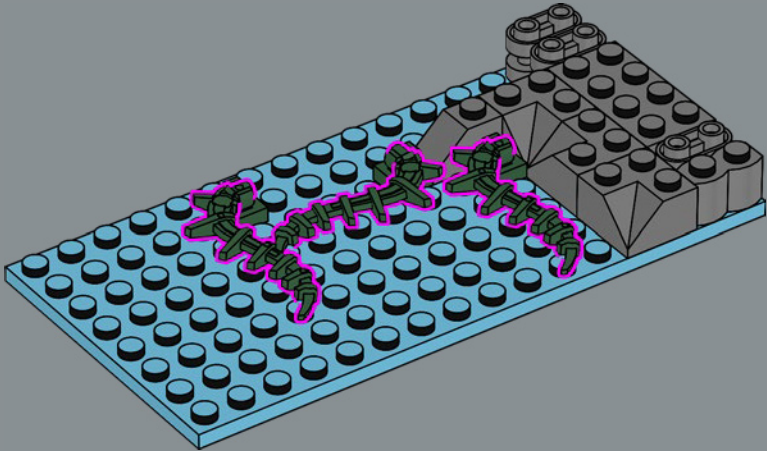



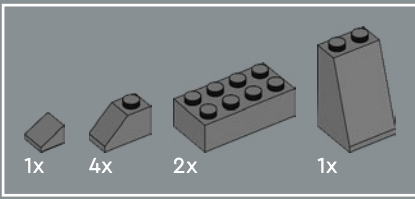

63

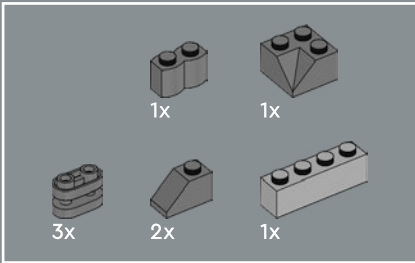
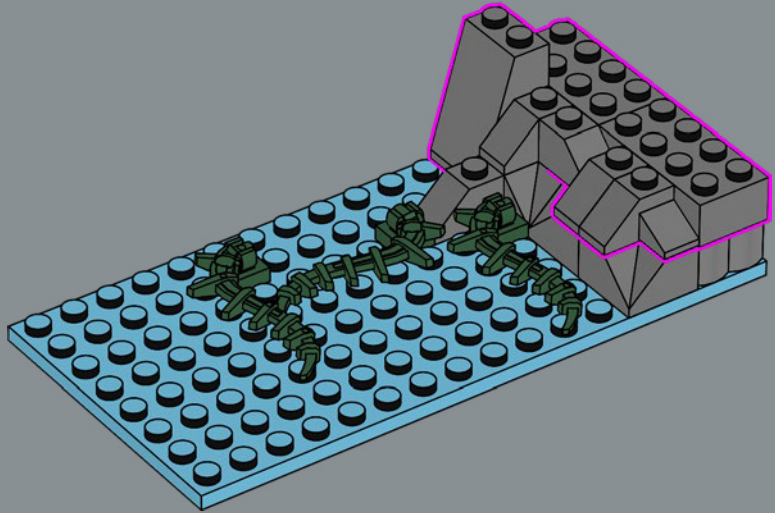

64

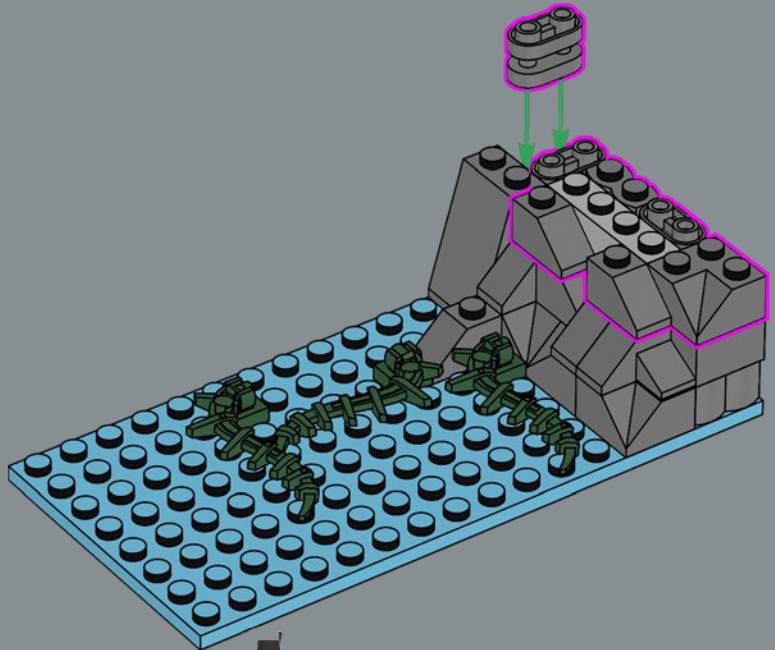

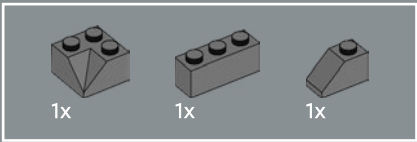

65

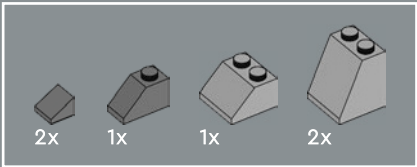
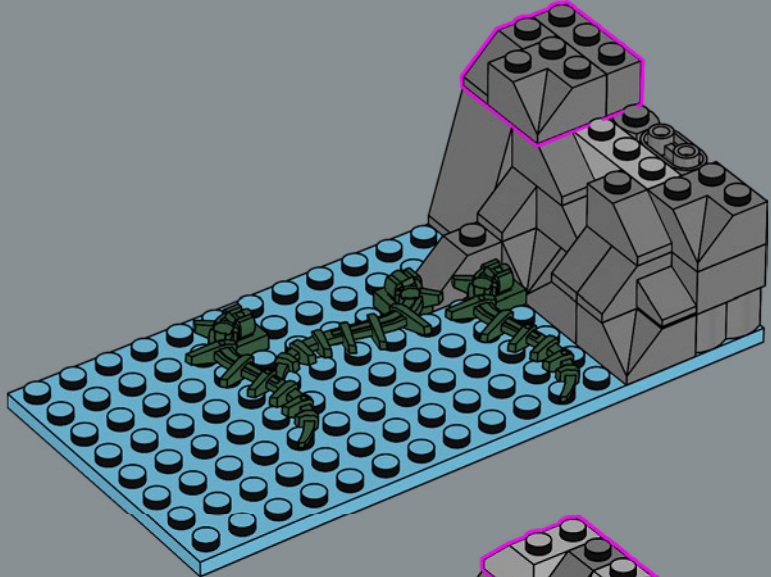

66

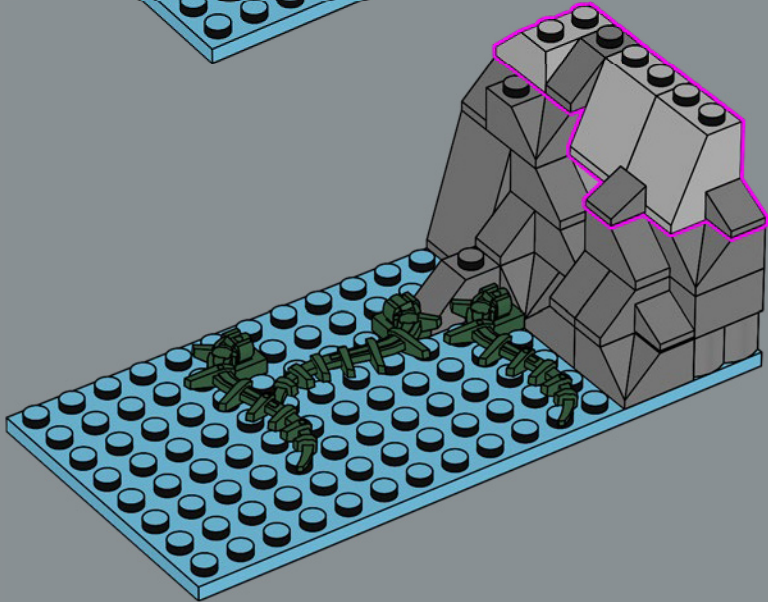

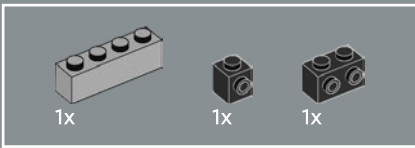

67

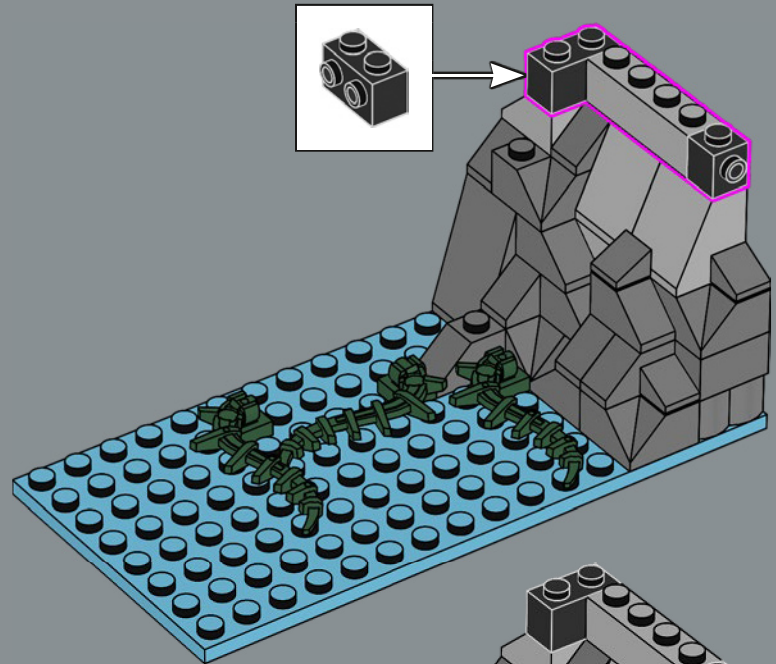

68

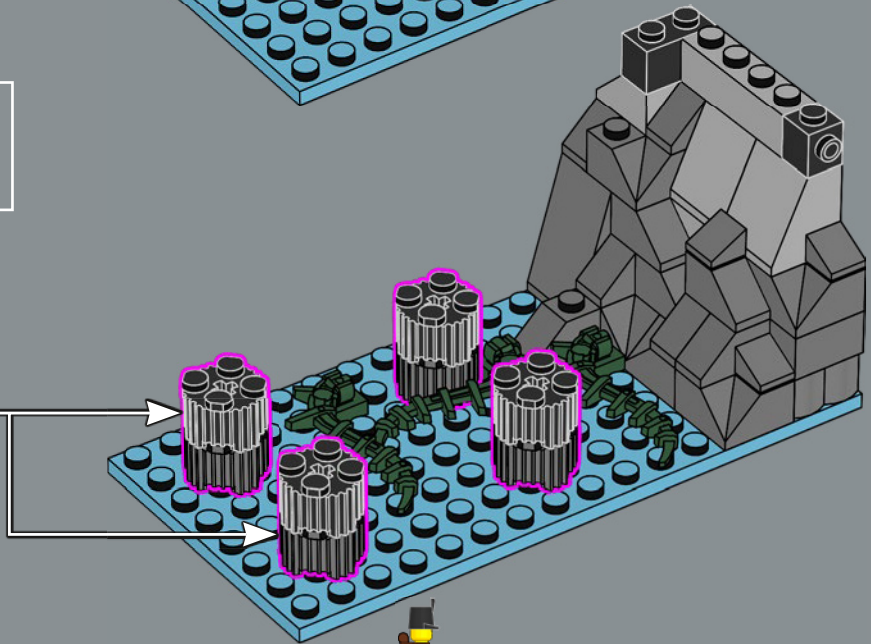
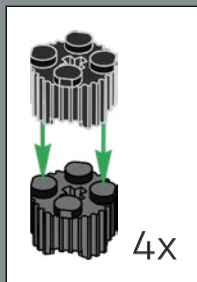

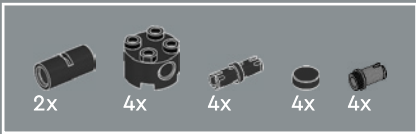

69

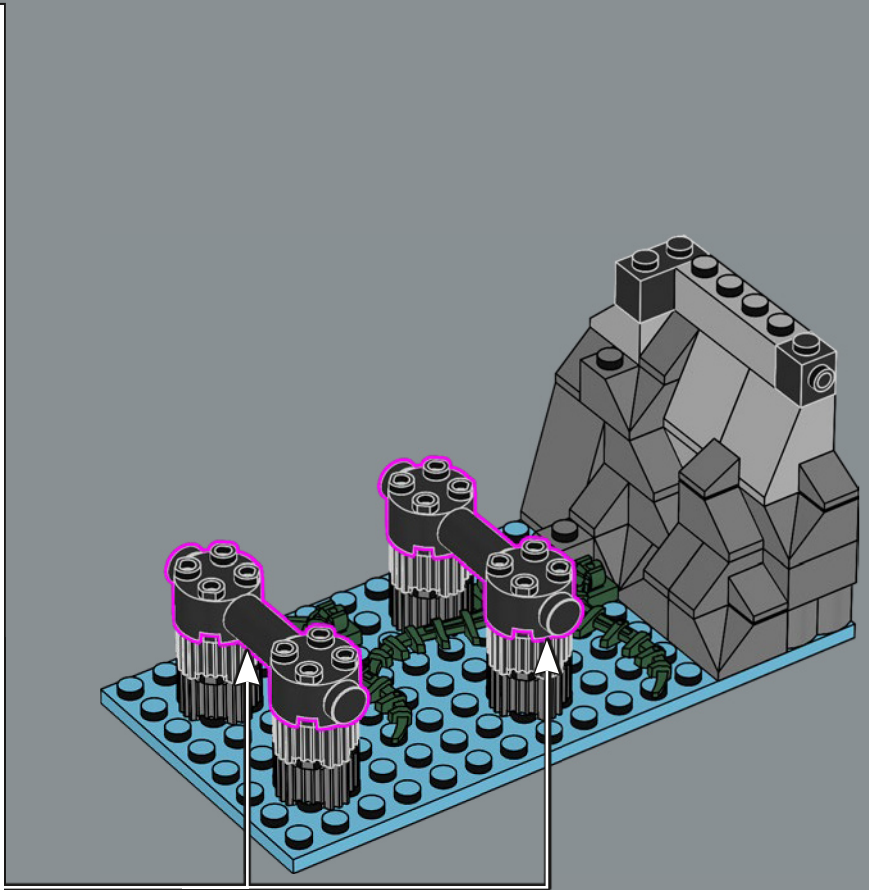
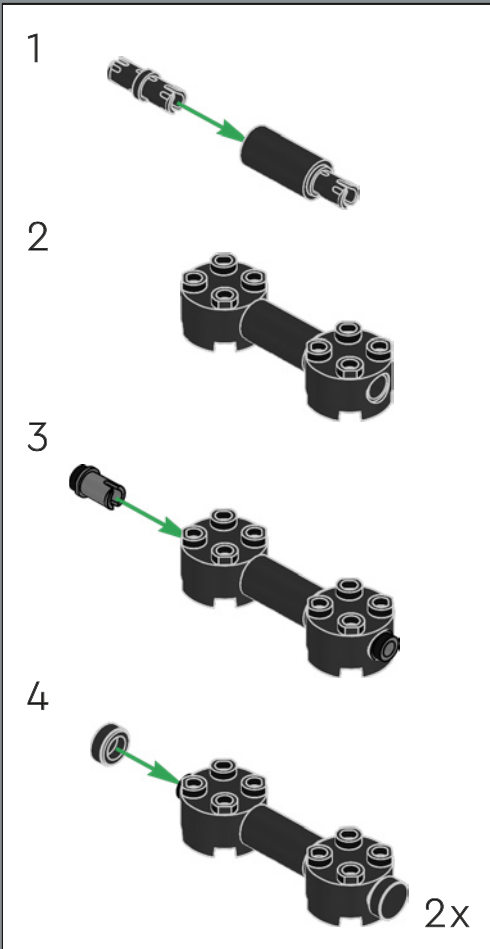

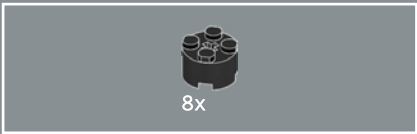

70

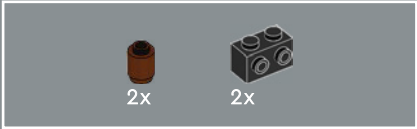
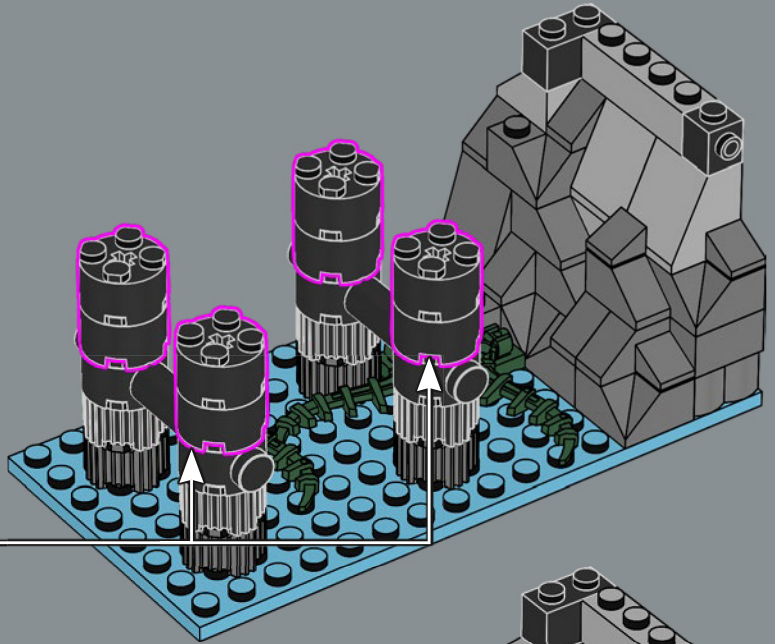
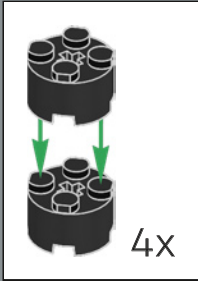

71

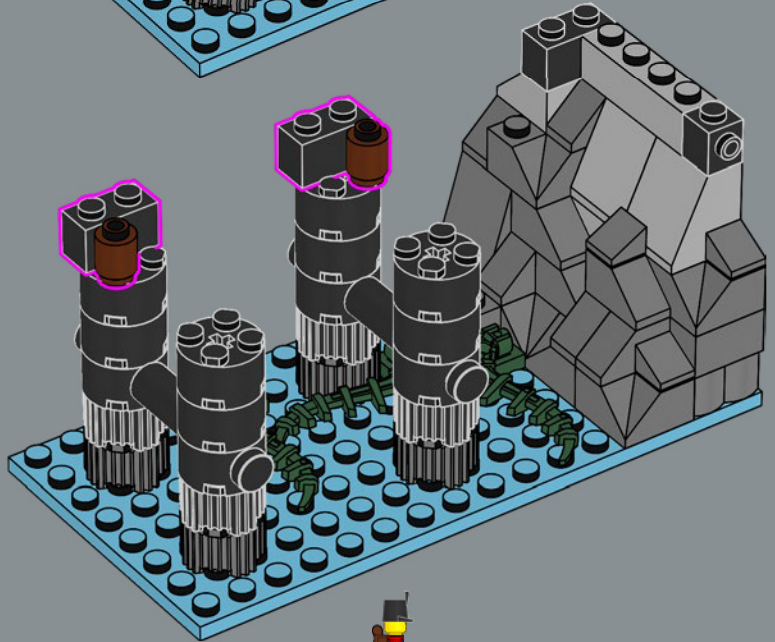

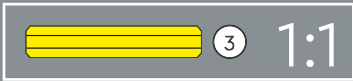
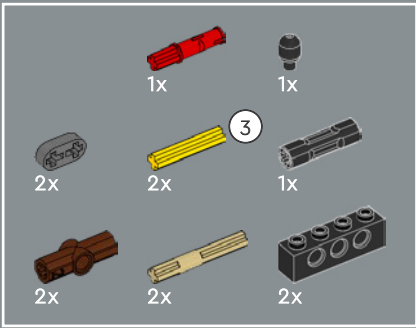

72

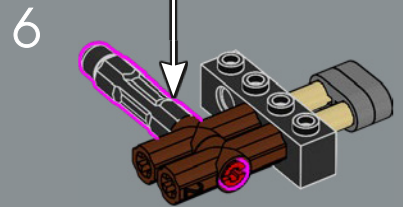
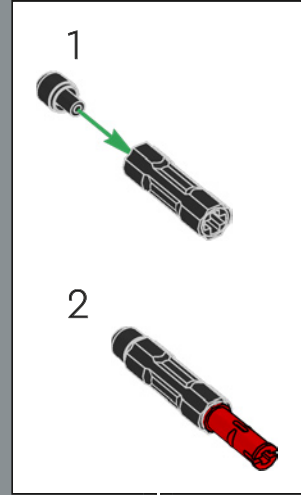
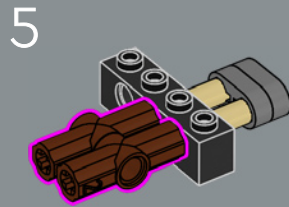
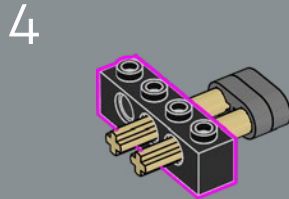
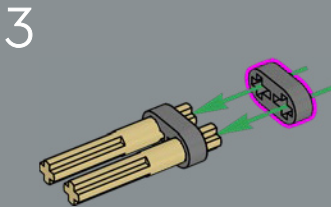
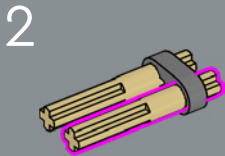
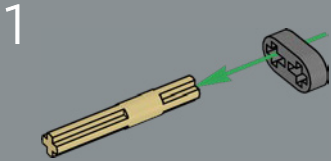

7

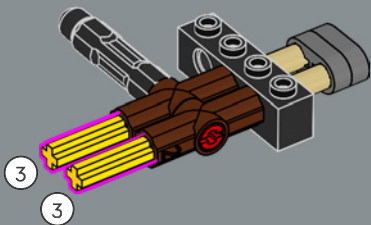

8

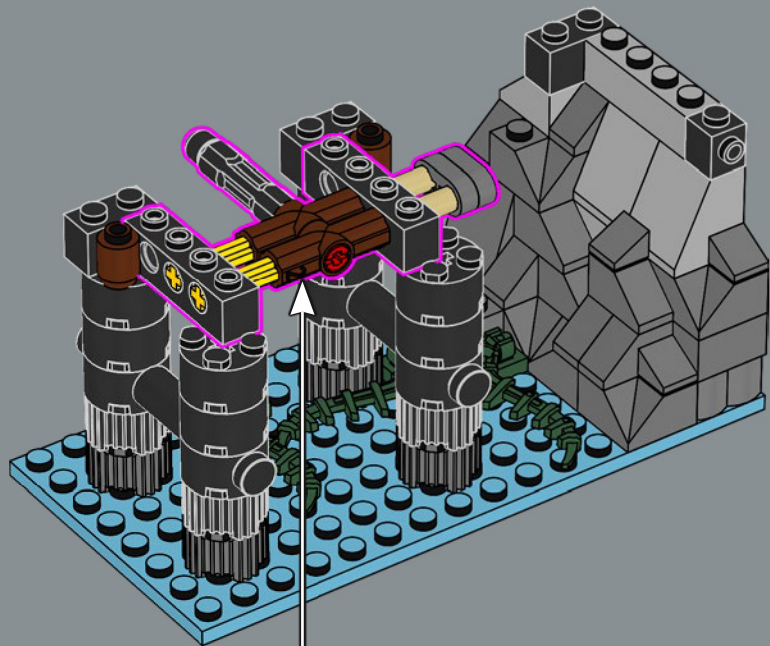
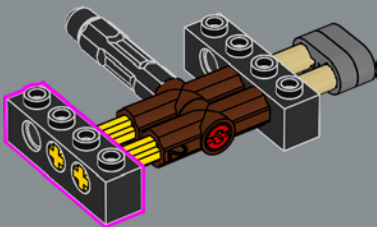



2x

73

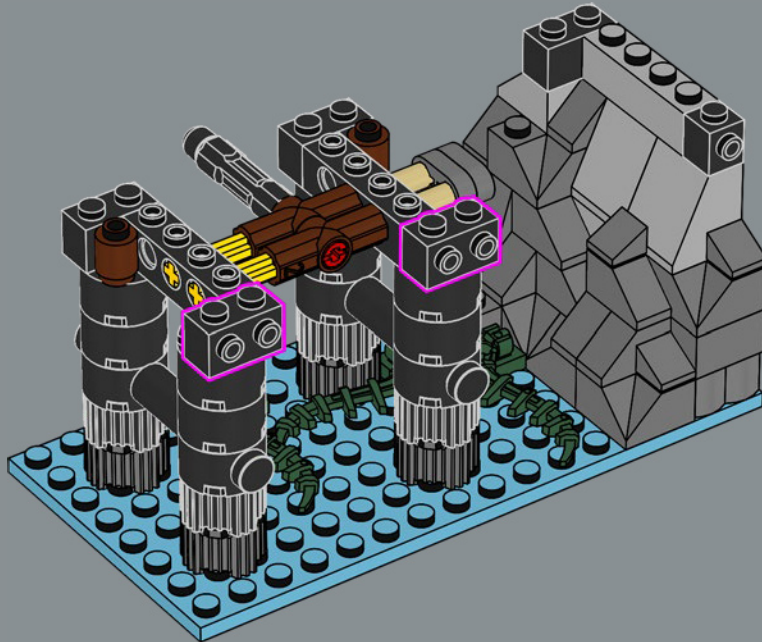



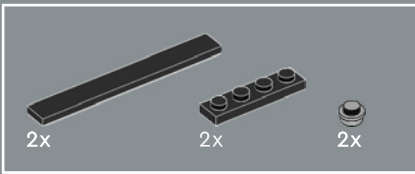

74

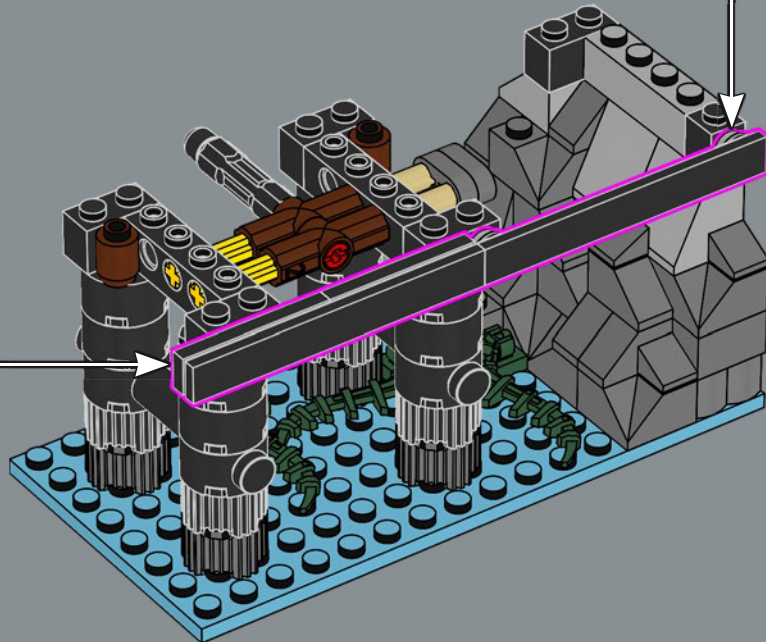
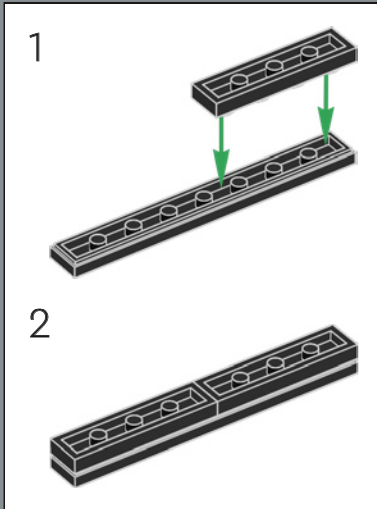
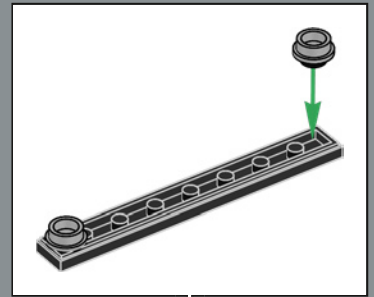

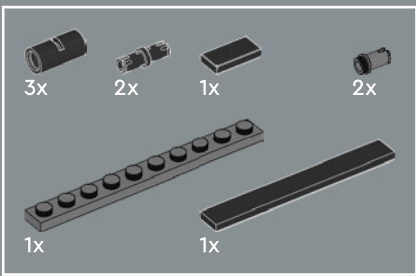

75

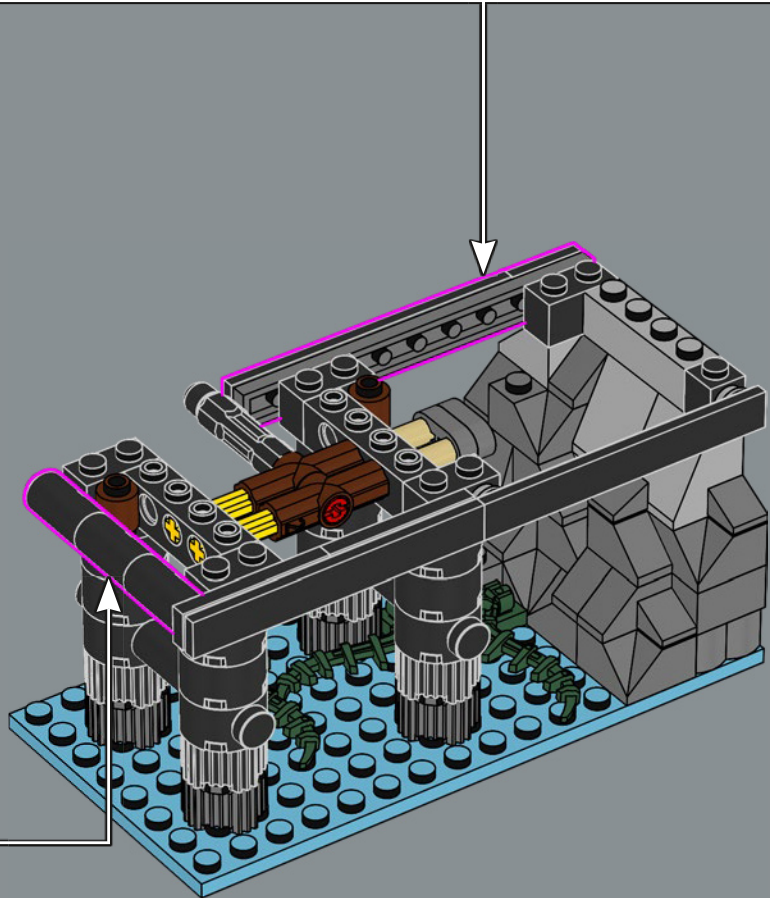
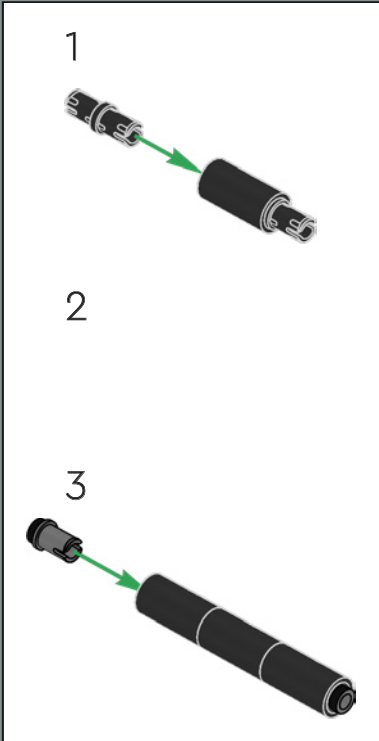
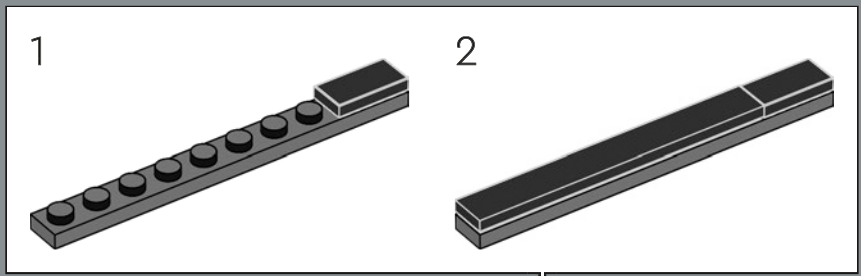

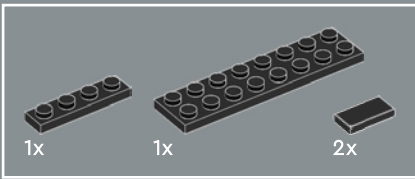

76

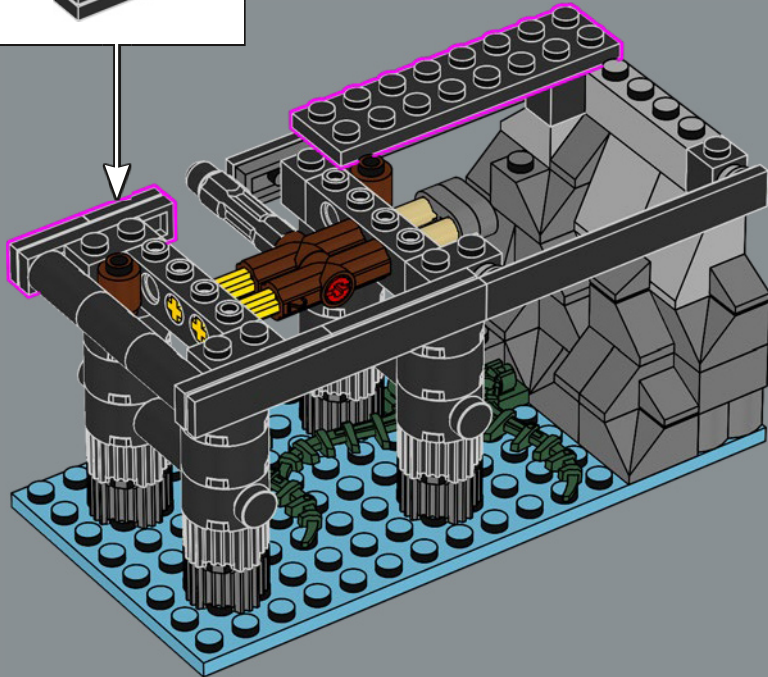
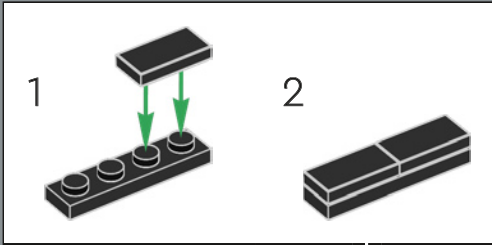

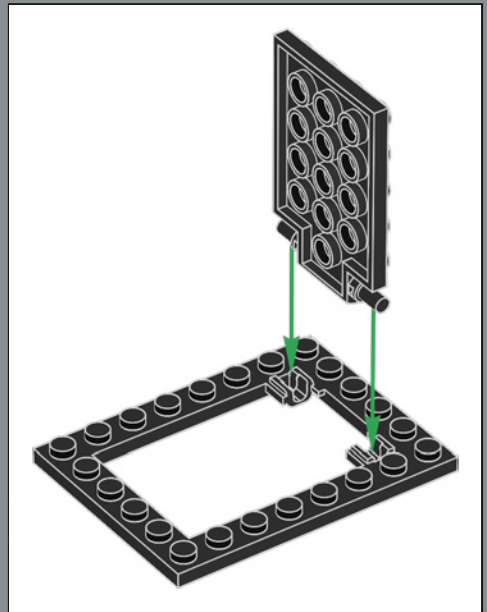
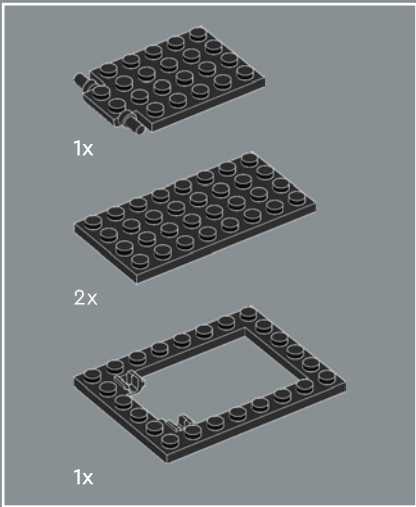

77

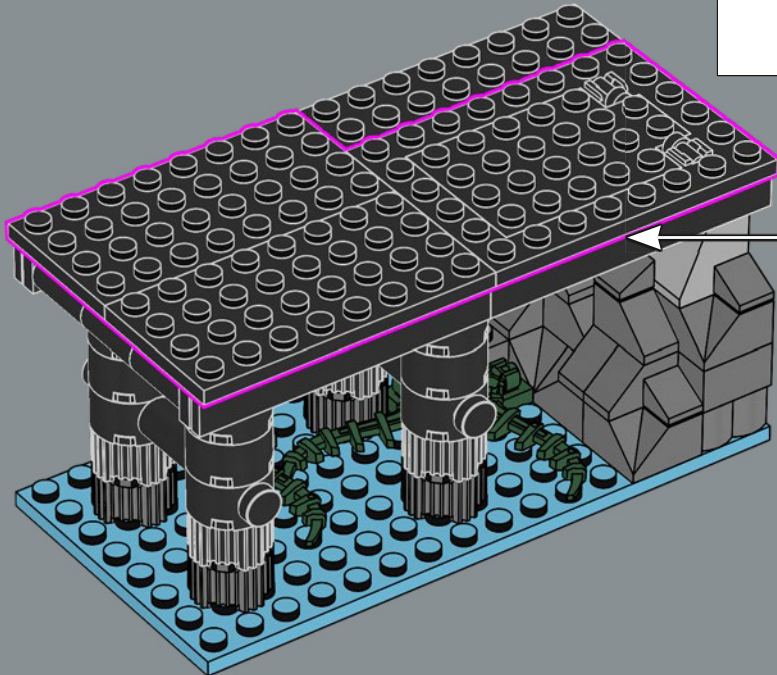

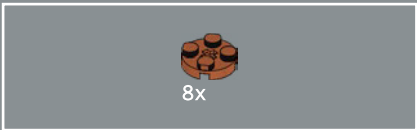

78

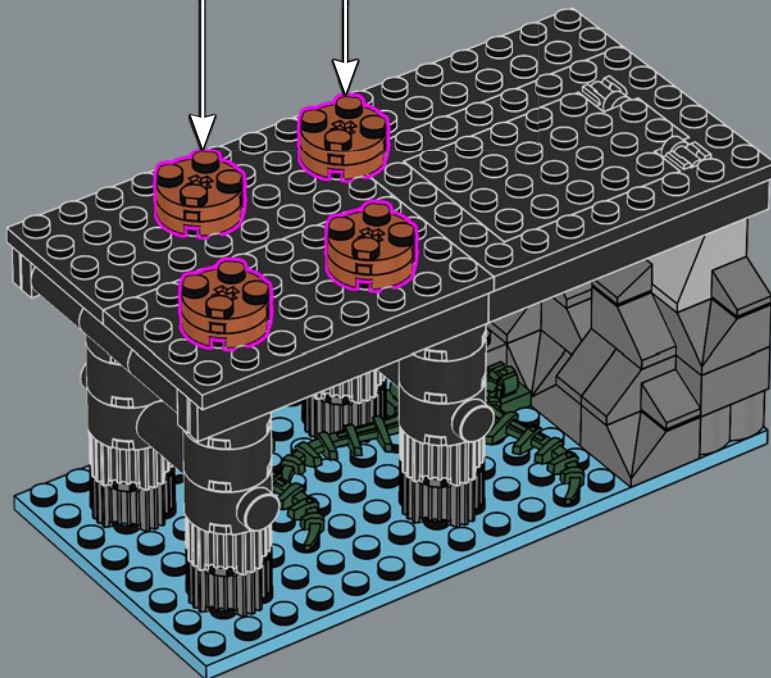
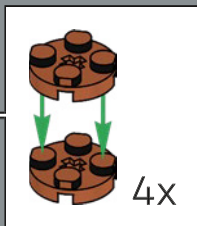

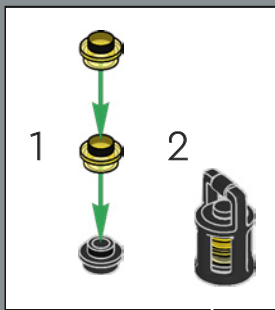

79

1

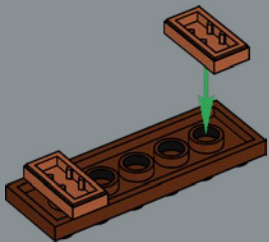

2

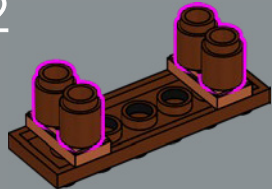

3

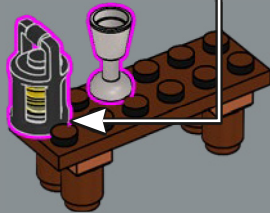

4



5

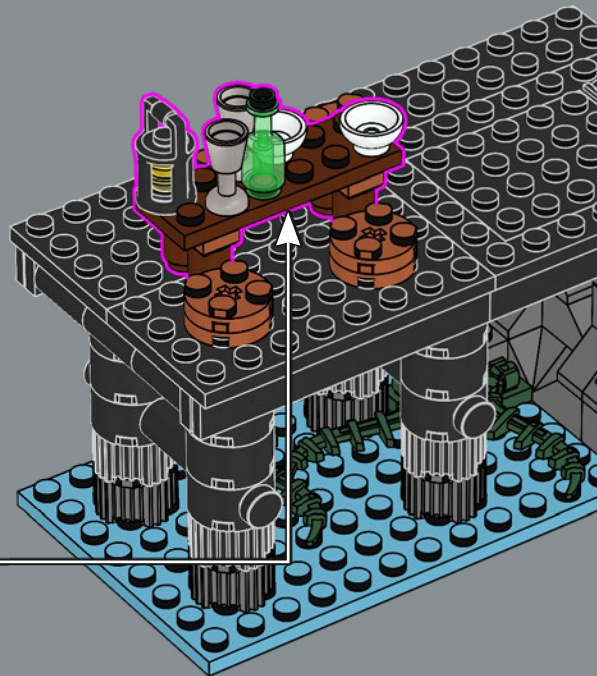



Se già possiedi il set LEGO® Ideas 21322, I pirati di Barracuda Bay, puoi collegarlo al molo.





LEGO and the LEGO logo are trademarks of the LEGO Group.  
©2023 The LEGO Group.