

1

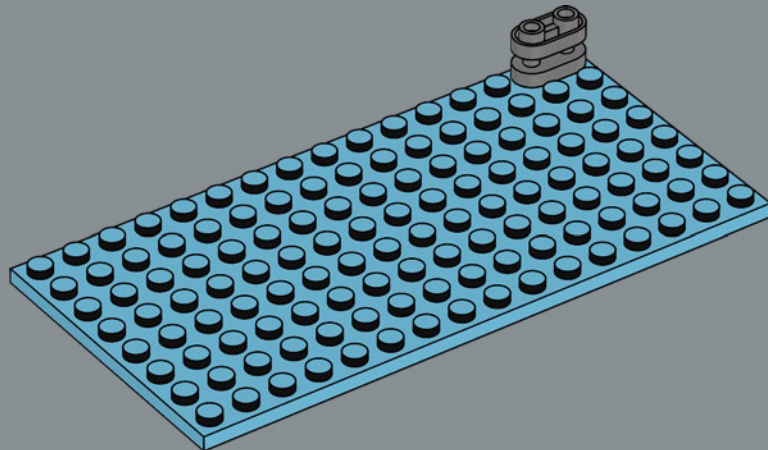

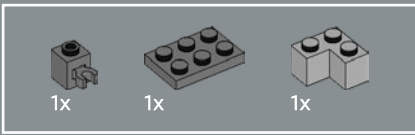

2

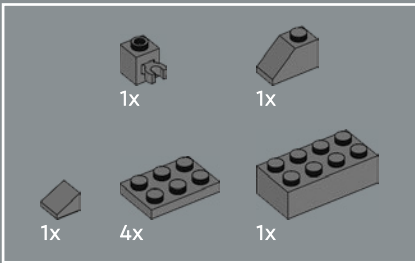
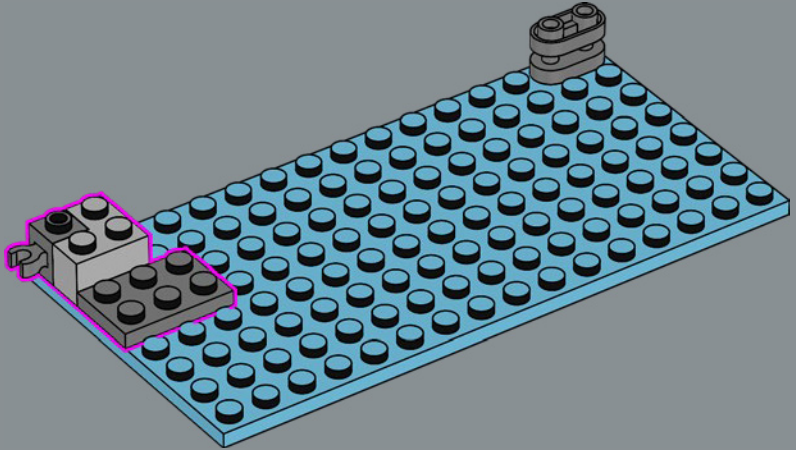

3

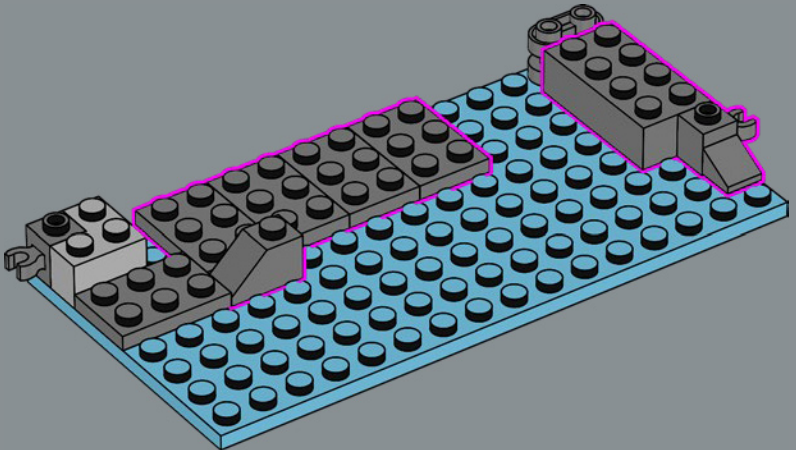

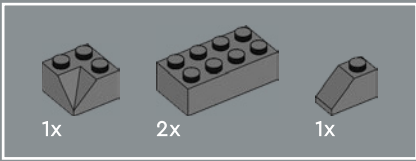

4

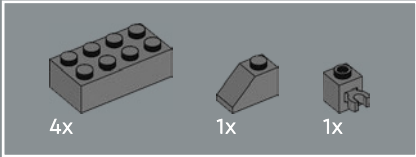
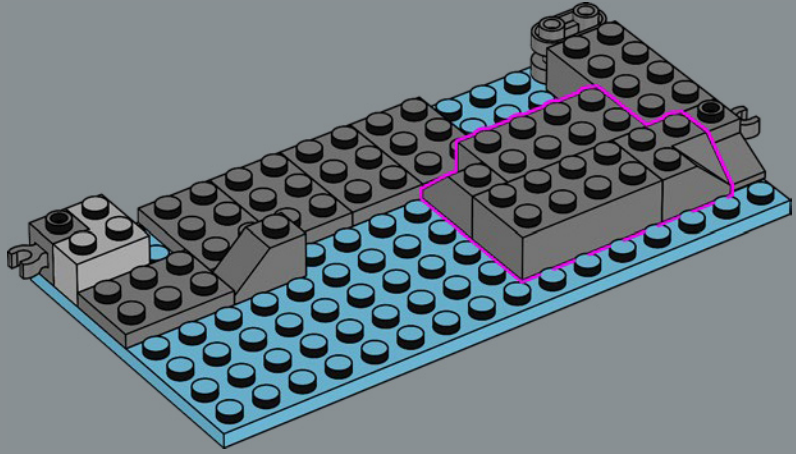

5

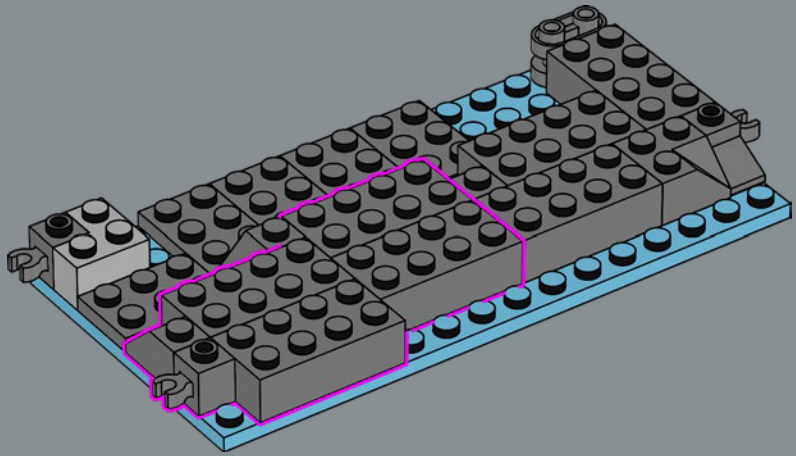

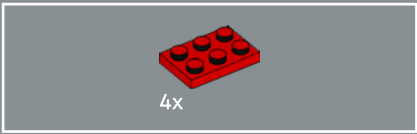

6

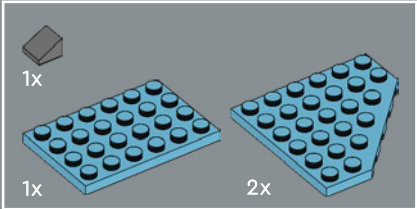
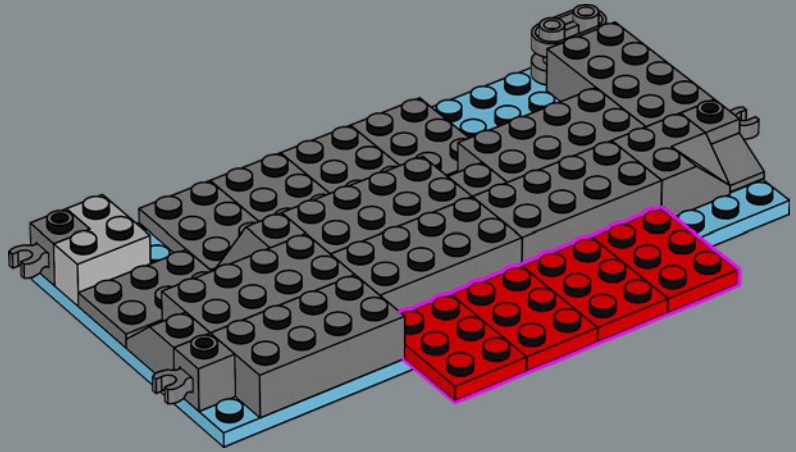

7

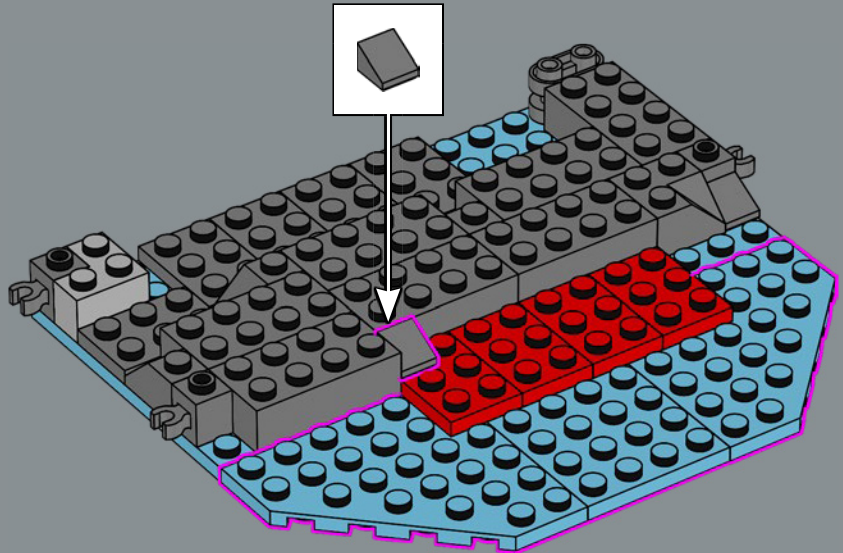

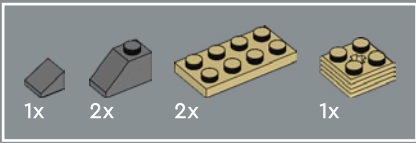

8

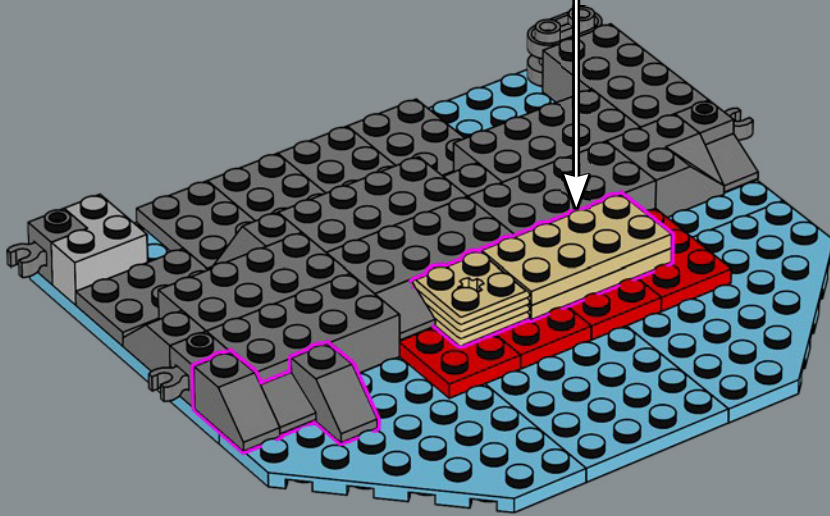
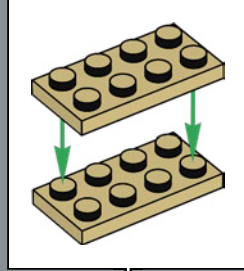





9

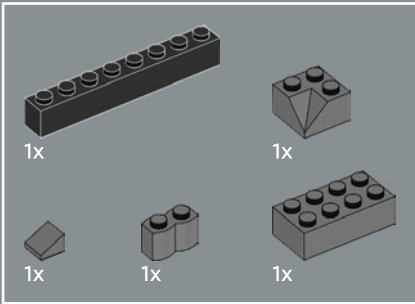
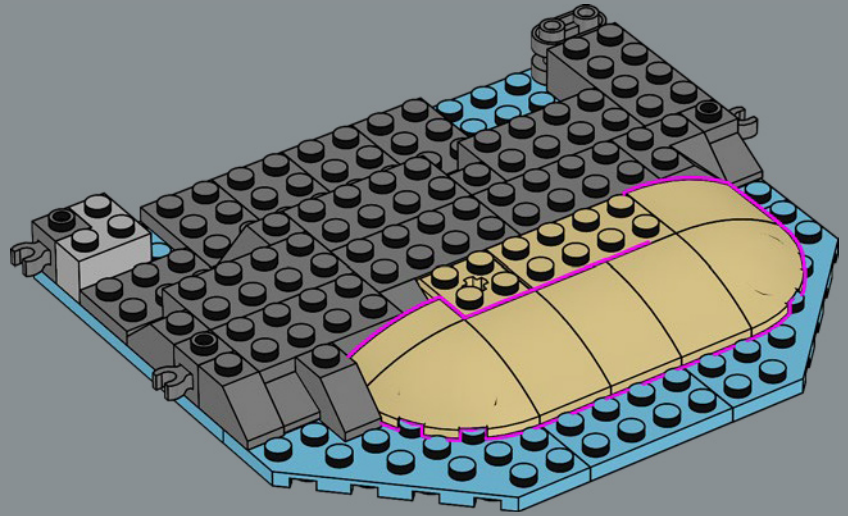

10

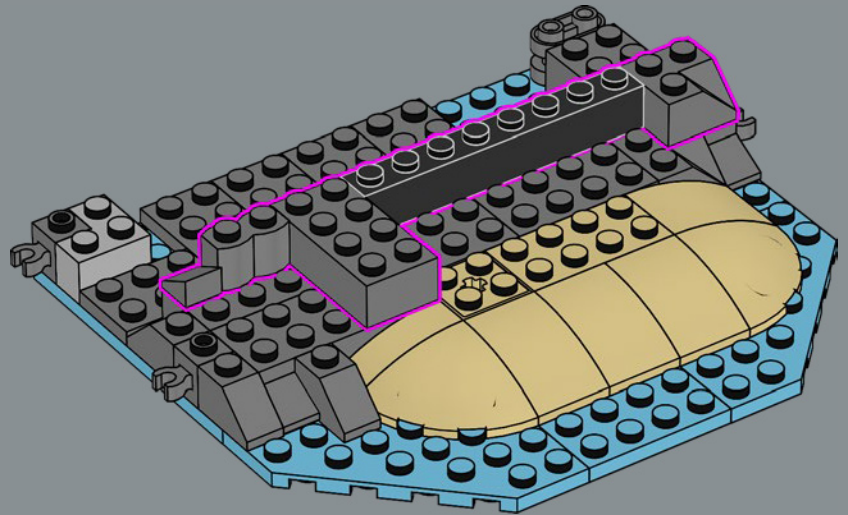

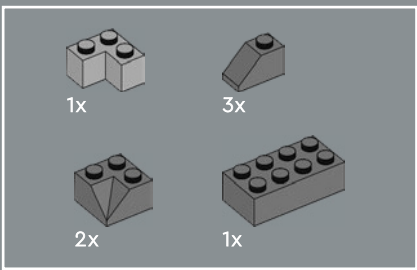

11

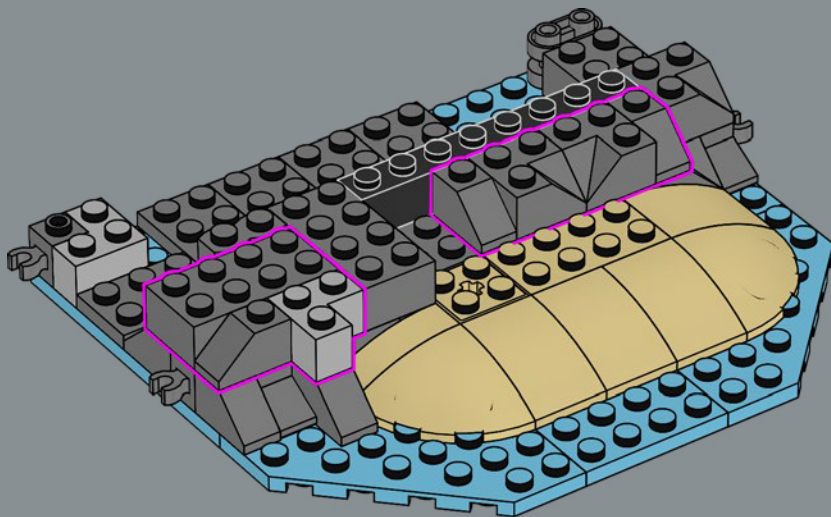

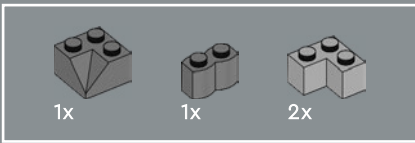

12

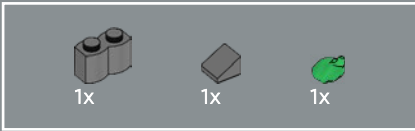
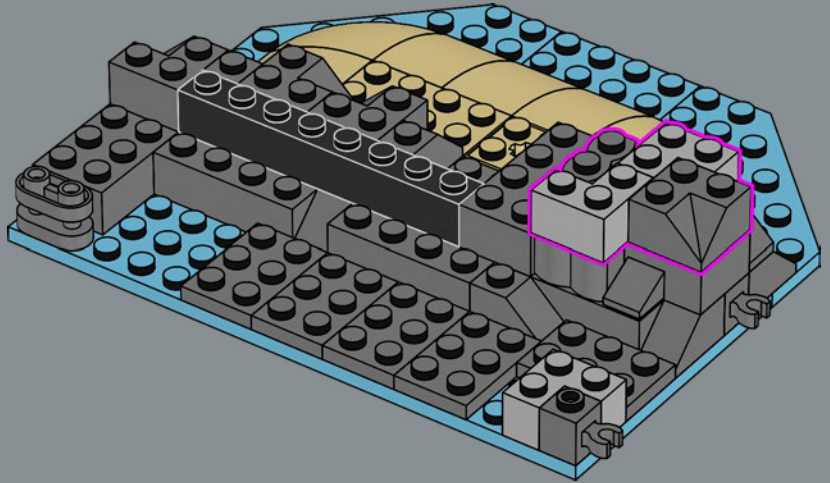

13

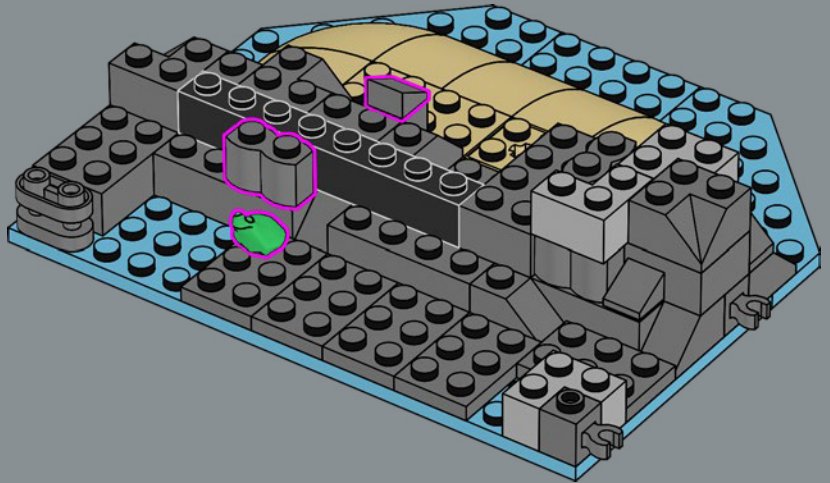

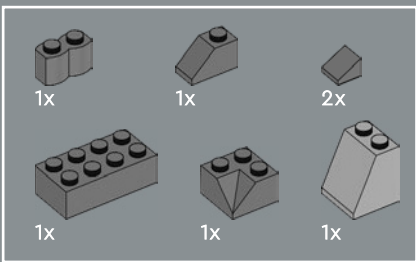

14

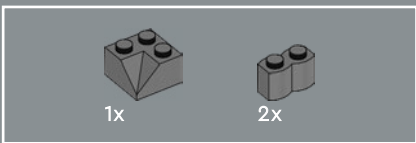
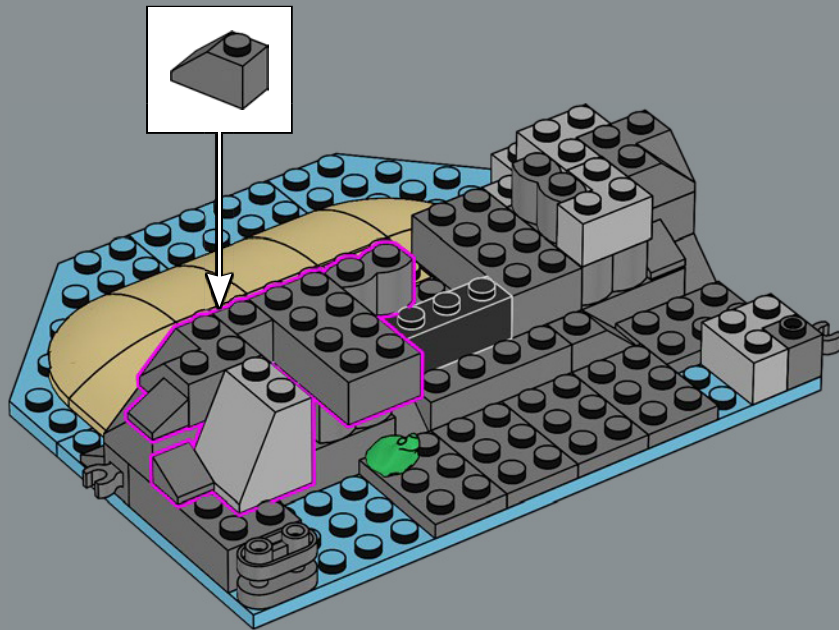

15

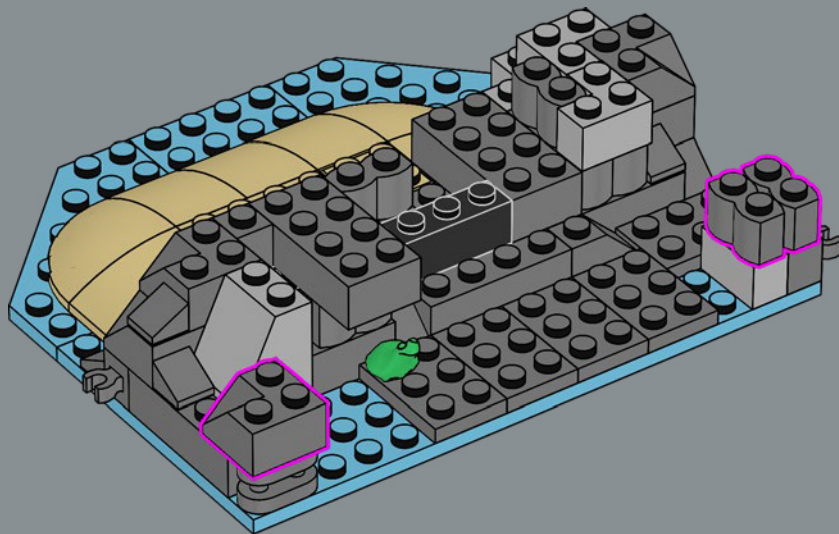

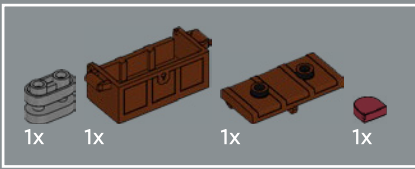

16

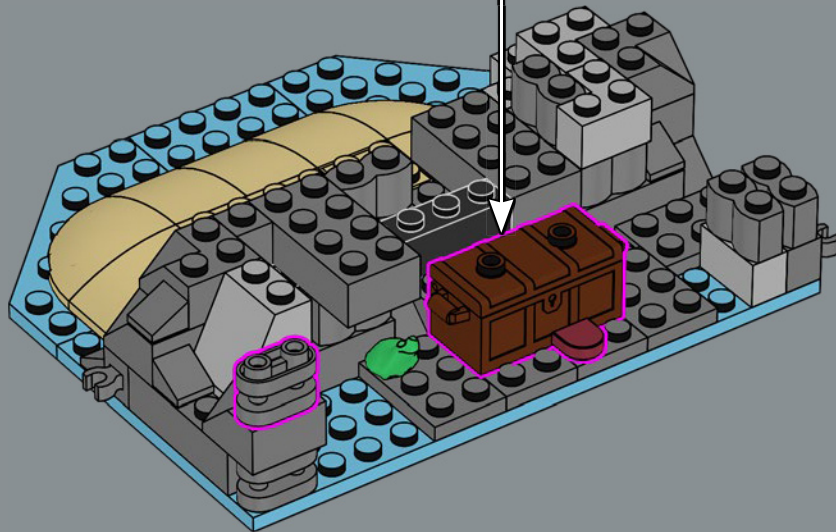
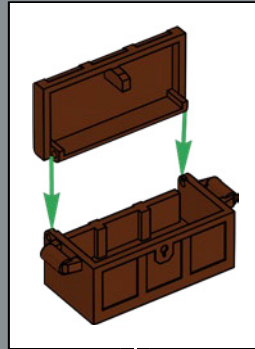

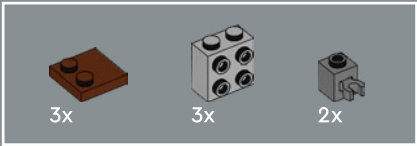

17

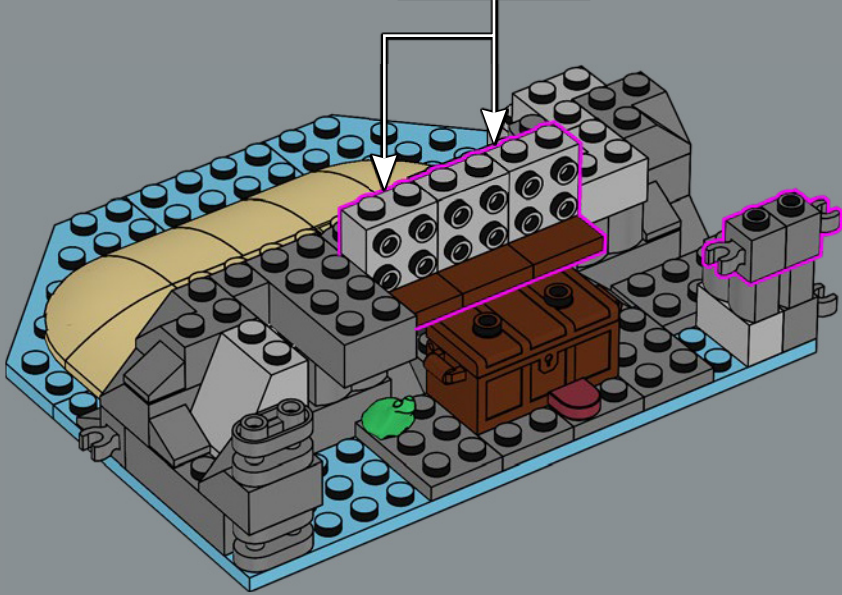
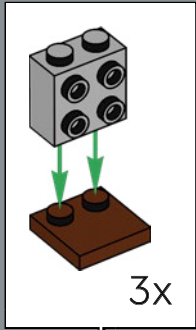



18

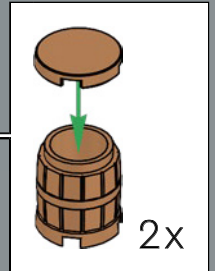
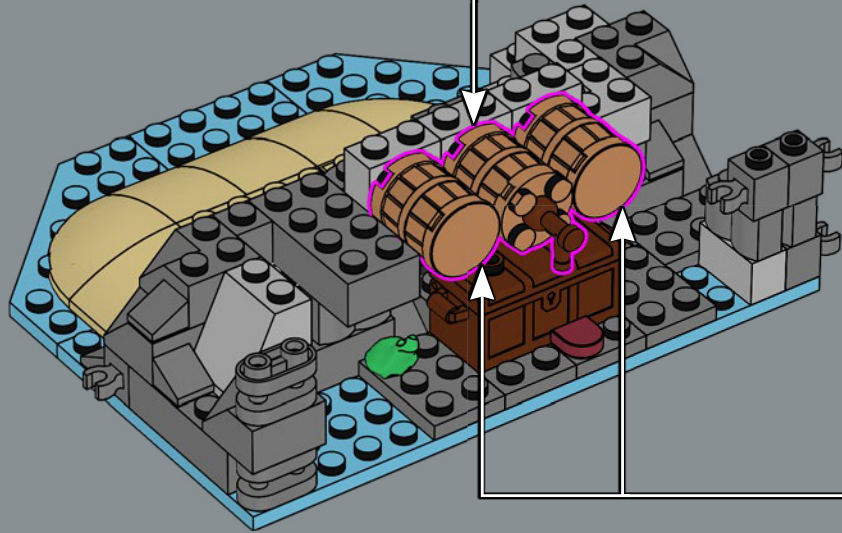
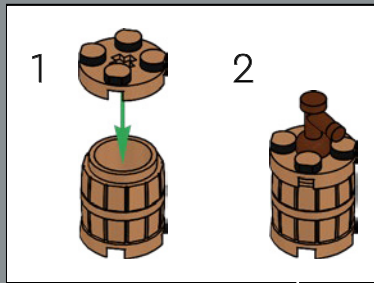

El barril tiene una fuga. Tal vez esos piratas deberían probar su puntería en otra parte...

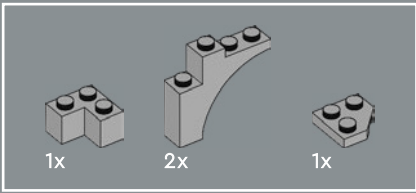

17

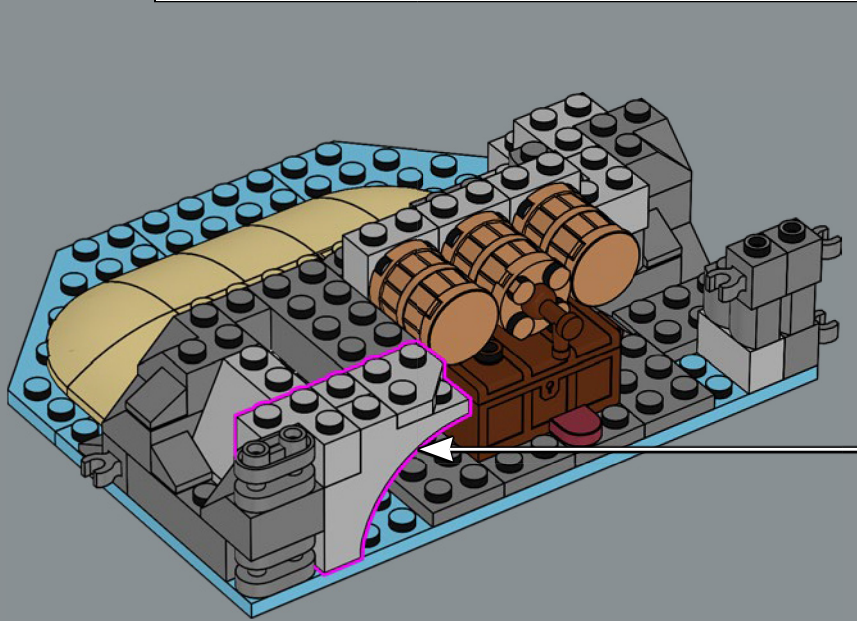
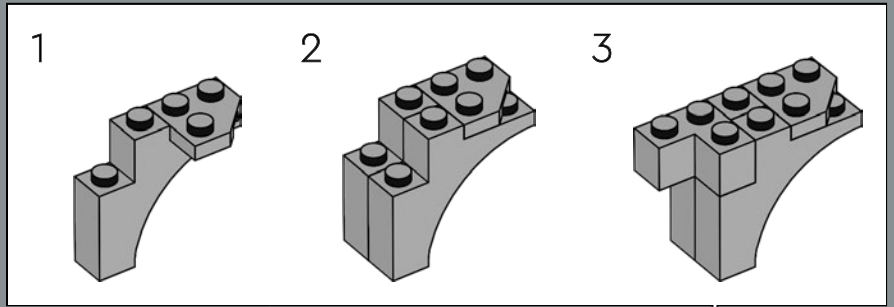



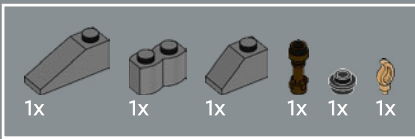

20

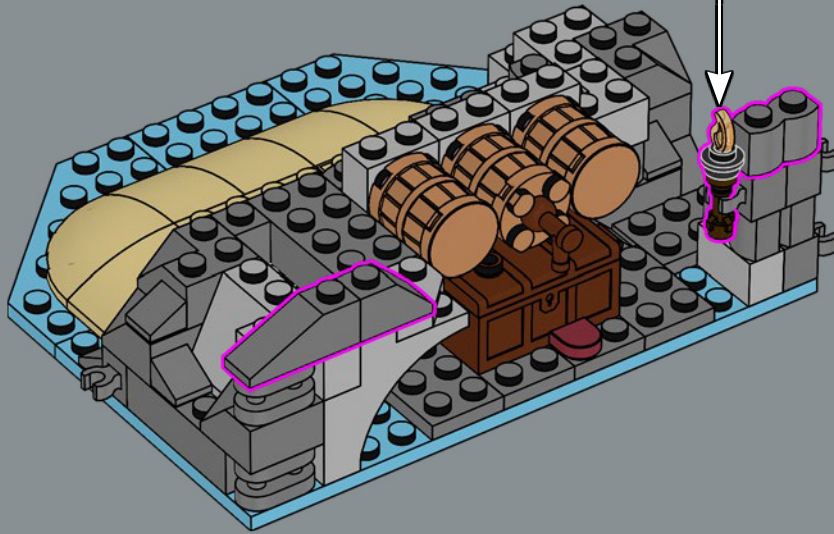
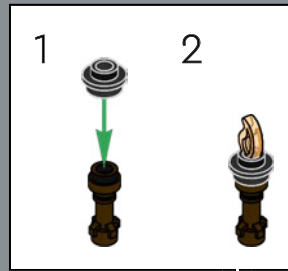

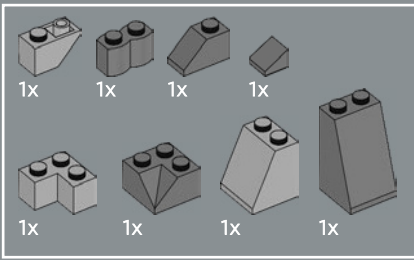

21

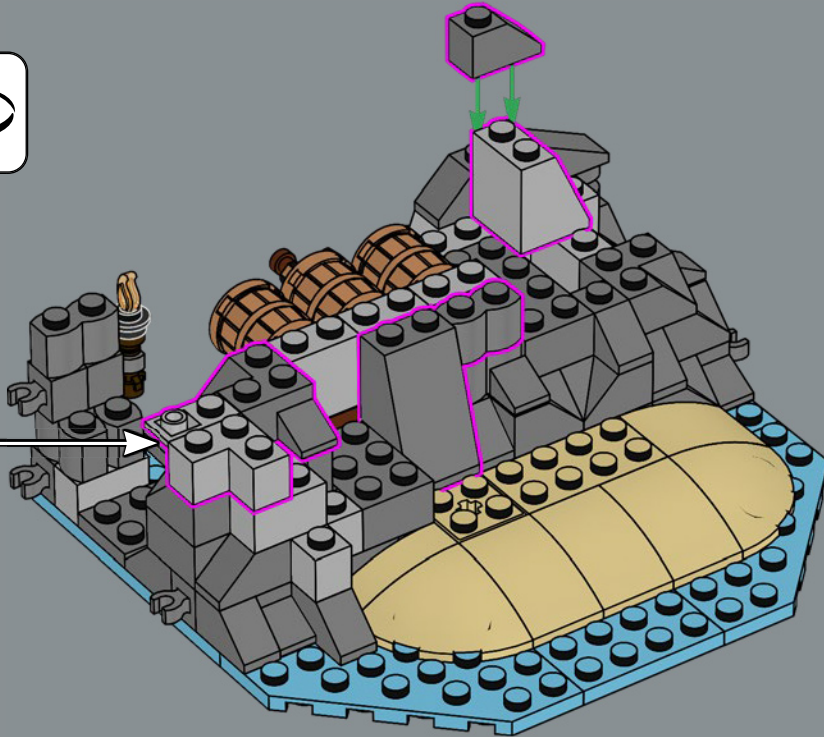
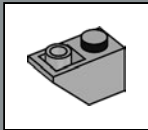

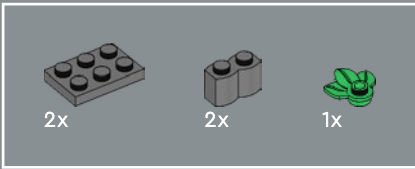

22

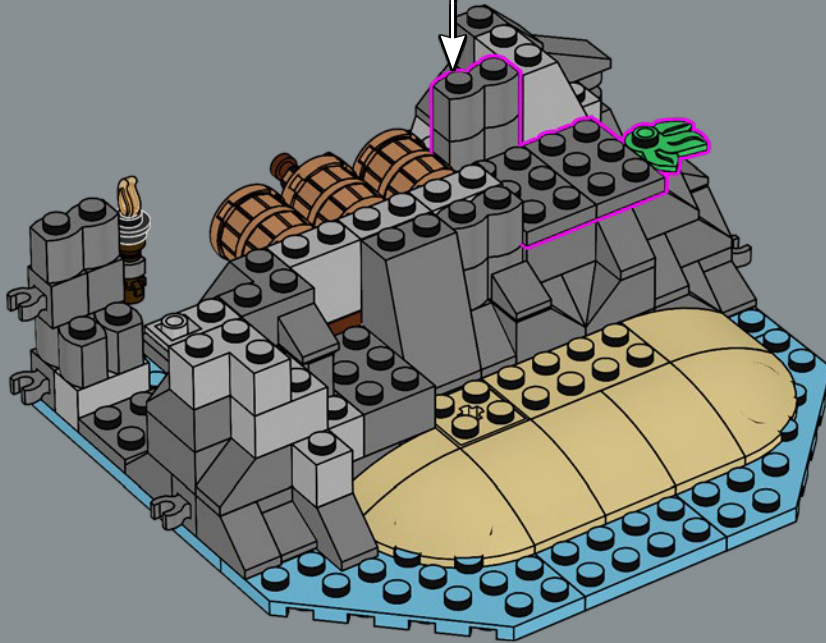
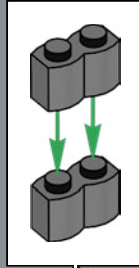

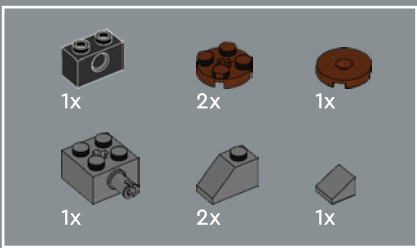

23

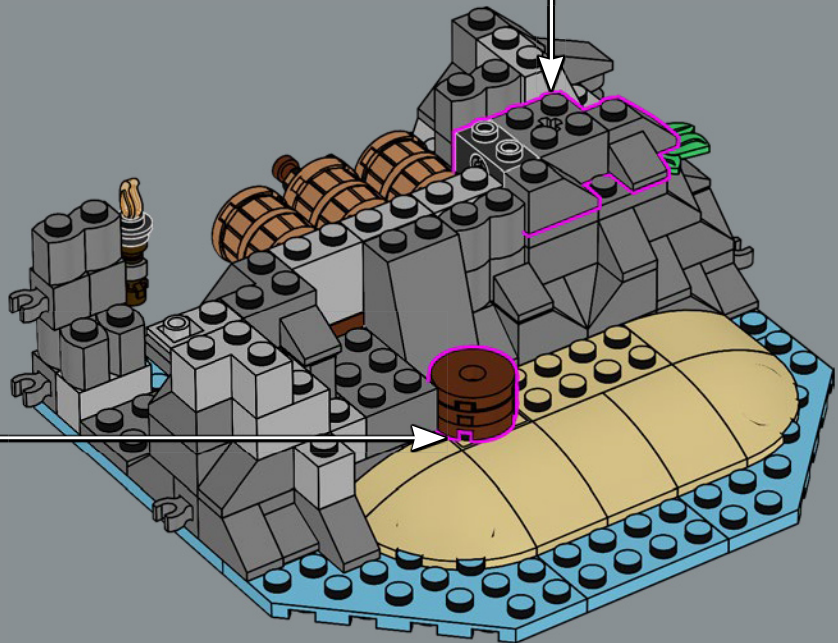
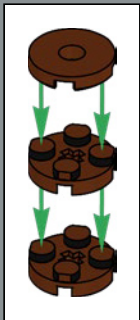
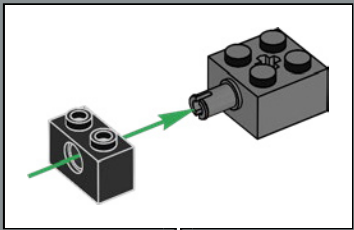

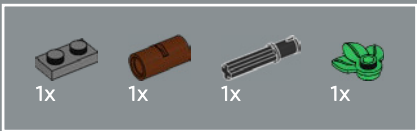

24

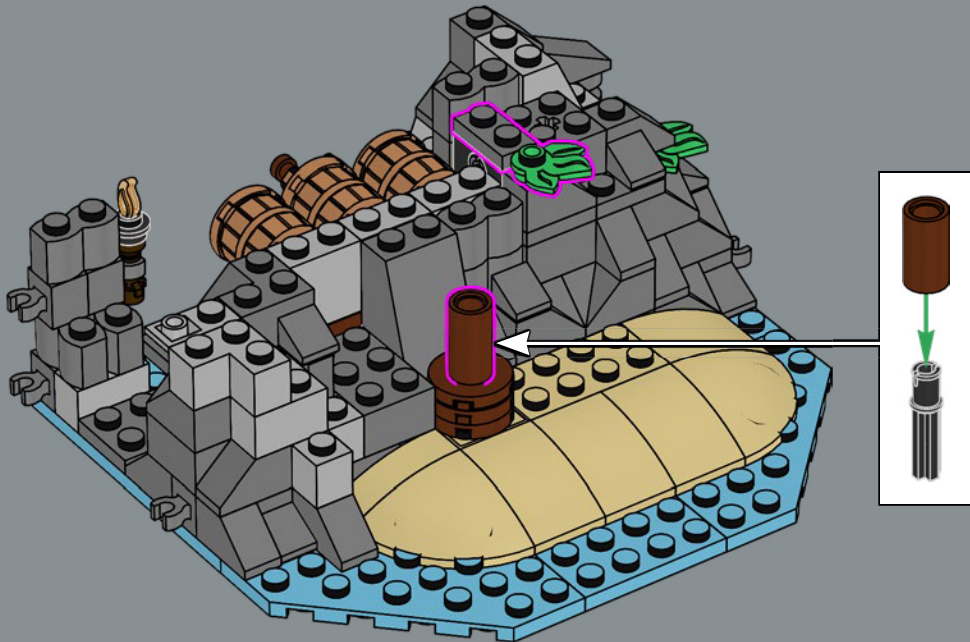

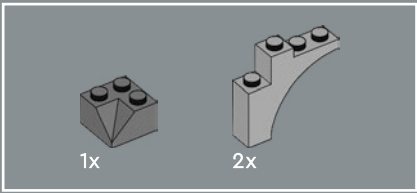

25

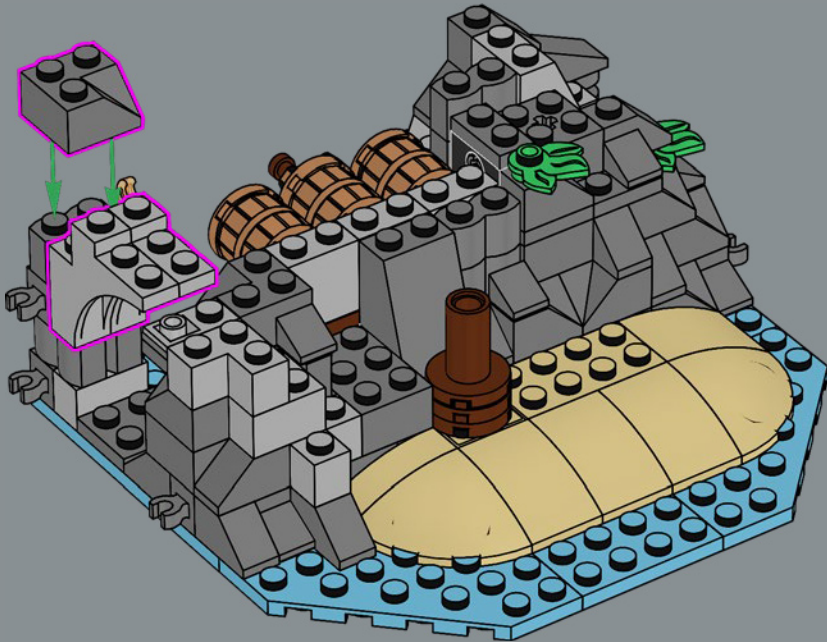

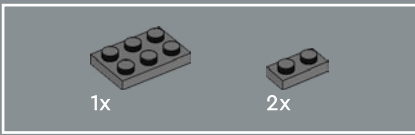

26

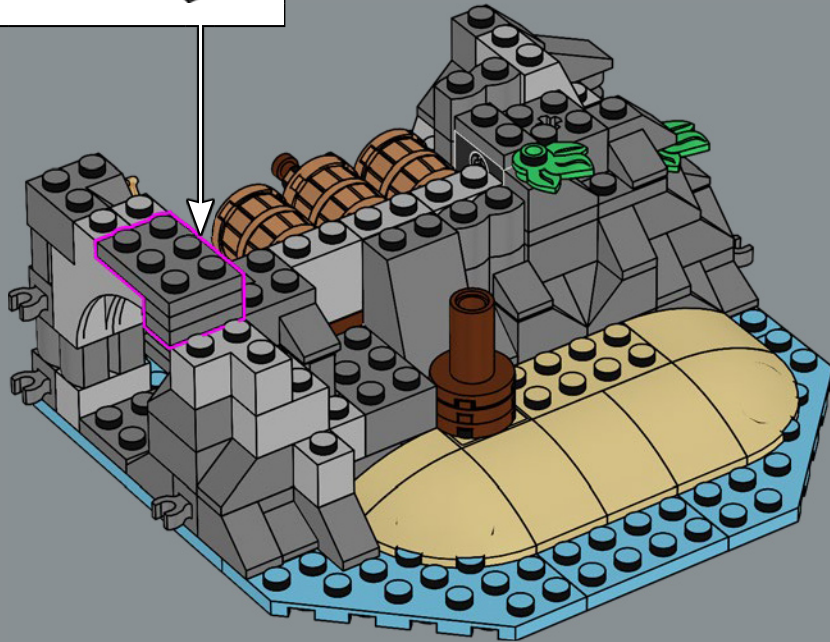
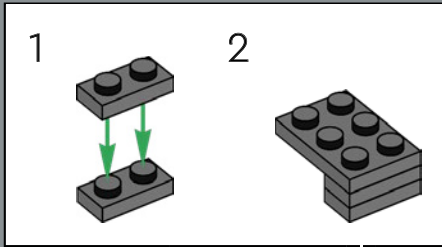

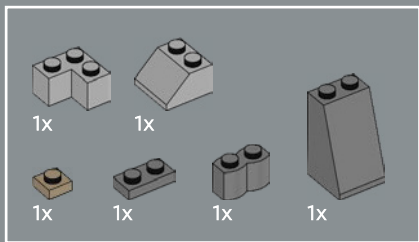

27

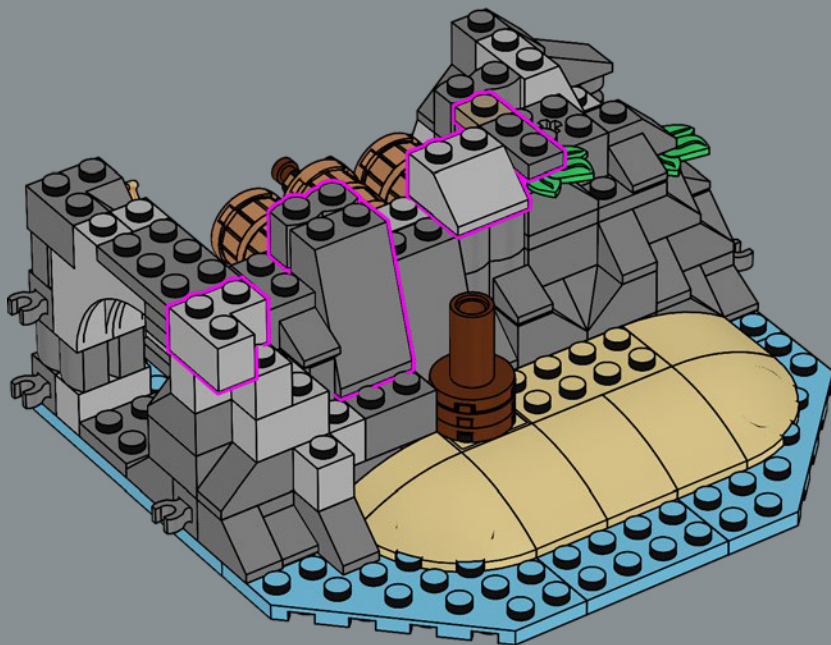



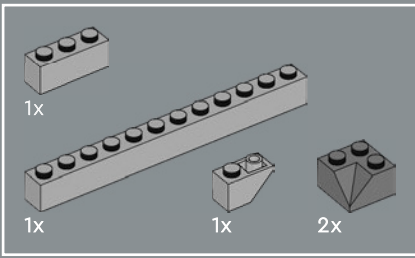

28

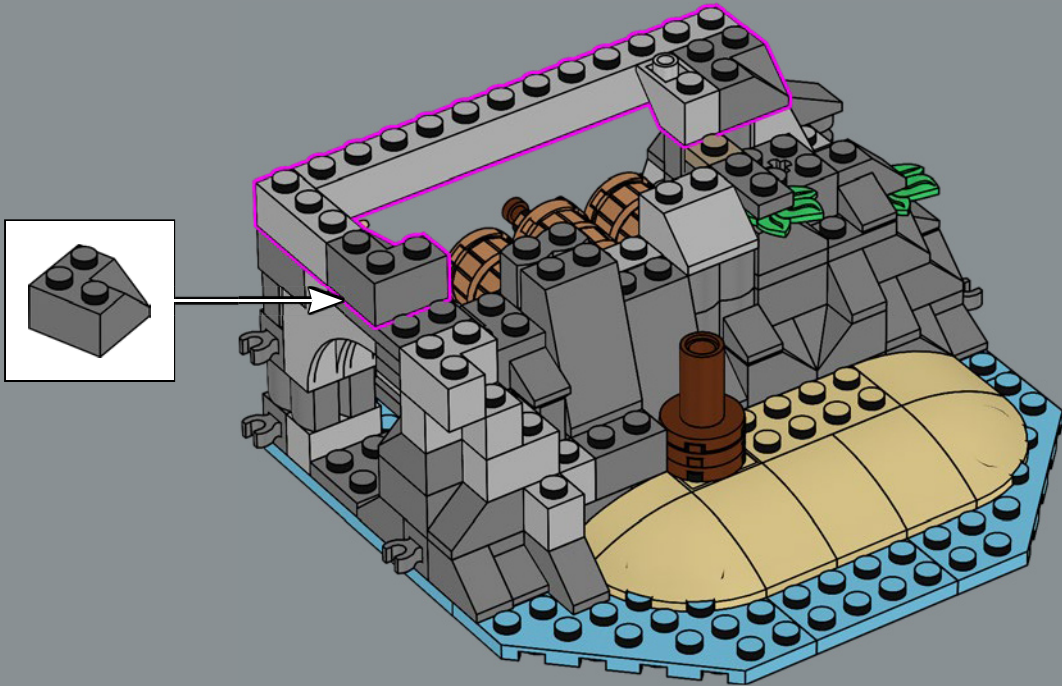

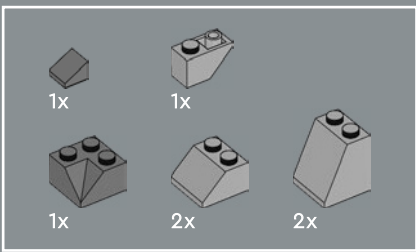

29

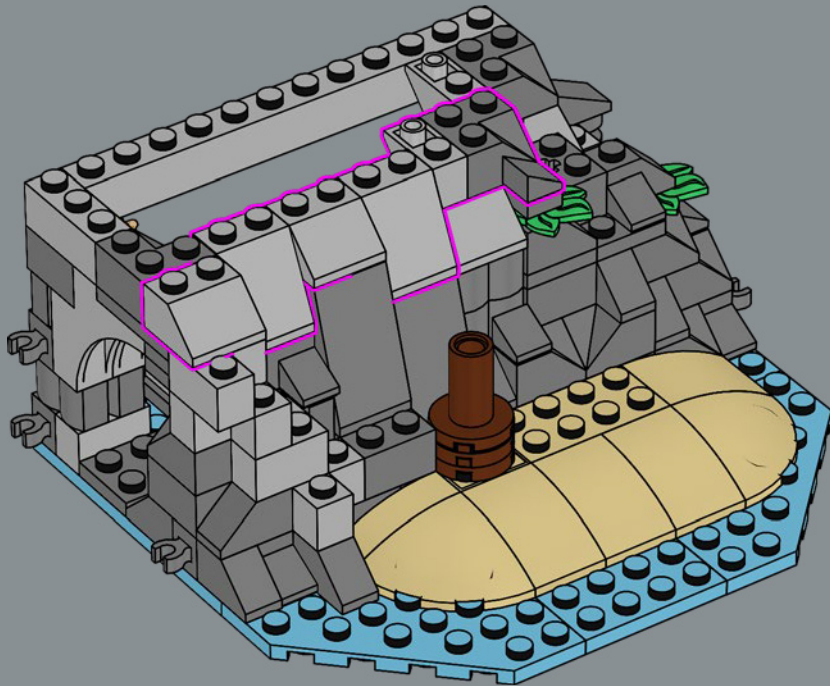

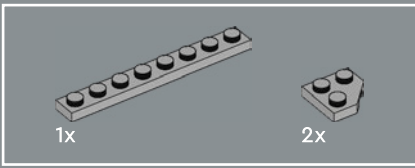

30

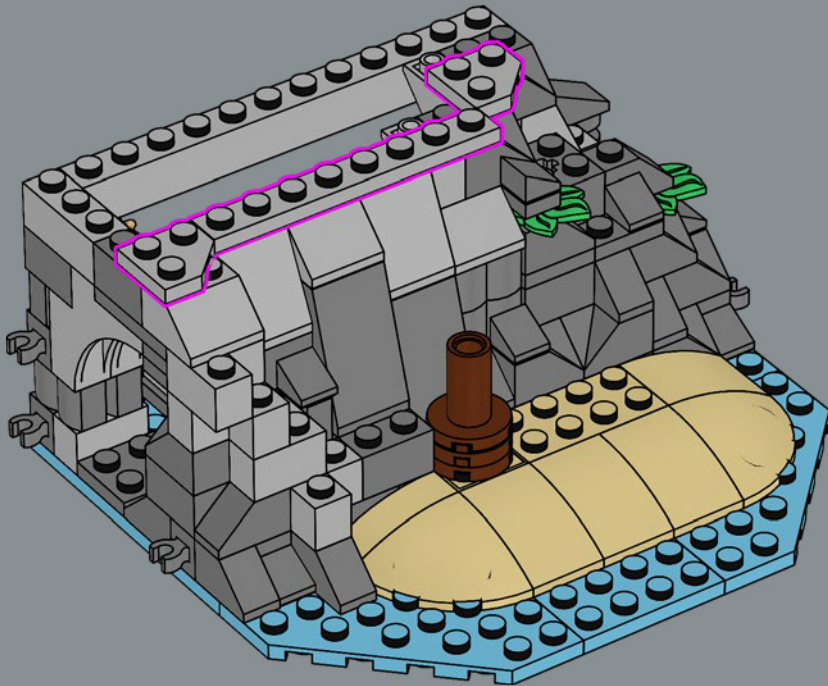

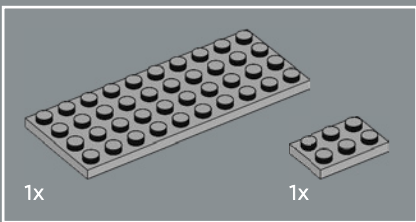

31

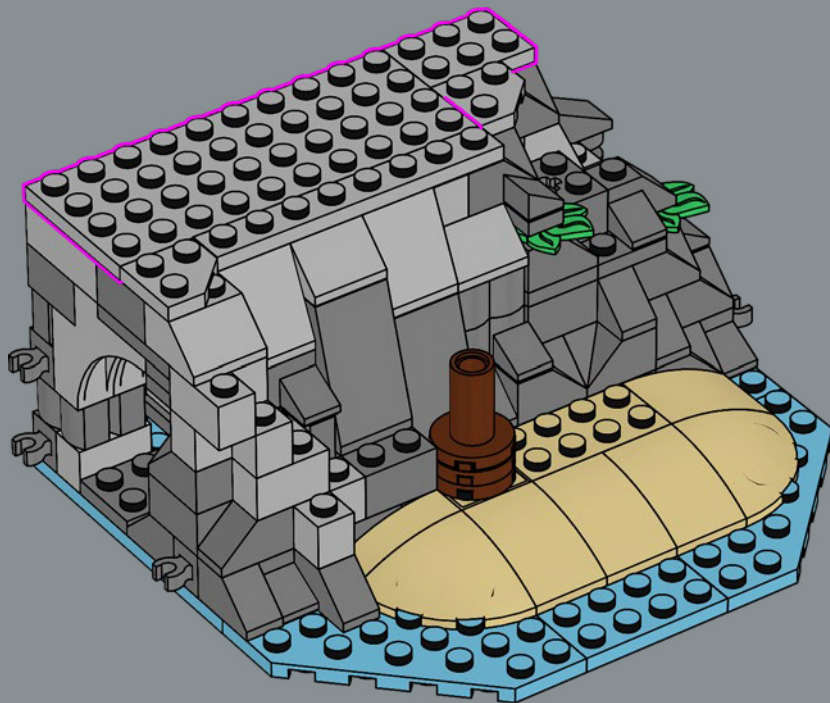

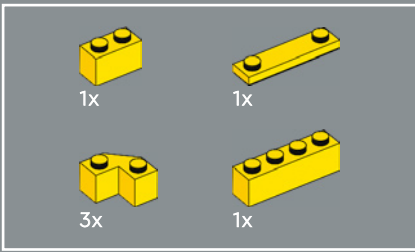

32

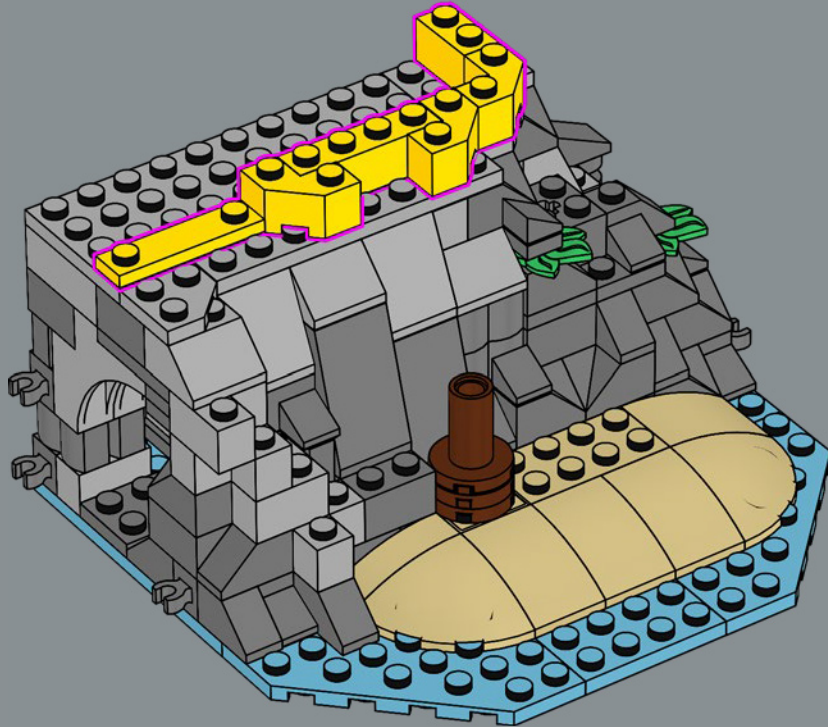

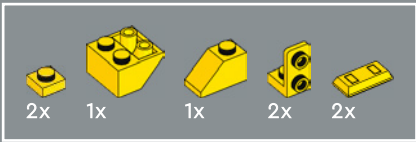

33

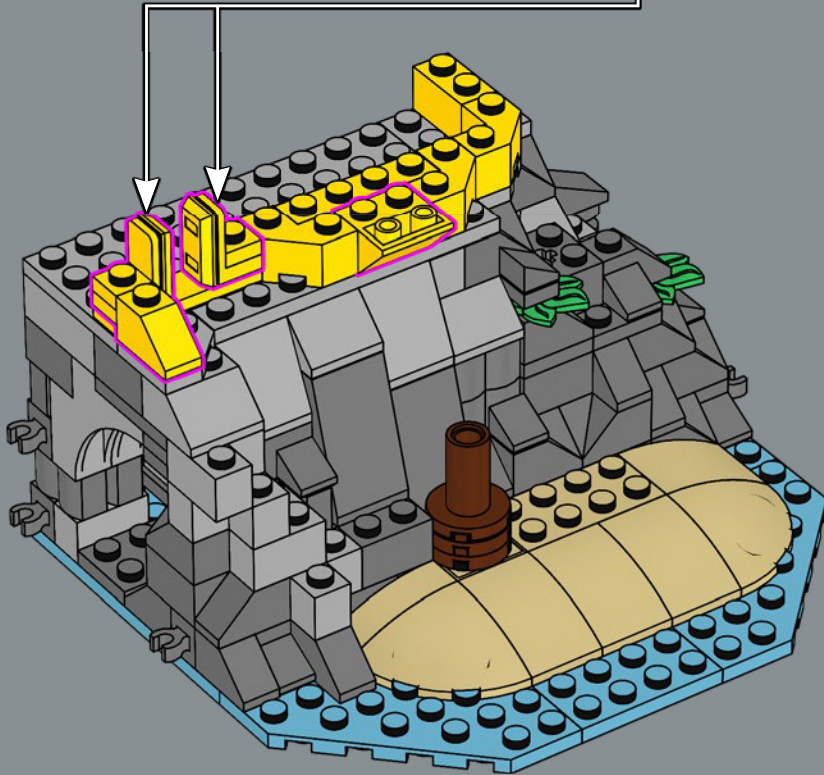
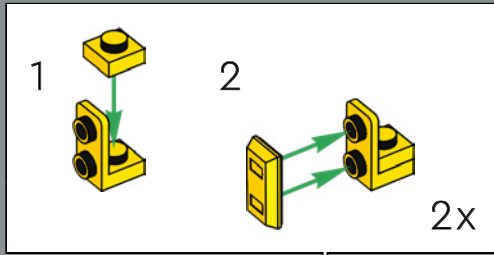

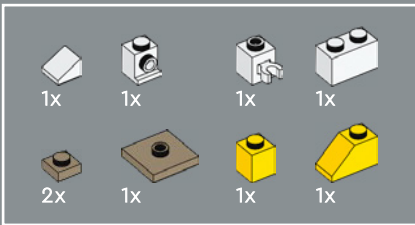

34

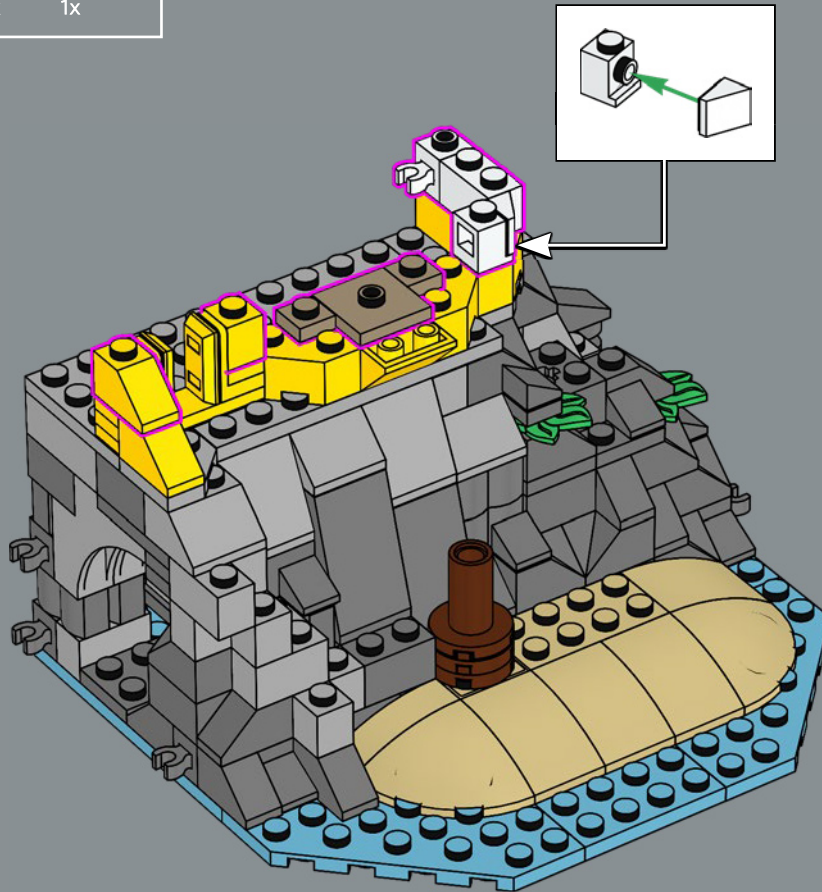

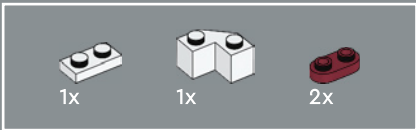

35

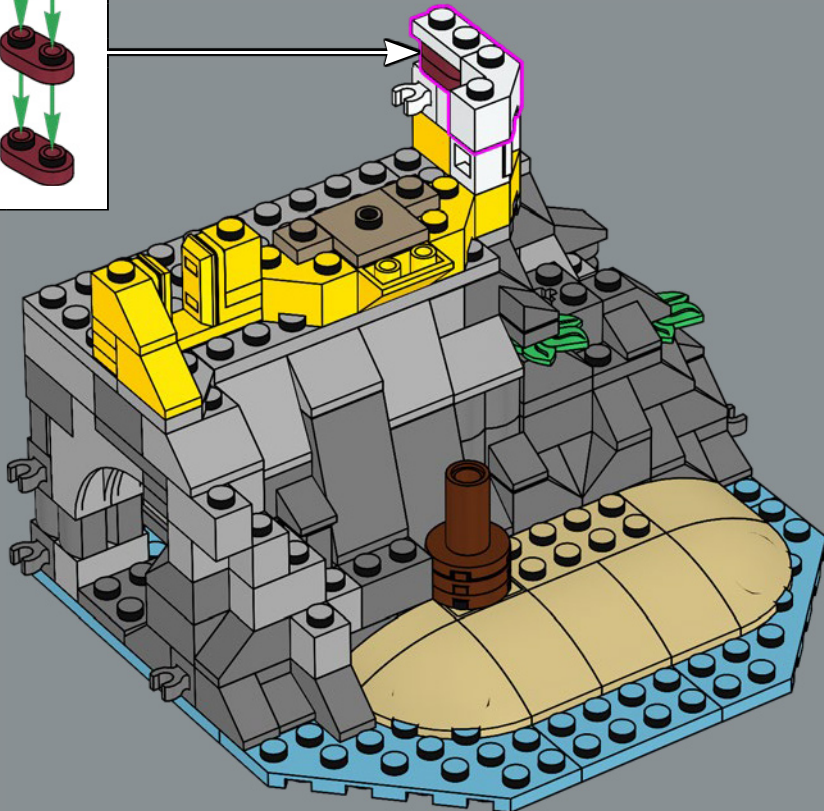
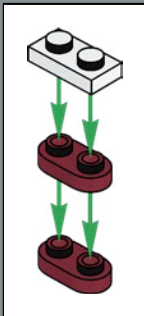



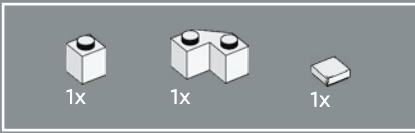

36

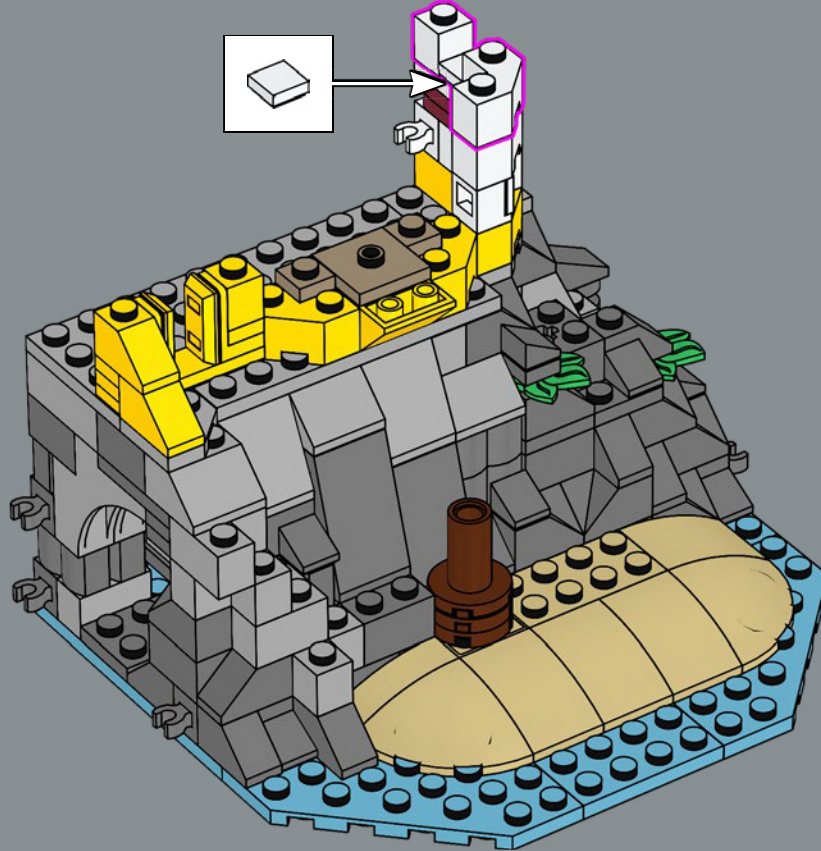

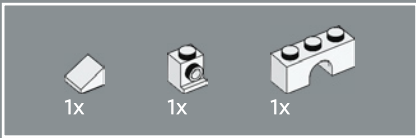

37

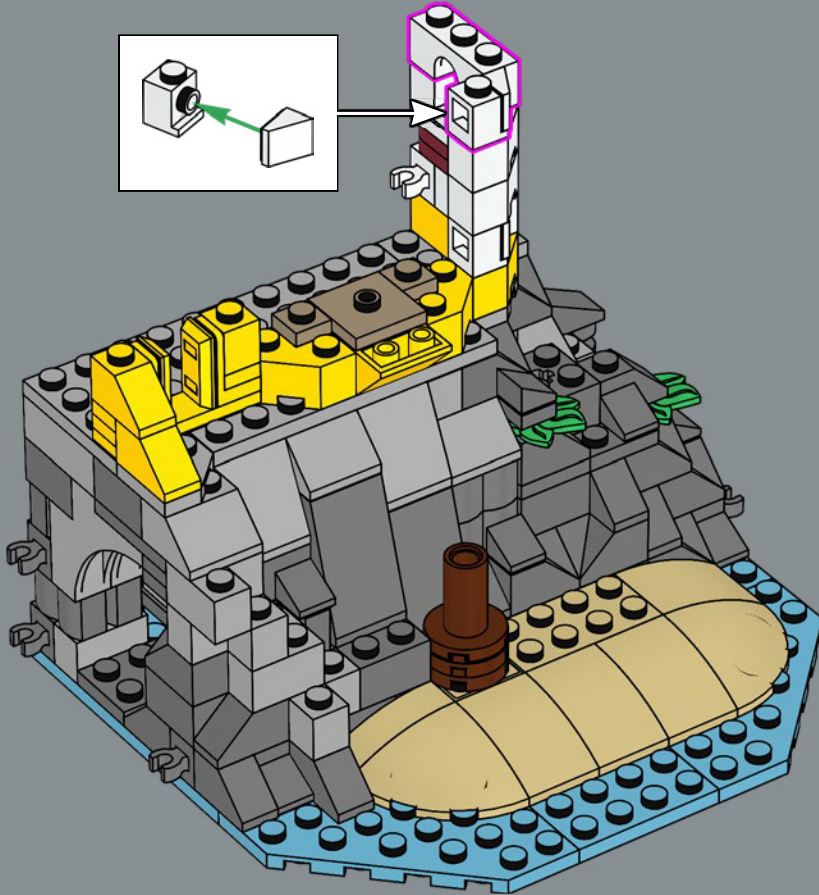

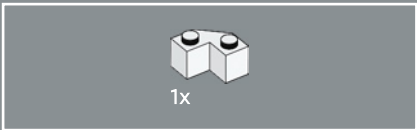

38

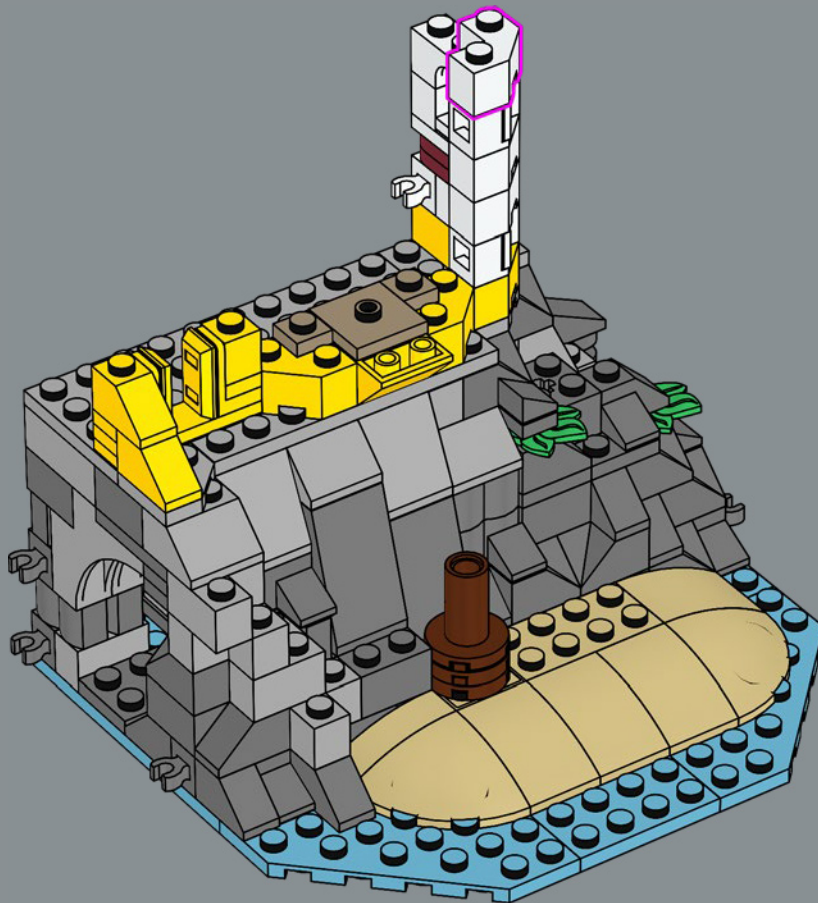

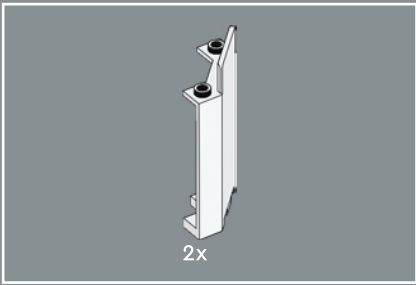

39

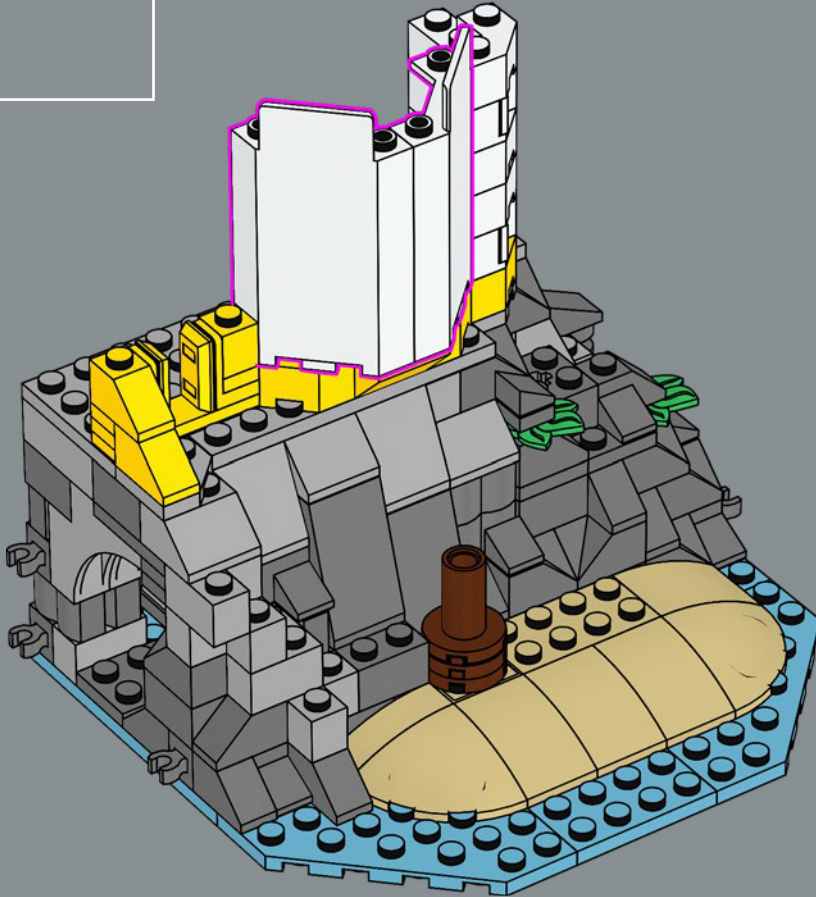



40

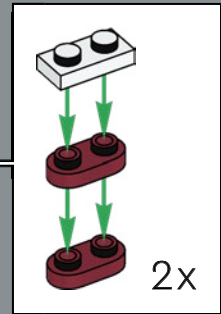
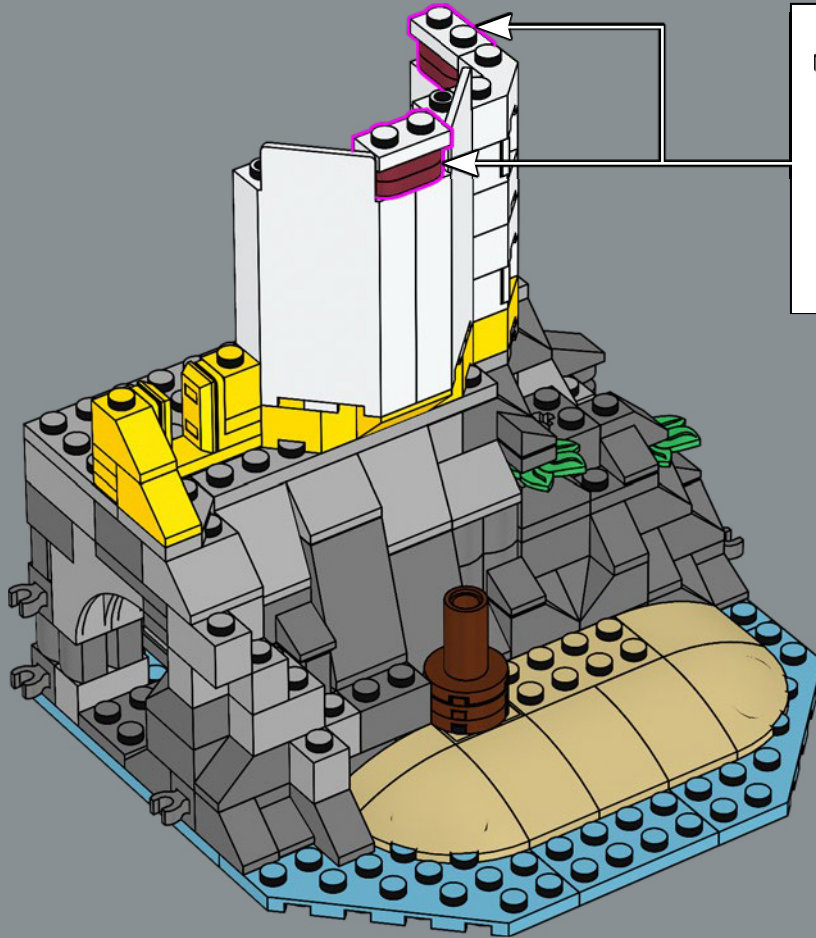

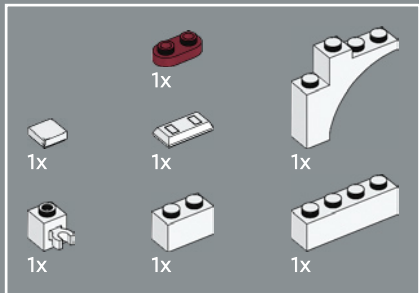

41

1

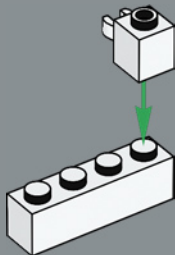

2

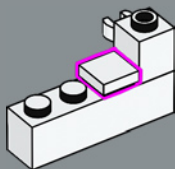

3

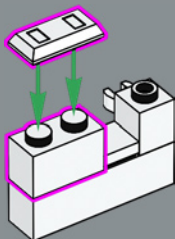

4

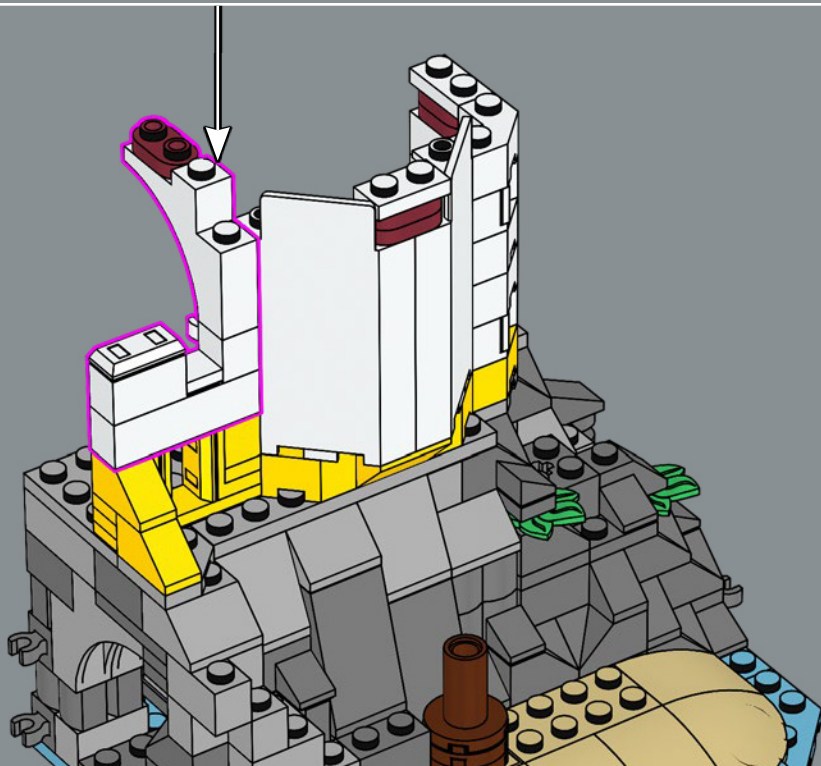
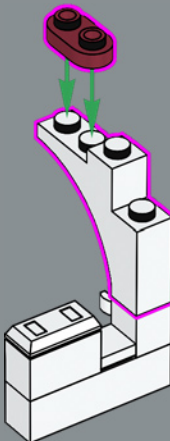

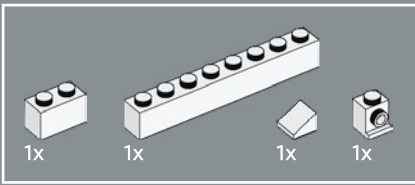

42

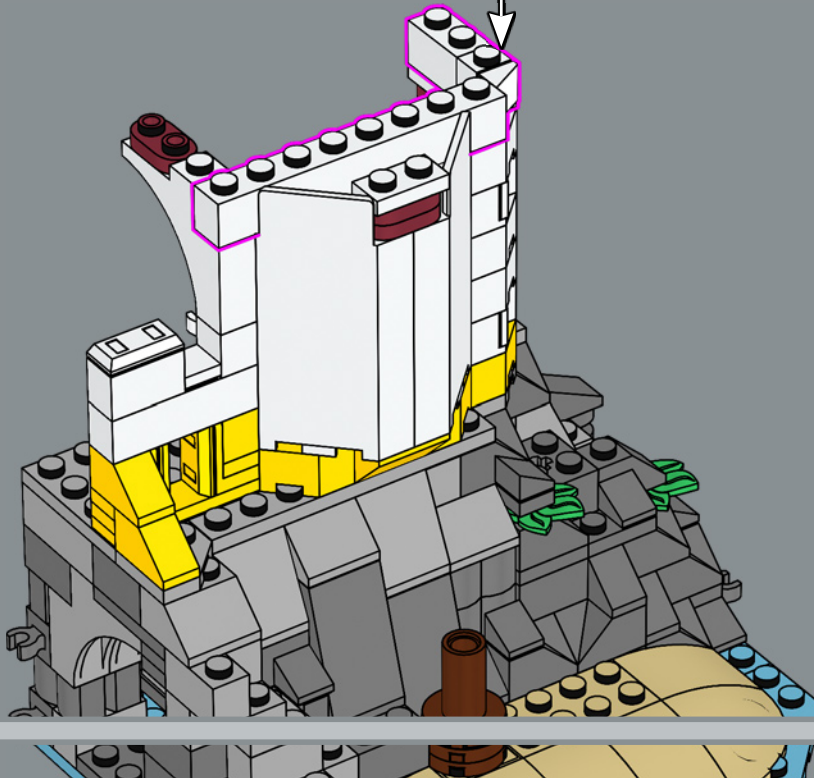
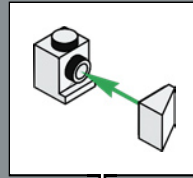

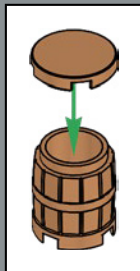

43

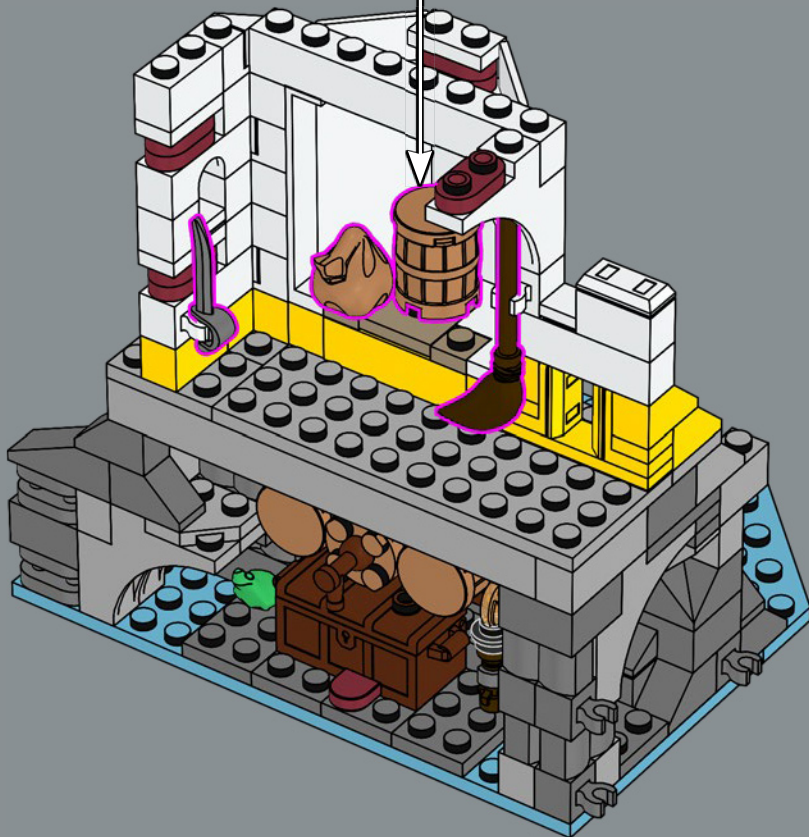



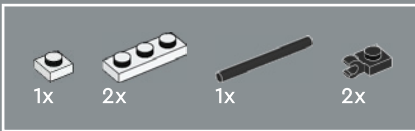

44

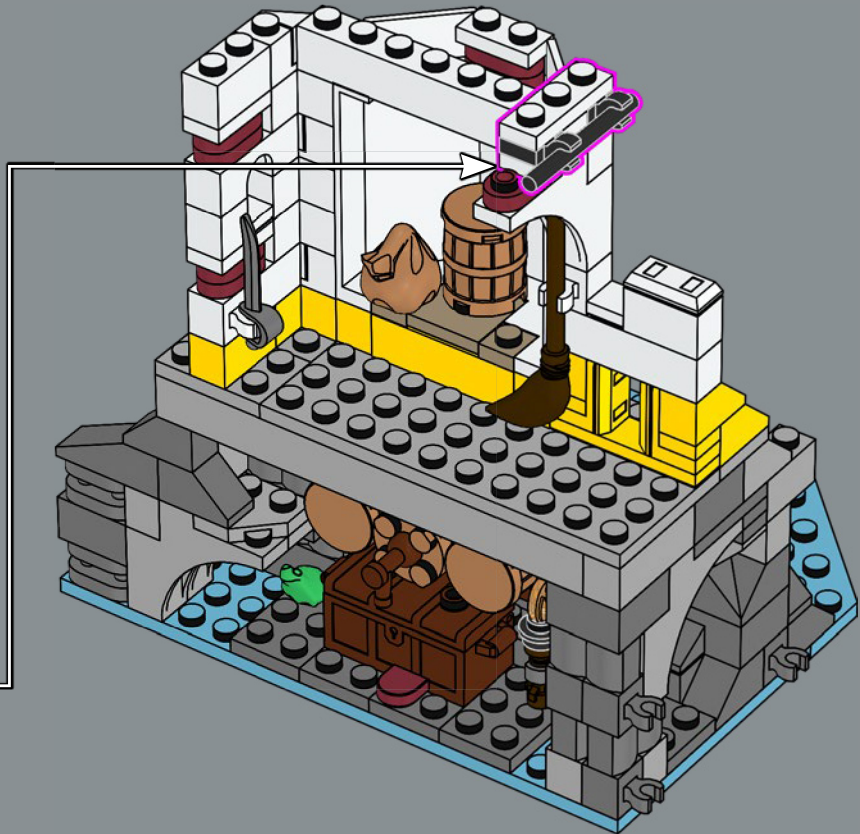
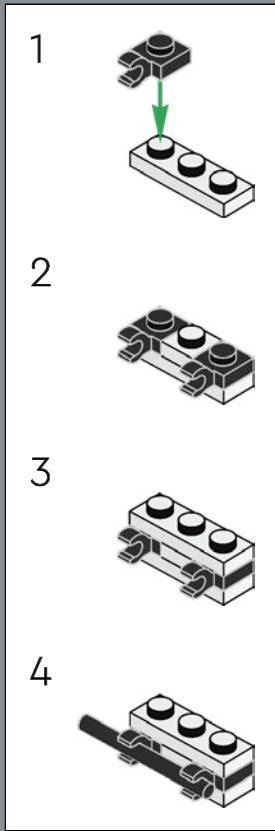

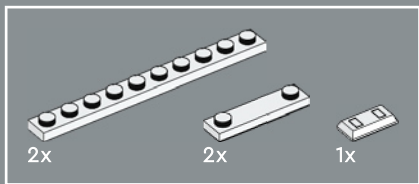

45

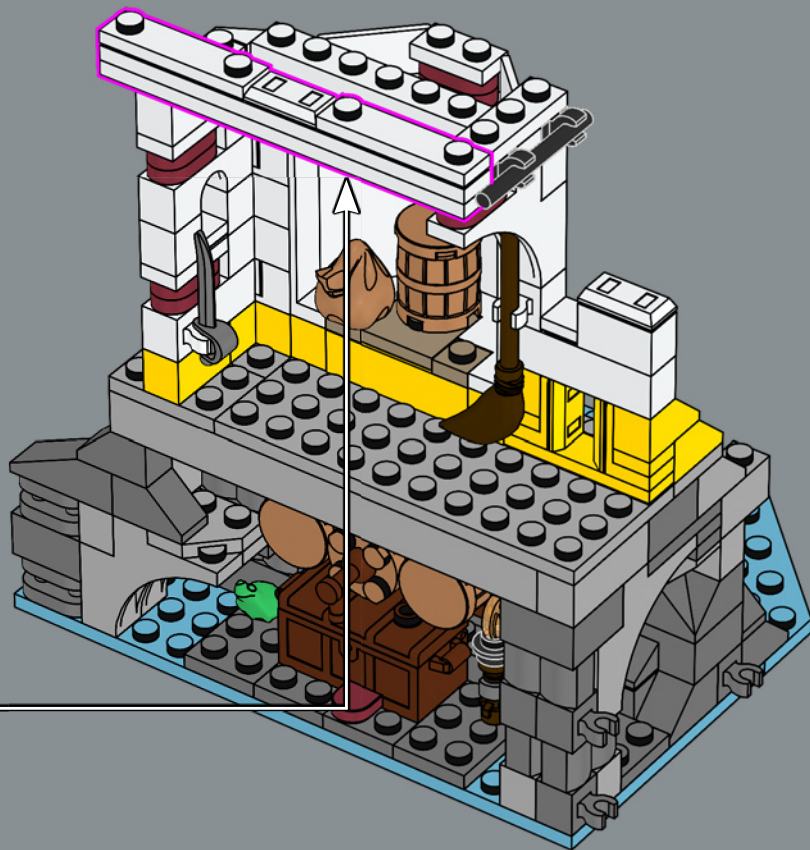
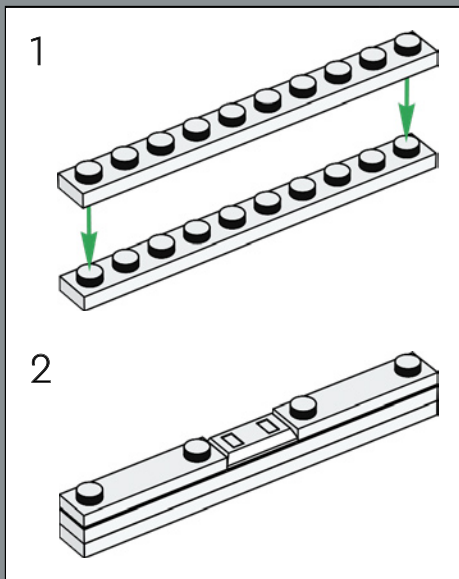

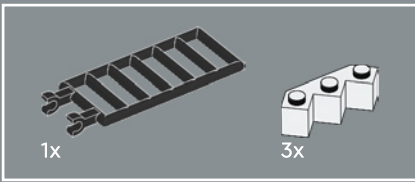

46

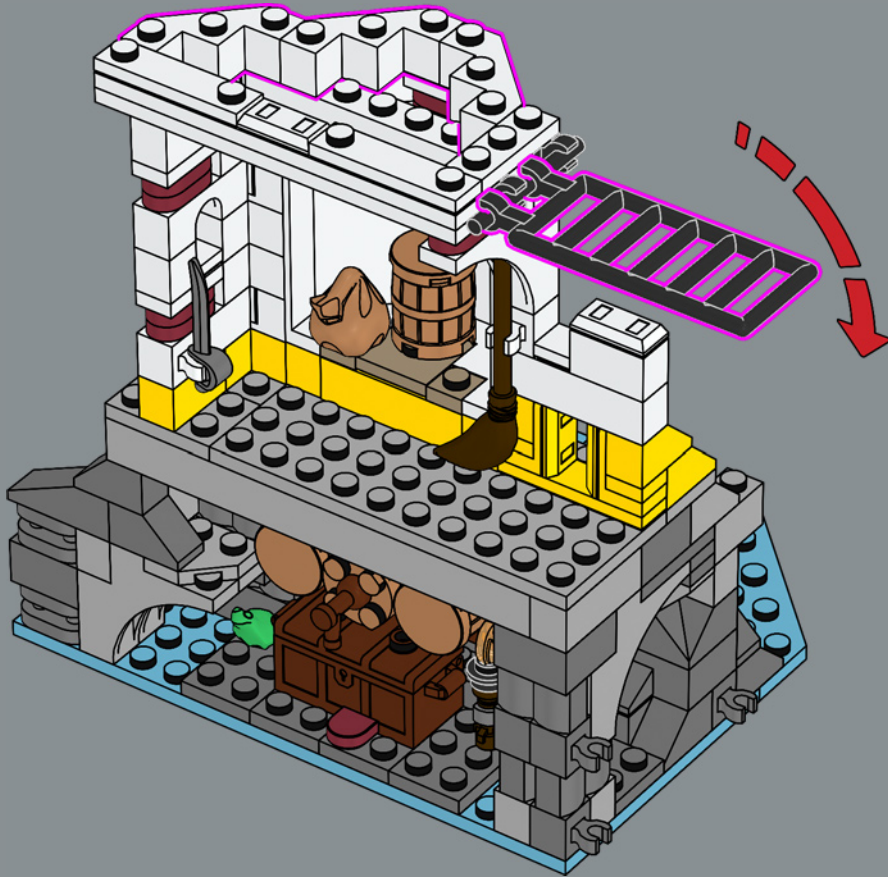

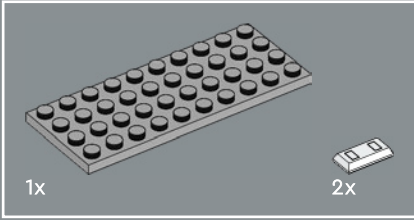
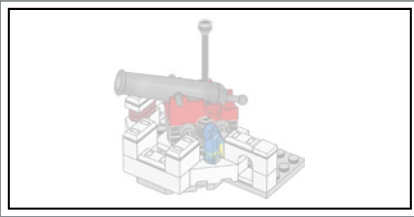

47

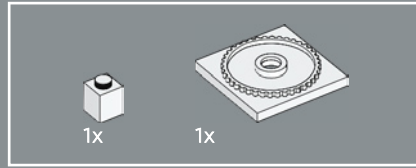
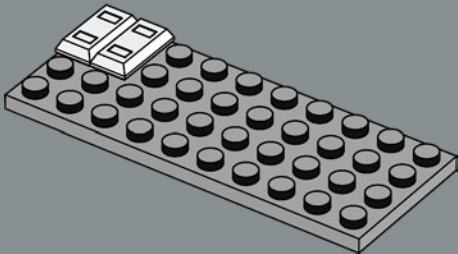

48

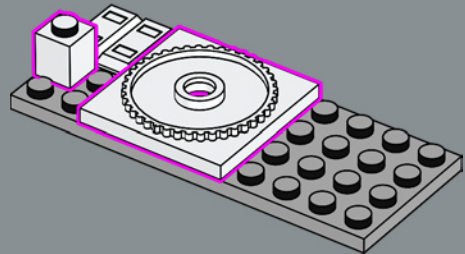

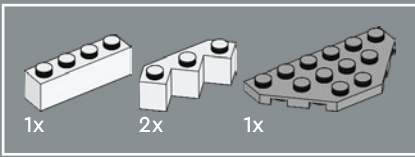

49

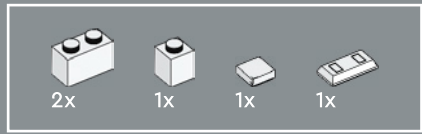
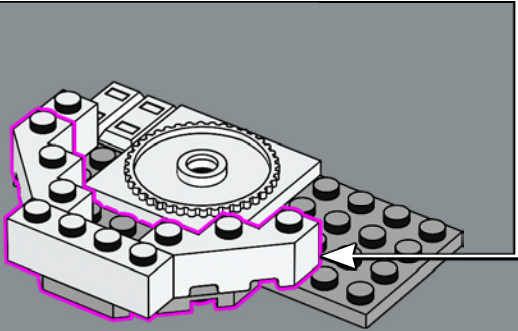
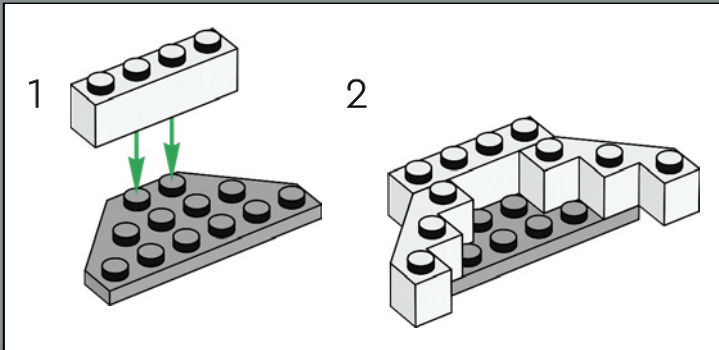

50

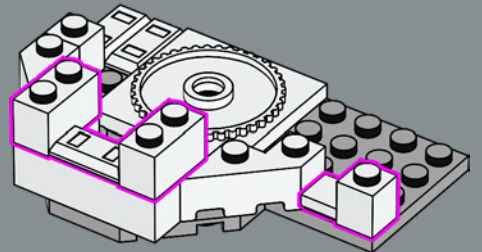

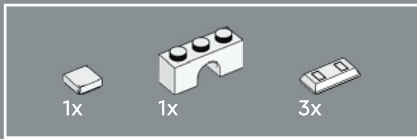

51

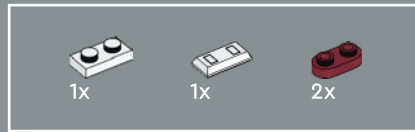
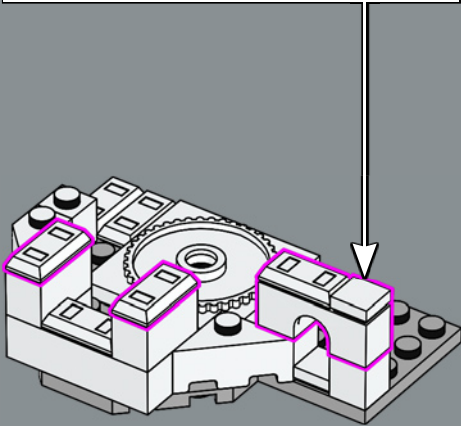
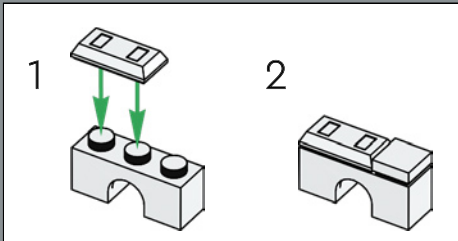

52

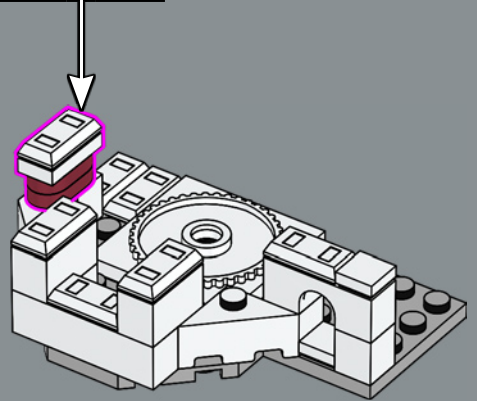
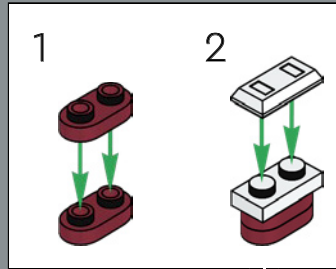

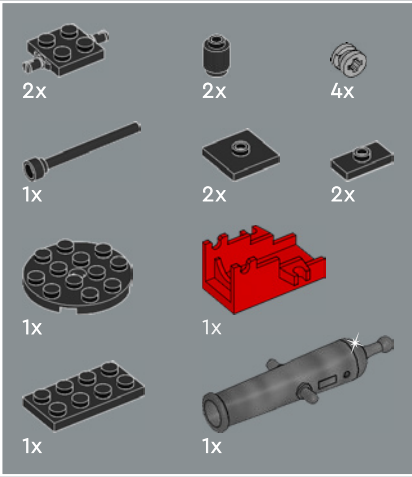
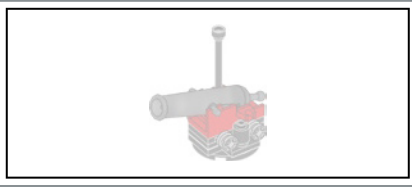

53

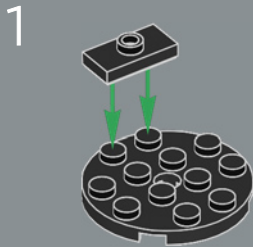

1



2

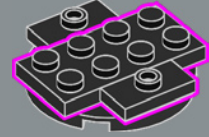

3

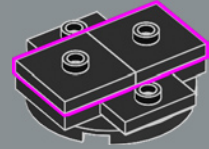

4

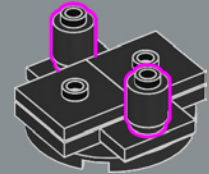



¿Tienes que atacar a los latosos piratas desde otro ángulo? Puedes mover los cañones de las torres hacia atrás y hacia delante para girar, o llevarlos a otras zonas de la fortaleza.

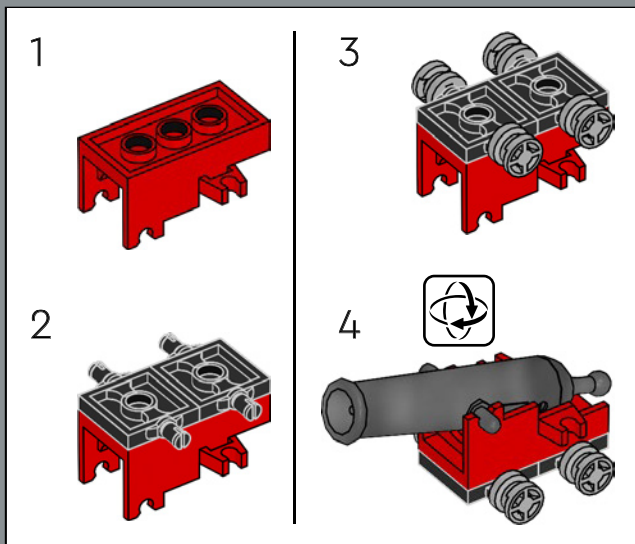

5

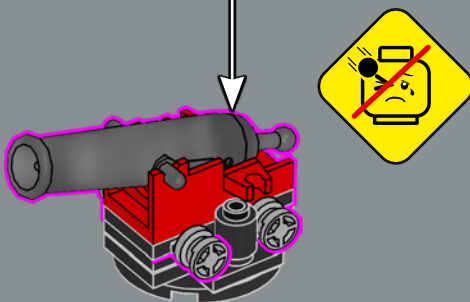

6

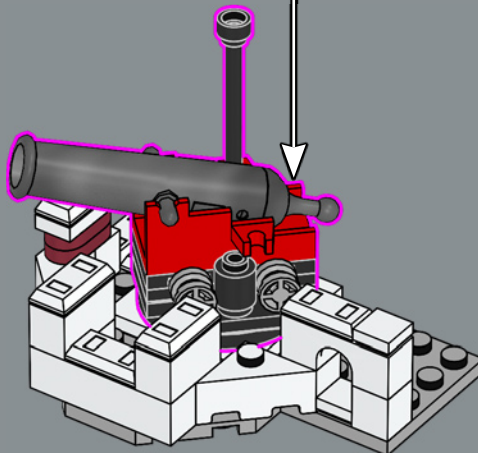
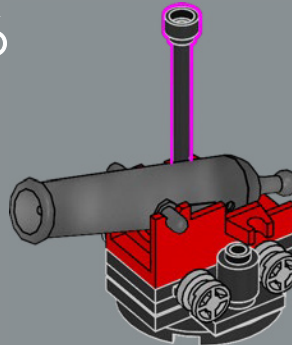





54

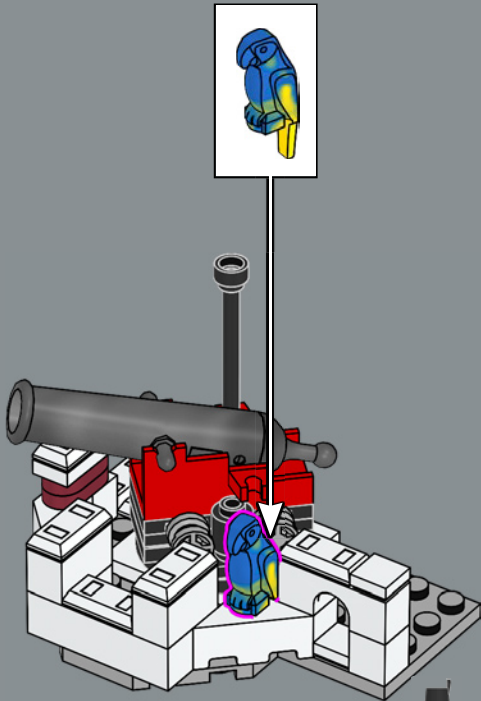

55

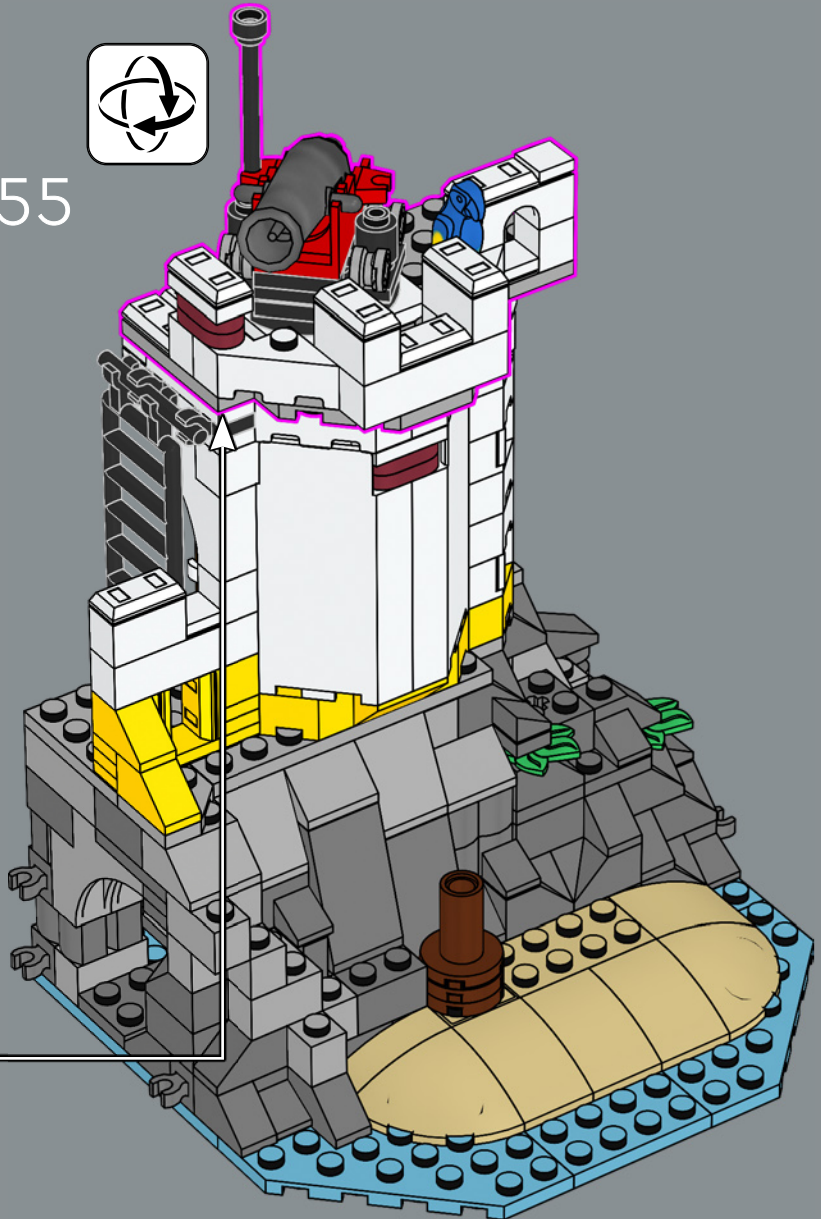

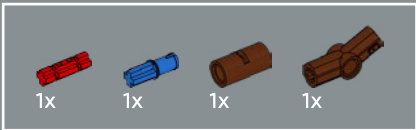

56

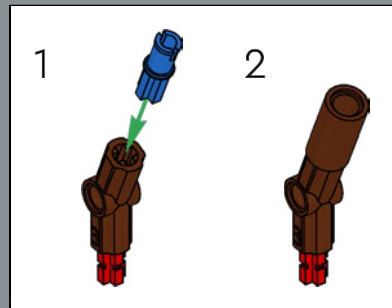
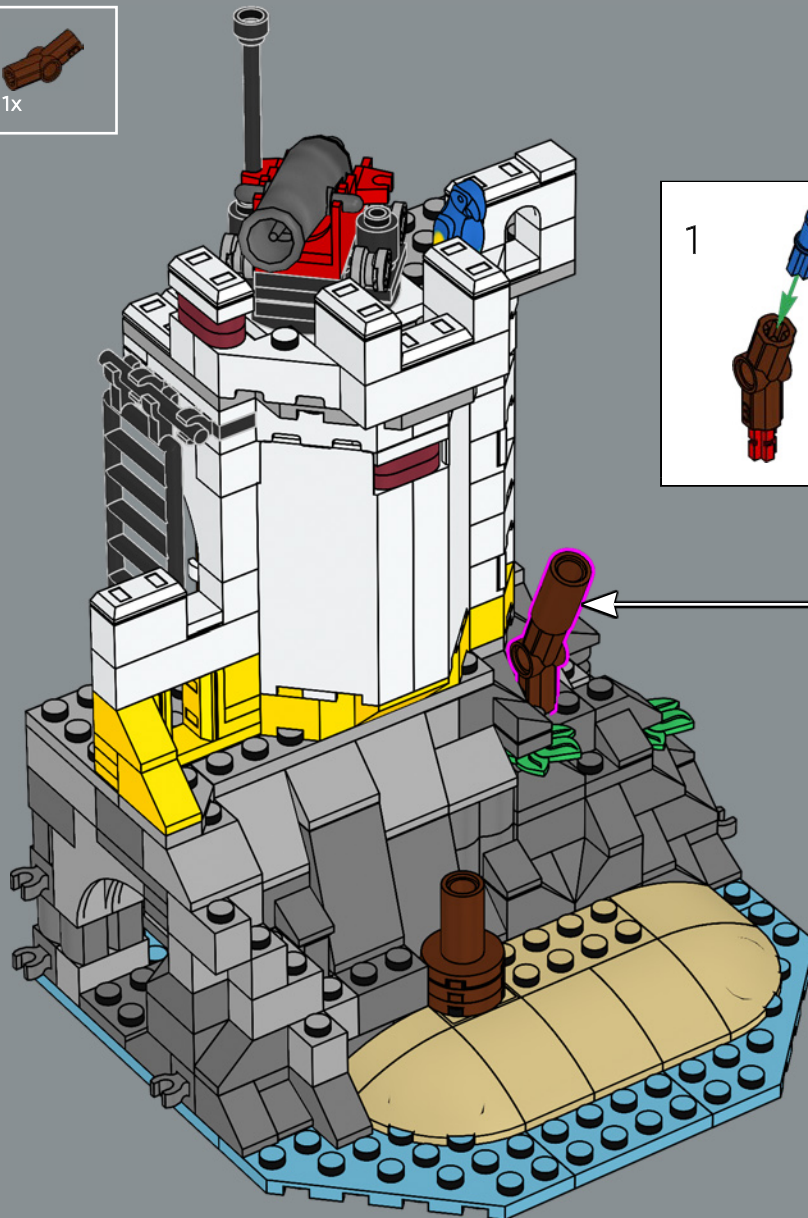

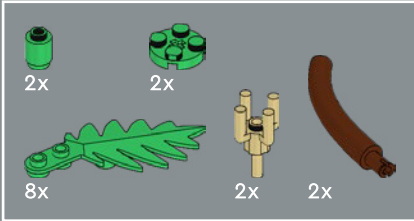
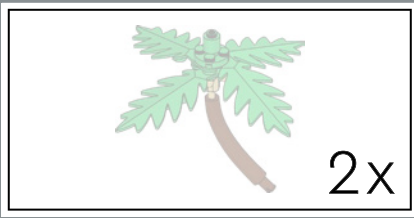

57

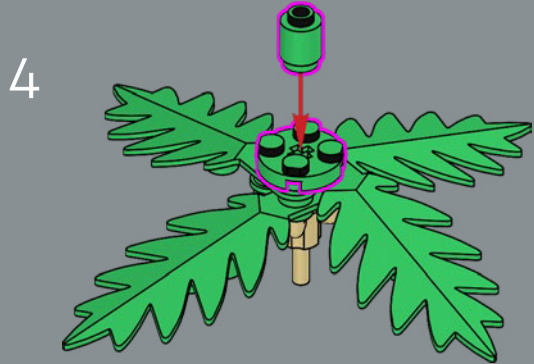
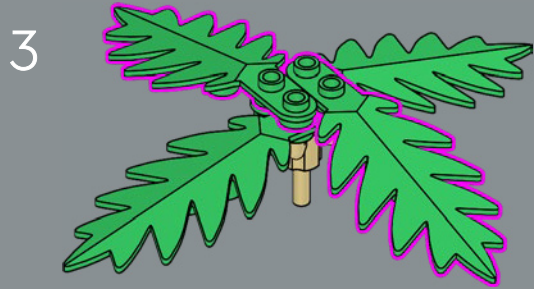
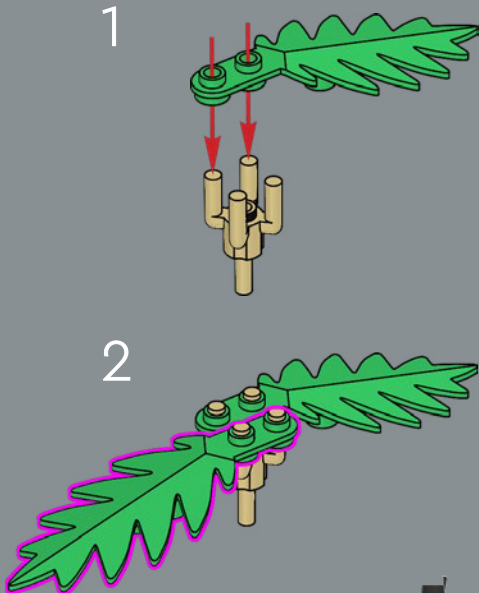

2x

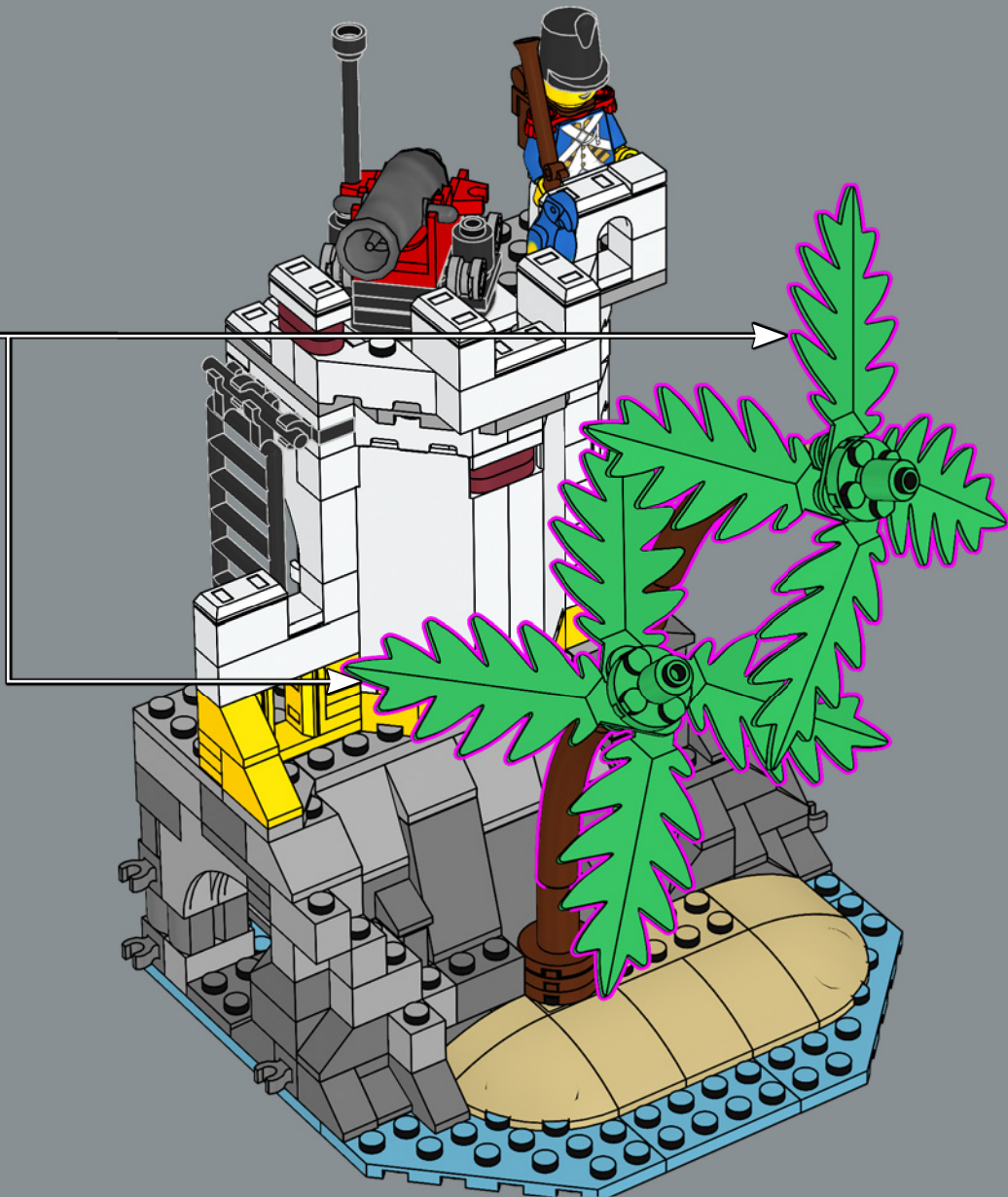

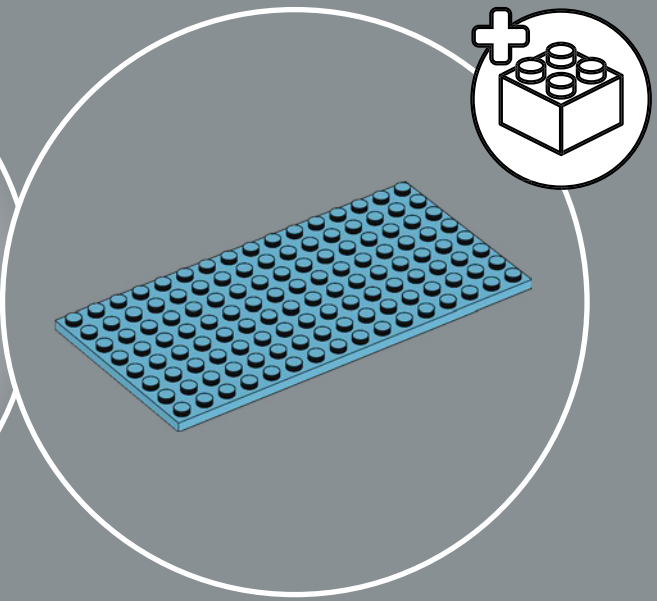

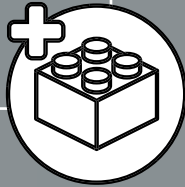
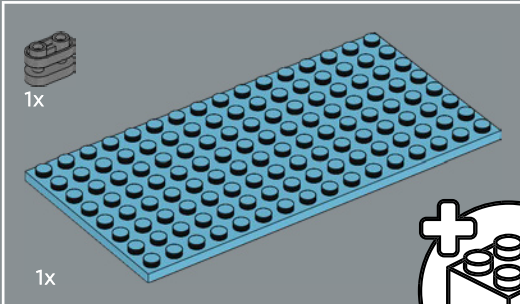
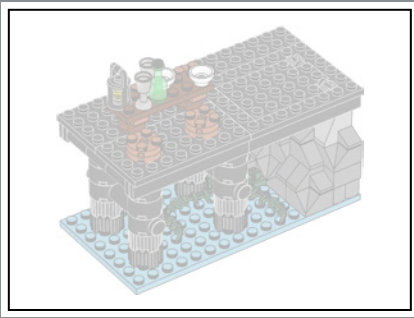

58

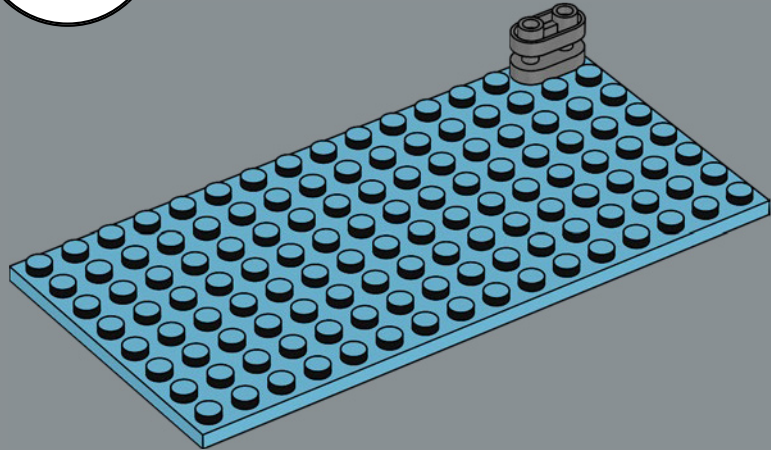

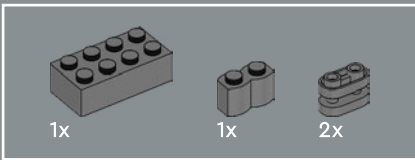

59

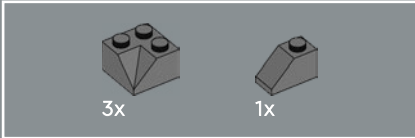
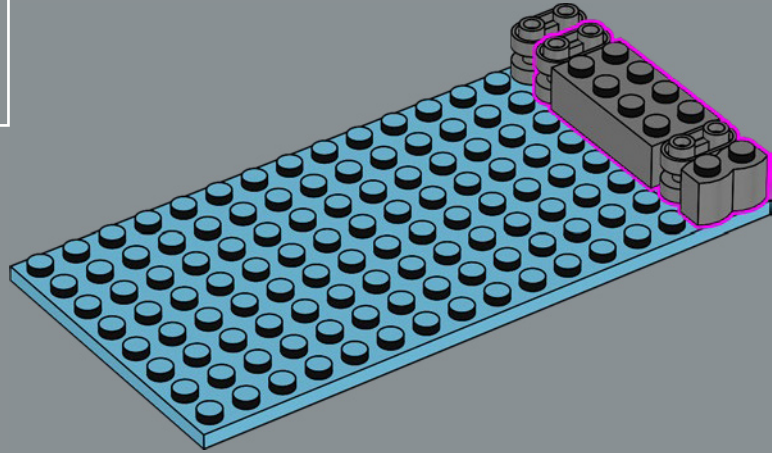

60

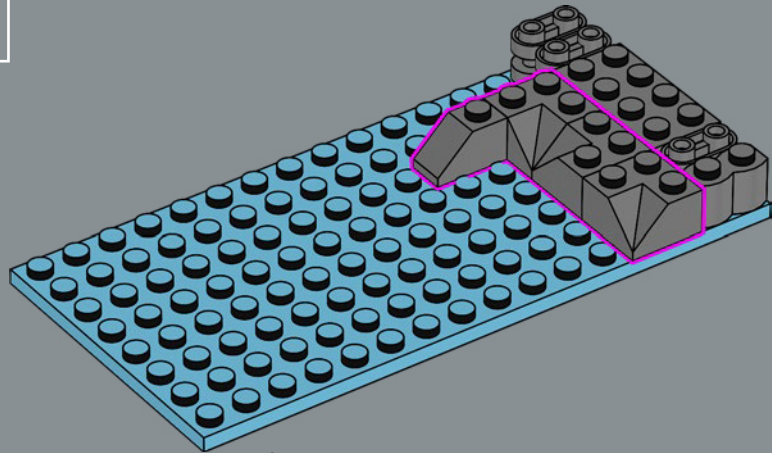



3x

61

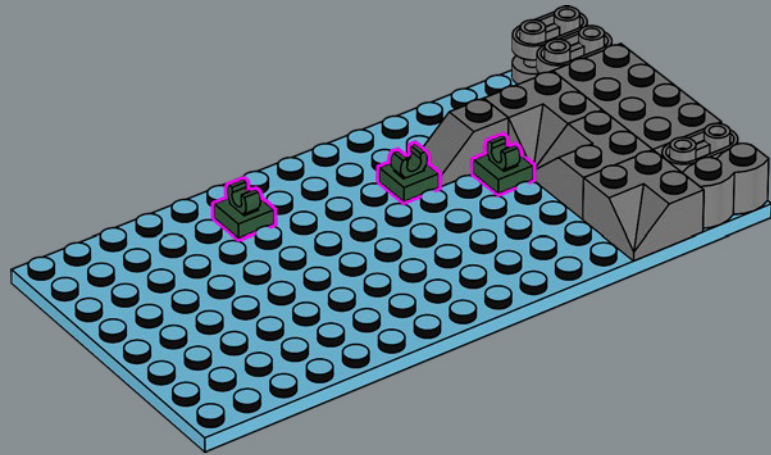

3x

62

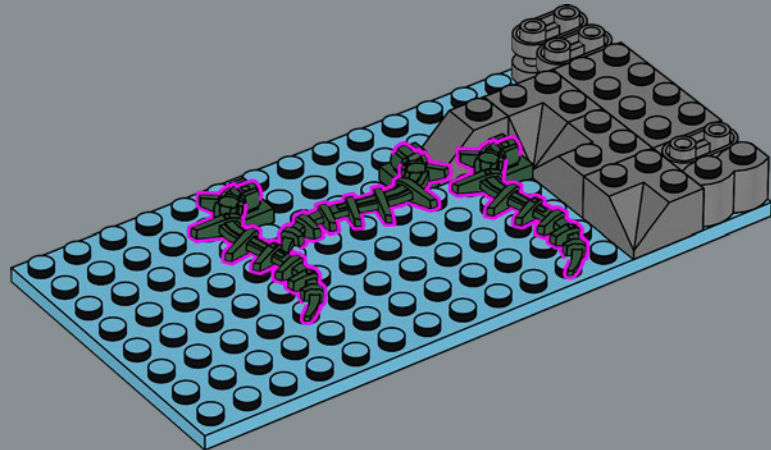



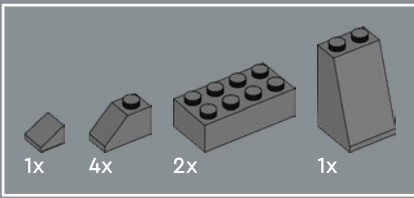

63

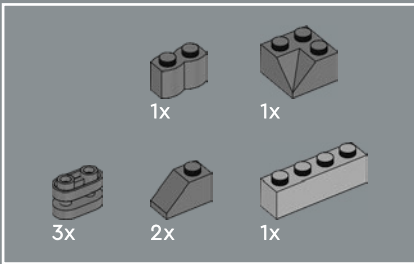
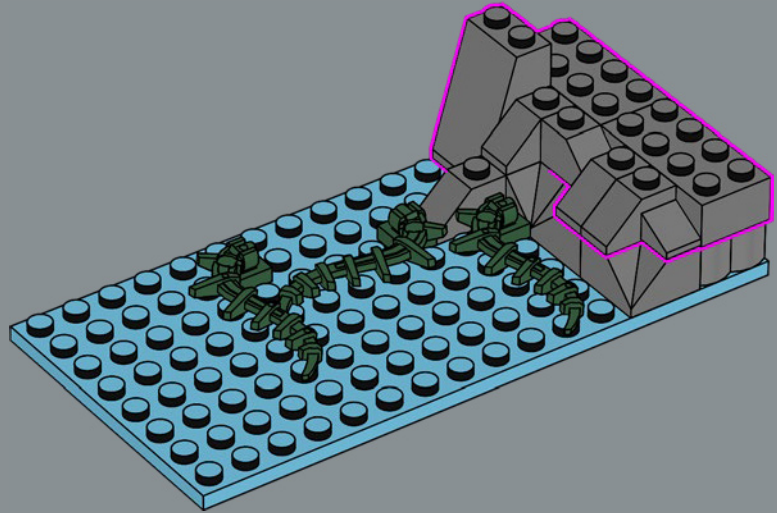

64

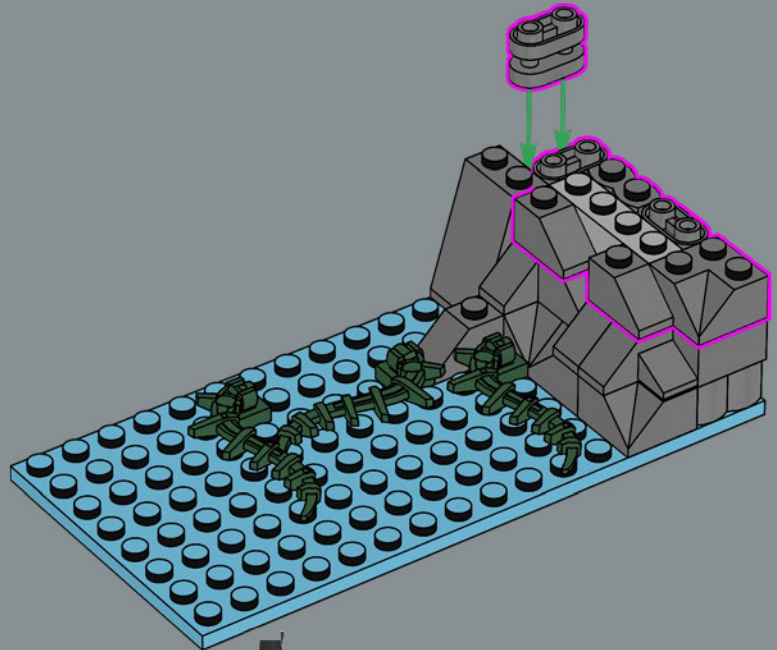

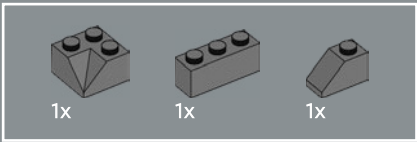

65

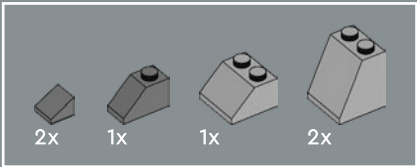
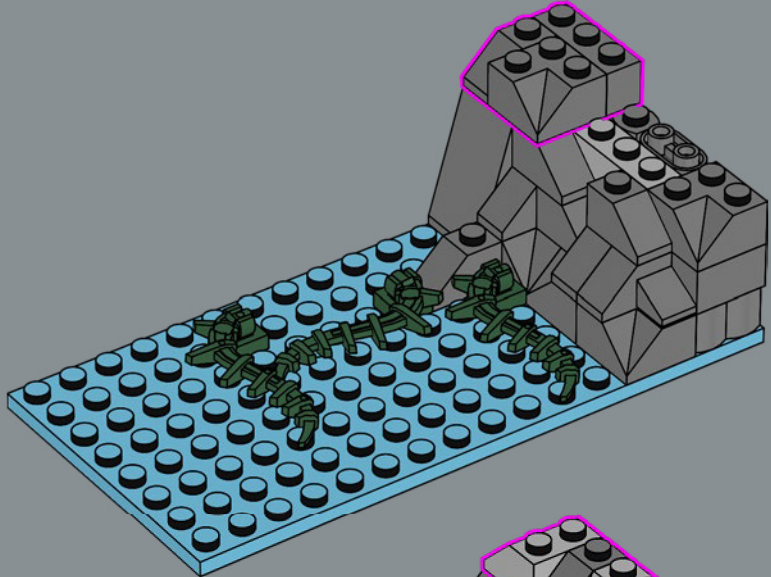

66

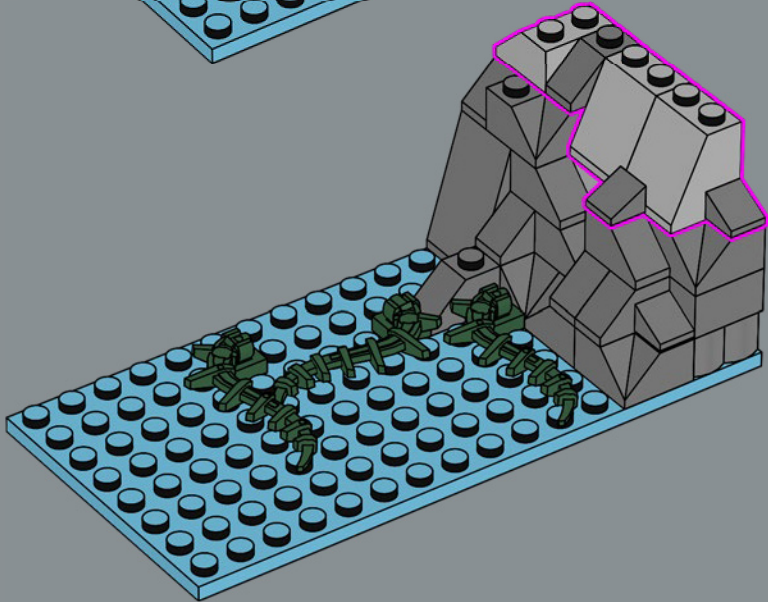



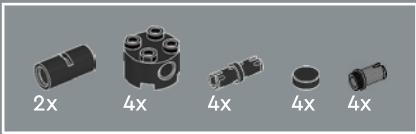

69

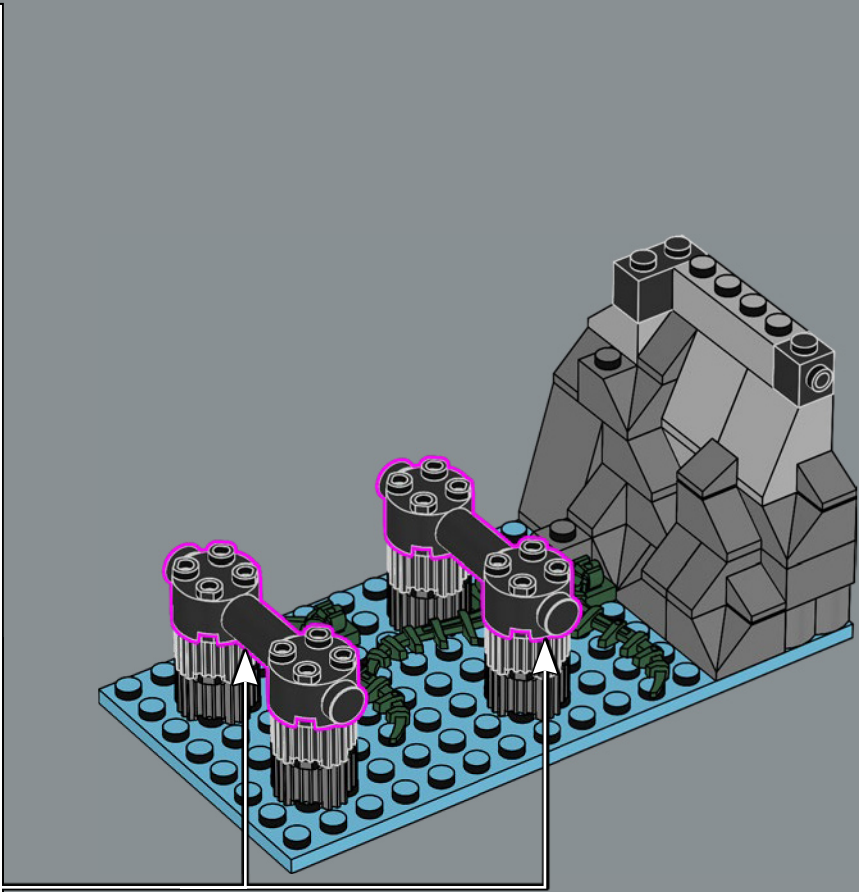
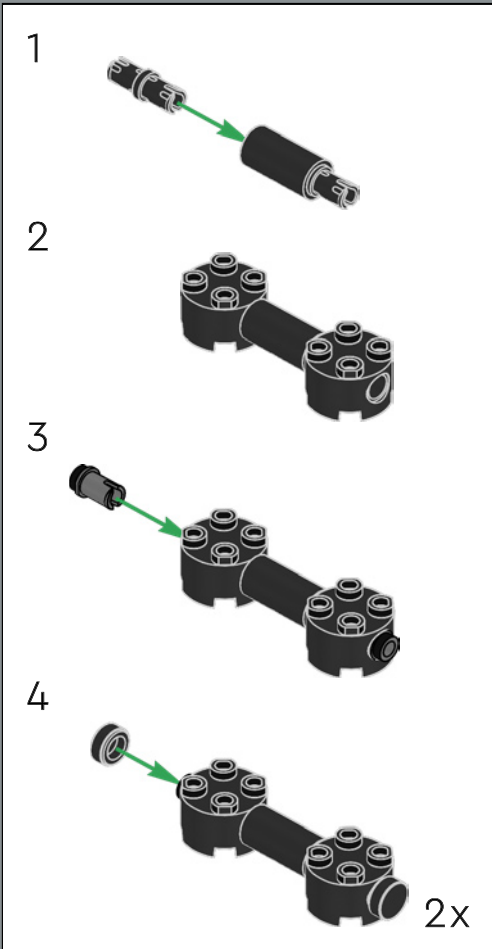

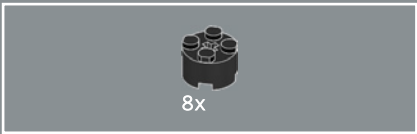

70

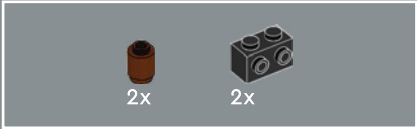
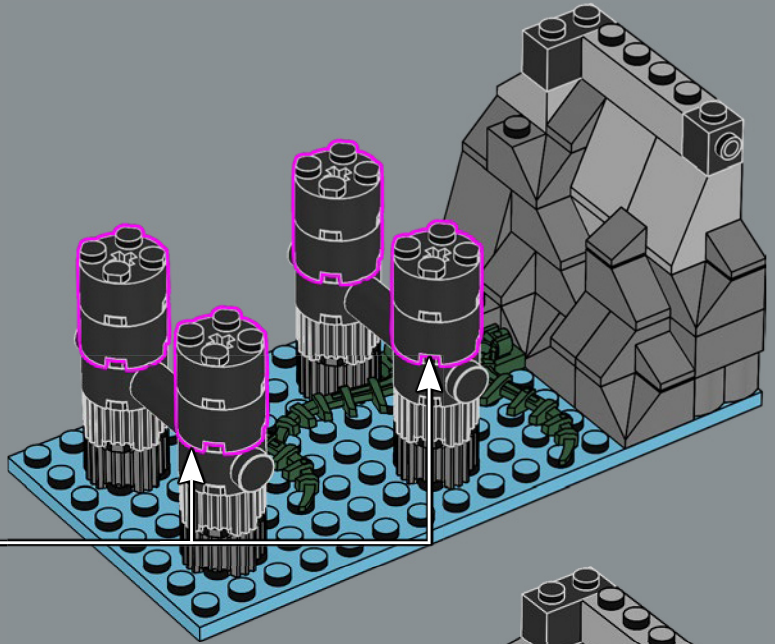
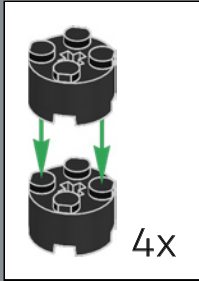

71



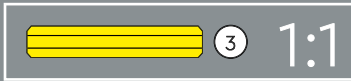
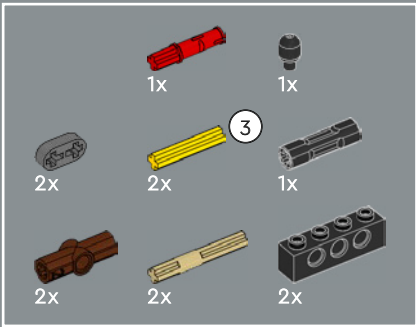

72

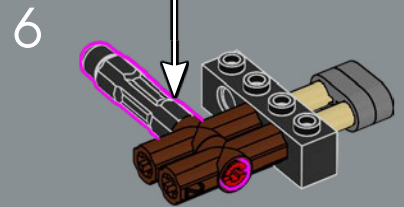
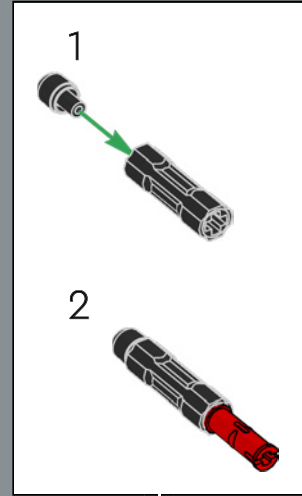
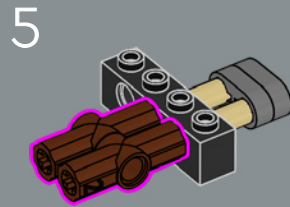
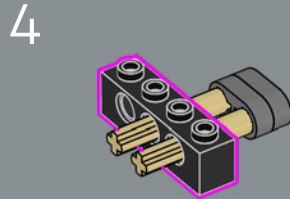
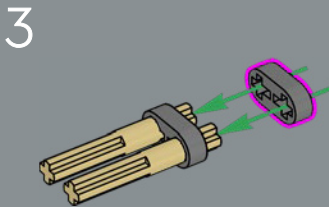
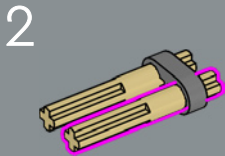
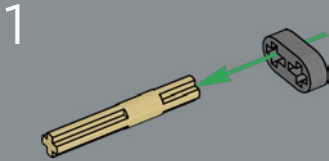

7

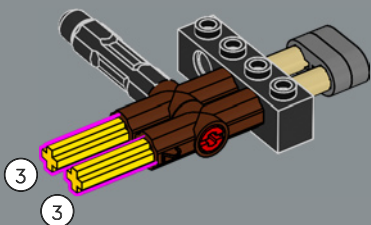

8

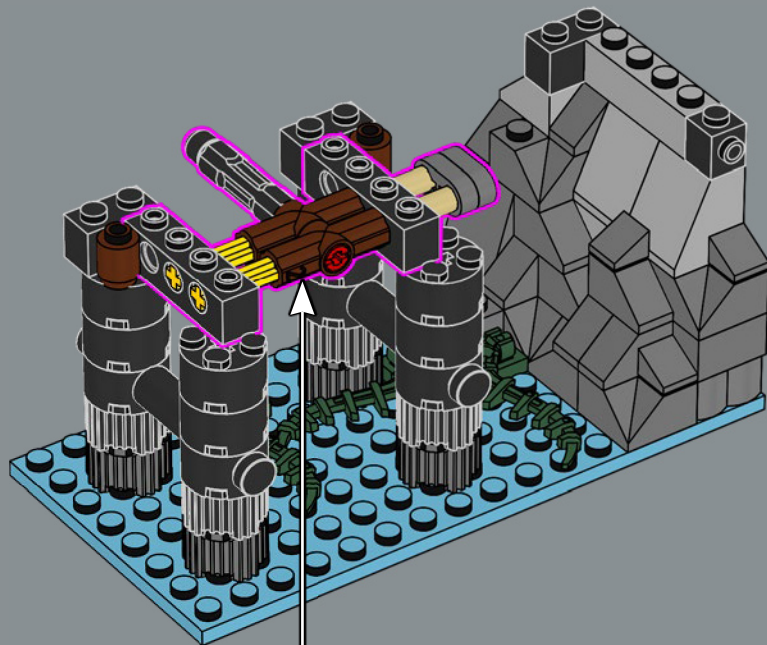
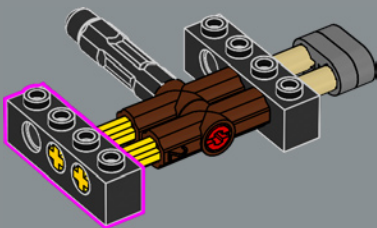



2x

73

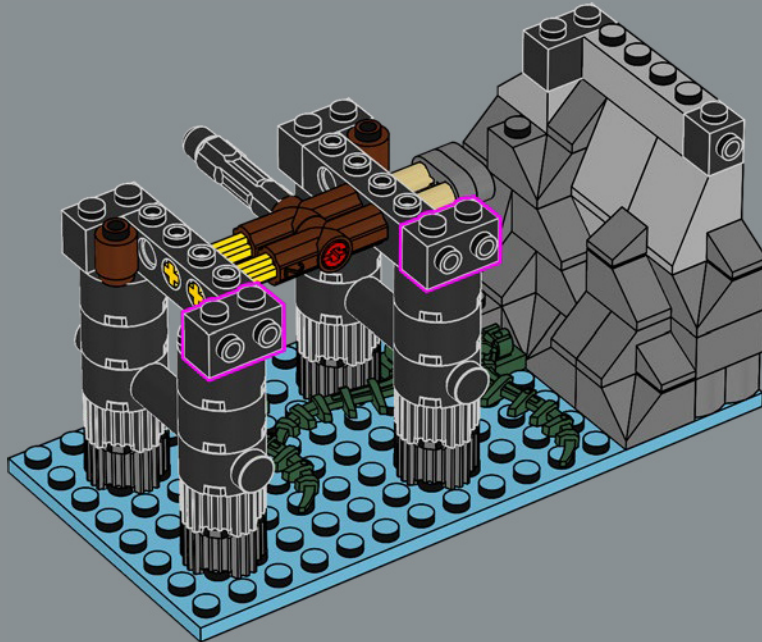



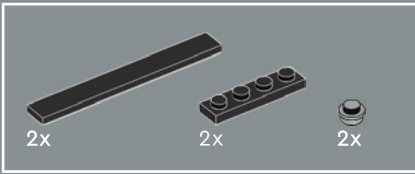

74

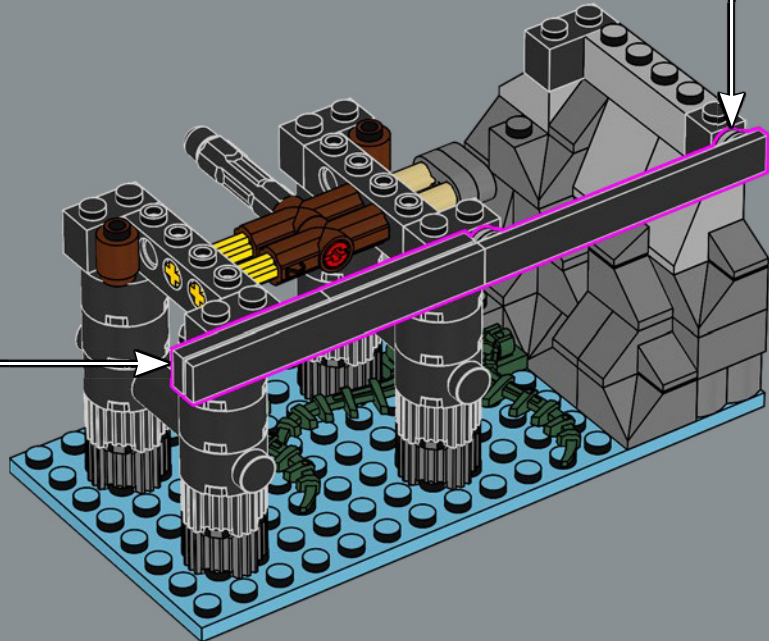
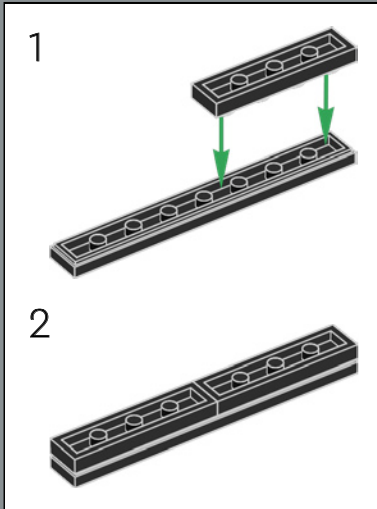
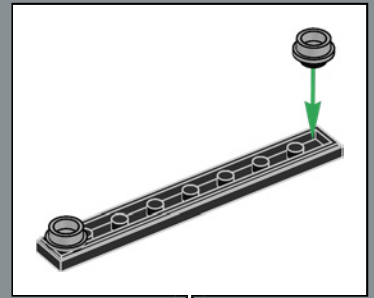

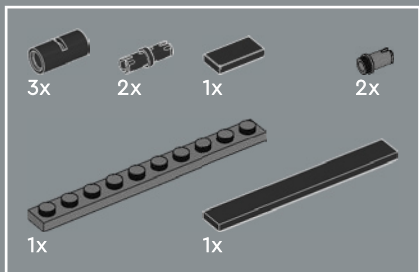

75

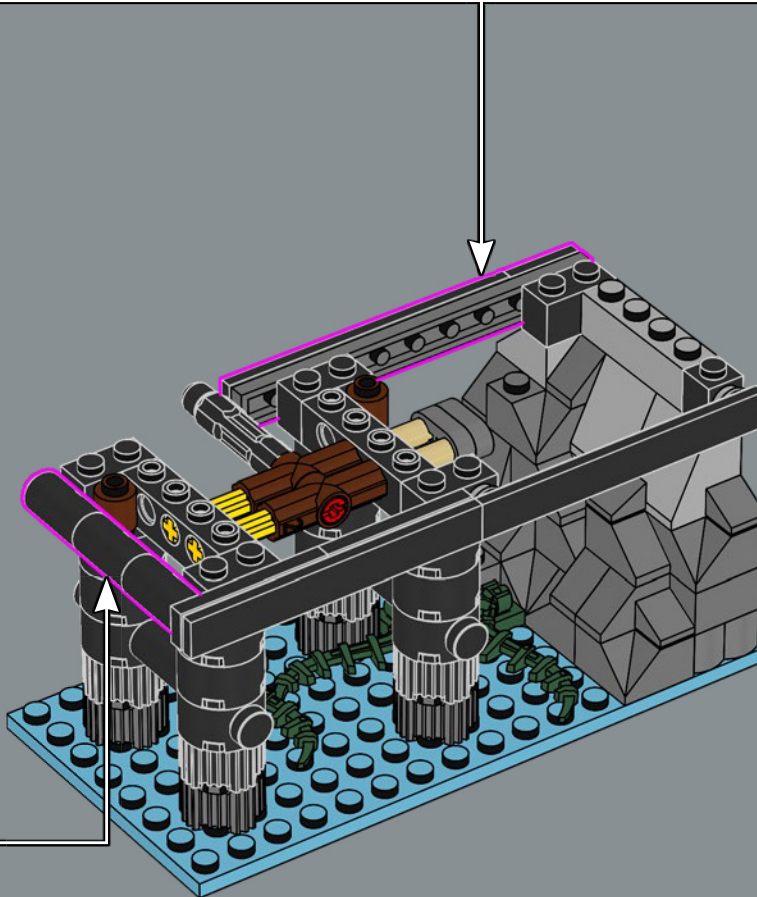
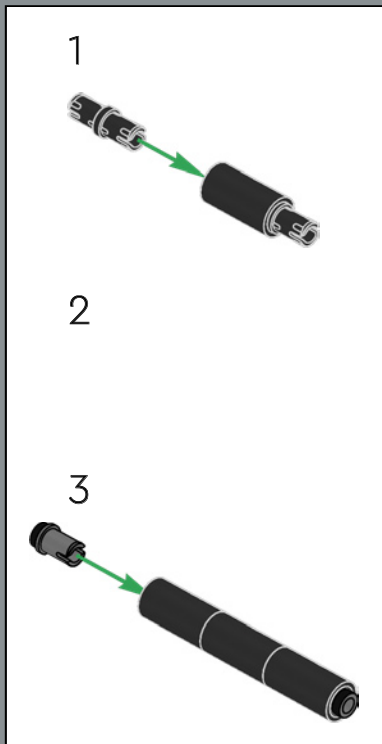
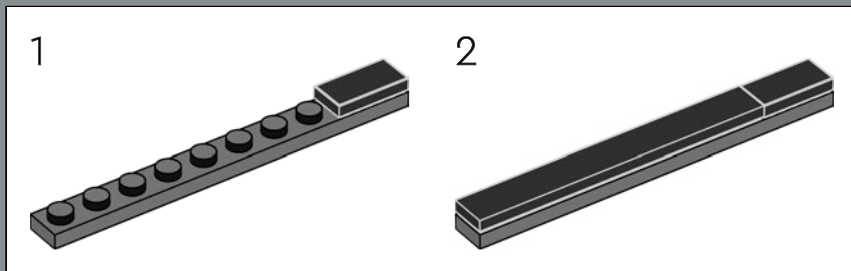

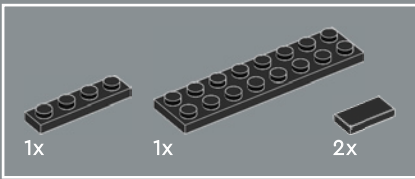

76

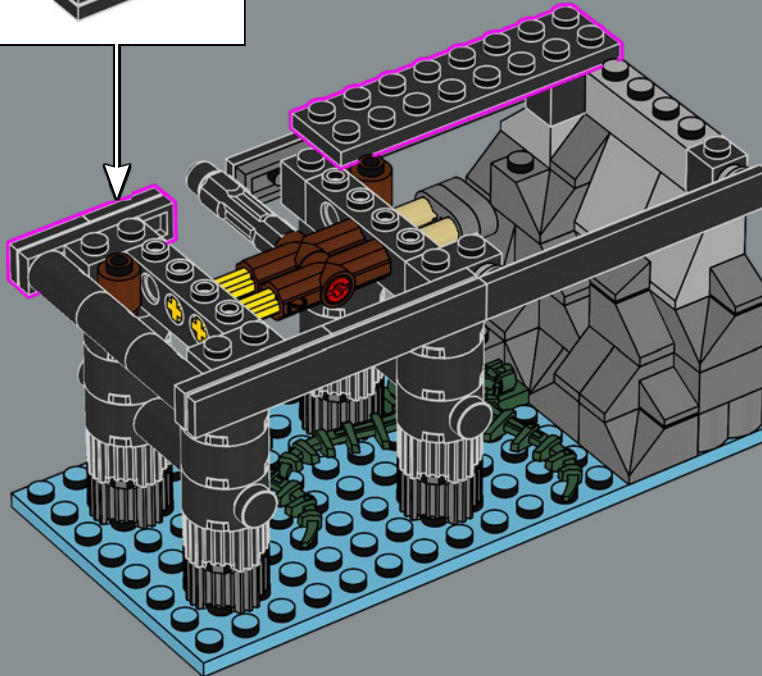
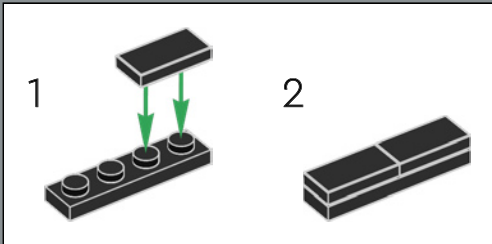

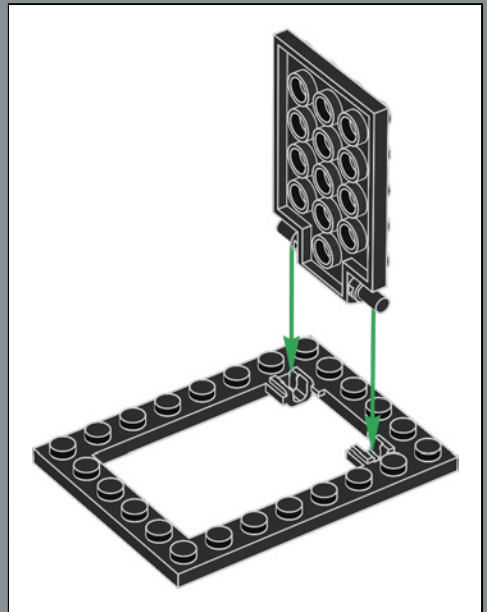
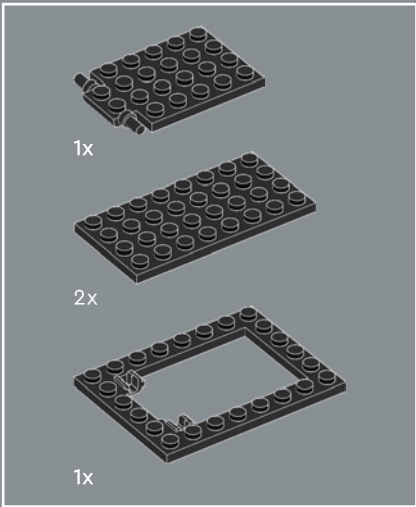

77

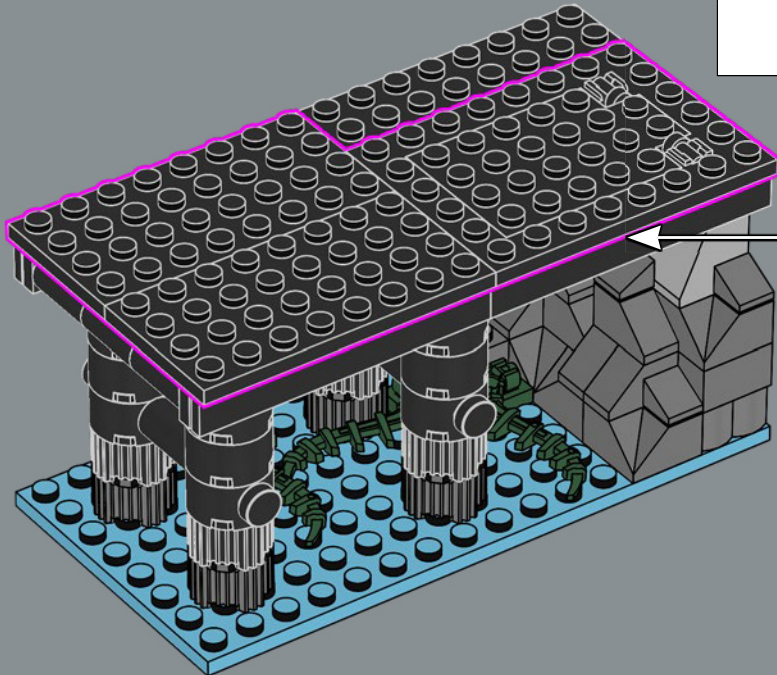

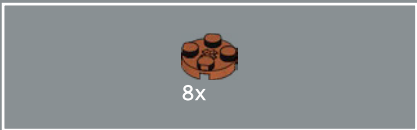

78

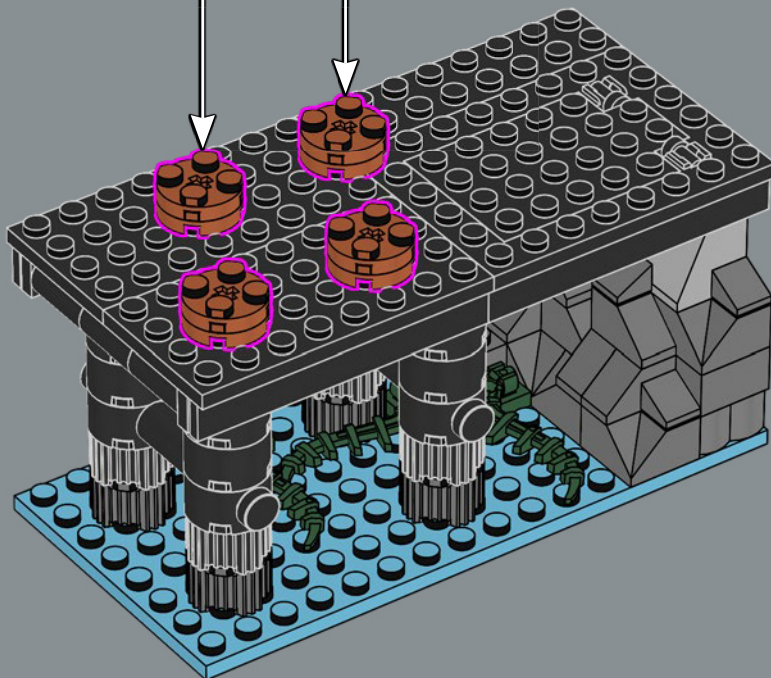
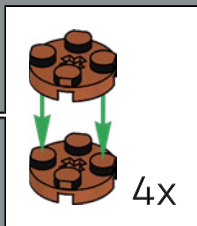

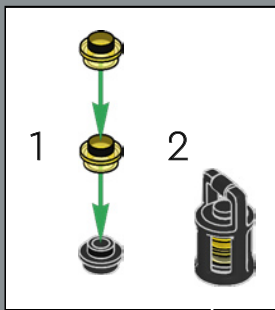

79

1

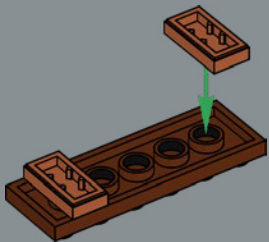

2

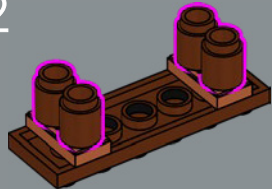

3

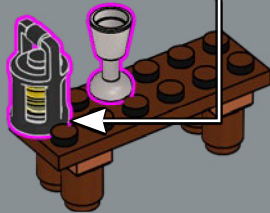

4



5

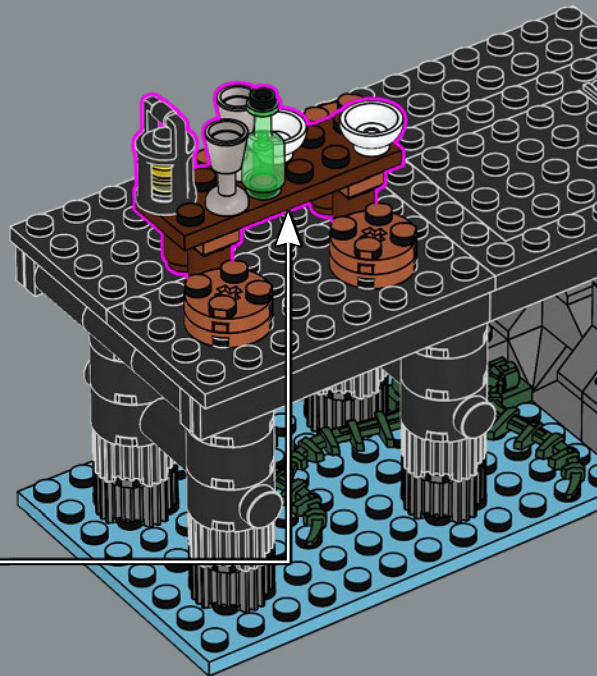



Si tienes el set LEGO® Ideas Piratas de Bahía Barracuda (21322), puedes atracarlo en el muelle.



