



**STAR
WAR**



9525



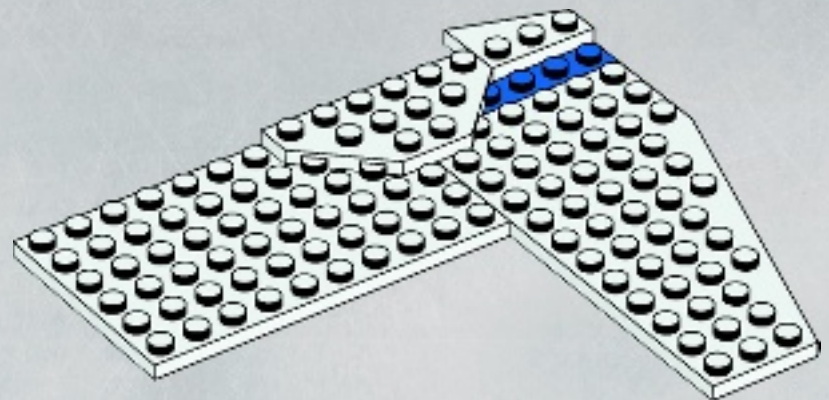
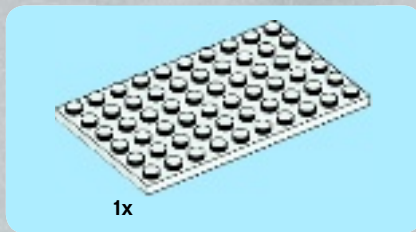
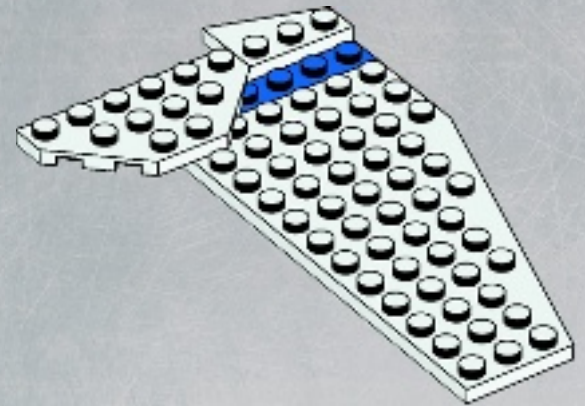
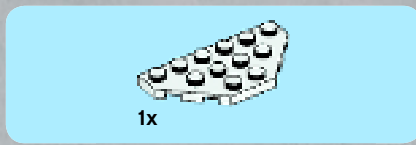
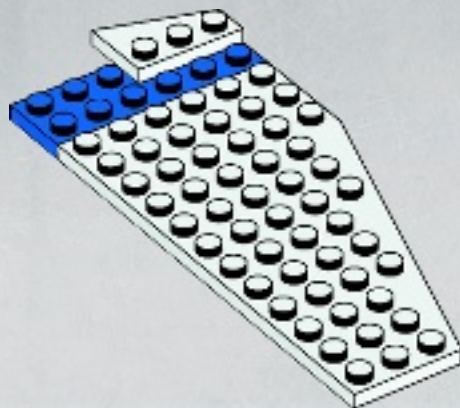
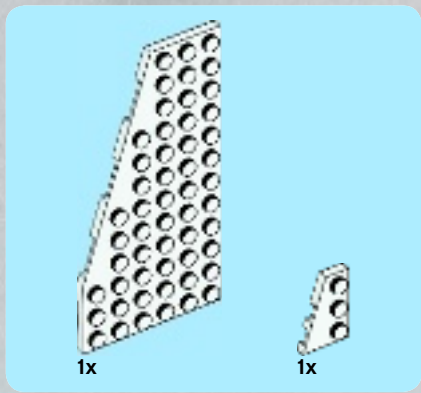
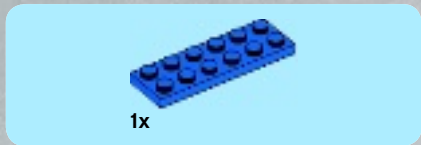
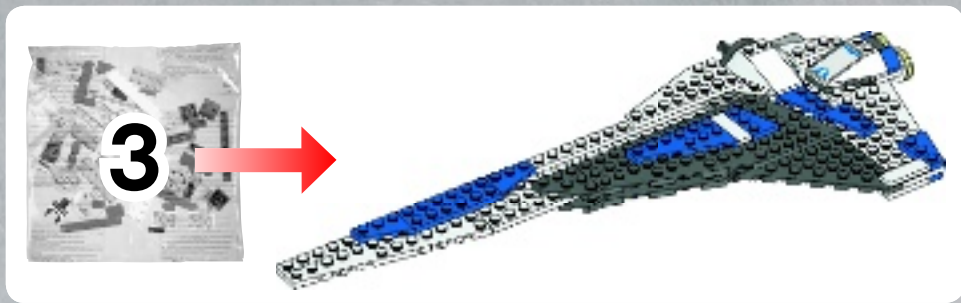

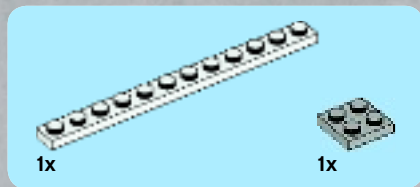

5

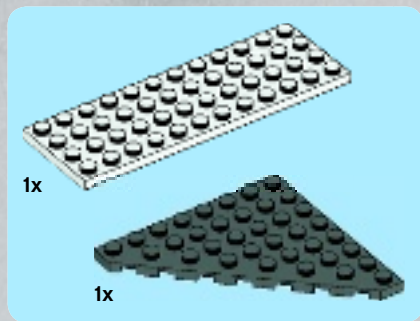
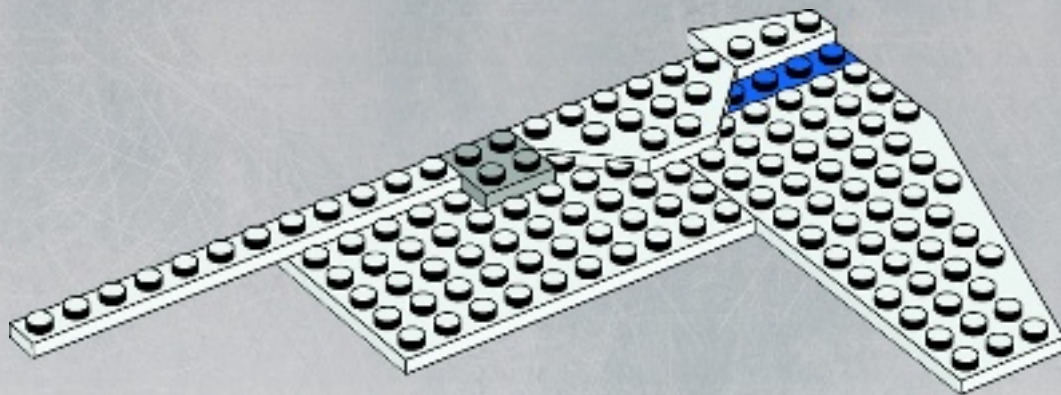

6

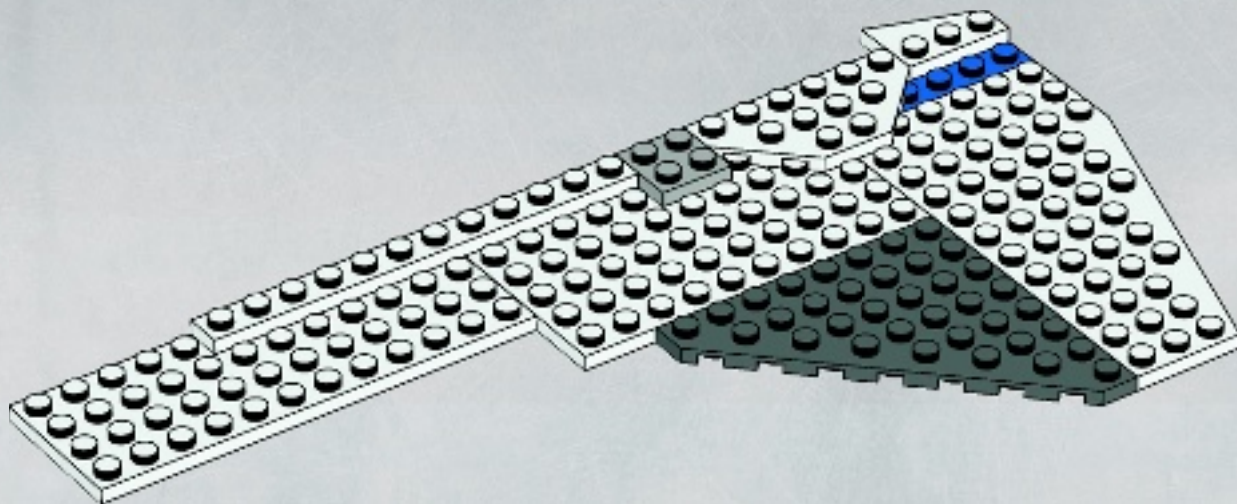

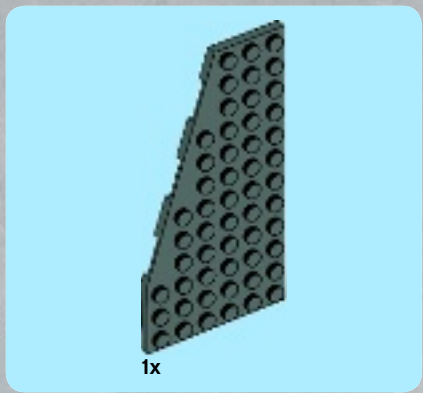

7

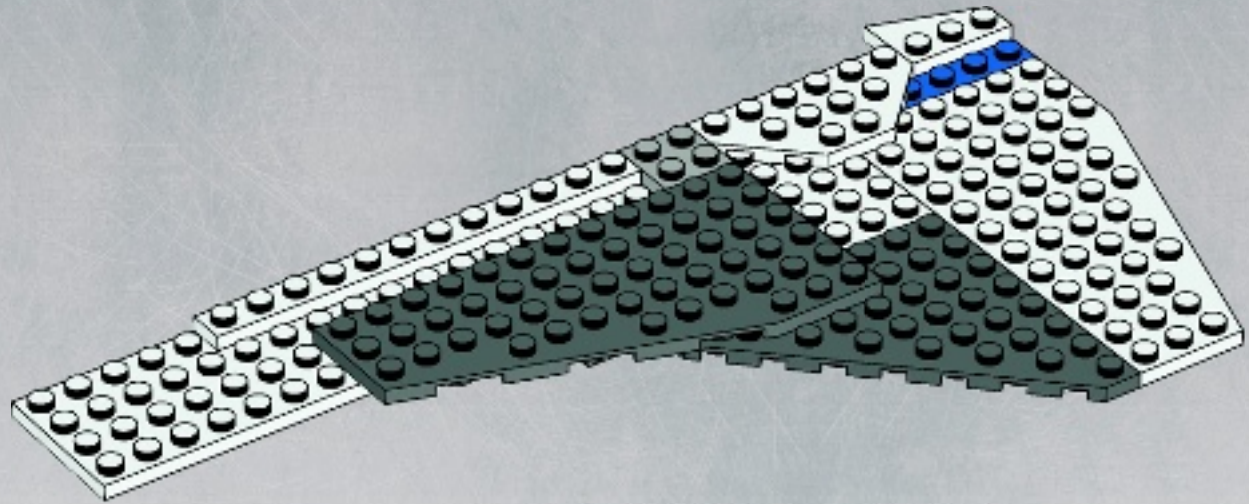

8

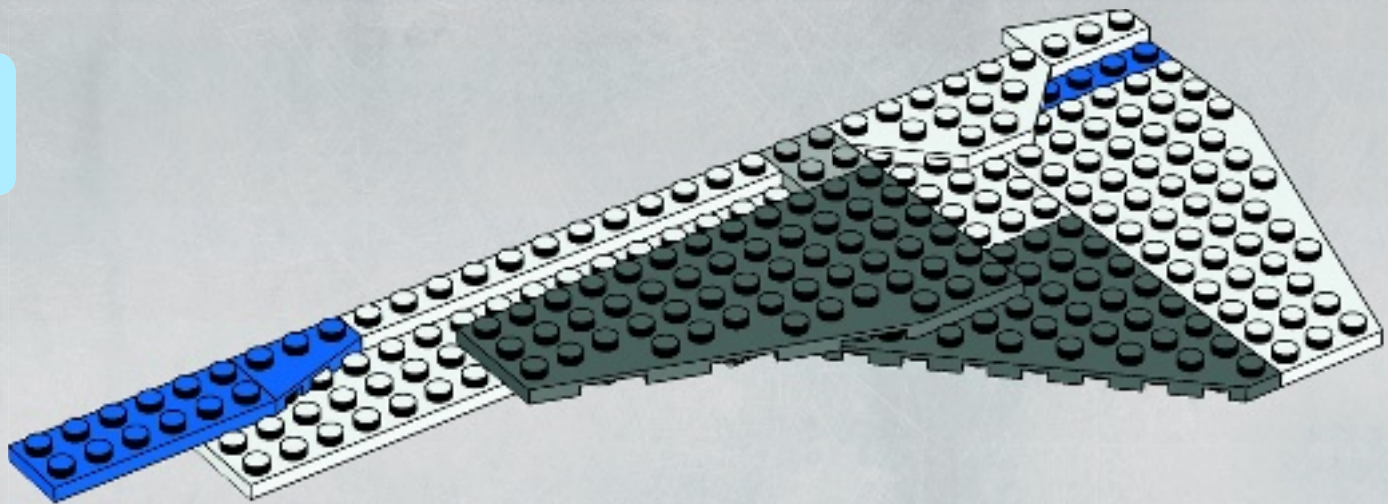

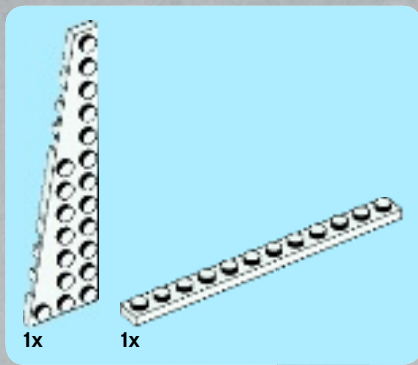

9

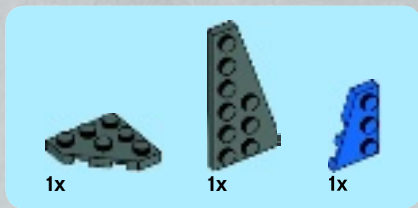
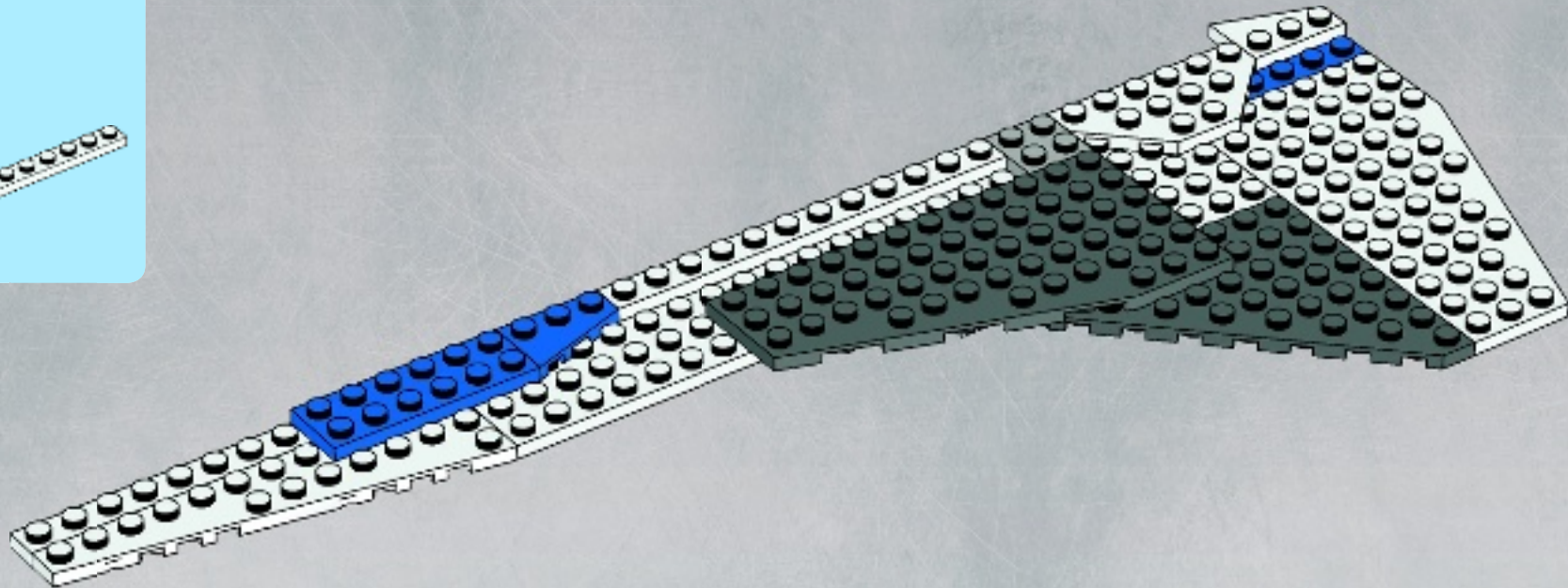

10

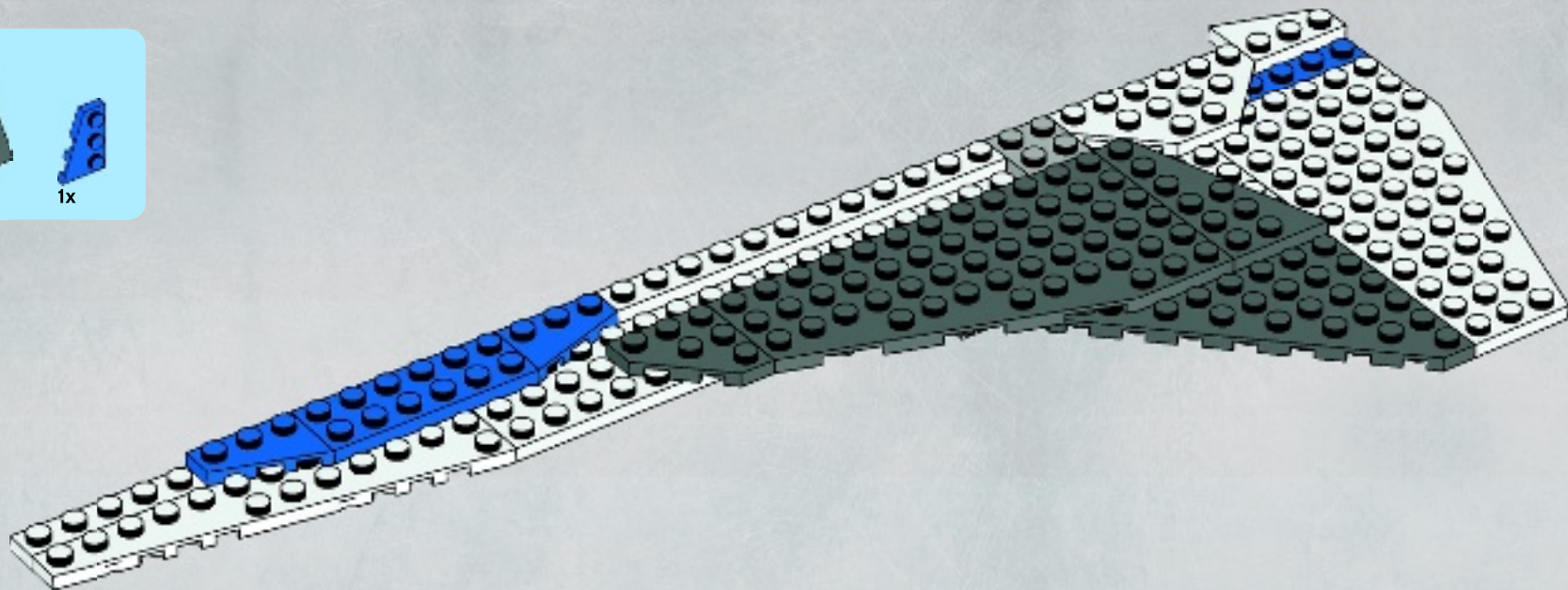

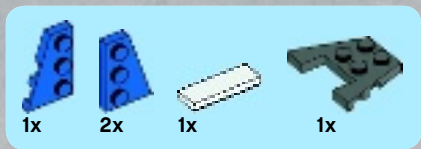

11

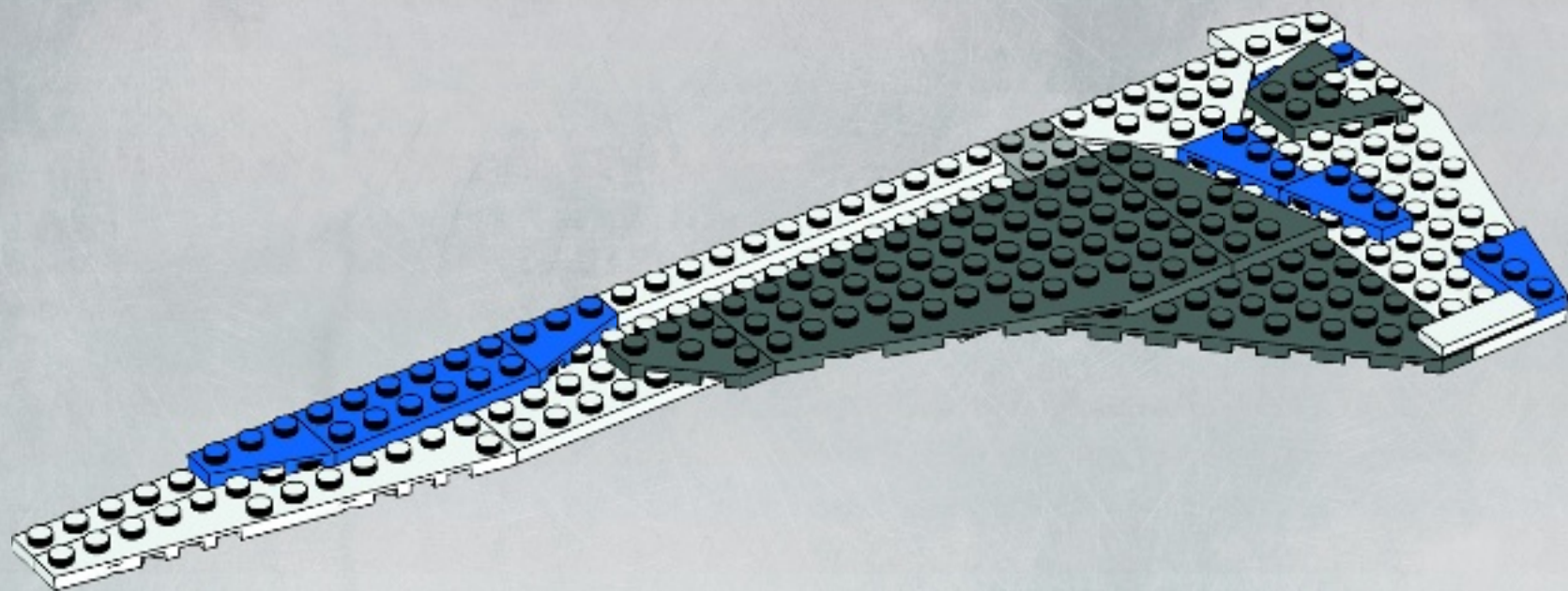

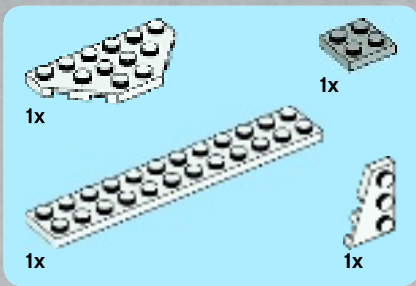

12

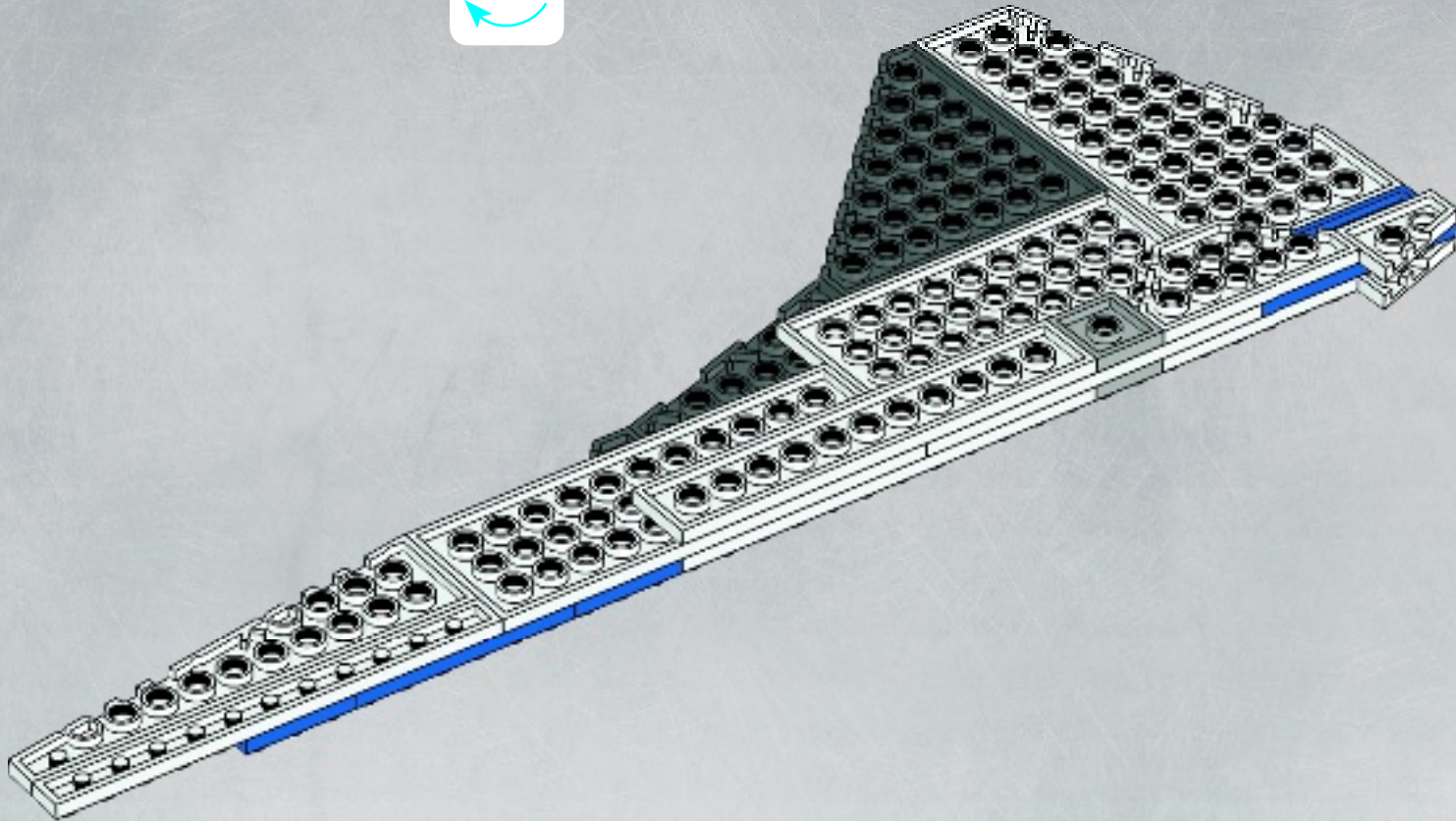

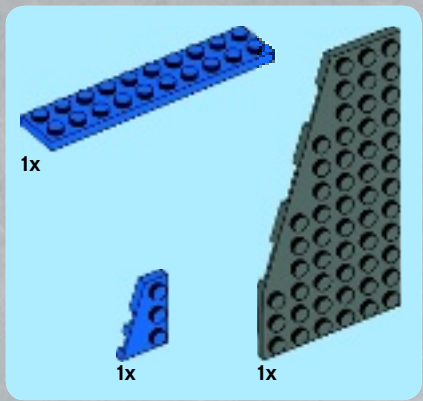

13

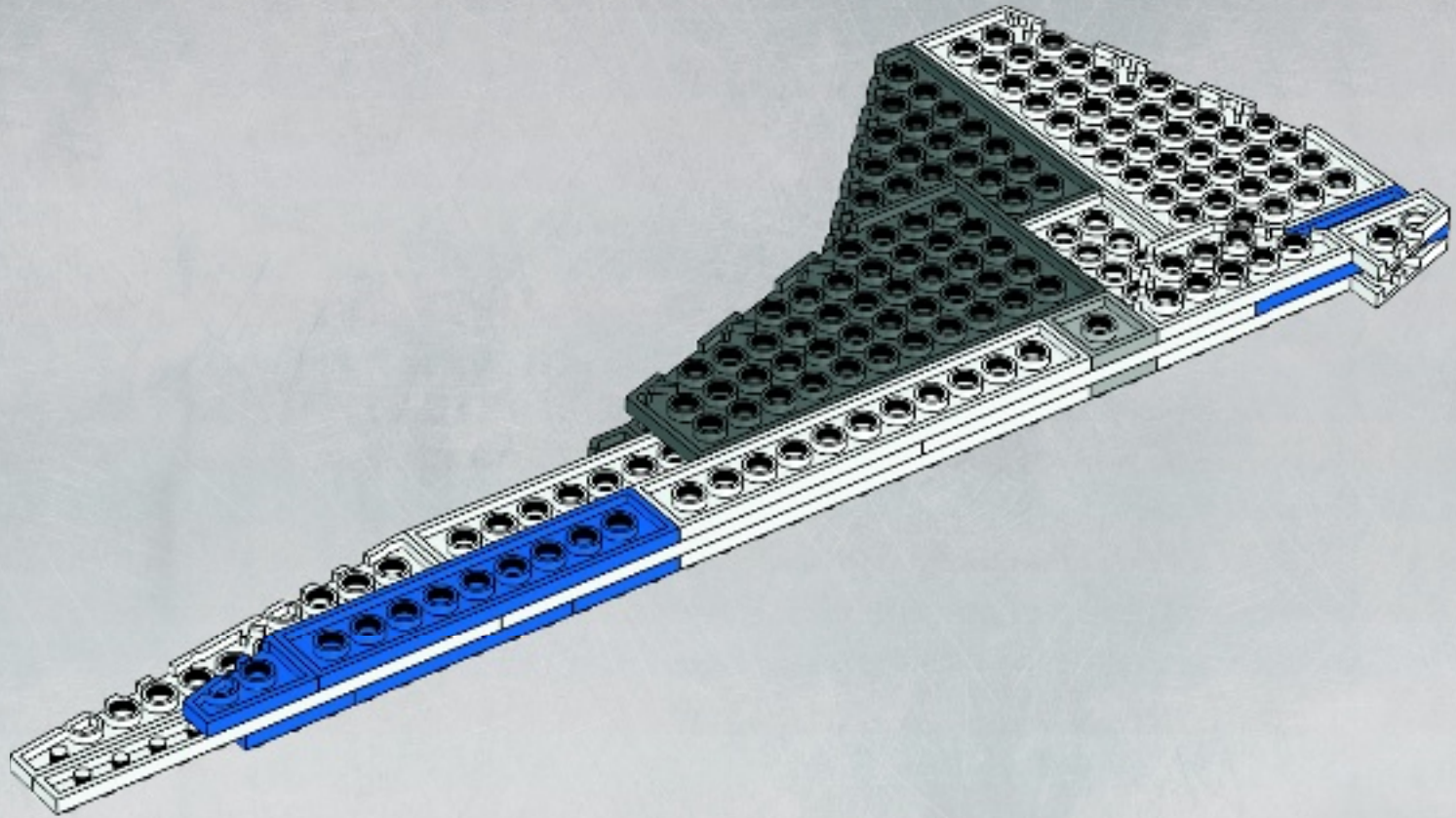

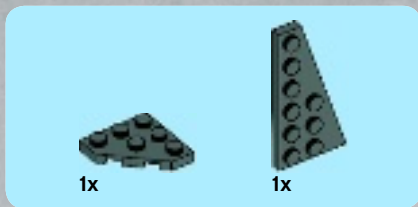

14

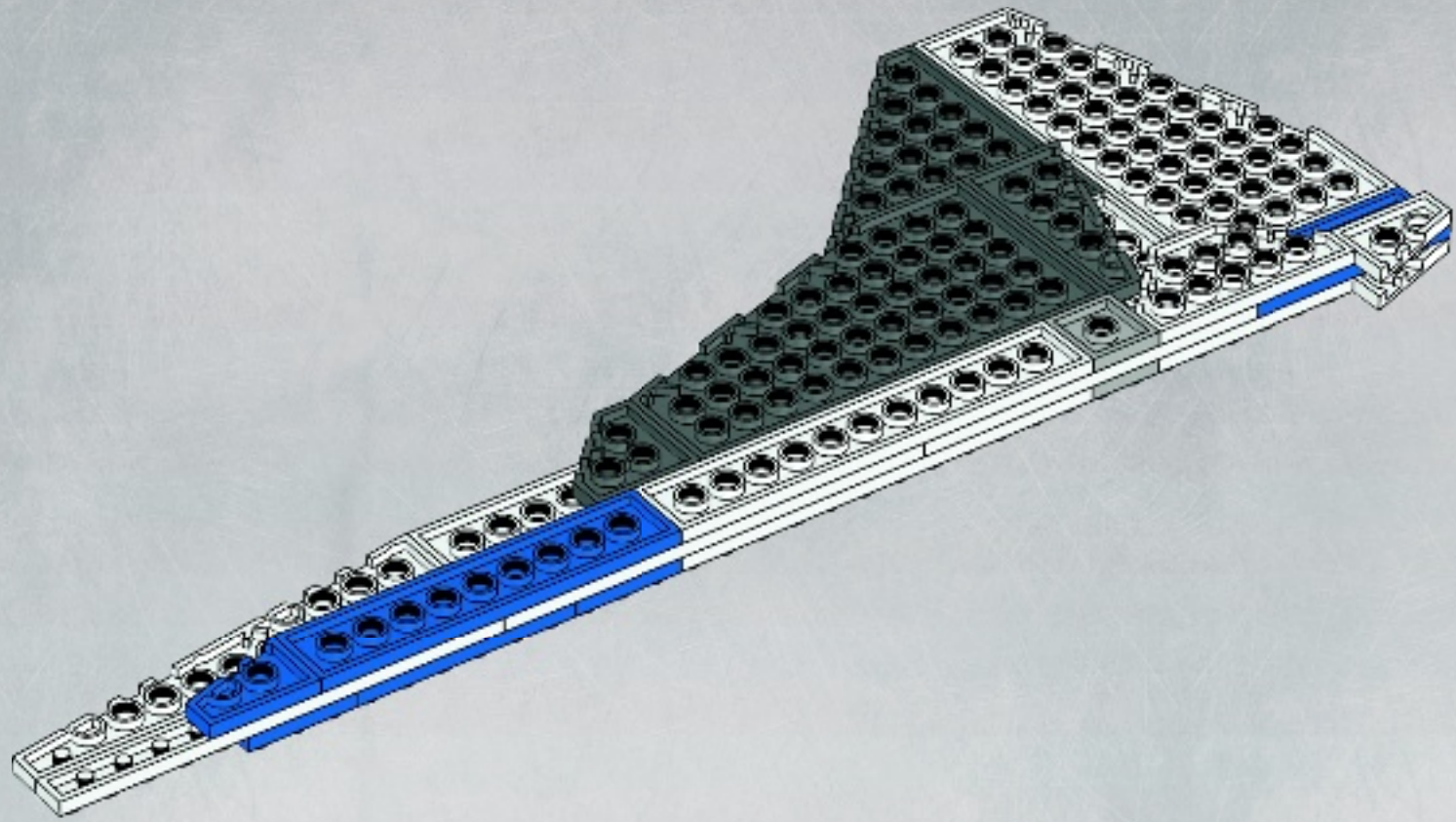



15

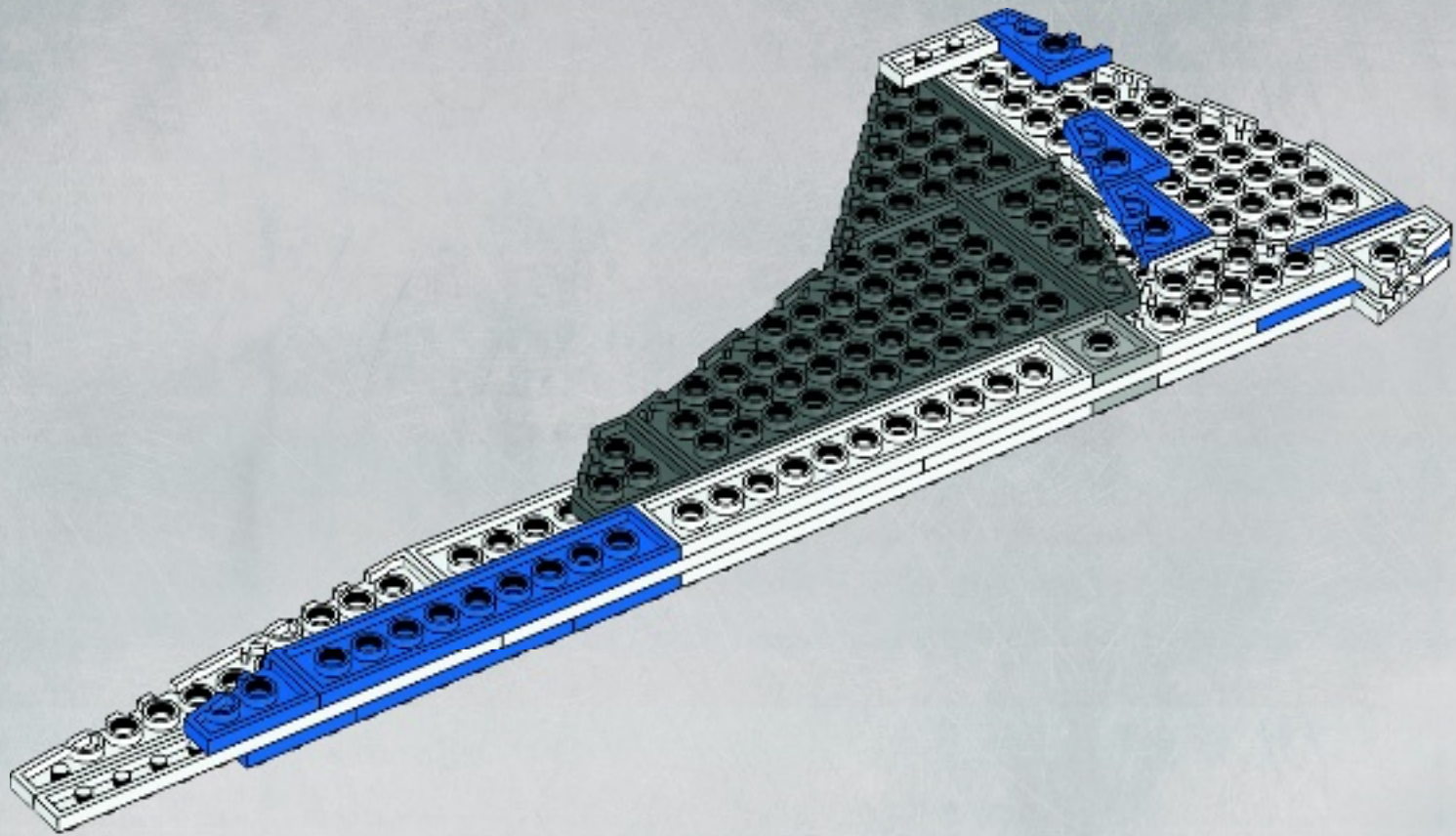



16

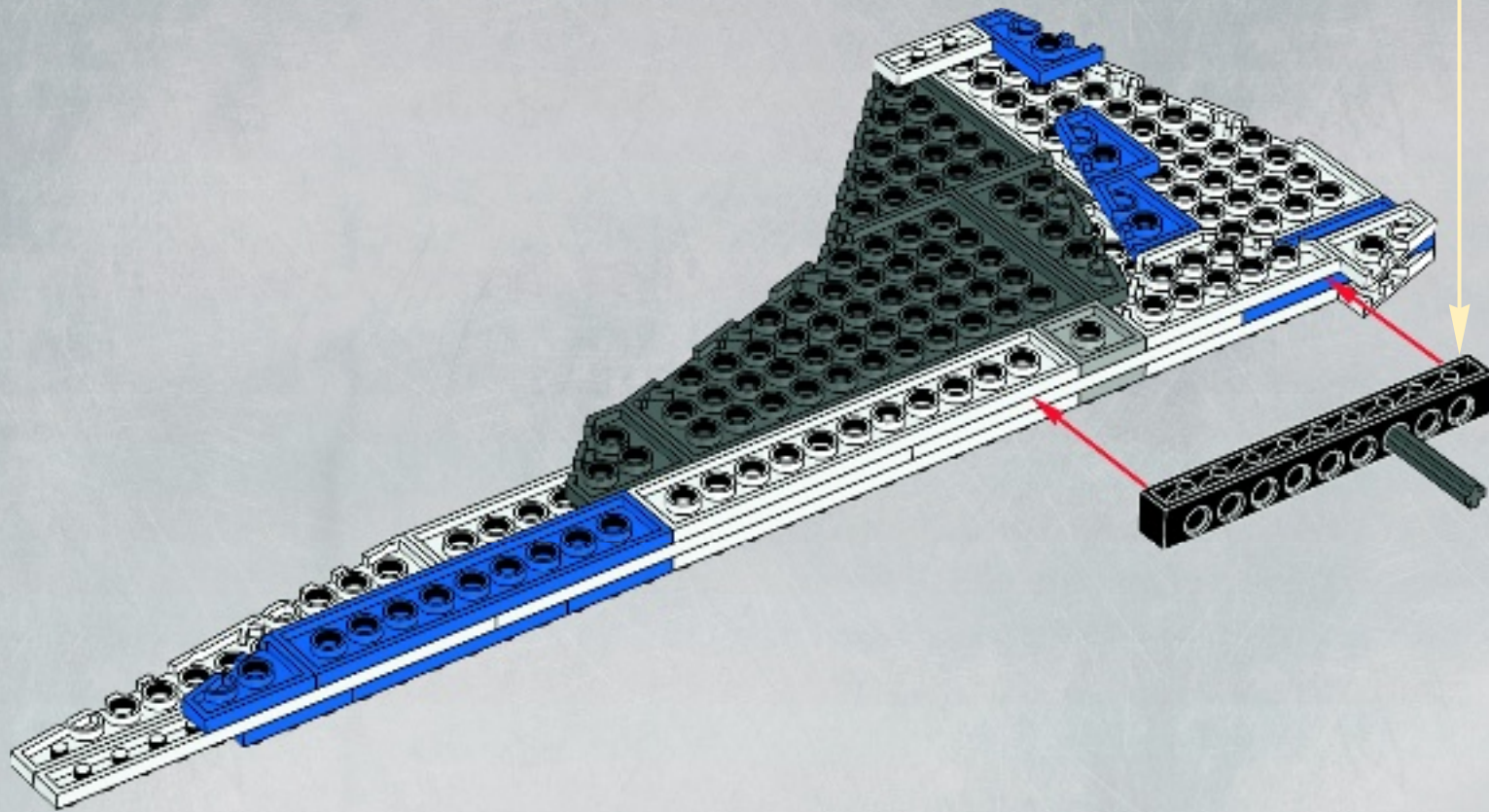
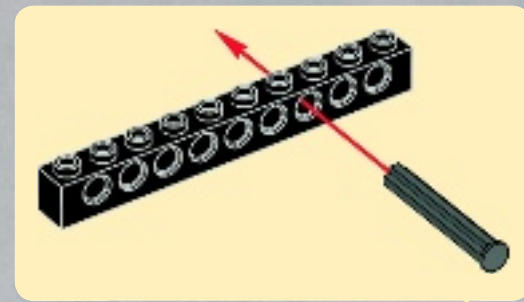



1x



1x

17

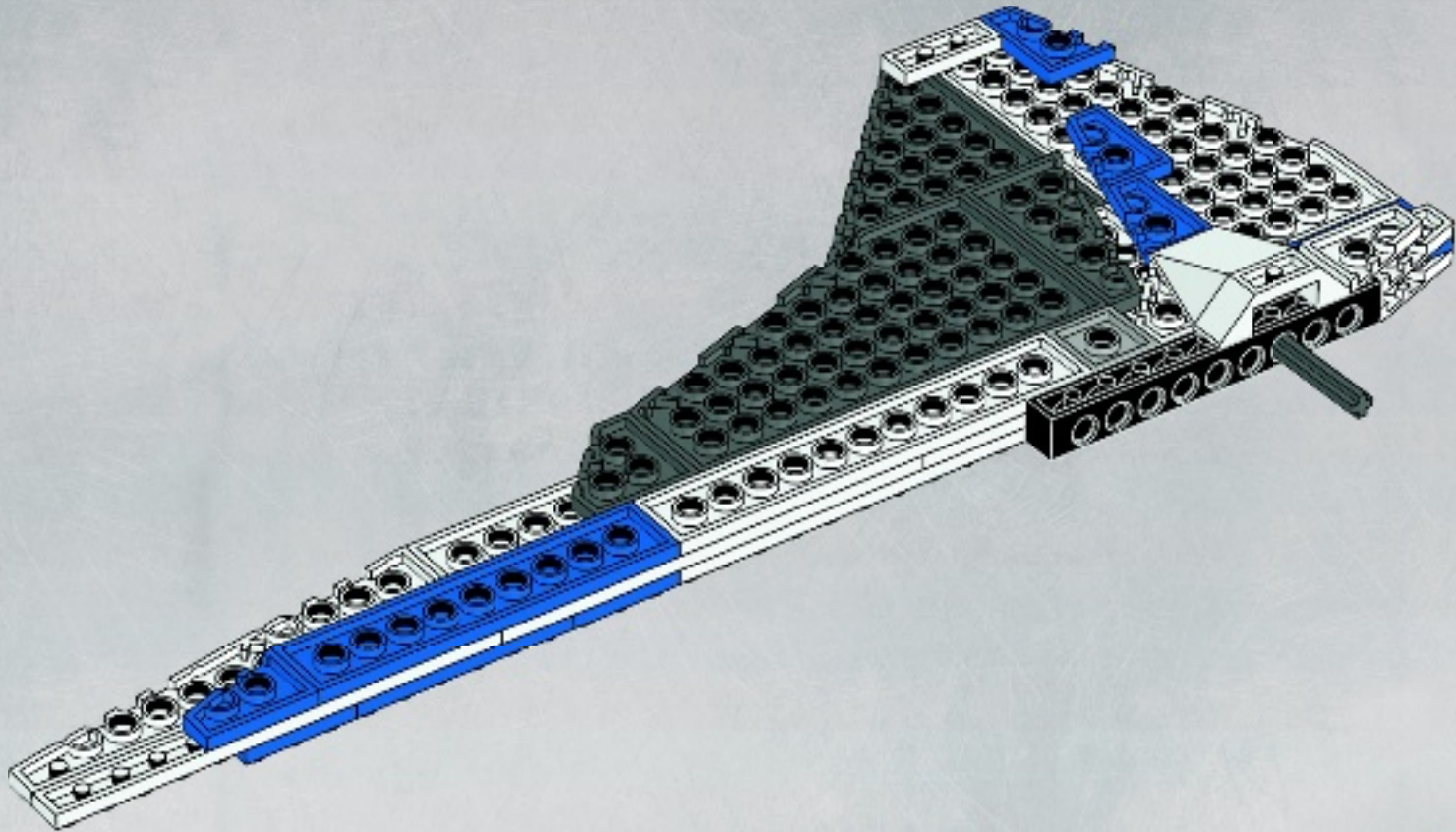

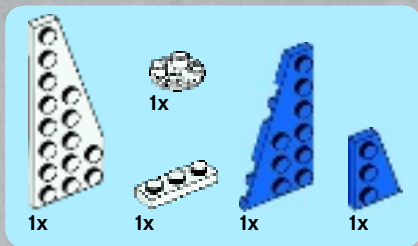

18

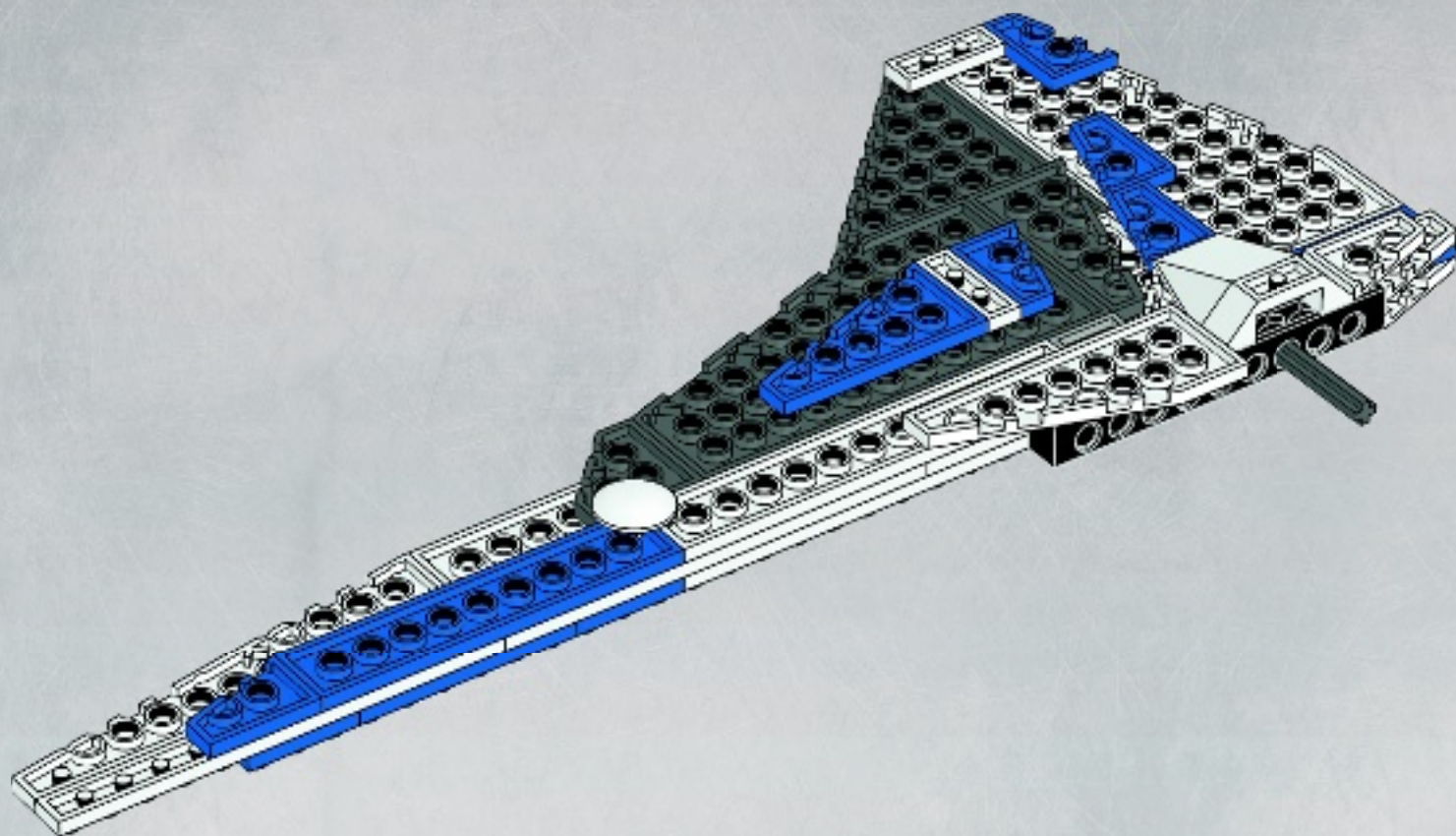



19

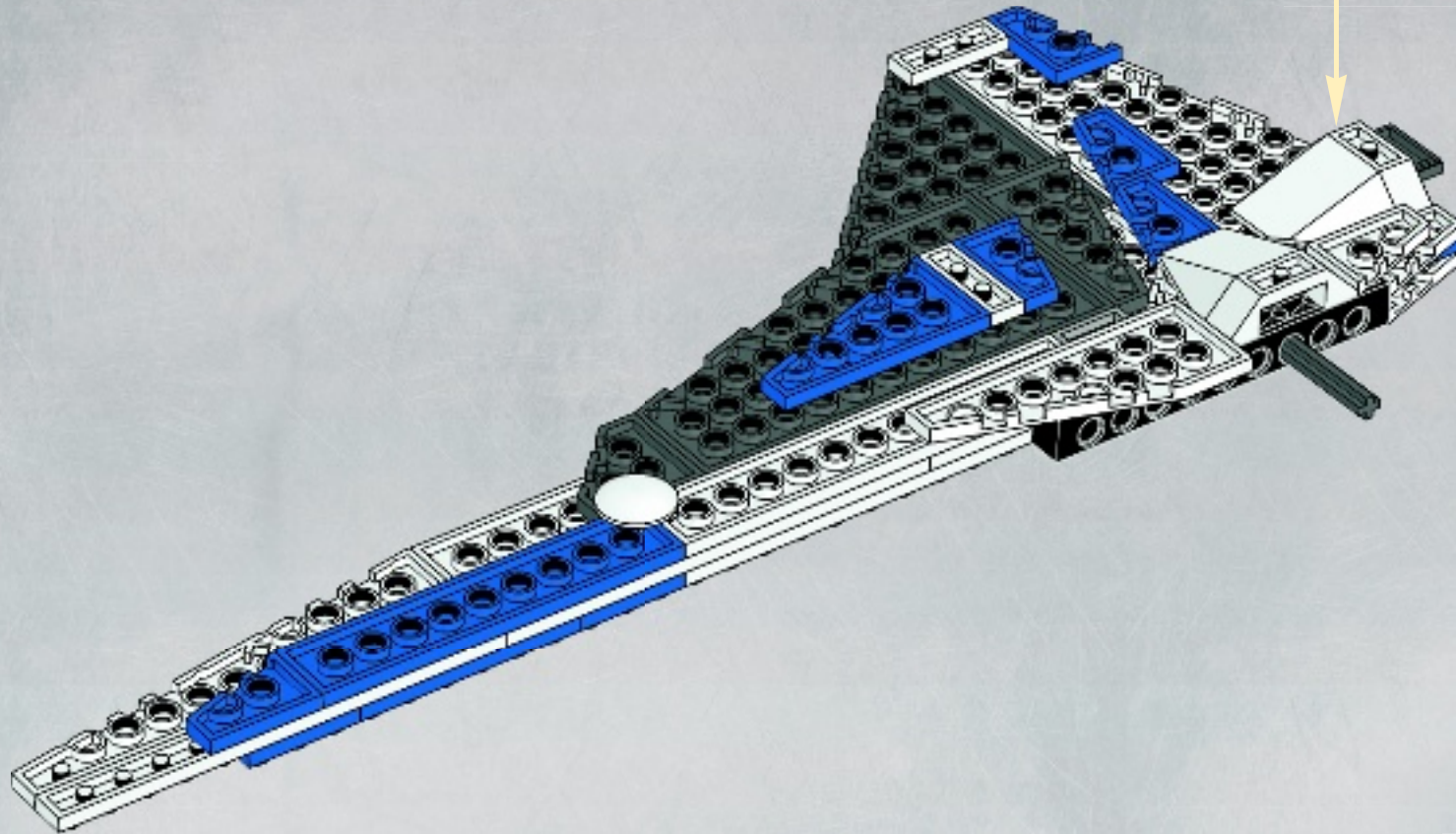
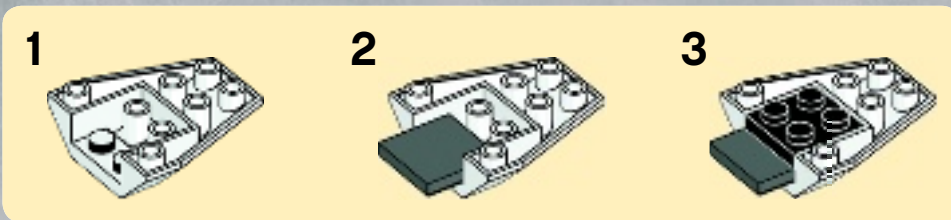

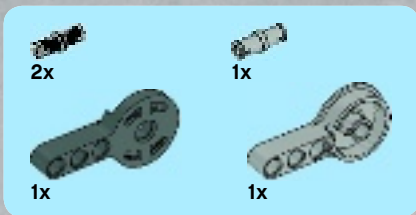

20

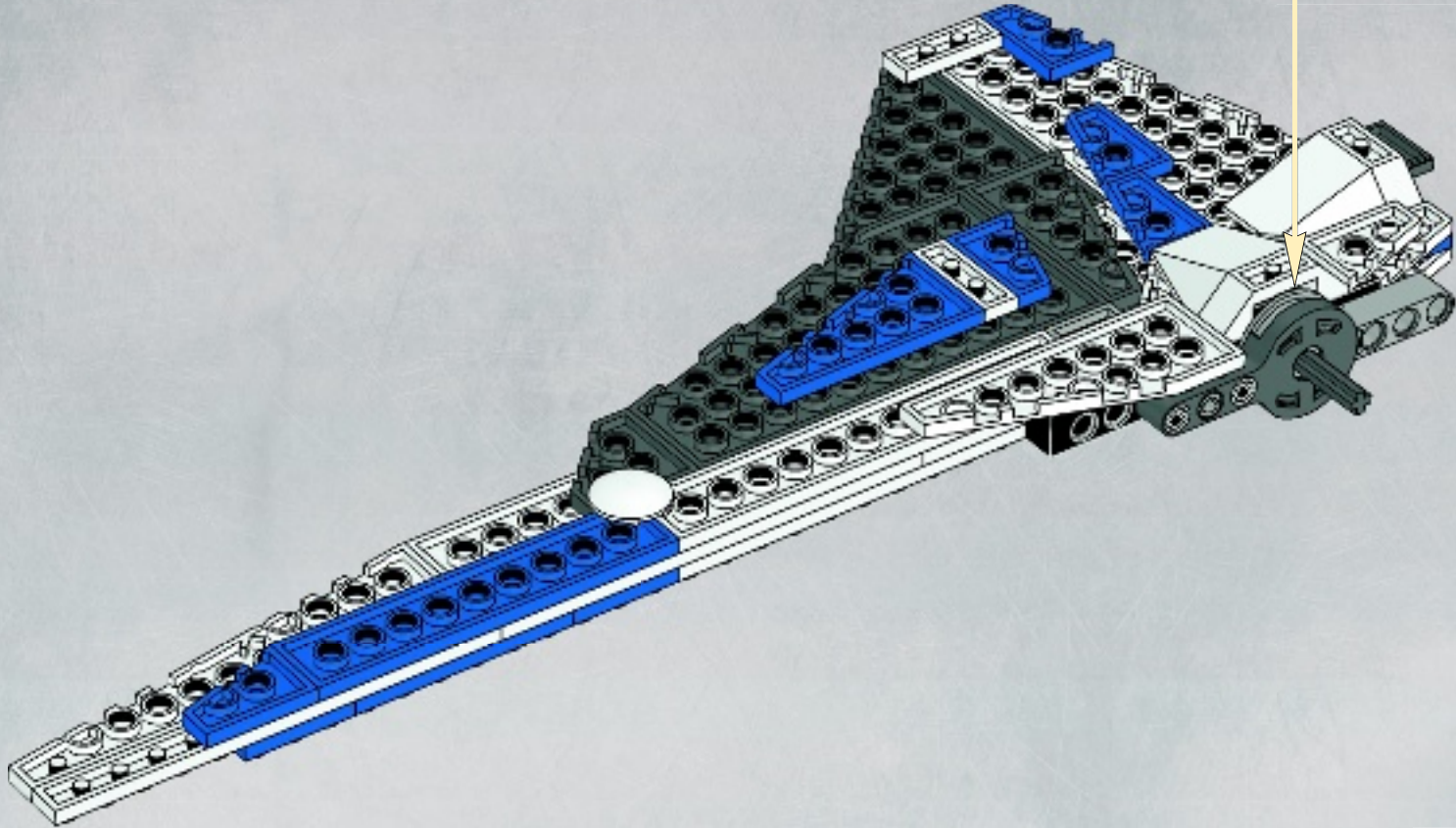
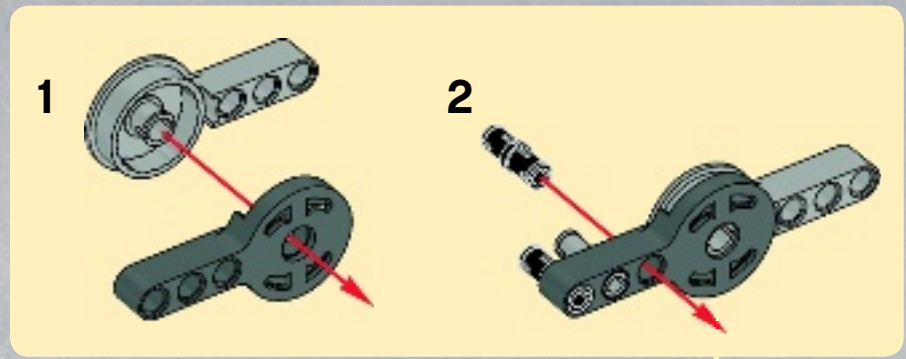

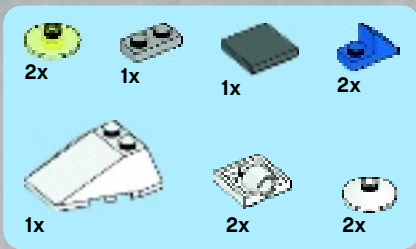

23

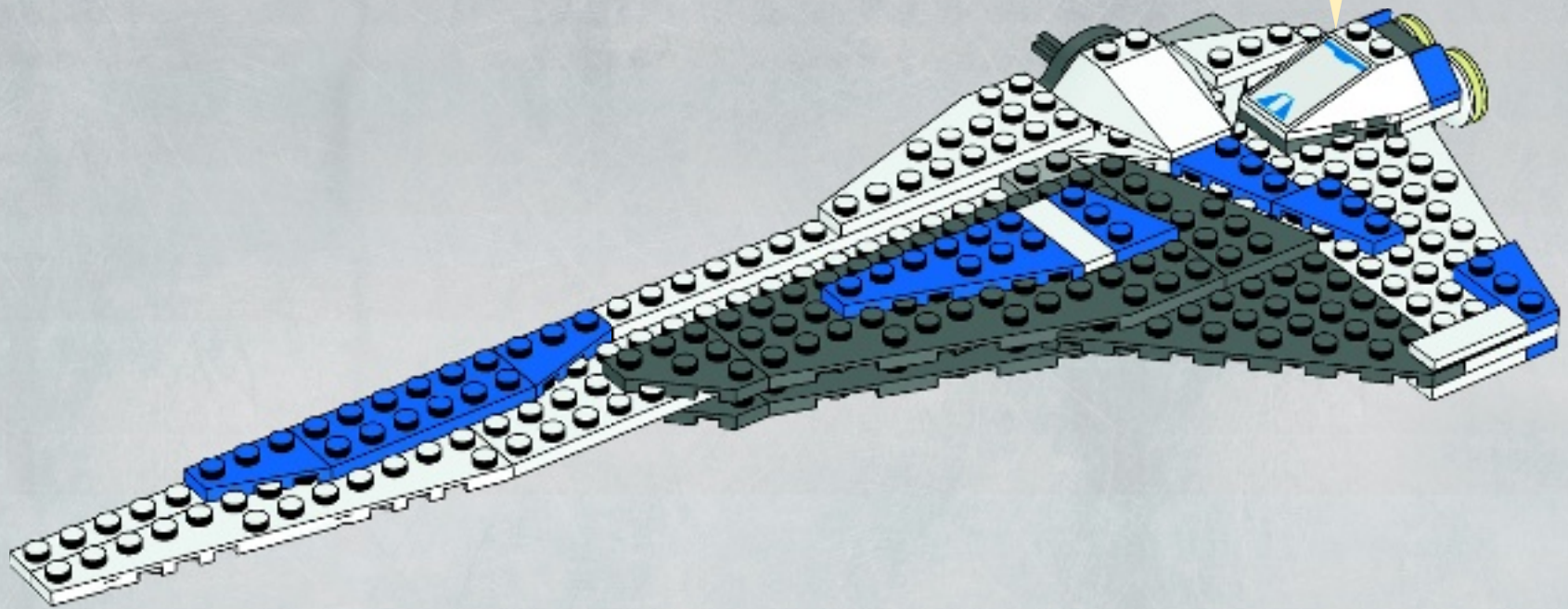
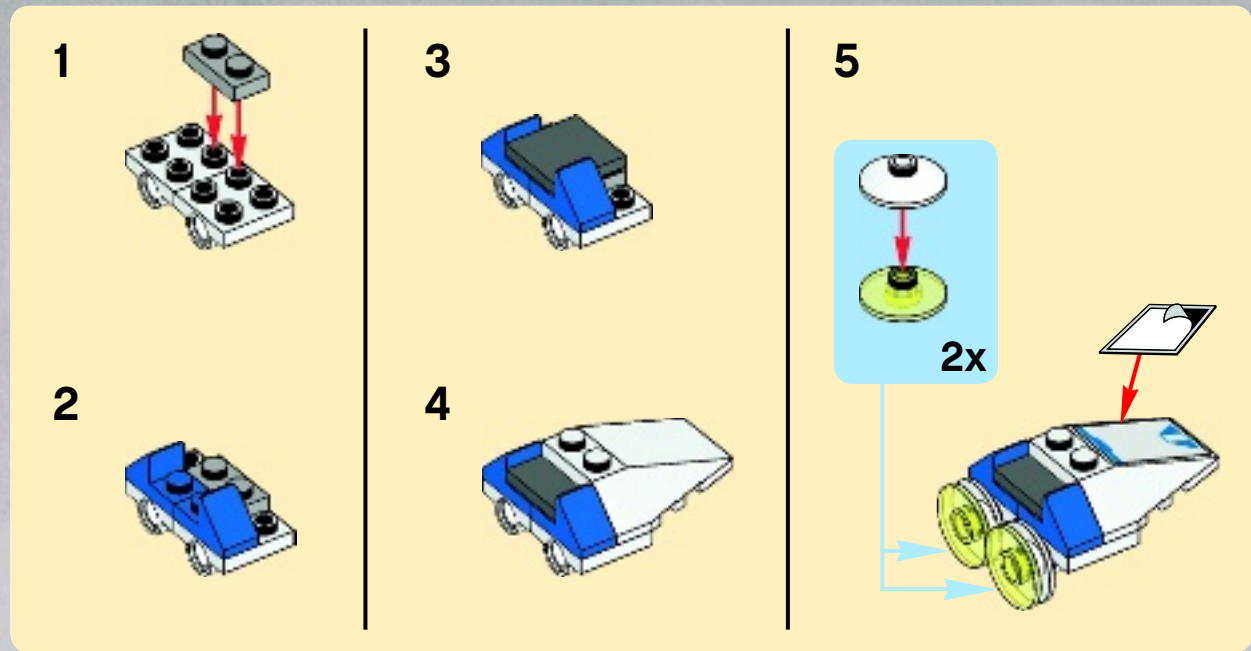

43

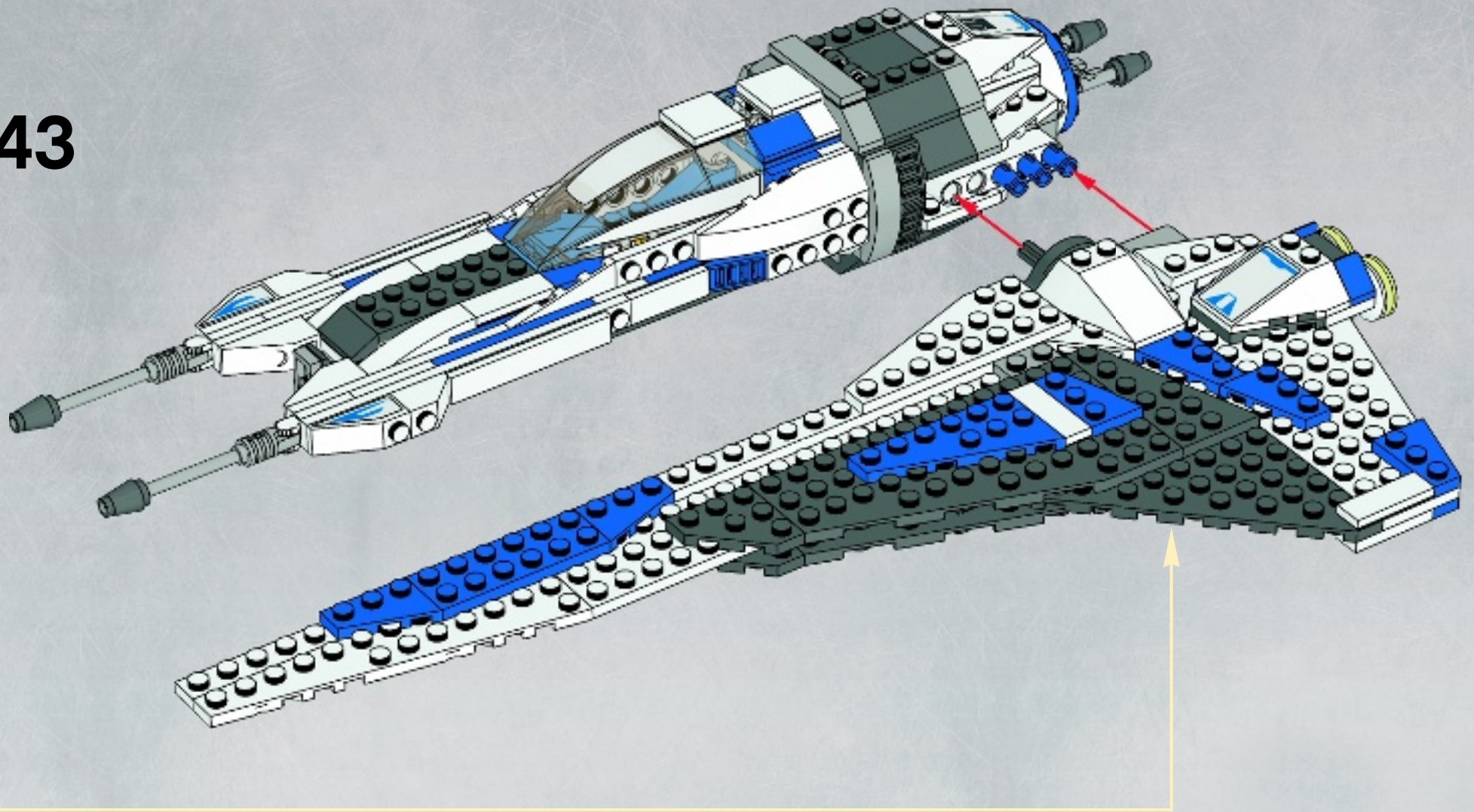

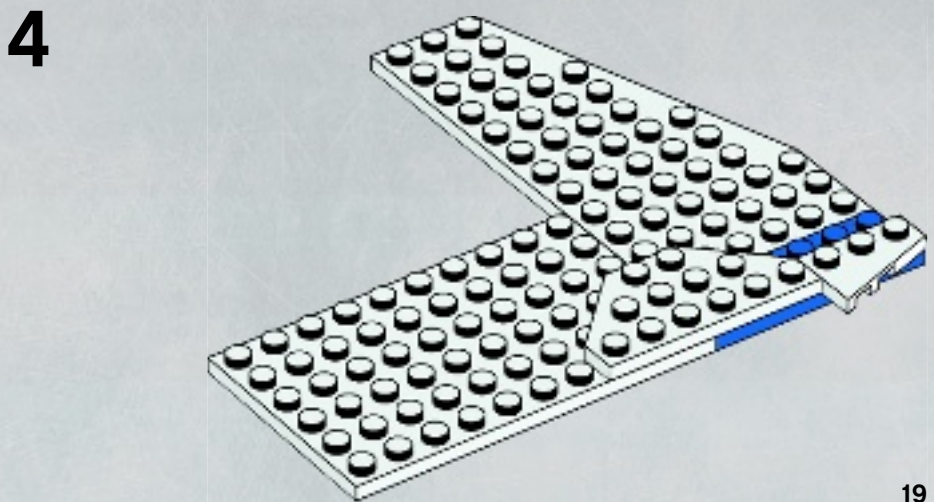
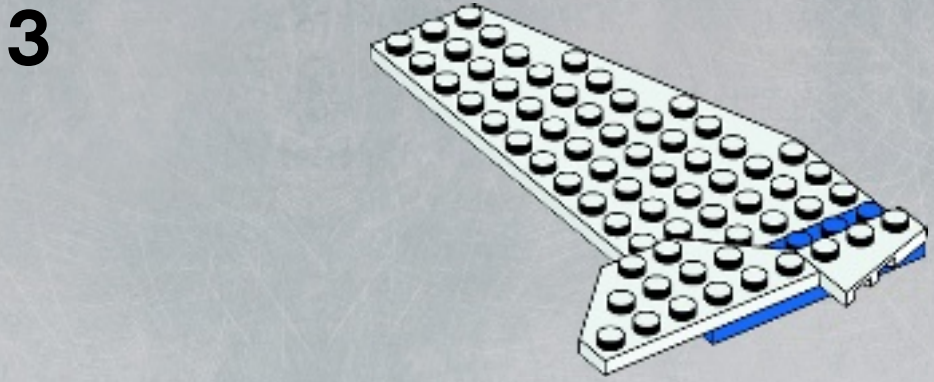
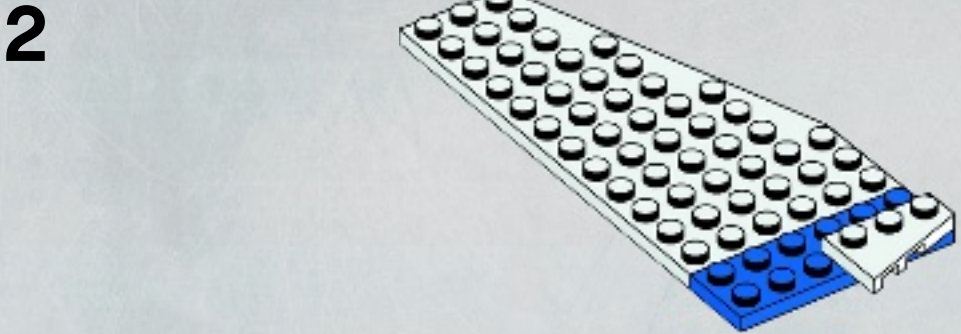
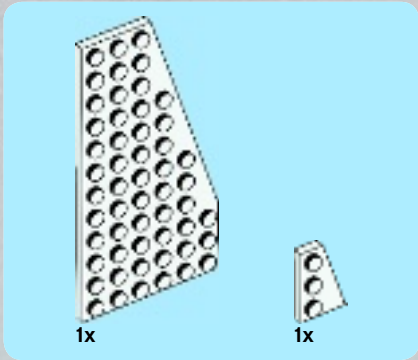
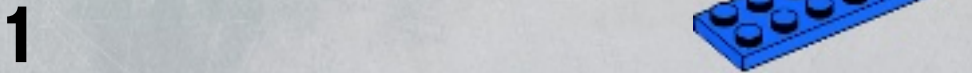
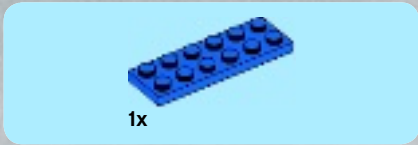
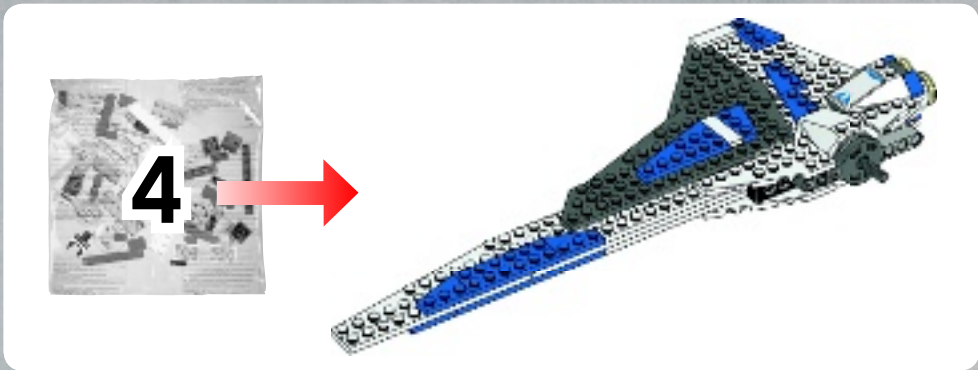

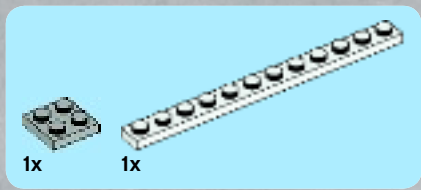

5

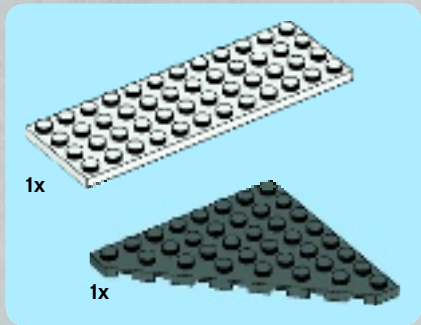
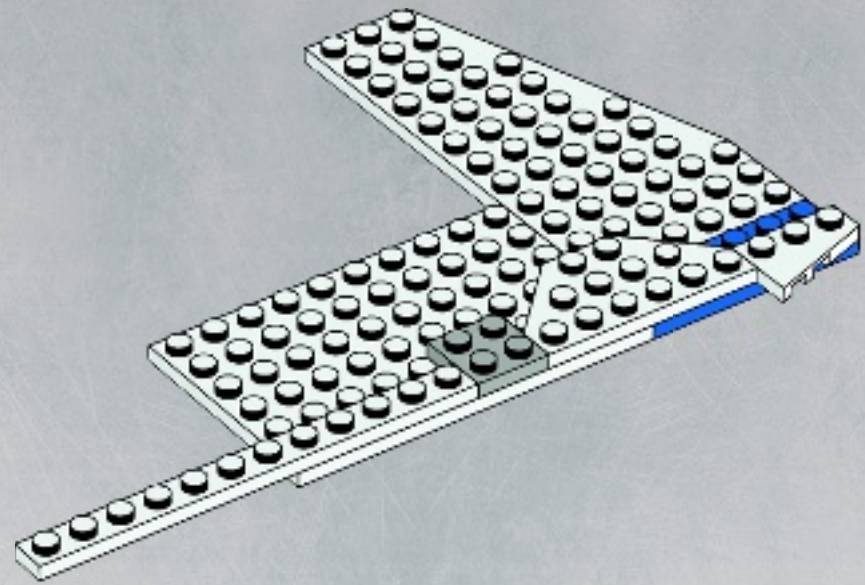

6

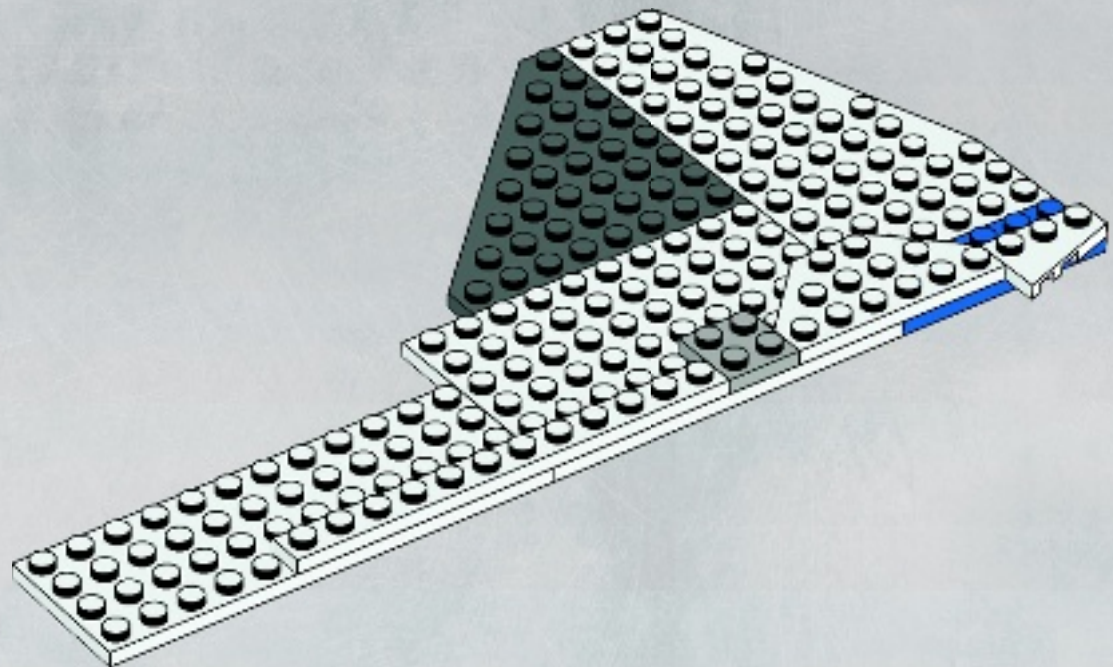

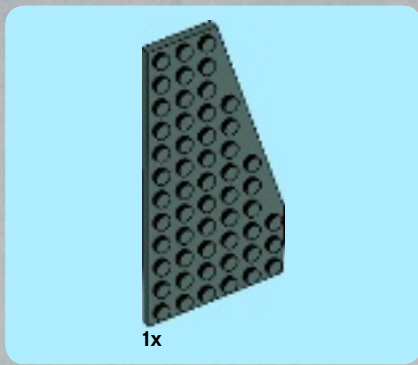

7

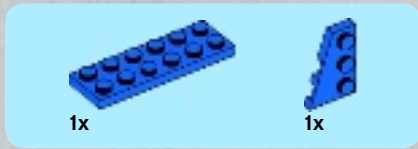
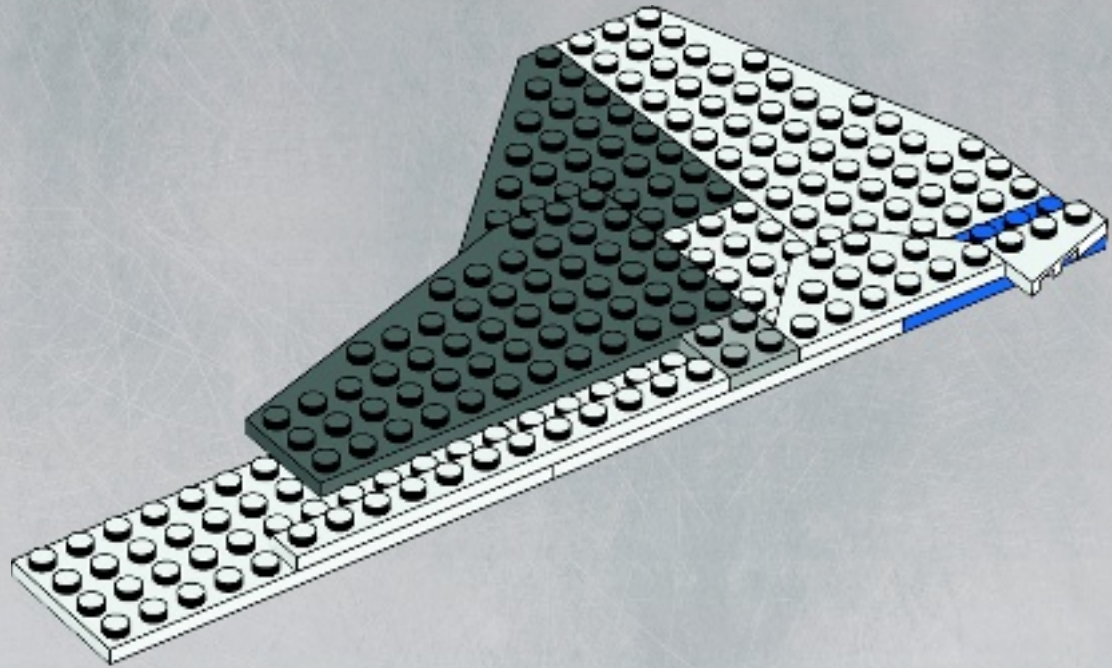

8

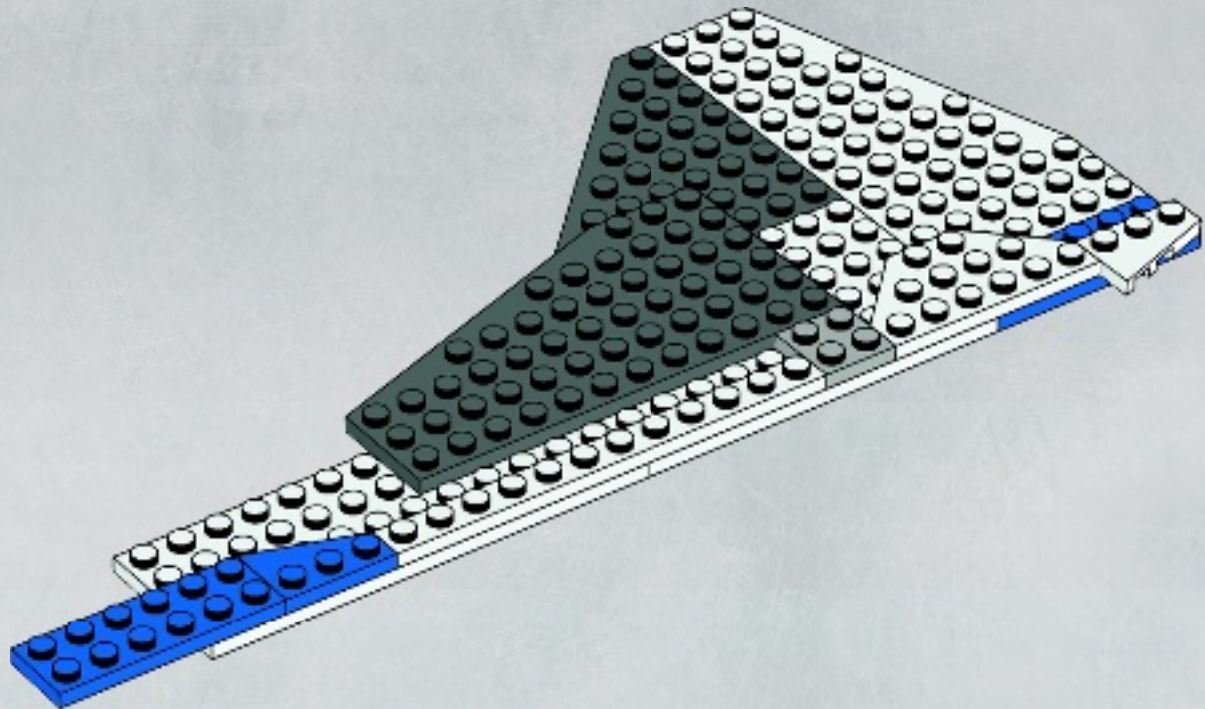

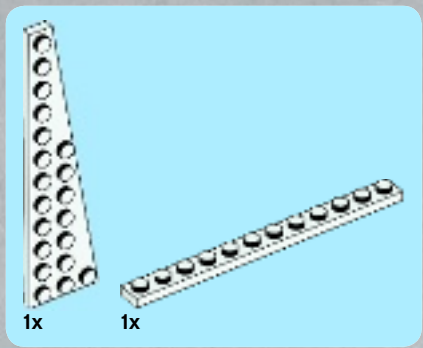

9

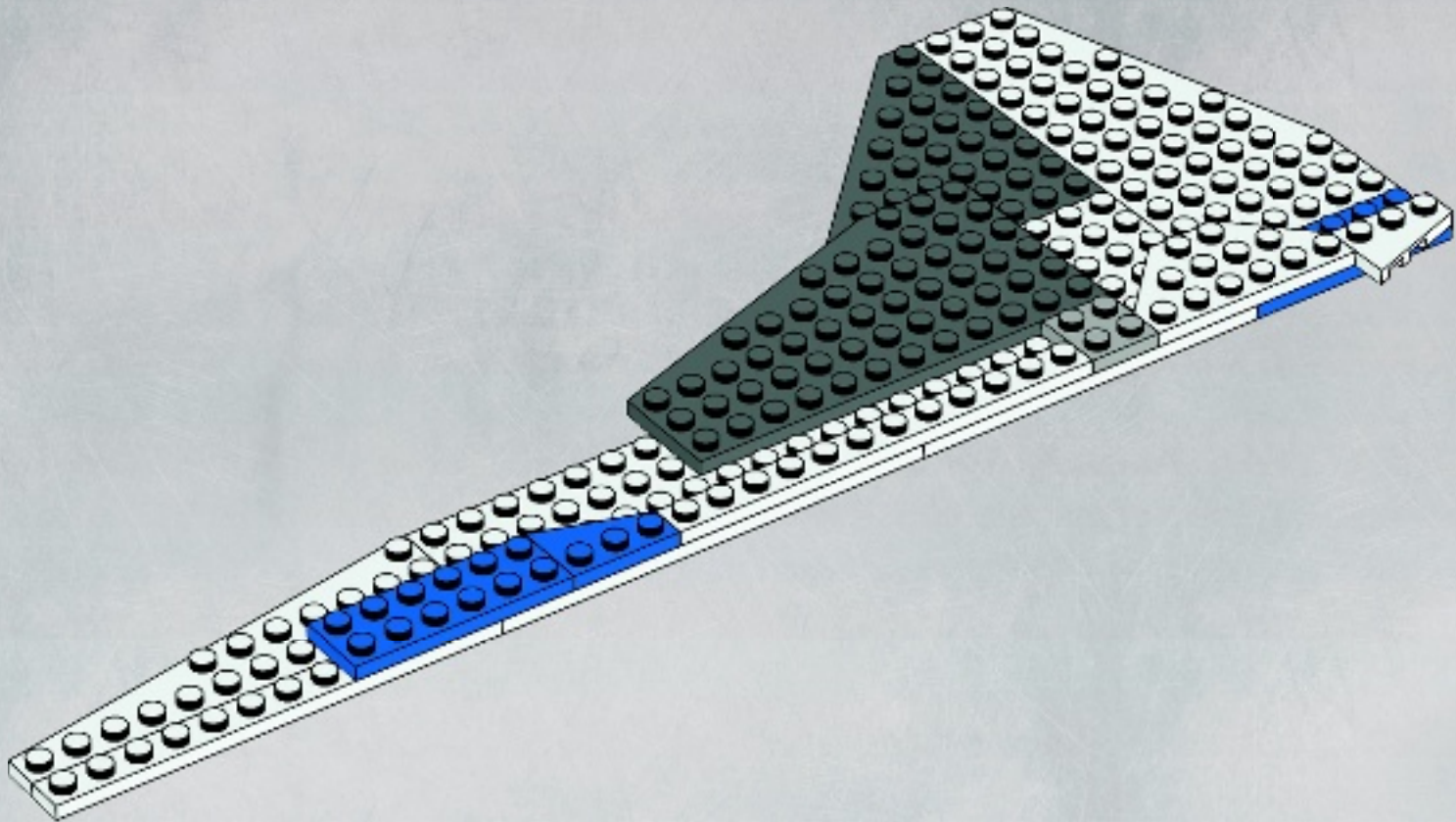

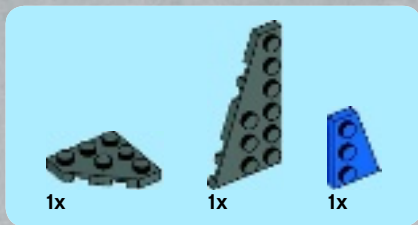

10

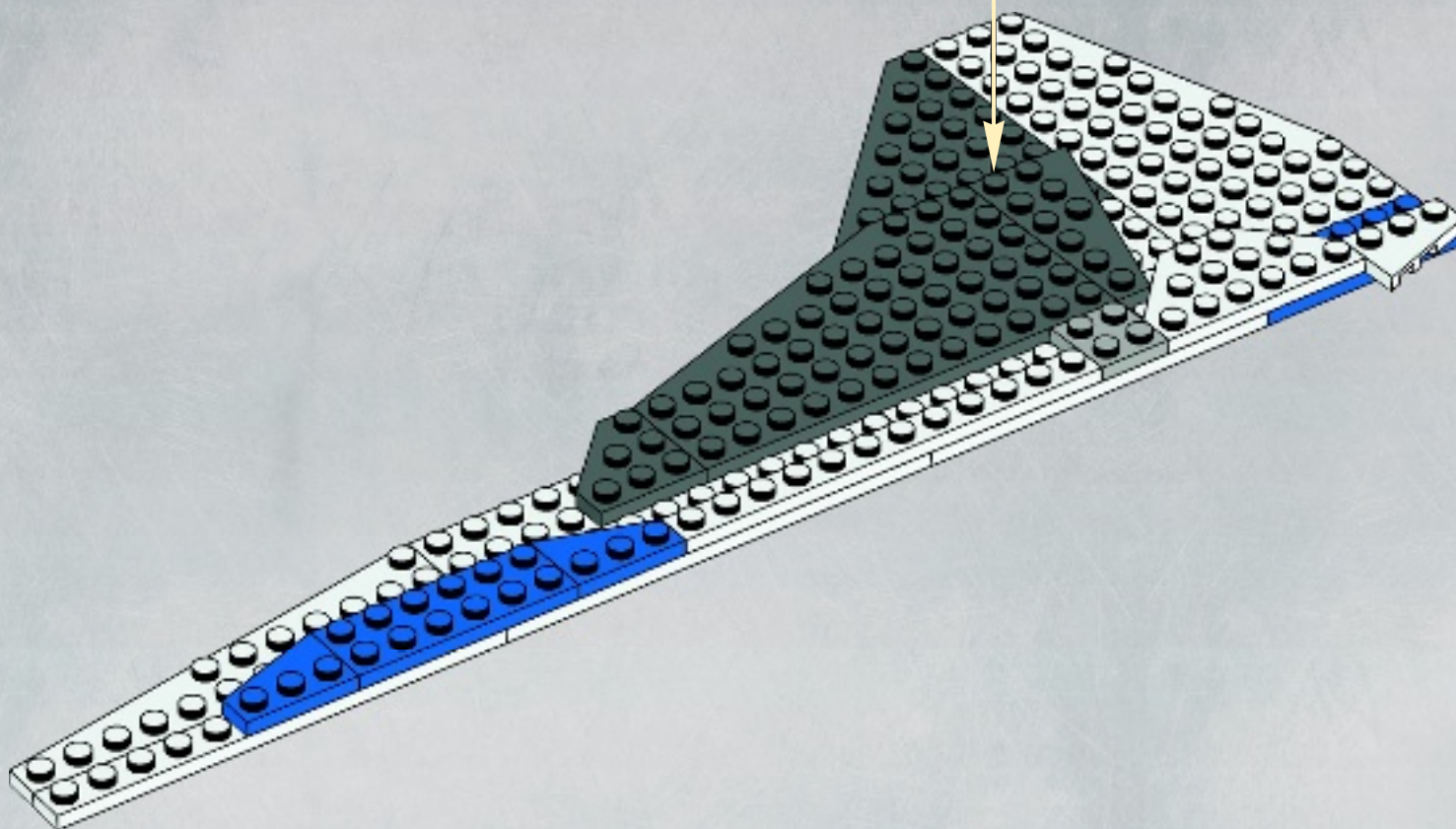
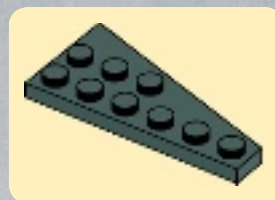

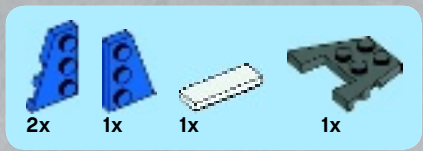

11

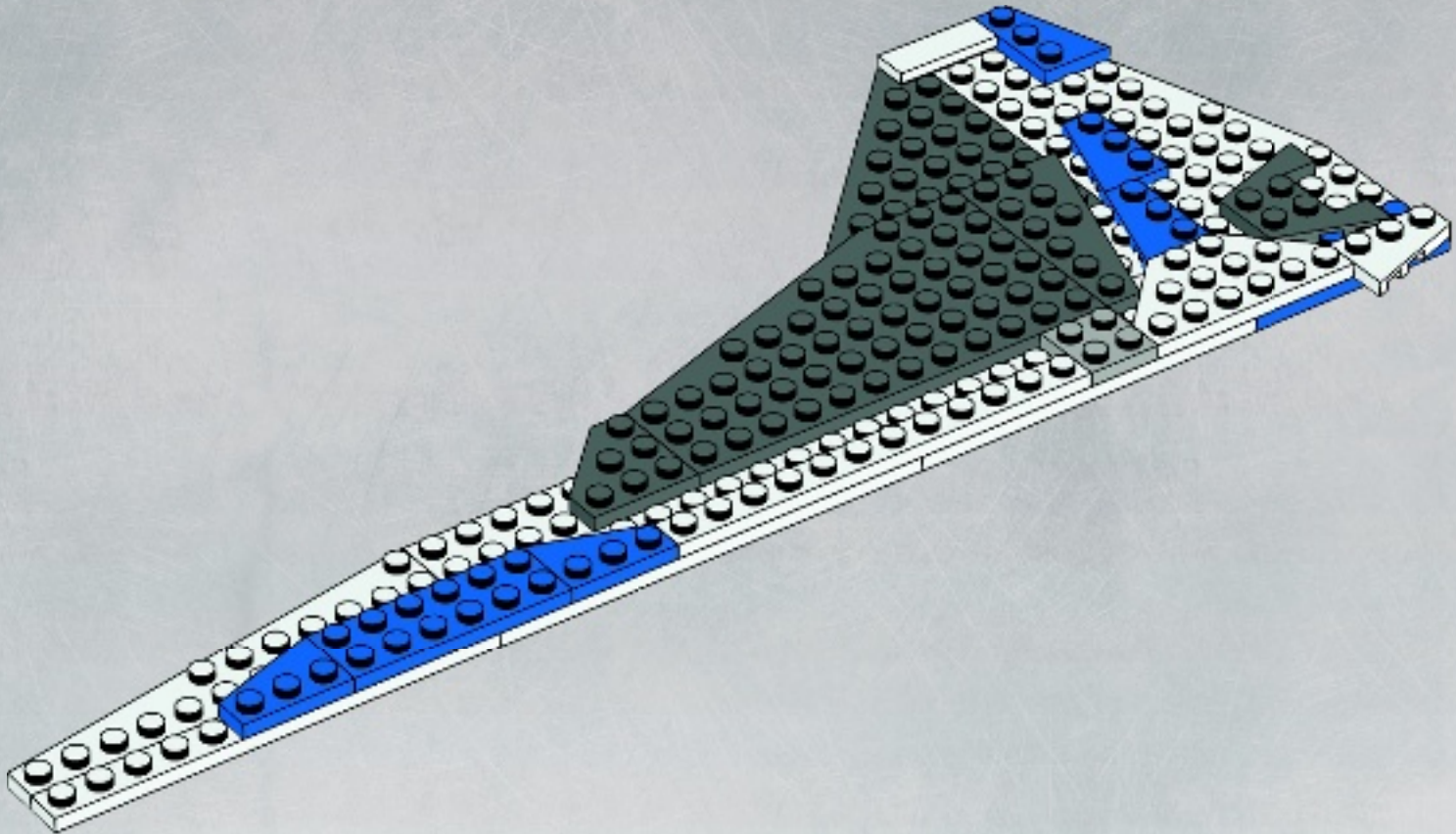

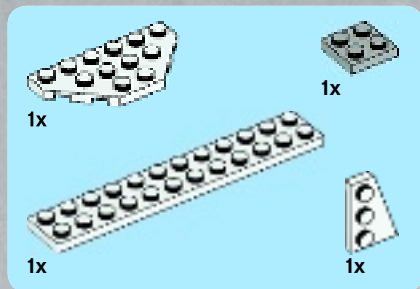

12

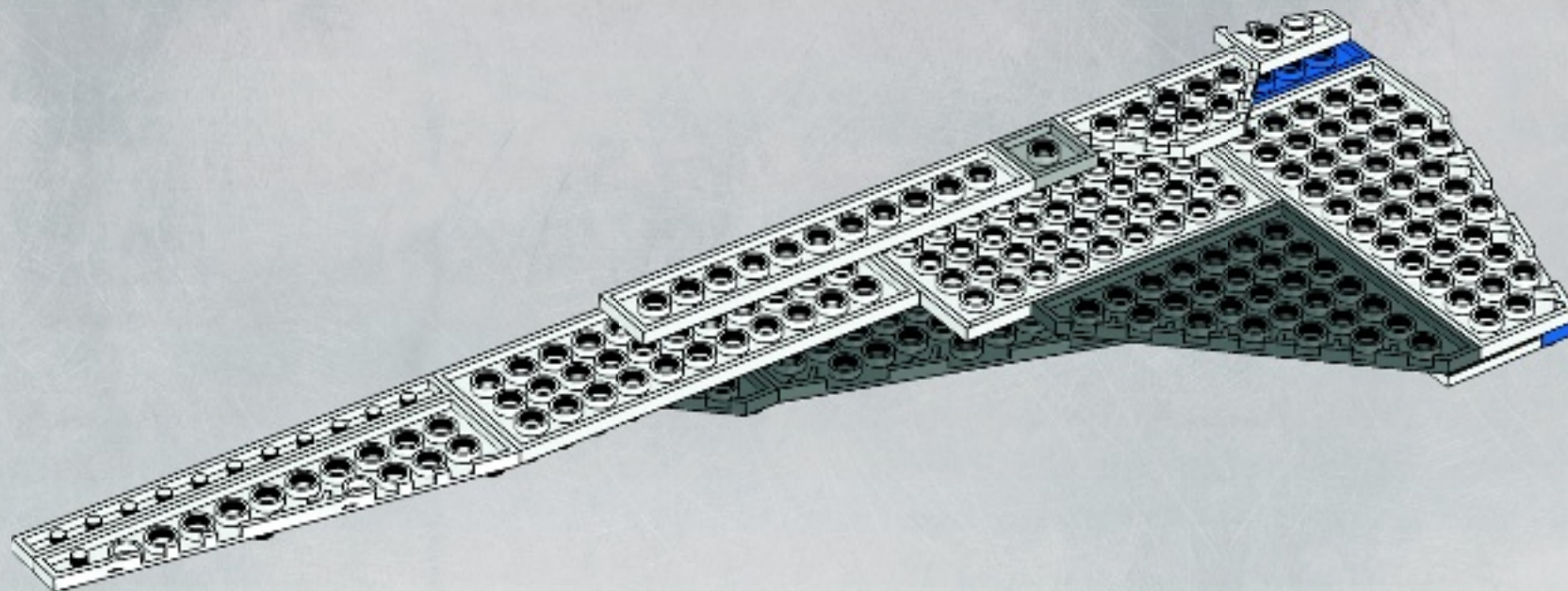

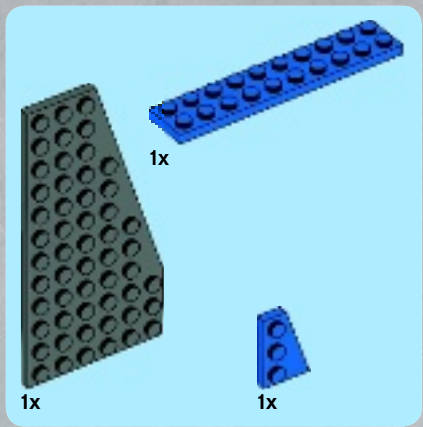

13

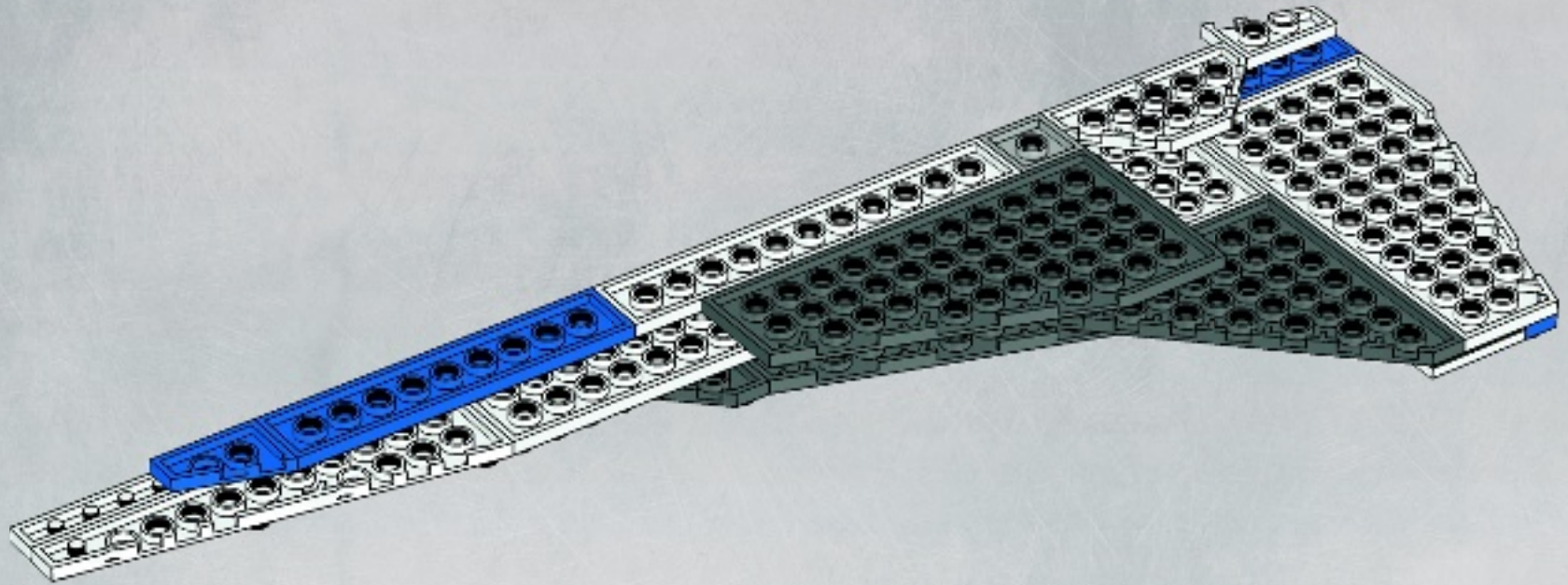

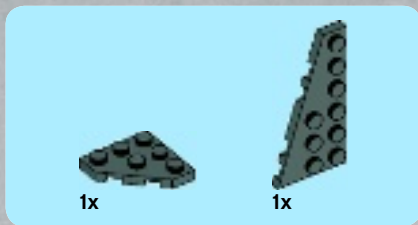

14

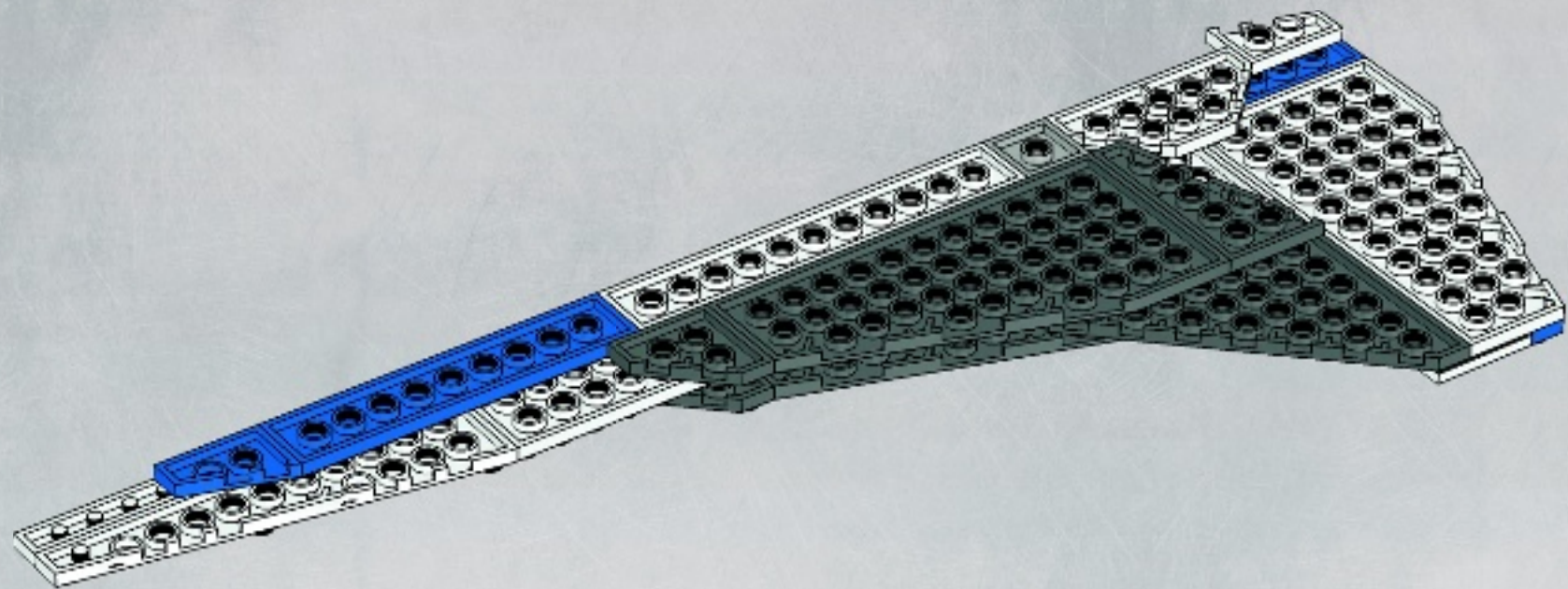



1x



2x



1x

15

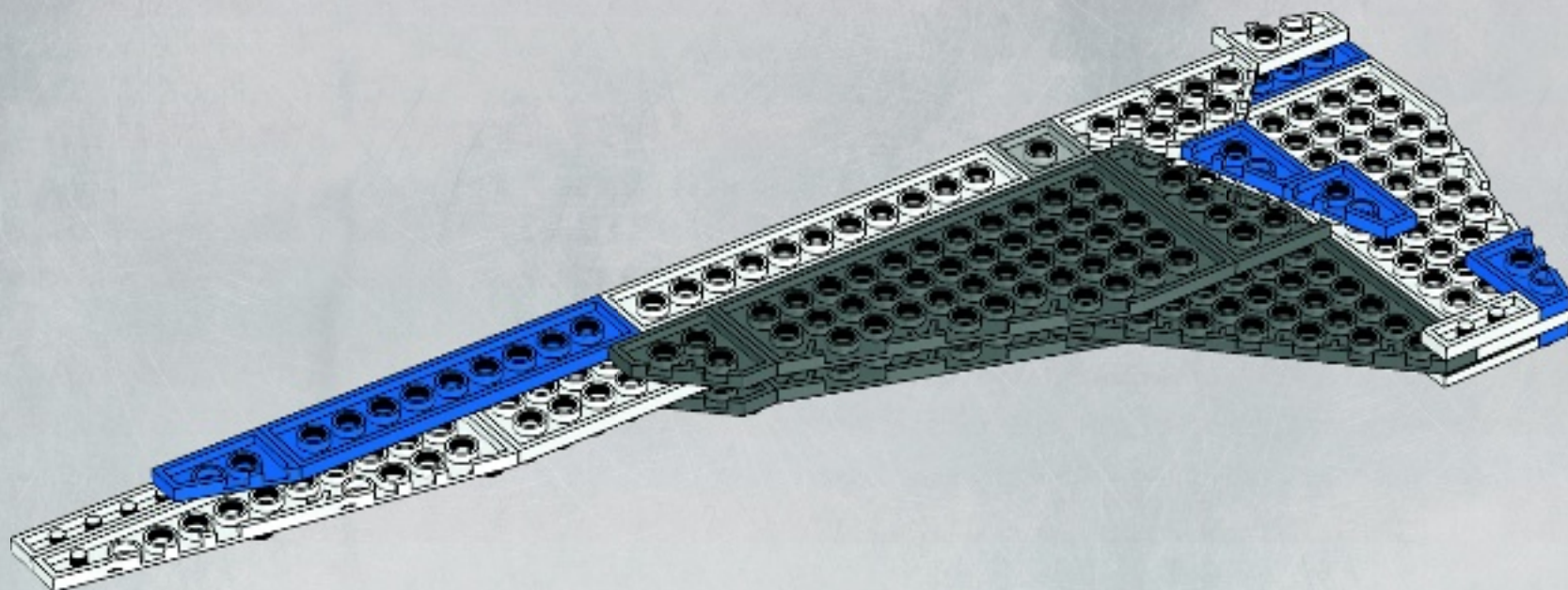



16

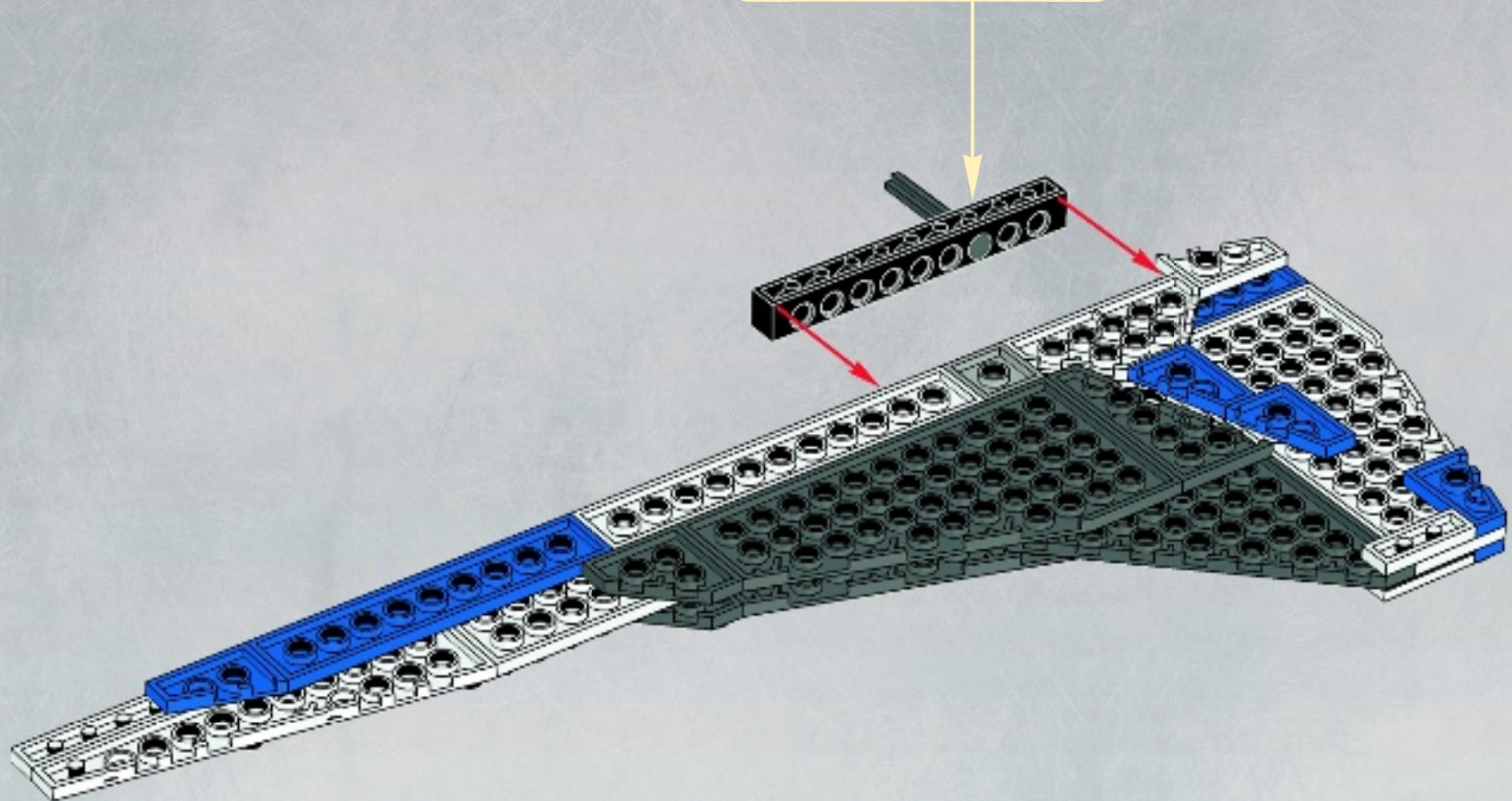
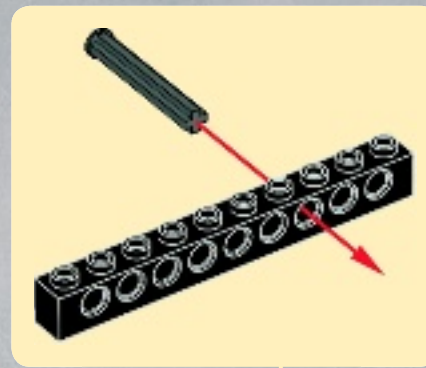



1x



1x

17

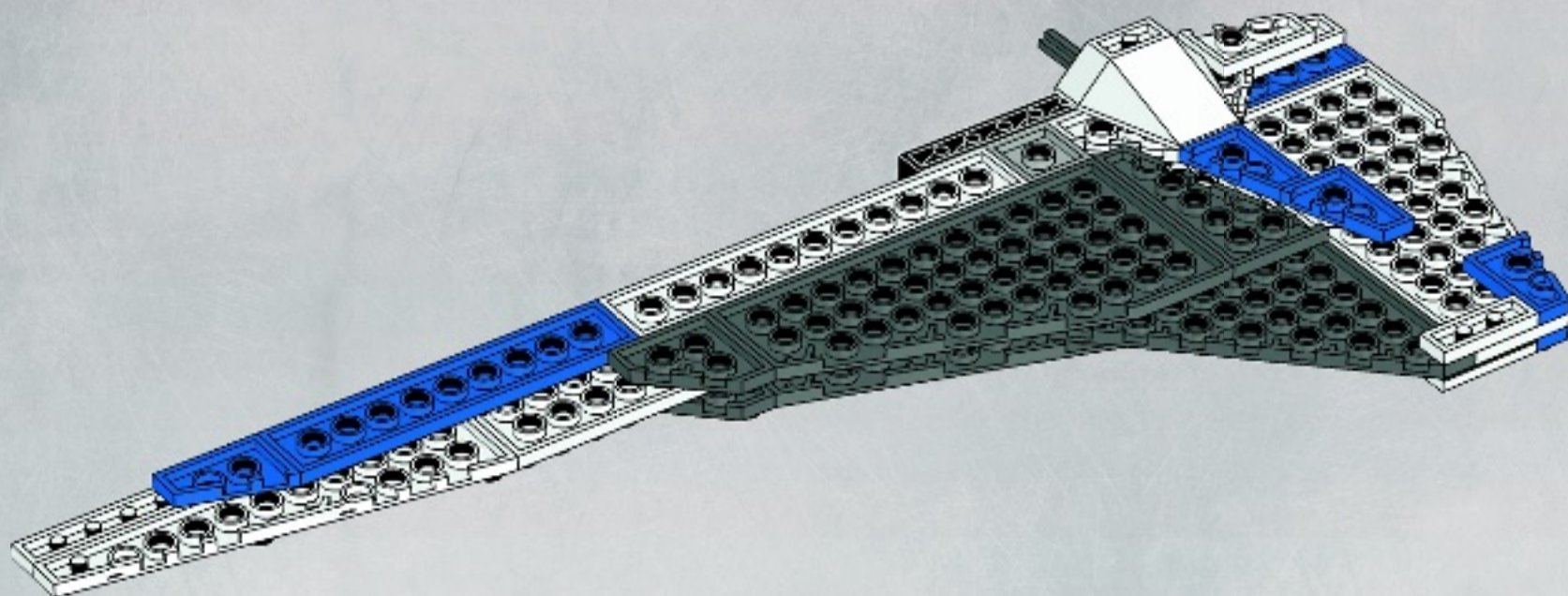

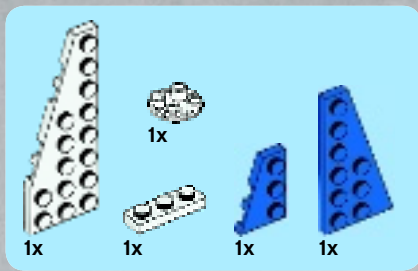

18

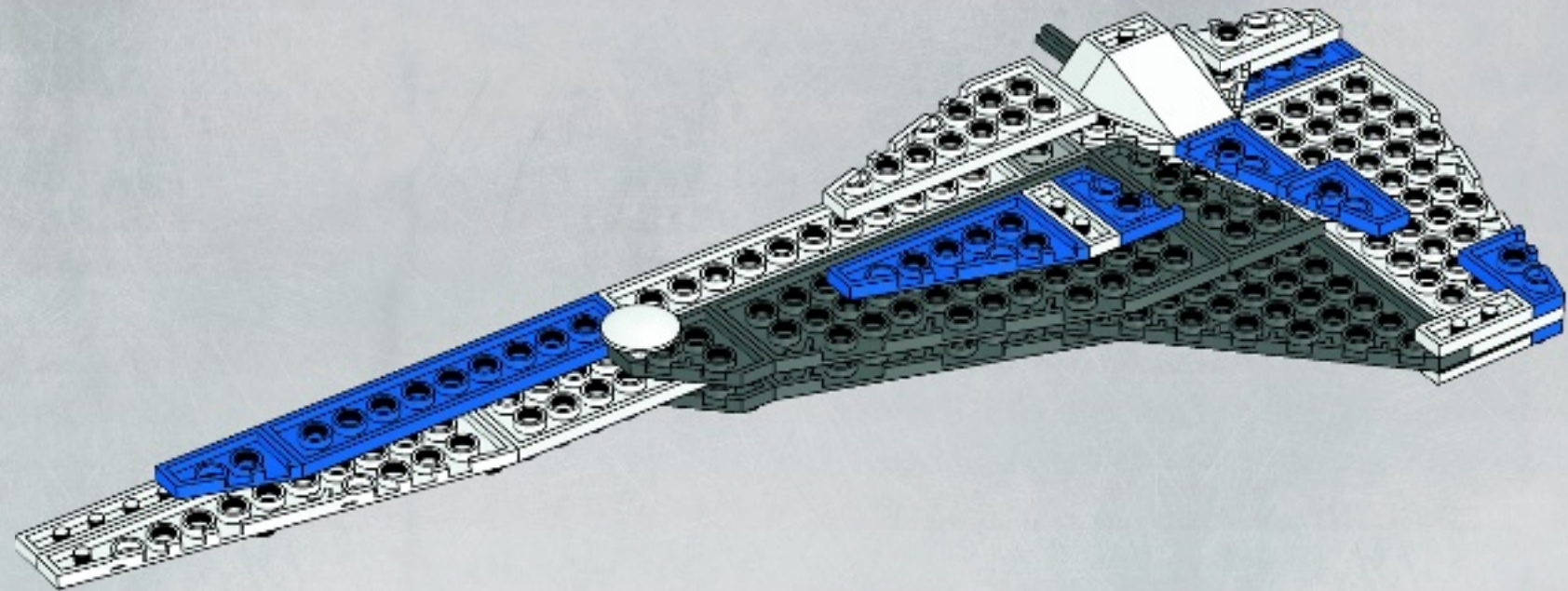



19

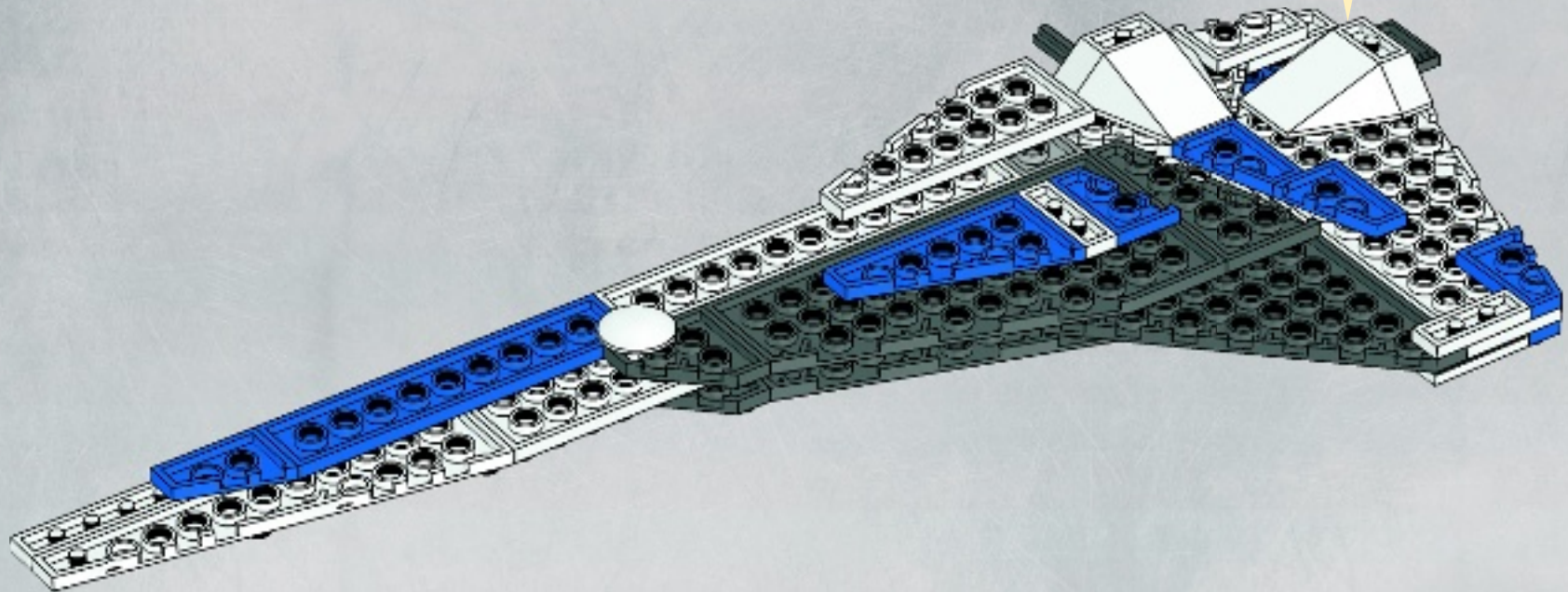
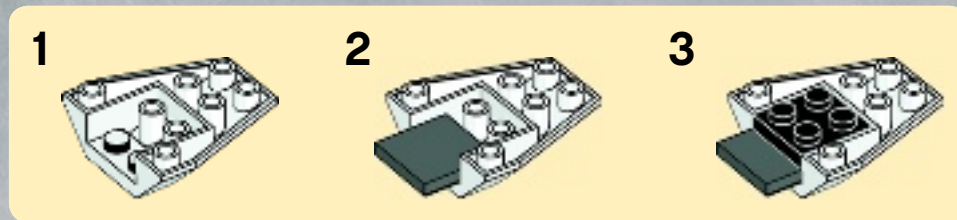

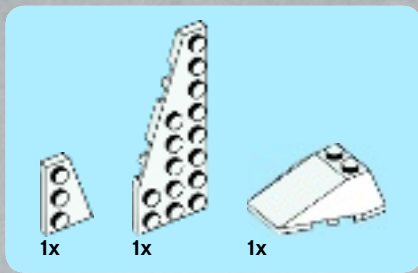

20

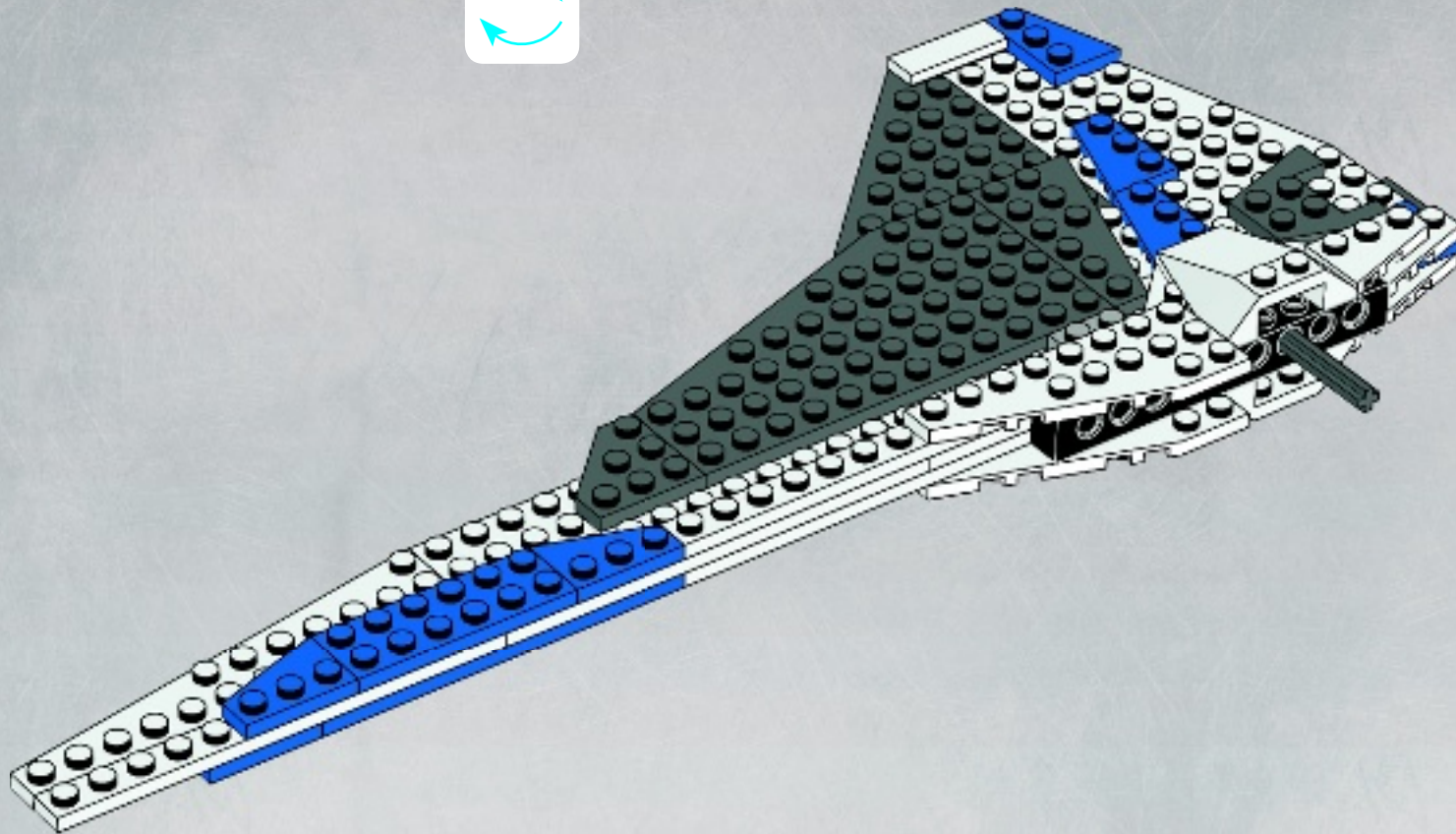

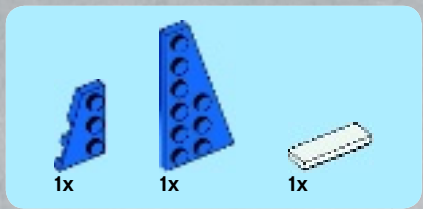

21

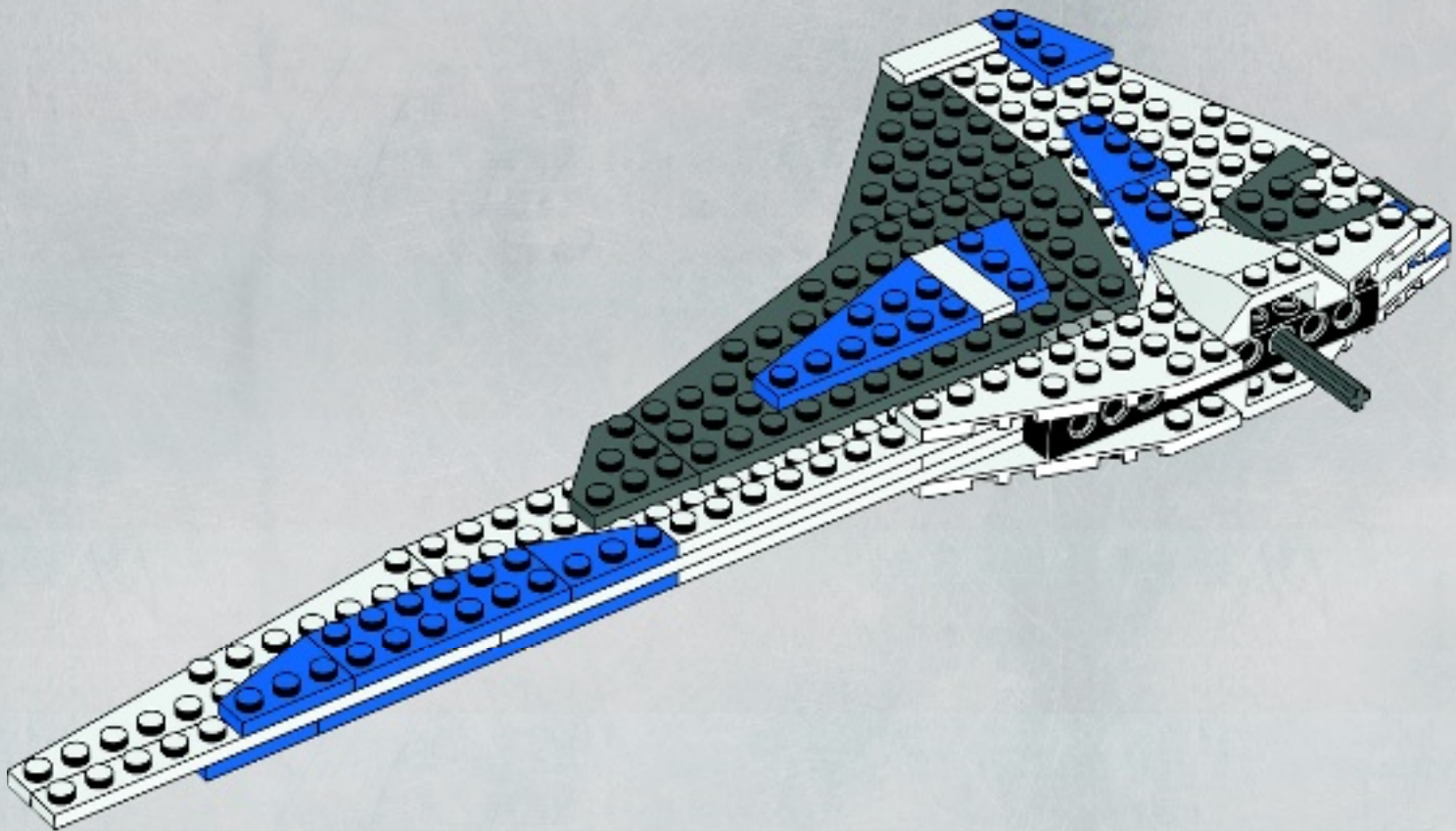

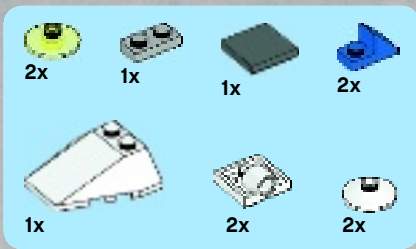

22

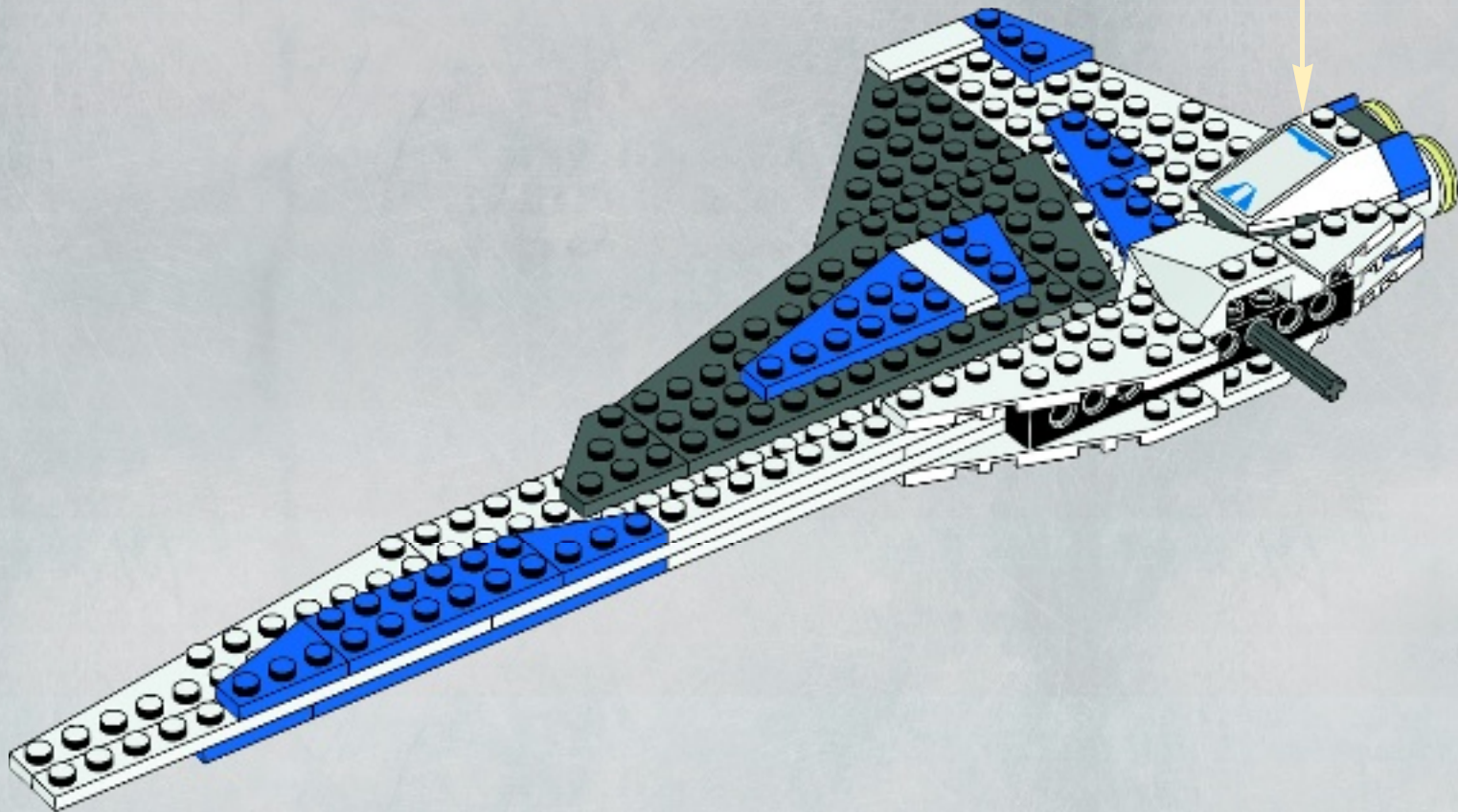
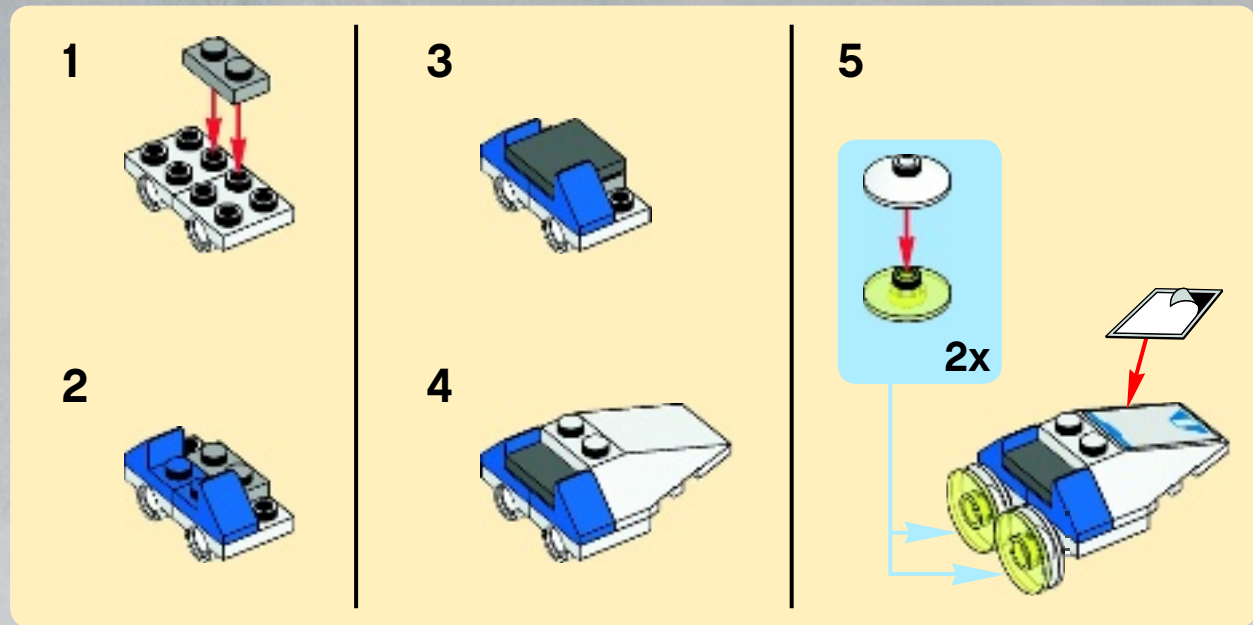

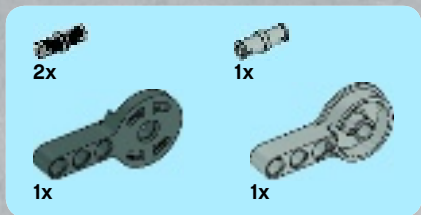

23

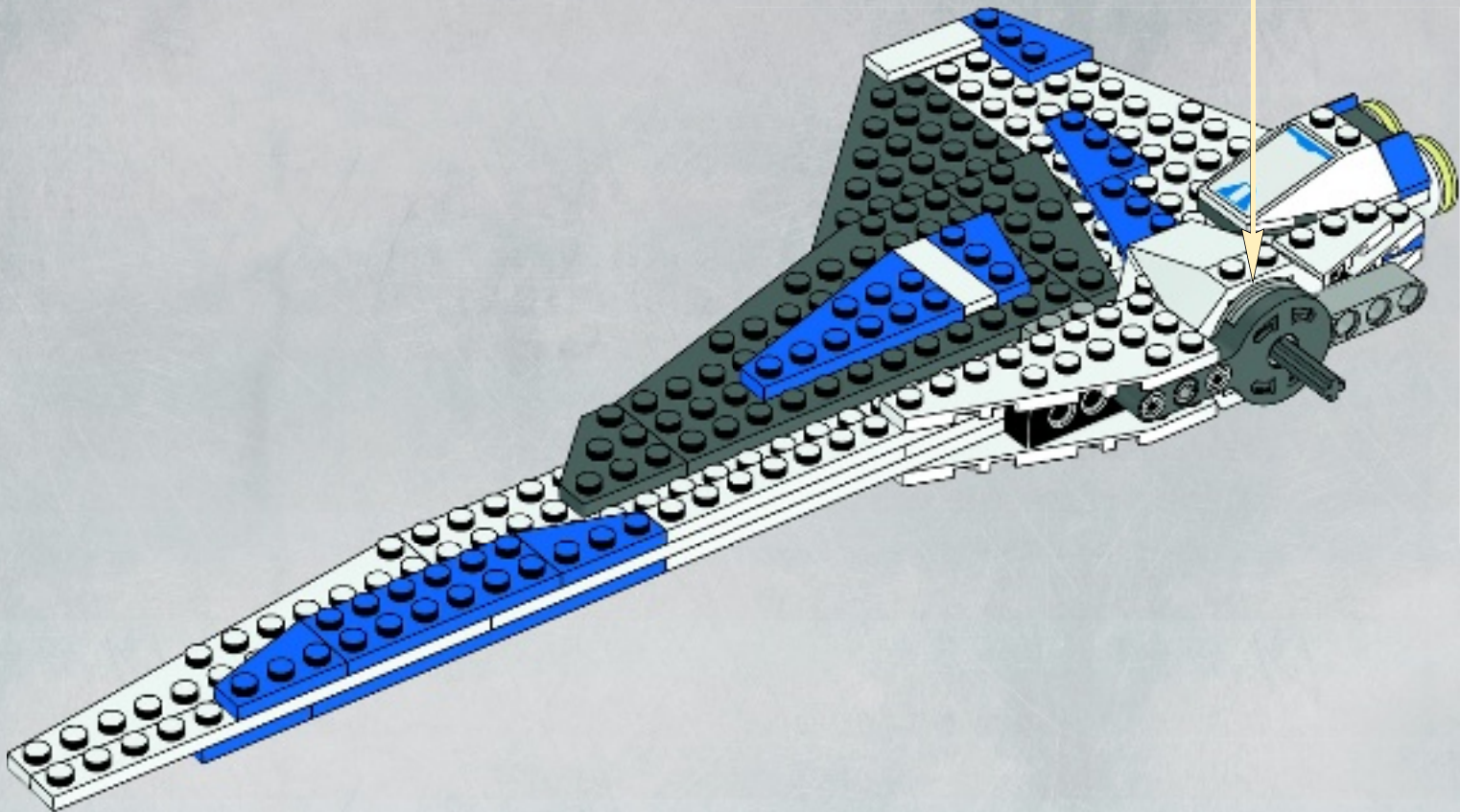
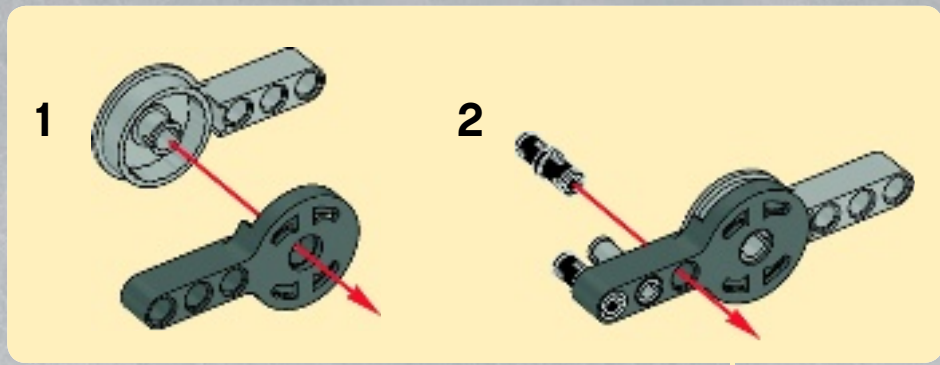

44

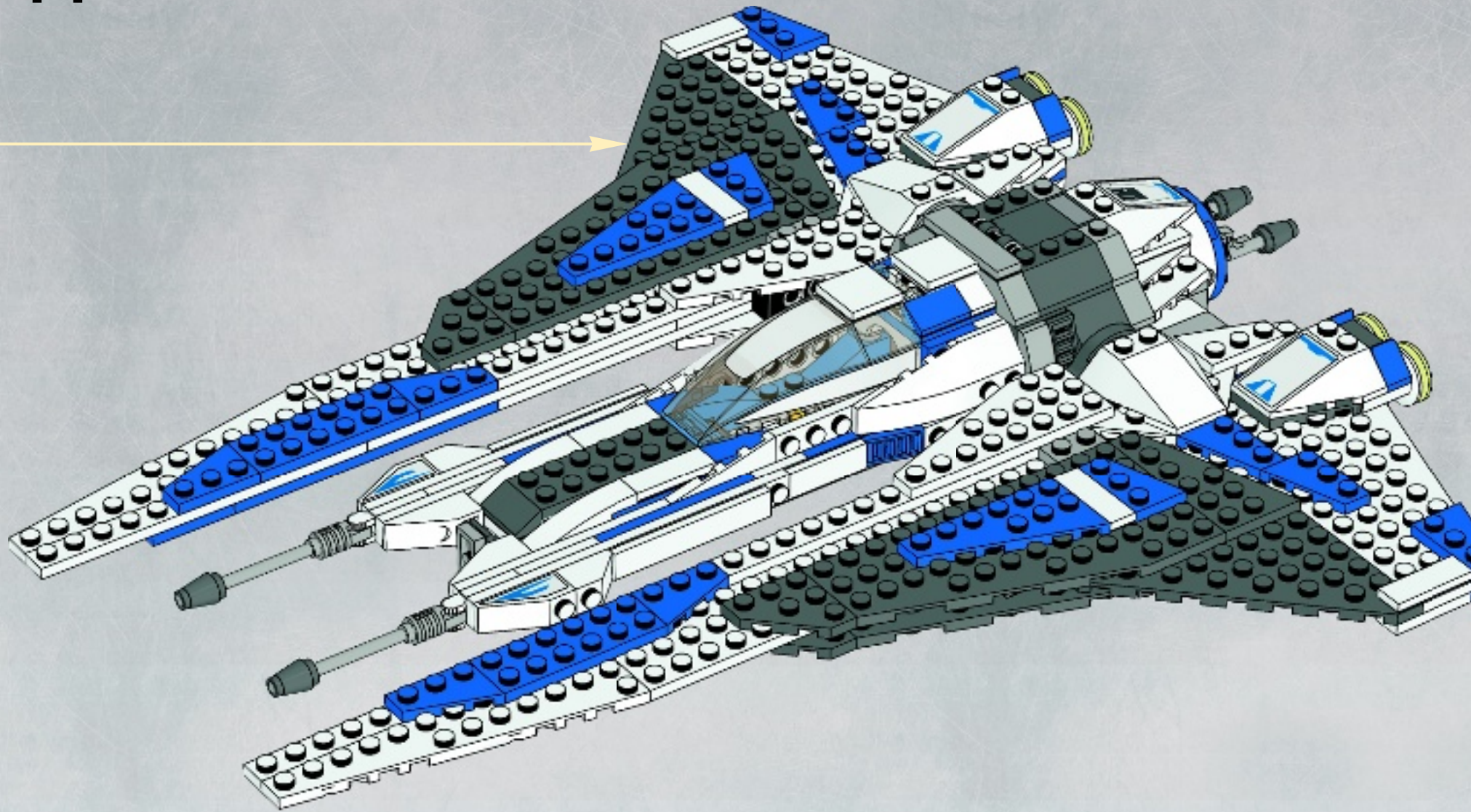



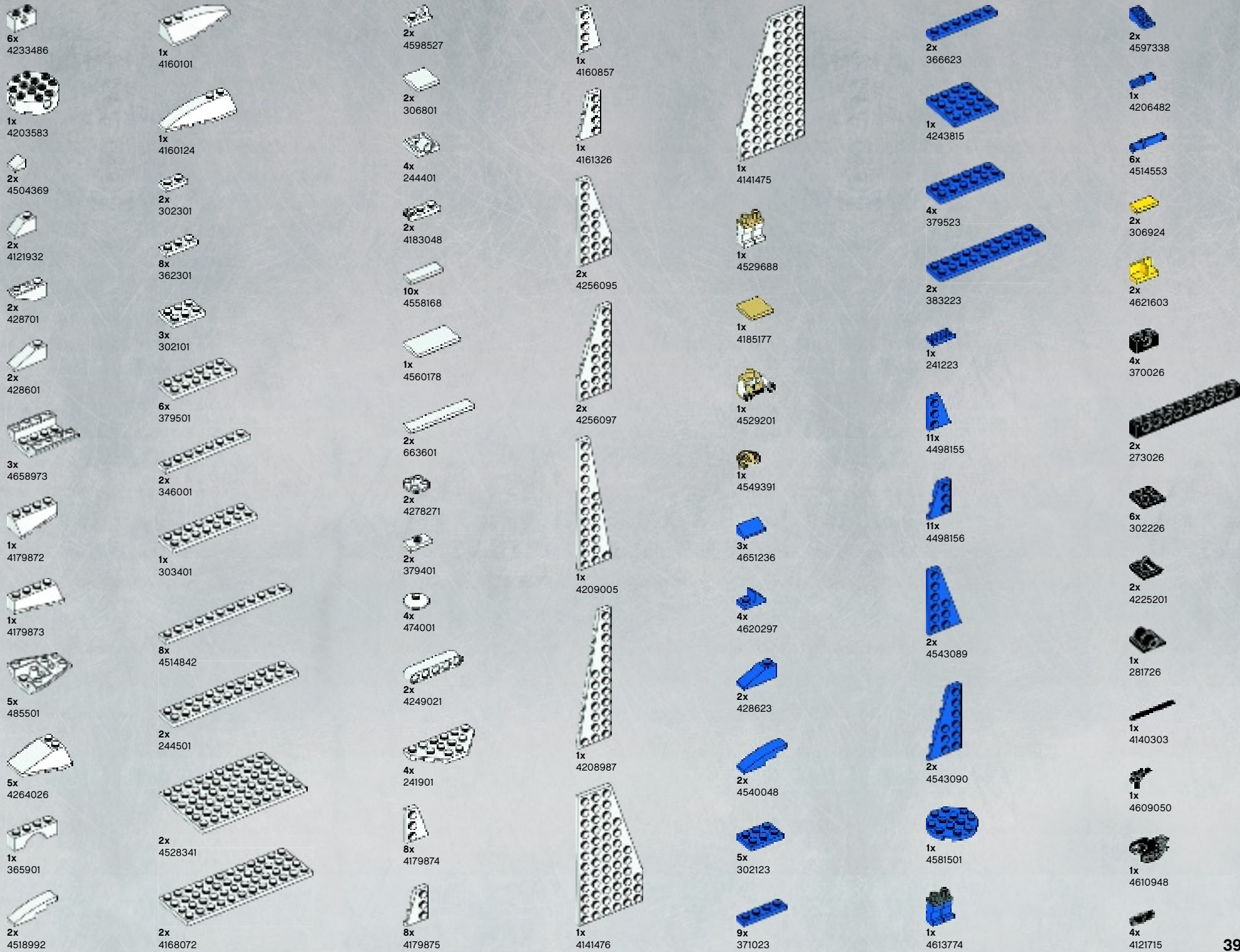



1x
4598530



1x
6009228



1x
6009163



1x
4613740



1x
6006224



4x
4211428



1x
4211716



1x
4211570



6x
4211614



11x
4211398



4x
4211397



1x
4211429



3x
4211395



2x
4211406



2x
4211369



1x
4515341



1x
4598526



2x
4654580



1x
4211803



1x
4615837



10x
4654577



1x
4515369



2x
4211356

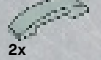

2x
4622803



8x
4211525



2x
4538098



2x
4514195



2x
4211679



2x
4211800



2x
4211807



2x
4211815



1x
4609091



1x
4598788



4x
4540386



4x
4558955



1x
4210636



1x
4497253



1x
4504378



3x
4567887



2x
4210862



2x
4211054



2x
4218188



1x
4211106



4x
4529240



7x
4211094



2x
4211133



2x
4277928



4x
4211055



1x
4211053



2x
4227517



2x
4596895



2x
4290150



2x
4290149

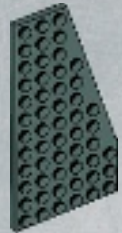

2x
4271543



2x
4271542



1x
4211002



1x
4211067



3x
4294180



2x
4547222



1x
4520307



4x
4210897



2x
4182751



2x
4560177



1x
4527159

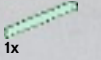

1x
4124073



4x
3006349



1x
300121



1x
4529177



1x
6009155



1x
4613716



2x
4548731



1x
6009135



1x
6009242



Customer Service
Kundenservice
Service Consommateurs
Servicio Al Consumidor
www.lego.com/service or dial



00800 5346 5555 :

1-800-422-5346 :





9677



9678



9679



9469



9497



9498



9499



9500



9515



9516



9496



9496



9496



9496



9497



9497



9497



9498



9498



9498



9499



9499



9499



9499



9500



9500



9500



9515



9515



9515



9515



9515



9515



9516



9516



9516



9516



9516



9516



9516



9516



9516



9516



WIN!

Go to www.LEGOsurvey.com/product to fill out a survey for a chance to win a cool LEGO® Product. No purchase necessary. Open to all residents where not prohibited.



www.LEGO.com



www.LEGOsurvey.com/product

GEWINNE!

Nimm an der Umfrage auf www.LEGOsurvey.com/product teil und hab die Chance ein cooles LEGO® Produkt zu gewinnen! Die Teilnahme am Gewinnspiel führt zu keinerlei Kaufverpflichtungen. Teilnahme in allen nicht ausgeschlossenen Ländern möglich.

WIN!

Ga naar www.LEGOsurvey.com/product, vul een enquêteformulier in en maak kans op een cool LEGO® product. Geen aankoopverplichting. Iedereen mag deelnemen, uitgezonderd ingezetenden van landen waar een enquêteverbod geldt.

GAGNE!

Visite www.LEGOsurvey.com/product pour répondre à un questionnaire et avoir une chance de gagner un produit LEGO® très cool! Aucune obligation d'achat. Ouvert à tous les résidents des pays autorisés.

当てよう!

www.LEGOsurvey.com/product にアクセスして、アンケートにご記入ください。当選者にはレゴ製品を差し上げます。お買い上げの必要はありません。禁止されていない限り、すべての皆様にご利用いただけます。