

BIONICLE®

GRESH

8980

GLATORIAN



1

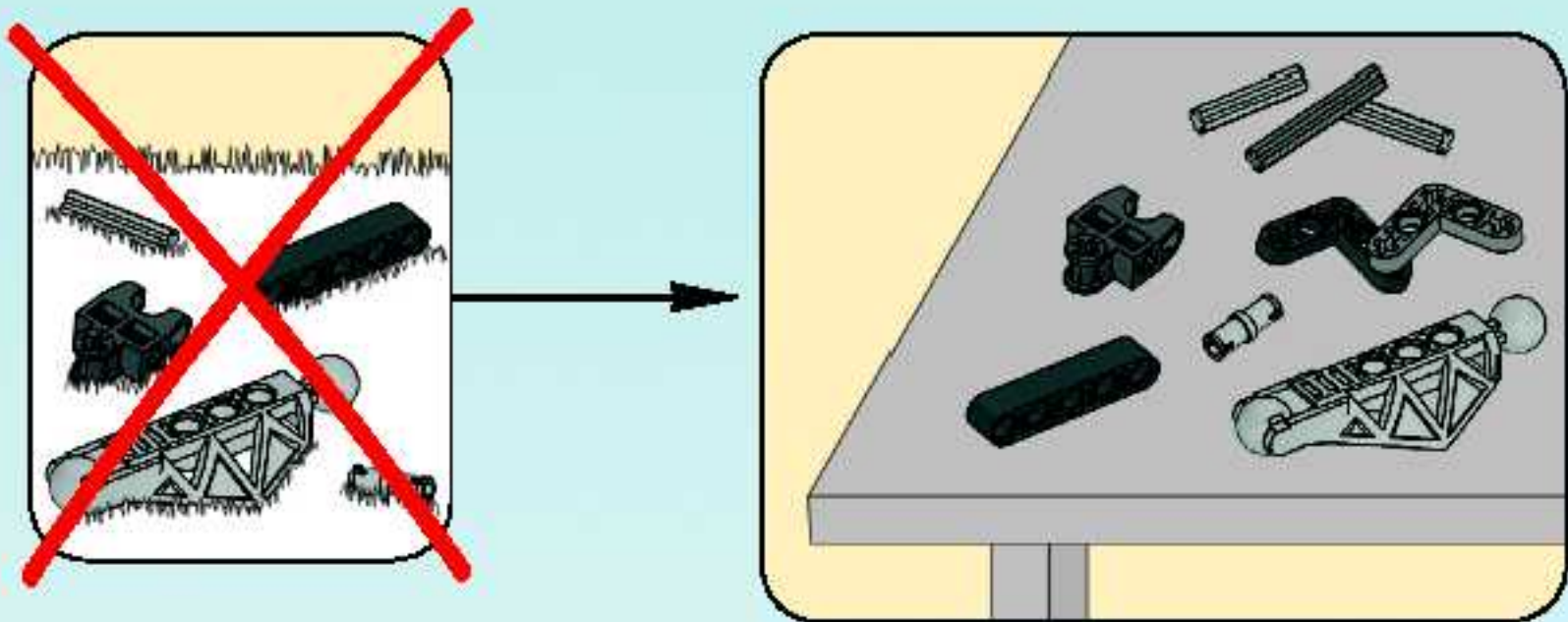

2

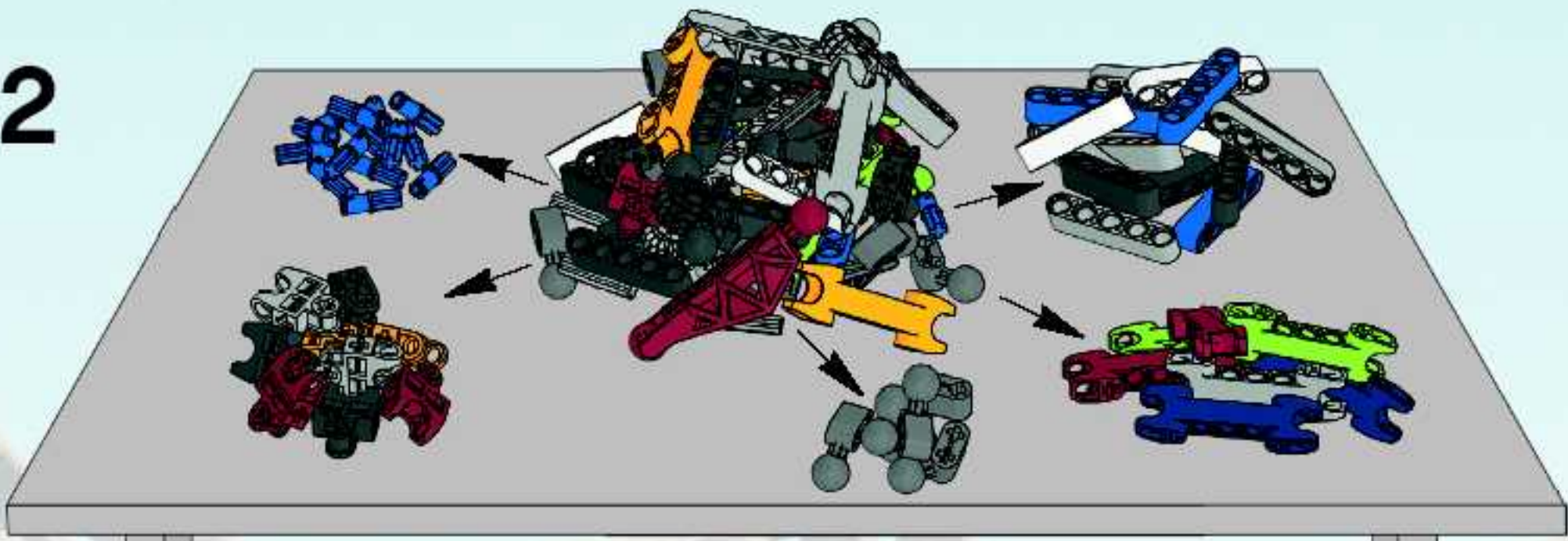

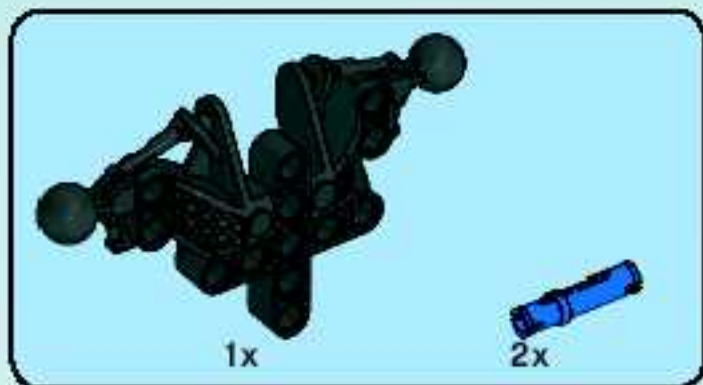

1





2

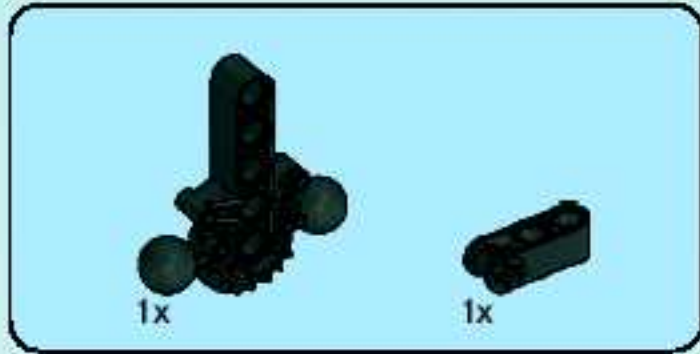
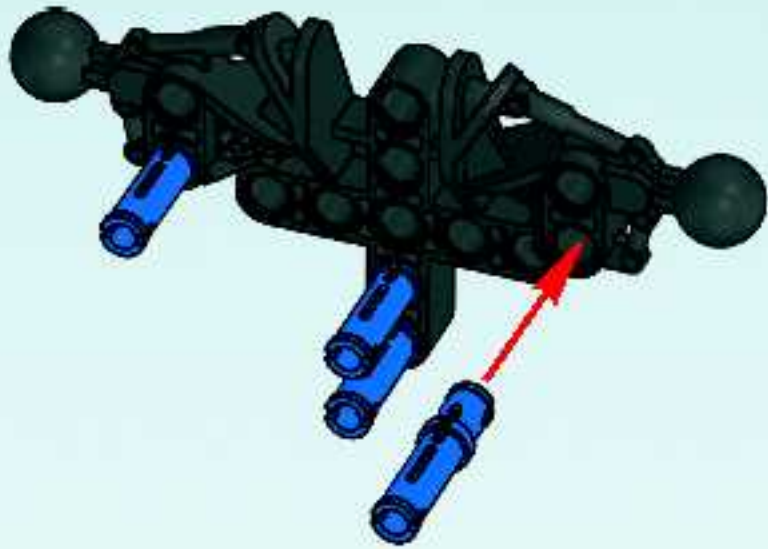

3

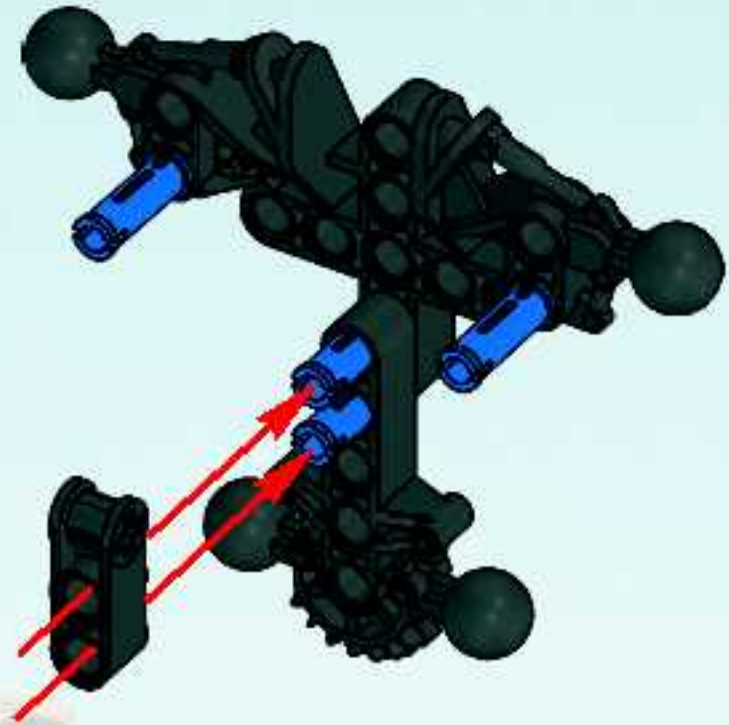

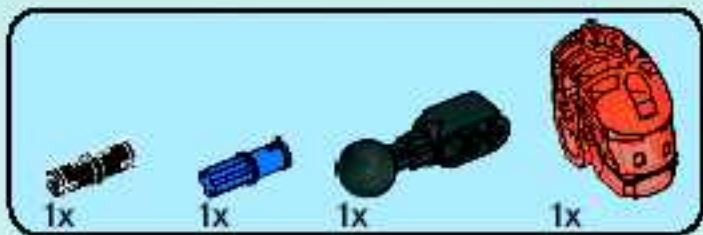

4

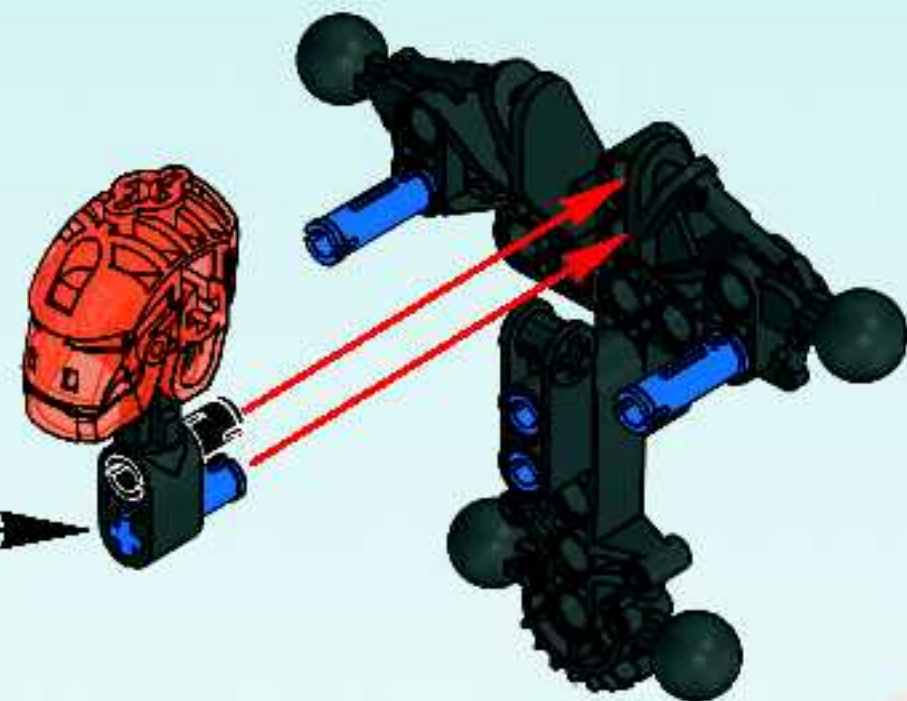
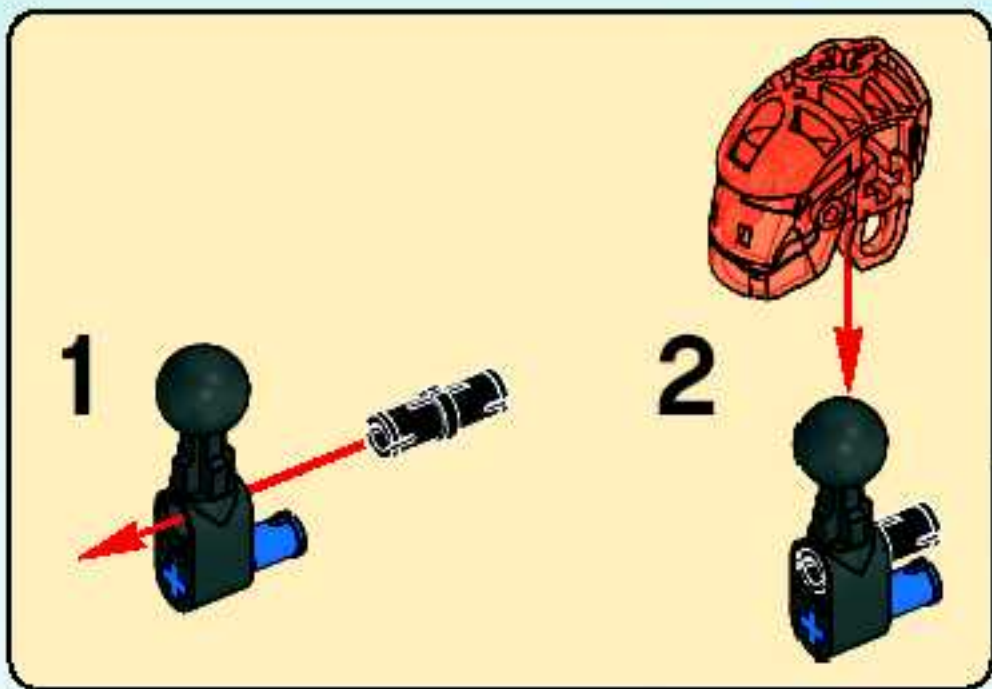

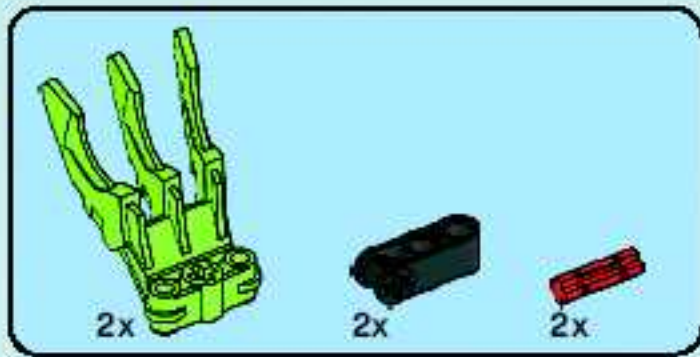

5

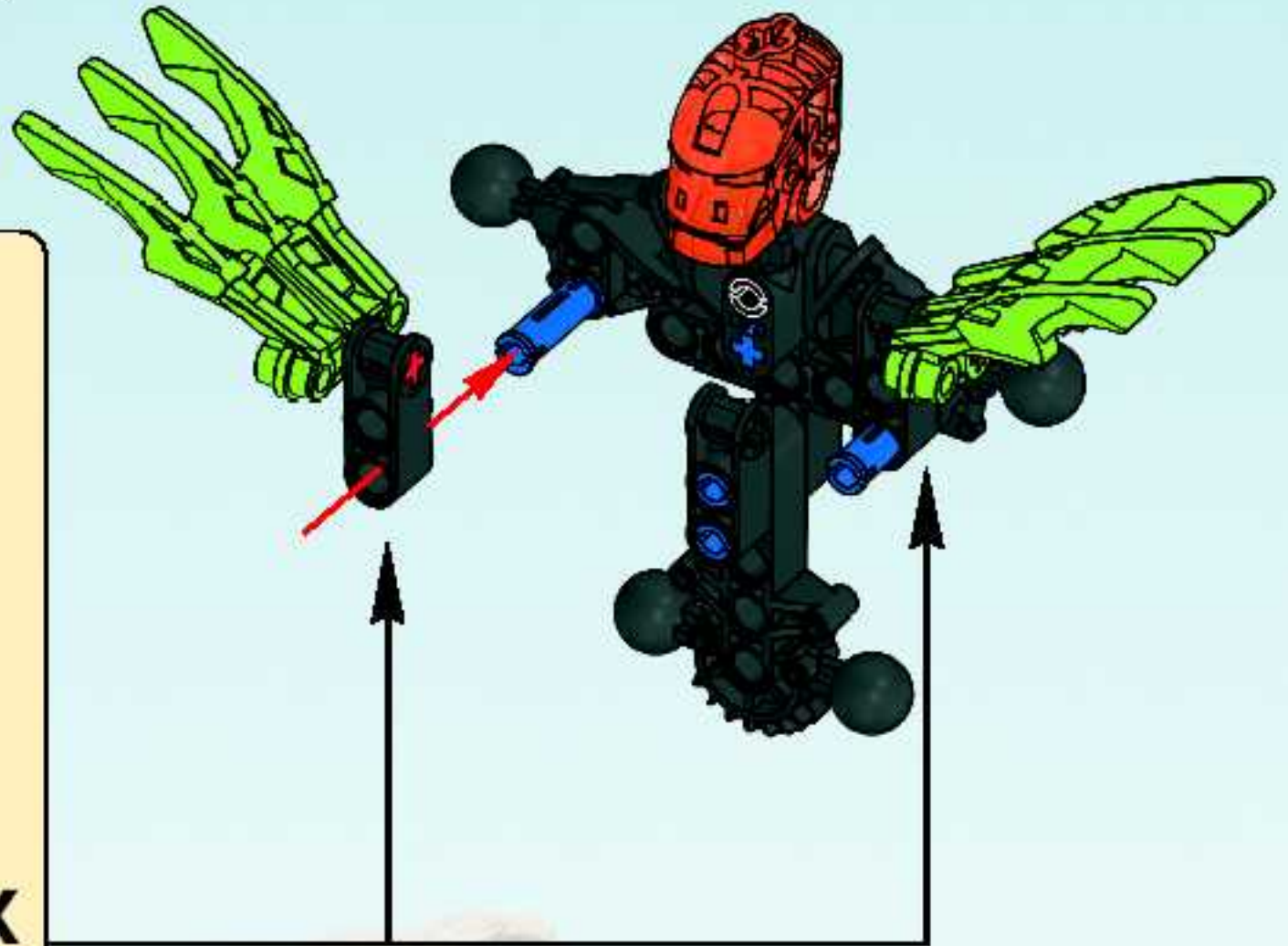
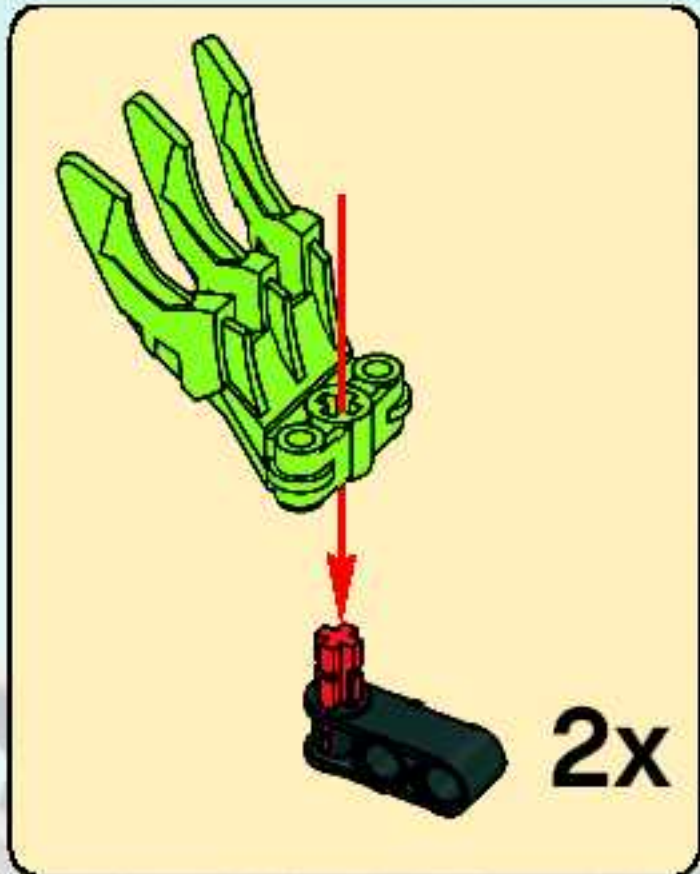

6



6



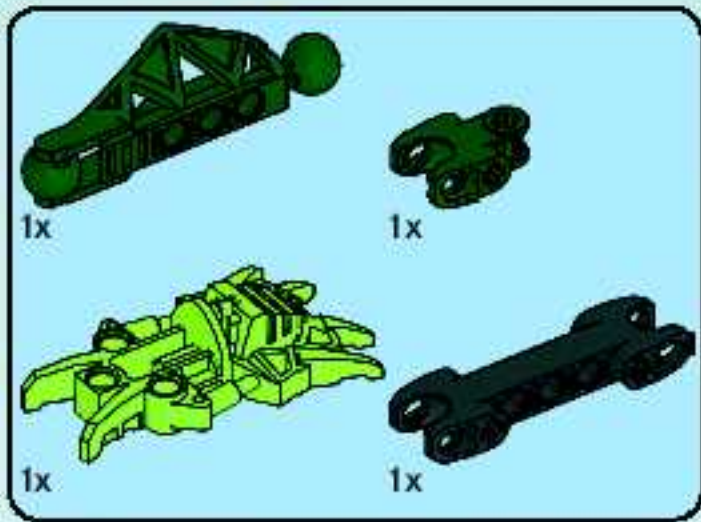

7

1



2

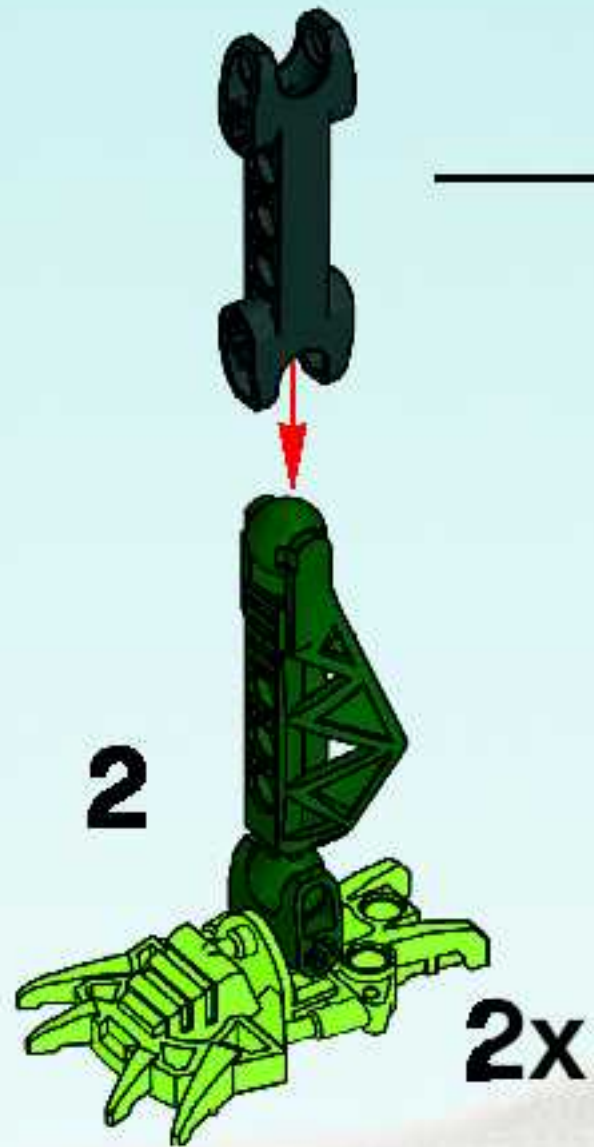

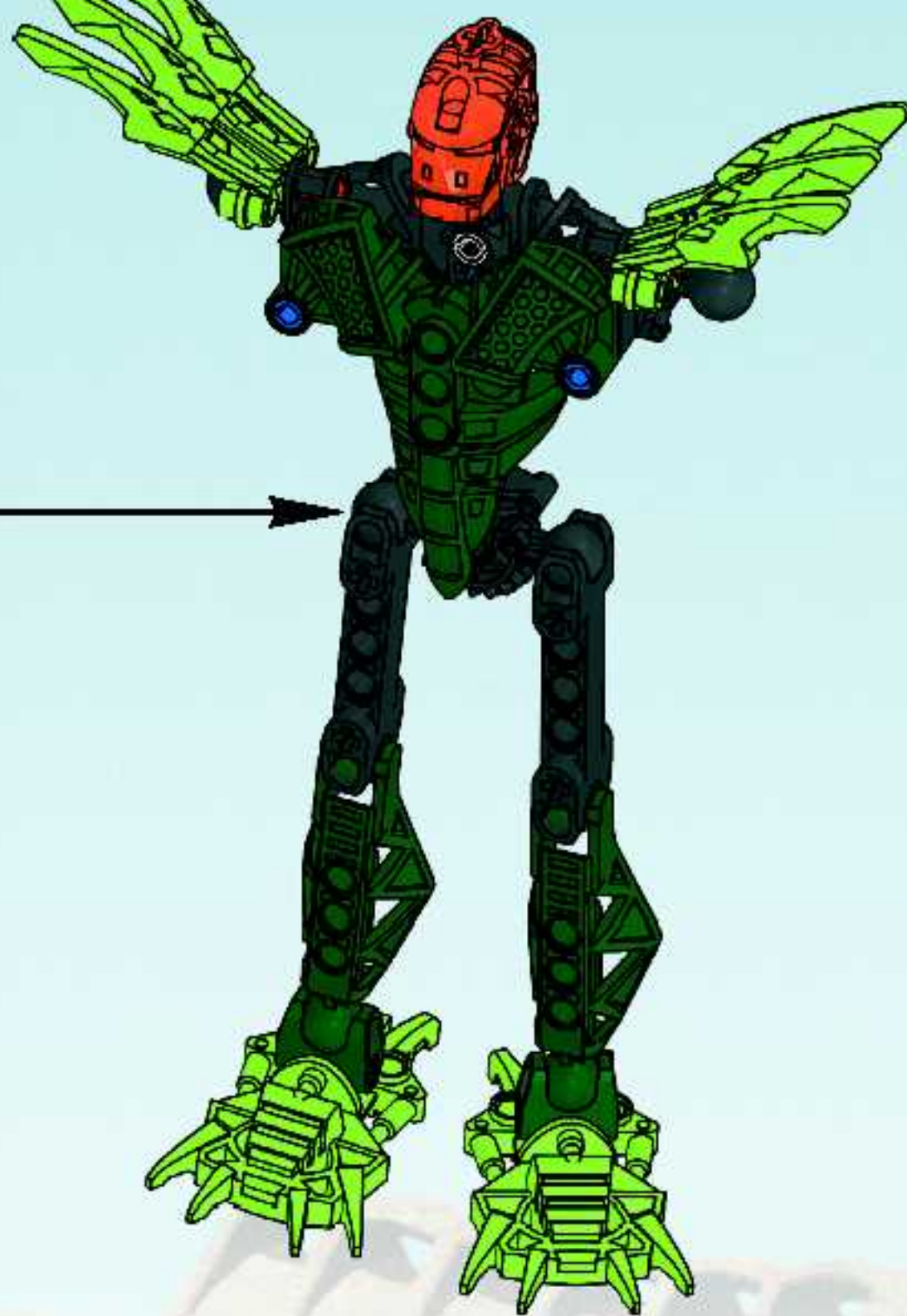

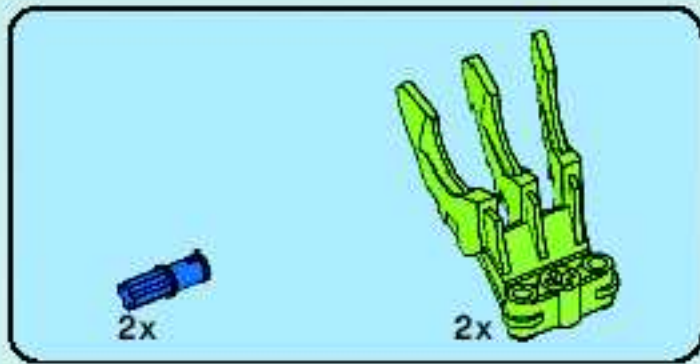

8

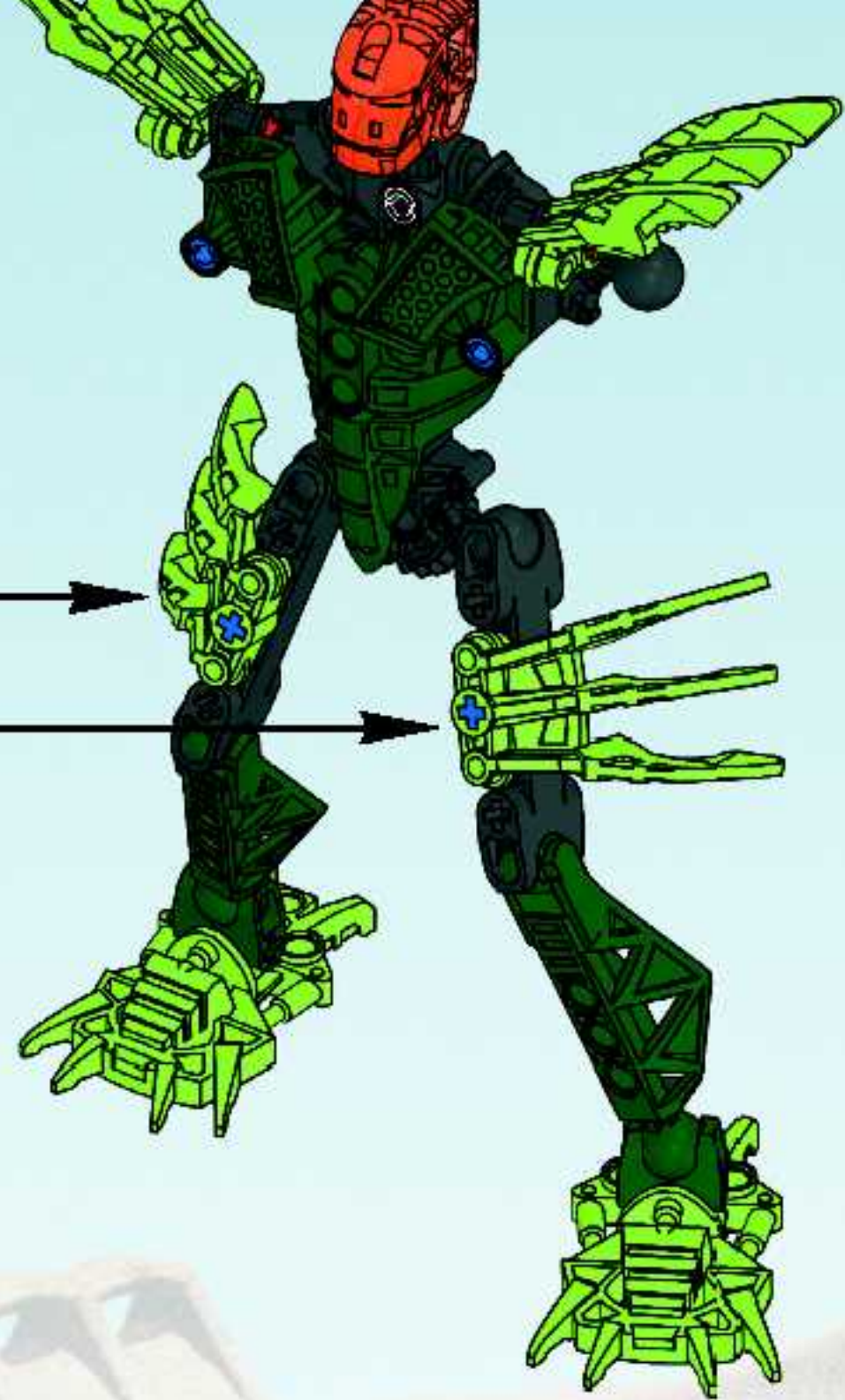
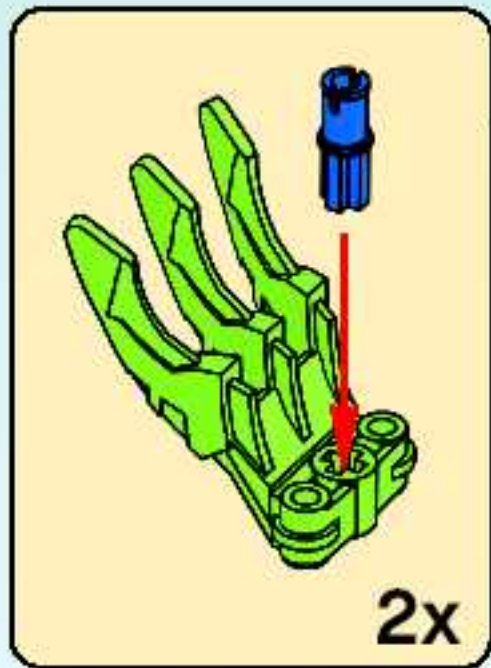



1

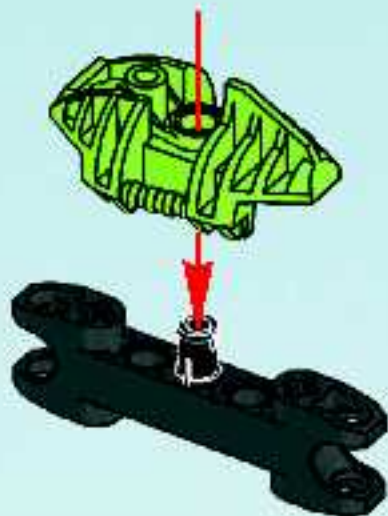

2

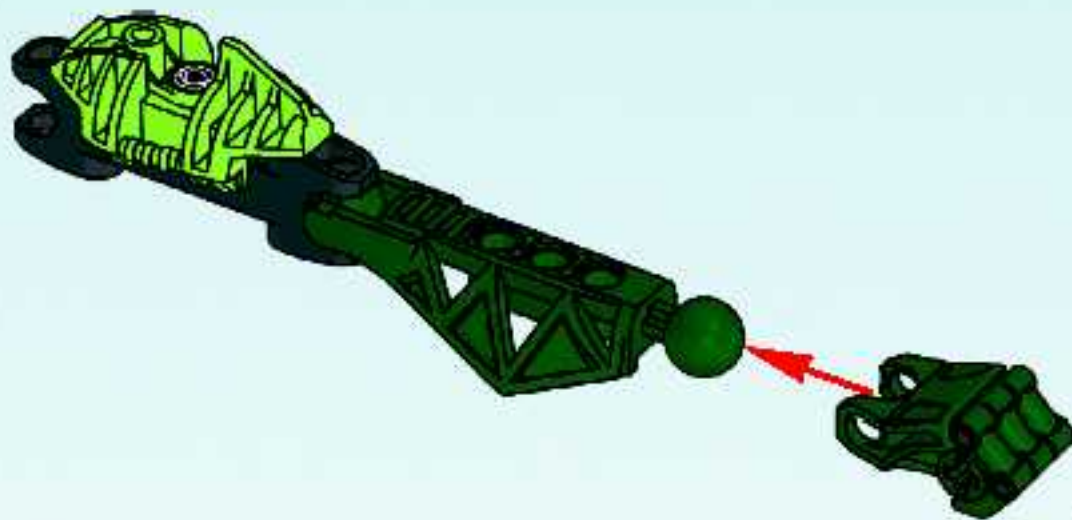

2x

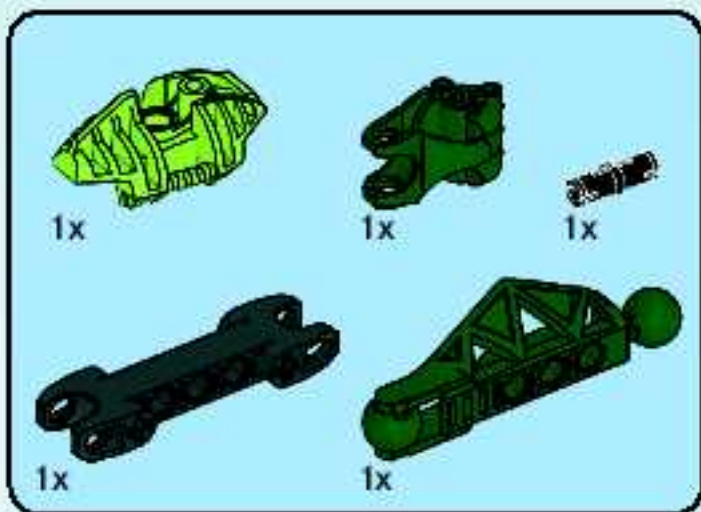

9



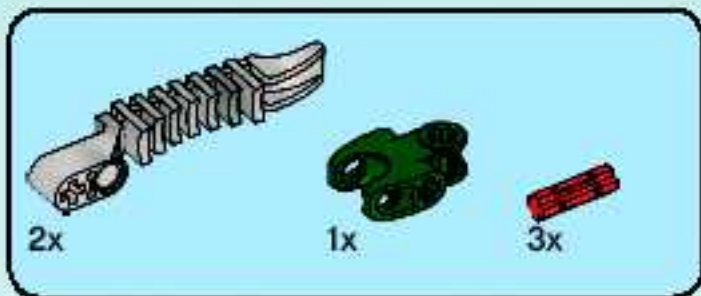

10

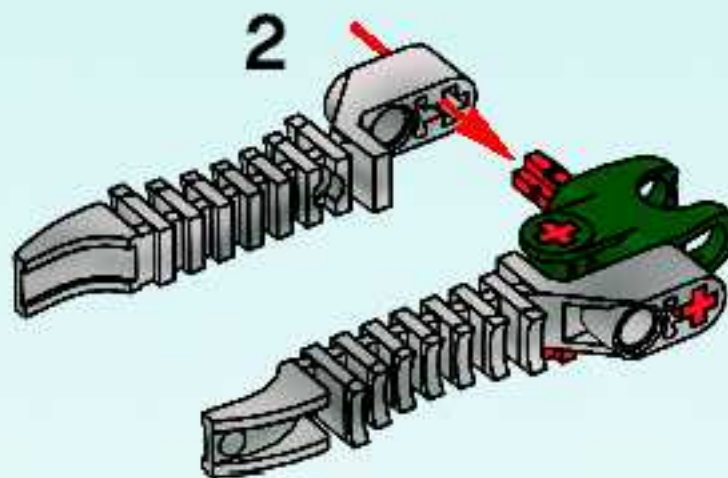
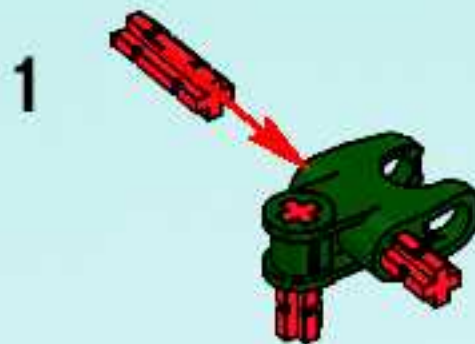

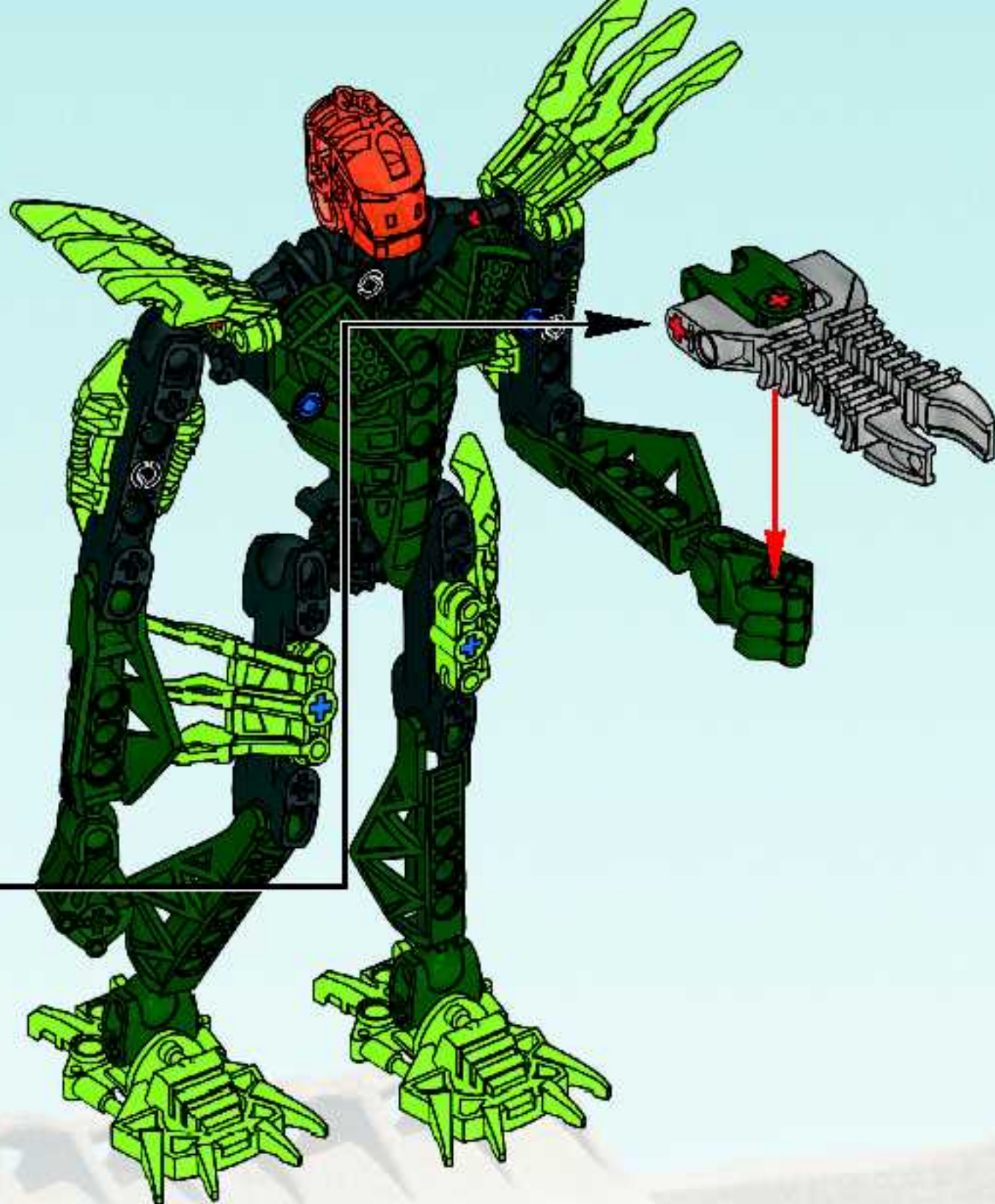

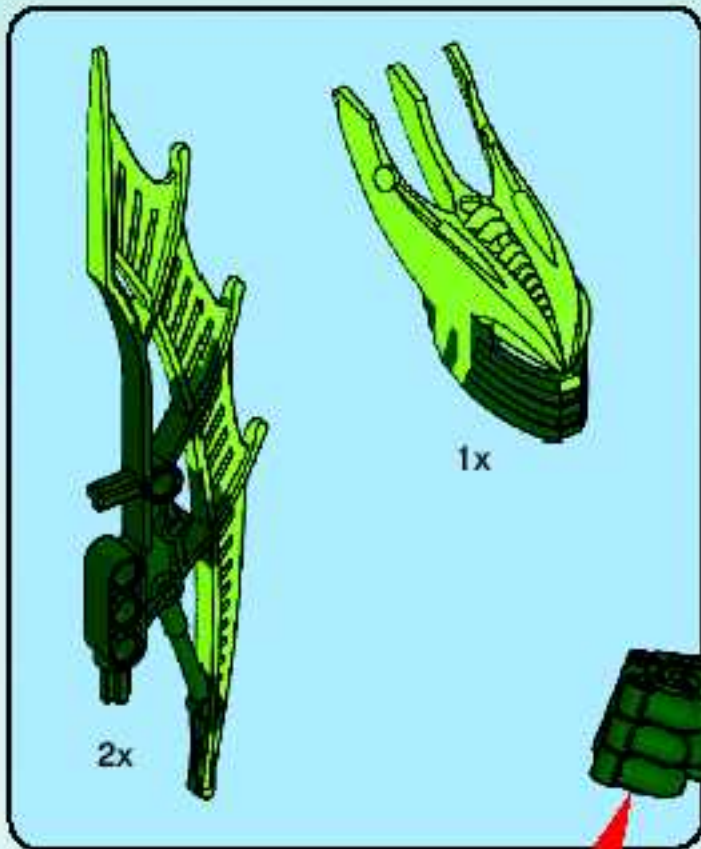

11

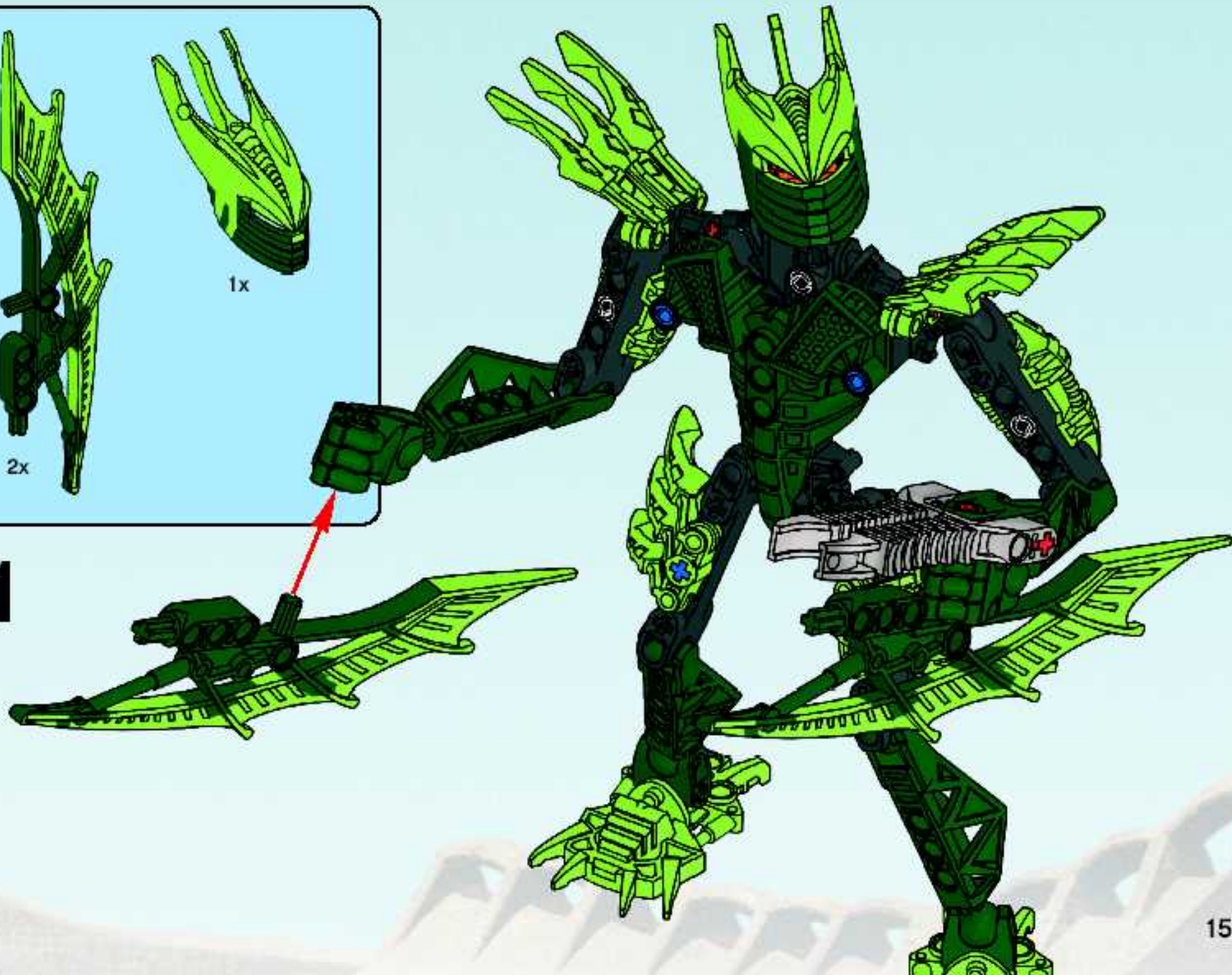



12

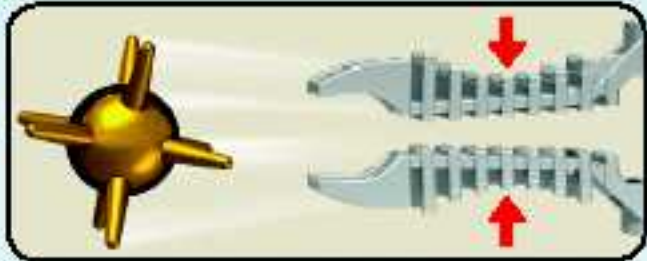
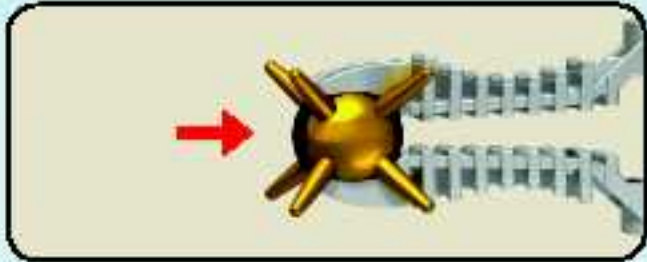



13

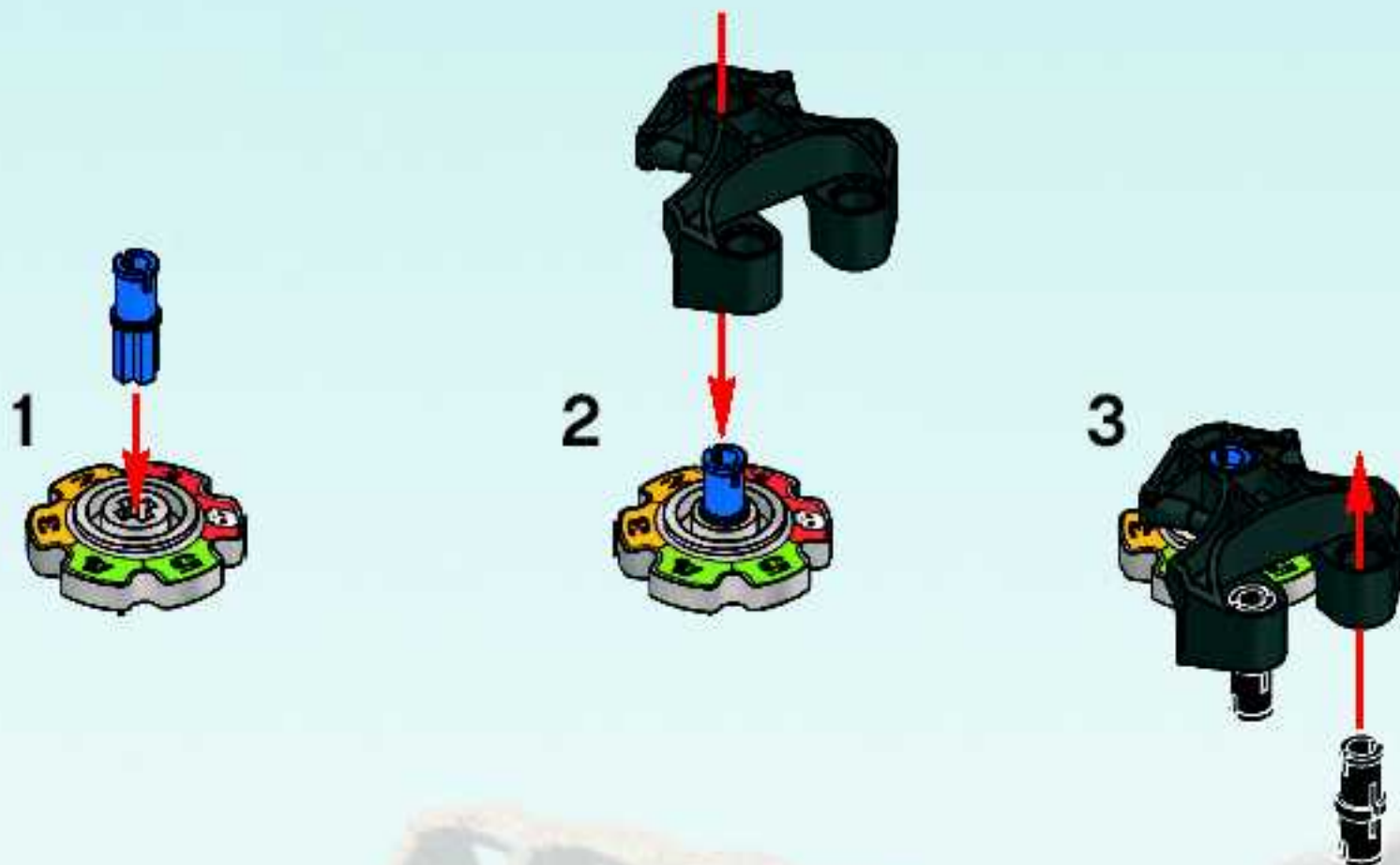





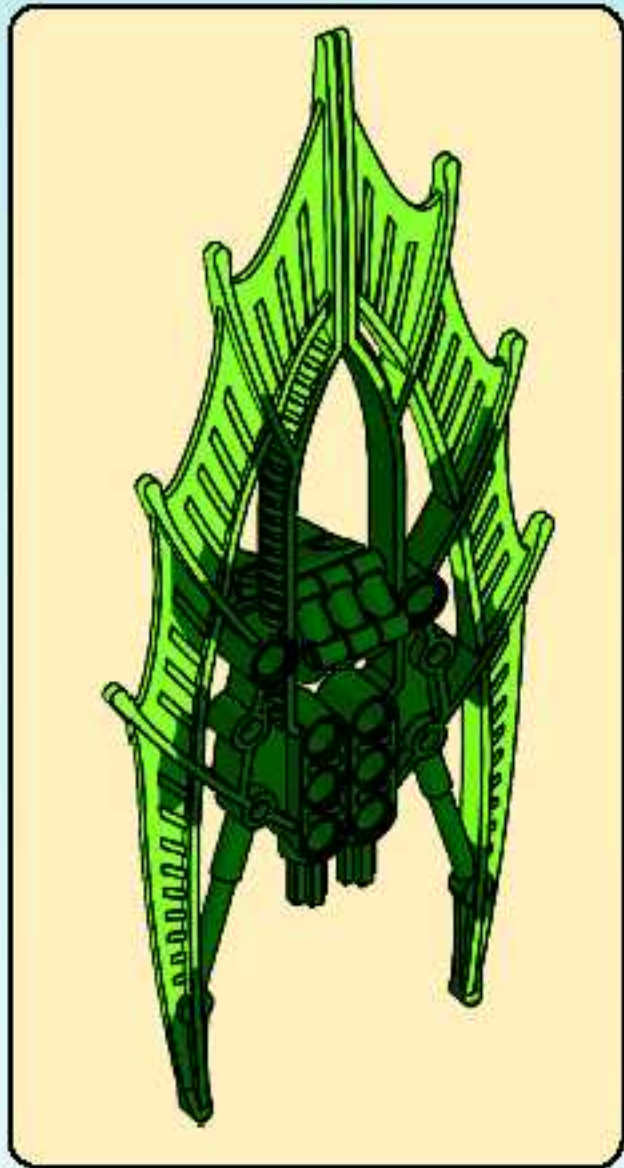



3x
4173970



1x
4537514



1x
4540599



4x
4519224



1x
4278585



1x
4292590



1x
4544529



5x
4121715



5x
4142865



1x
4540702



4x
4206482



4x
4514553



2x
4539225



4x
4541480



2x
4292598



1x
4537499



1x
4546585



3x
4526003



2x
4542715



4x
4543194



2x
4546416



2x
4537505



1x
4543004



Customer Service
Kundenservice
Service Consommateurs
Servicio Al Consumidor

www.lego.com/service or dial



: 00800 5346 5555

: 1-800-422-5346

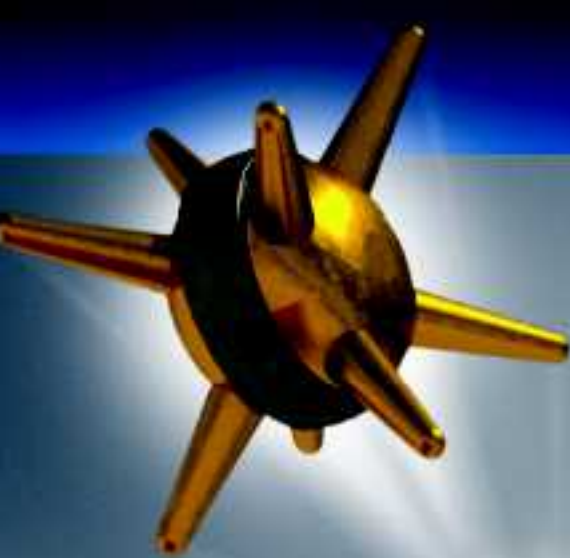

BIONICLE ACTION FIGURE
GAME



Setting Up Aufbau des Spiels

Règles du jeu Comenzar a jugar

This game is about taking the life of your opponent before he takes yours!

1. Set up the game using 2 cans & 2 figures
2. Set the dial to 5
3. Decide who goes first

Treffe Deinen Gegner und nimm ihm die Lebenspunkte, bevor er es tut!

1. Stelle zwei Dosen und zwei Figuren wie abgebildet auf.
2. Drehe die Lebenszähler an den Spielfiguren auf 5.
3. Entscheide, wer beginnt.

Pour remporter le combat, il faut que tu t'empares de la vie de ton adversaire avant qu'il ne s'empare de la tienne !

1. Délimite la zone de combat à l'aide des 2 boîtes et place les 2 figurines
2. Positionne ton compteur de vie sur 5
3. Décide qui commence

¡El objetivo de este juego es hacerse con la vida de tu oponente antes de que él se haga con la tuya!

1. Prepara el juego utilizando 2 botes y 2 figuras
2. Coloca el marcador en 5
3. Decide quién empezará



Playing the game: **POINTS** Punktvergabe bei einem Treffer

Comment jouer : **LE CALCUL DES POINTS**
Como jugar: **PUNTOS**

1. Hit can and opponent loses 1 life point or hit figure and opponent loses 2 points.
1. Wird die Dose getroffen, verliert der Gegner 1 Punkt, bei einem Treffer der Figur werden 2 Punkte abgezogen.
1. Si ta balle Spiky touche la boîte, ton adversaire perd 1 point de vie et si elle touche la figurine, ton adversaire perd 2 points
1. Si golpeas el bote, tu oponente pierde 1 punto y si golpeas la figura, tu oponente pierde dos puntos.



Playing the game: **MOVE**
Position der Spielfiguren

Comment jouer : **LES DÉPLACEMENTS**
Como jugar: **DESPLAZAMIENTO**

1. After shooting move figure to where ball lands.
1. Nach jedem Schuss wird die Figur dort abgestellt, wo die Dornenkugel gelandet ist.
1. Après avoir tiré, déplace la figurine à l'endroit où ta balle Spiky a atteri.
1. Después de disparar, mueve la figura hasta el lugar en el que haya caído la bola.



Winning the game
Gewinne das Spiel

Comment remporter le combat !
Como ganar

1. The first player to take all the opponent's life points wins!
1. Gewonnen hat der Spieler, der seinem Gegner als Erster alle Lebenspunkte genommen hat.
1. Le premier joueur qui s'empare de tous les points de vie de son adversaire gagne !
1. El primer jugador que se haya con todos los puntos de vida de su oponente ganará!



Team up
Spiele mit mehreren Figuren

Forme ton équipe !
Une al equipo



For more rules on advanced multi-figure game play - check out
Weitere Informationen und Anleitungen für coole Spiele mit mehreren
Figuren findest du unter

Retrouve toutes les règles du jeu multi-joueur sur

Para más información sobre instrucciones de juego avanzado con varias
figuras, consulta

www.BIONICLE.com

GLATORIAN BIONICLE®

FOR VICTORY - FOR GLORY - FOR POWER



LEGO



8972



8973



8974

www.BIONICLE.com



8975



8977



8976

FERO &
SKIRMIX

TUMA



8990



8991

www.BIONICLE.com

FREE! GRATIS! GRATUIT!





club
MAGAZINE™

www.LEGOclub.com



00800 5346 5555*        

  **1-866-534-6258 • 1-877-518-5346**

US & Canada only Canada seulement

* Free phone. Mobile charges may apply. * Numéro sans frais. Les frais peuvent s'appliquer avec les téléphones cellulaires.
* Gebührenfrei. Kosten für Anrufe aus Mobilfunknetzen können anfallen. * Gratis telefonnummer vanaf vast te lijn. * Det er et gratis nummer, når du ringer fra fast telefon.
* Dotar gratis, når du ringer fra en fast telefon.



VISIT THE WORLD'S
BIGGEST LEGO® SHOP!

www.LEGOshop.com



WIN LEGO® PRODUCTS

Fill out a survey and you might WIN a cool LEGO product!
NO PURCHASE NECESSARY

Open to all residents where not prohibited
Go to www.nielsen aim.dk/LEGO to fill out a survey for a chance to win a LEGO product.

WIN LEGO® PRODUCTEN

Vul een enquêteformulier in en maak kans op een cool LEGO® product!

Kopen niet nodig
Iedereen uit landen waar geen enquêteverbod geldt mag deelnemen.

Ga naar www.nielsen aim.dk/LEGO, vul een enquêteformulier in en maak kans op een LEGO product.

GEWINNE LEGO® PRODUKTE

Nimm an der Umfrage teil und GEMINNE ein tolles LEGO® Produkt!
Die Teilnahme am Gewinnspiel führt zu keinerlei Kaufverpflichtungen

Teilnahme in allen nicht ausgeschlossenen Ländern möglich
Wir verlosen unter allen Teilnehmern der Umfrage auf www.nielsen aim.dk/LEGO LEGO Produkte.

GAGNE DES PRODUITS LEGO®

Réponds à un questionnaire et tu pourrais GAGNER un produit LEGO® très cool !

Aucune obligation d'achat.
Ouvert à tous les résidents des pays autorisés.
Visite www.nielsen aim.dk/LEGO pour répondre à un questionnaire et avoir une chance de gagner un produit LEGO.

レゴ®製品を「当てよう」

アンケートに記入して、かっこいいレゴ®製品を当てよう！

お買い上げの必要はありません。
禁止されていない限り、すべての皆様にご利用いただけます。

www.nielsen aim.dk/LEGOにアクセスして、アンケートにご記入ください。当選者にはレゴ®製品を差し上げます。

