



POWER MINERS

8191





3

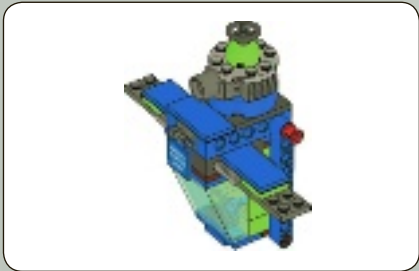

1x

1



1x

1x

2



1x

2x

3



1x

2x

4





5

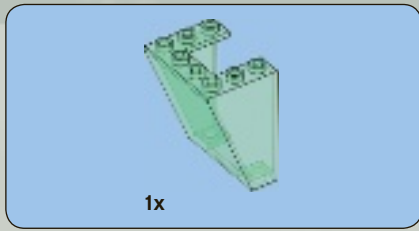
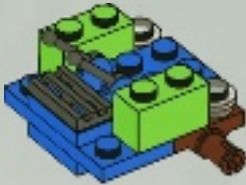

7

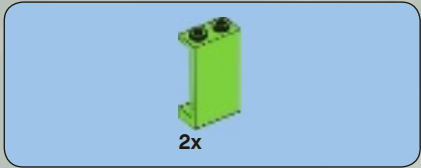
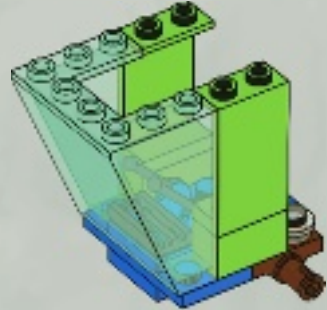

6

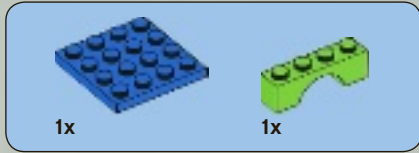
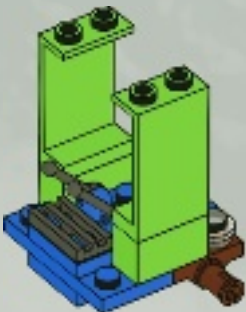

8

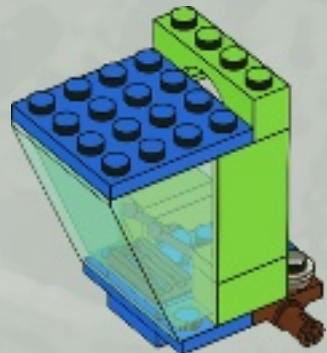



9

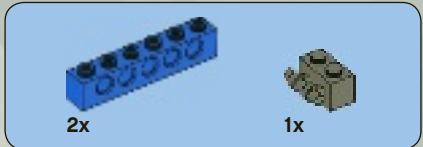
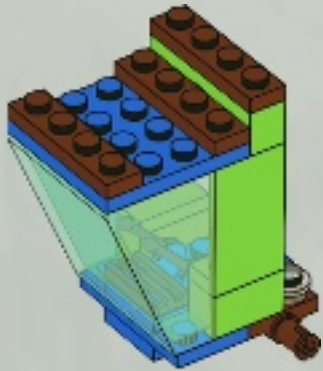

11

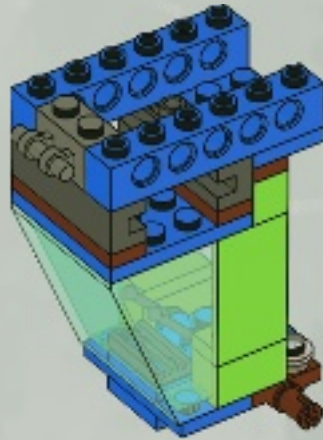

10

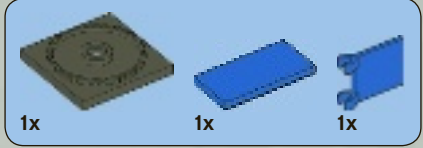
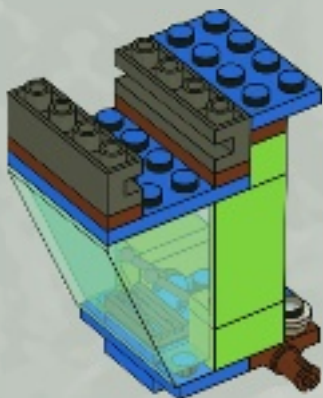

12

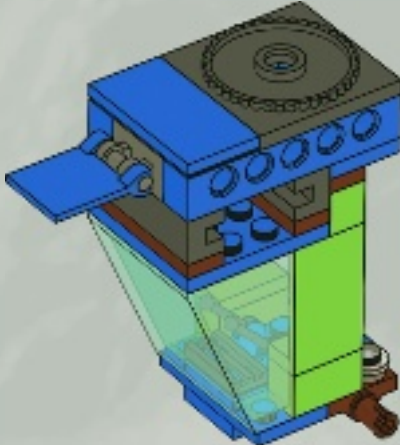

13

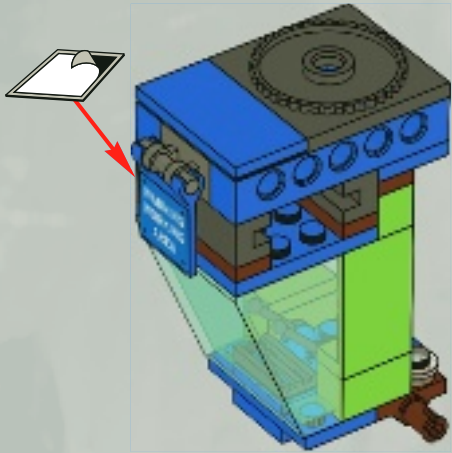

14

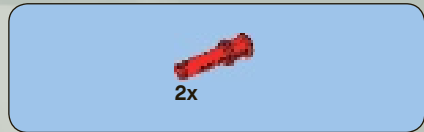
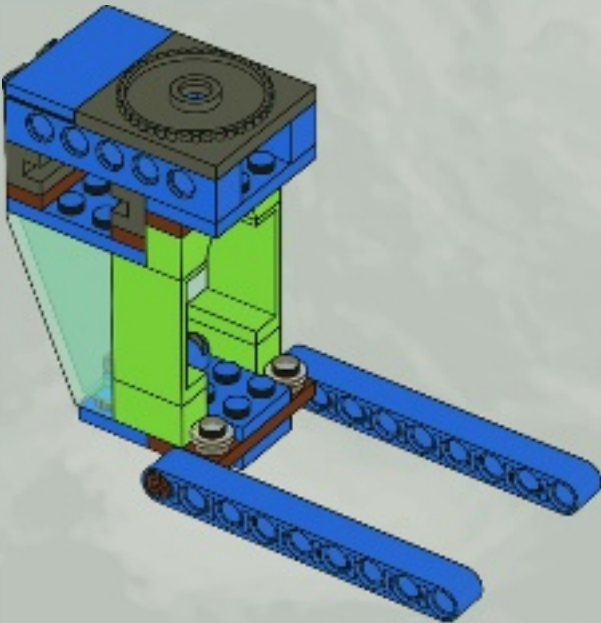

15

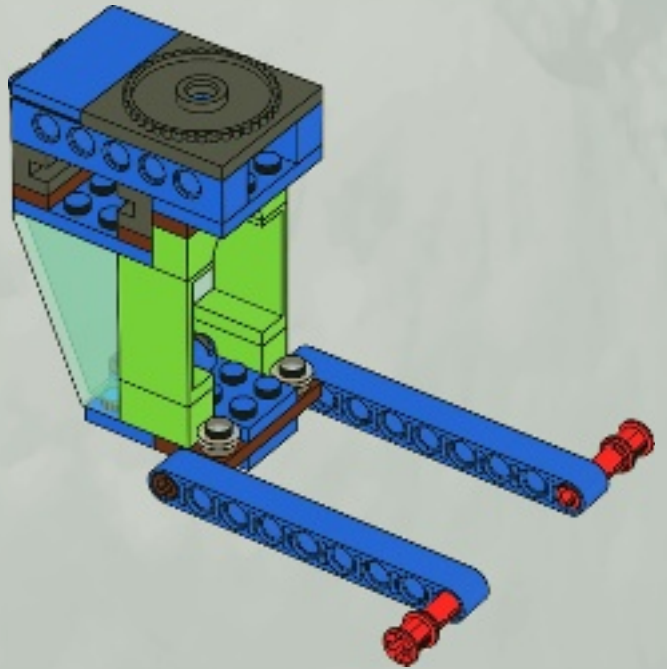

16

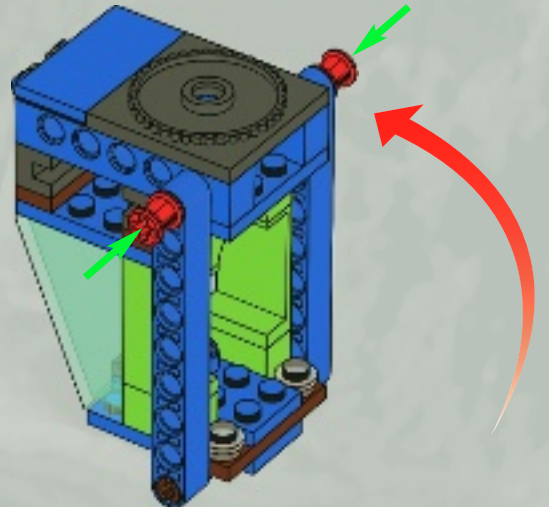

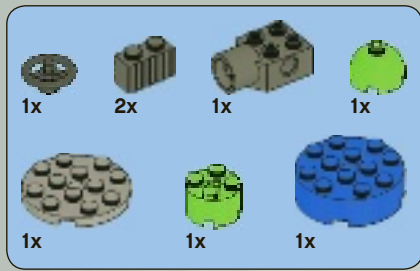

17

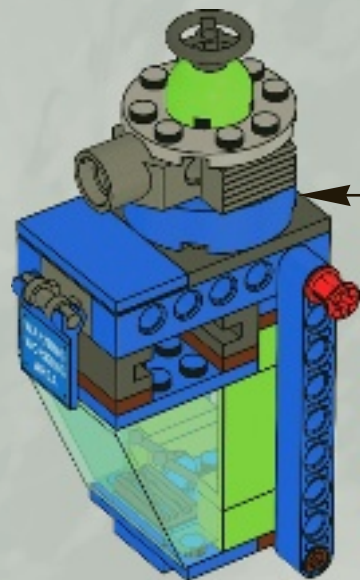
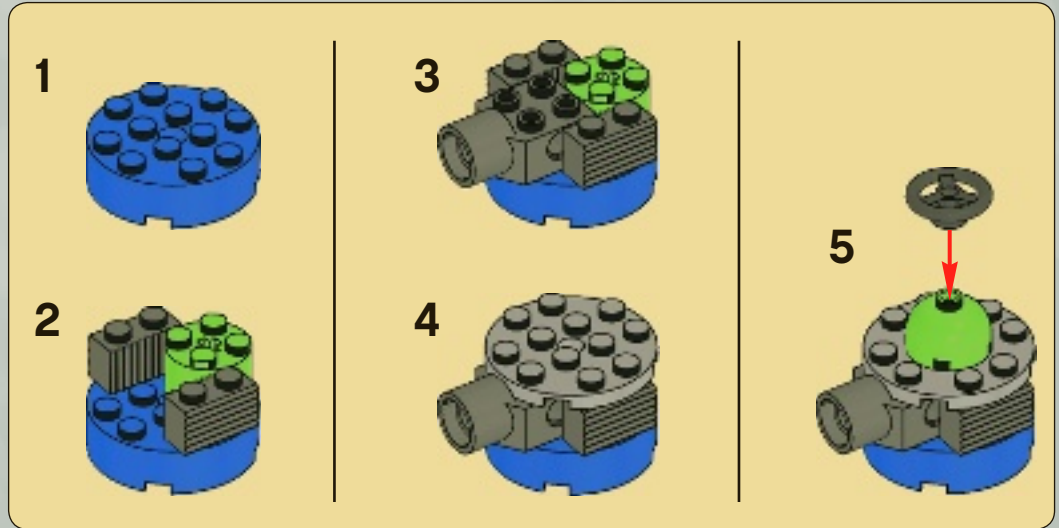

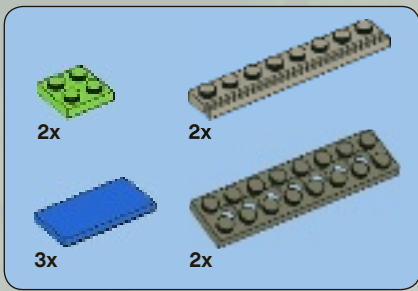

18

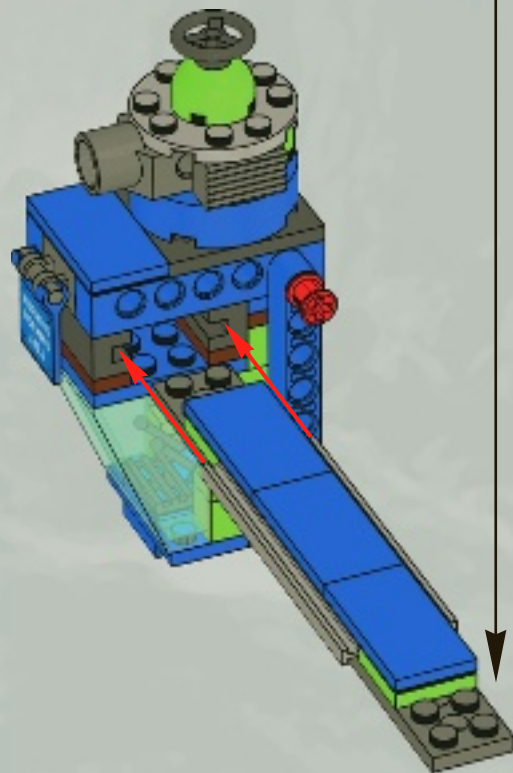
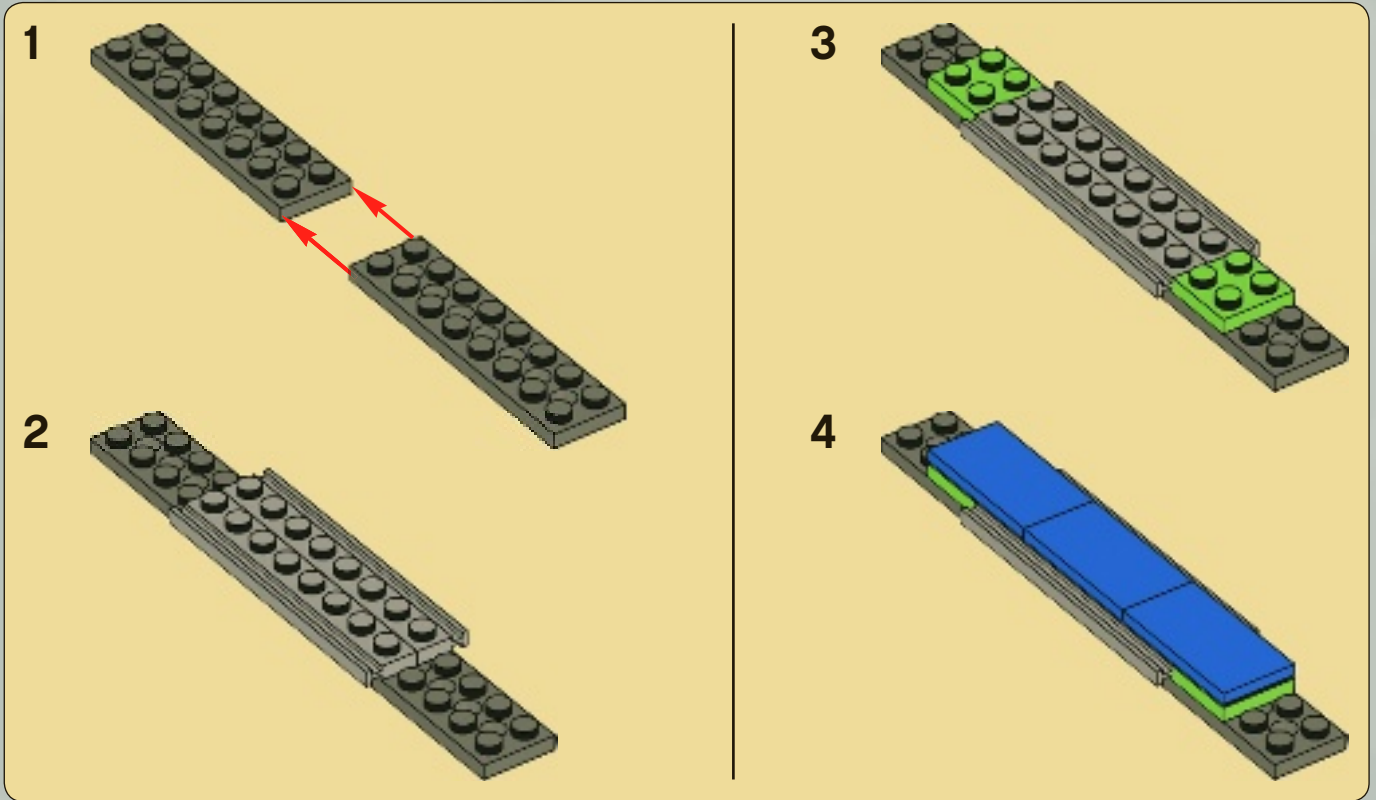

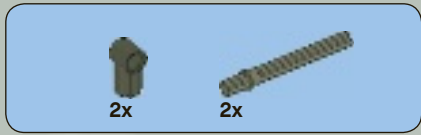

19

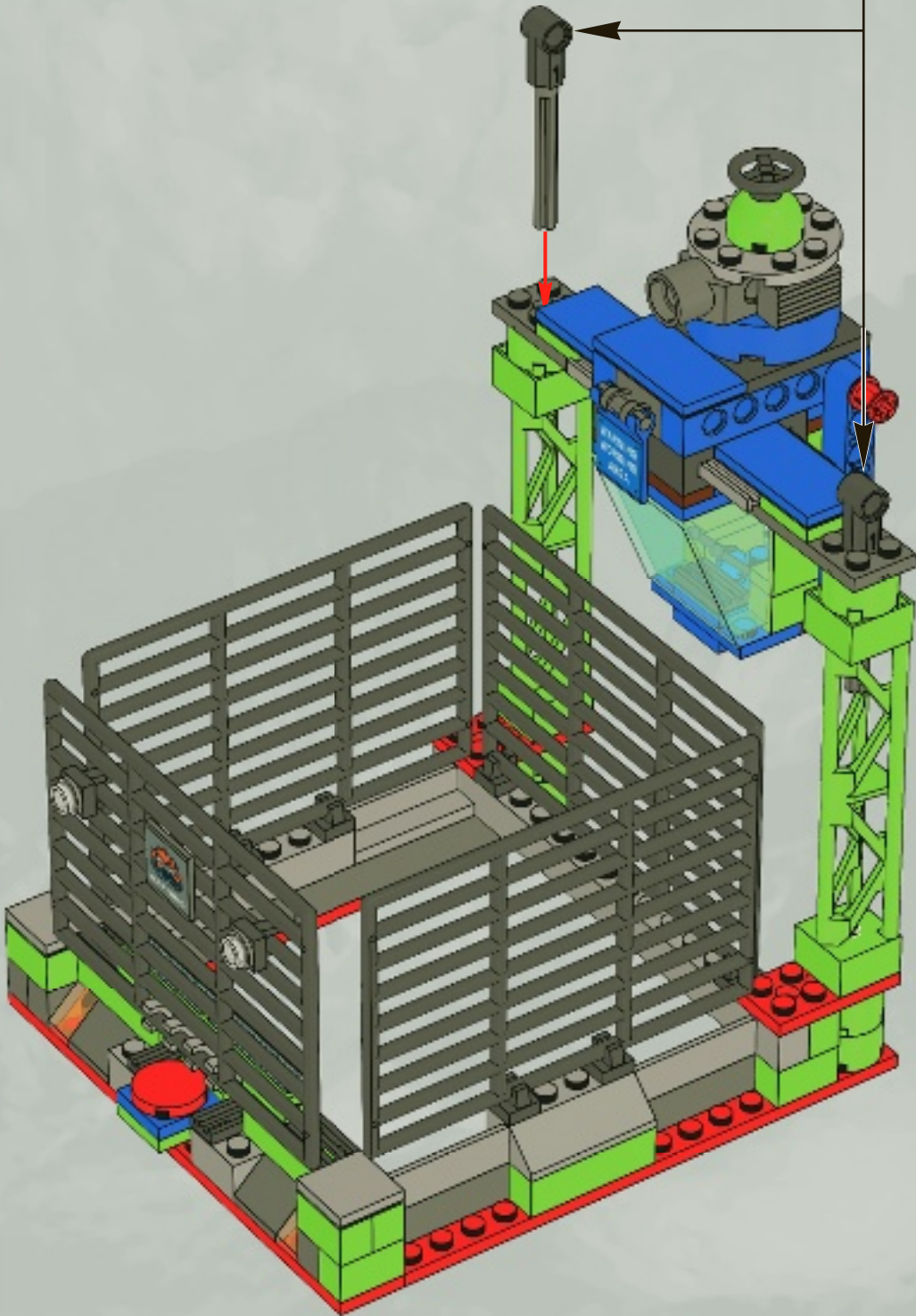
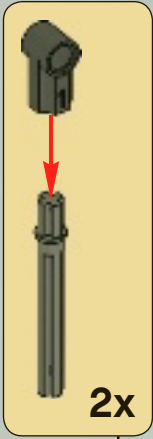

2x 8x 2x

20

1

2

3

2x

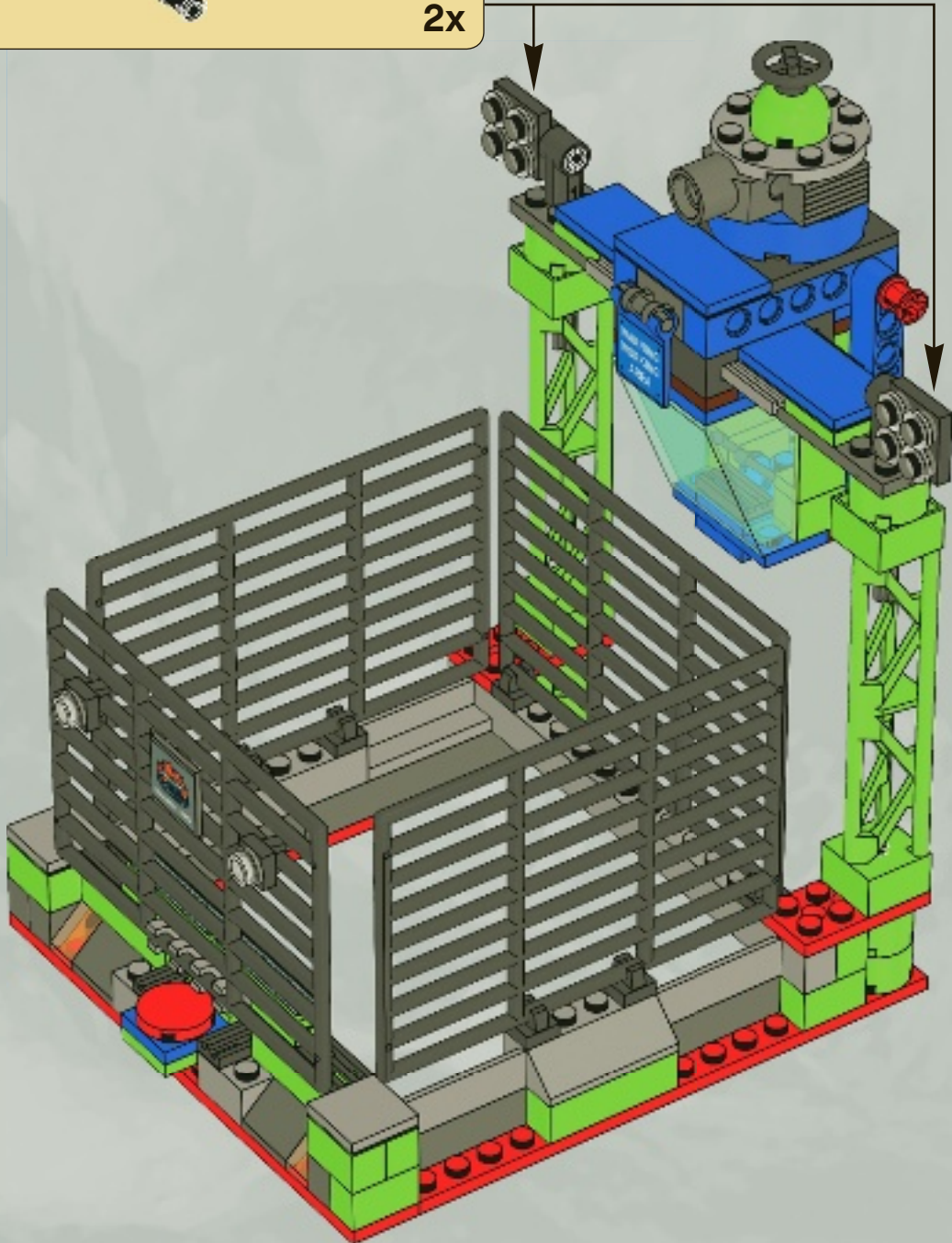

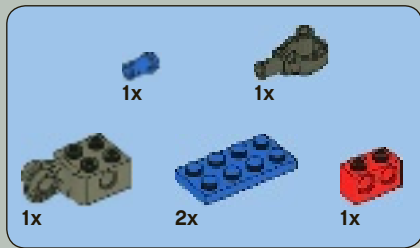

21

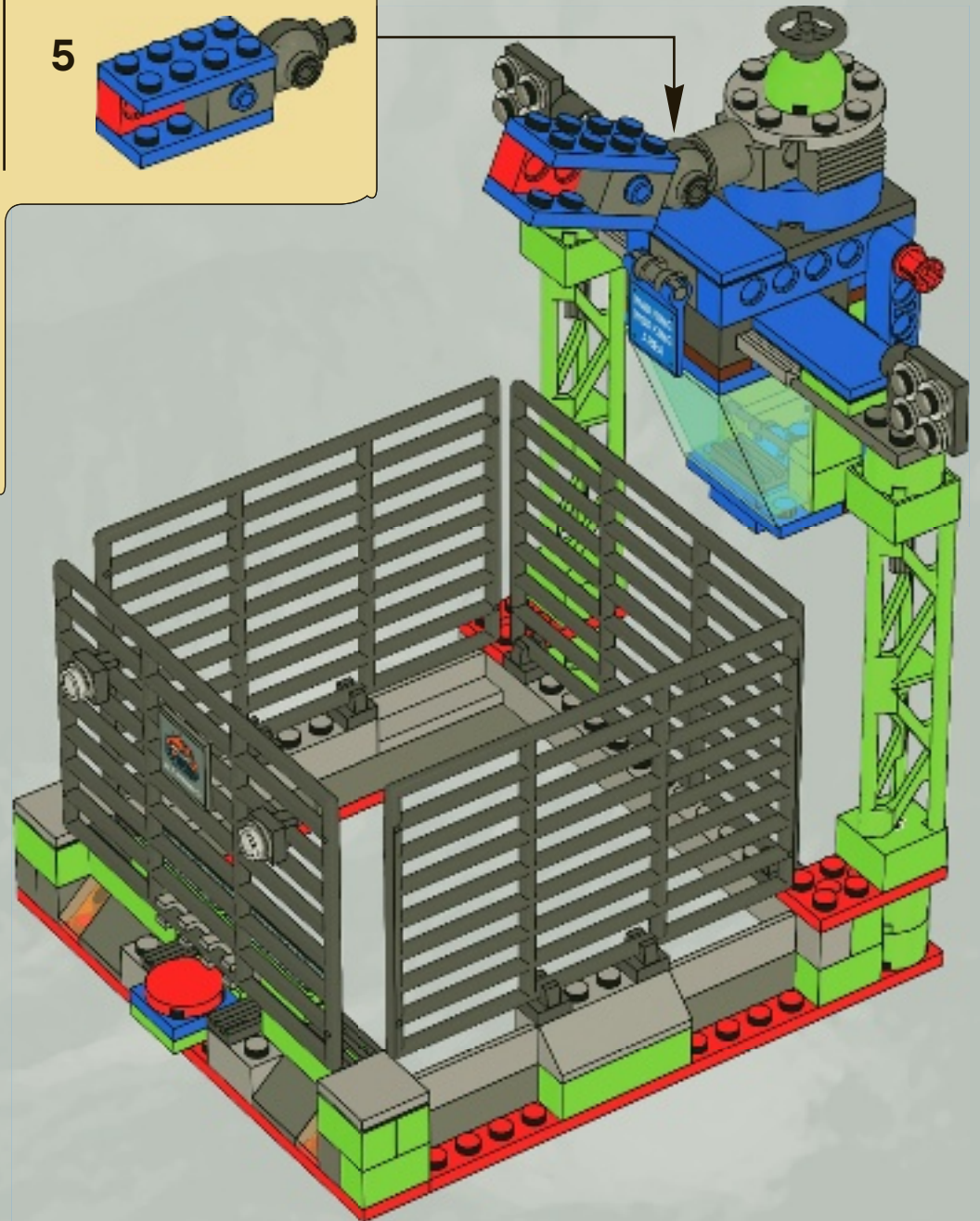
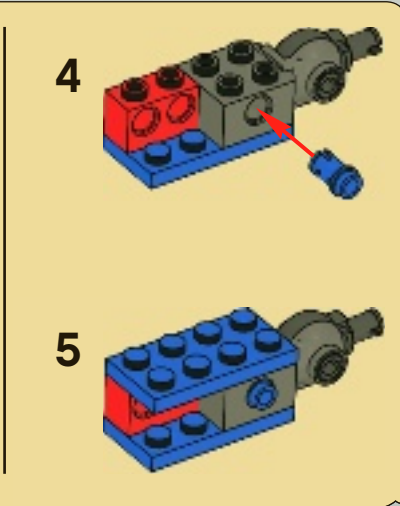
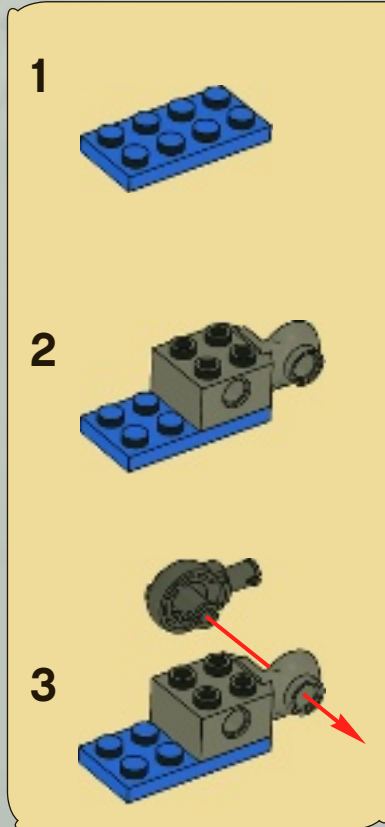

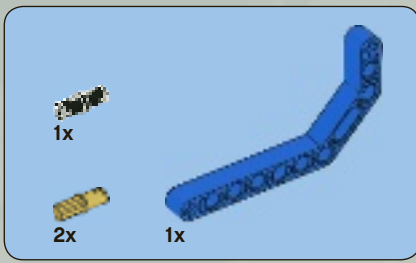

22

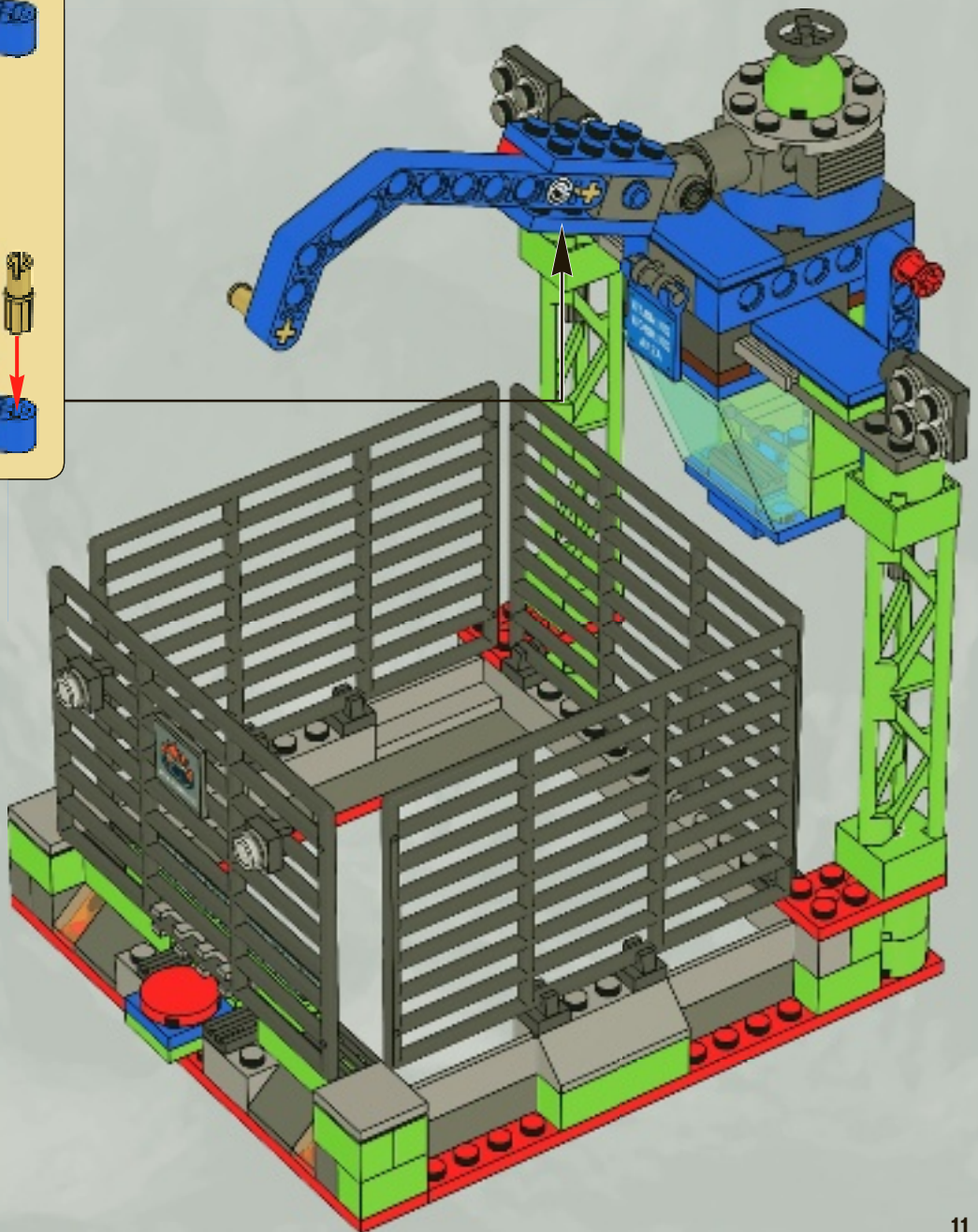
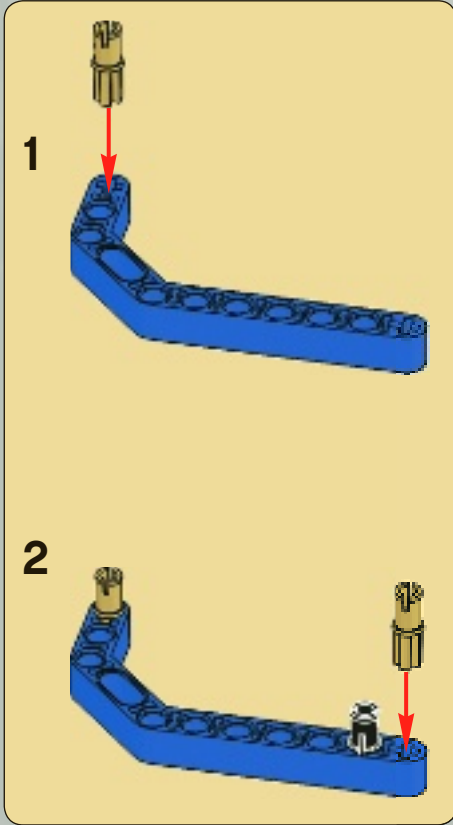



23

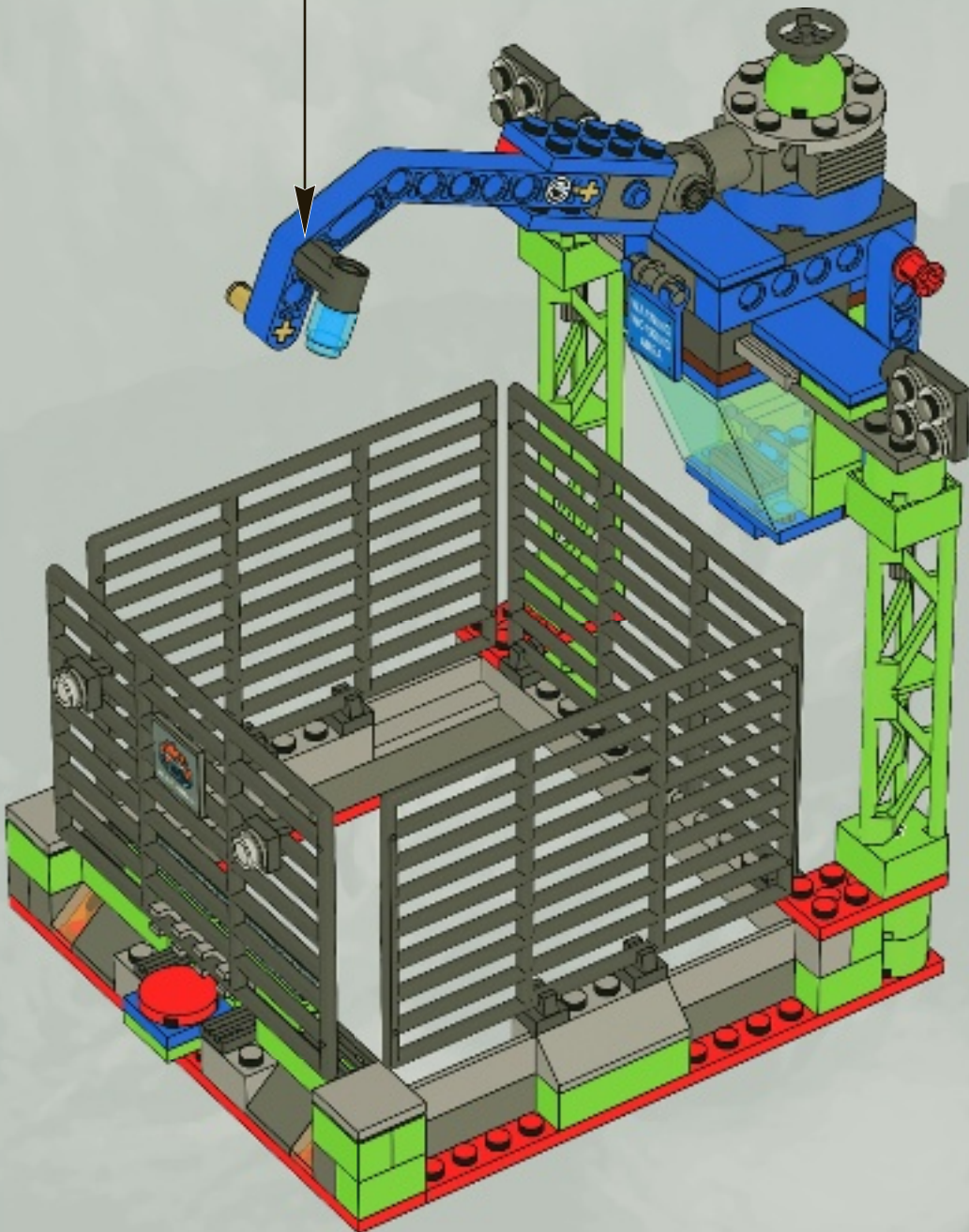

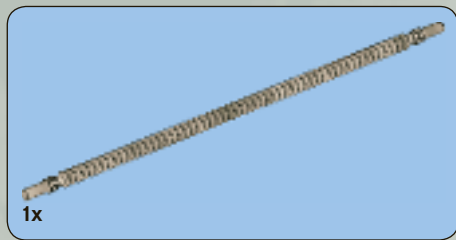

24

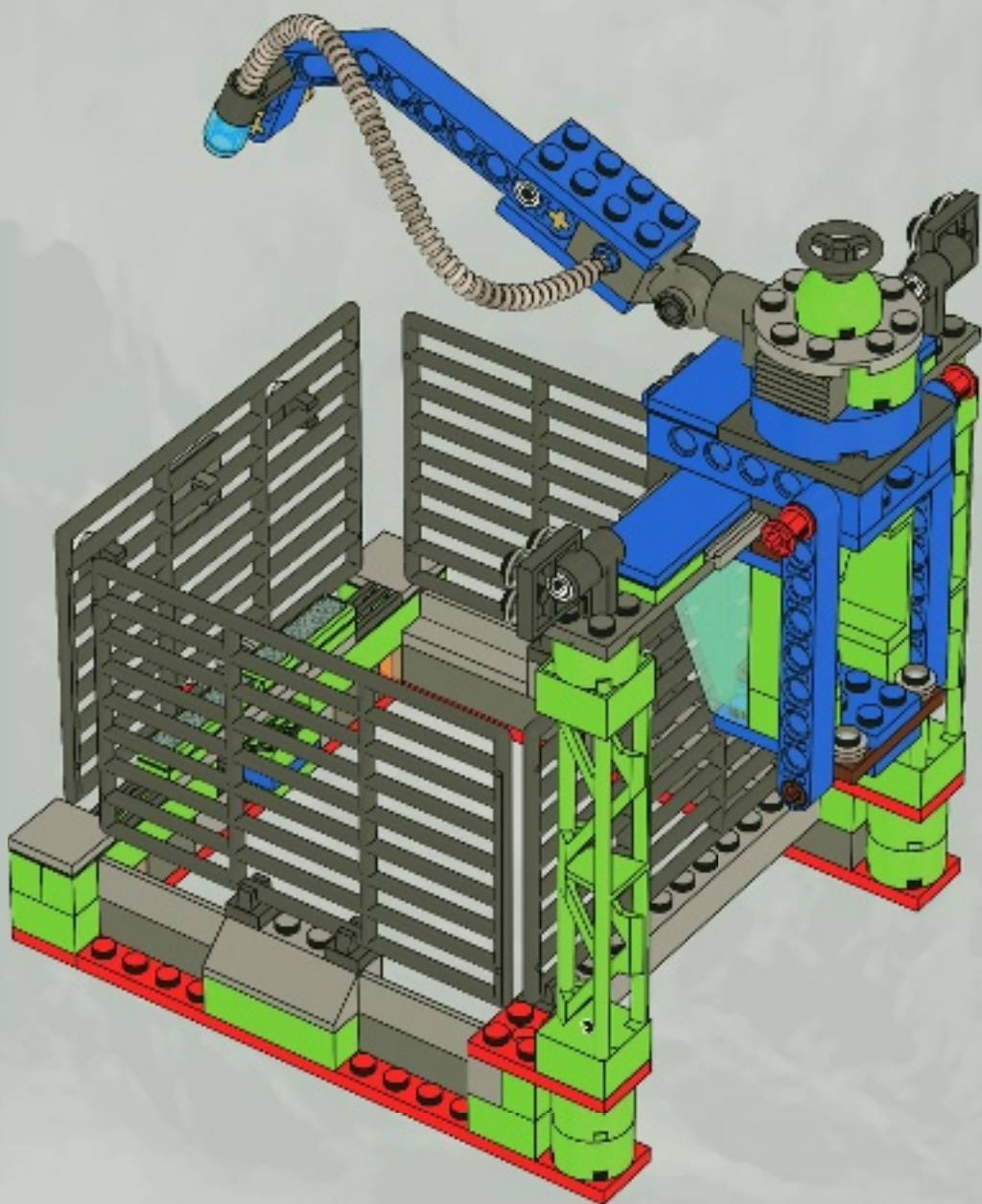



1



2

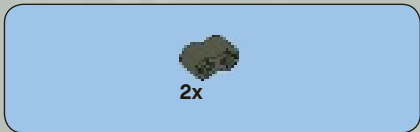

3

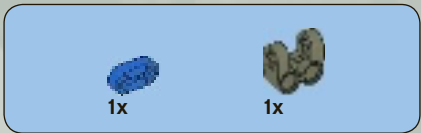

4

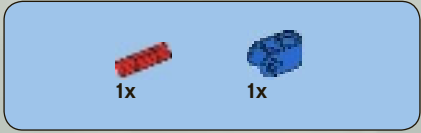

5

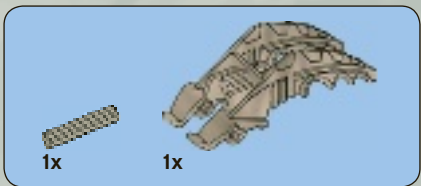
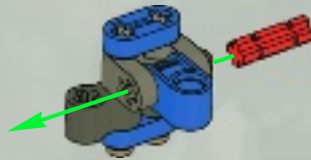

6

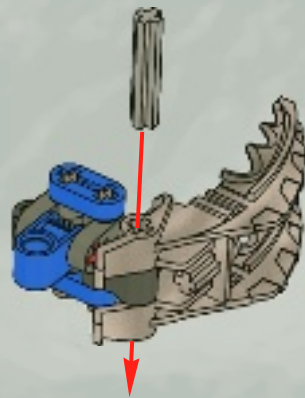

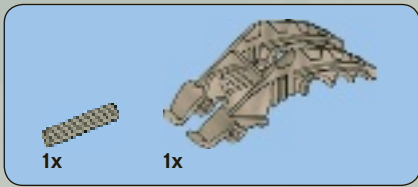

7

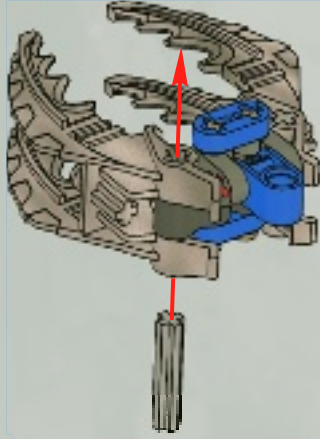

25

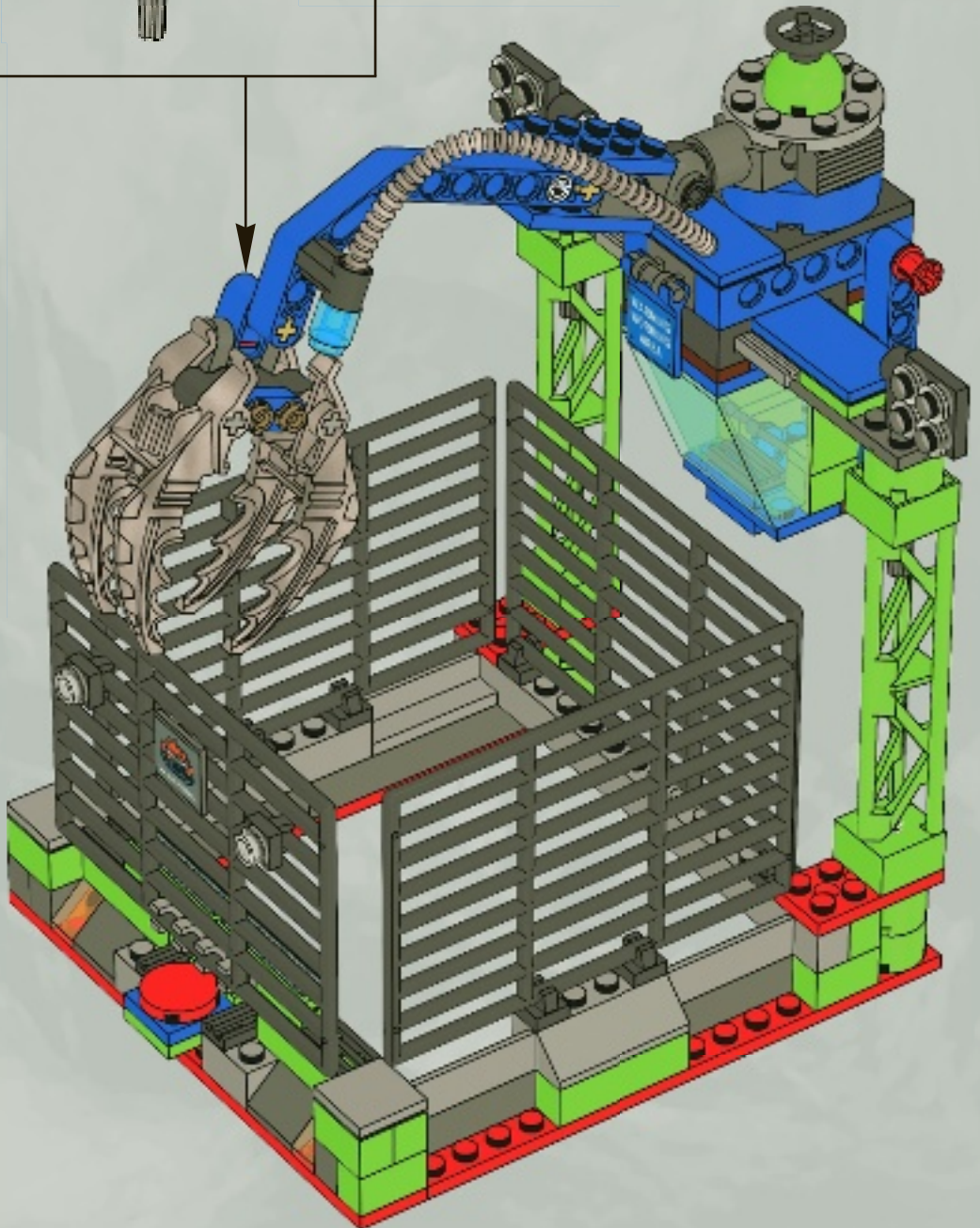

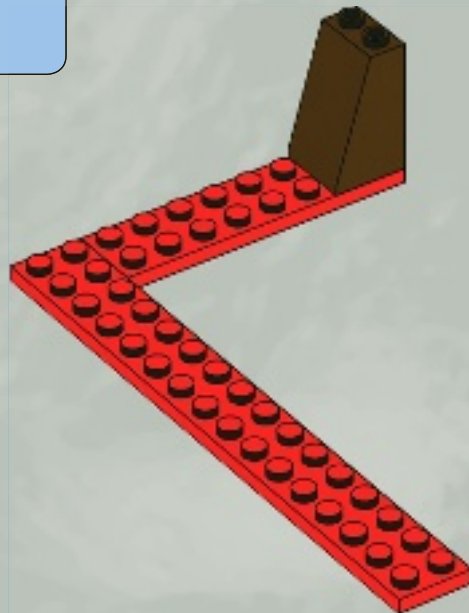
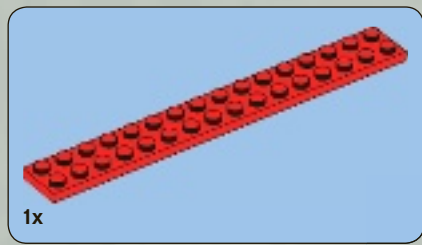
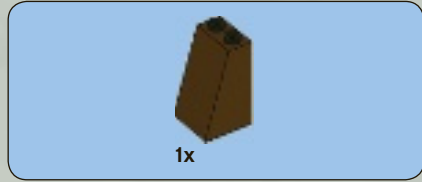
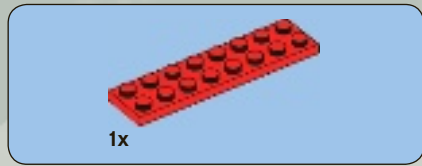
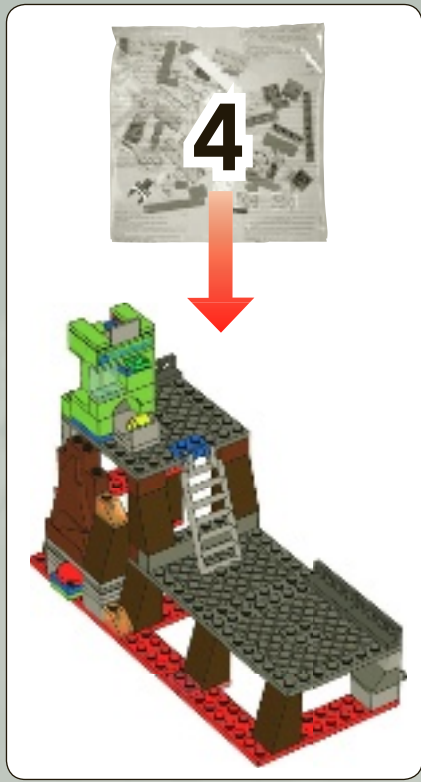



4

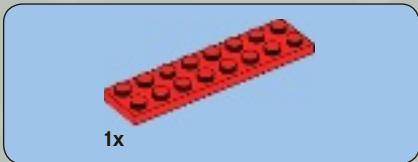
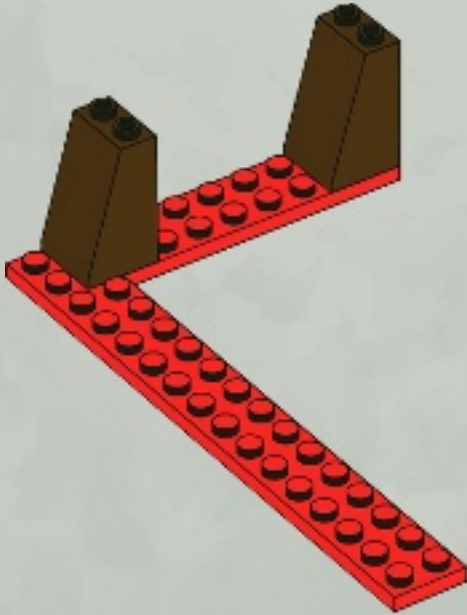

5

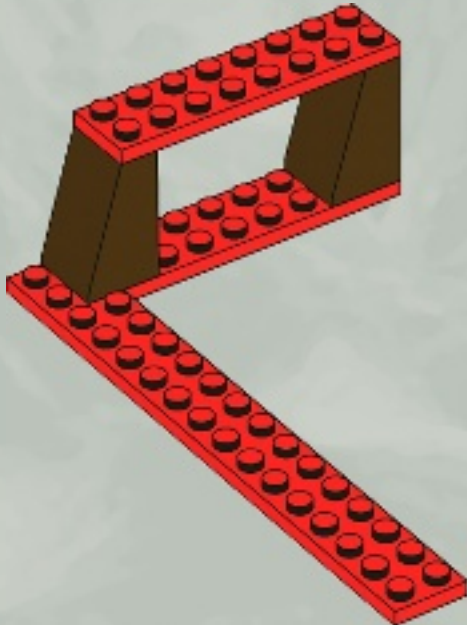



6

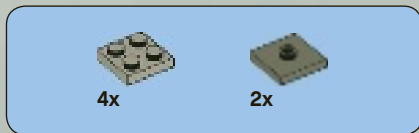
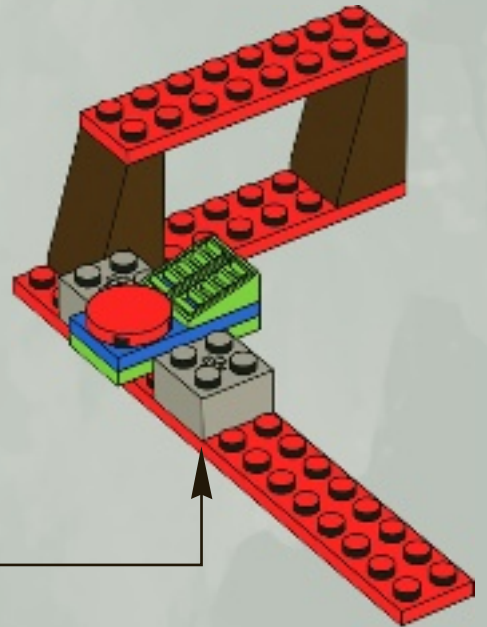
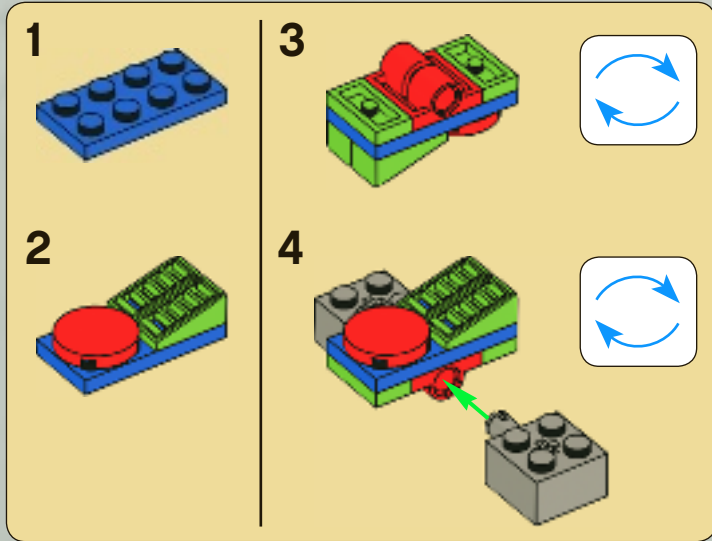

7

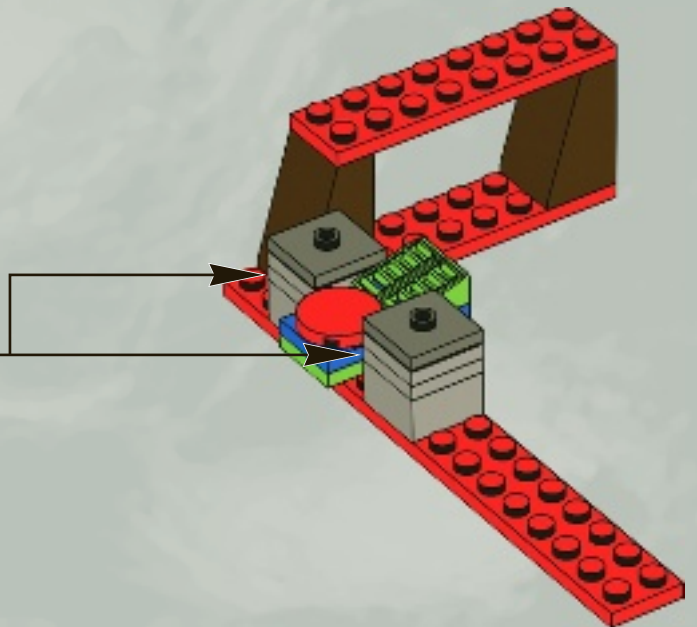
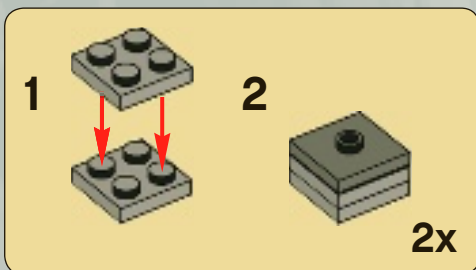

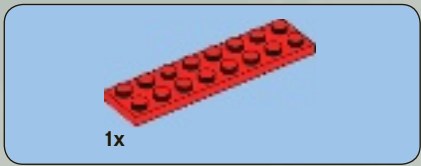

8

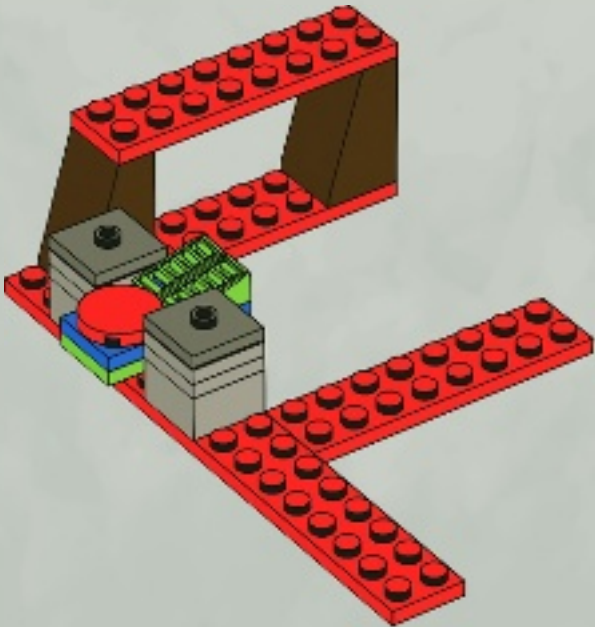

9

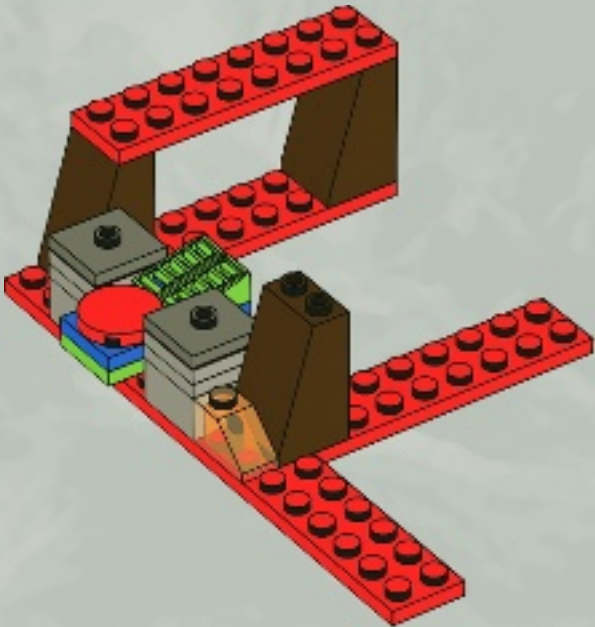

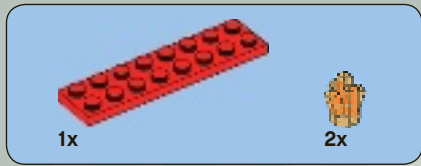

10

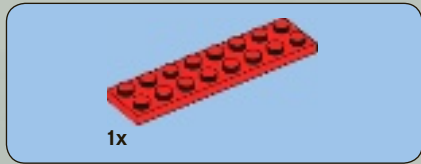
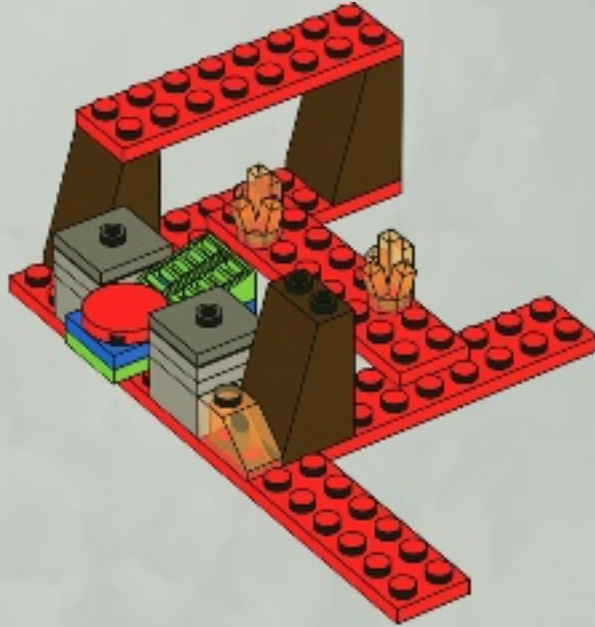

11

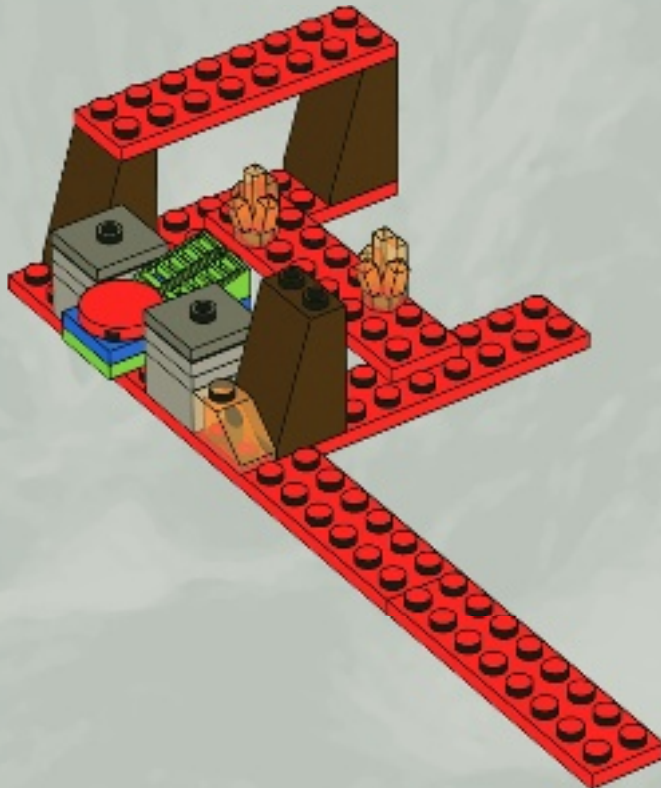



2x

12

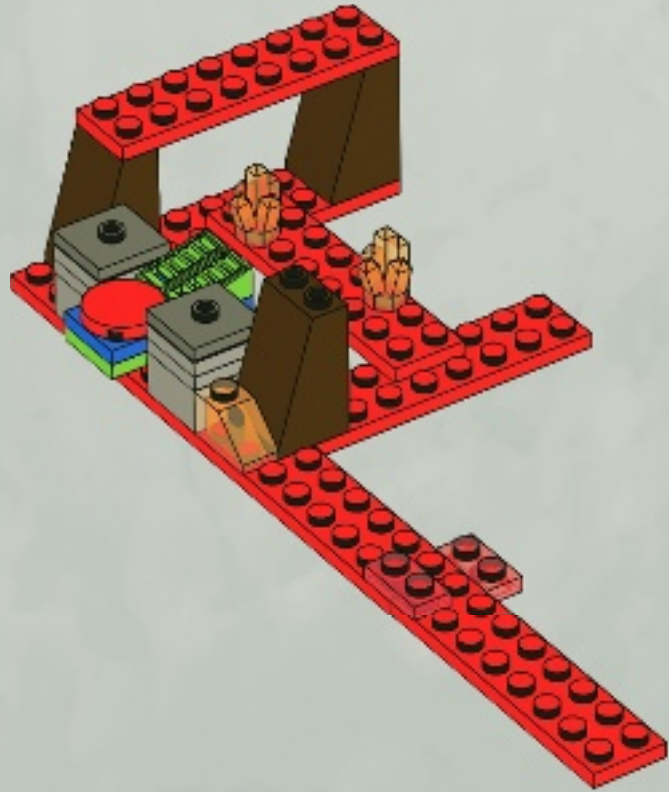

1x

13

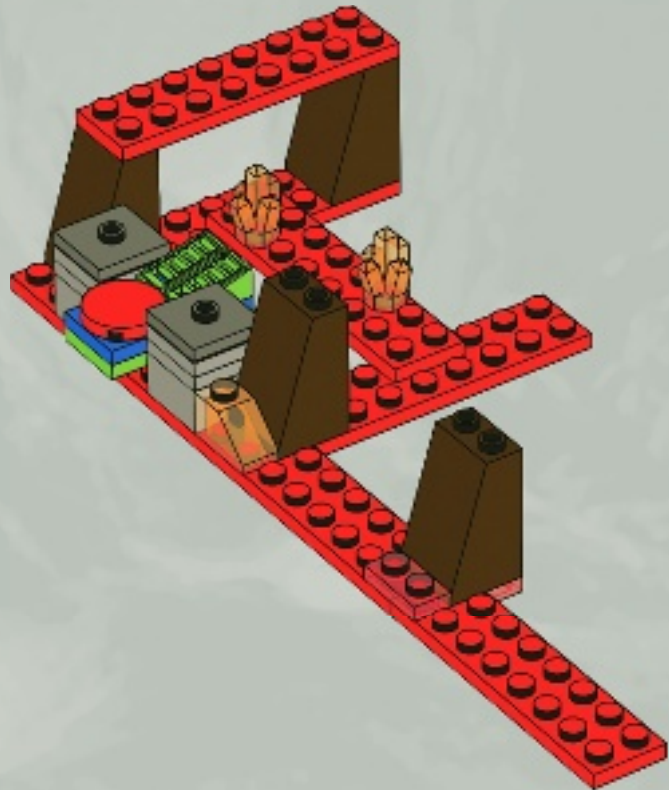

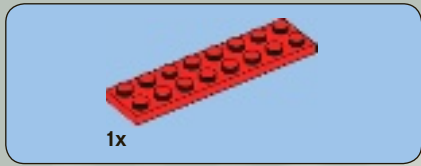

14

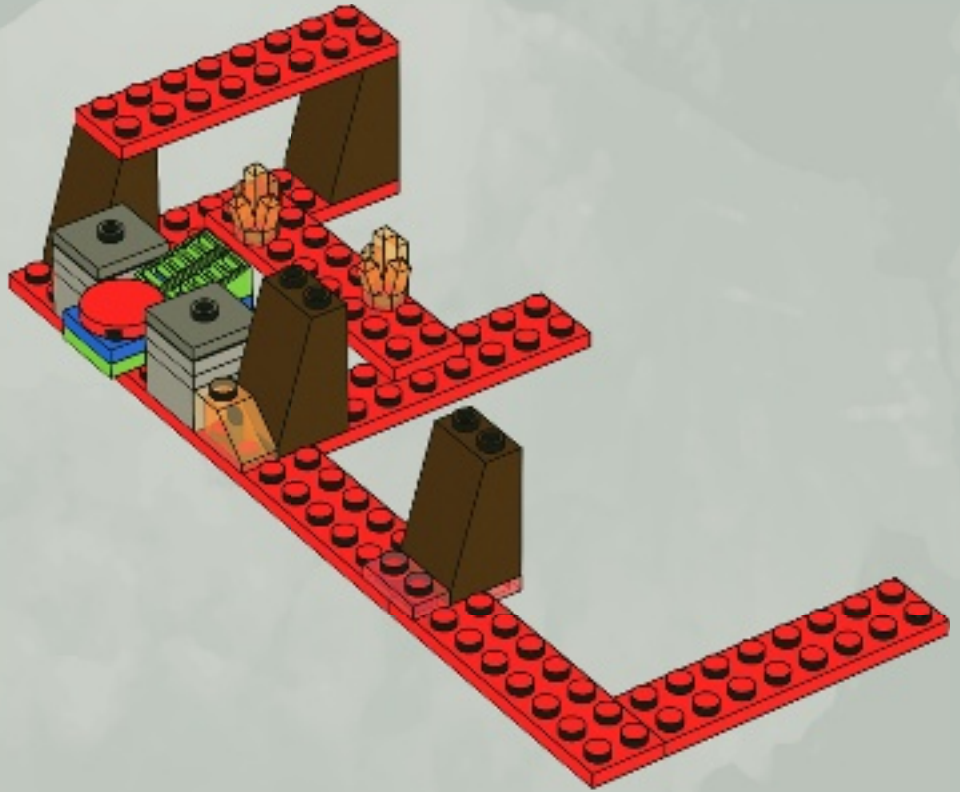

15

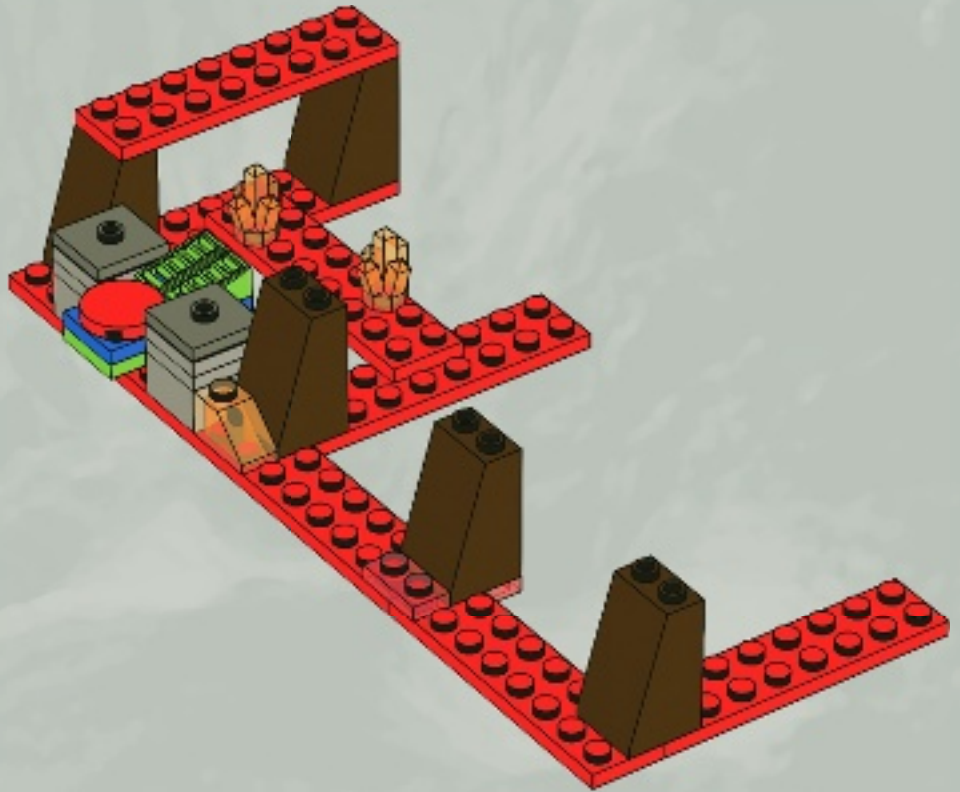



2x

16

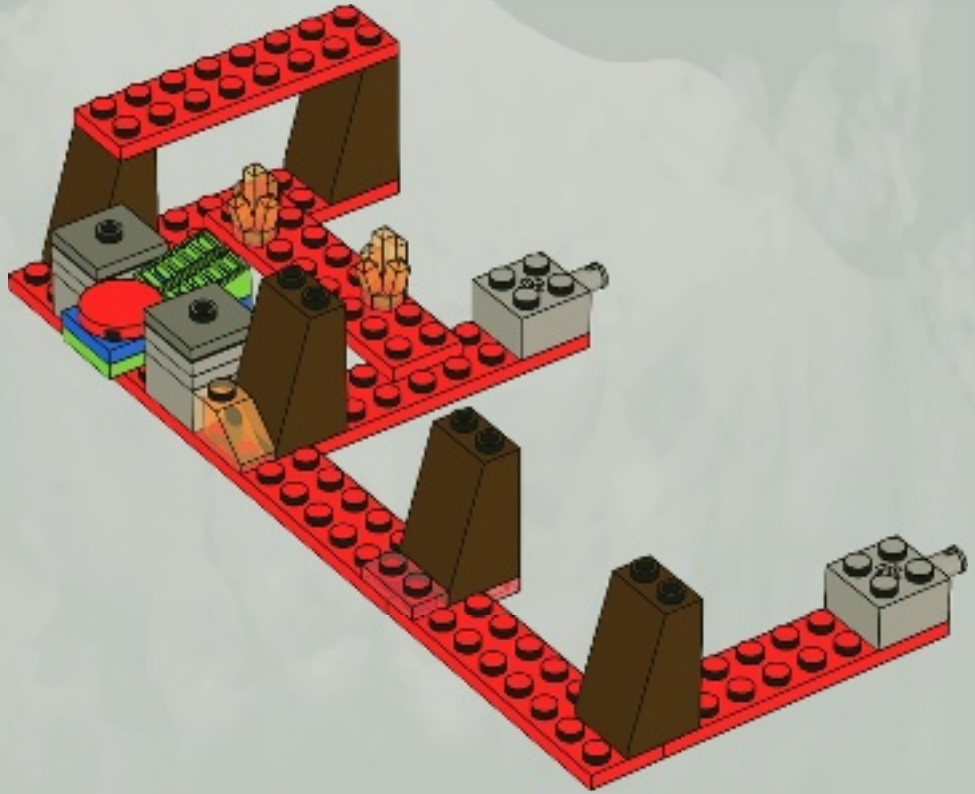

2x

17

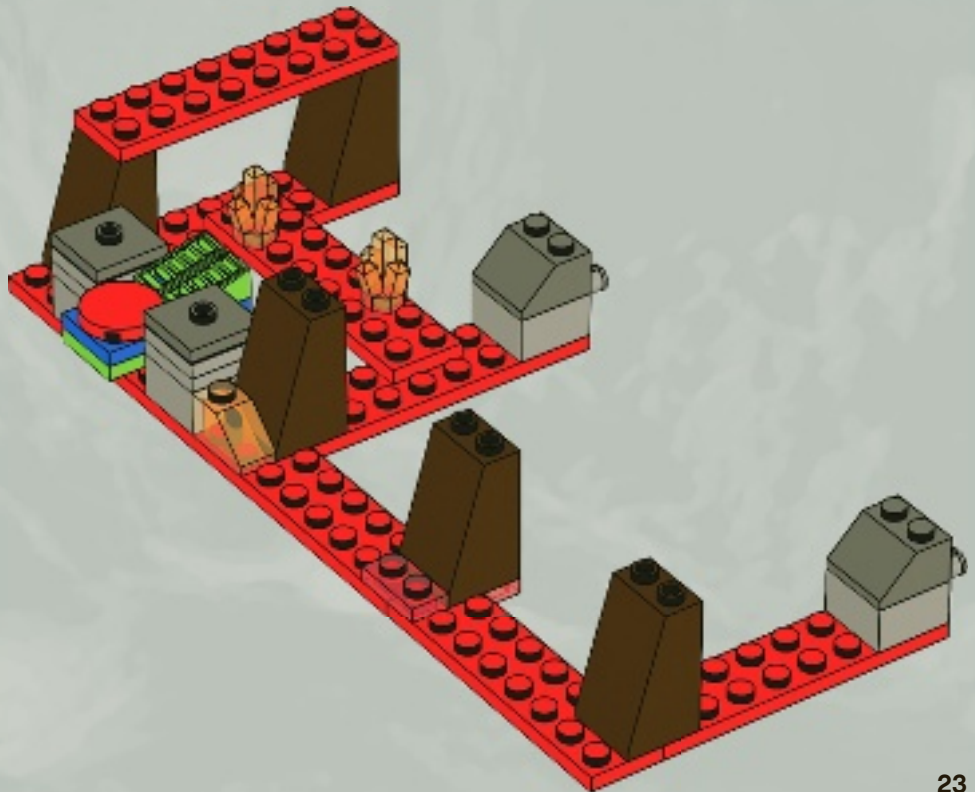

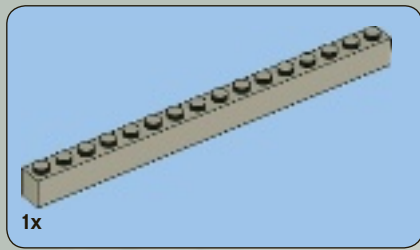

18

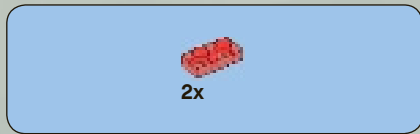
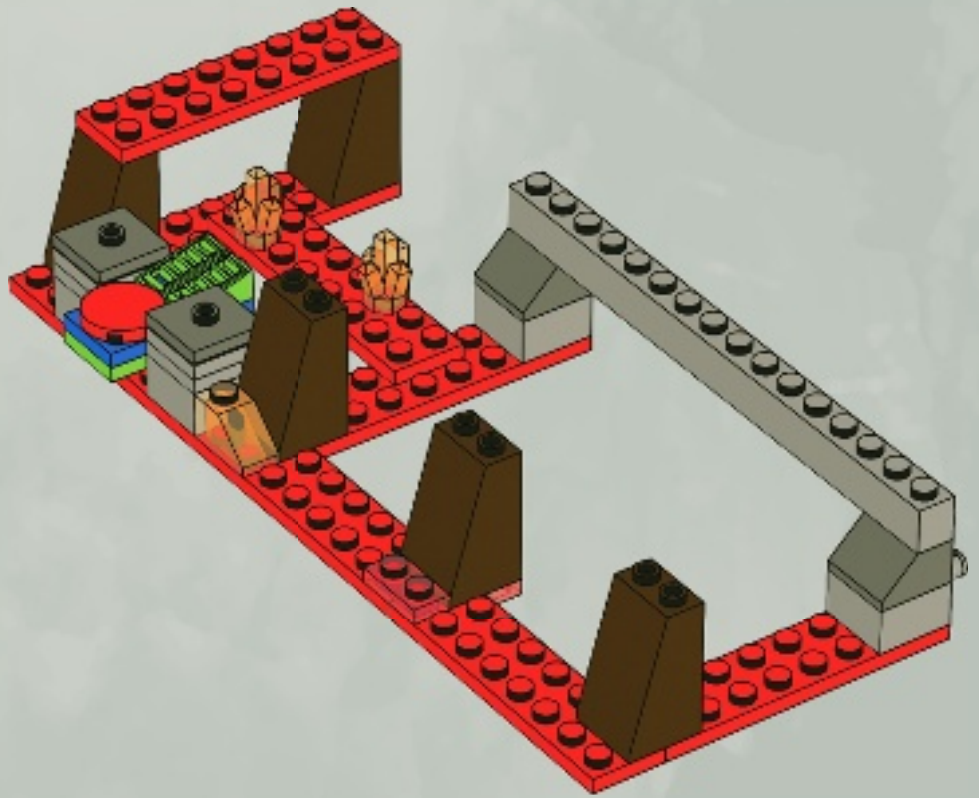

19

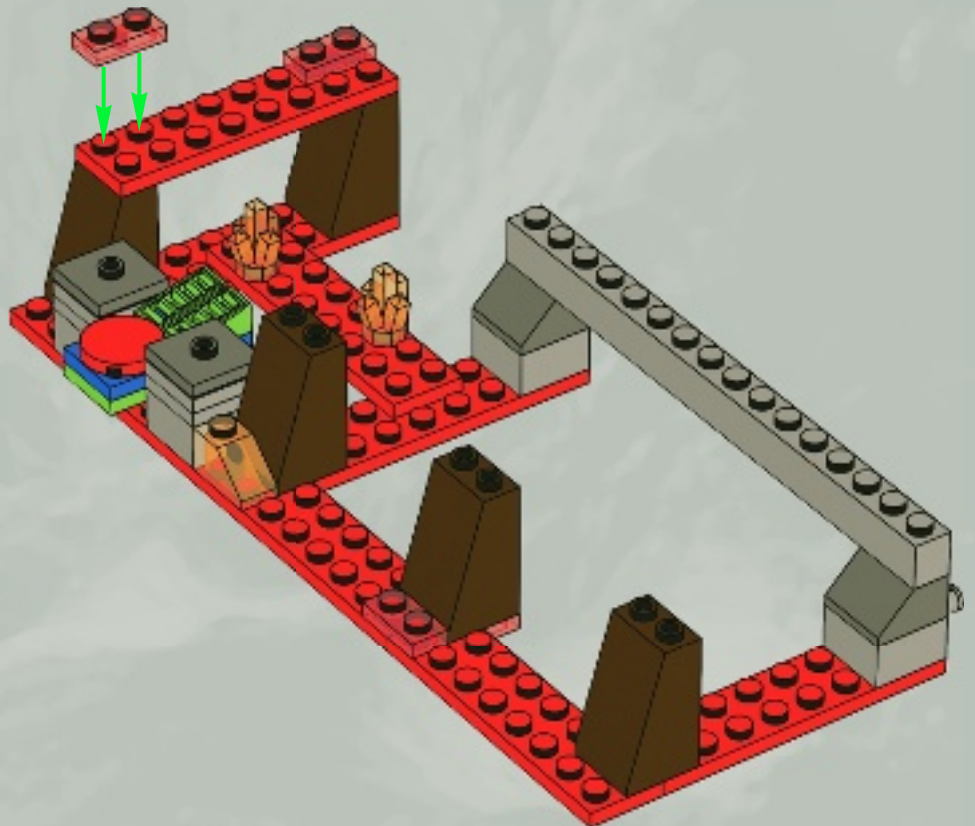

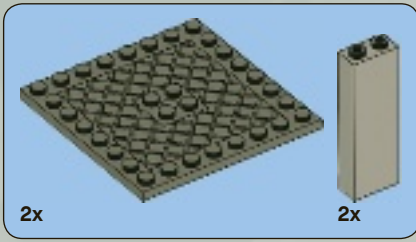

20

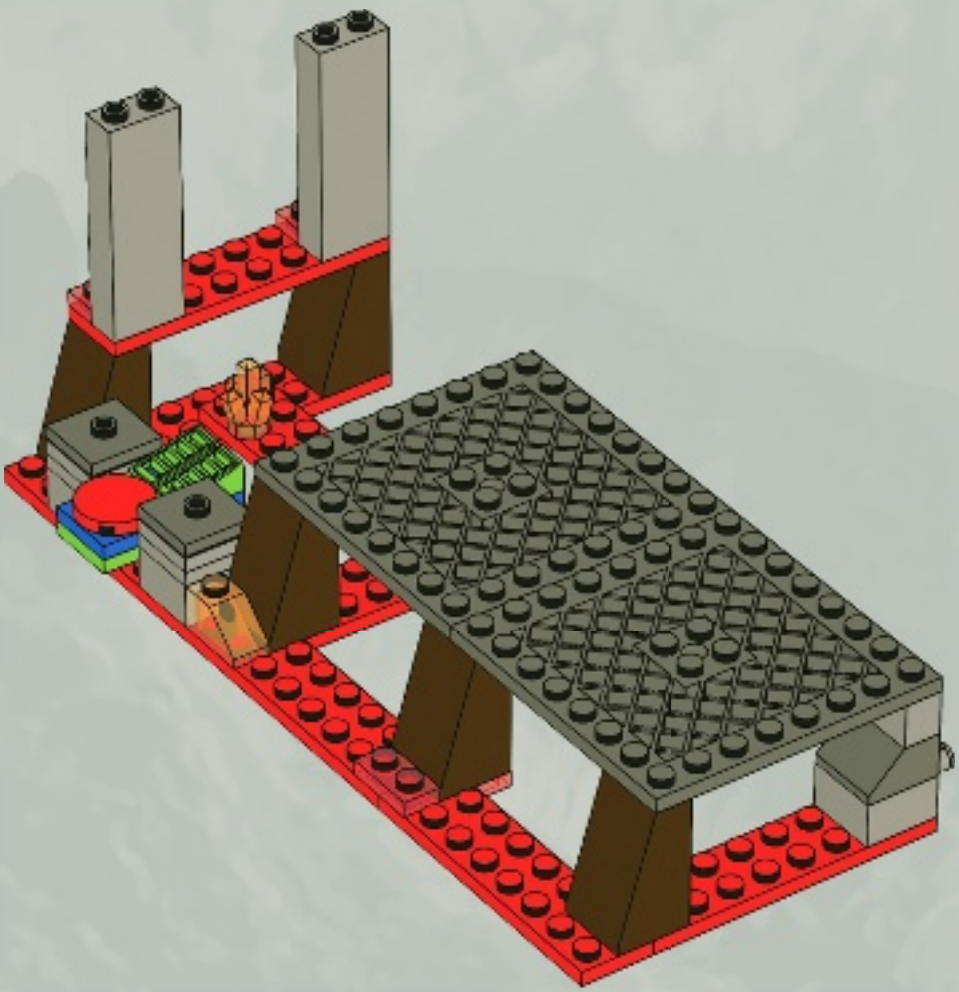

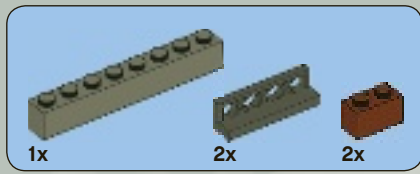

21

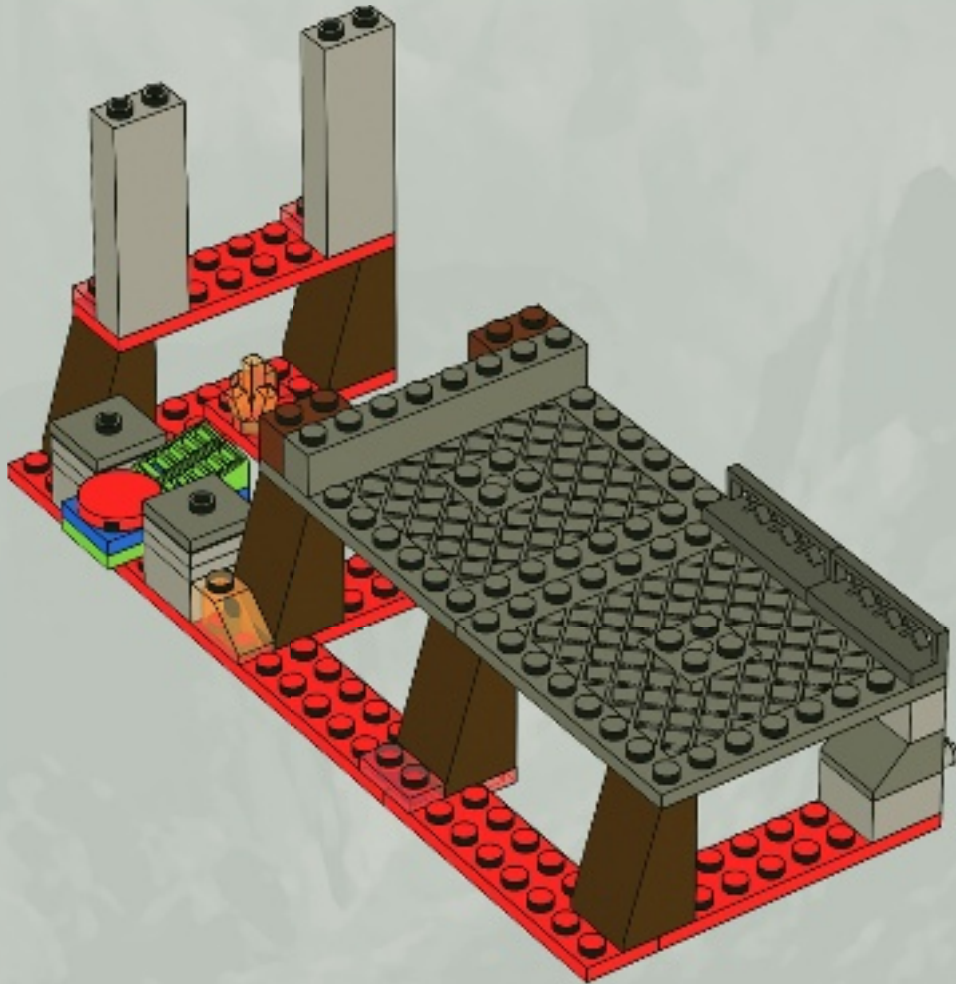

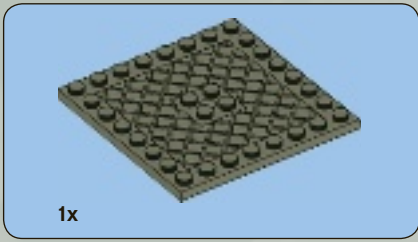

24



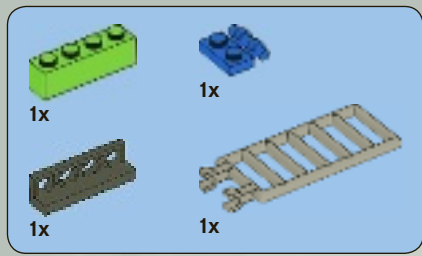

25

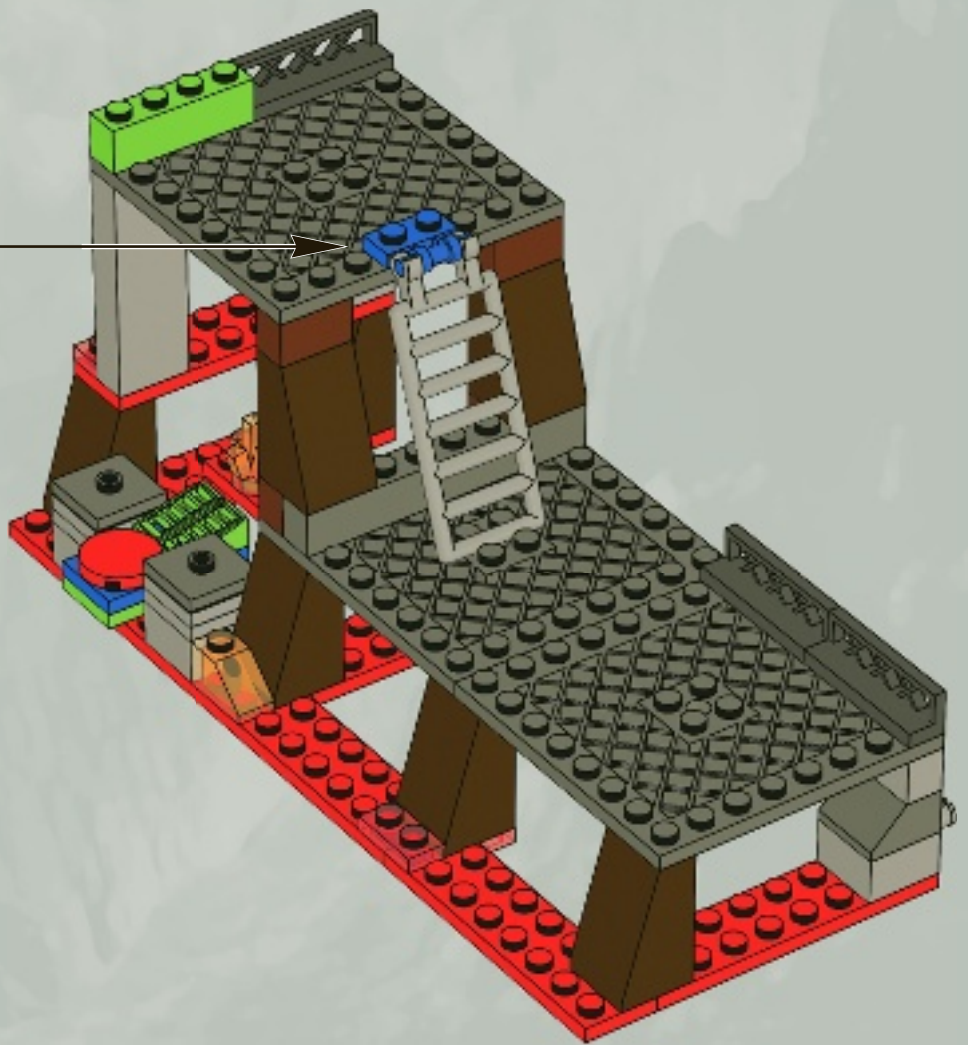
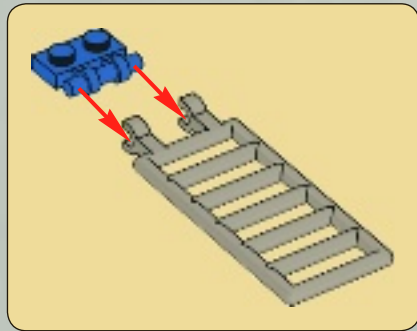

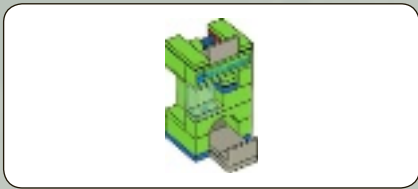

1

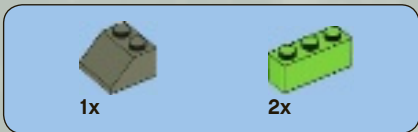
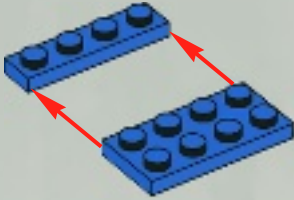

2

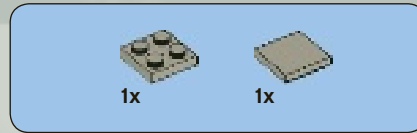
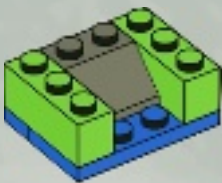

3

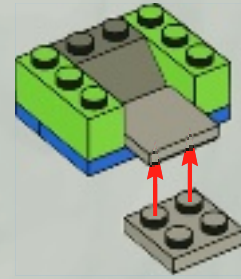

4

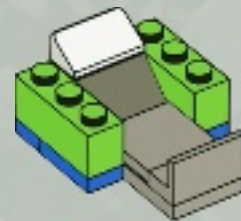

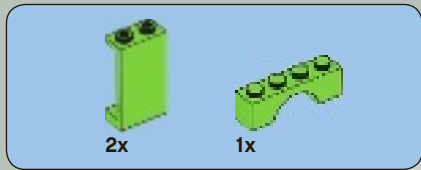

5

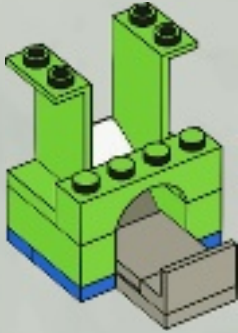

6

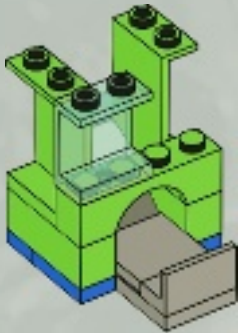

7

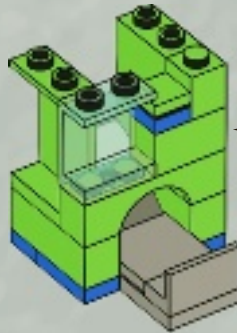
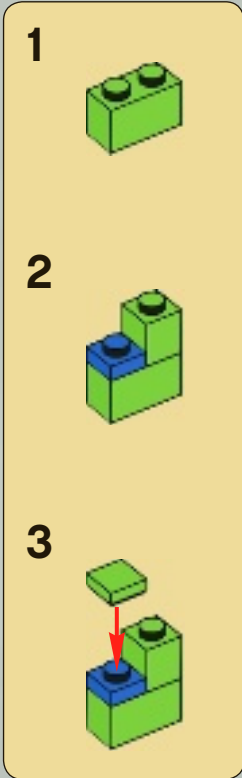

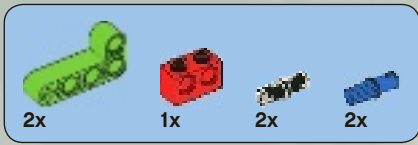

8

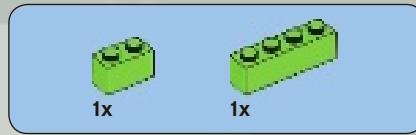
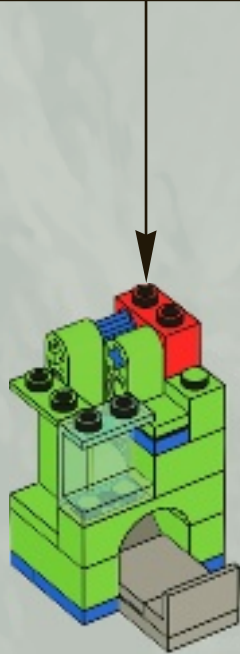
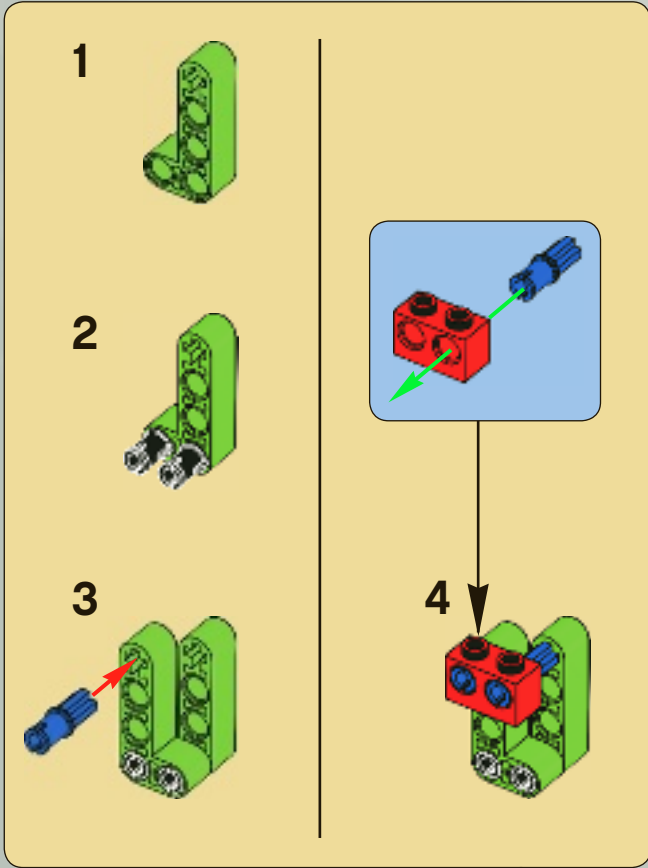

9

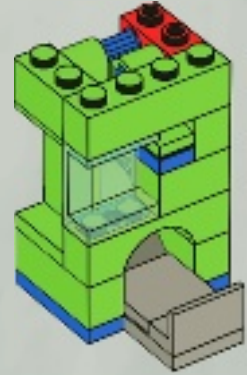

10

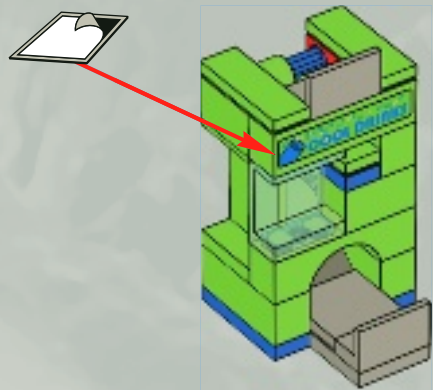

26



1x 1x 1x

27

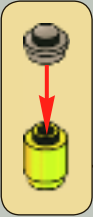

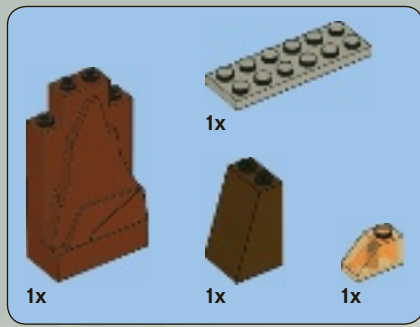

28

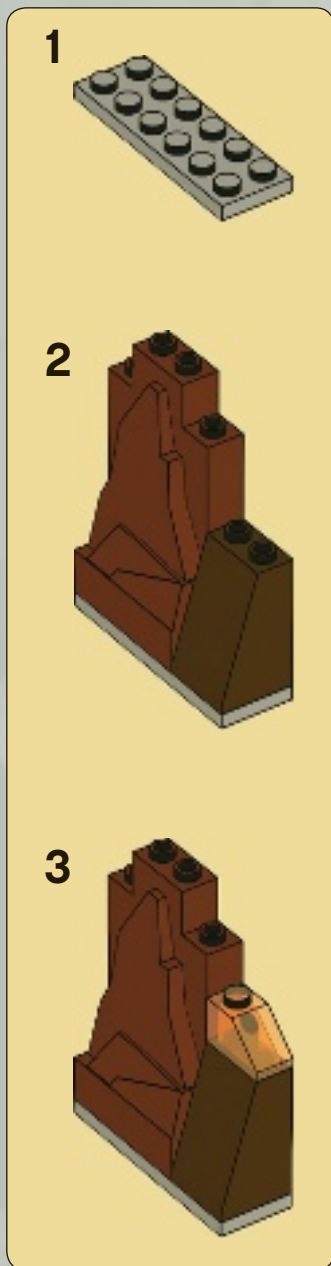

29

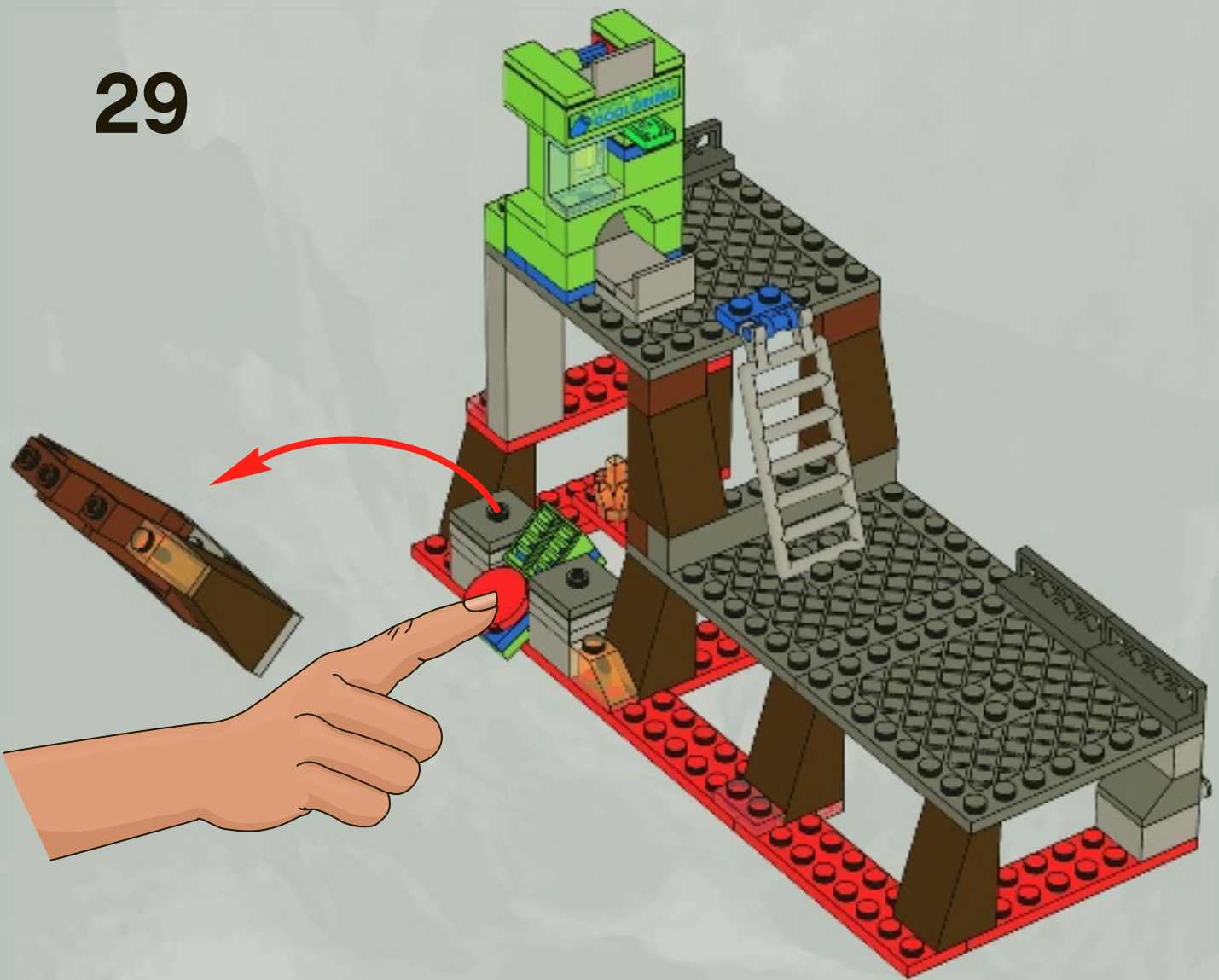

30



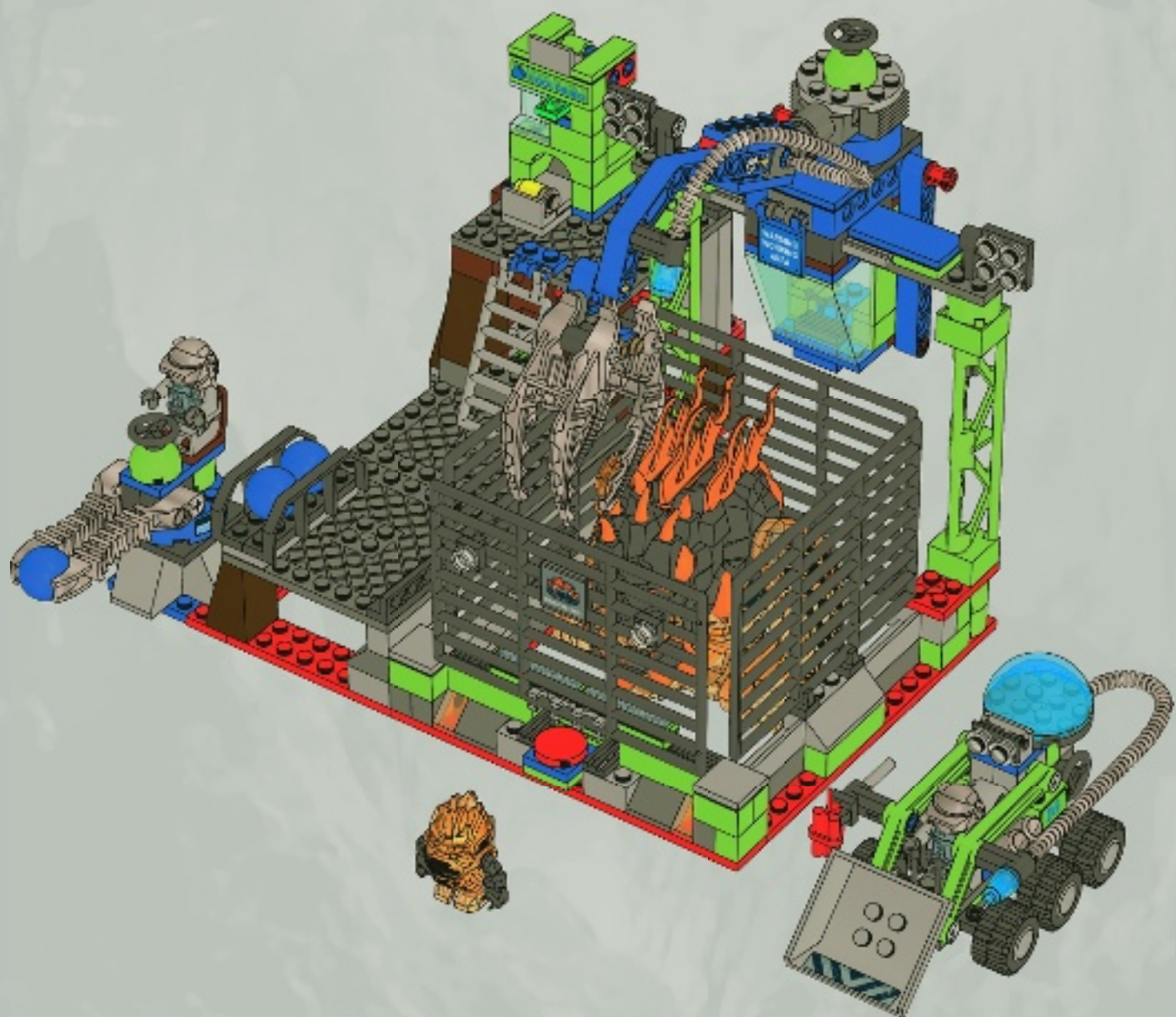

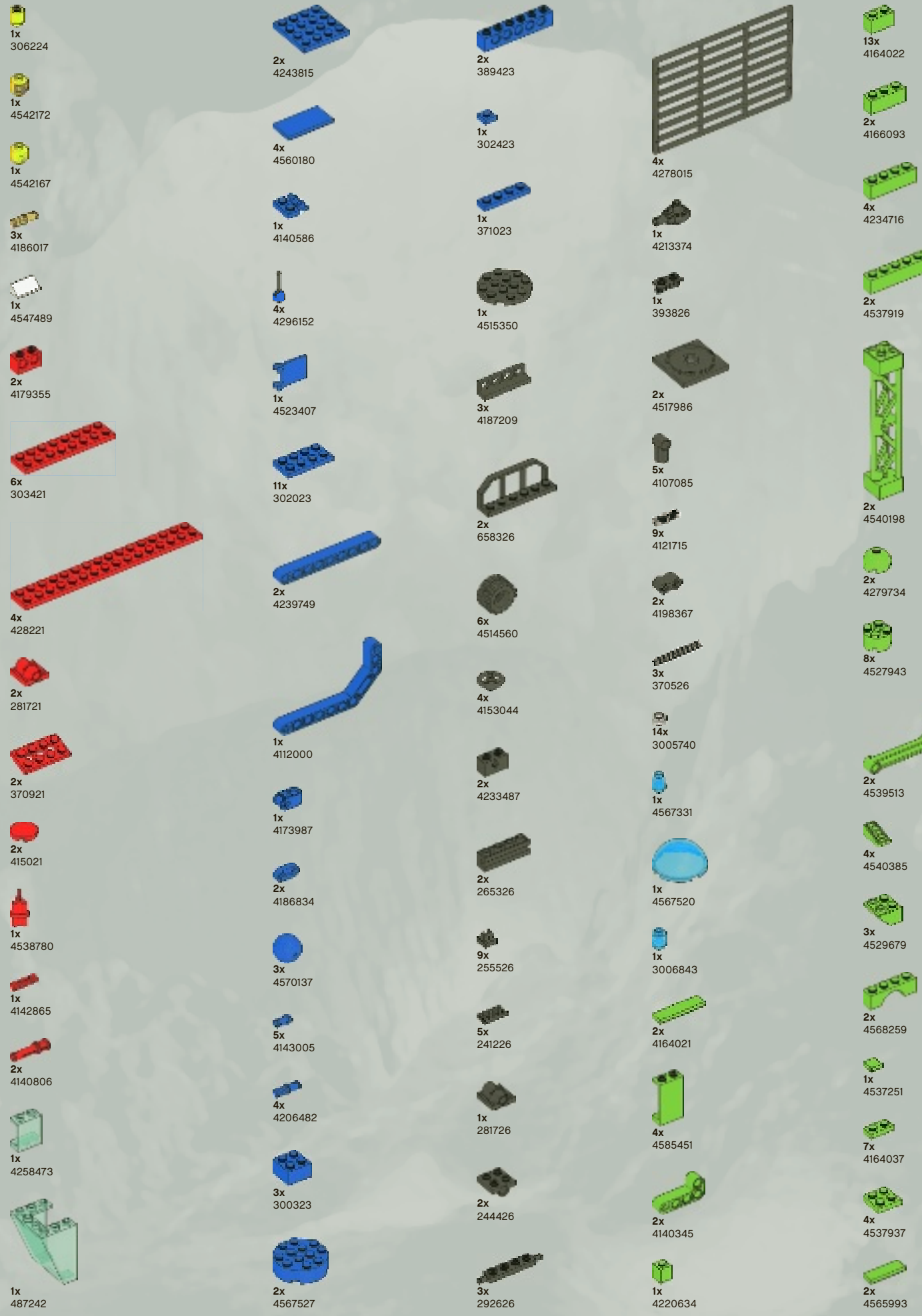

1x
306224

1x
4542172

1x
4542167

3x
4186017

1x
4547489

2x
4179355

6x
303421

4x
428221

2x
281721

2x
370921

2x
415021

1x
4538780

1x
4142865

2x
4140806

1x
4258473

1x
487242

2x
4243815

4x
4560180

1x
4140586

4x
4296152

1x
4523407

11x
302023

2x
4239749

1x
4112000

1x
4173987

2x
4186834

3x
4570137

5x
4143005

4x
4206482

3x
300323

2x
4567527

2x
389423

1x
302423

1x
371023

1x
4515350

3x
4187209

2x
658326

6x
4514560

4x
4153044

2x
4233487

2x
265326

9x
255526

5x
241226

1x
281726

2x
244426

3x
292626

4x
4278015

1x
4213374

1x
393826

2x
4517986

5x
4107085

9x
4121715

2x
4198367

3x
370526

14x
3005740

1x
4567331

1x
4567520

1x
3006843

2x
4164021

4x
4585451

2x
4140345

1x
4220634

13x
4164022

2x
4166093

4x
4234716

2x
4537919

2x
4540198

2x
4279734

8x
4527943

2x
4539513

4x
4540385

3x
4529679

2x
4568259

1x
4537251

7x
4164037

4x
4537937

2x
4565993





Customer Service
Kundenservice
Service Consommateurs
Servicio Al Consumidor
www.lego.com/service or dial

 : 00800 5346 5555
 : 1-800-422-5346

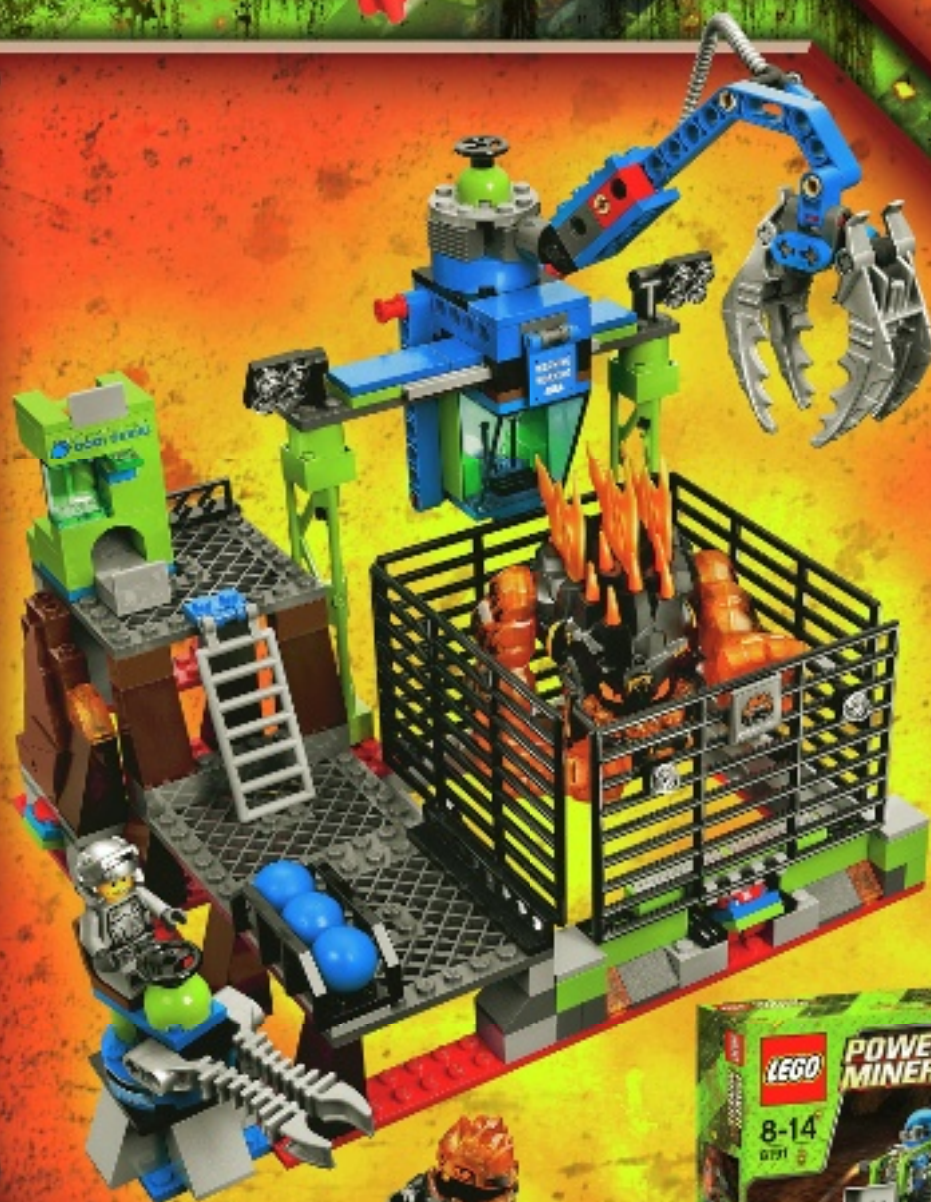

8188



8191





8189



8190





THE ADVENTURES OF CLUTCH POWERS



FIRST LEGO® DVD MOVIE!
SPRING 2010

Premier film LEGO® en DVD ! Printemps 2010 - ¡La 1^{era} Película de LEGO® en DVD! Primavera 2010



LEGO

POWER MINERS



Infernex

Combustix

Firax

Eruptorr





FREE! GRATIS! GRATUIT!



club
MAGAZINE™

www.LEGOclub.com



00800 5346 5555*



1-866-534-6258 • 1-877-518-5346

US & Canada only

Canada seulement



VISIT THE WORLD'S
BIGGEST LEGO® SHOP!

www.LEGOshop.com

* FreePhone. Mobile charges may apply. * Numéro sans Frais. Des Frais peuvent s'appliquer avec les téléphones cellulaires. * Gebührenfrei, Kosten für Anrufe aus Mobilfunknetzen können abweichen. * Gratis telefonnummer vanaf vaste lijn. * Det er ett gratis nummer, når du ringer fra Posttelefon. * Det är gratis, när du ringer från en Post telefon.

YES! I want to join the LEGO® Club FREE! OUI! Je veux m'abonner au Club LEGO® GRATUITEMENT! Ja! Ich möchte Mitglied im kostenlosen LEGO® Club werden. Ja! Ik wil graag GRATIS lid worden van de LEGO® Club. Ja! Jeg ønsker å melde meg inn i LEGO® Club gratis! Ja! Jeg vill gå med i LEGO® Club GRATIS!

First name - Prénom
Vorname - Voornaam
Fornavn - Förnamn

Last name - Nom de Famille
Name - Achternam
Etternavn - Efternamn

Date of Birth - Date de naissance
Geburtsdag - Geboortedatum
Fødselsdato - Fødselsdato

Boy - Garçon
Junge - Jongen
Gutt - Pojke

Girl - Fille
Mädchen - Meisje
Jente - Flicka

Street - Adresse
Straße, Housn.
Straat, huijsn. - Adress

City - Ville
Ort - Woonplaats
Poststed - Postort

State
Prov.
County

Zip/Postcode - Code Postal
PLZ - Postcode - Postnummer

Country
Pays - Land

Post - Poste
Per Post

Email - Courriel
Per E-Mail
E-Mail

Ich möchte über Produkte, Angebote, Aktionen und weitere interessante Themen von sonstigen LEGO Partnerunternehmen informiert werden* (bitte ankreuzen). Per Post Per E-Mail

The English language version of the magazine can only be mailed to addresses in the US, Canada, the UK, and Republic of Ireland. Club membership is valid for two years and includes free copies of the LEGO Club Magazine. In the US and Canada please allow up to 6 weeks for delivery of your first magazine. In the UK and Republic of Ireland please allow six to 14 weeks for delivery of your first magazine. By signing this form you consent the LEGO Club to use your child's data for LEGO mailings. The data will only be used for LEGO mailings and will not be sold, rented or otherwise disclosed to any company outside the LEGO Company except for disclosure to companies acting as our agents to help us provide services requested by the child. This coupon is valid for one free membership per person, group or organisation. Photocopied coupons are accepted. La version française du magazine peut être postée uniquement au Canada. L'abonnement est valide pour 2 ans et inclut des exemplaires gratuits du Magazine LEGO. Aux E.-U. et au Canada, laissez 6 semaines pour la livraison initiale. En remplissant ce formulaire, vous consentez à ce que LEGO utilise les informations de votre enfant pour des envois postaux de LEGO. L'information sera utilisée uniquement pour des envois postaux par LEGO et ne sera en aucun cas, vendue, louée, échangée ou divulguée à d'autres compagnies autres que la compagnie LEGO, à l'exception des compagnies affiliées qui nous procurent des services auxquels l'enfant en a fait la demande. Das deutschsprachige LEGO Club Magazin kann nur an Adressen in Deutschland, Österreich und der Schweiz verschickt werden. Die kostenlose Mitgliedschaft beinhaltet die Zusendung des LEGO Club Magazins und endet nach zwei Jahren. Mit der Anmeldung gehen Sie keine Verpflichtungen ein. Es kann bis zu drei Monate dauern, bis das erste Magazin zugestellt wird. Mit Ihrer Unterschrift erklären Sie sich damit einverstanden, dass die Daten Ihres Kindes zum Zweck einer LEGO Club Mitgliedschaft von der LEGO Gruppe gespeichert und verarbeitet werden. Die Daten werden vertraulich behandelt, nicht an Dritte weitergegeben und nicht veräußert. Externe Dienstleister erhalten Ihre Daten nur, soweit es für die Abwicklung von LEGO Kommunikation erforderlich ist. Wenn Sie von uns nicht mehr kontaktiert werden möchten, können Sie der Verwendung Ihrer Daten für Werbezwecke widersprechen unter: 00800 5346 5555 (Anruf gebührenfrei, Kosten für Anrufe aus Mobilfunknetzen können abweichen). * Die Einwilligungen kann ich jederzeit (insgesamt oder zum Teil) ohne Einfluss auf die LEGO Club Mitgliedschaft bei der LEGO Gruppe widerrufen. Het LEGO Club Magazine kan alleen worden gestuurd naar adressen in Nederland. Het lidmaatschap is 2 jaar geldig en geeft recht op toezending van het gratis LEGO Club Magazine. Het eerste magazine zal na 12 tot 14 weken toegestuurd worden. Het lidmaatschap kan op ieder moment opgezegd worden. Door dit formulier te tekenen geeft u de LEGO Club toestemming om bovenstaande gegevens te gebruiken voor het toesturen van LEGO mailings. Uw gegevens worden uitsluitend gebruikt voor mailings van LEGO en zullen niet worden verkocht, verhuurd of op welke wijze dan ook verstrekt aan derden buiten de LEGO Groep, uitgezonderd de organisaties die namens ons optreden om de service te verlenen waar uw kind om gevraagd heeft. Den norske utgaven av magasinet sendes kun til adresser i Norge. Medlemskap i klubben gjelder i 2 år og inkluderer gratisutgaver av LEGO Magazine. Påregnet opp til seks uker leveringstid for første magasin. Ved å undertegne dette skjemaet, gir du ditt samtykke til at LEGO Club kan bruke opplysningene om barnet ditt i LEGO forsendelser. Dataene vil utelukkende bli brukt i LEGO forsendelser og vil ikke bli solgt, utleid eller på annen måte gjøres tilgjengelig for selskaper utenfor LEGO gruppen, unntatt selskaper som er våre agenter og som hjelper oss å tilby tjenestene barnet etterspør. Dette skjemaet gjelder for ett gratis medlemskap per person, gruppe eller organisasjon. Den svenska versionen av tidningen kan endast skickas till adresser i Sverige. Club-medlemskapet är giltigt i 2 år och innefattar gratis exemplar av LEGO Club Magazine. Vålligen räknas med 6 veckor för leverans av din första tidning. Genom att skicka in det här formuläret godkänner du att LEGO Club använder barnets uppgifter för LEGO utskick. Uppgifterna kommer bara att användas för LEGO utskick och kommer inte att säljas, hyras ut eller vidarebefordras till något företag som inte tillhör LEGO Gruppen, med undantag av företag som agerar som våra ombud för att tillhandahålla tjänster som barnet har begärt. Den här kupongen gäller för ett gratis medlemskap per person, grupp eller organisation.

Mail to: / Poster à:

 BG29
LEGO® Club
 P.O. Box 1157
 Enfield, CT USA
 06083-1157

Mail to:

 BIO9U
LEGO® Club
 33 Bath Road
 Slough SL1 3UF
 United Kingdom

Per Post an:

 BIO9C
LEGO® Club
 Postfach 14 15
 D-36243 Niederaula

Stuur op naar:

 BIO9N
LEGO® Club
 Postbus 40250
 3504 AB Utrecht

Send til:

 BIO9O
LEGO® Club Norge
 Postboks 58
 1314 Vøyenenga

Skickas till:

 BIO9S
LEGO® Club Sverige
 Ubox 841
 202 29 Malmö

Parent's signature - Signature d'un parent - Unterschrift Erziehungsberechtigte/r
 Handtekening ouders - Foreldres/Foresettes underskrift - Förälders/Förmyndares underskrift

Date
 Datum
 Dato