



# CITY

Ages/edades

# 5-12

## 7993

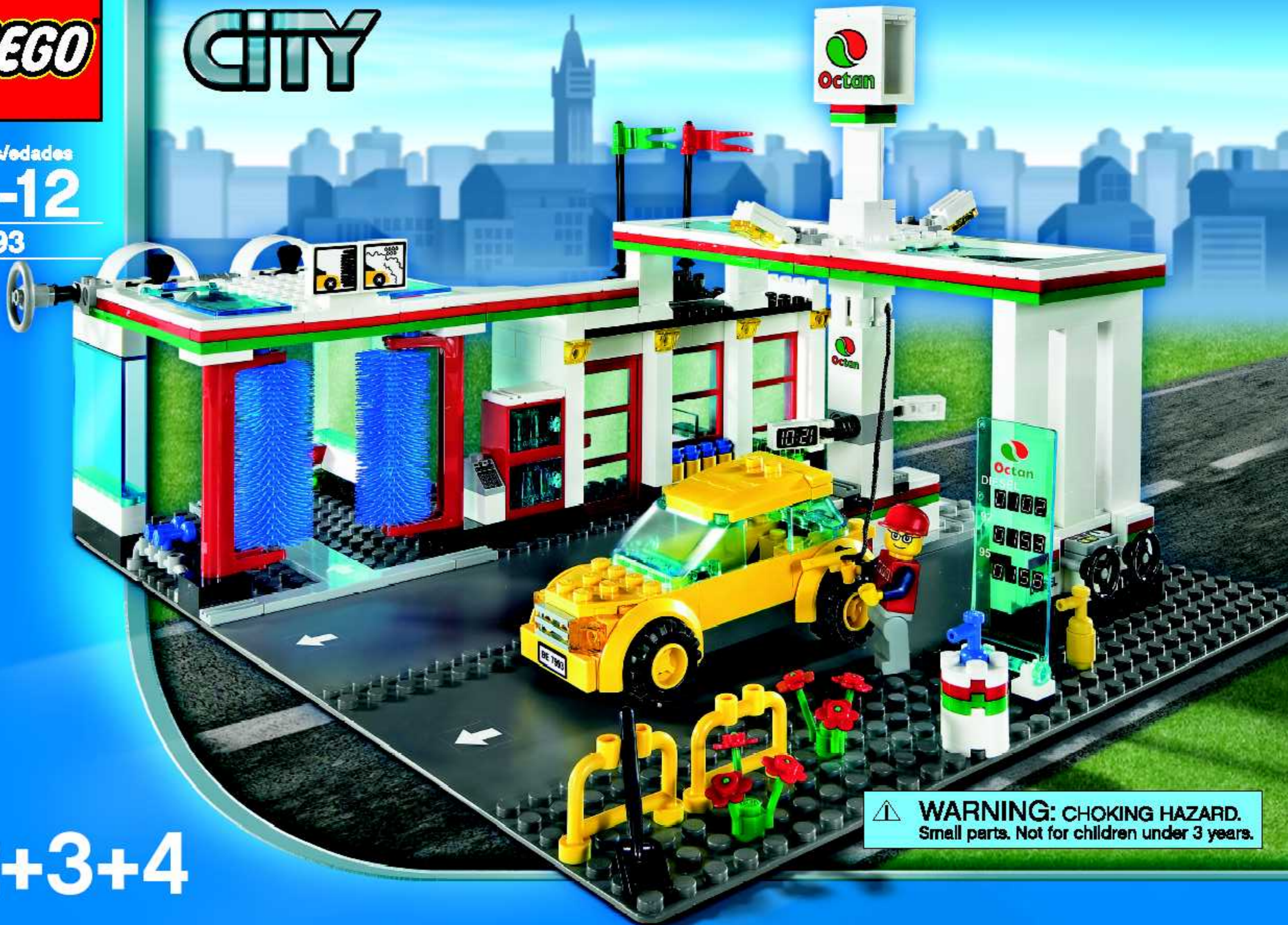

# 2+3+4

 **WARNING: CHOKING HAZARD.**  
Small parts. Not for children under 3 years.

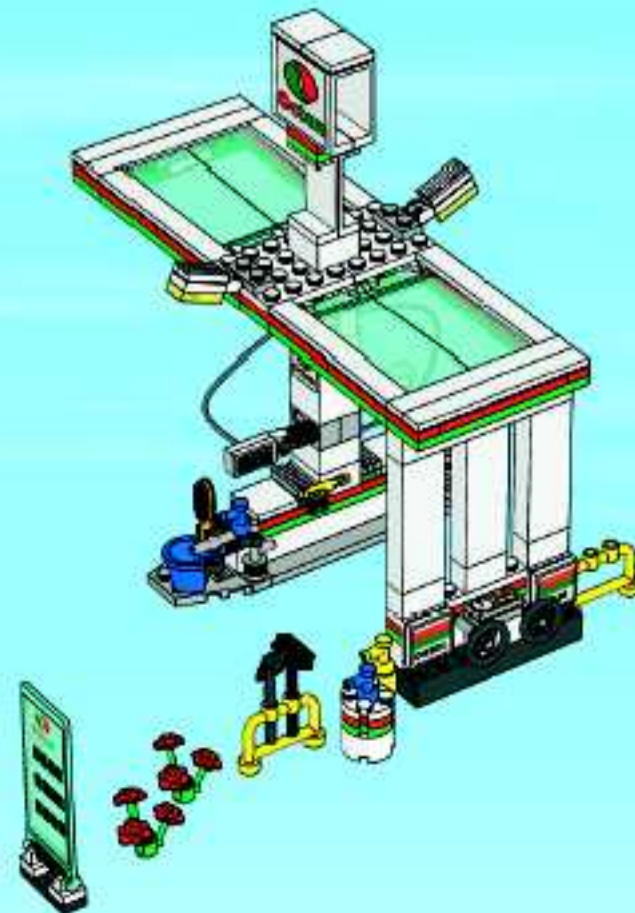
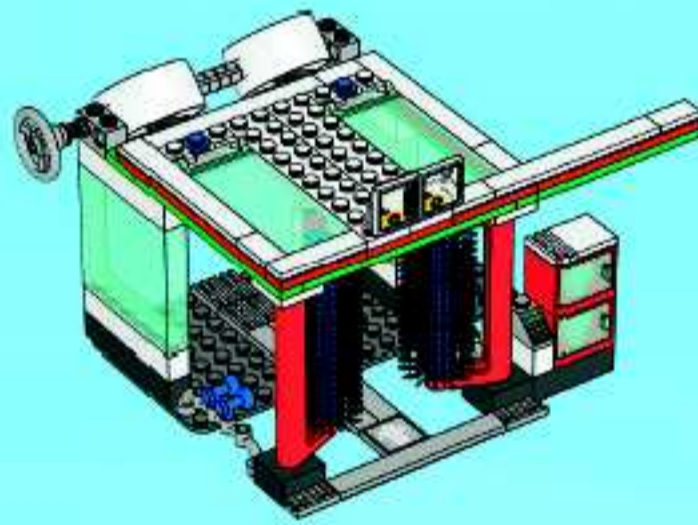
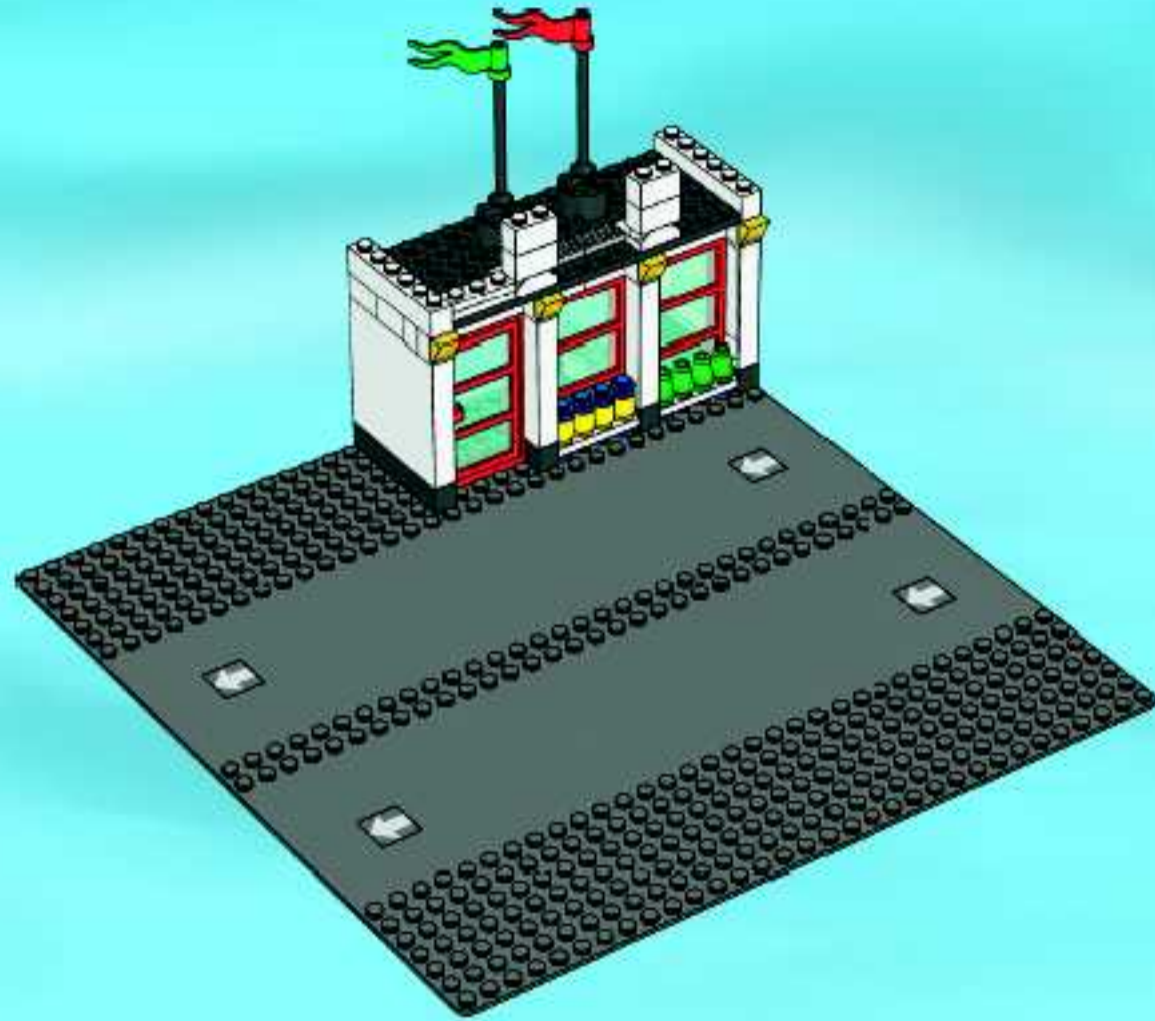

1

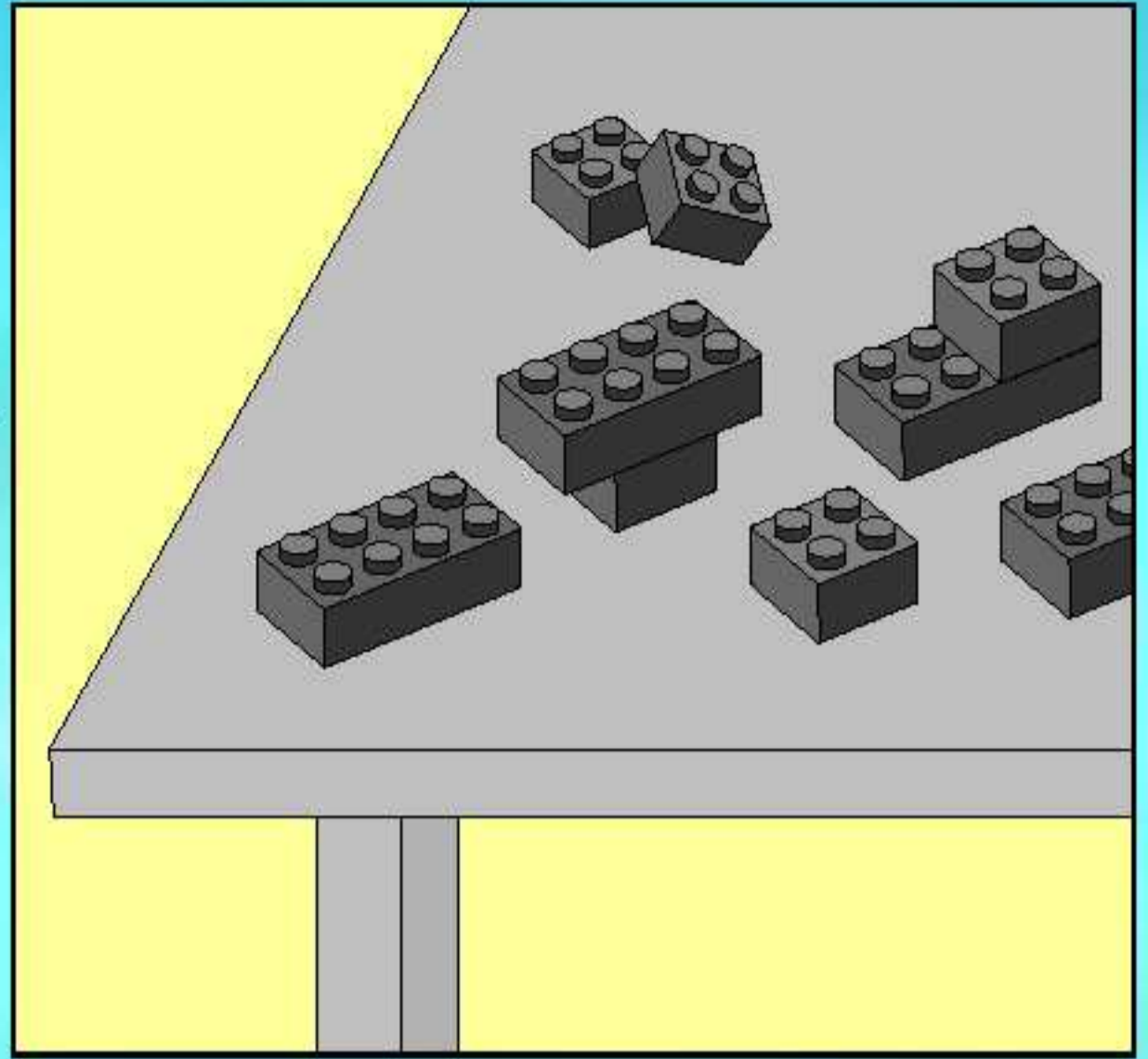
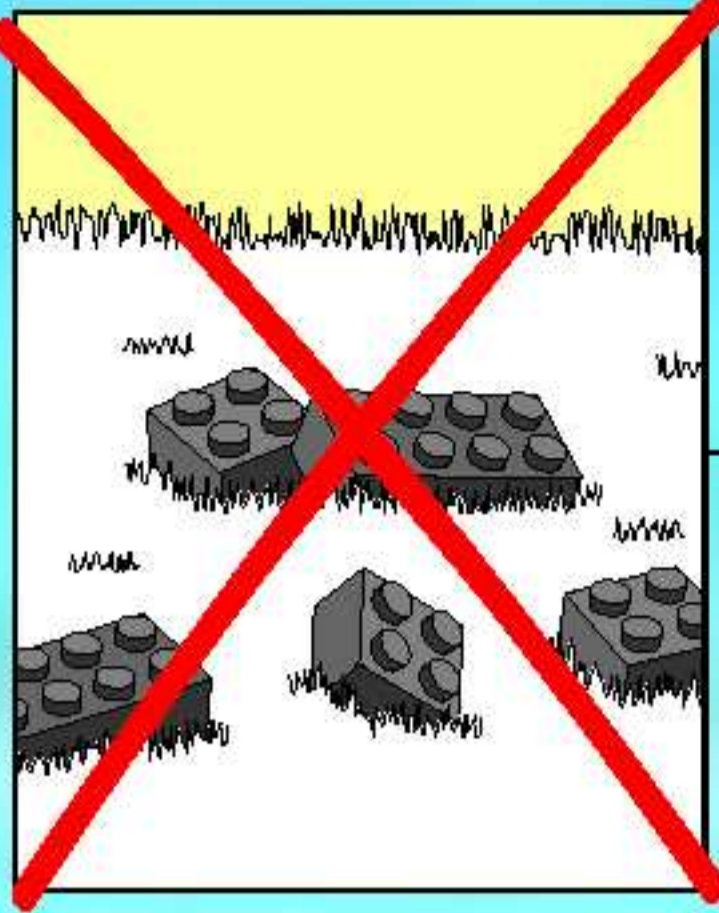

2



⚠ **AVERTISSEMENT : RISQUE D'ÉTOUFFEMENT.**  
 Contient des petites pièces. Ne convient pas aux enfants de moins de 3 ans.

⚠ **ADVERTENCIA: PELIGRO DE ASFIXIA.**  
 No recomendado para niños menores de 3 años. Contiene piezas pequeñas.

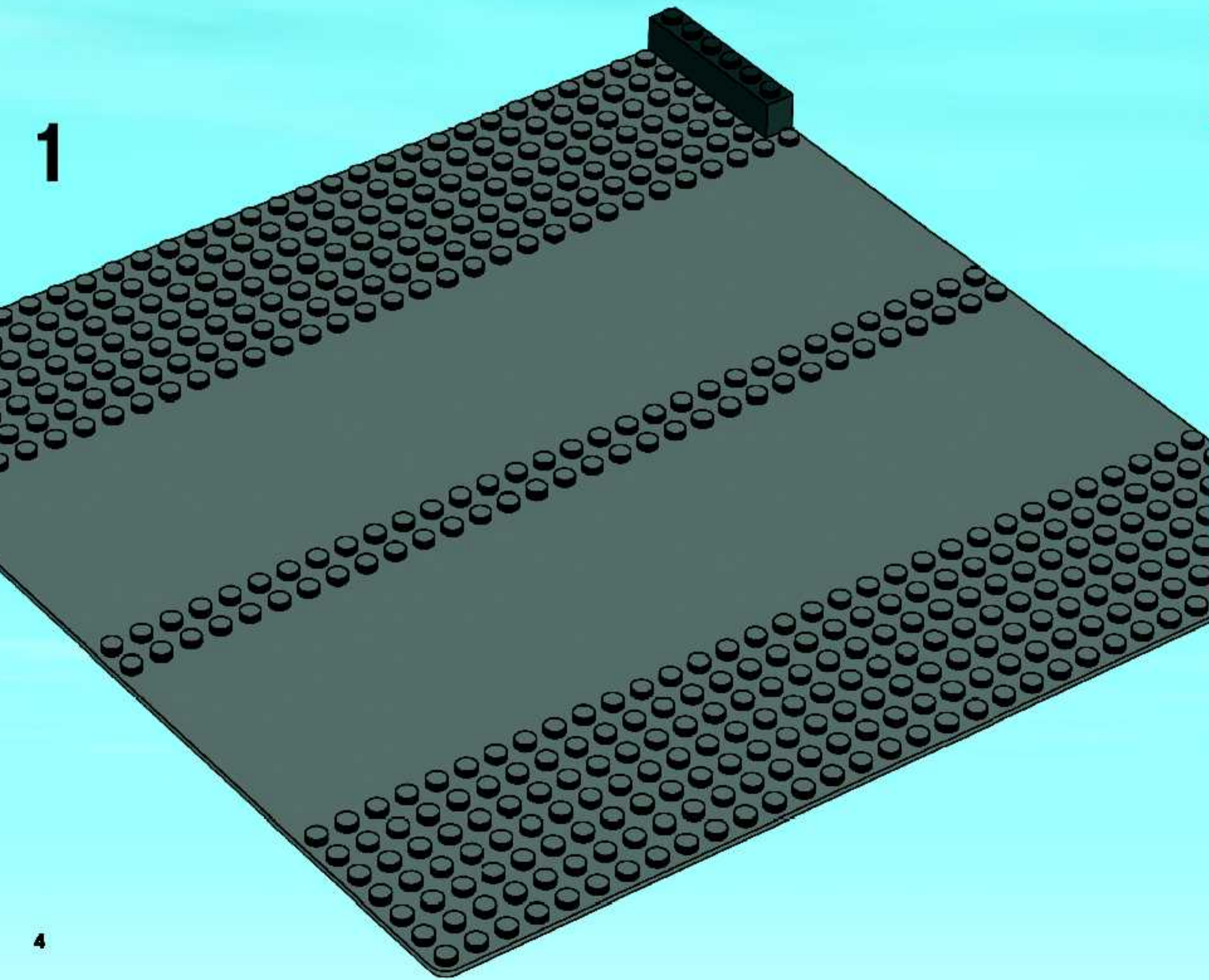
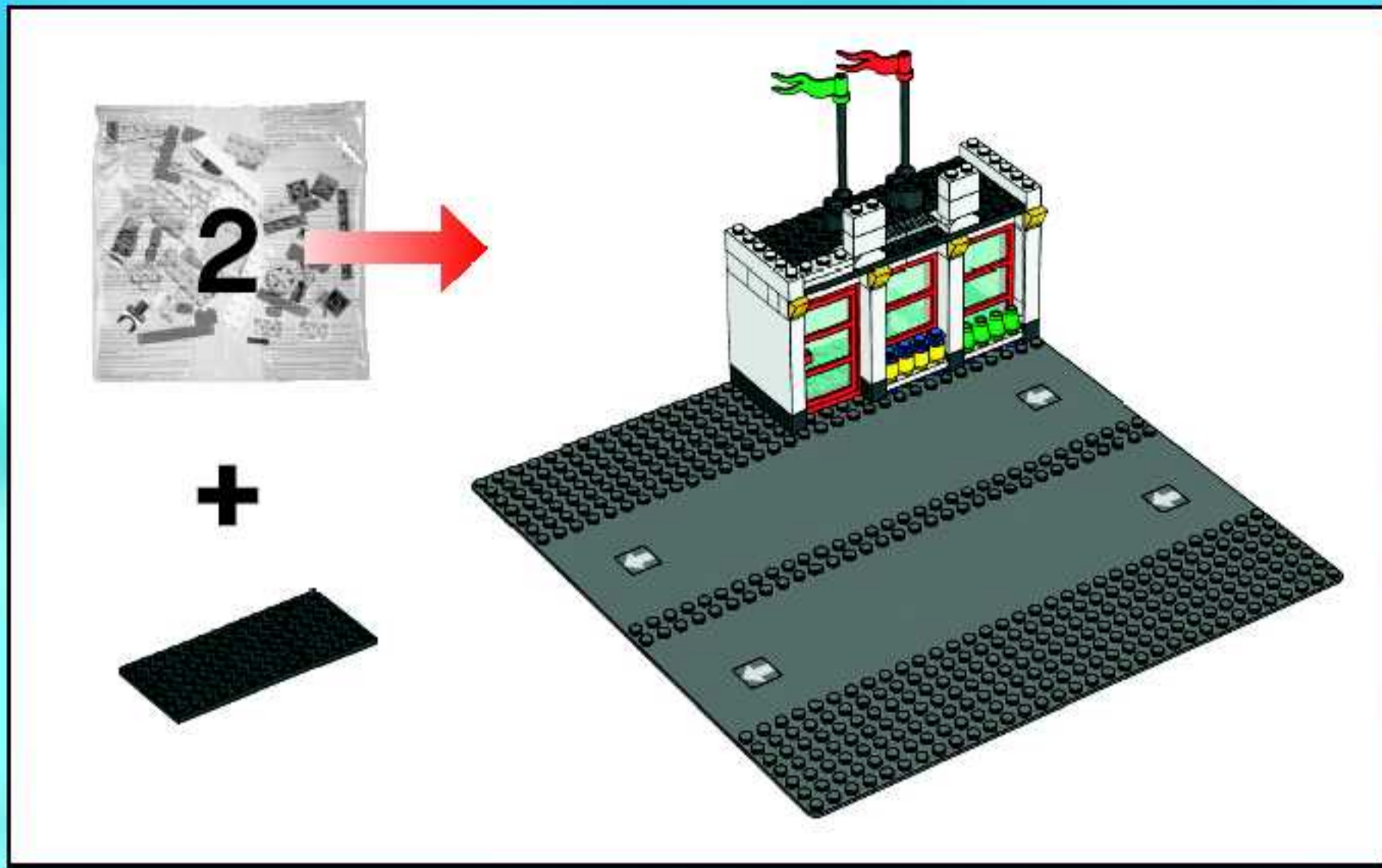

2

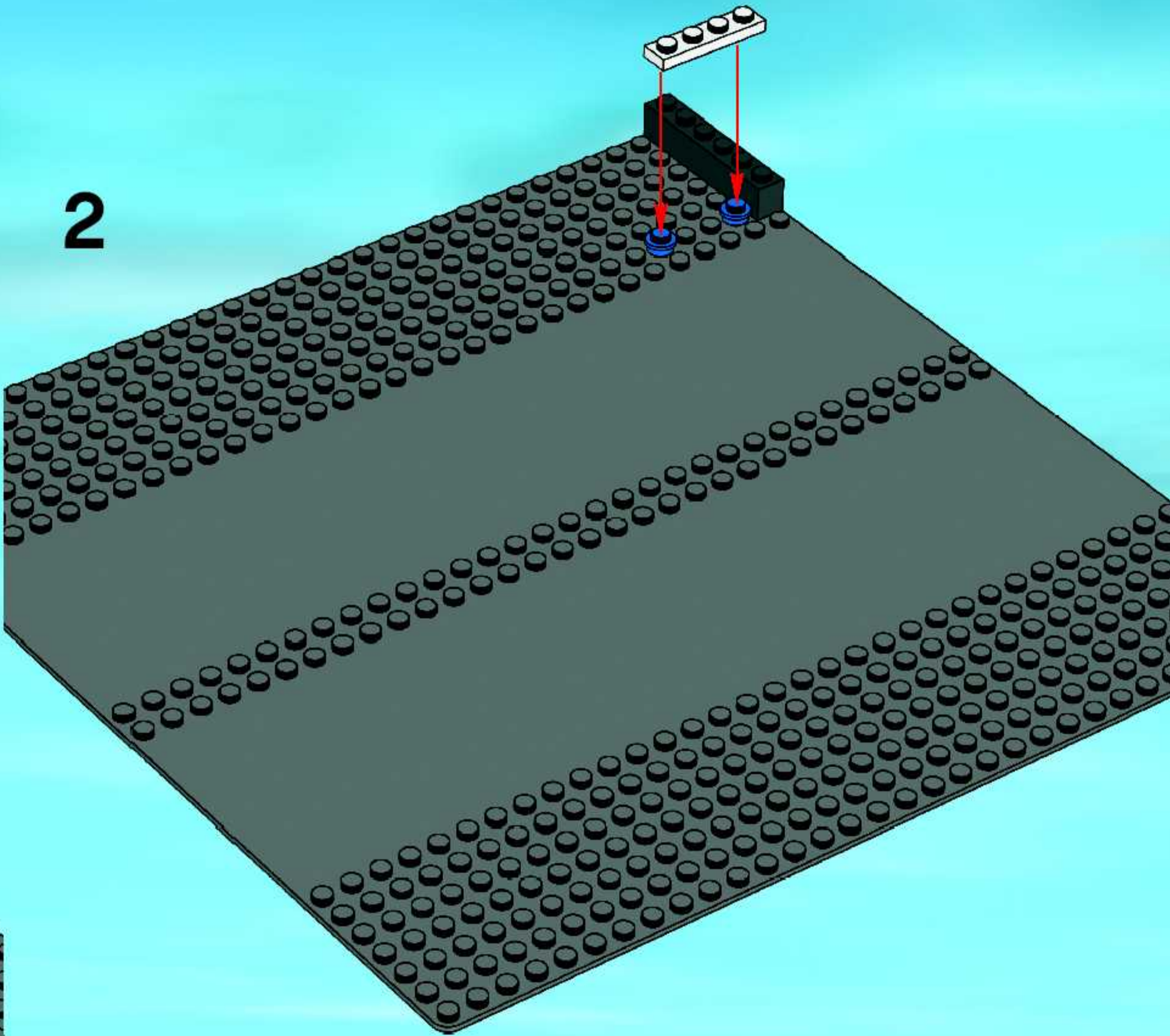

3

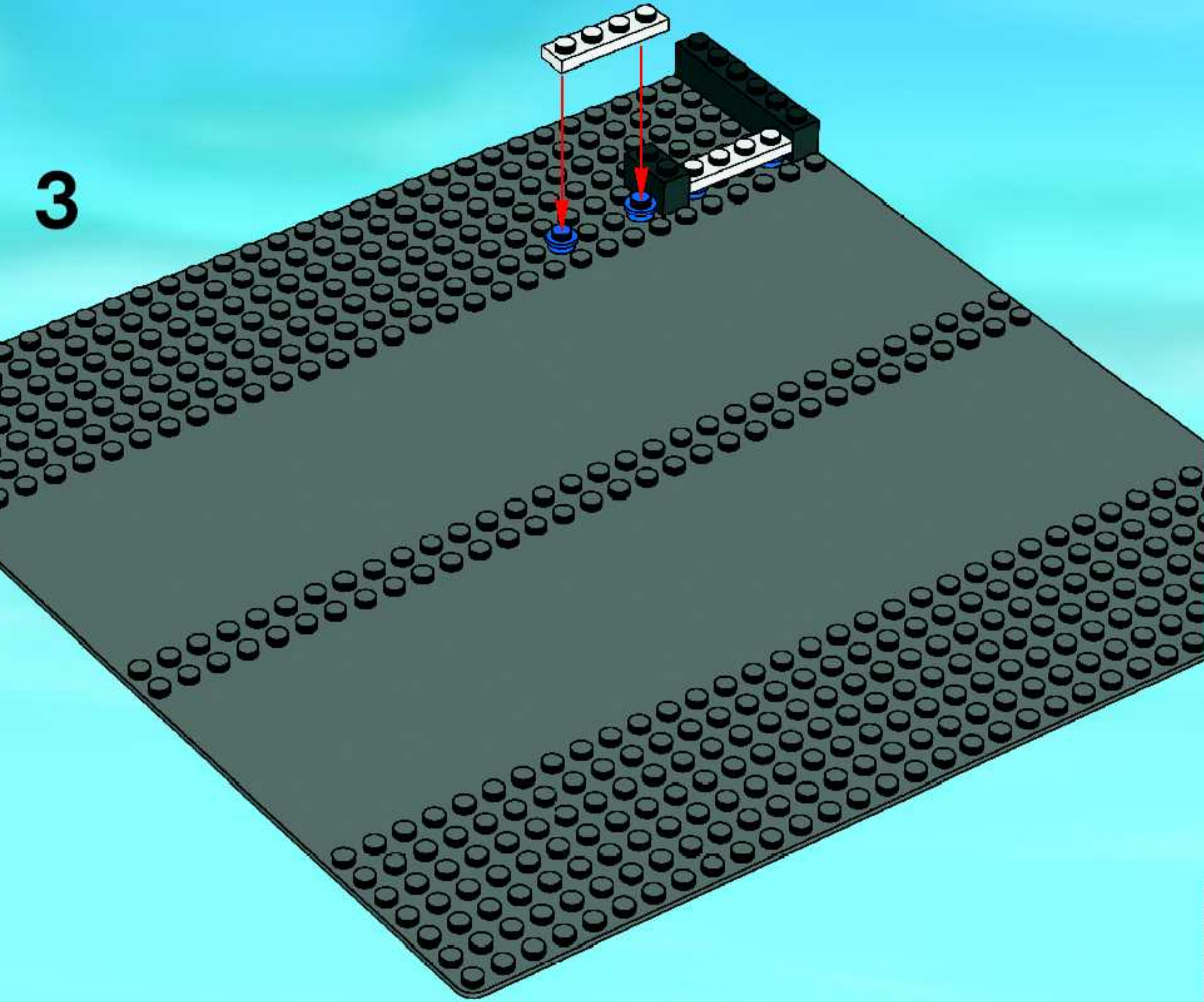

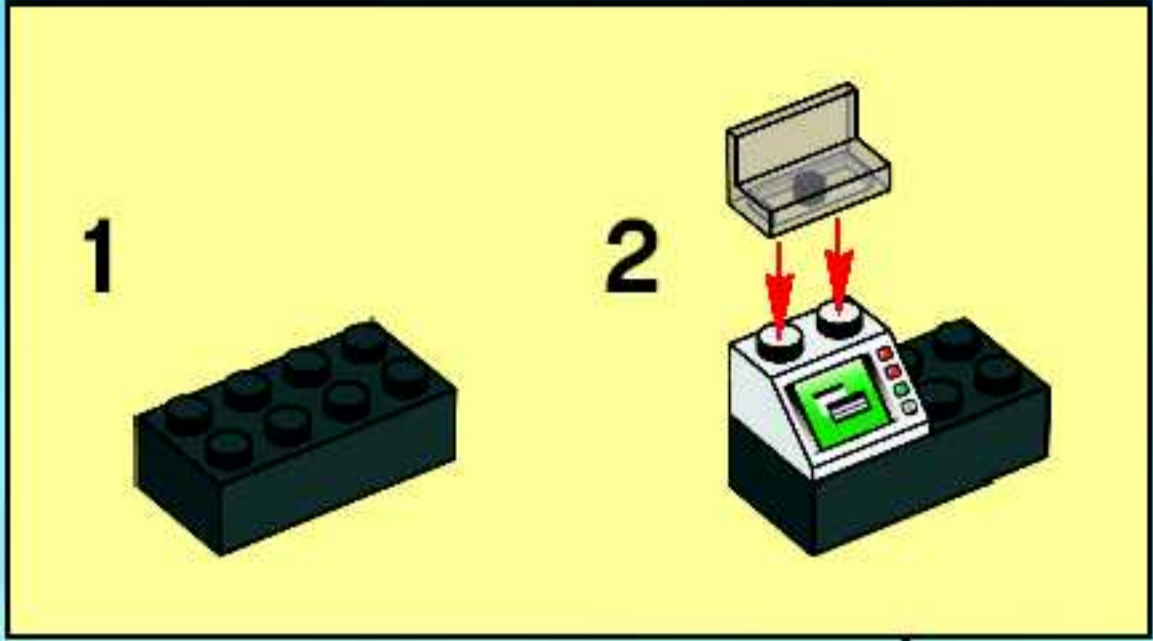

4

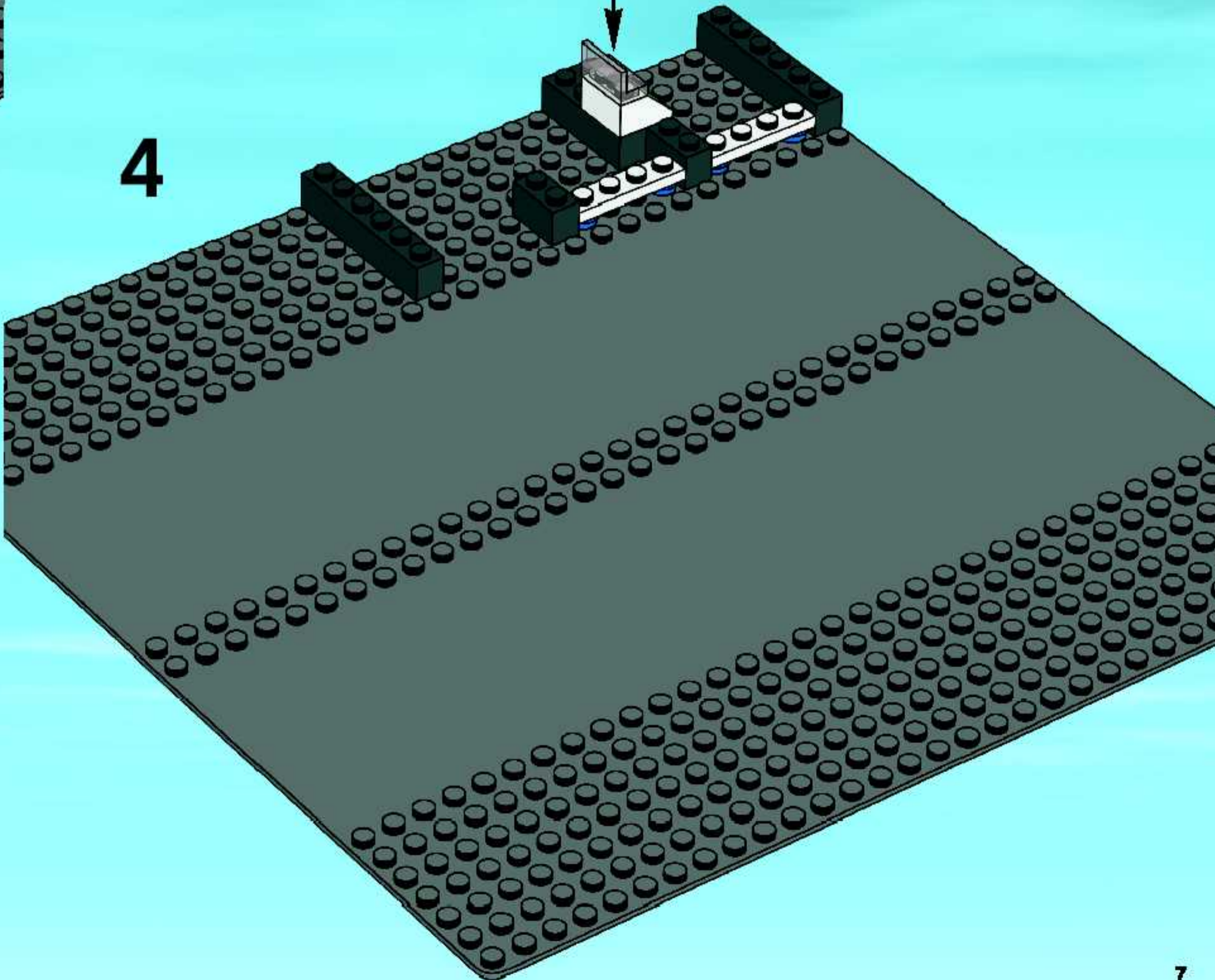

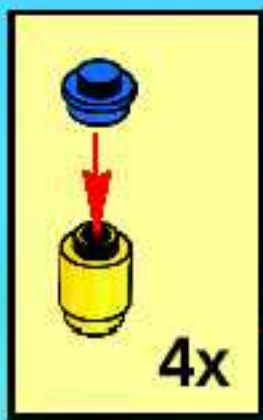

5

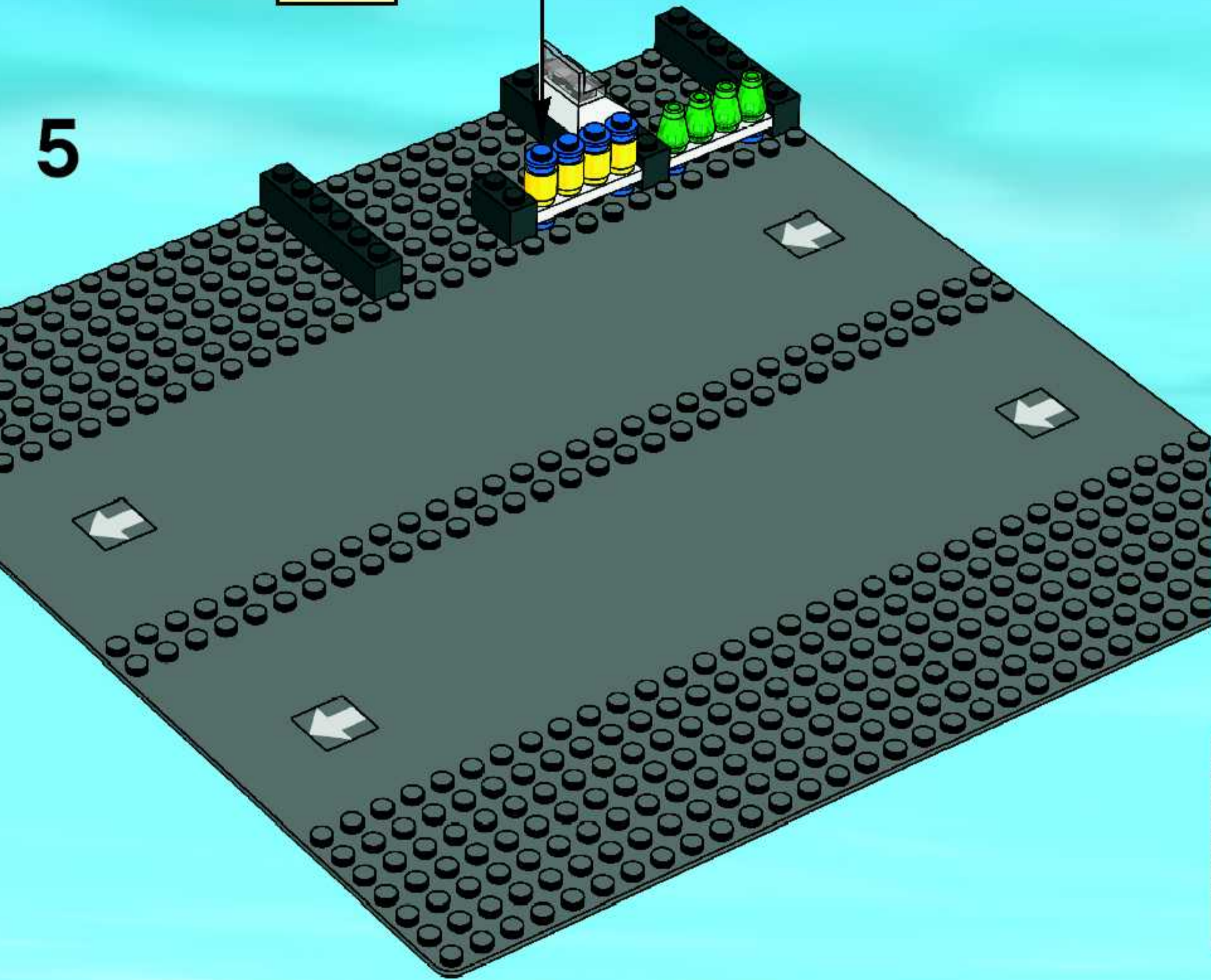



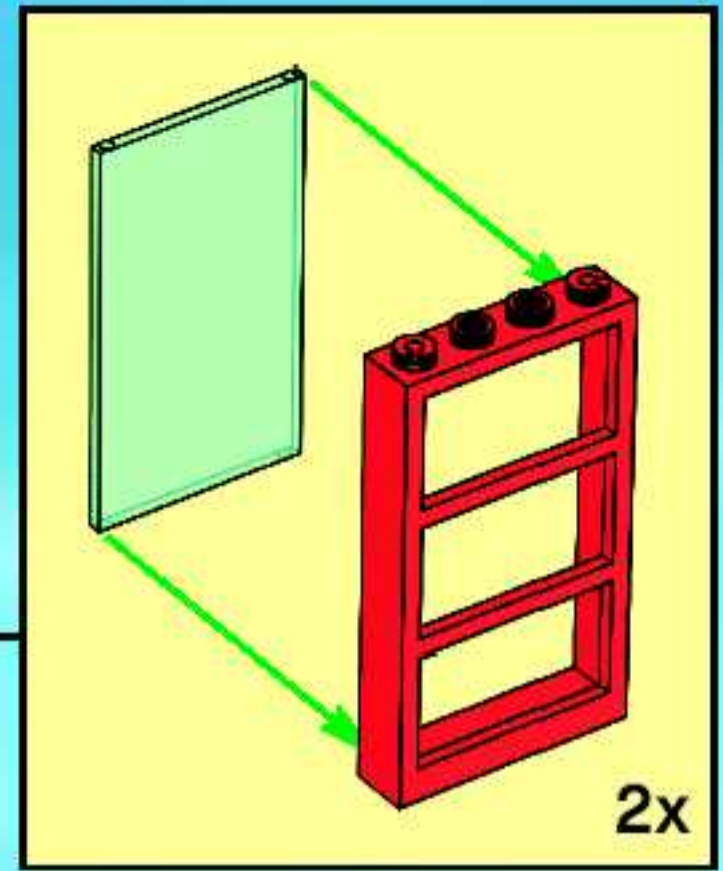
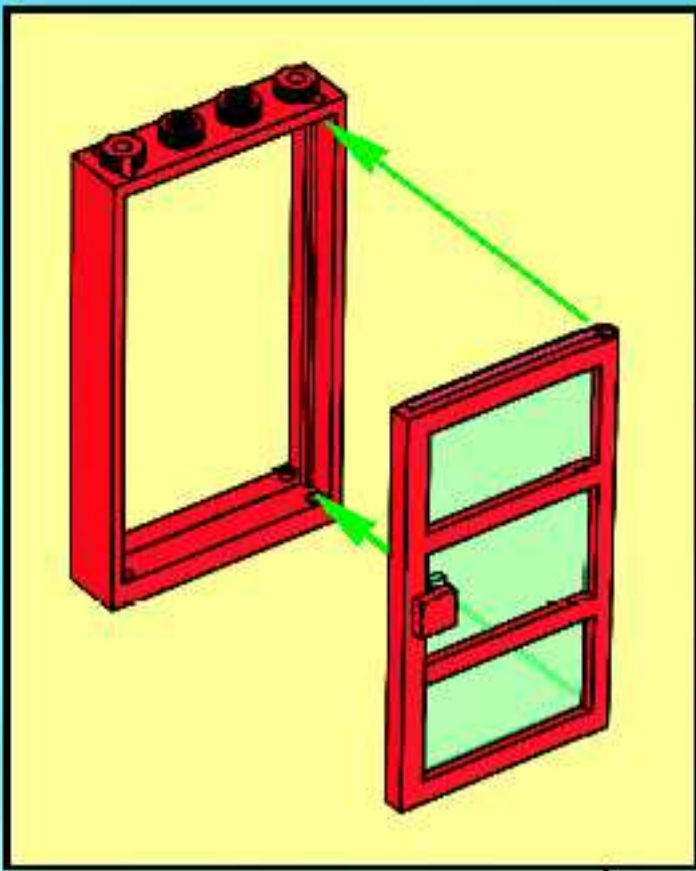

6

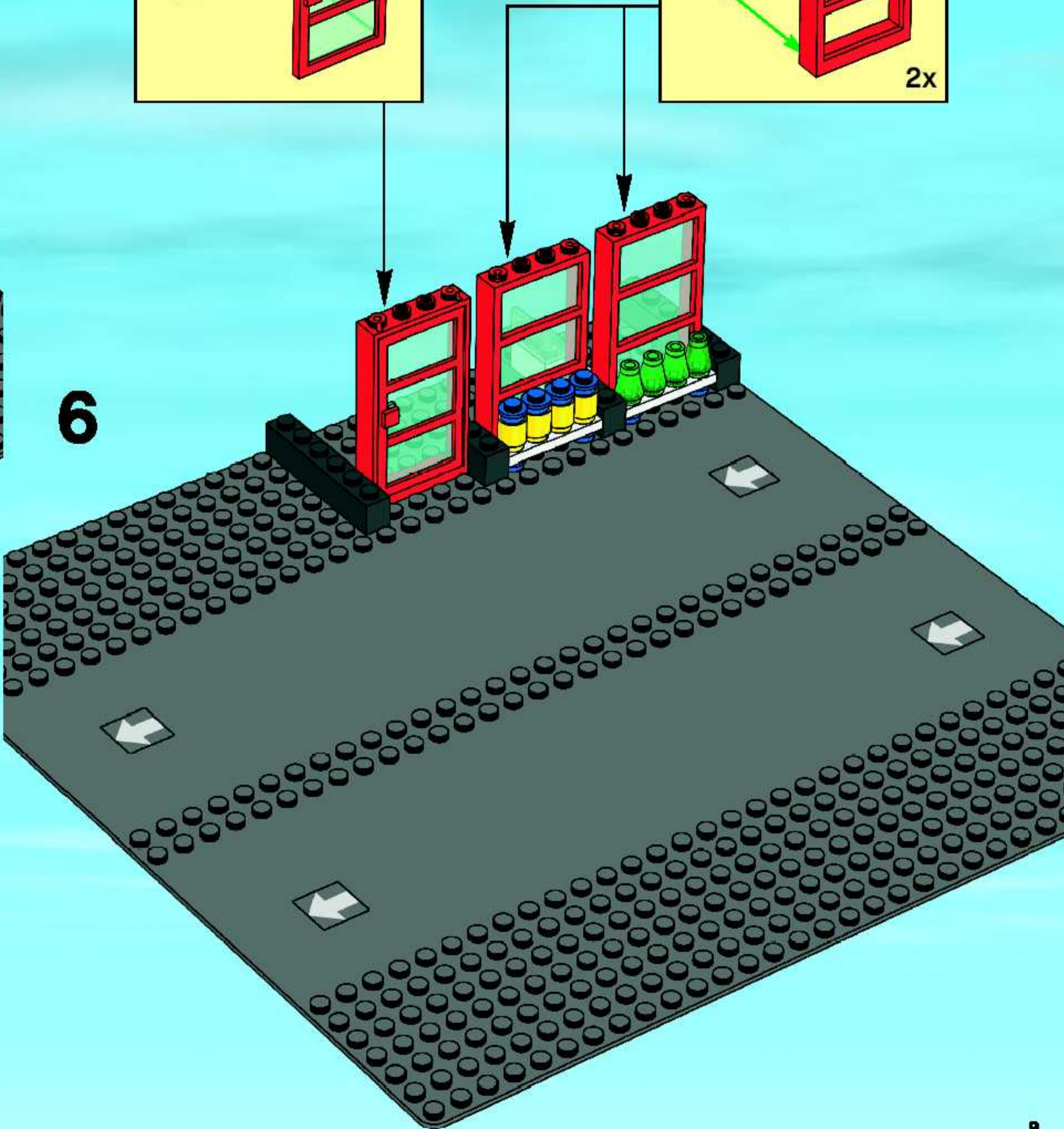

7

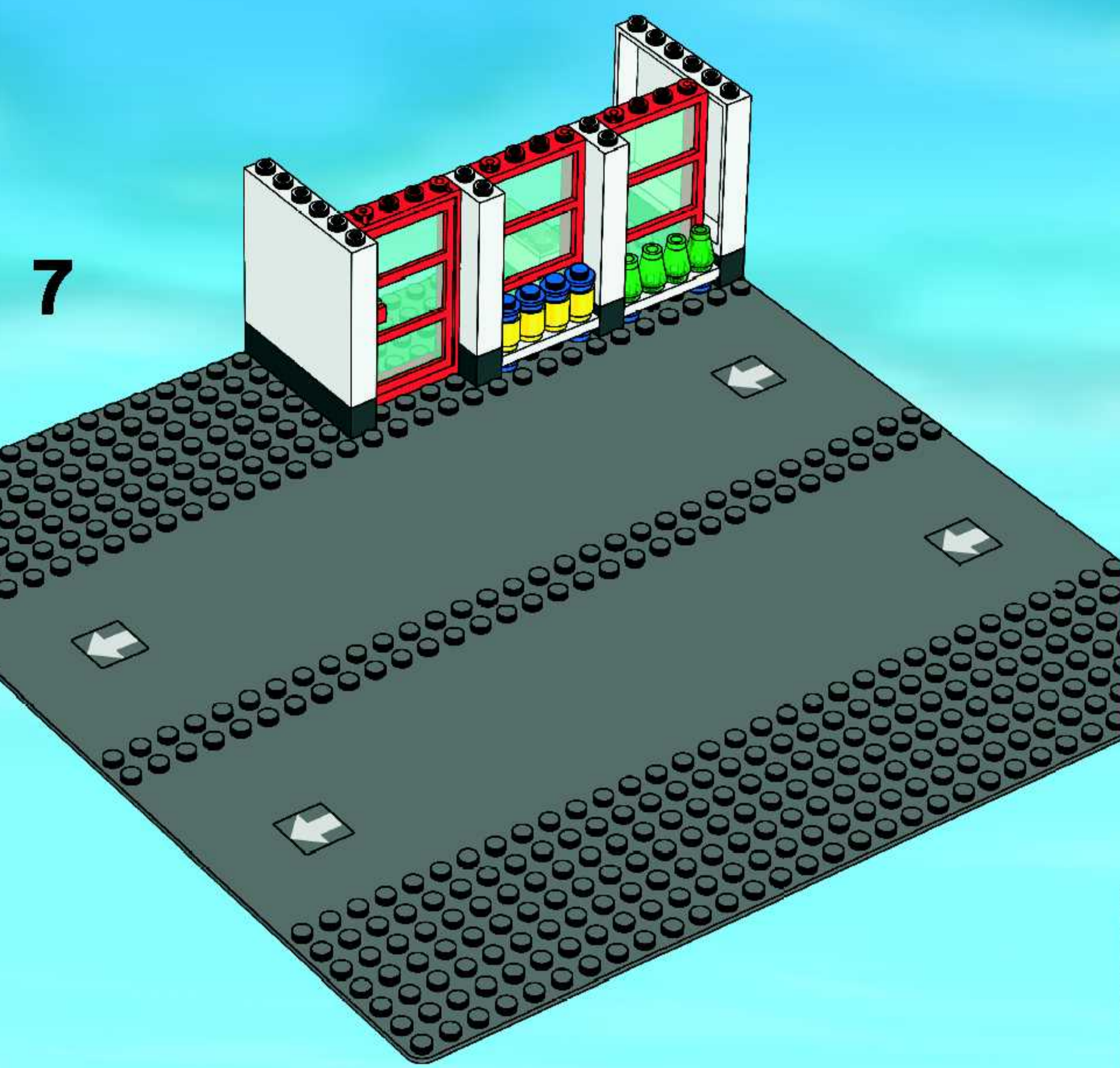

8

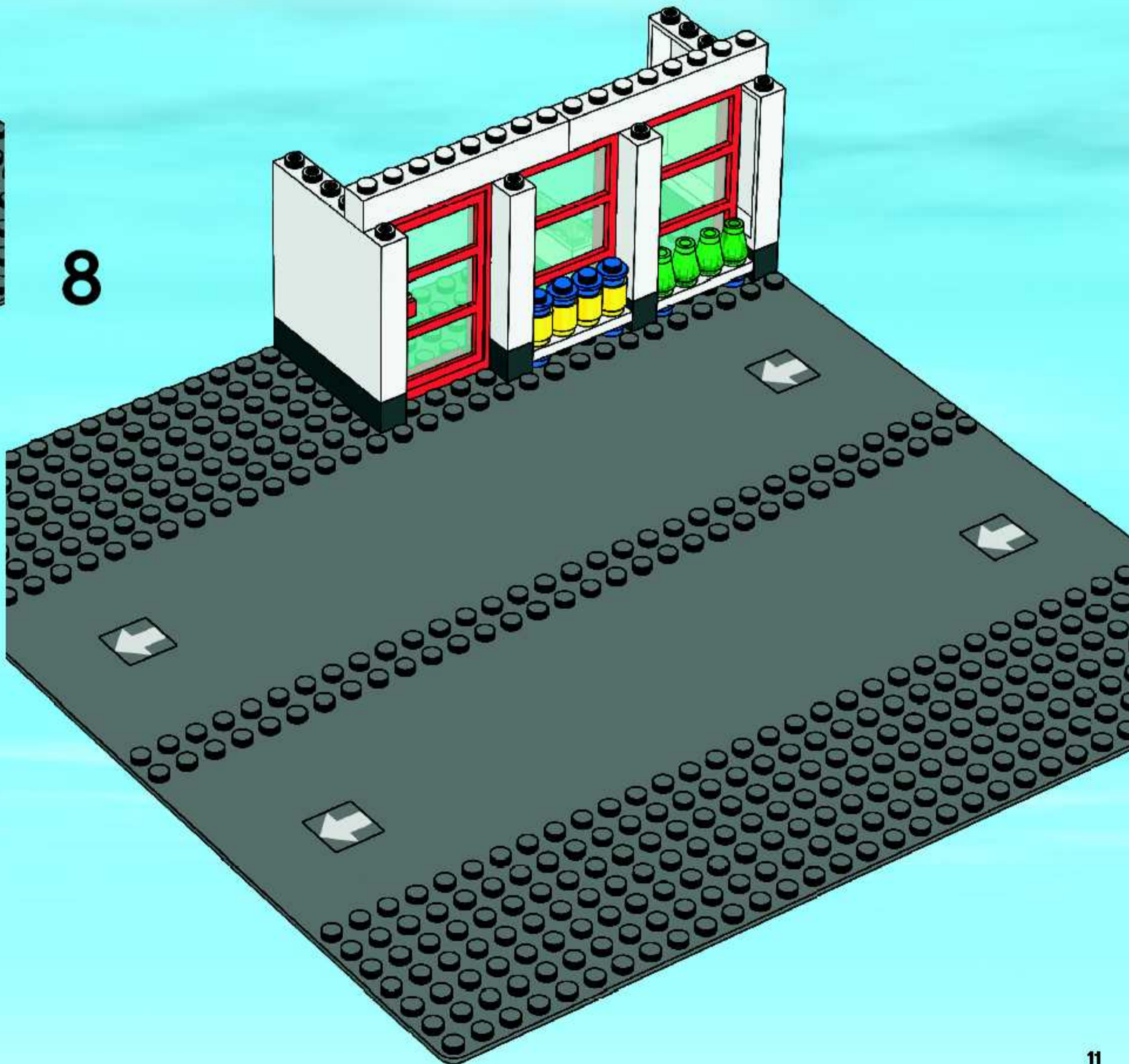

9

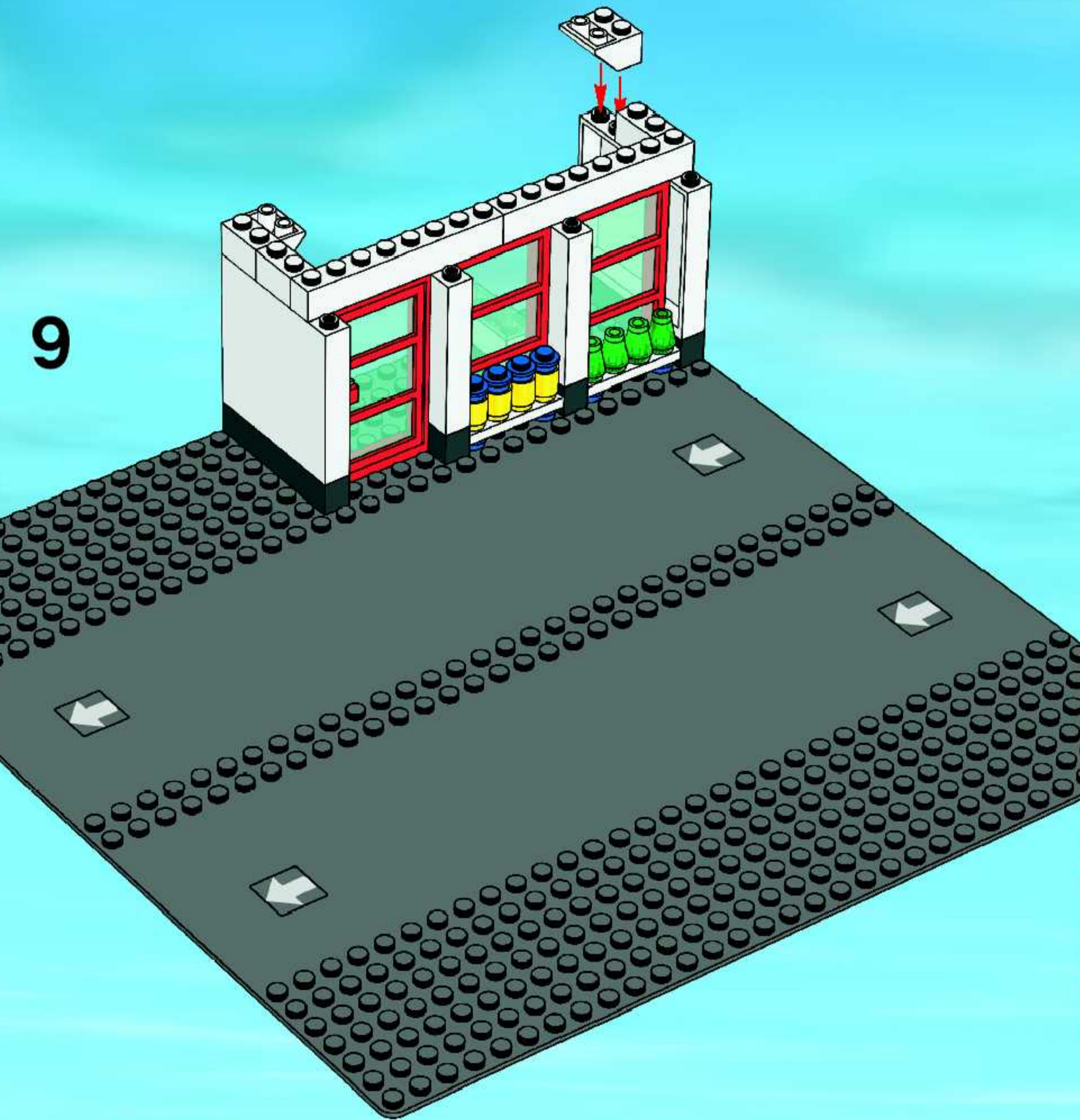

10

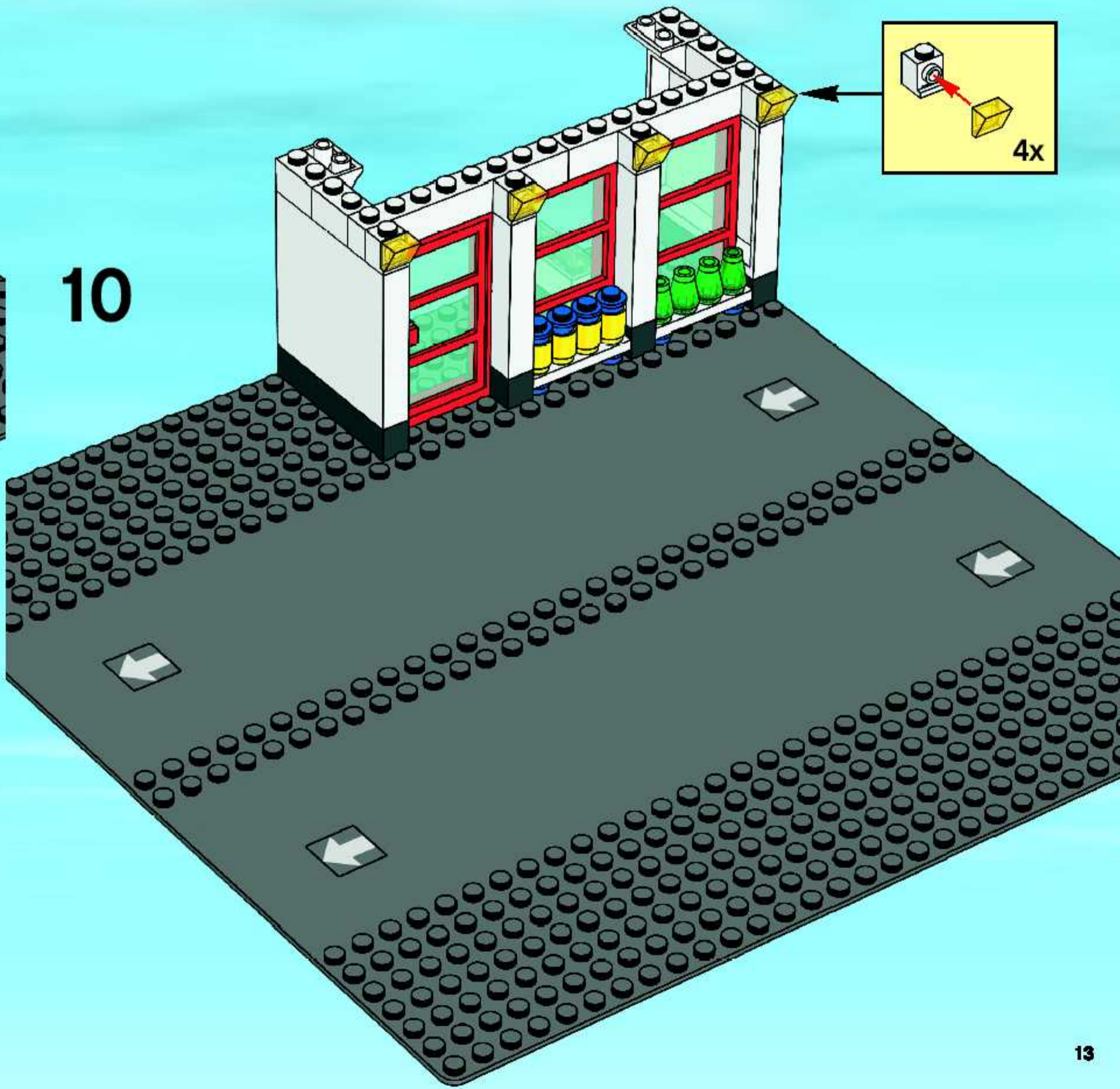

11

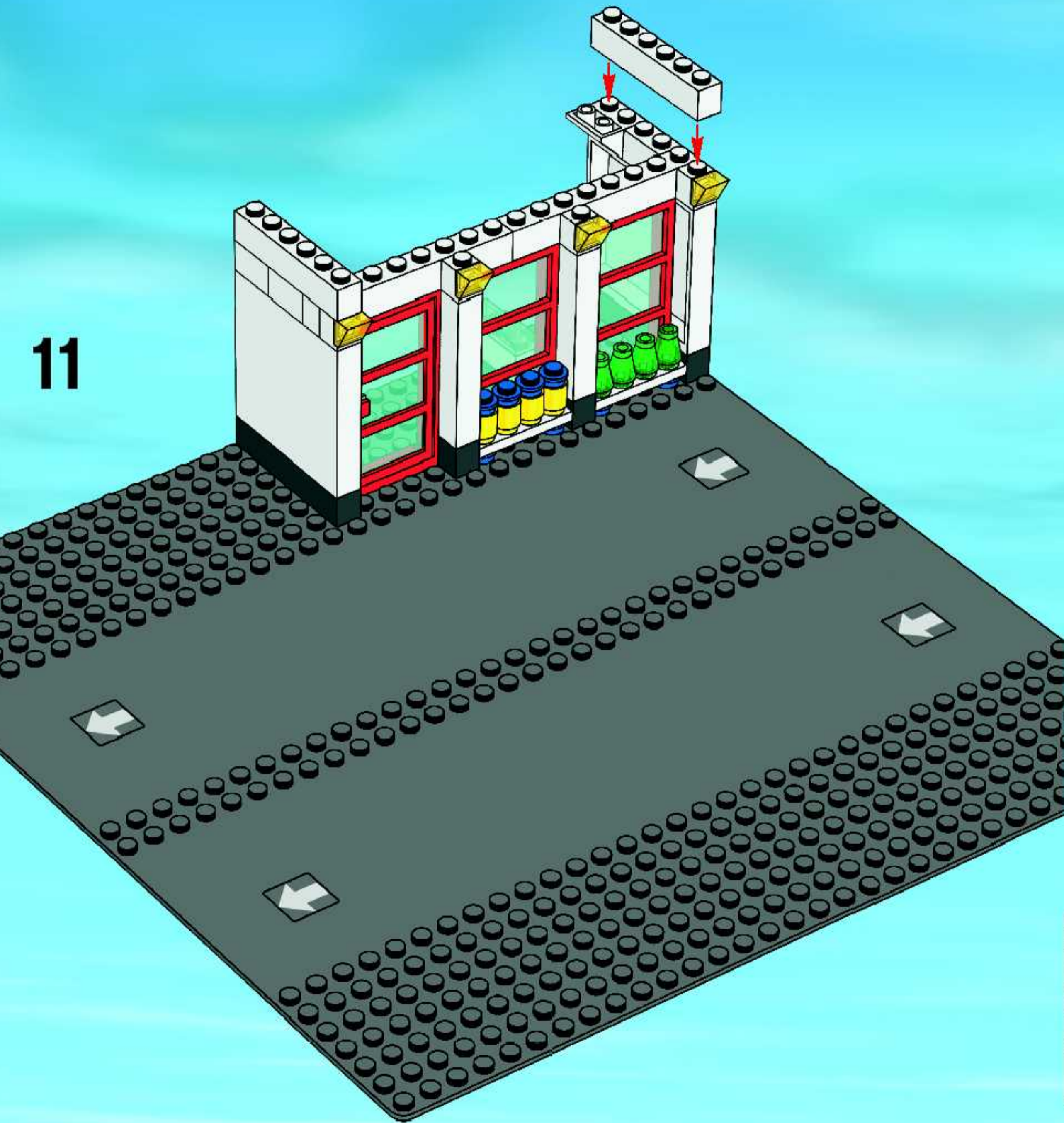

1

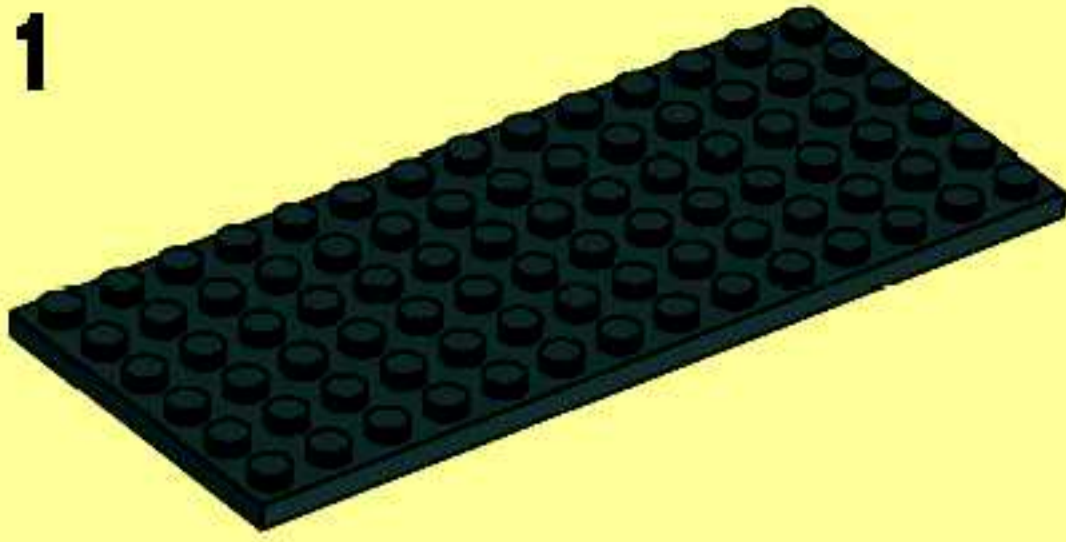

2

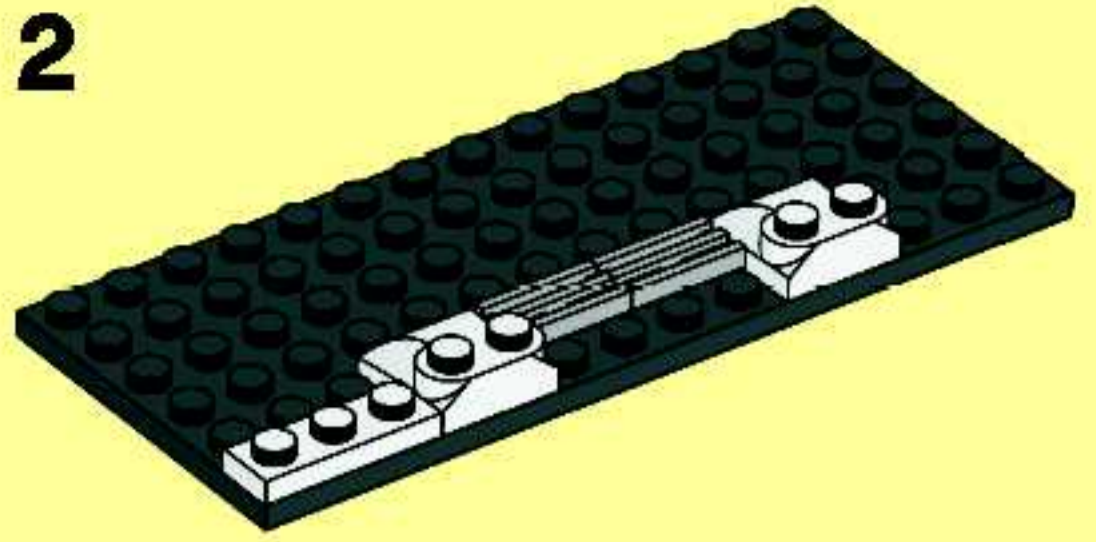

12

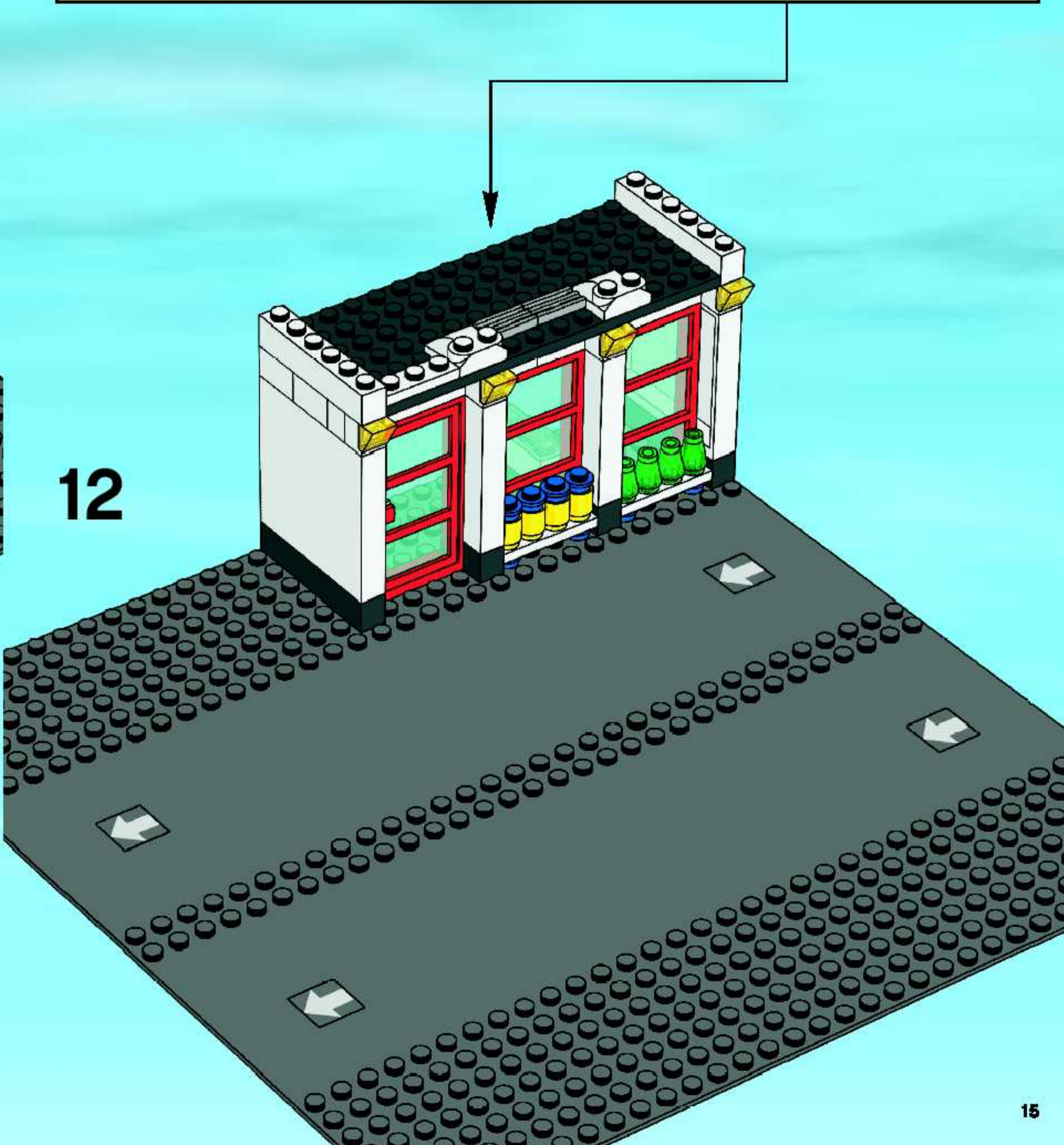

13

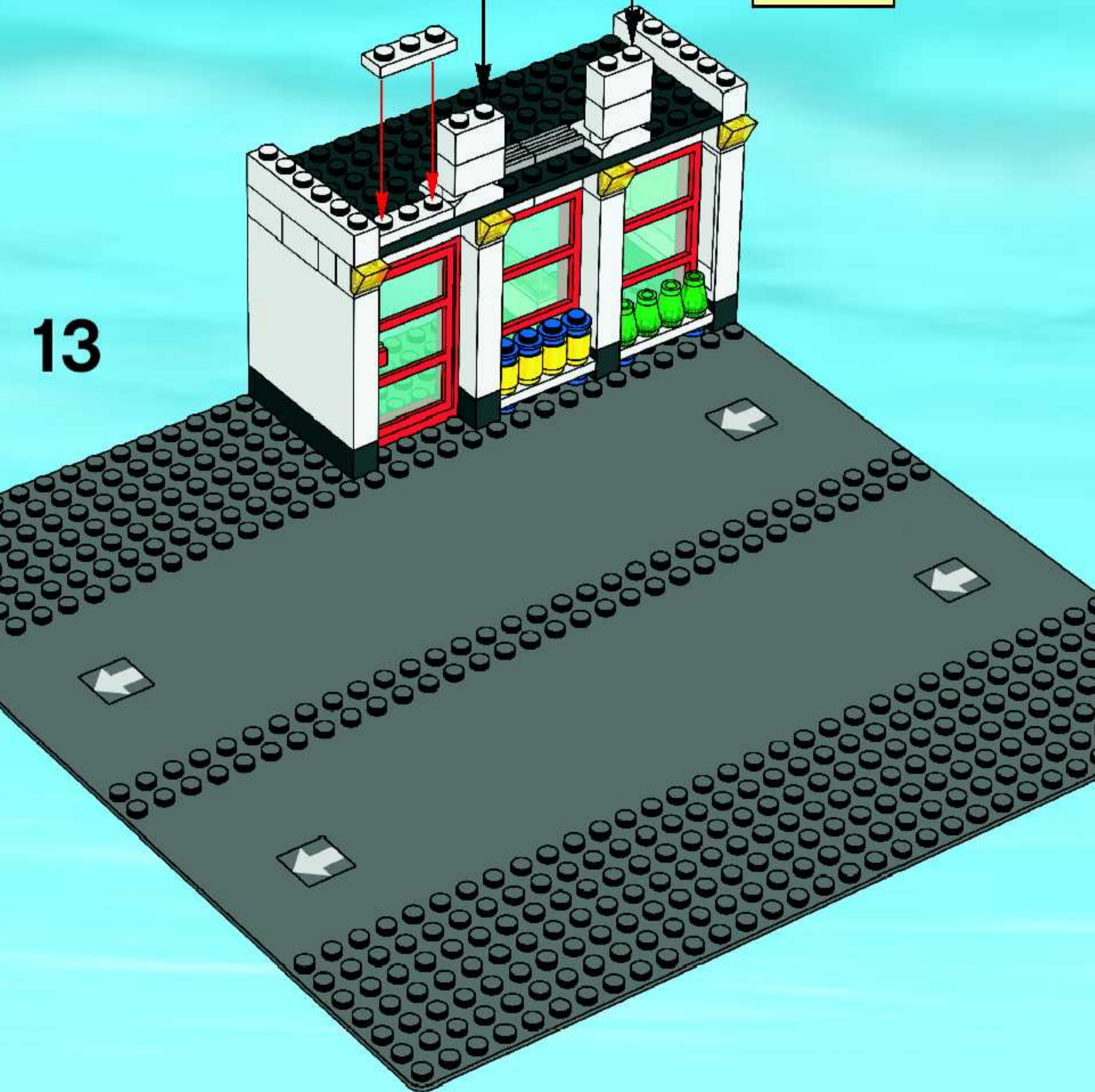
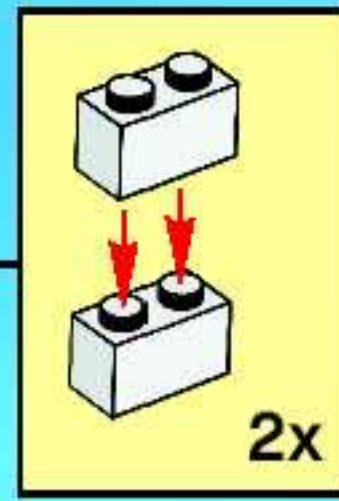



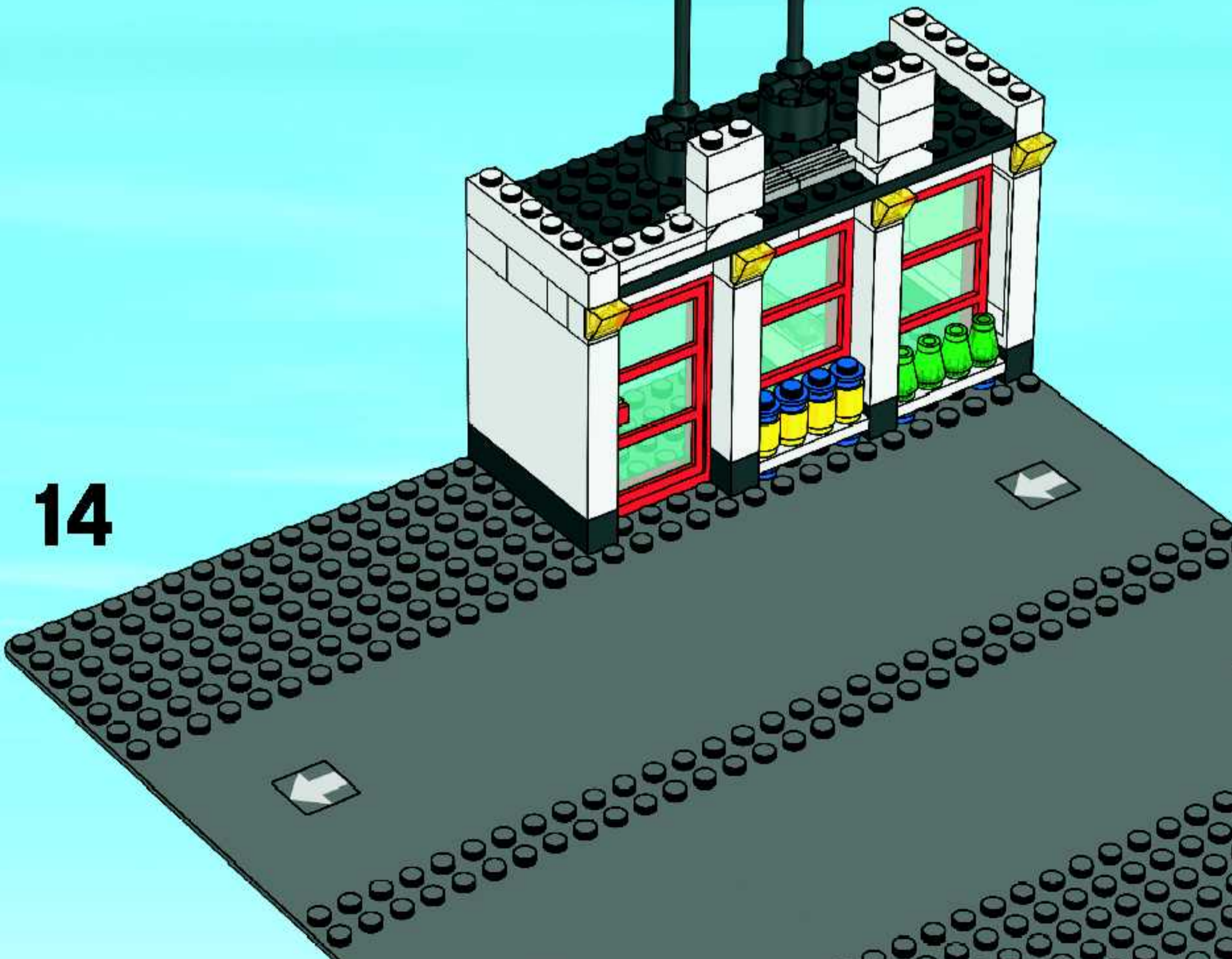
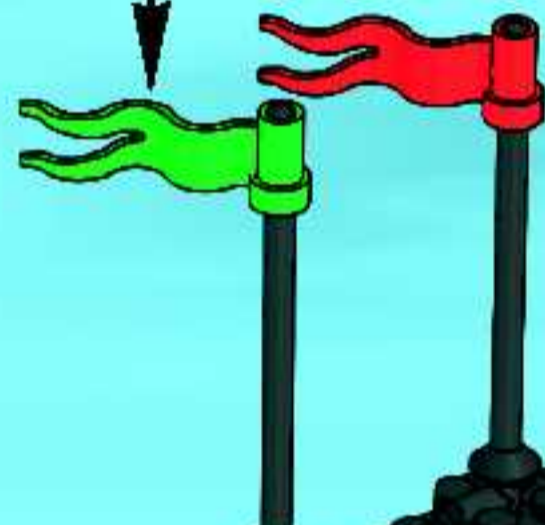
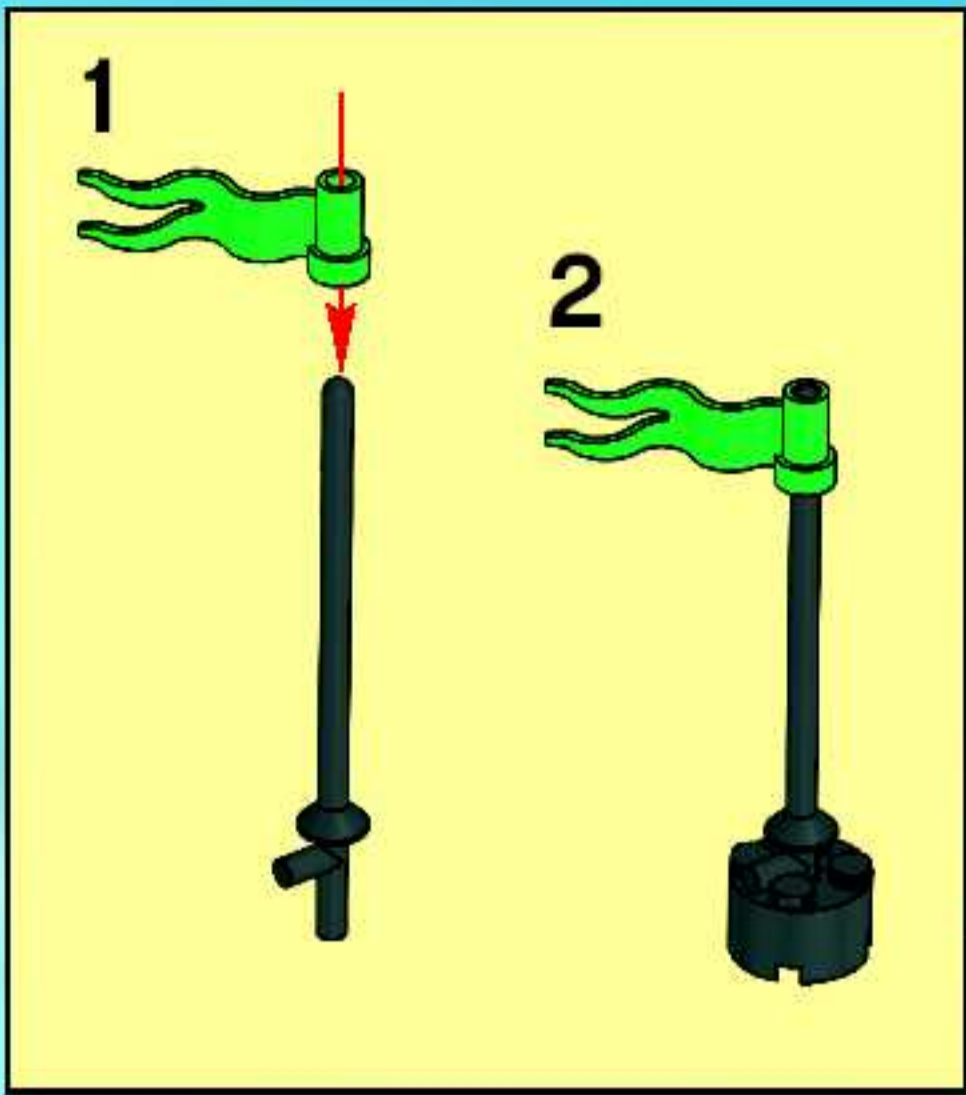

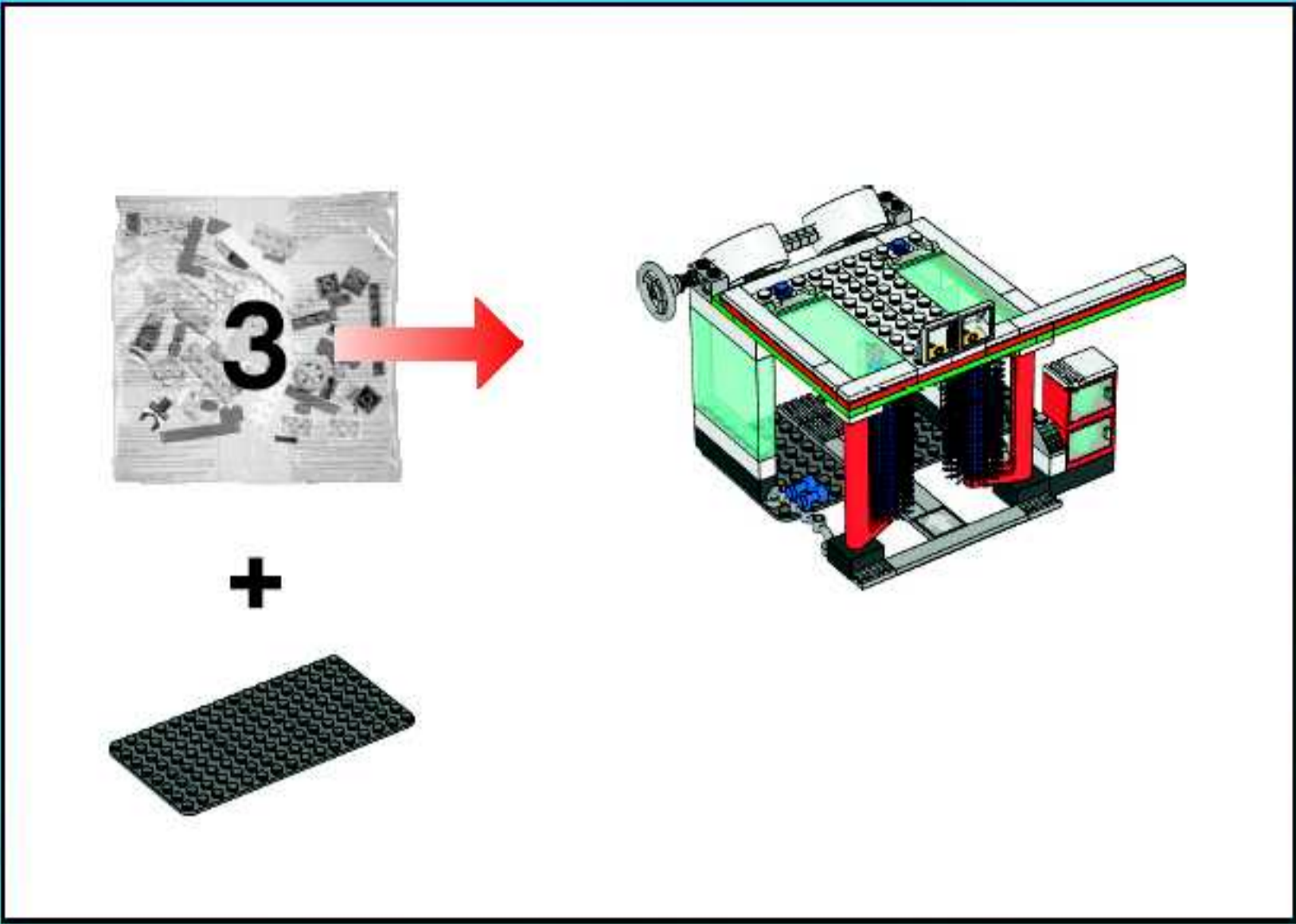

1

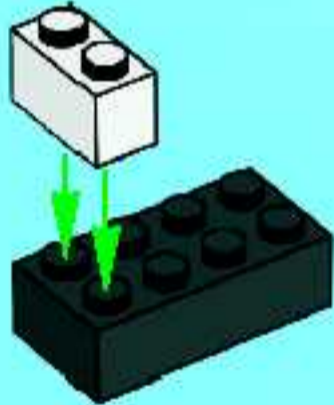

2



3

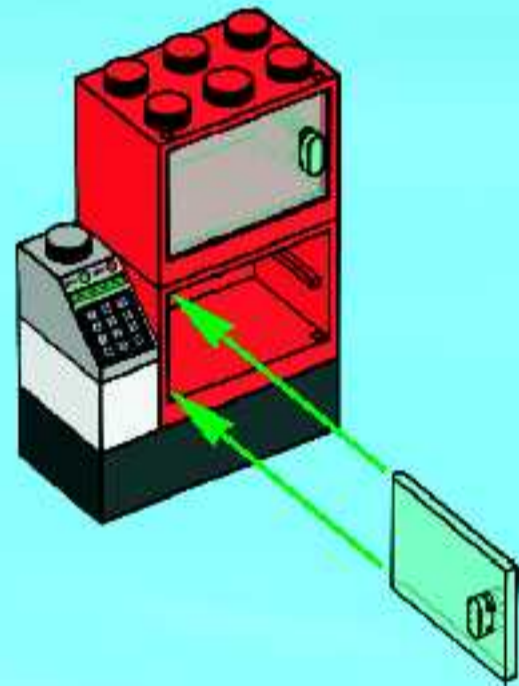

4

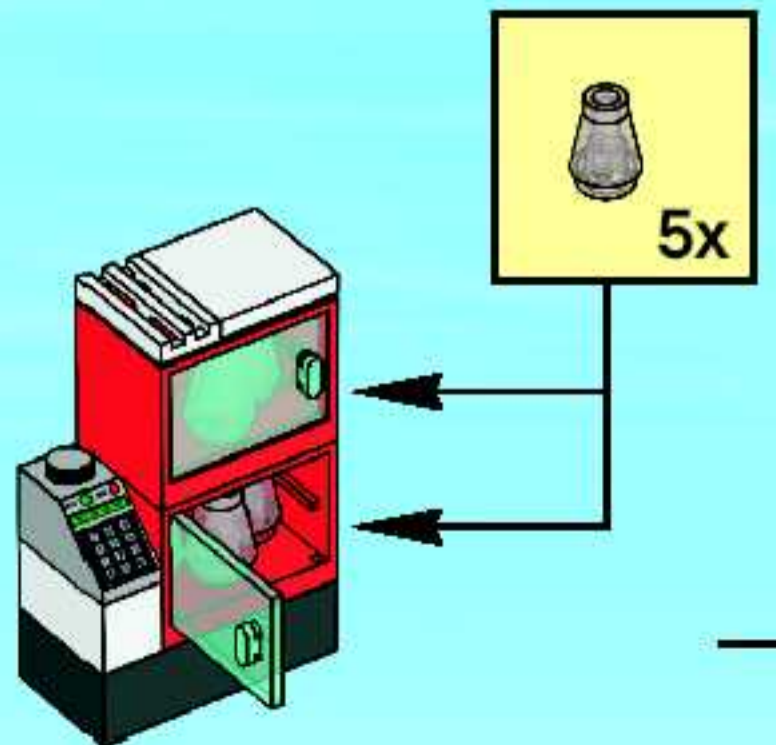

15

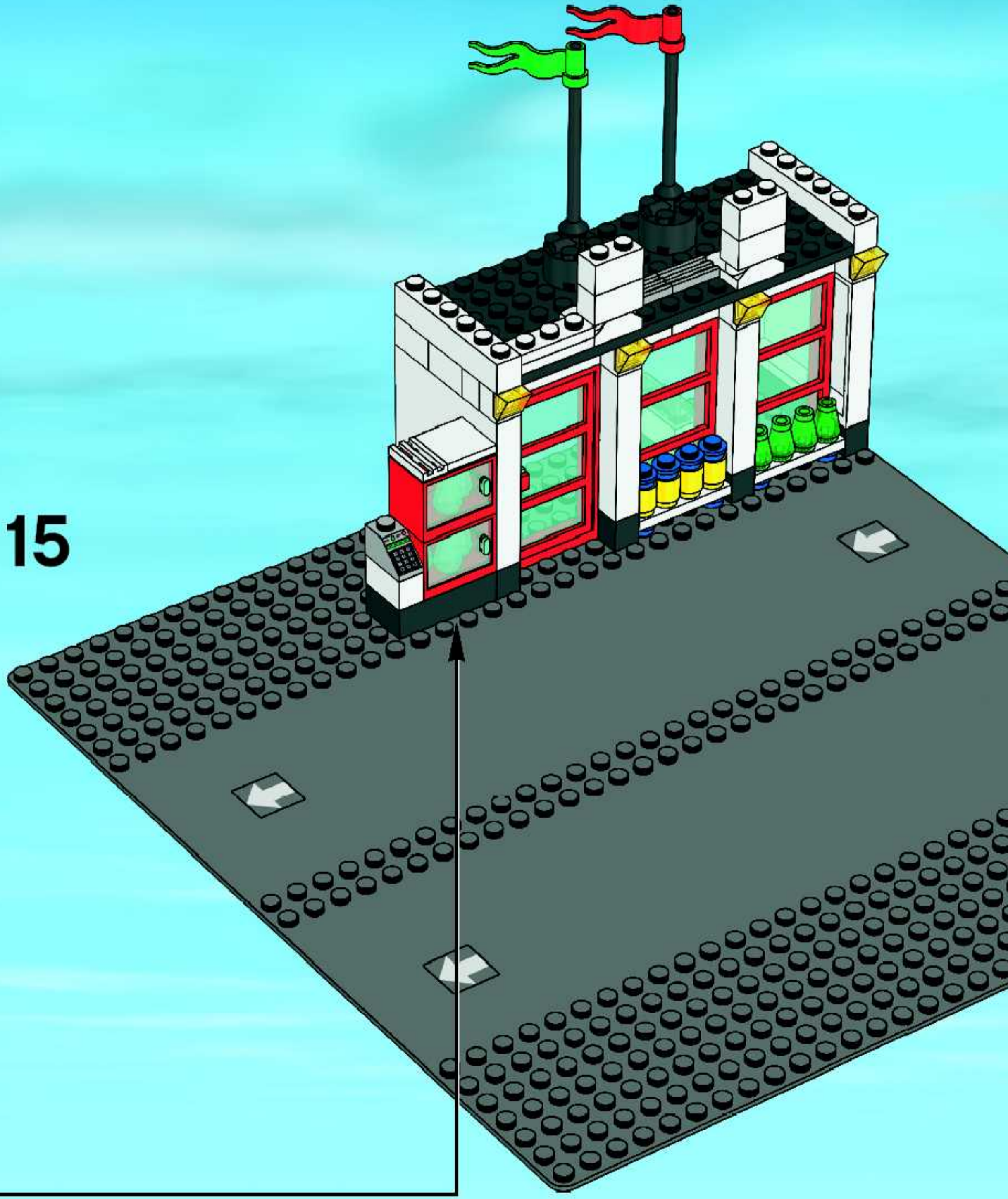

16

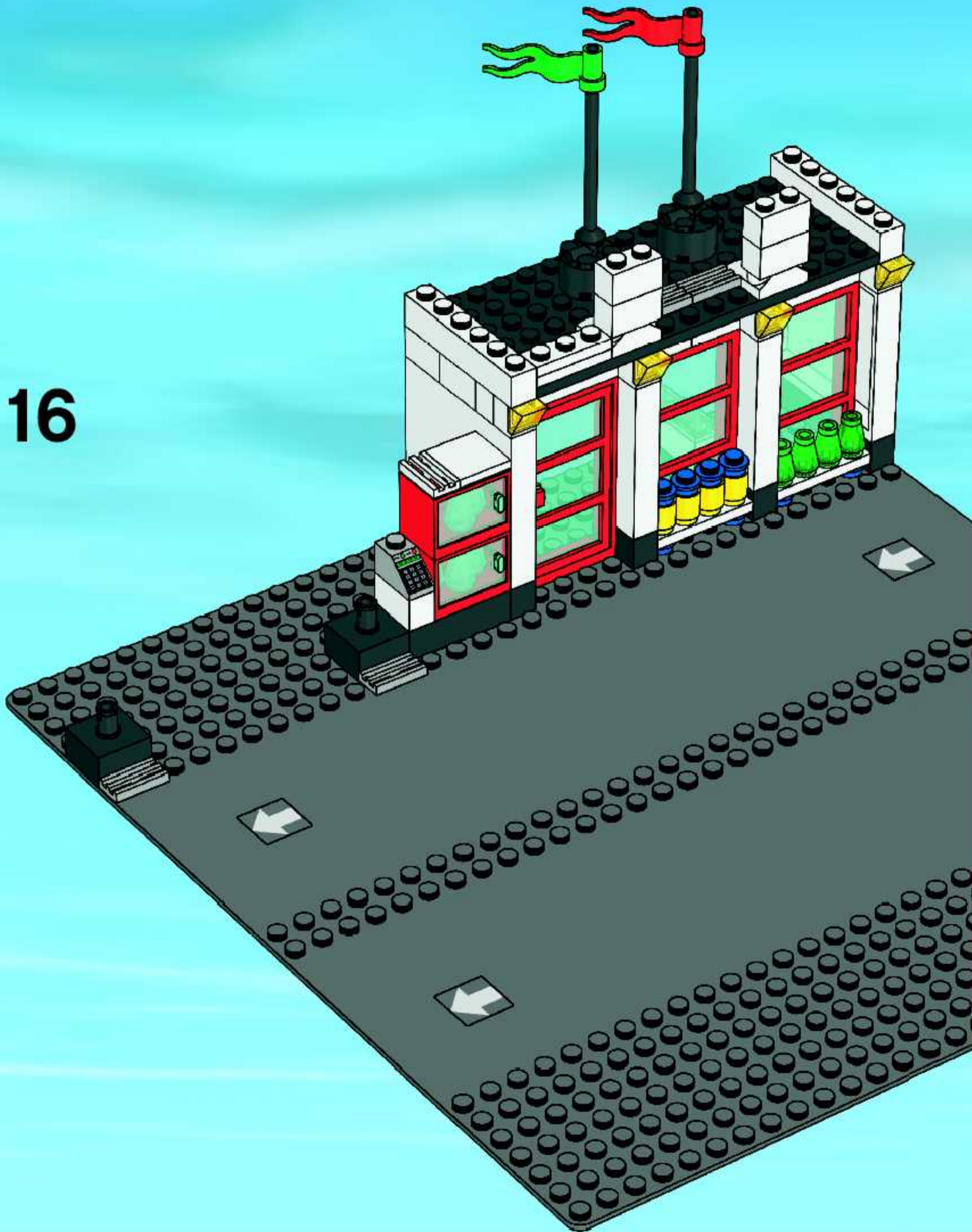

17

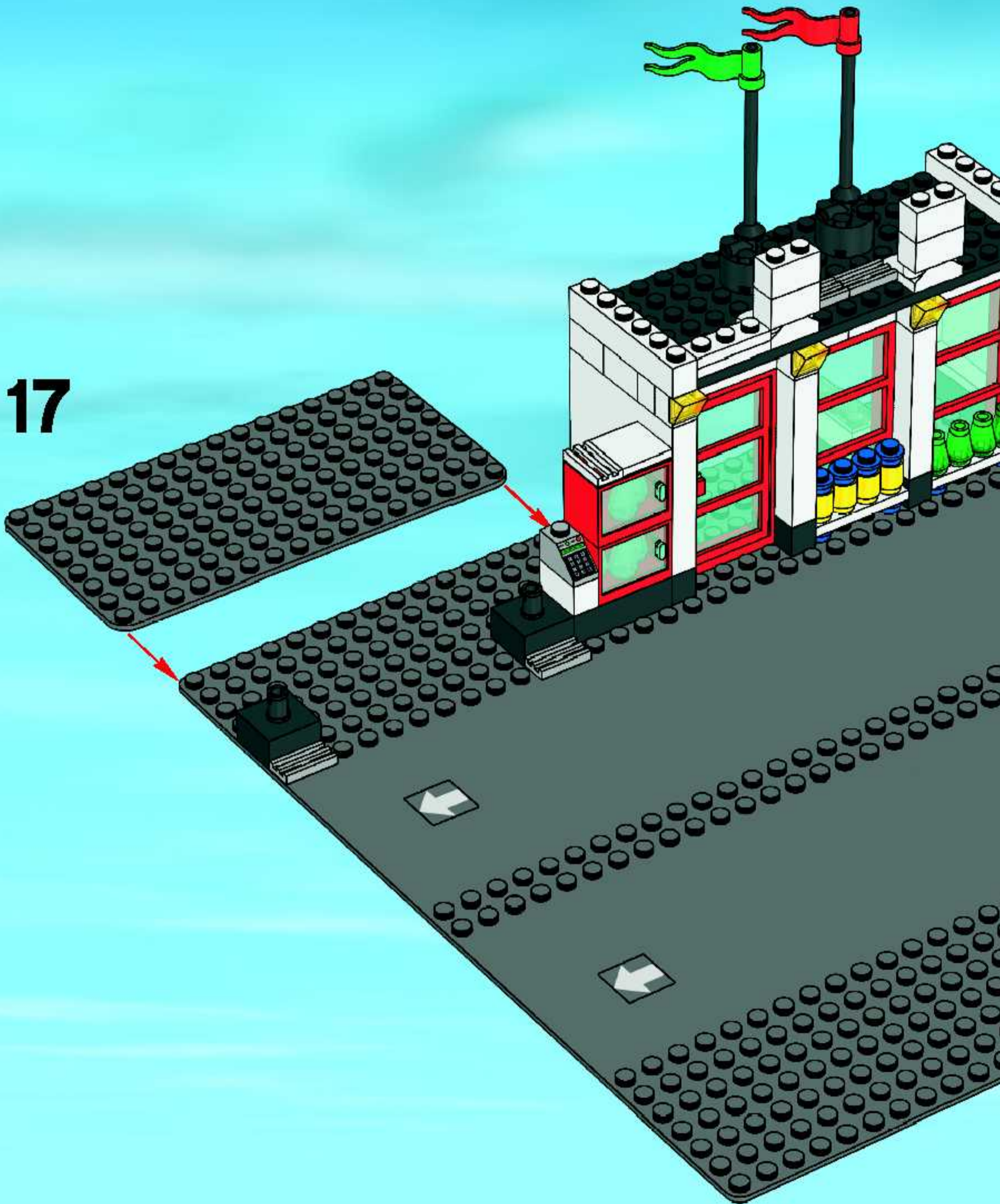

18

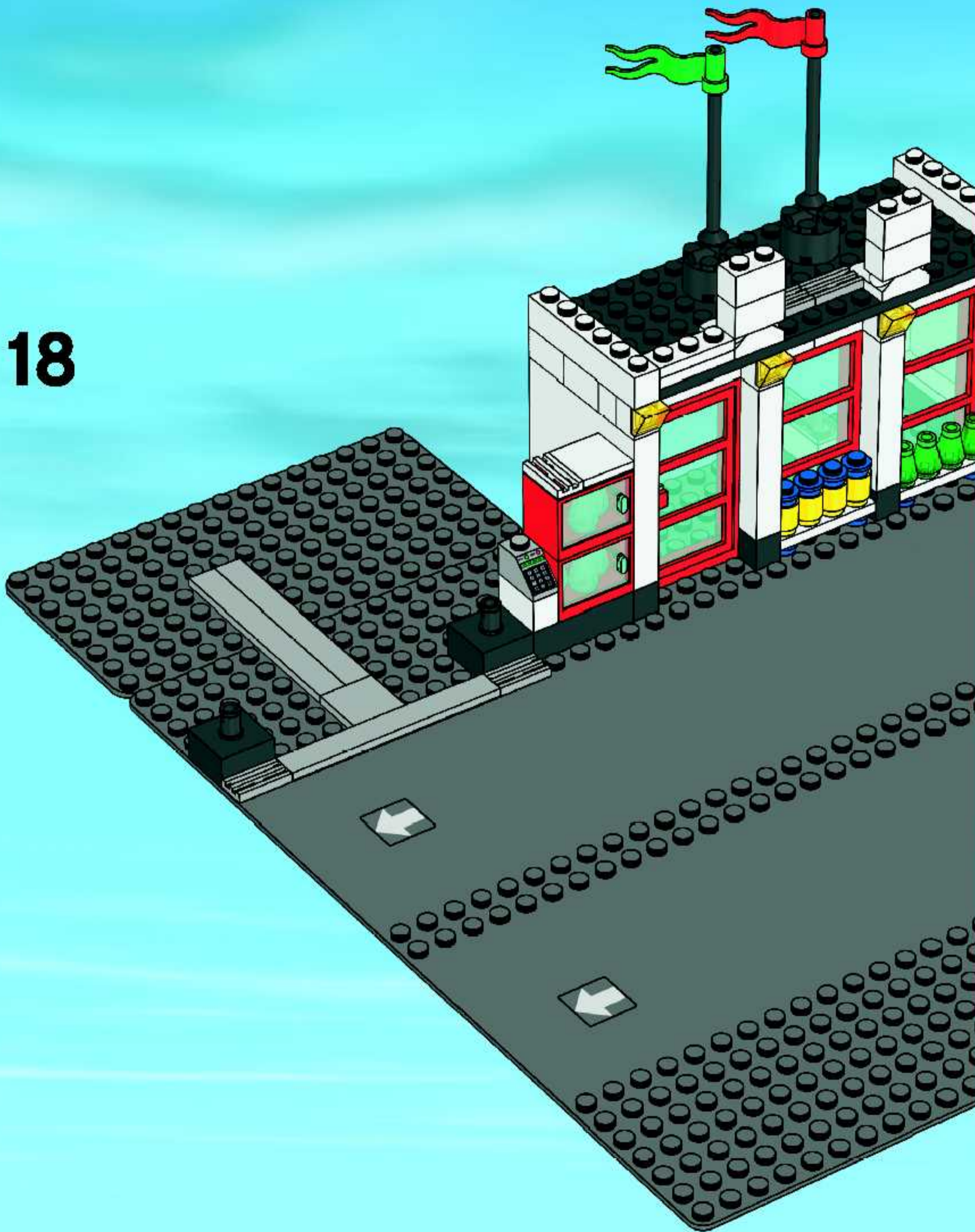

19

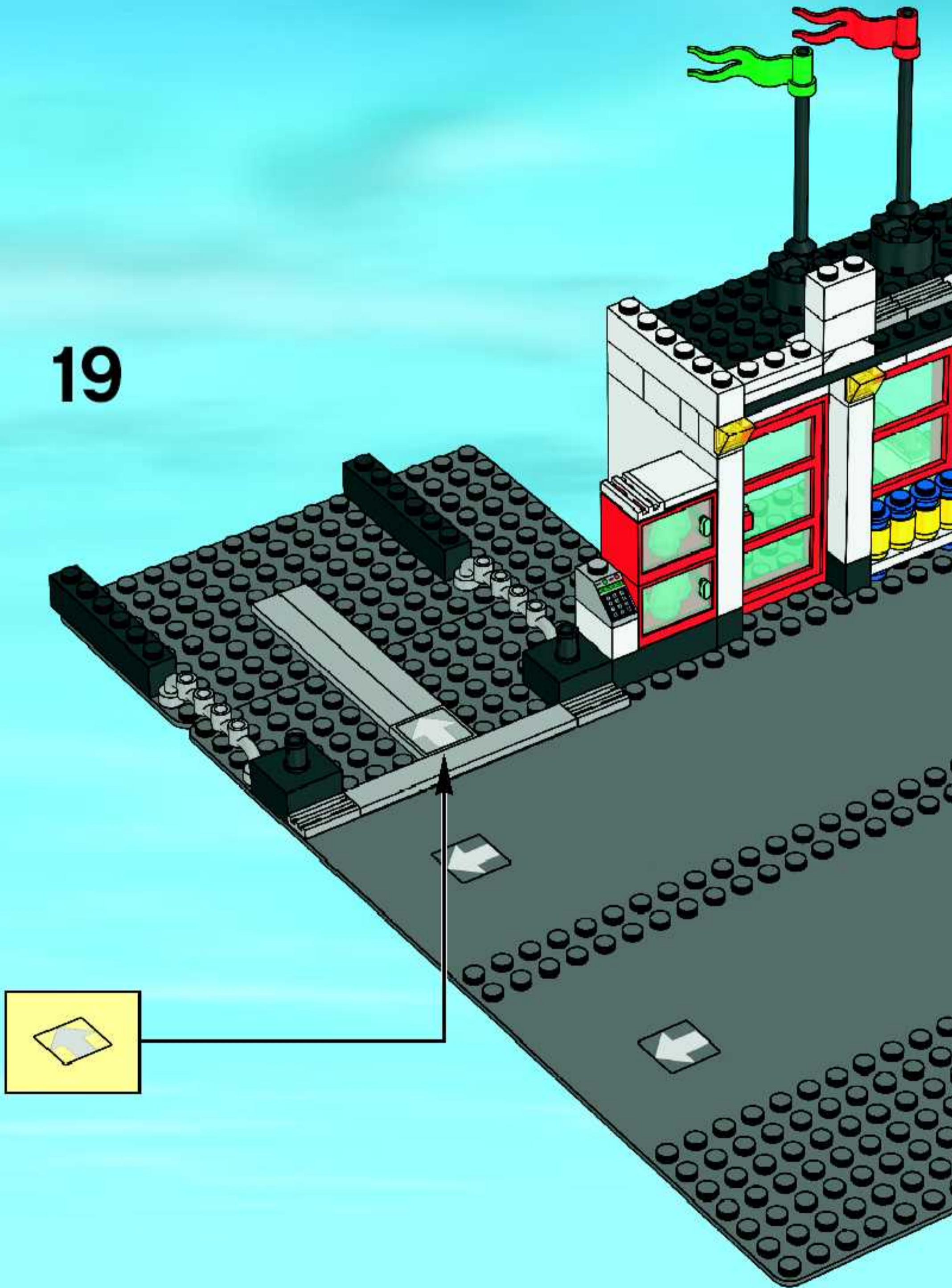

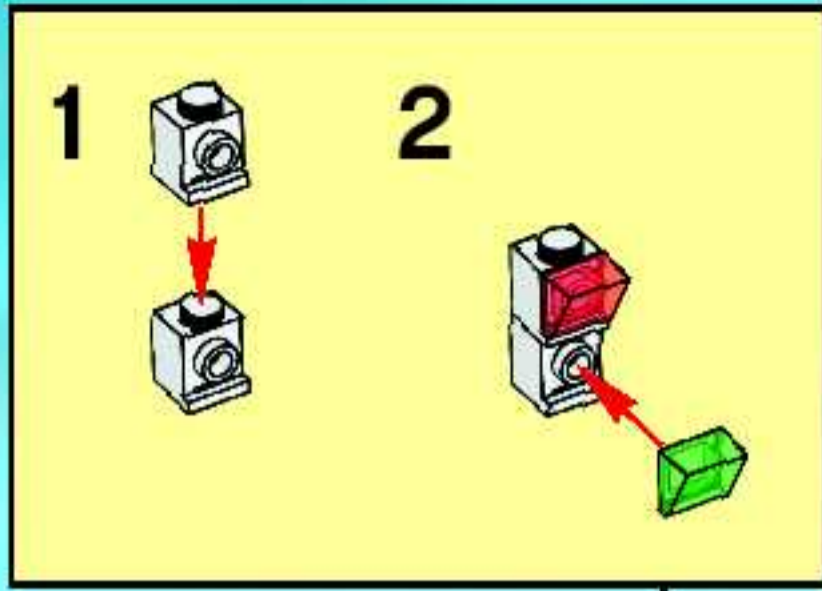

20

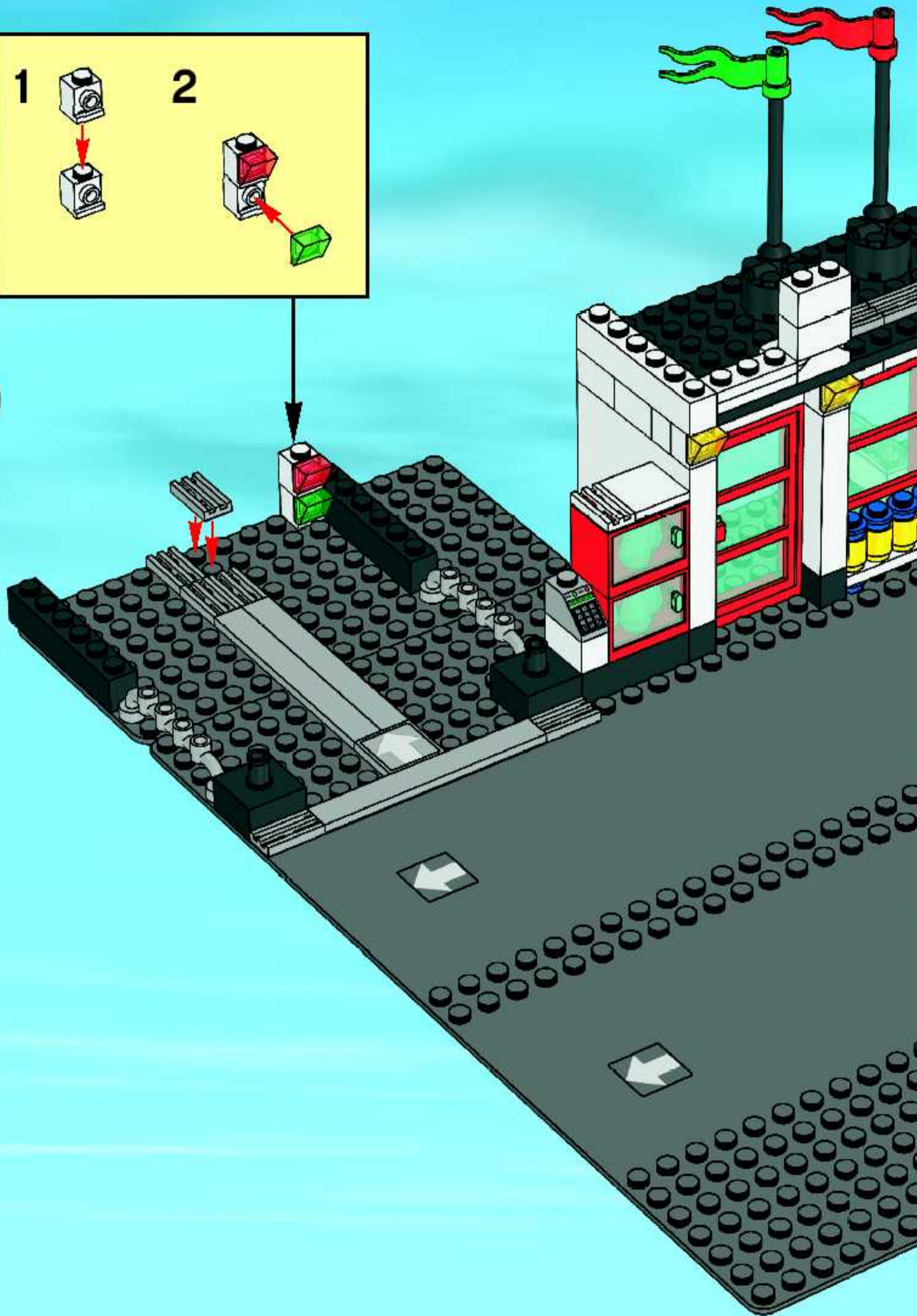



21

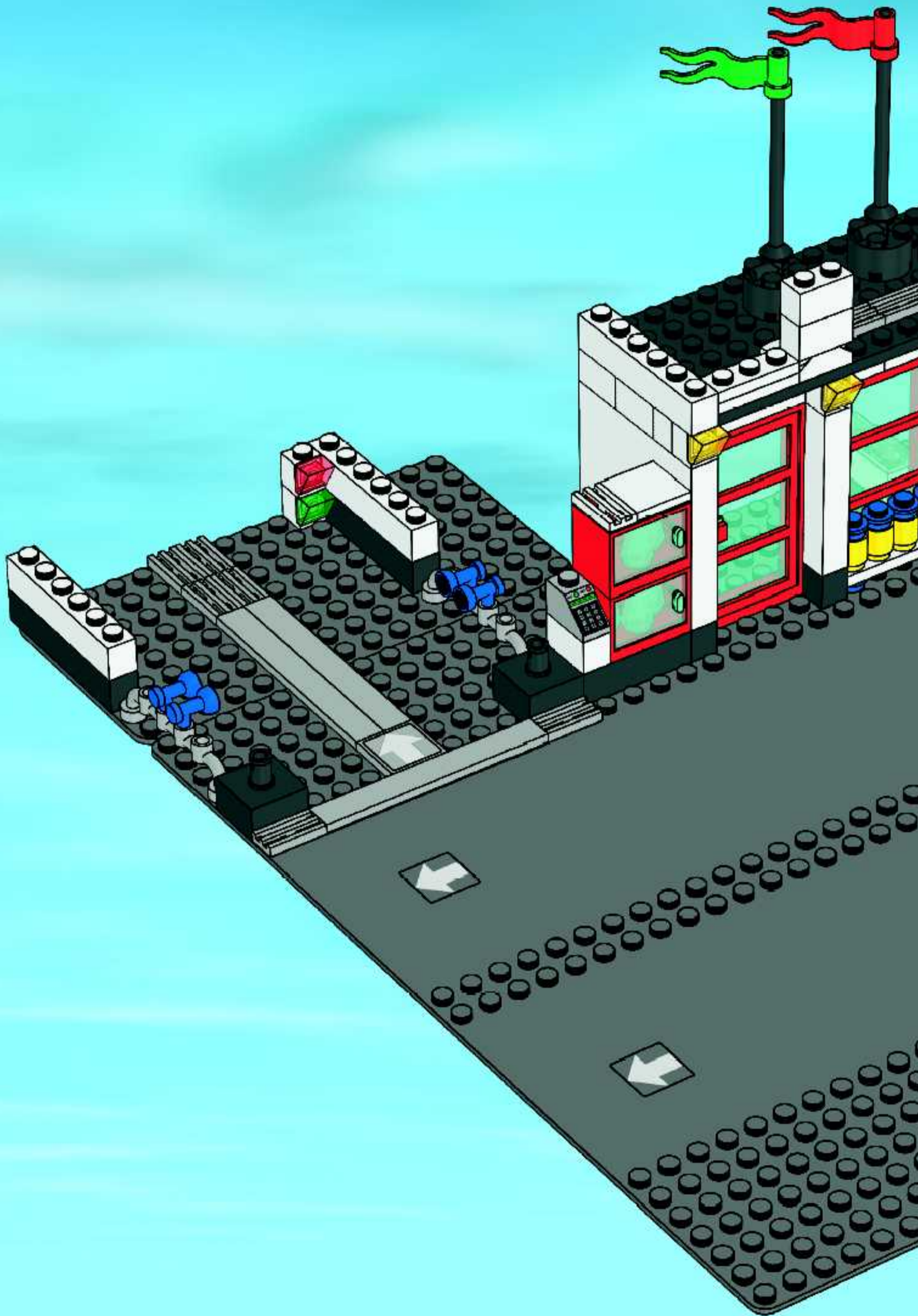

22

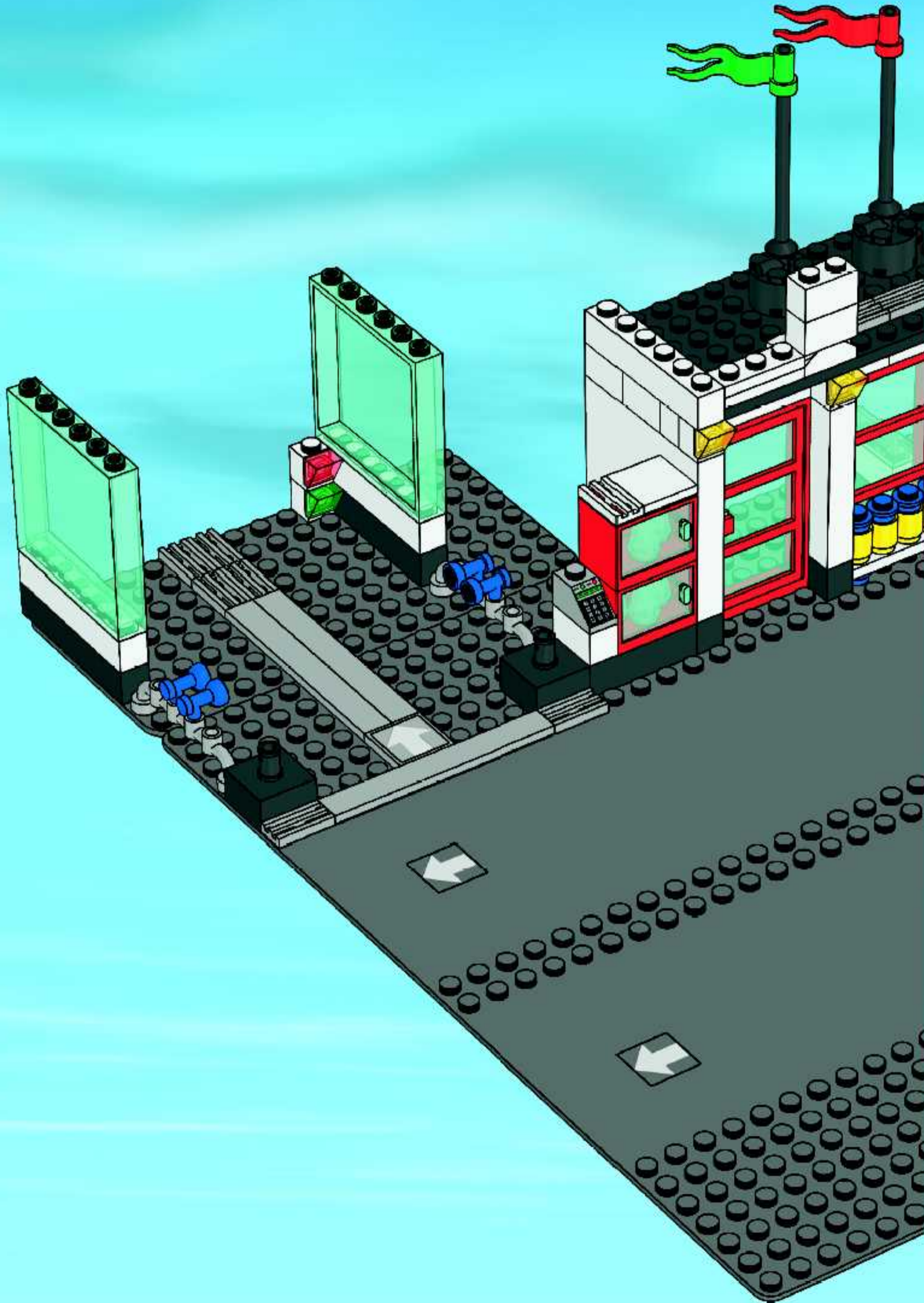

23

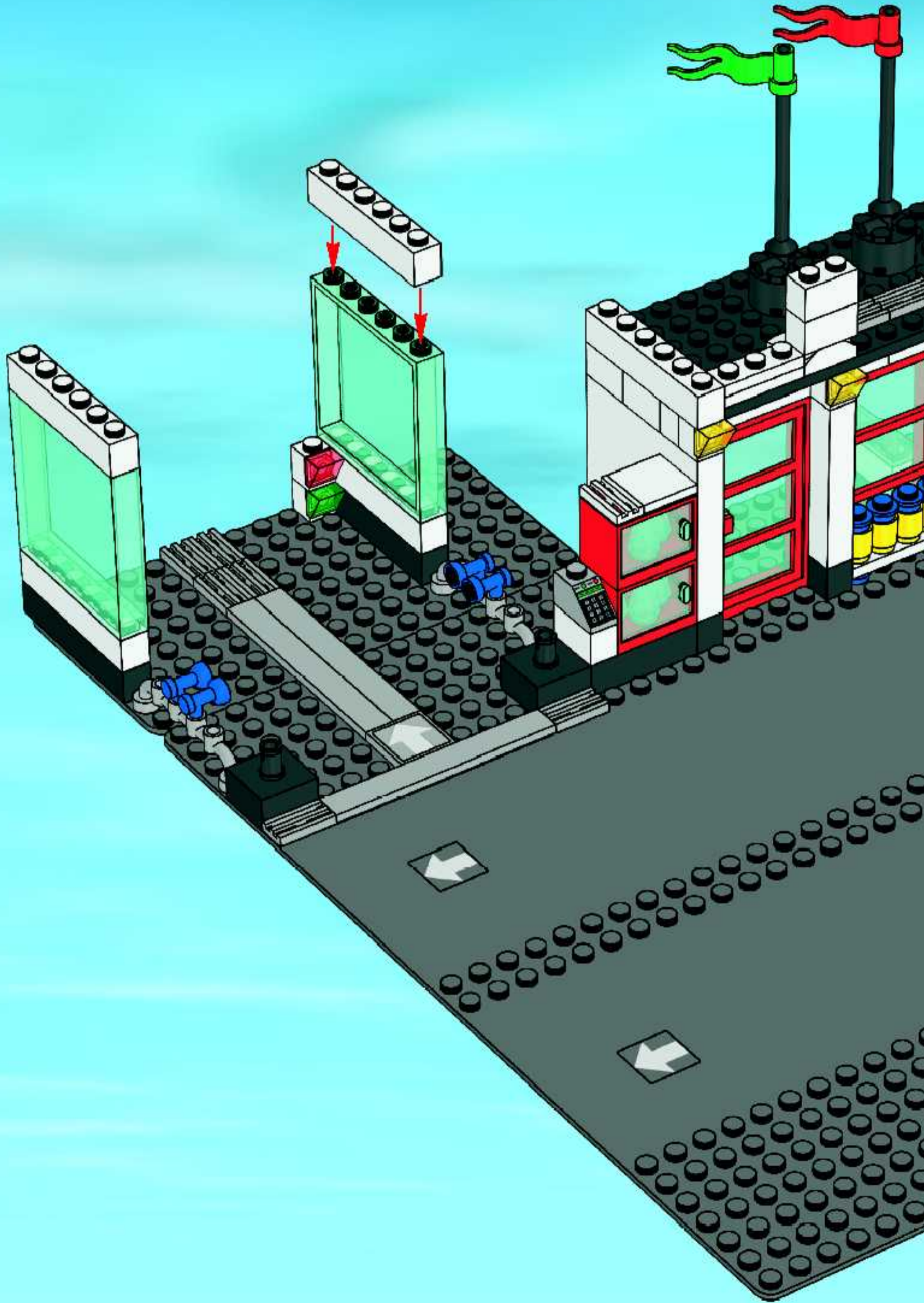

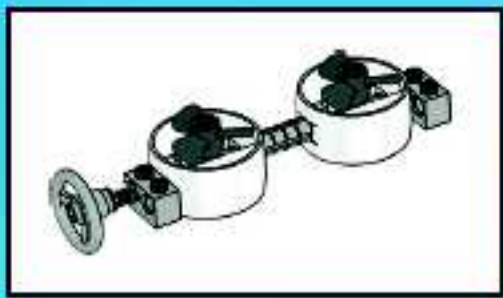

1

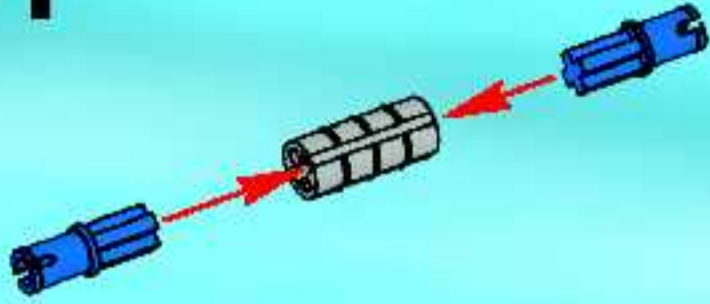

2

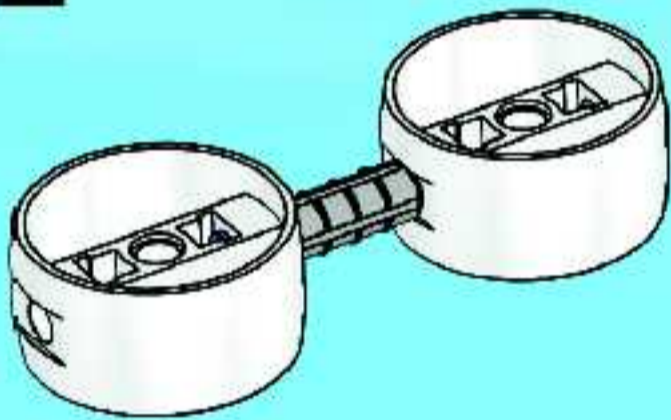

3

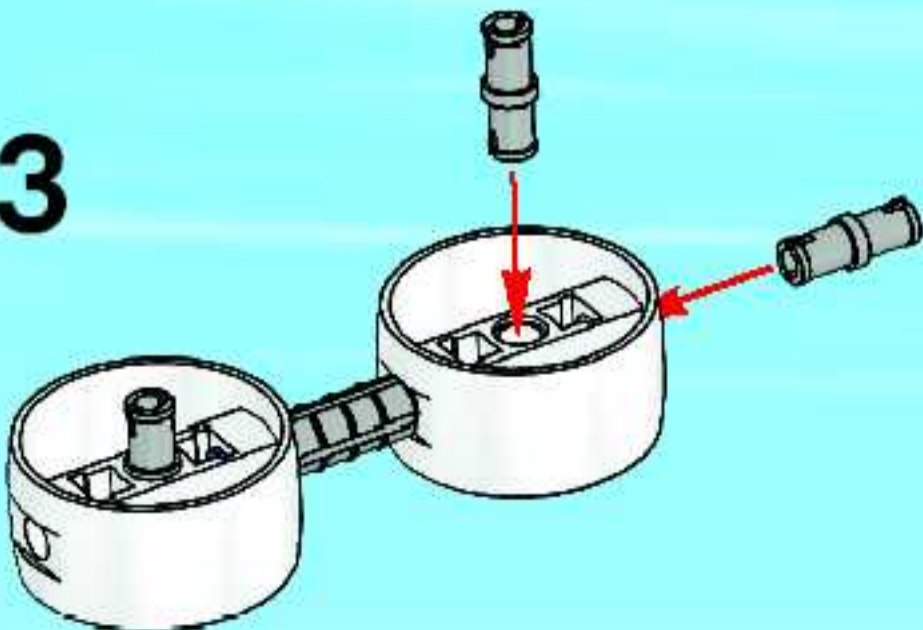

4



1

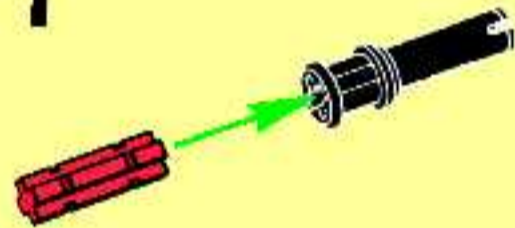

2

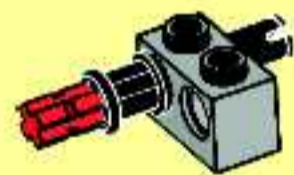

3

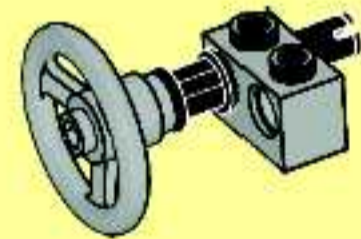

5

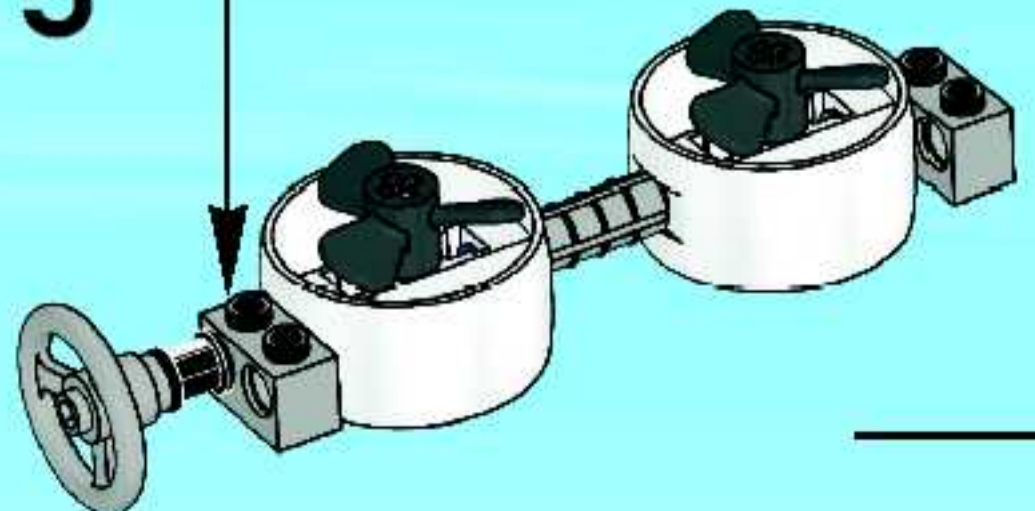

# 24

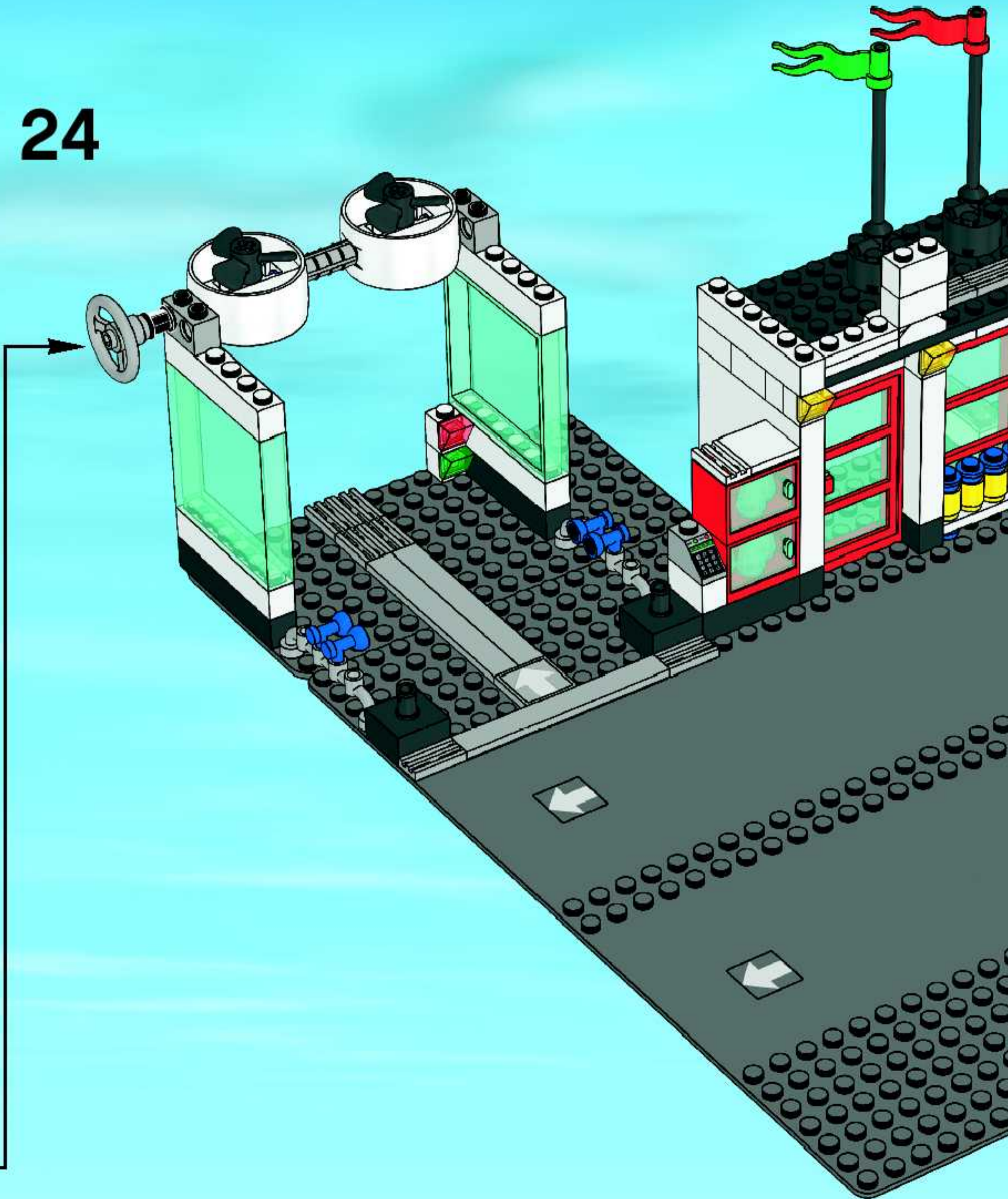



1



3

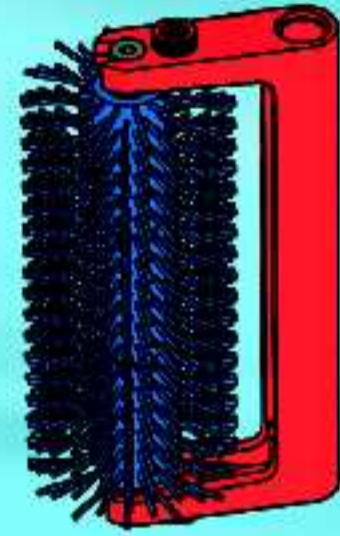

2



4



2x

25

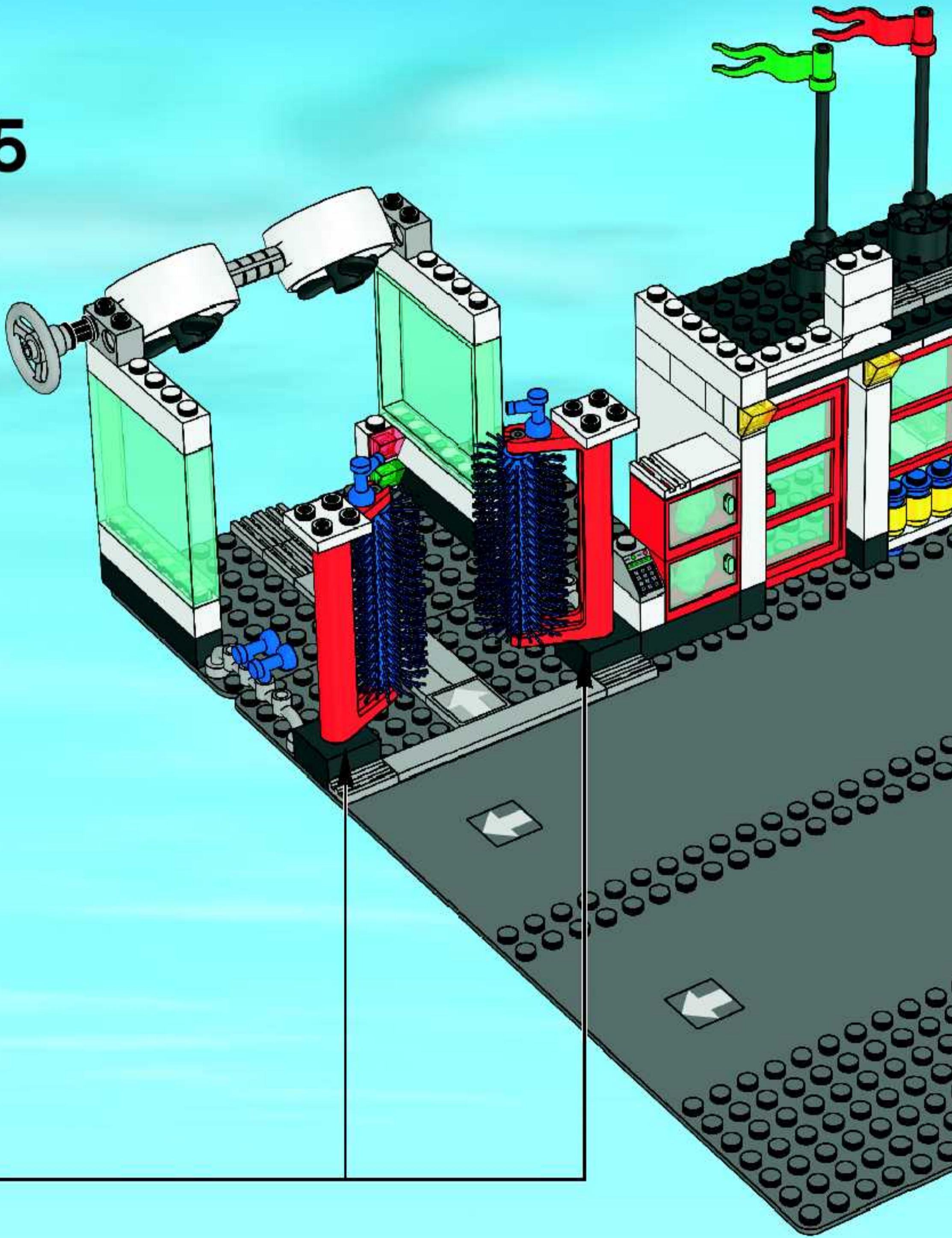

26

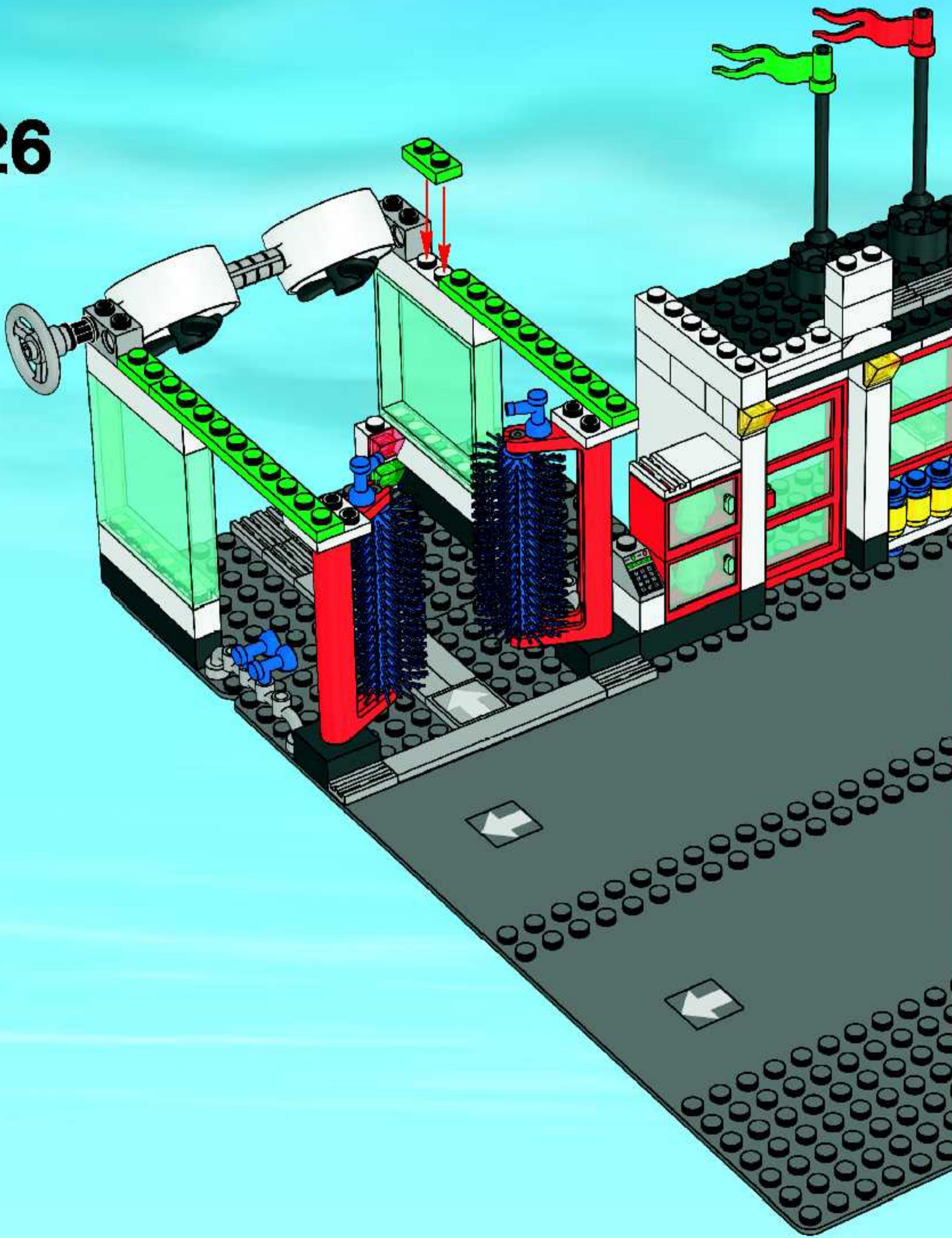



27

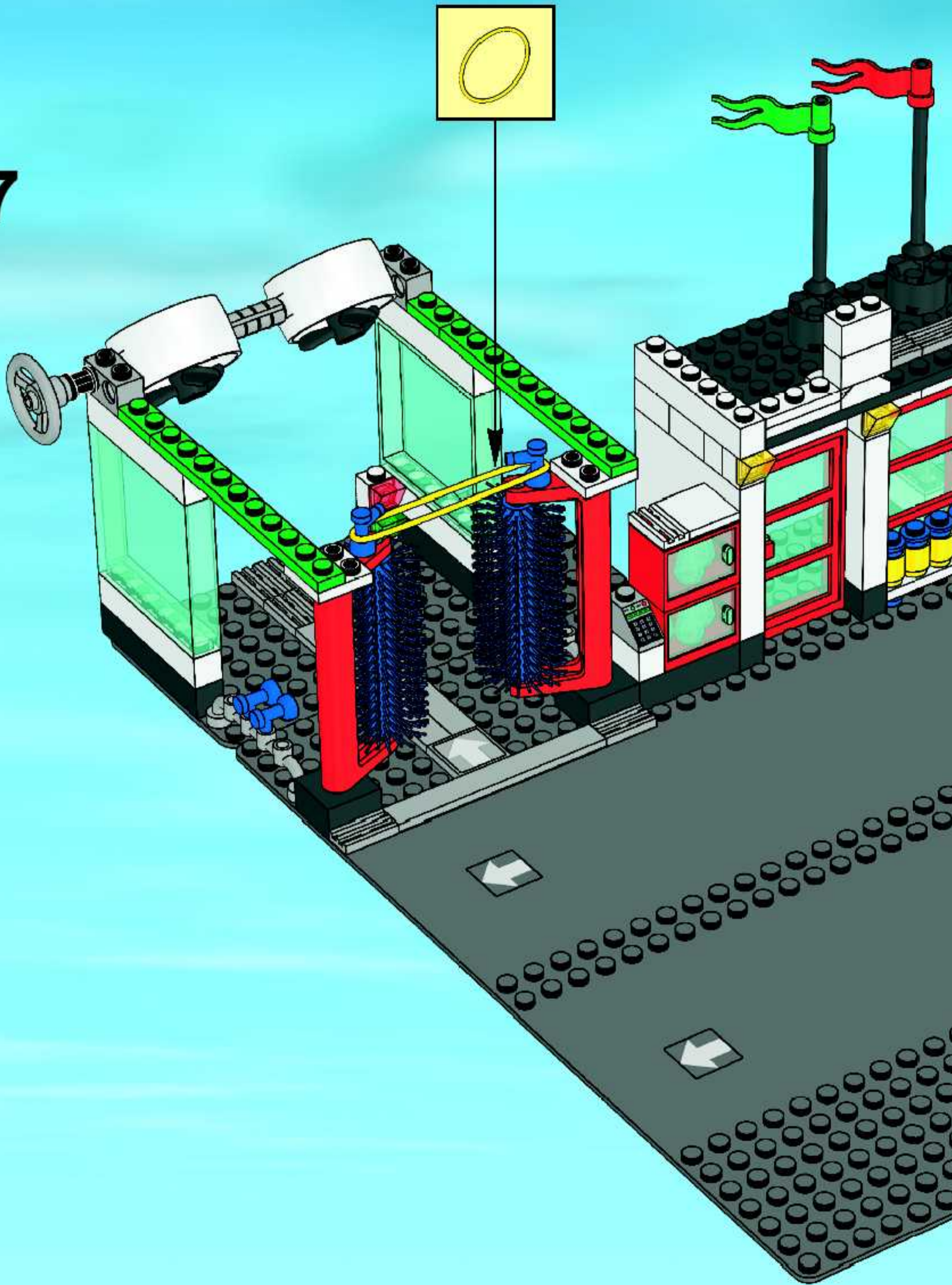

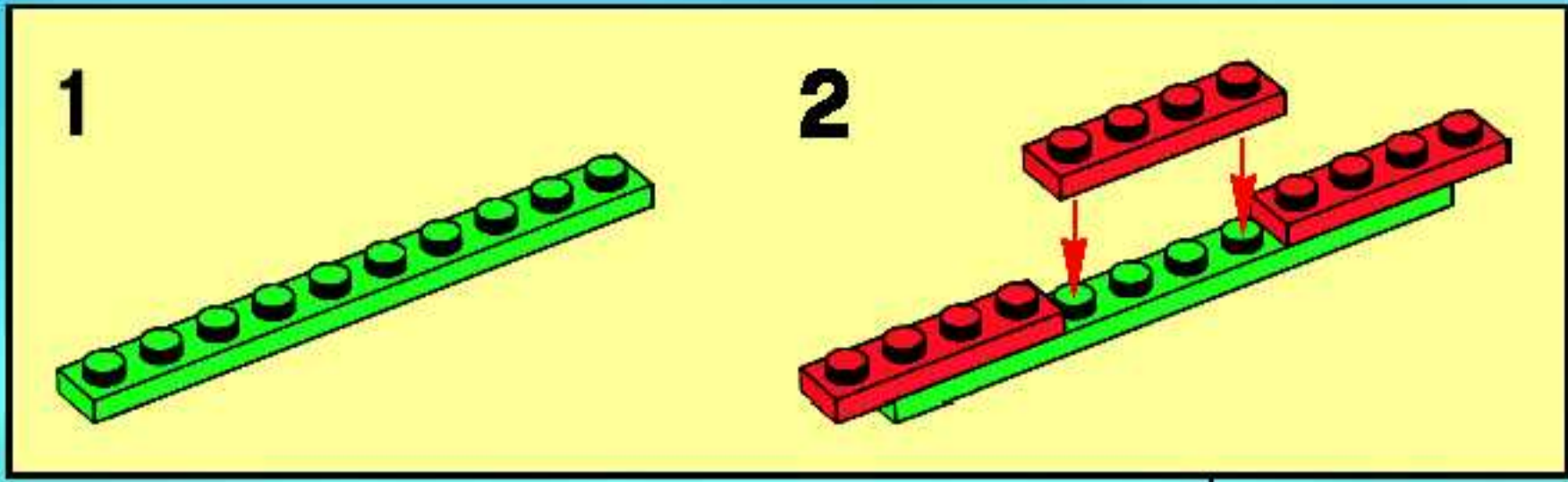

28

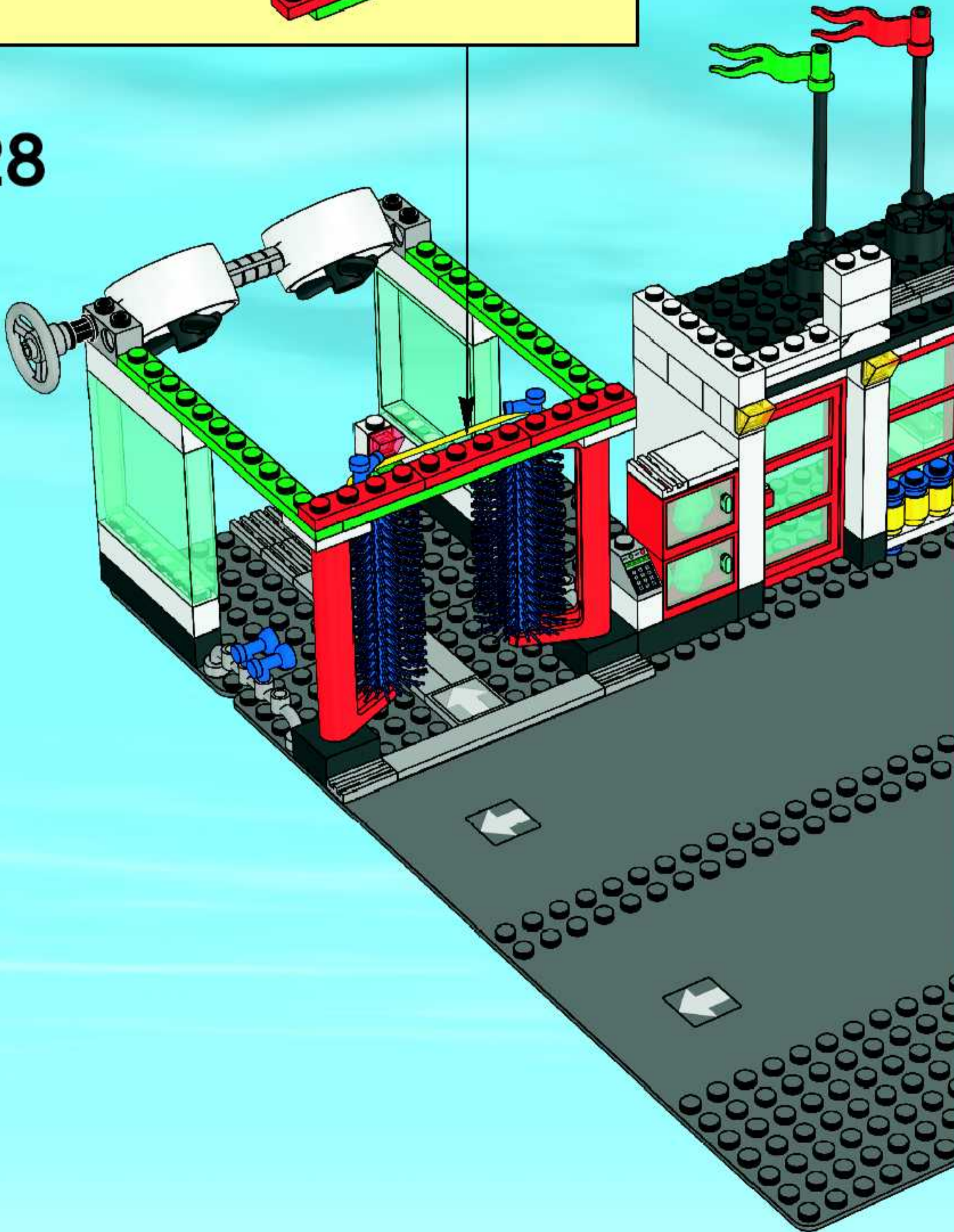

29

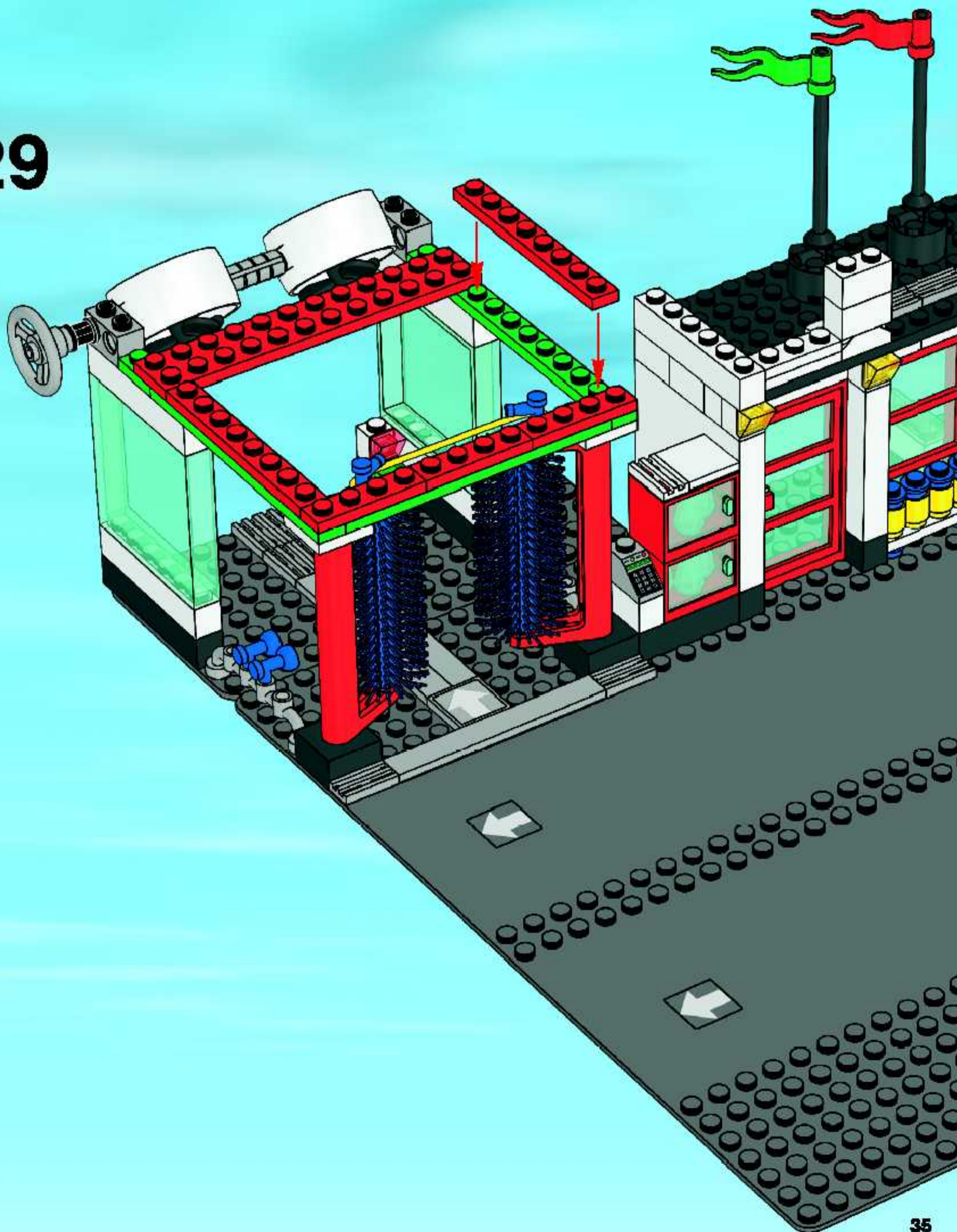

30

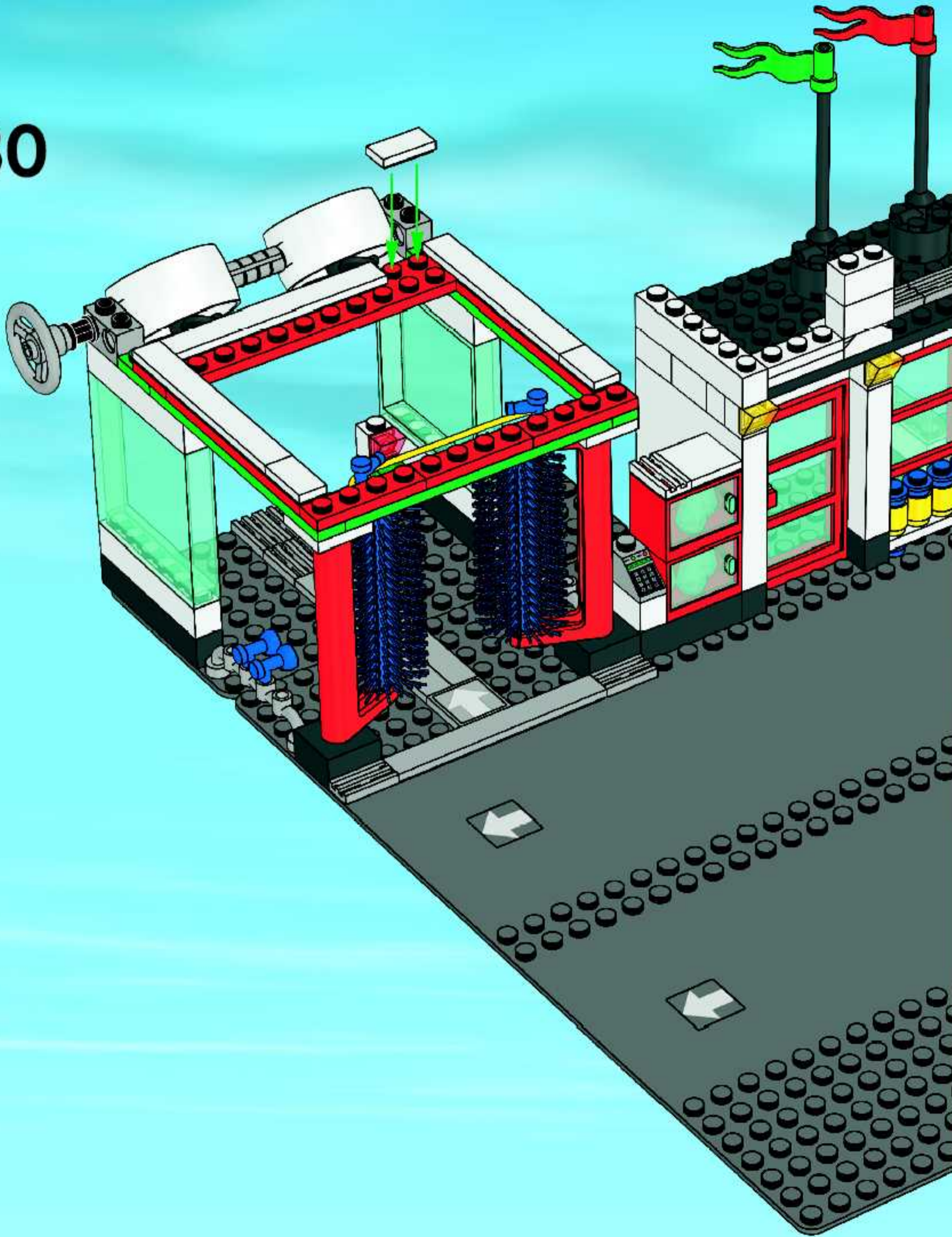

31

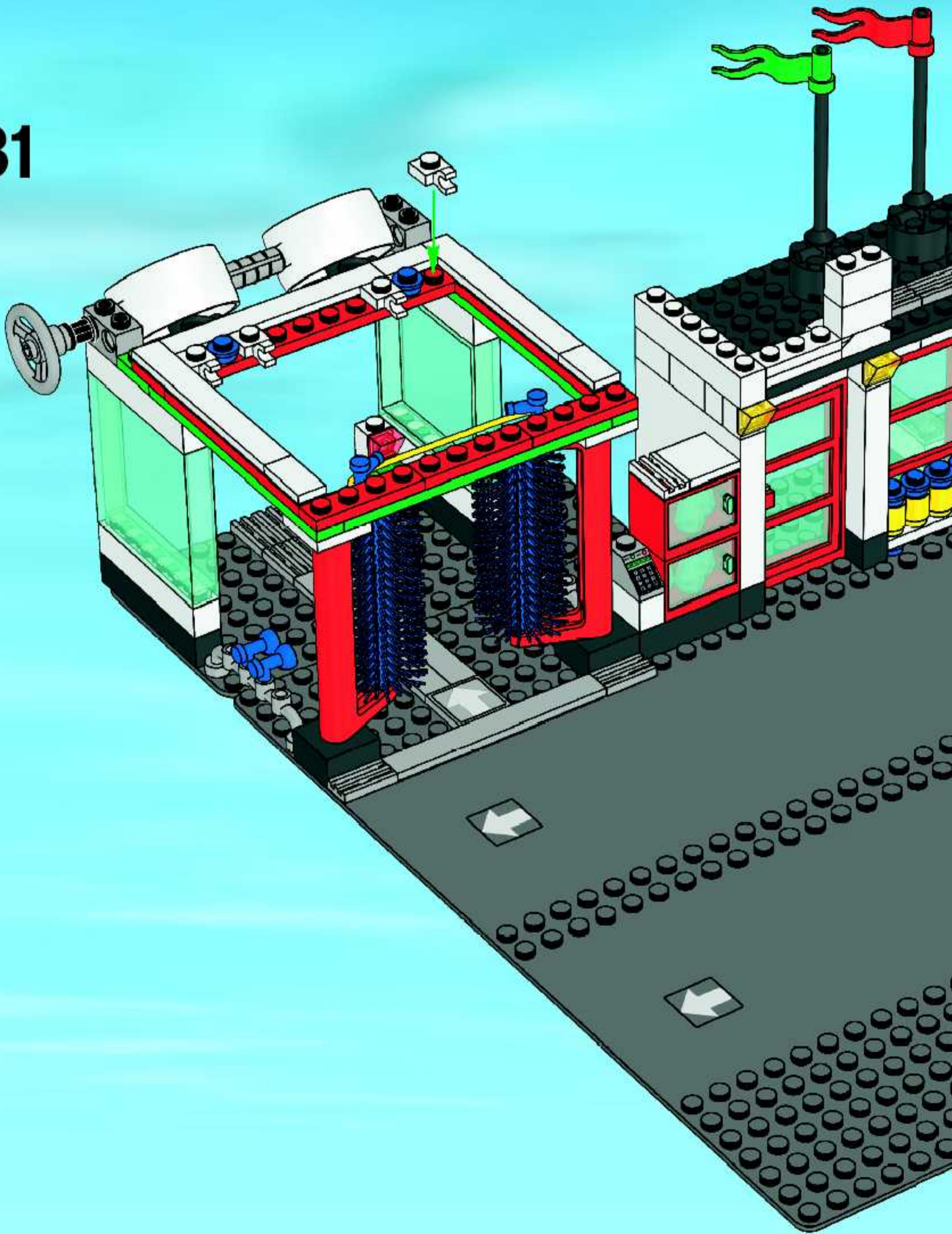

32

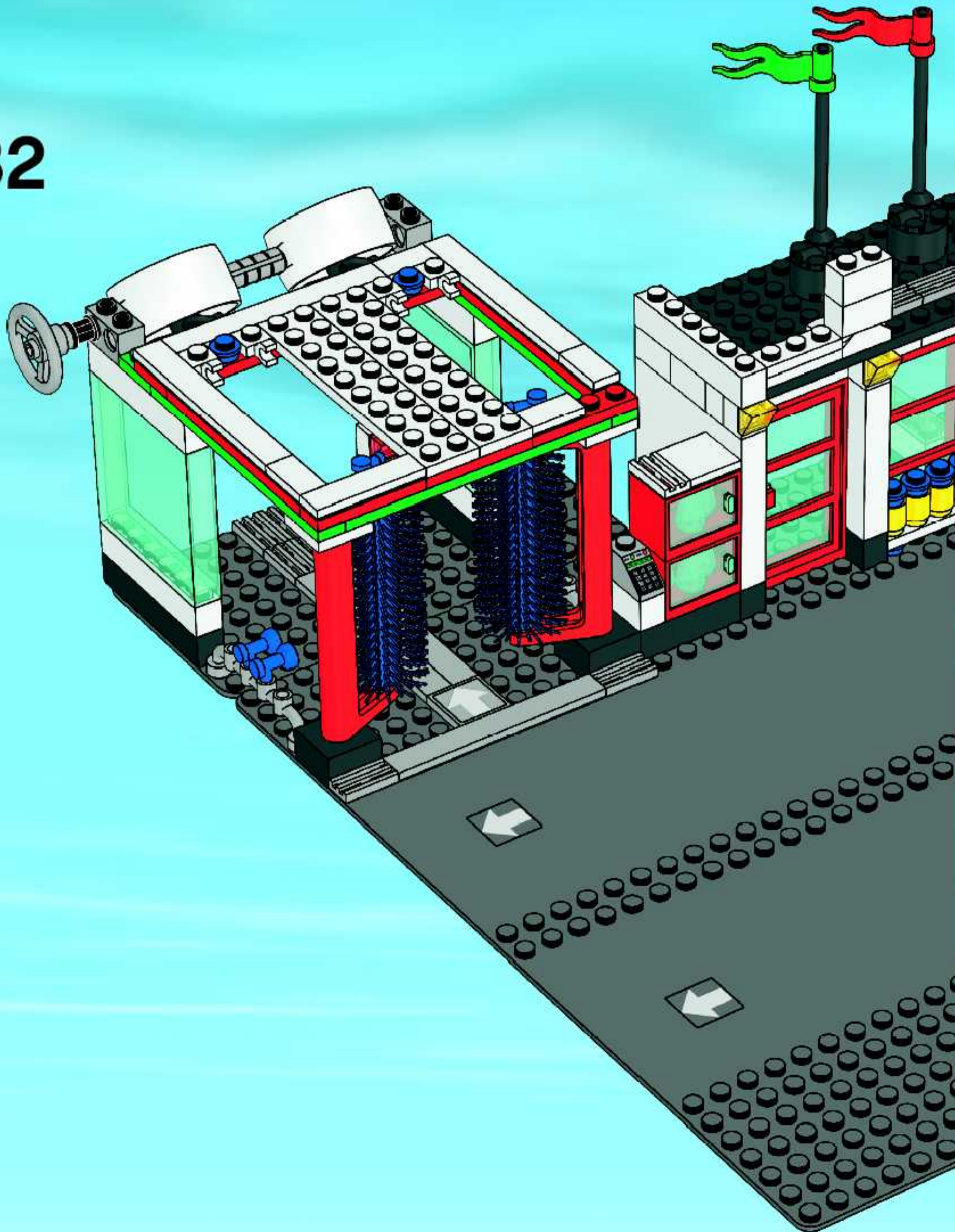

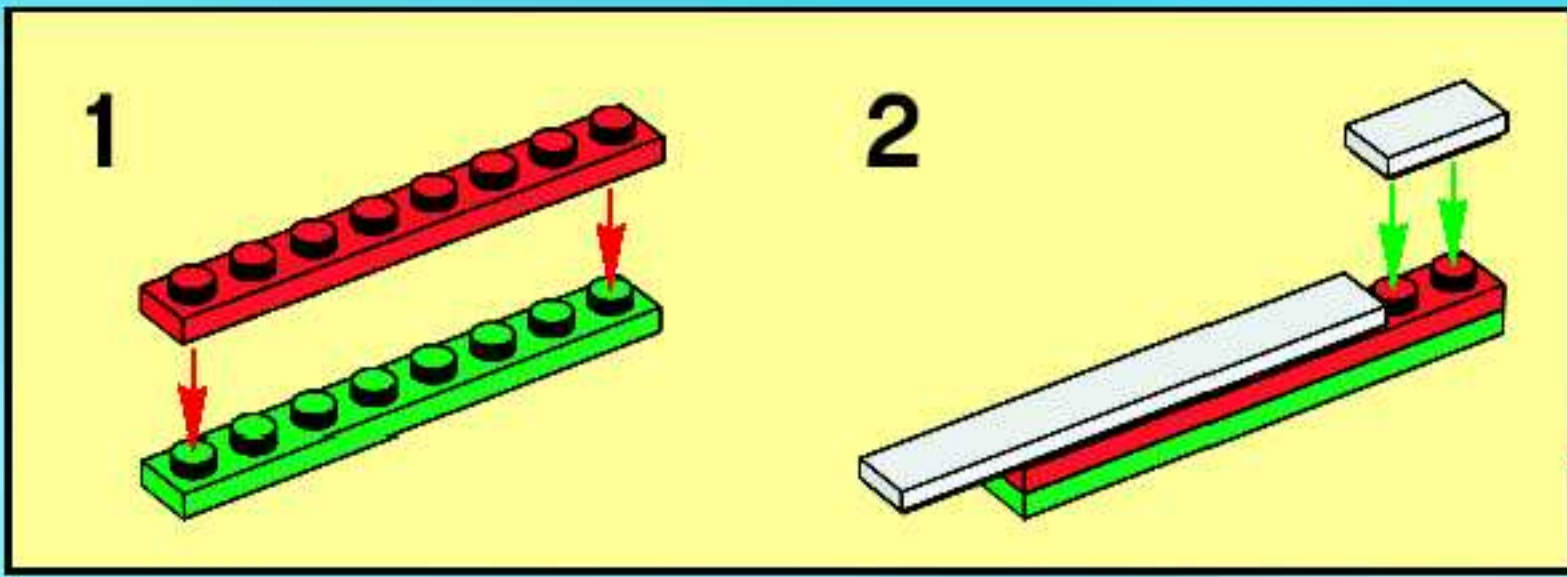

33

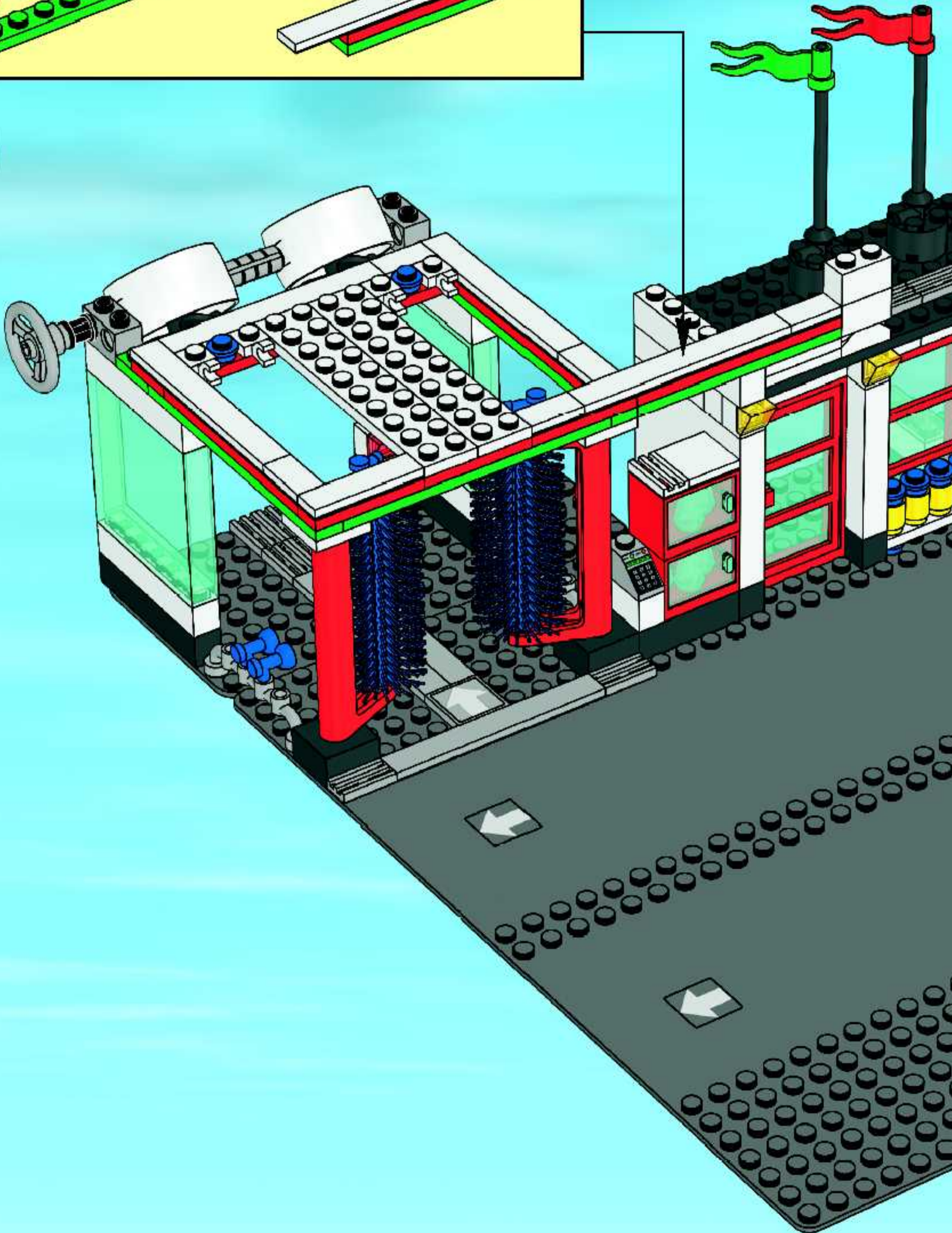

34

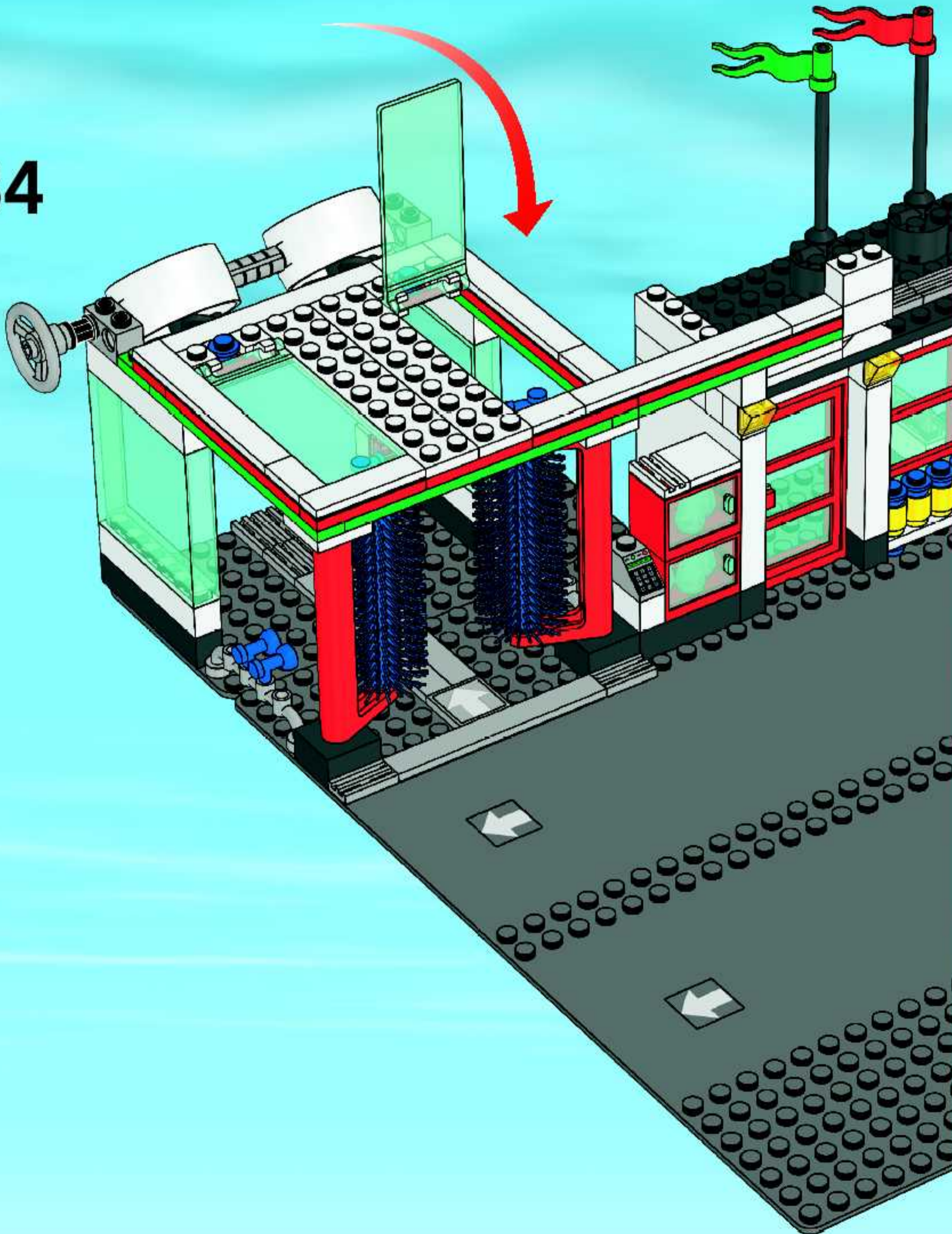



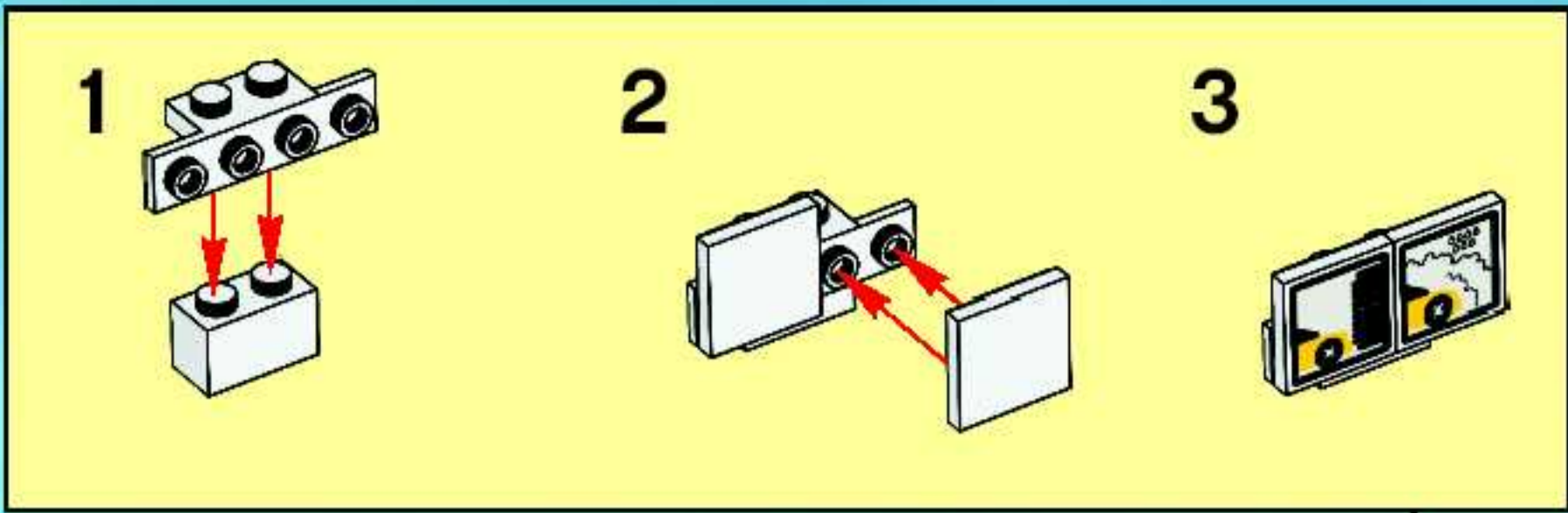

35

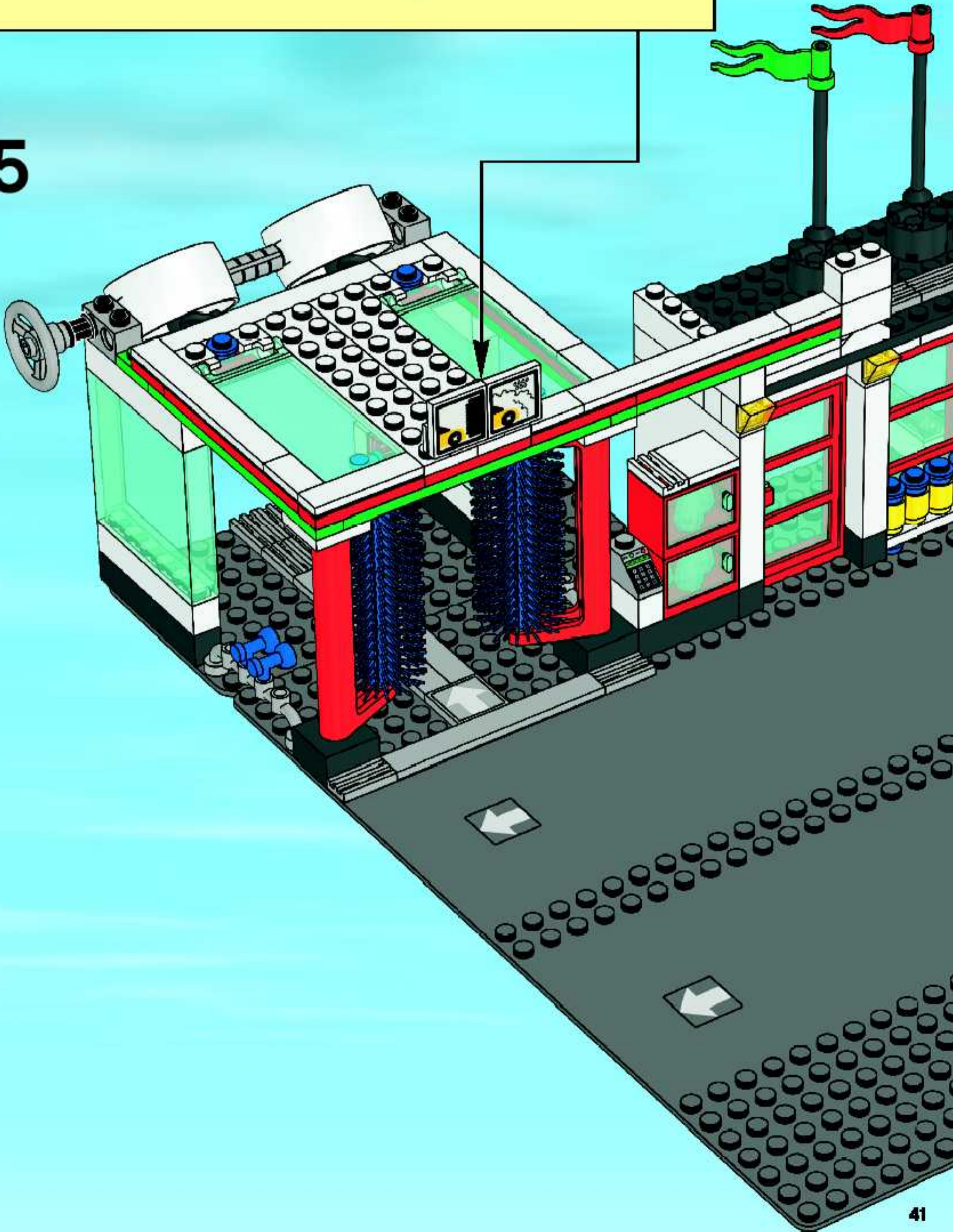

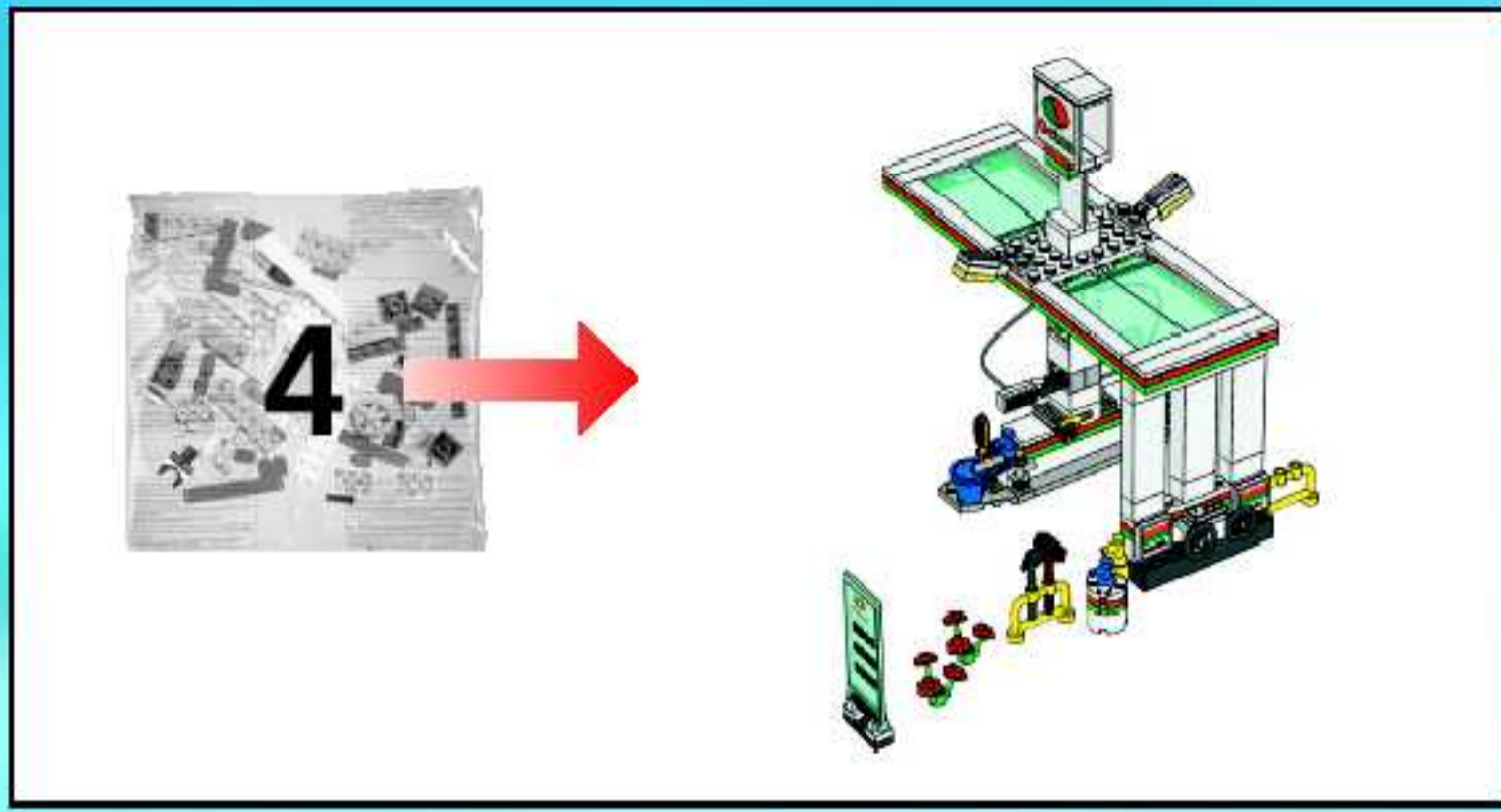

36

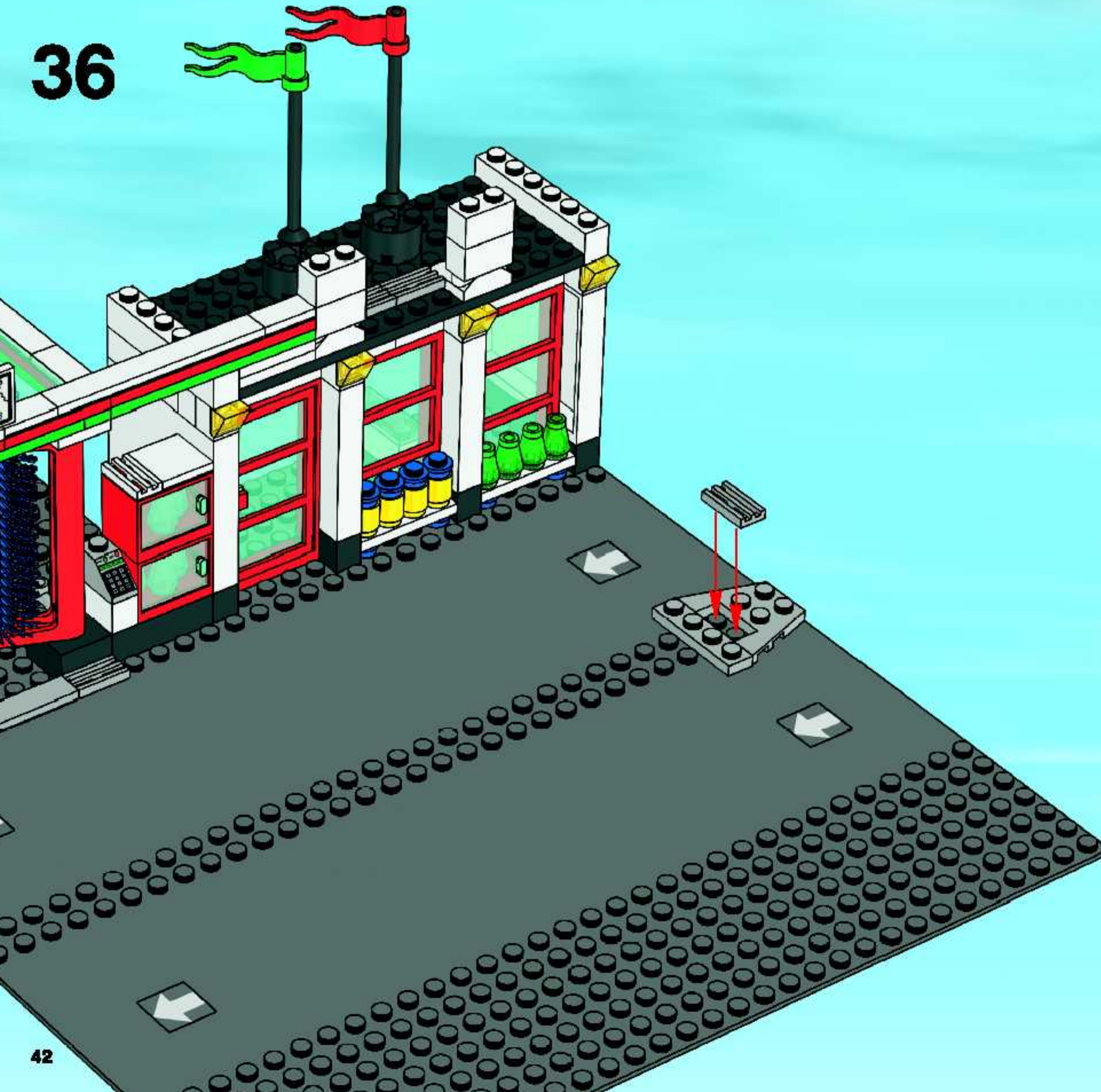

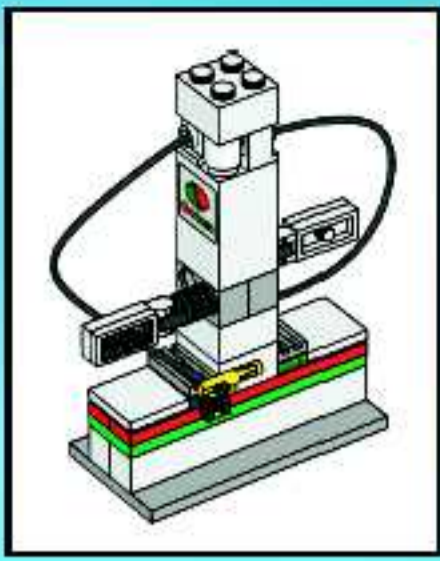

1

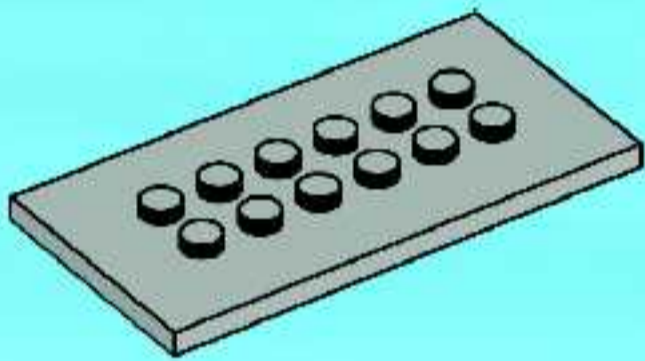

2

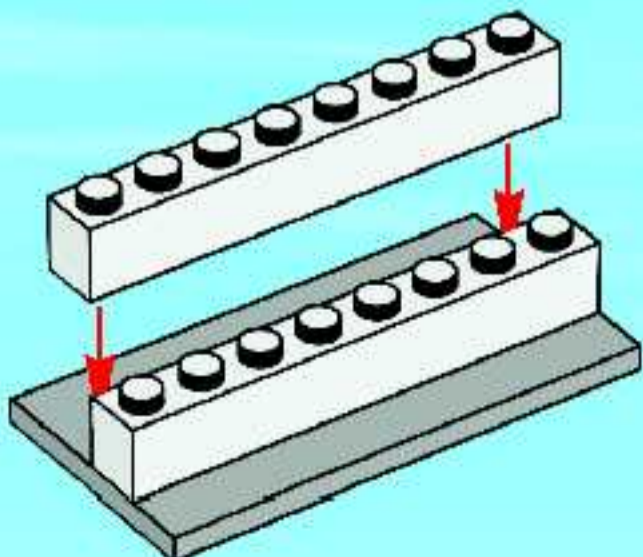

3

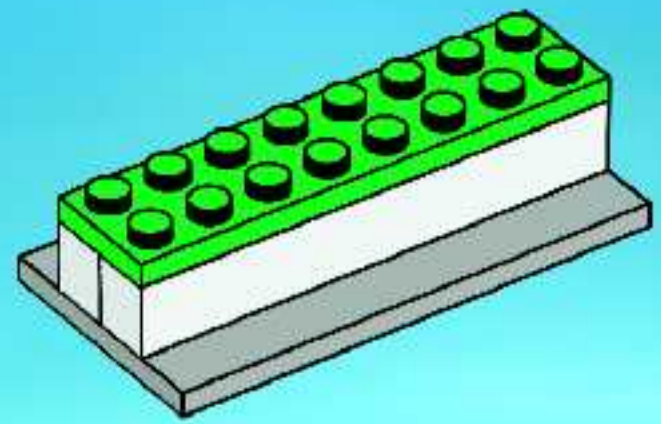

4

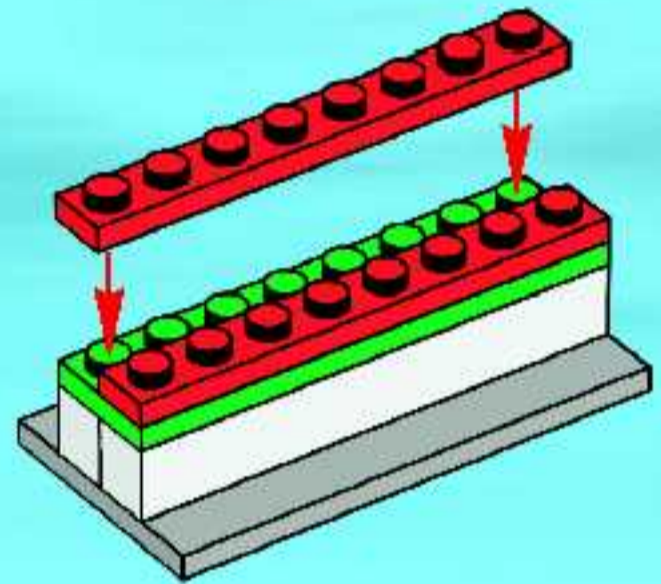

5

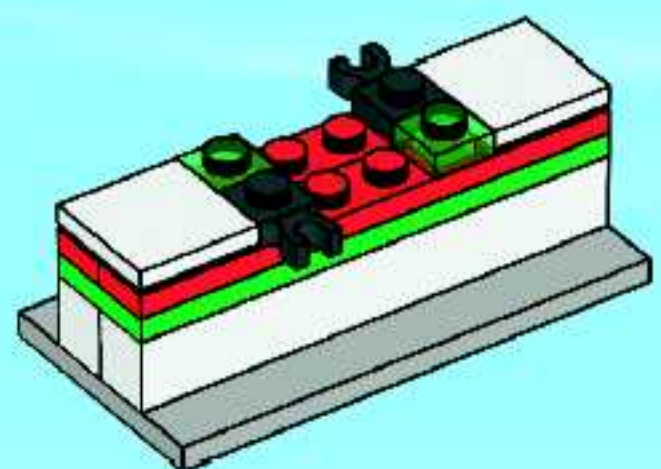

6

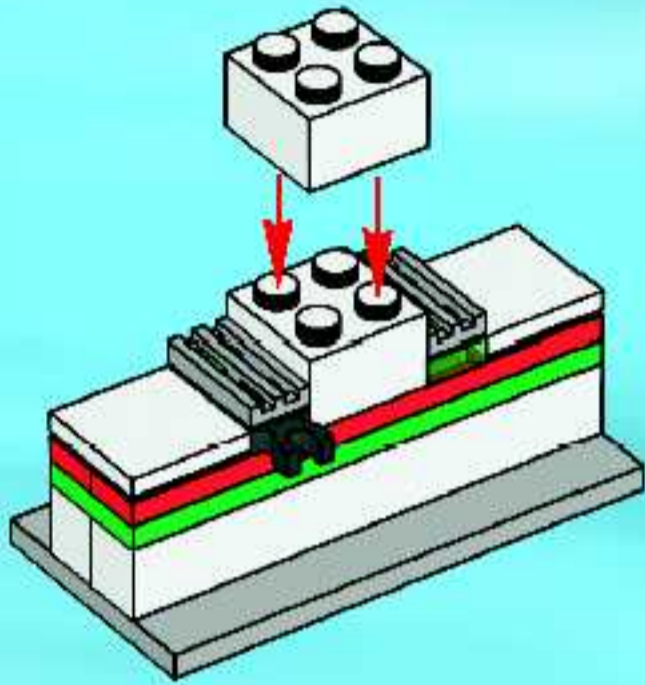

8

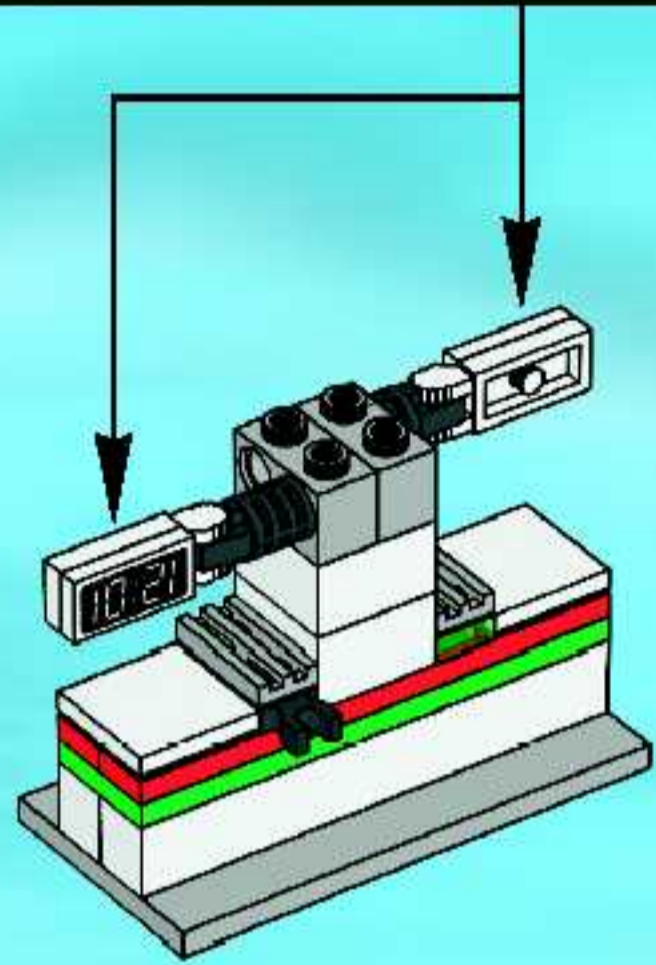

7

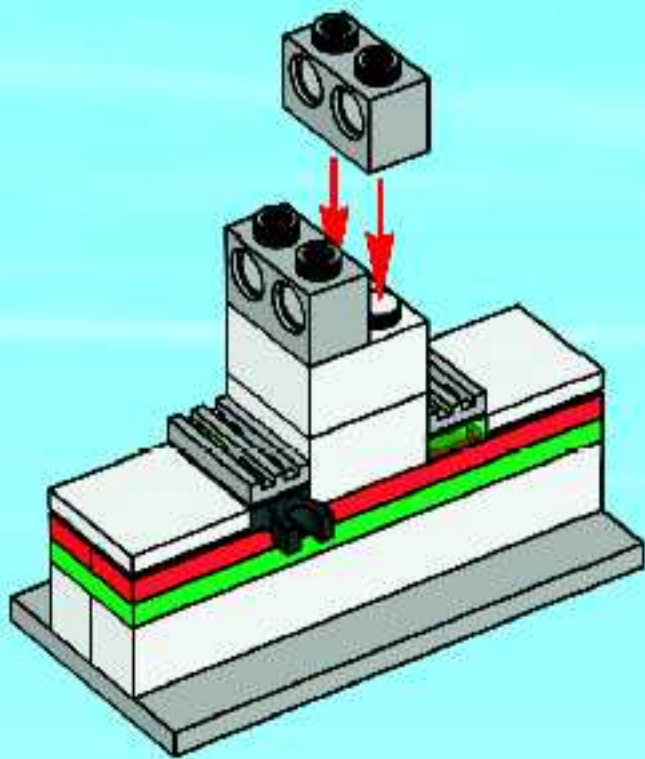

9

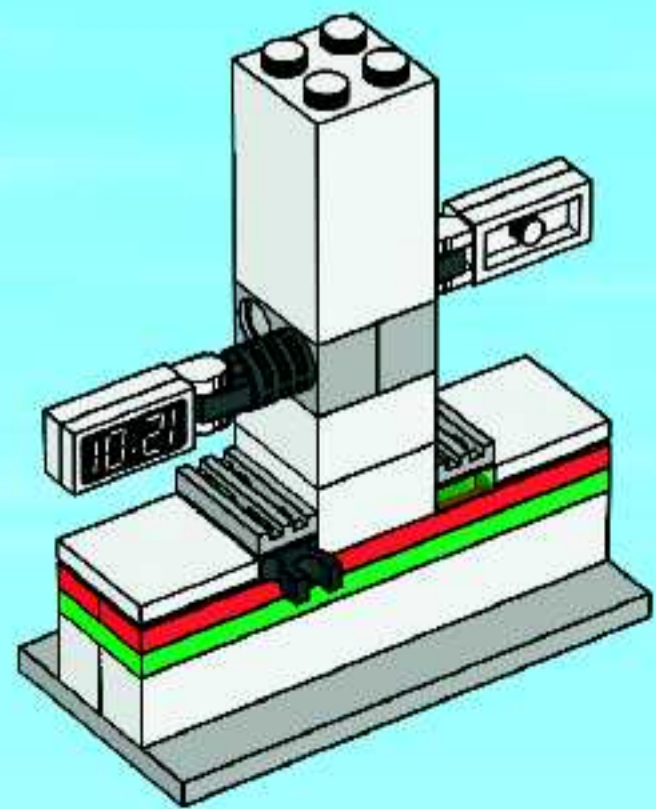

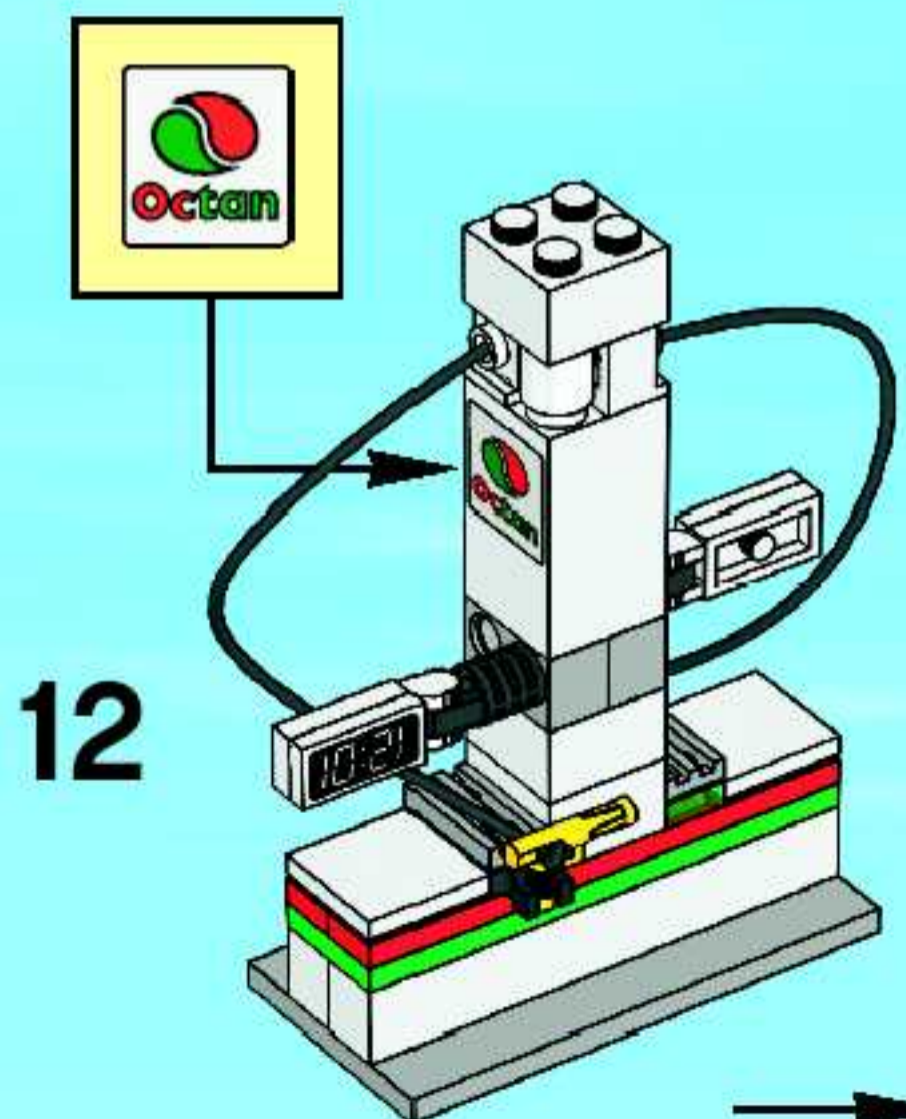
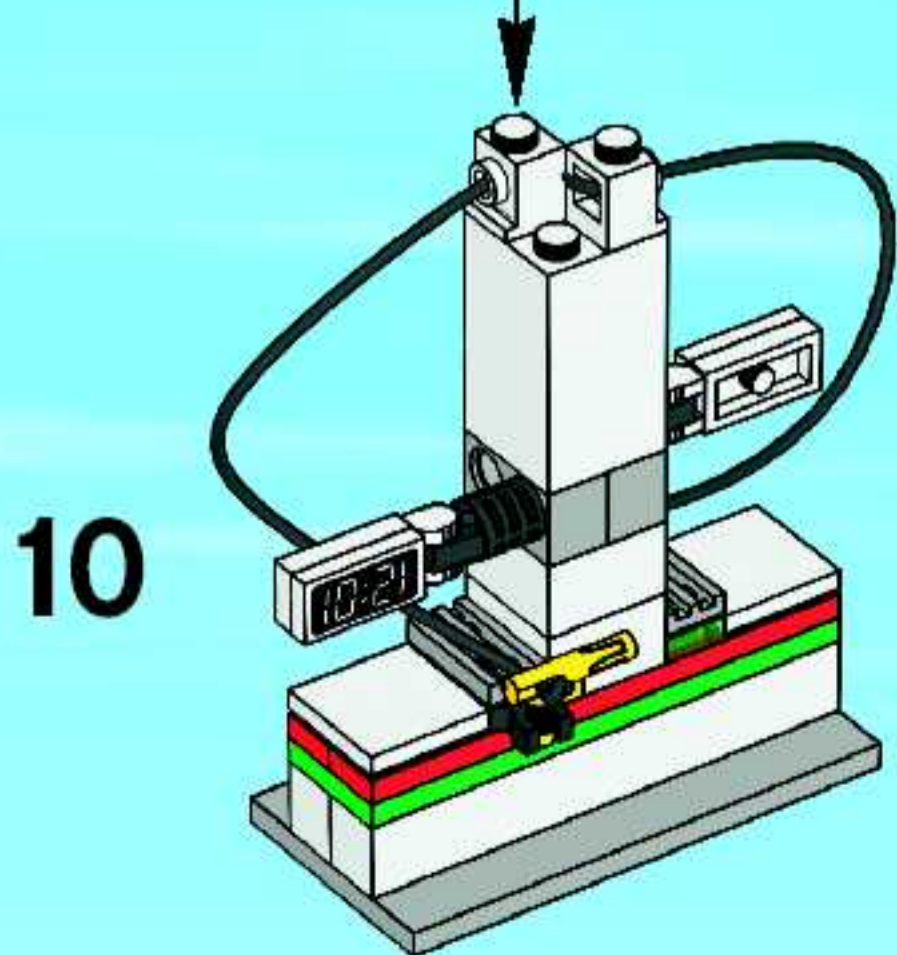
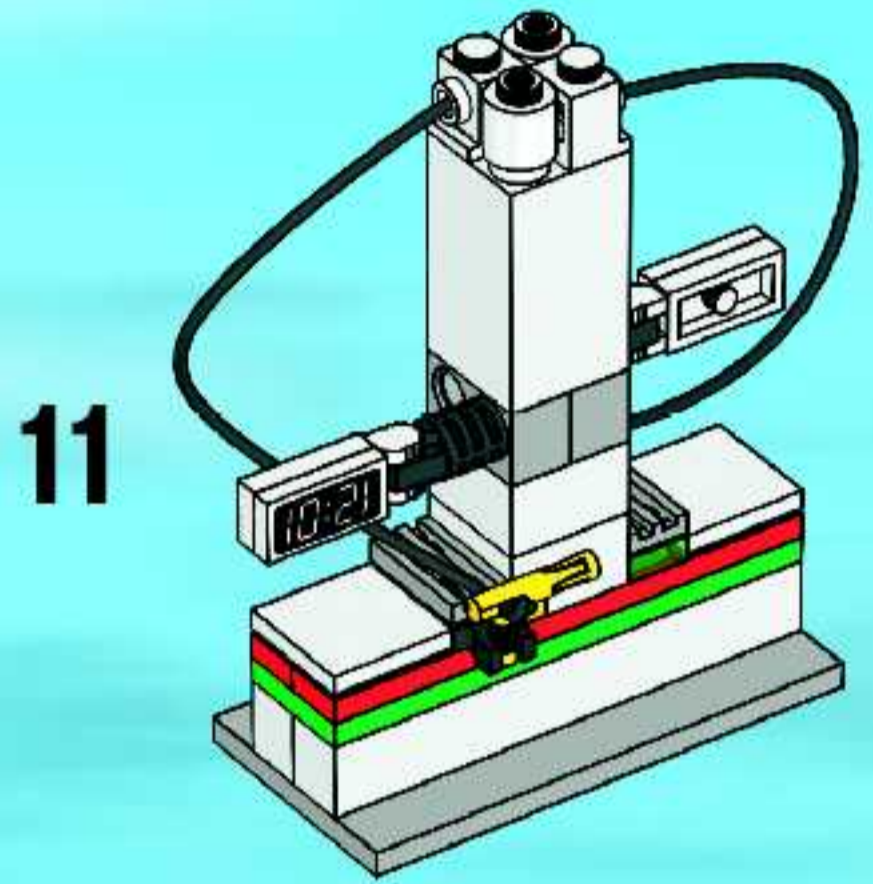
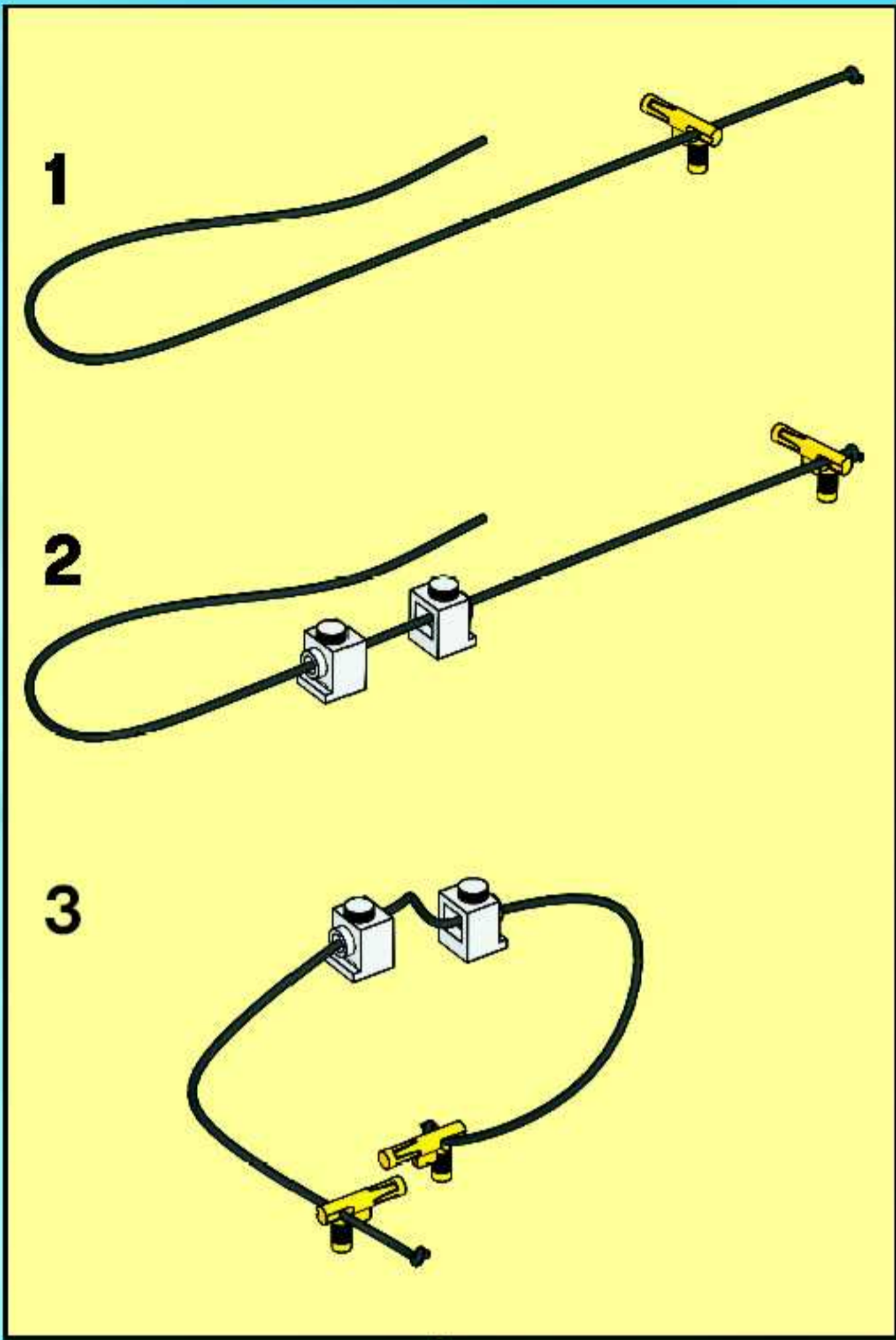

37

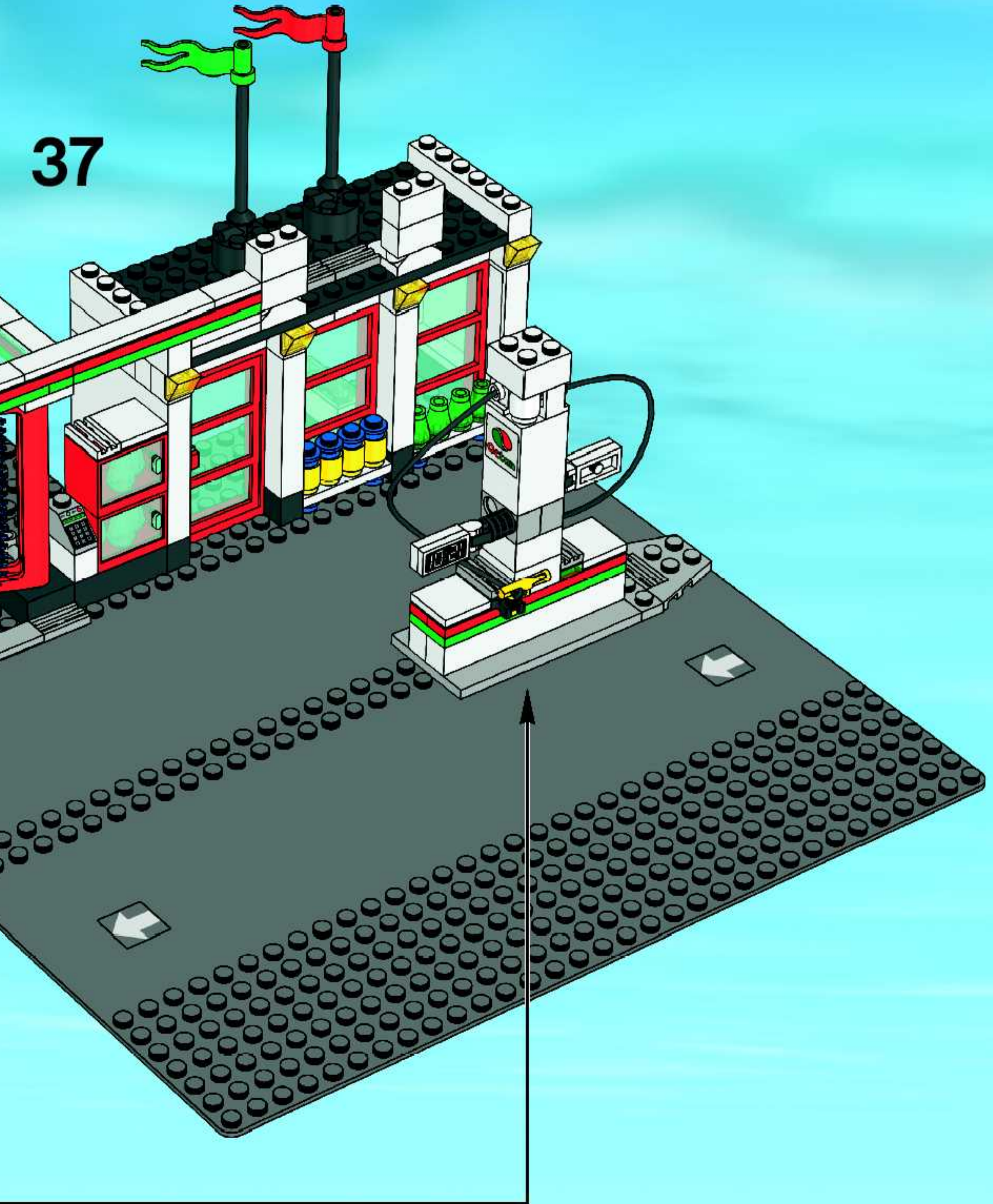

38

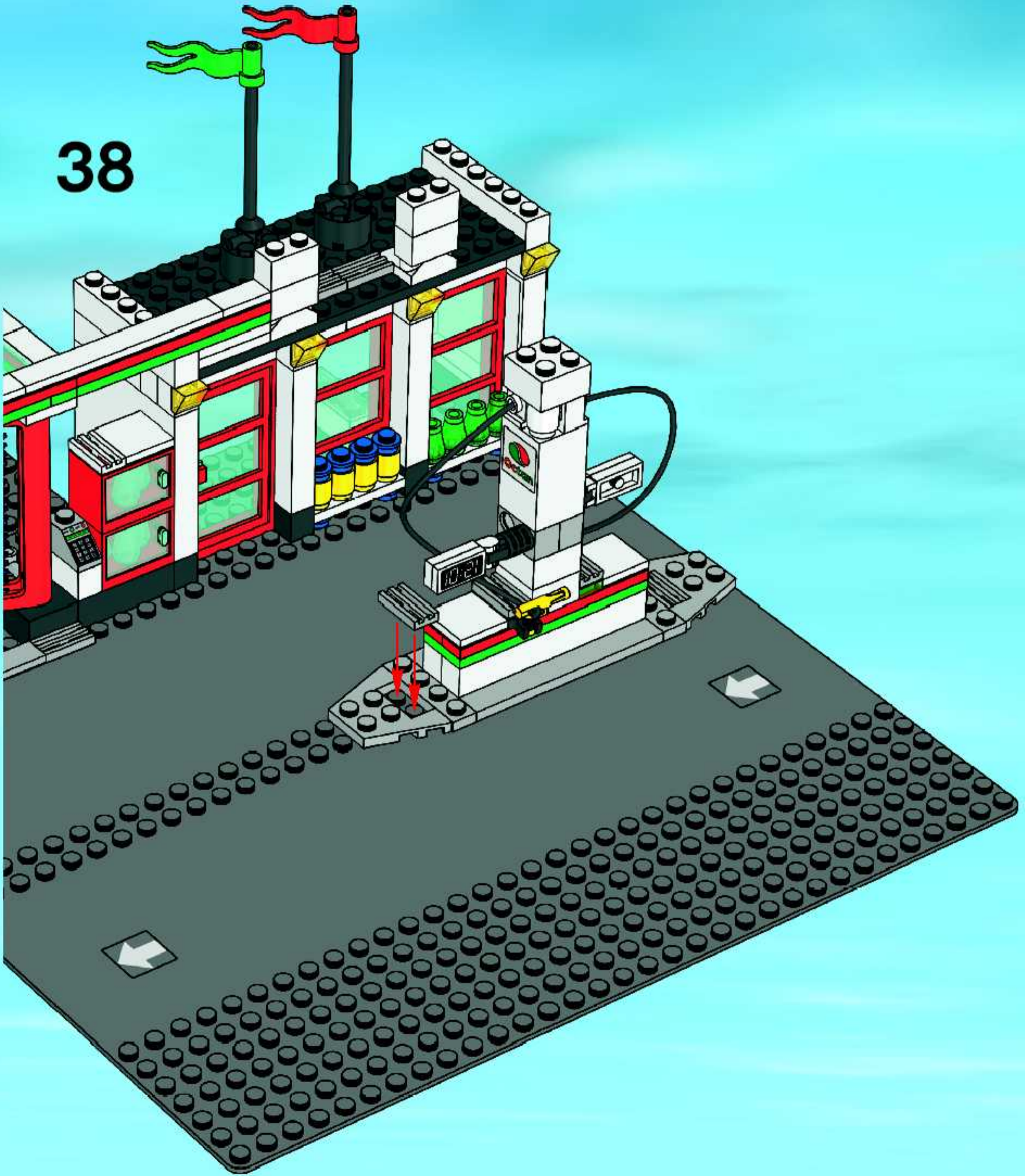

39

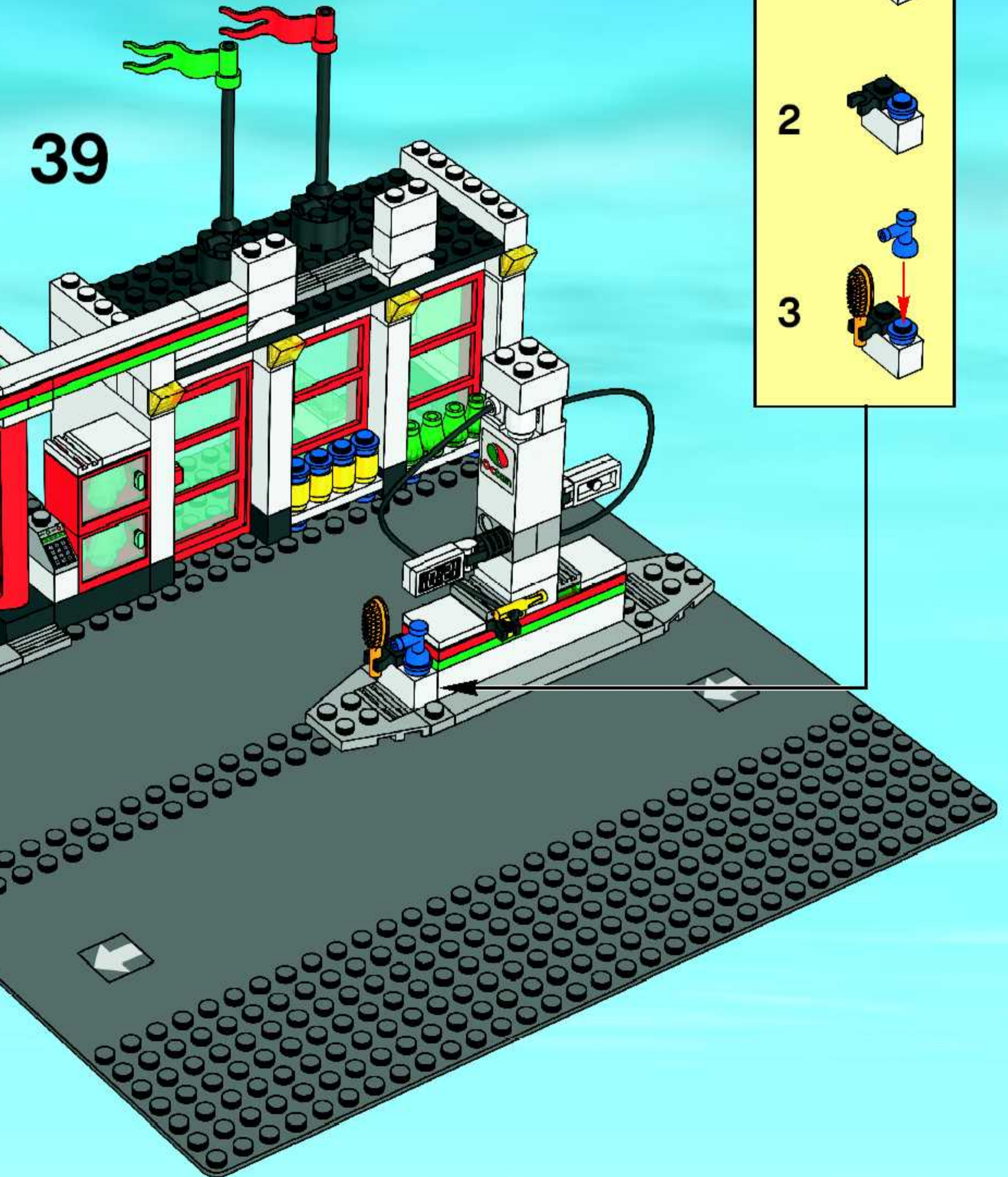

1

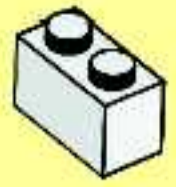

2



3





40

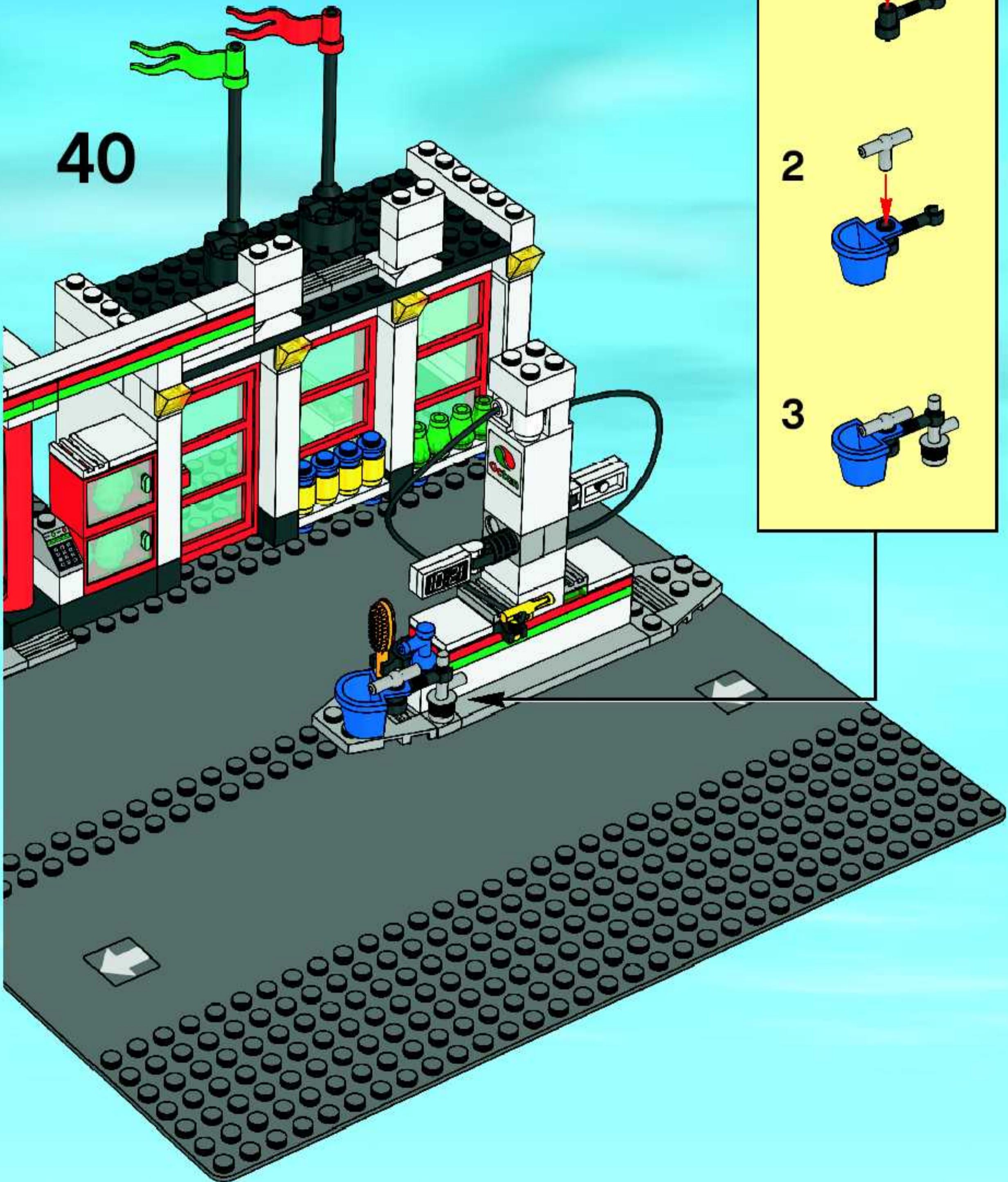

41

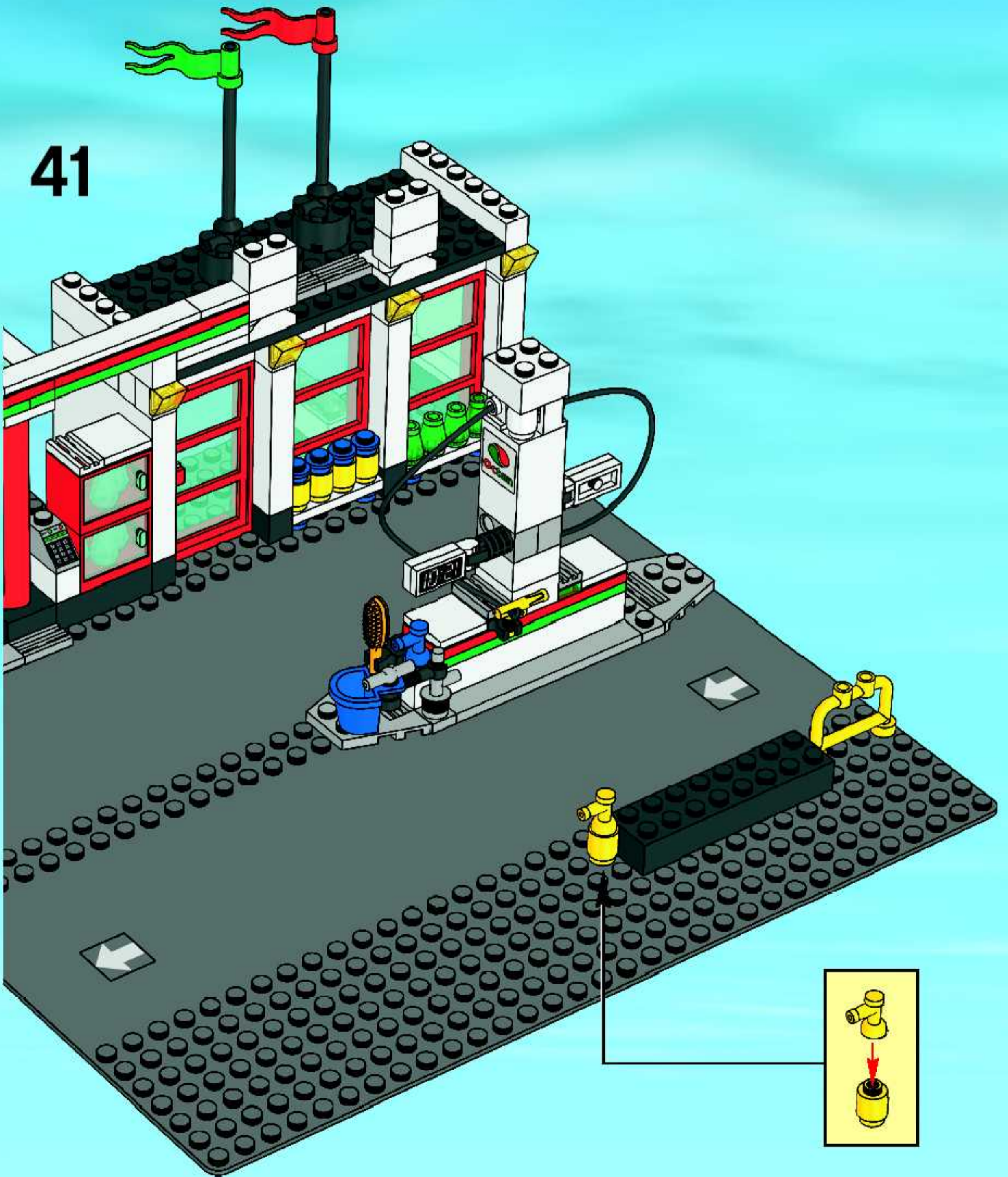



1

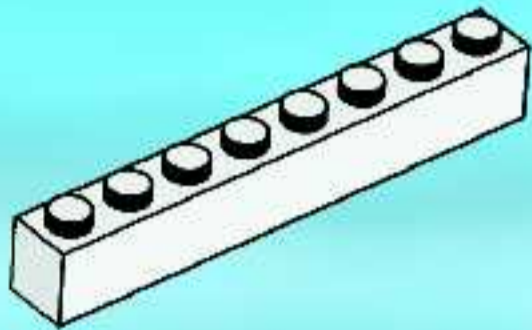

2

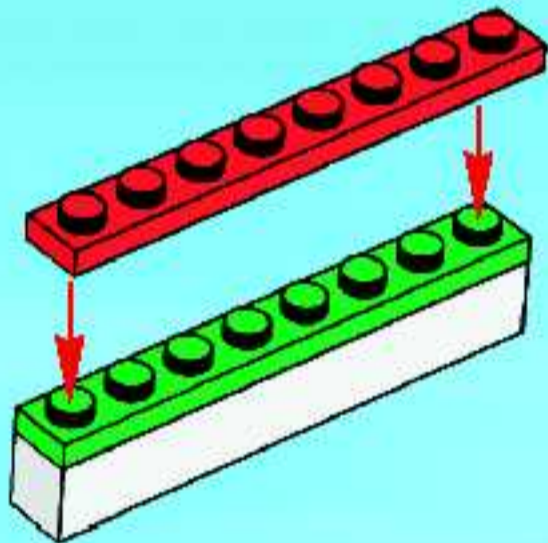

3

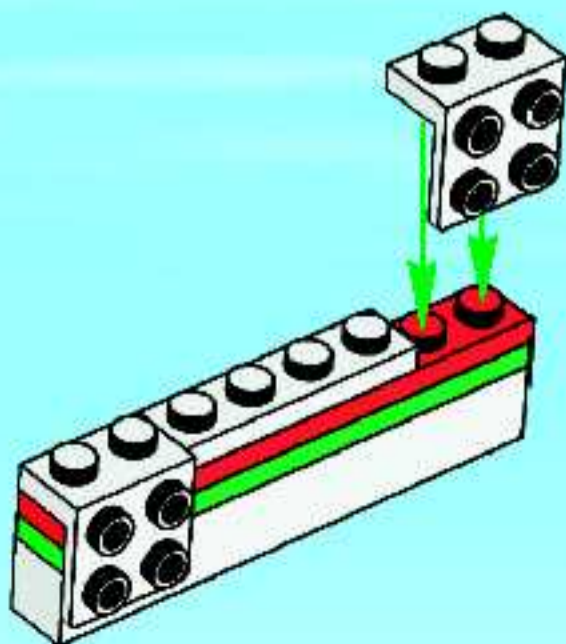

4

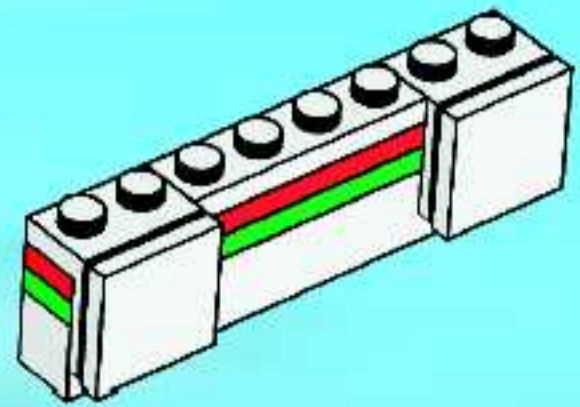

5

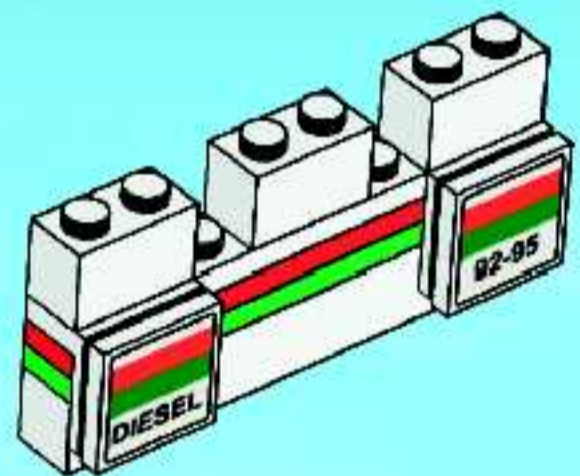

42

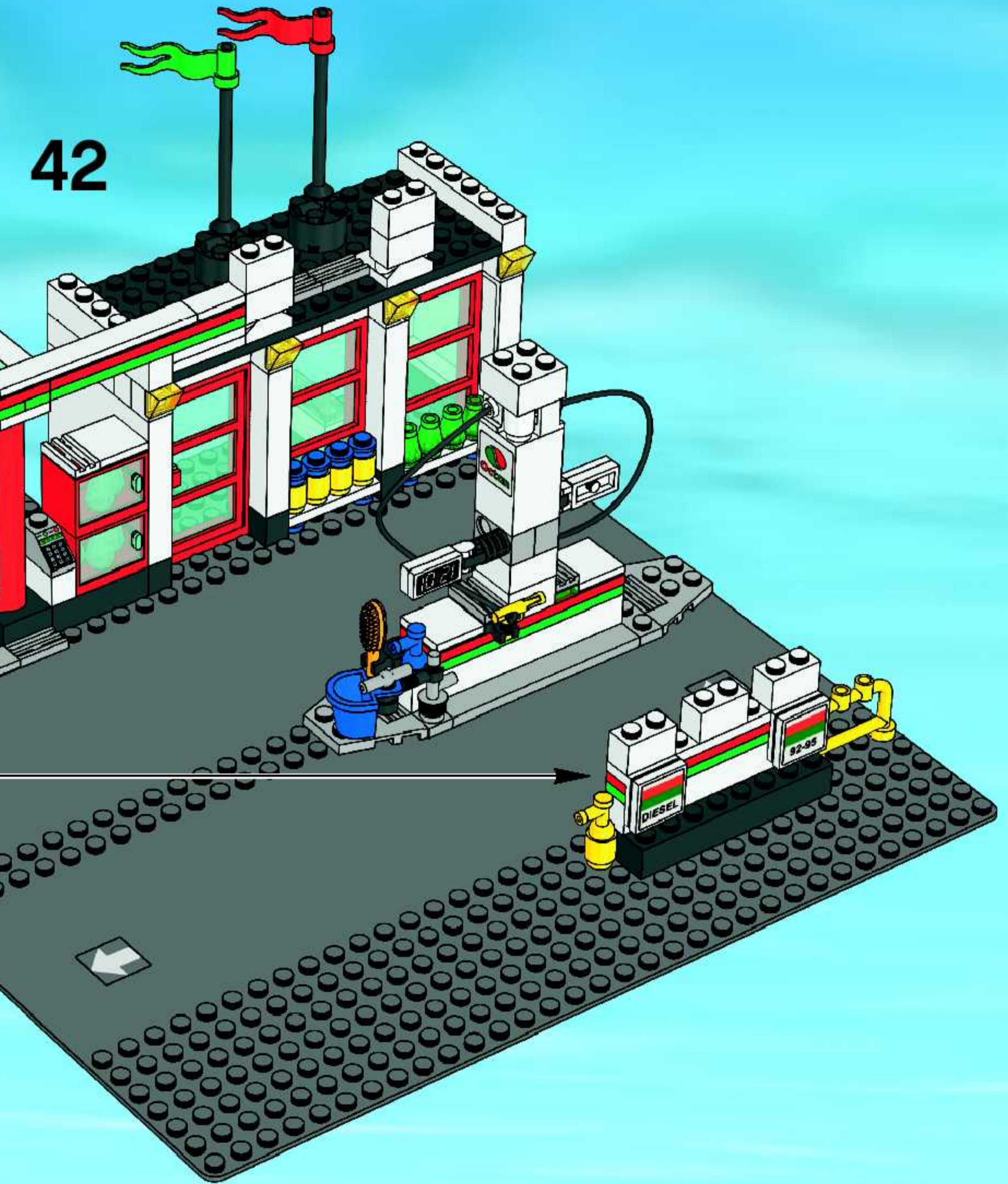

43

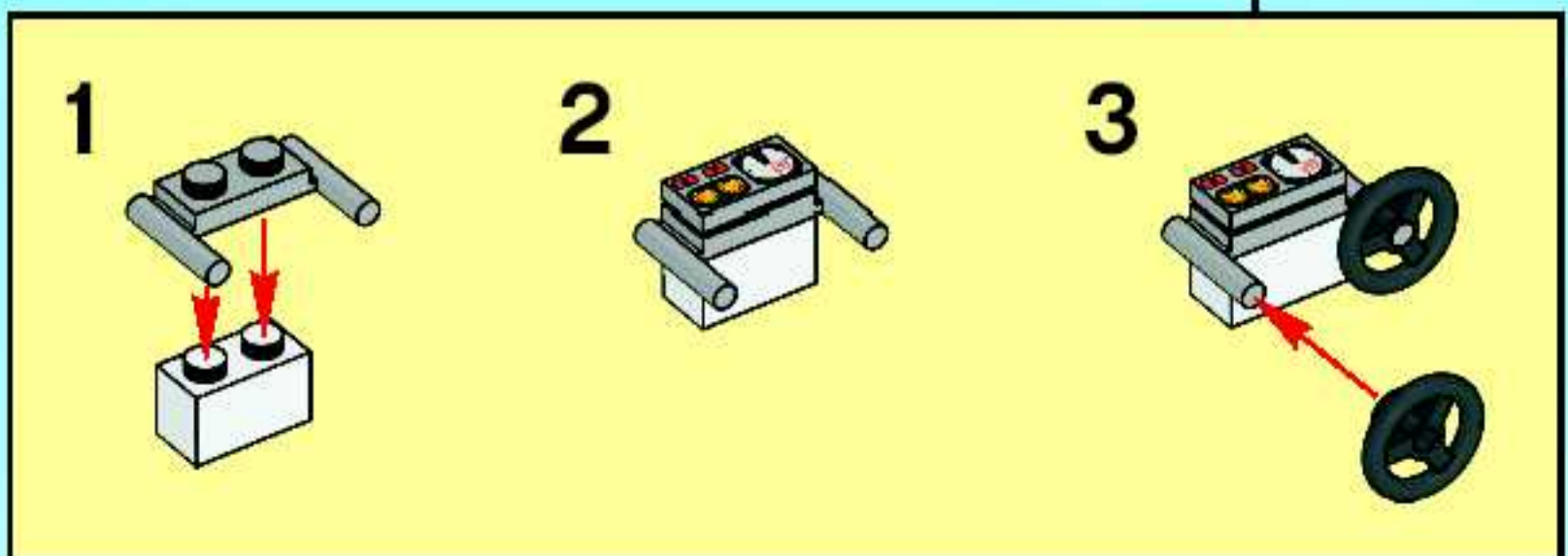
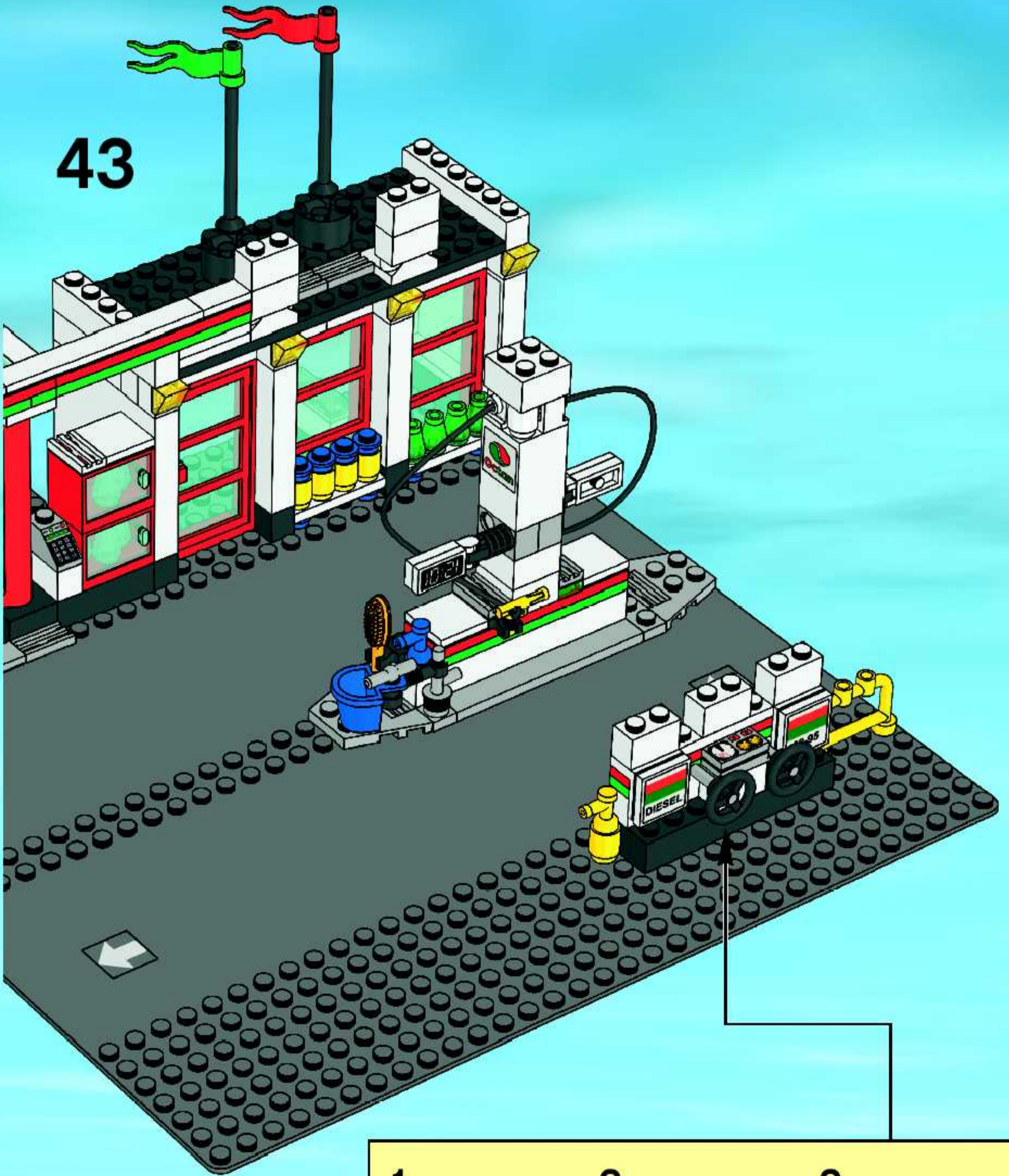

44

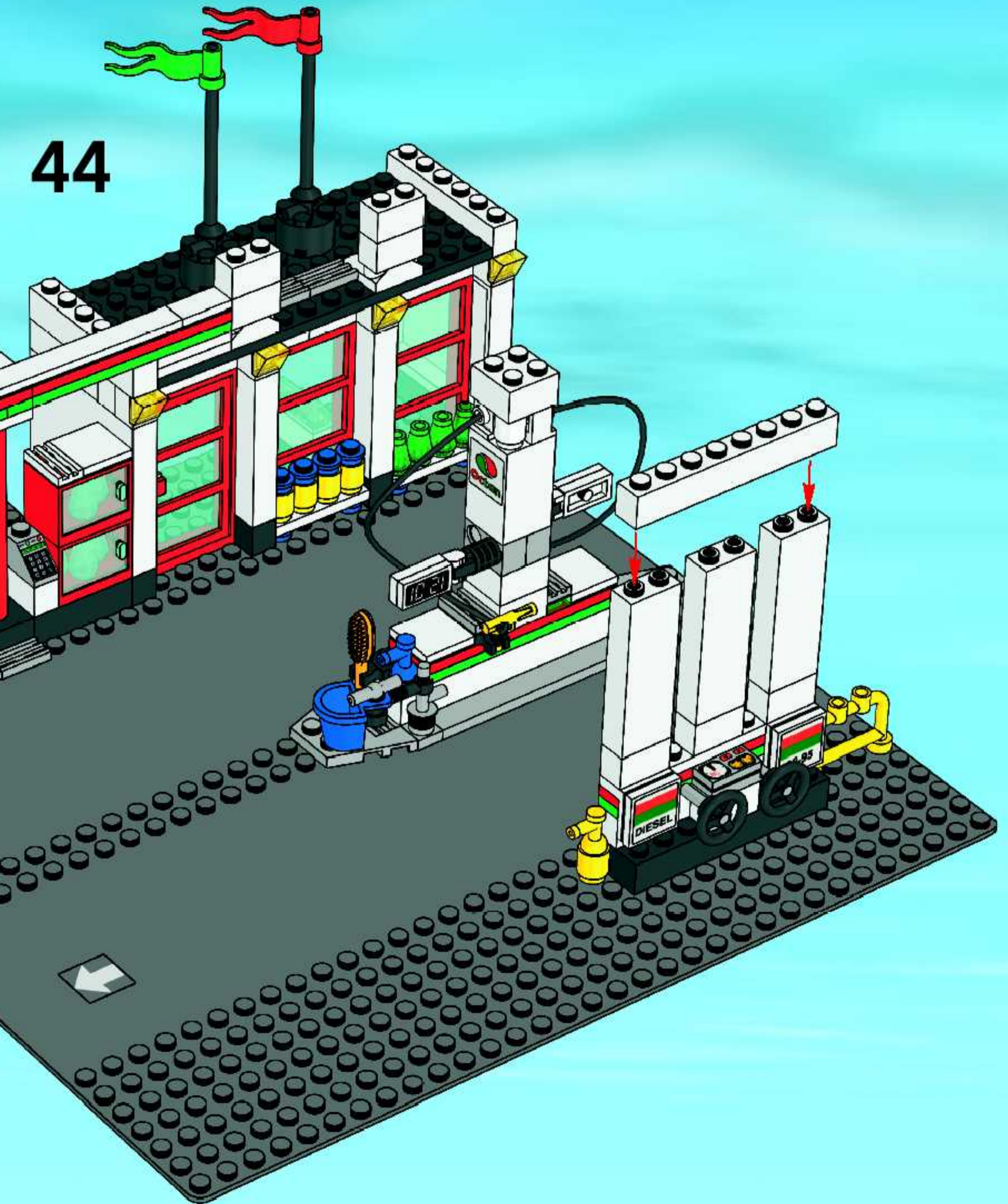

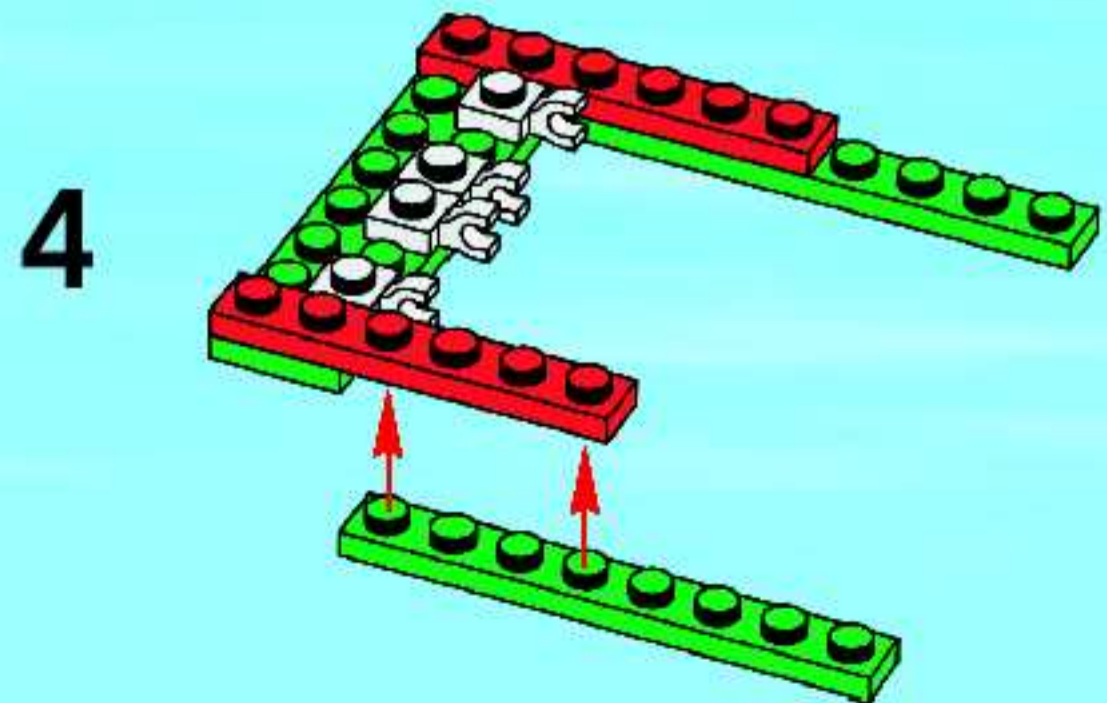
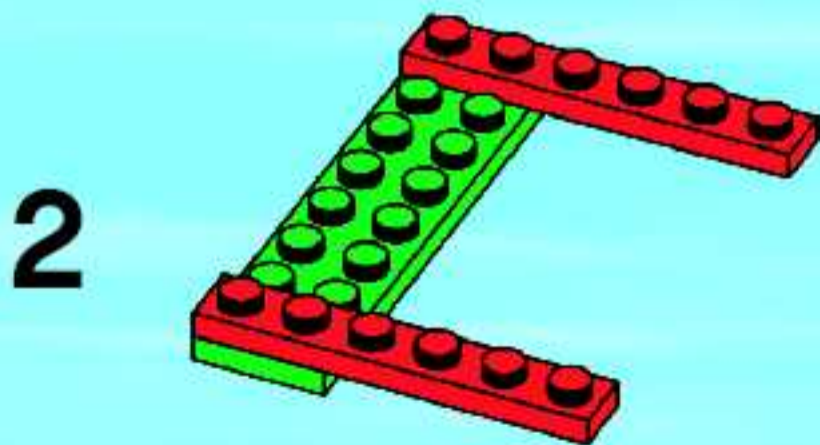
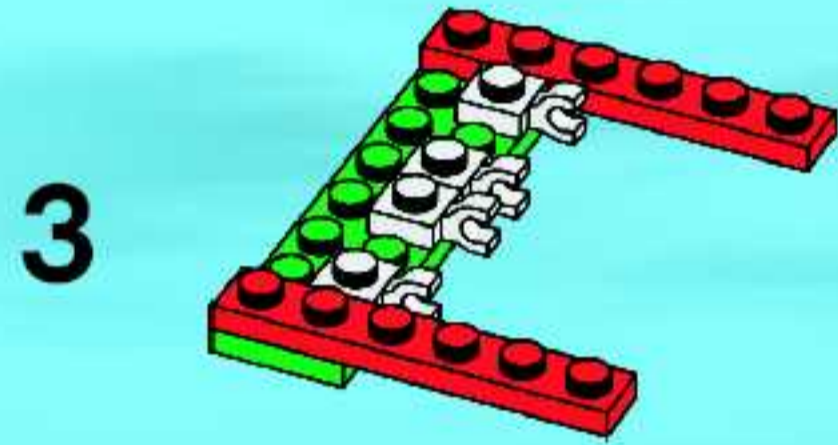
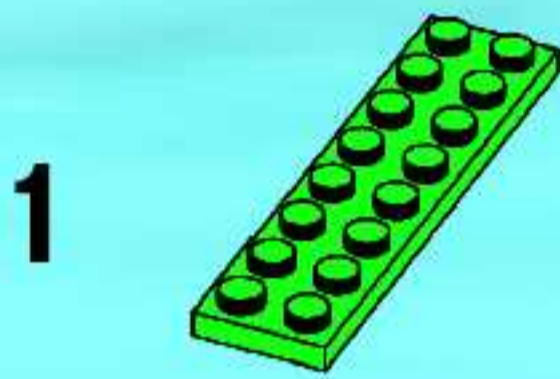
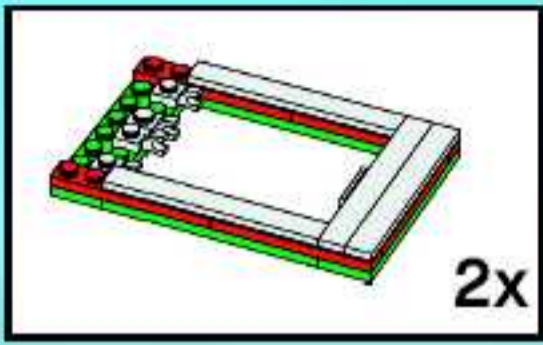
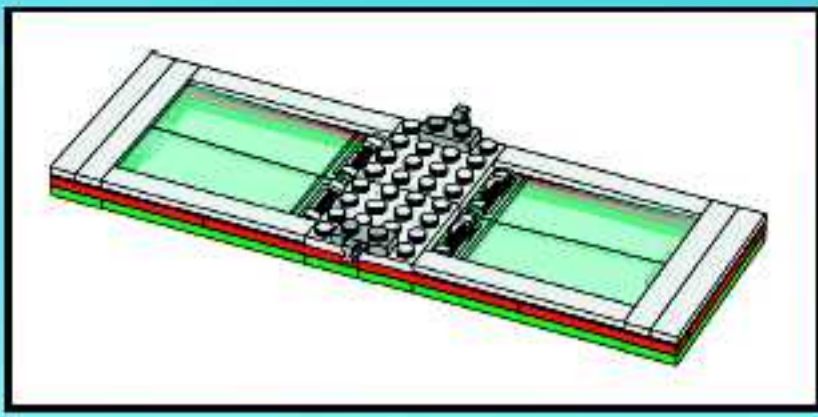

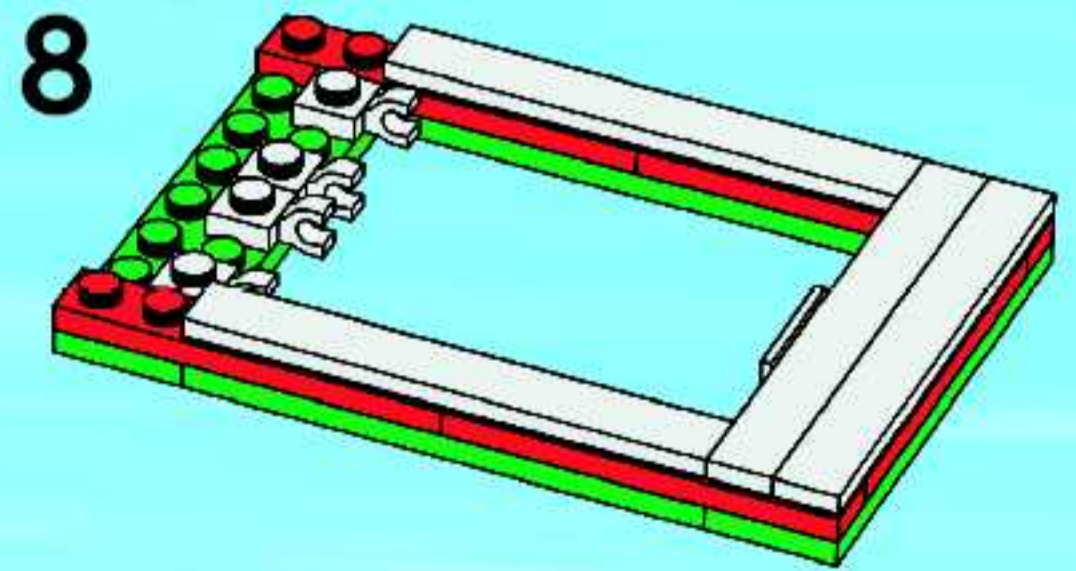
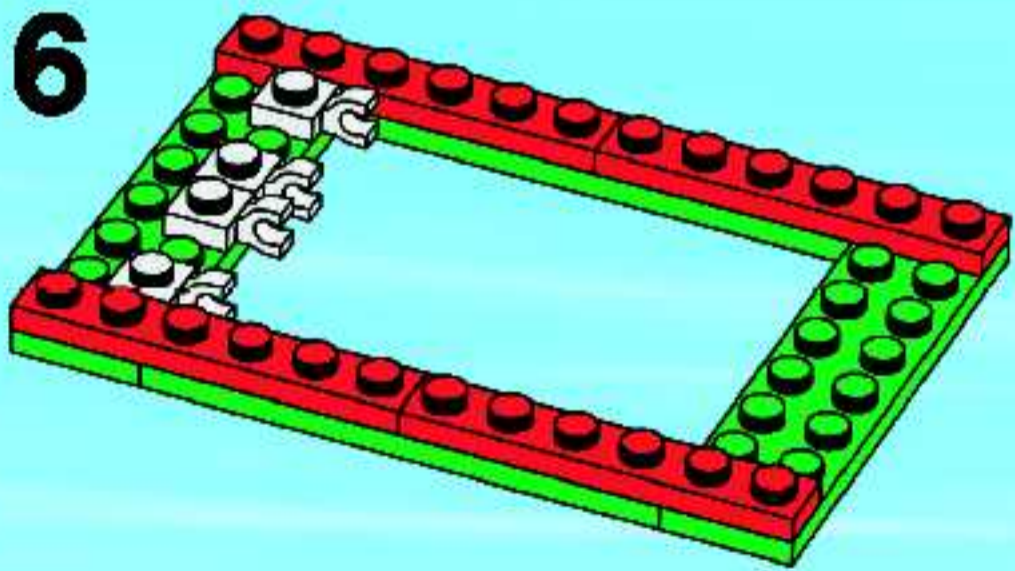
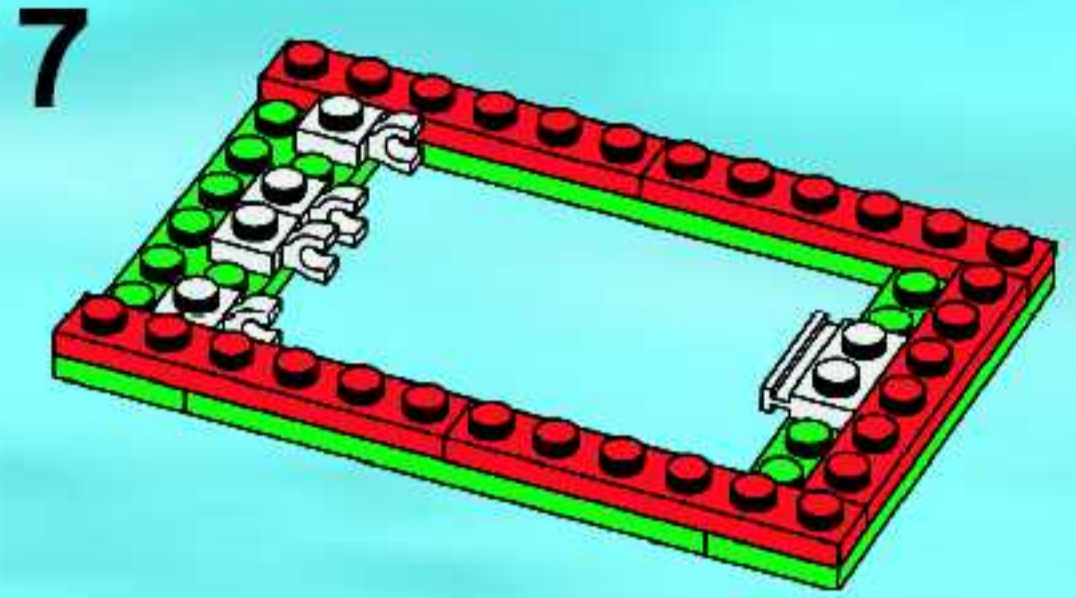
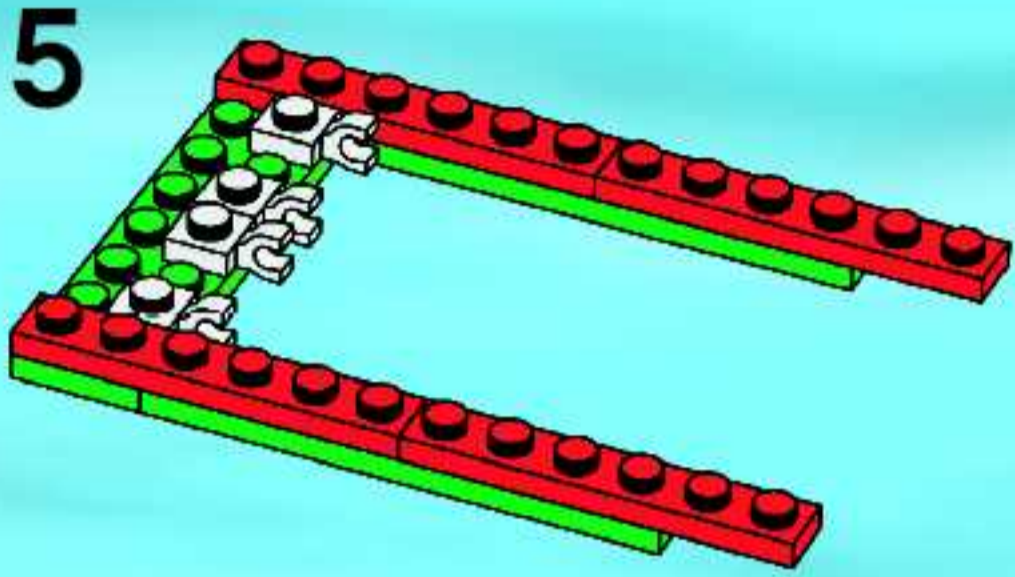

2x



9

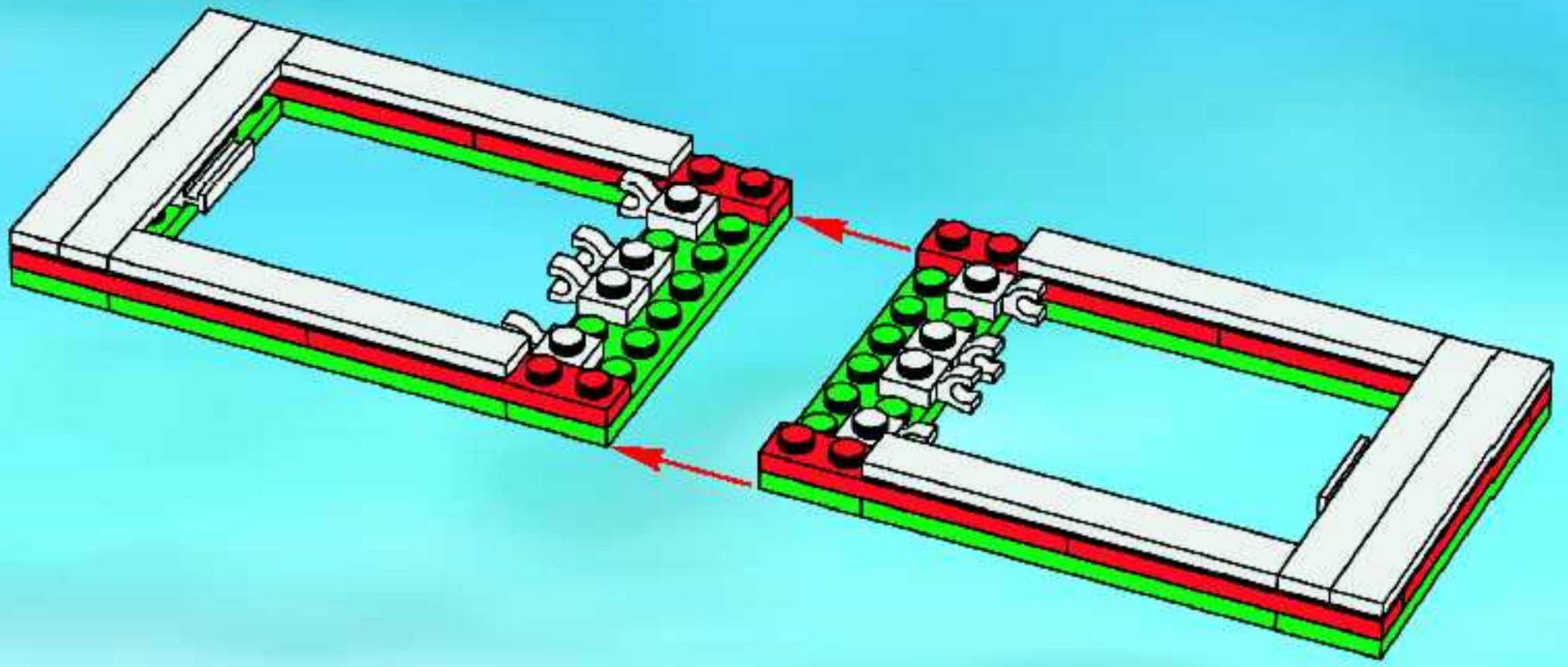

10

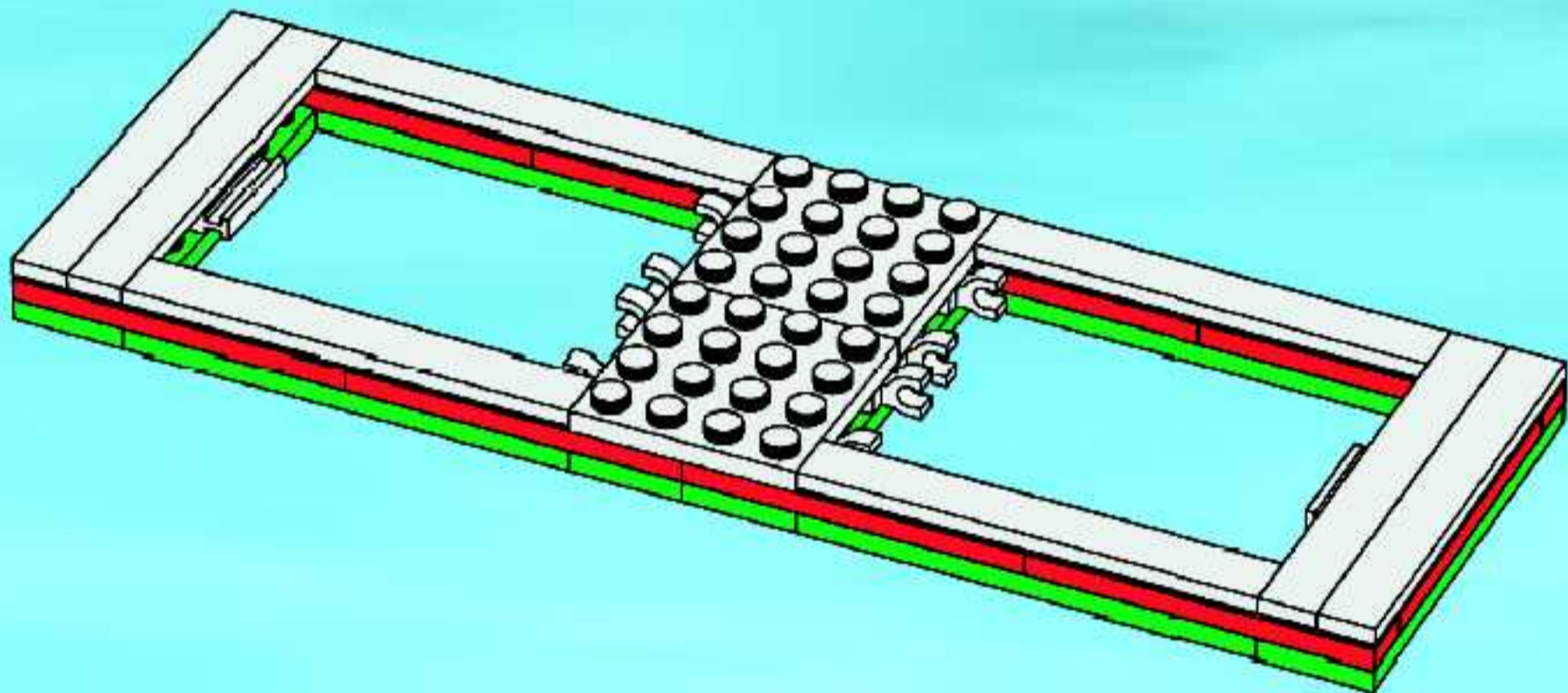

11

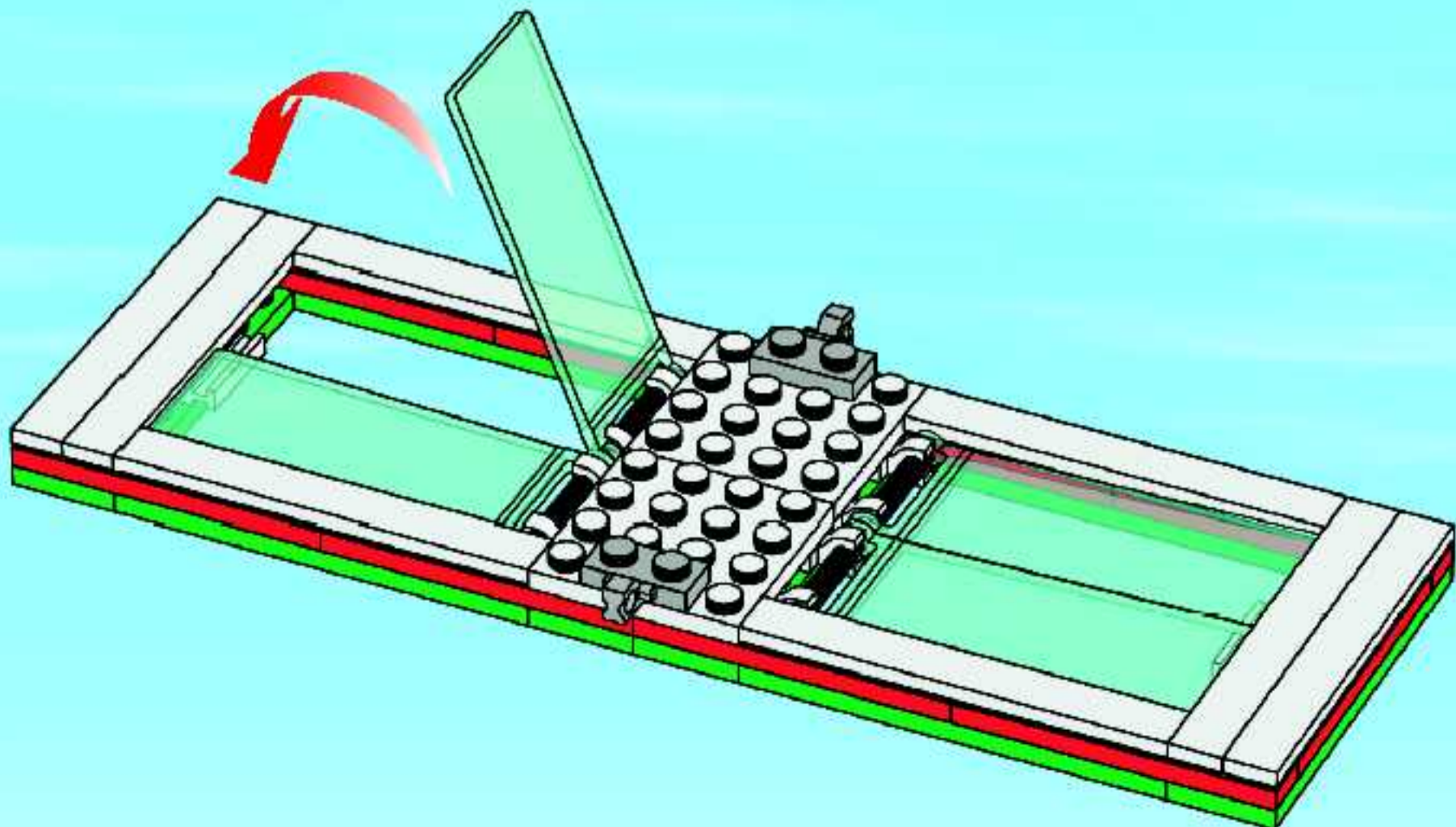

45

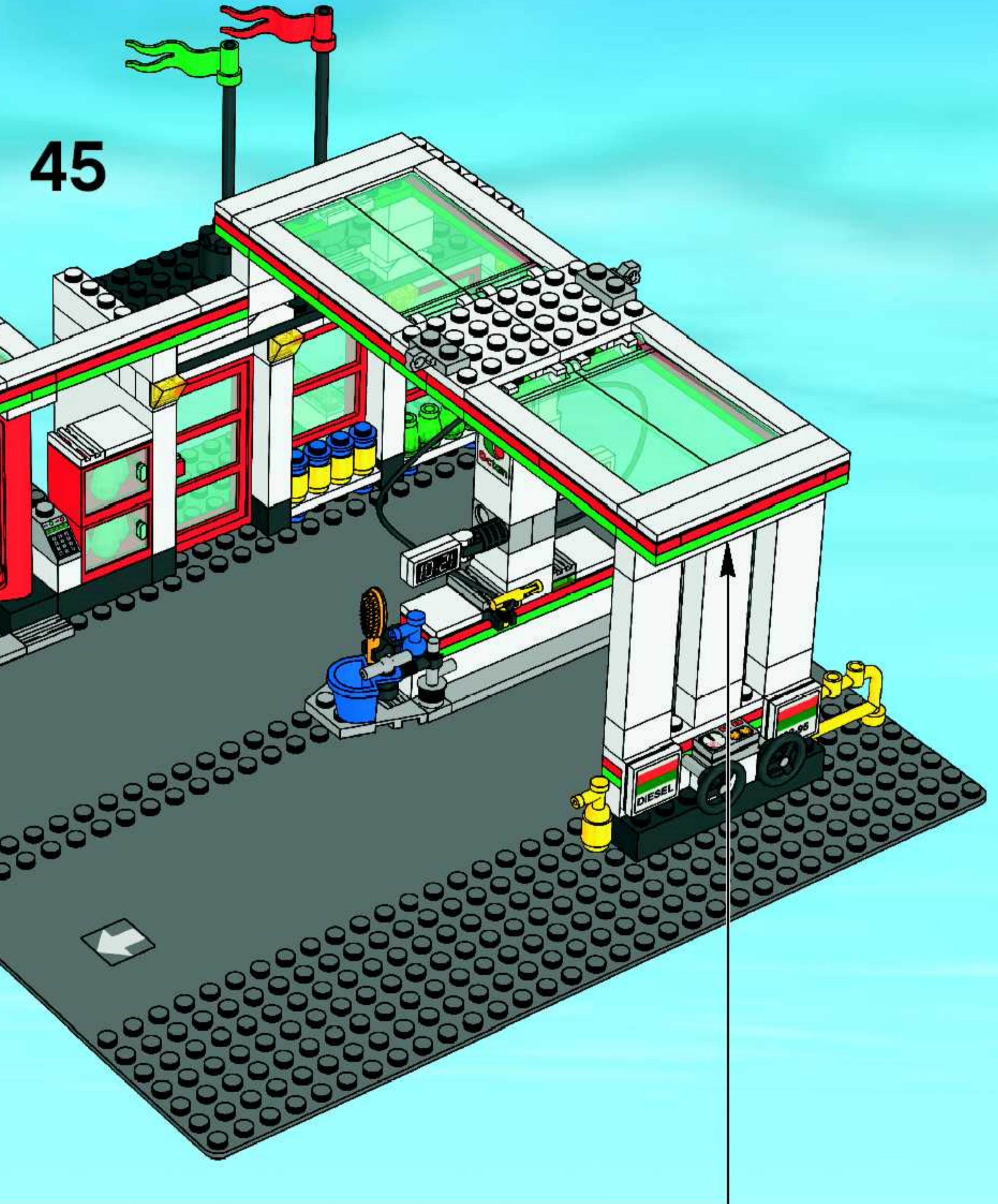

46

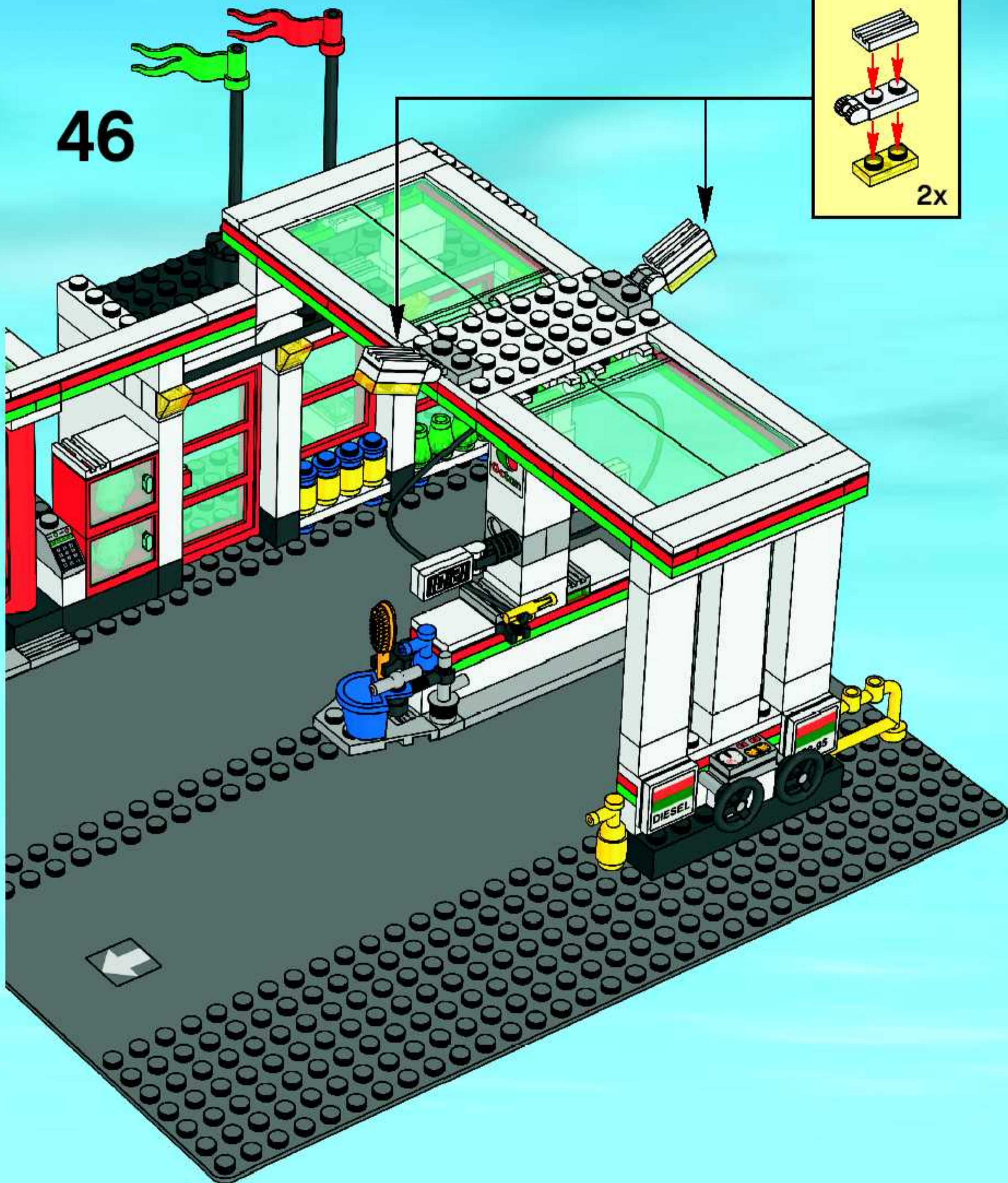
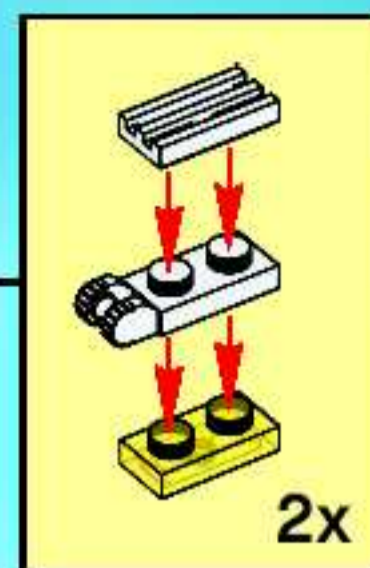

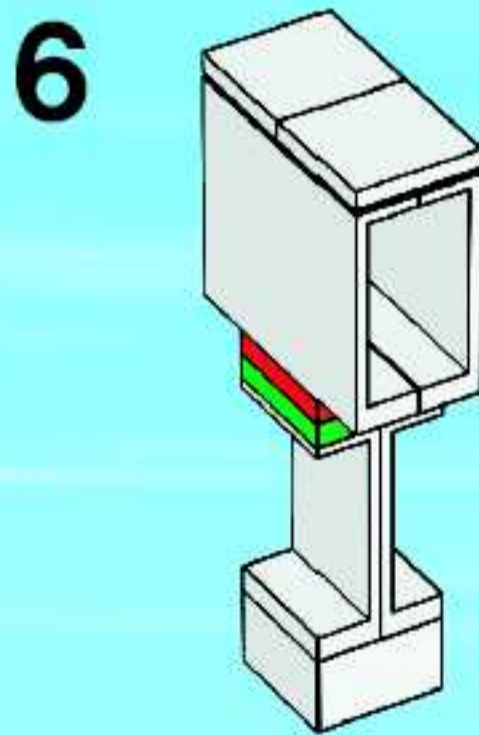
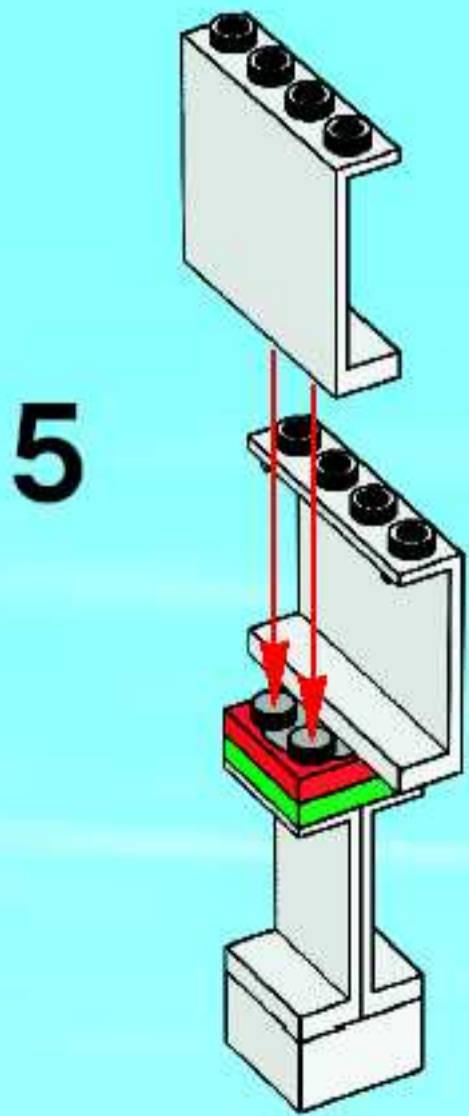
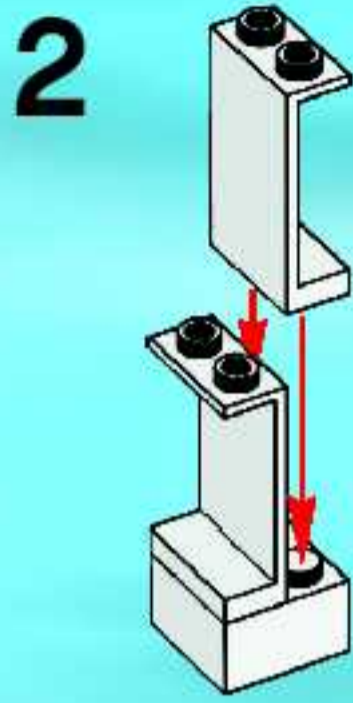
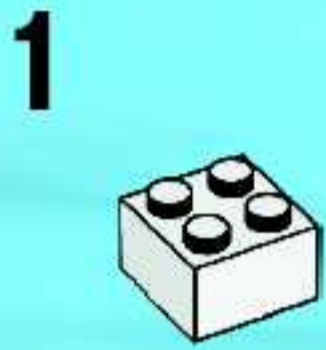
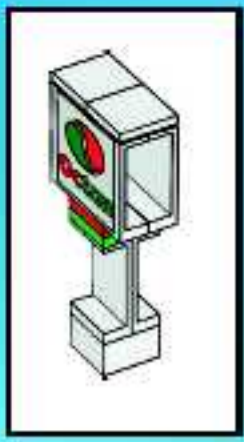

47

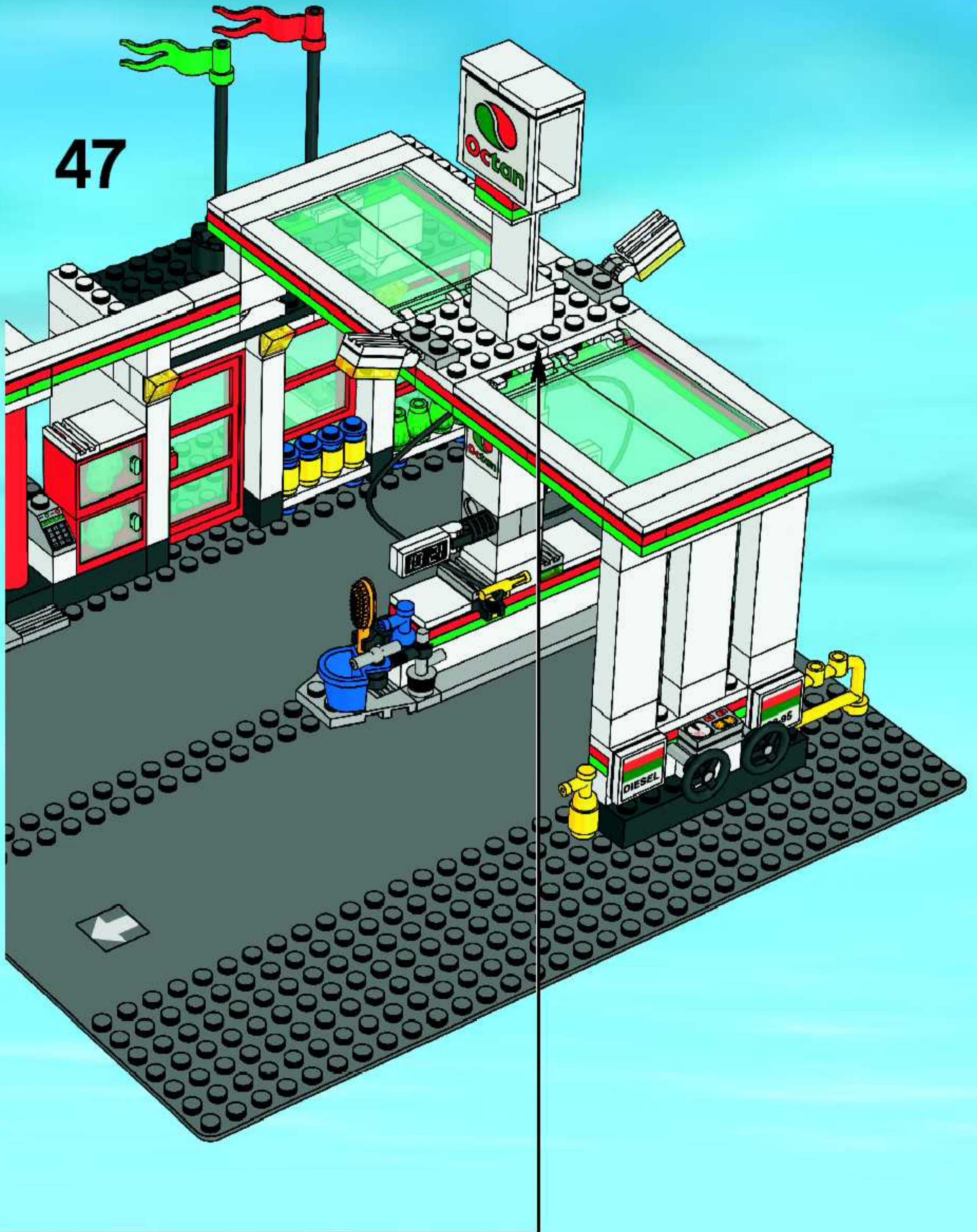

48

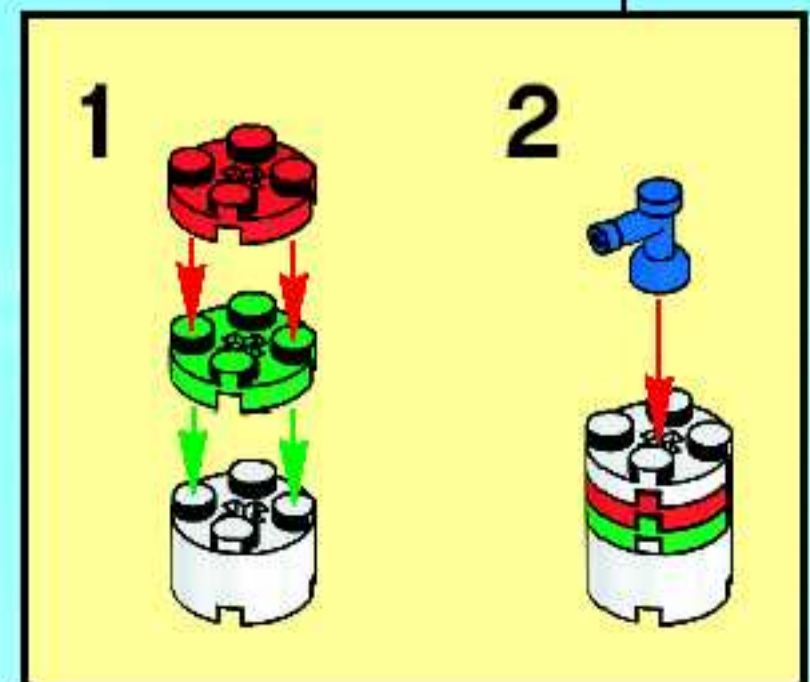
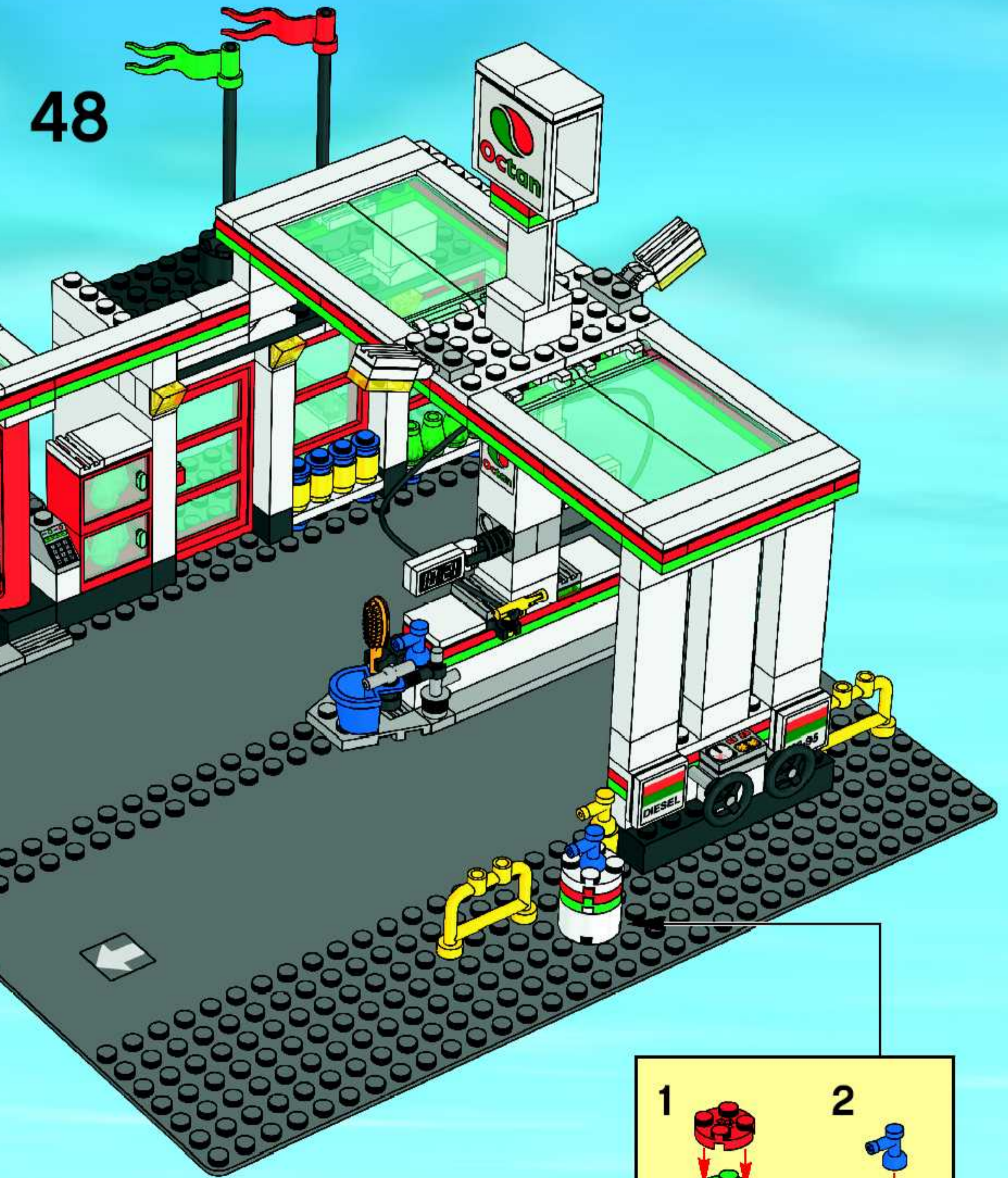

49

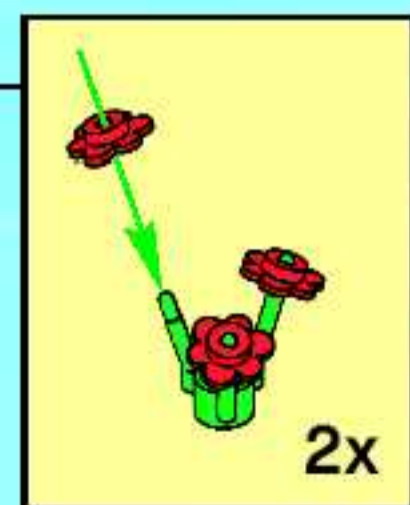
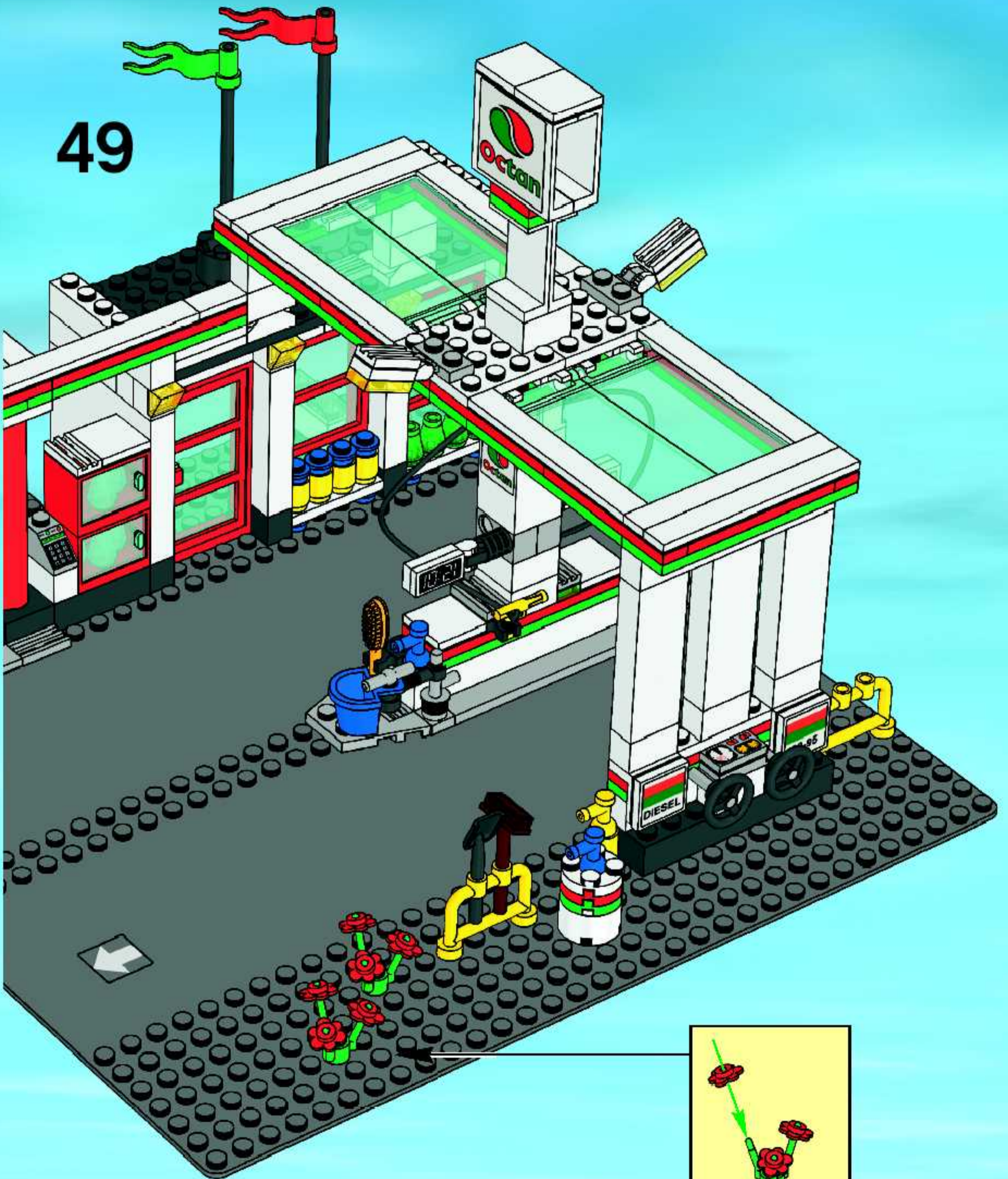

1

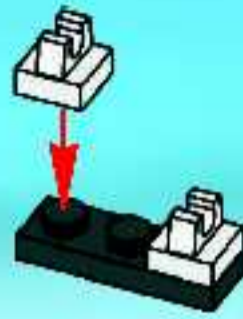

2

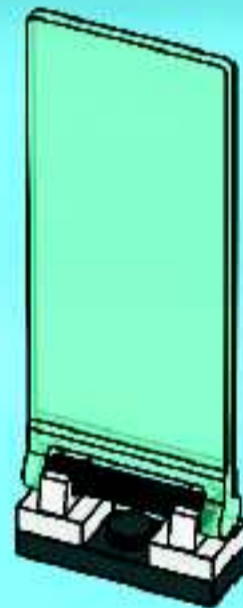

3

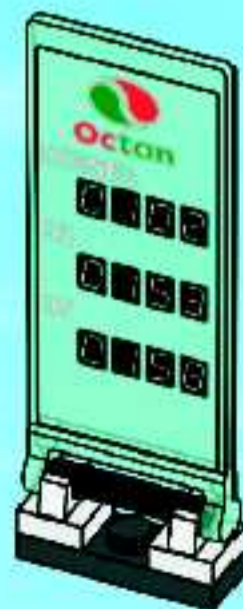



50

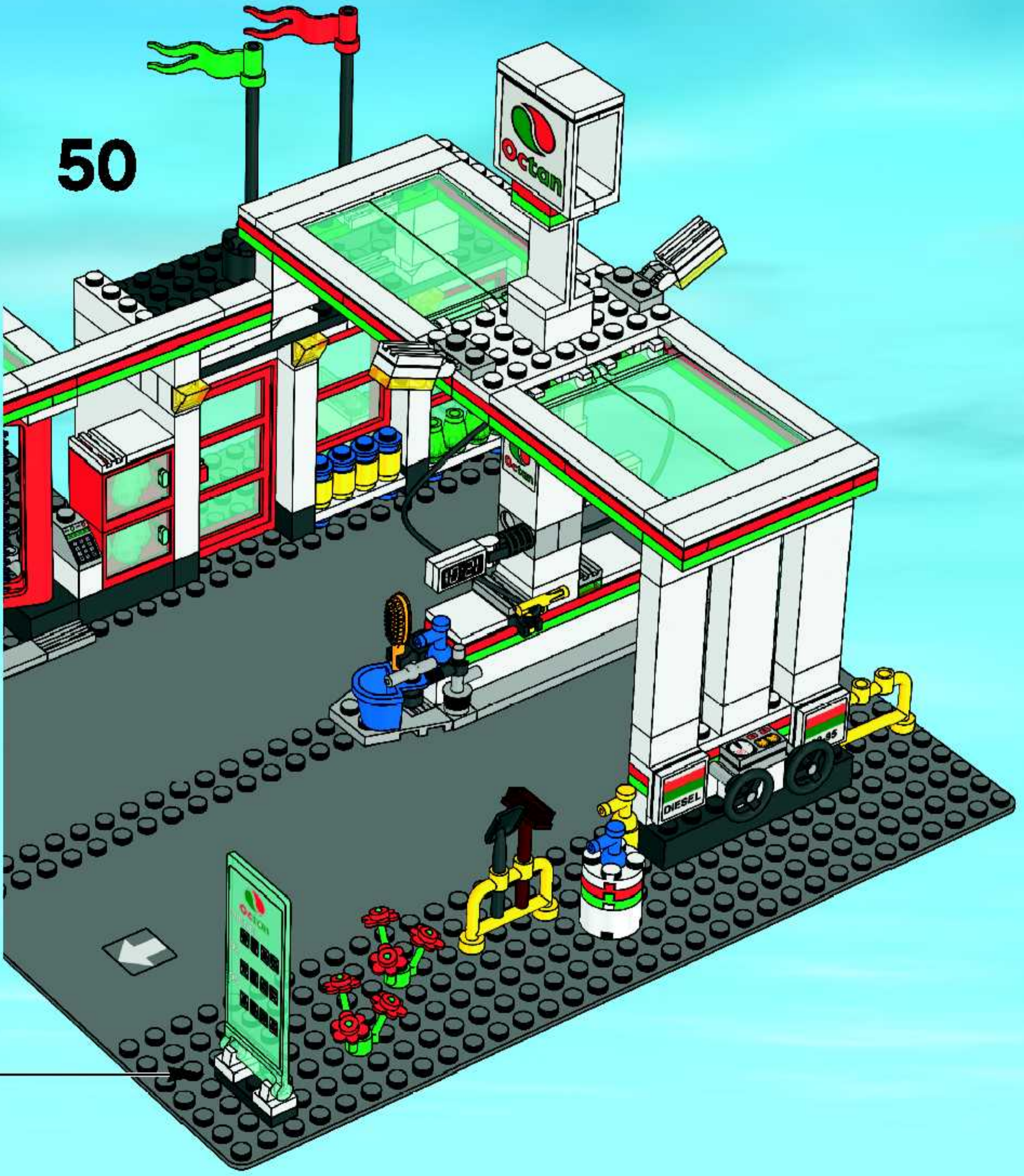

51

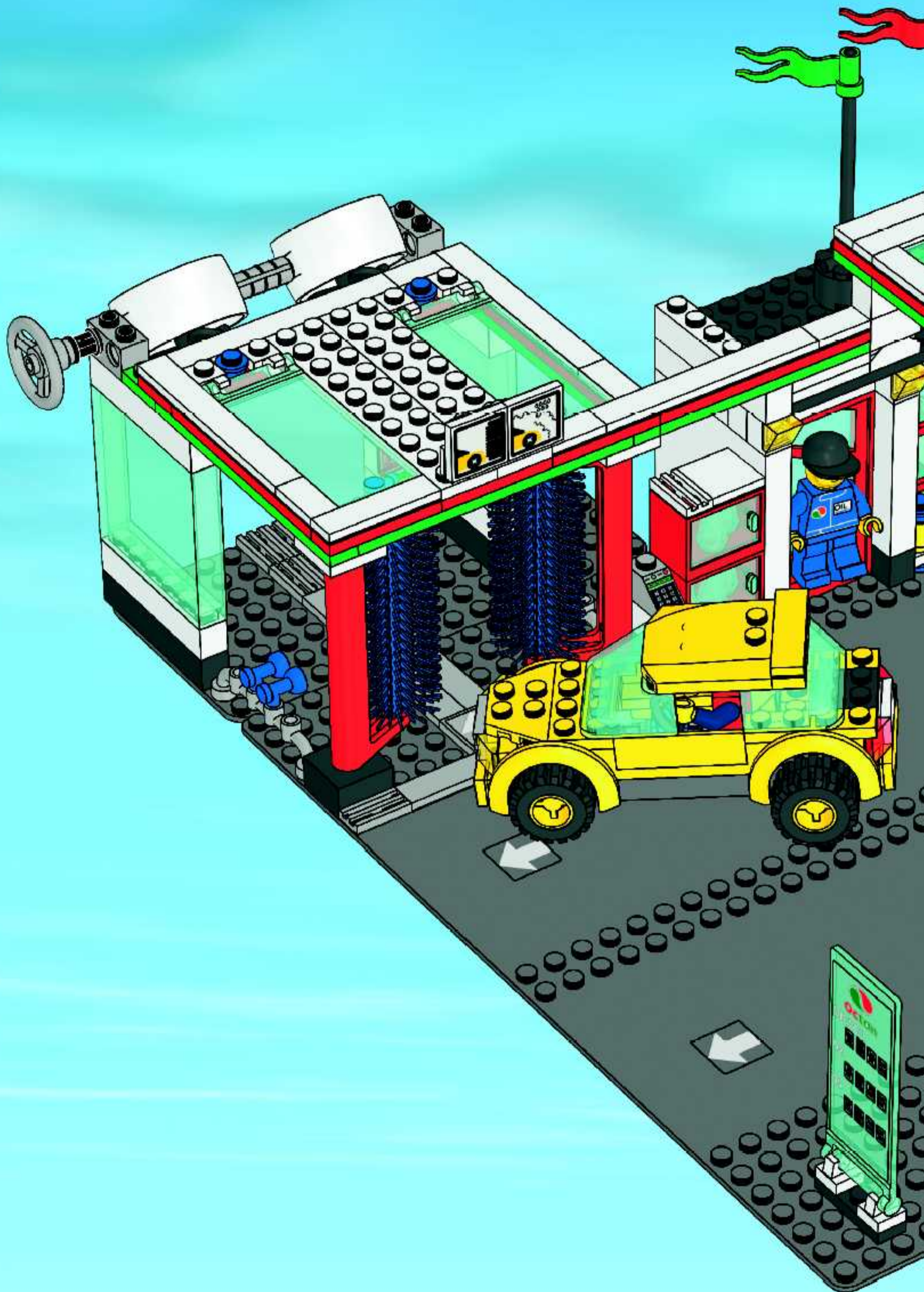



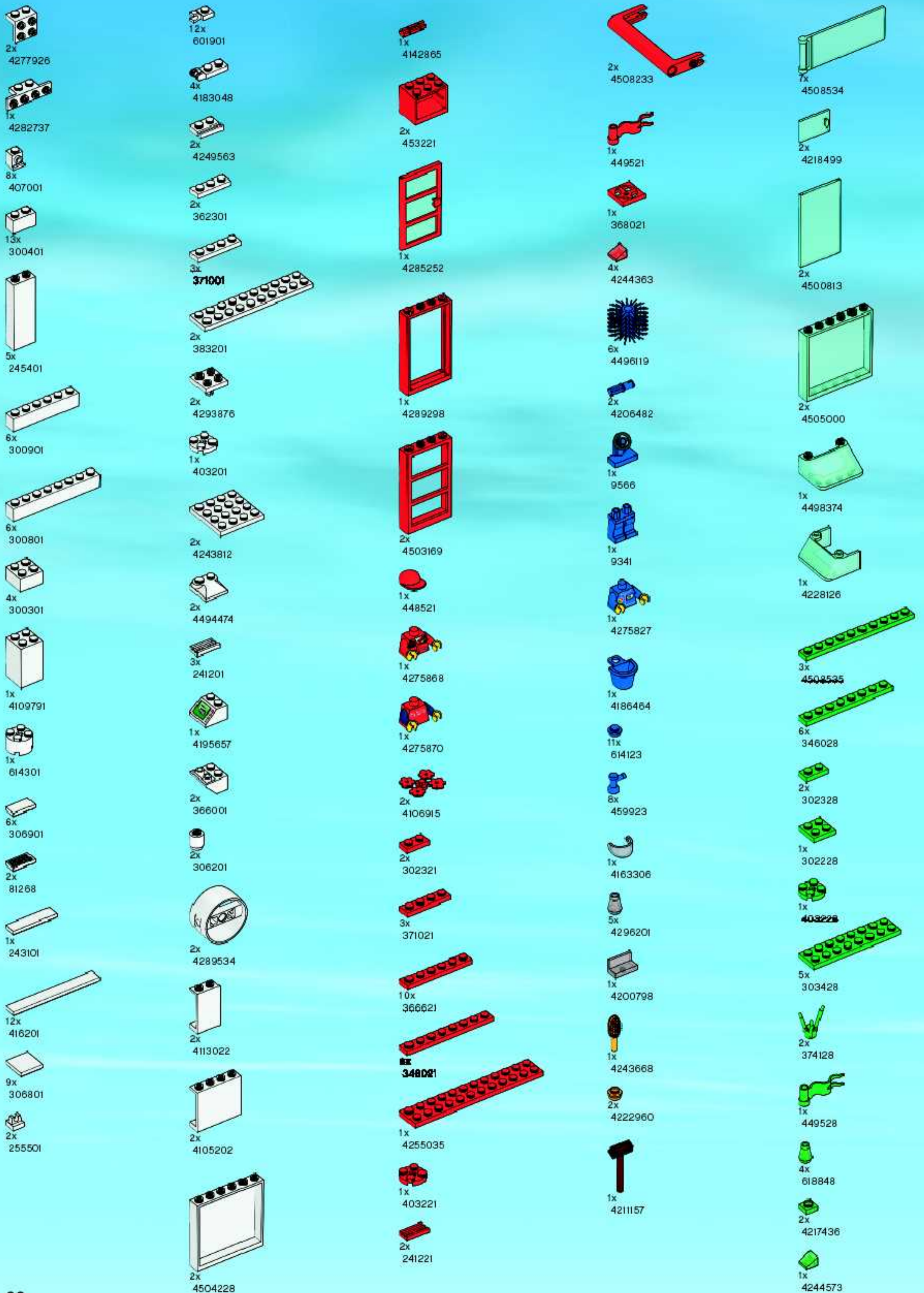

1x  
4194017

1x  
4200908

1x  
4261572

2x  
4515896

3x  
371024

1x  
302024

1x  
4260192

1x  
4193073

4x  
4170460

5x  
306224

1x  
4256320

2x  
4503844

2x  
4171666

2x  
4288592

4x  
4288594

3x  
243124

2x  
408324

2x  
4194746

7x  
4260942

1x  
70905

2x  
4508536

2x  
300126

1x  
300726

2x  
614326

1x  
4141580

1x  
423319

2x  
384926

1x  
4189009

1x  
448526

1x  
4492322

1x  
4242385

3x  
408526

2x  
379426

1x  
362326

2x  
302226

2x  
300426

4x  
300926

1x  
4140801

2x  
604126

2x  
4153044

2x  
4159335

4x  
4514560

2x  
4244953

1x  
4500577

1x  
4222693

2x  
4503176

1x  
4259673

3x  
4211481

1x  
4211413

2x  
4211524

1x  
4211464

1x  
4227657

2x  
4211814

2x  
4211445

2x  
4240013

1x  
4215405

1x  
4211439

2x  
4211569

4x  
4211541

13x  
4211350

2x  
4259653

1x  
4228198

1x  
4211578

3x  
4211508

1x  
4261357

3x  
4211807

1x  
4211543

1x  
4227776



1x  
345626



1x  
4226978

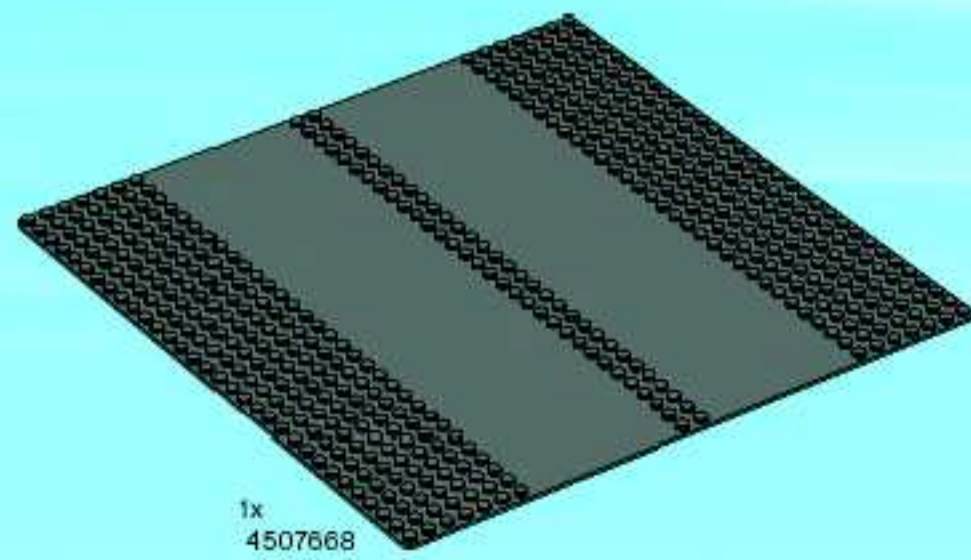

1x  
4507668

# Win! Gagne! 当たります Gewinne!

## Win LEGO products

We would like to know what you think about your new LEGO product. Log on to the web address below for further instructions.

## Gagne des produits LEGO

Nous aimerions savoir ce que tu penses de ton nouveau produit LEGO. Tu obtiendras davantage d'informations en visitant le site Internet indique ci-dessous.

## Gewinne LEGO produkte

Wir sind sehr an deiner Meinung über dein neues LEGO Produkt interessiert. Gehe einfach zu der unten angegebenen Webadresse – dort findest du weitere Informationen.

## Estimado usuario LEGO

Al contestar algunas preguntas en inglés, francés, alemán o japonés, en el sitio [www.acnielsen.aim.dk/lego](http://www.acnielsen.aim.dk/lego), podrás participar en el sorteo de algunos valiosos premios LEGO.

## Caro Consumidor da LEGO

Ao responder a algumas perguntas em Inglês, Francês, Alemão ou Japonês no endereço [www.acnielsen.aim.dk/lego](http://www.acnielsen.aim.dk/lego) irá participar num concurso para ganhar valiosos prémios da LEGO.

## Kedves ifjú LEGO Vásárló

Ha ellátogatsz a [www.acnielsen.aim.dk/lego](http://www.acnielsen.aim.dk/lego) honlapra és ott angol, francia, német vagy japán nyelven megválaszolsz néhány kérdést, akkor részt veszel egy versenyben, amelyben értékes LEGO díjakat nyerhetsz.

## 抽選でレゴ®製品が当たります

私たちは、皆さんがお買い求めのレゴ®製品についてどんな感想をお持ちか、知りたいと思っています。質問に答えて、楽しいレゴ製品の抽選に応募しませんか。アンケートの回答には、ほんの3分ほどしかかかりません！詳しくは、以下のウェブアドレスまでアクセスしてください。

[www.acnielsen.aim.dk/LEGO](http://www.acnielsen.aim.dk/LEGO)

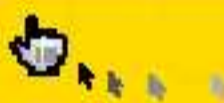

Any questions regarding your new LEGO product, please contact:

**Customer Service | Kundenservice**

**Service Consommateurs**

**Servicio Al Consumidor at**

**[www.lego.com/service](http://www.lego.com/service) or dial**

 :

**00800 5346 5555**

 :

**1-800-422-5346**



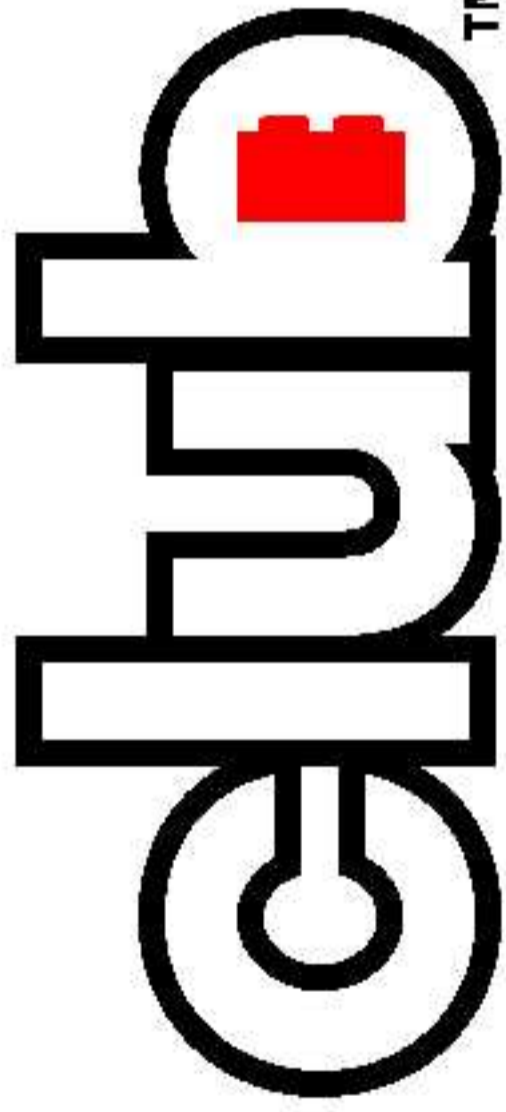

TM

FREE LEGO Magazine • GRATUIT • GRATIS LEGO Magazin



**Join Today!**  
 .....  
**Abonne-toi**  
**dès aujourd'hui !**  
 .....  
**Meld je nu aan!**  
 .....  
**Jetzt anmelden!**



US & Canada only

1-866-534-6258 / 1-877-518-5346

(en Français)

00800 5346 5555



[www.LEGOclub.com](http://www.LEGOclub.com)



VISIT THE

**WORLD'S BIGGEST  
LEGO® SHOP!**

[www.LEGOshop.com](http://www.LEGOshop.com)



**YES!** I want to join the LEGO® Club FREE!  
**OUI!** Je veux m'abonner au Club LEGO® GRATUITEMENT!  
**Ja!** Ich möchte Mitglied im kostenlosen LEGO Club werden. **Ja!** Ik wil graag GRATIS lid worden van de LEGO Club.

BG27

First Name  
Prénom  
Vorname  
Voornaam

--	--	--	--	--	--	--	--	--	--	--	--	--	--	--	--	--	--	--	--

Last name  
Nom de famille  
Familienname  
Achternaam

--	--	--	--	--	--	--	--	--	--	--	--	--	--	--	--	--	--	--	--

Date of Birth  
Date de naissance  
Geburtsstag  
Geboortedatum

--	--	--	--	--	--	--	--	--	--	--	--	--	--	--	--	--	--	--	--

Boy  
Garçon  
Junge  
Jongen

Girl  
Fille  
Mädchen  
Meisje

Street, No.  
Rue  
Straße, Hausnr.  
Straat, huisnr.

--	--	--	--	--	--	--	--	--	--	--	--	--	--	--	--	--	--	--	--

City/County  
Ville  
Stadt  
Woonplaats

--	--	--	--	--	--	--	--	--	--	--	--	--	--	--	--	--	--	--	--

State  
Prov.

--	--	--	--	--	--	--	--	--	--	--	--	--	--	--	--	--	--	--	--

Zip/Postcode  
Code Postal  
PLZ  
Postcode

--	--	--	--	--	--	--	--	--	--	--	--	--	--	--	--	--	--	--	--

Country  
Pays  
Land

--	--	--	--	--	--	--	--	--	--	--	--	--	--	--	--	--	--	--	--

Telephone  
No de Téléphone  
Telefonnr.  
Telefoonnummer

--	--	--	--	--	--	--	--	--	--	--	--	--	--	--	--	--	--	--	--

Parent's signature  
Signature d'un parent  
Underschrift Erziehungsberechtigte/r  
Handtekening ouders

---

Mail to: / Poster à:  
**LEGO Club**  
**P.O. Box 1157**  
**Enfield, CT USA**  
**06083-1157**

Mail to:  
**LEGO Club**  
**33 Bath Road**  
**Slough SL1 3UF**  
**United Kingdom**

Per Post an:  
**LEGO® Club**  
**Postfach 14 15**  
**D-36243 Niederaula**

Stuur op naar:  
**LEGO® Club**  
**Postbus 40252**  
**3504 AB Utrecht**

The English version of the magazine can only be mailed to addresses in the US, Canada, the UK, and Republic of Ireland. Club membership is valid for 2 years and includes free copies of the LEGO Magazine. In the US and Canada please allow up to 6 weeks for delivery of your first magazine. By signing this form you consent the LEGO Club to use your child's data for LEGO mailings. The data will only be used for LEGO mailings and will not be sold, rented or otherwise disclosed to any company outside the LEGO Company except for disclosure to companies acting as our agents to help us provide services requested by the child. This coupon good for one free membership per person, group or organization (photocopies not accepted).  
 La version française du magazine peut être postée uniquement au Canada. L'abonnement est valide pour 2 ans et inclut des exemplaires gratuits du Magazine LEGO. Aux É.-U. et au Canada, allowez 6 semaines pour la livraison initiale. En remplissant ce formulaire, vous consentez à ce que LEGO utilise les informations de votre enfant pour des envois postaux de LEGO. L'information sera utilisée uniquement pour des envois postaux par LEGO et ne sera en aucun cas, vendue, louée, échangée ou divulguée à d'autres compagnies autres que la compagnie LEGO, à l'exception des compagnies affiliées qui nous procurent des services auxquels l'enfant en a fait la demande.  
 Das deutschsprachige Angebot gilt nur für die Länder D, AU und CH. Die kostenlose Mitgliedschaft beinhaltet die Zusendung des LEGO Magazins und endet nach zwei Jahren. Für die Mitglieder entstehen keine Verpflichtungen. Es kann bis zu drei Monate dauern, bis das erste Magazin zugestellt wird. Mit Ihrer Unterschrift erklären Sie sich einverstanden, dass die Daten Ihres Kindes zum Zweck einer LEGO Club-Mitgliedschaft von der LEGO Gruppe gespeichert werden. Die Daten werden vertraulich behandelt und nicht an Dritte weitergegeben, außer an Dienstleister der LEGO Clubs. Wenn Sie außer vom LEGO Club keine weiteren Informationen von der LEGO Company bekommen möchten bitte hier ankreuzen:   
 Door dit formulier te tekenen geeft u de LEGO Club toe stemming om bovenstaande gegevens te gebruiken voor het toesturen van LEGO mailings. Uw gegevens worden uitsluitend gebruikt voor mailings van LEGO en zullen niet worden verkocht verhuurd of op welke wijze dan ook verstrekt aan derden buiten de LEGO groep, uitgezonderd de organisaties die namens ons optreden om de service te verlenen waar uw kind om gevraagd heeft.





# CITY



7990



7991



7992



7993



7994



7241

7942

7238

7239

7945



CITY



7944





©2007 The LEGO Group. 451 6696

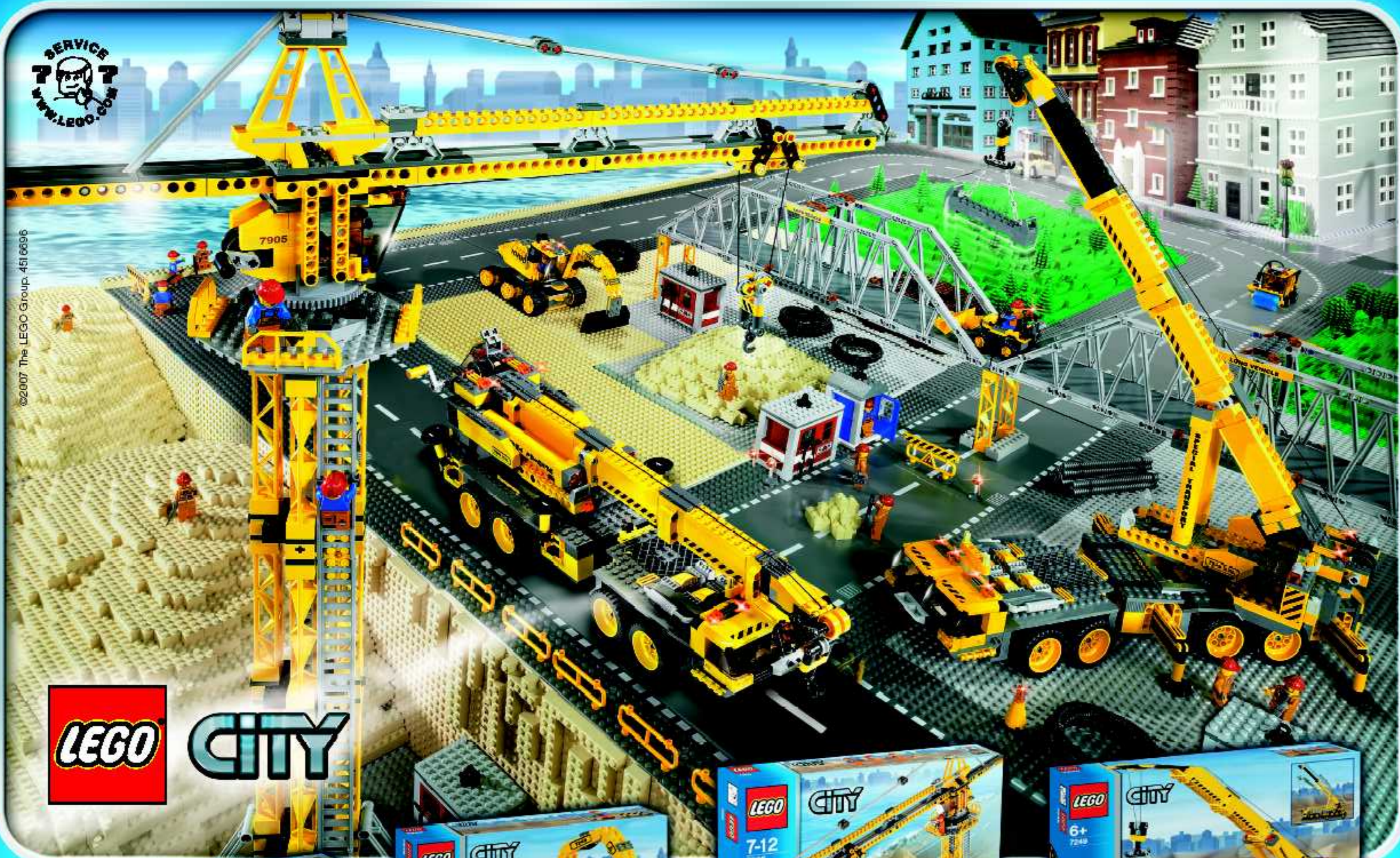

CITY



7248



7242



7248



7905



7249