



# THE BATMAN



76179



2

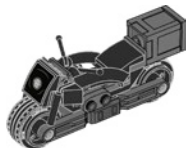

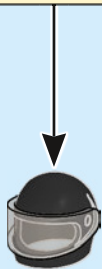
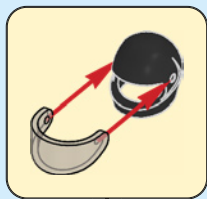
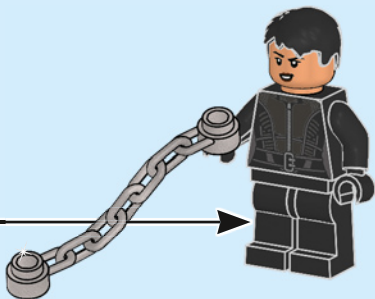
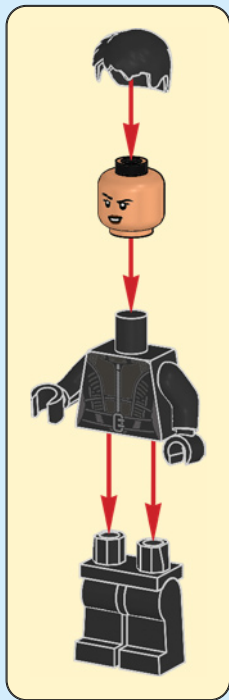

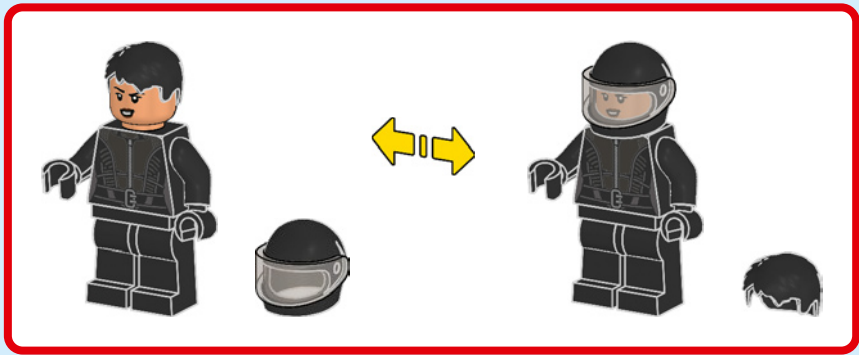

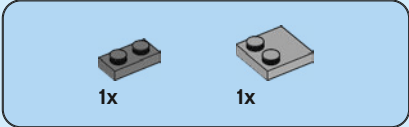

**1**

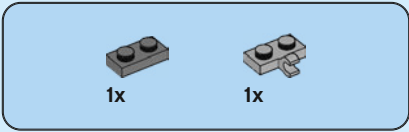
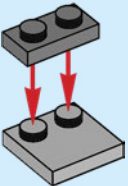

**2**

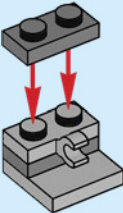



1x

3

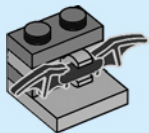

6

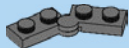

1x

4

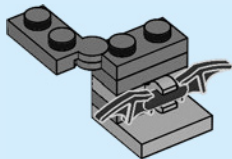



1x



1x

5

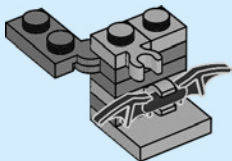

1x

6

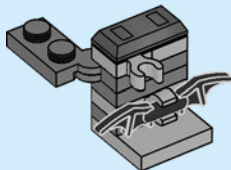

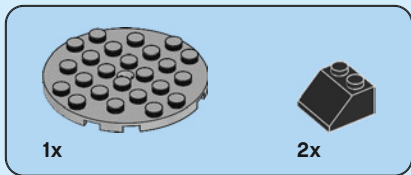

7

1

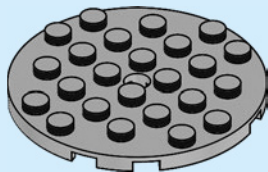

2

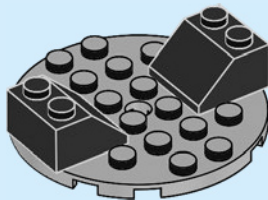

8



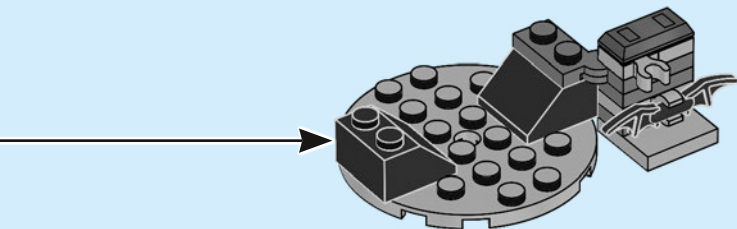



1x

8

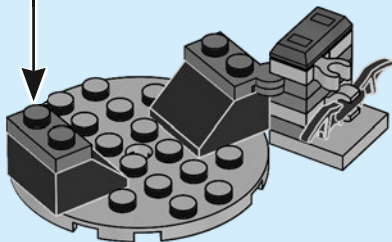

10

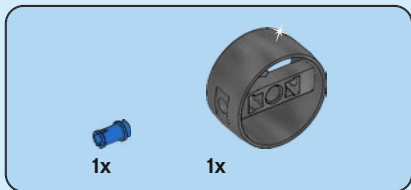

9

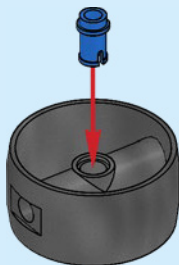

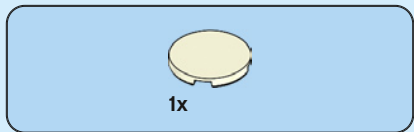

10

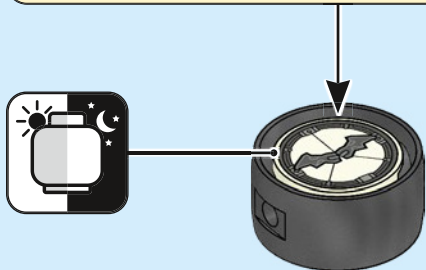
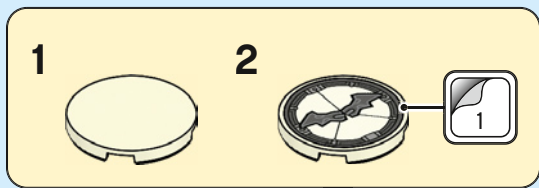



2x



2x



2x

# 11

1

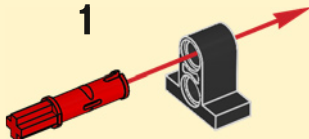

2

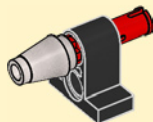

2x

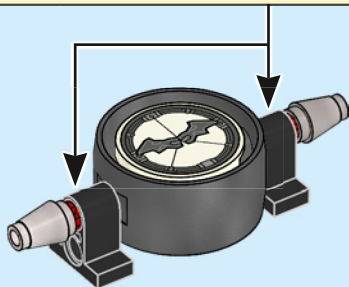

12

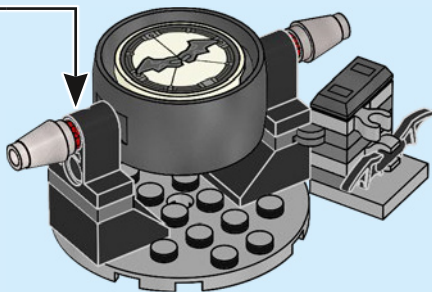

14



2x



1x



1x

# 13

1

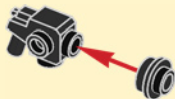

2

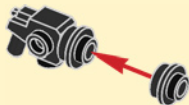

3

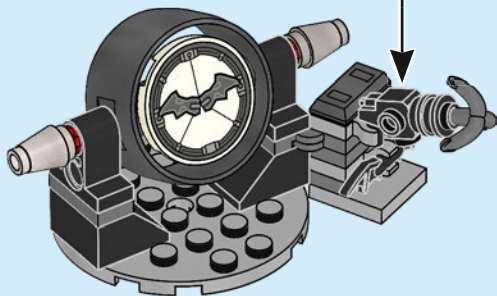

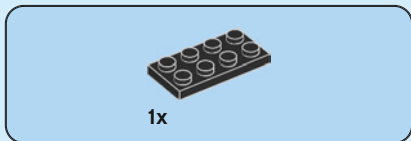
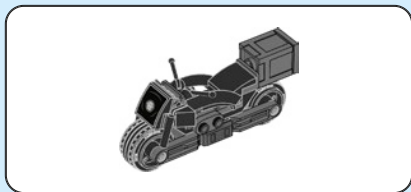

1x

1

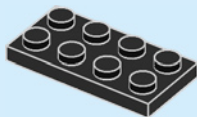



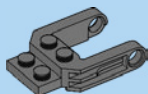

2x

2

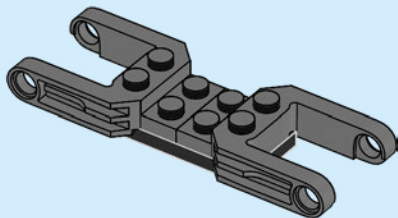

2x

3

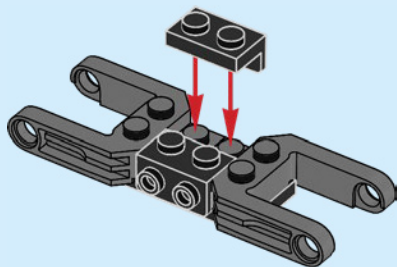



2x

4

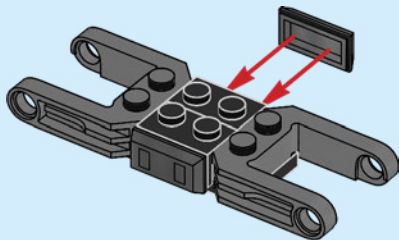

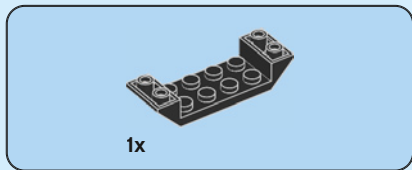

5

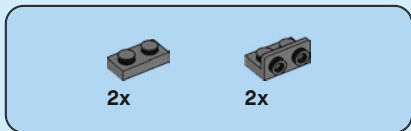
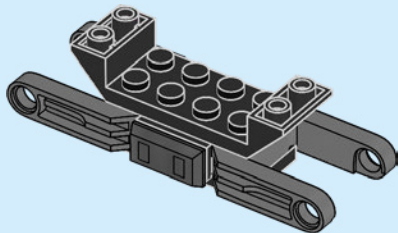

6

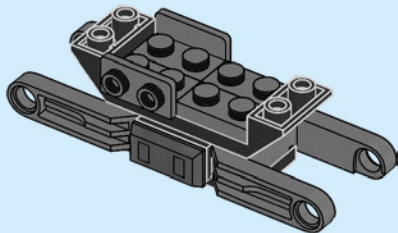



7

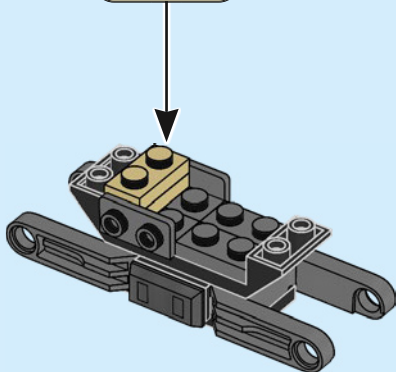
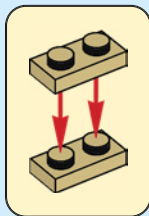

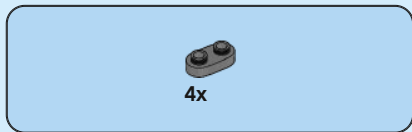

8

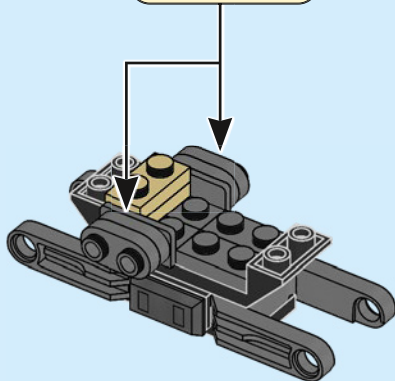
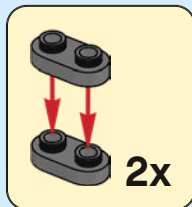



1x

9

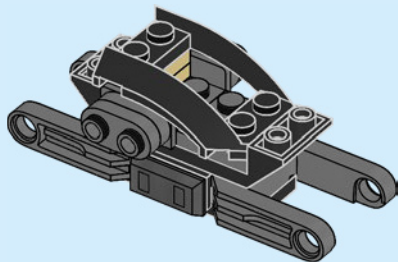

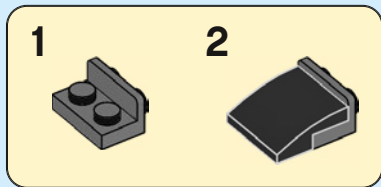
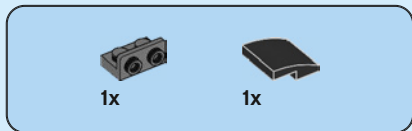

10

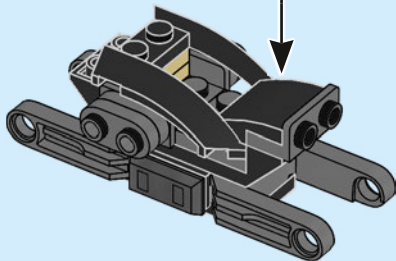



2x

11

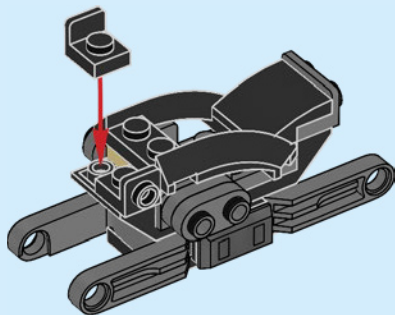





1x

**12**

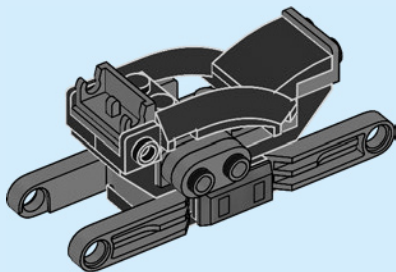

2x

**13**

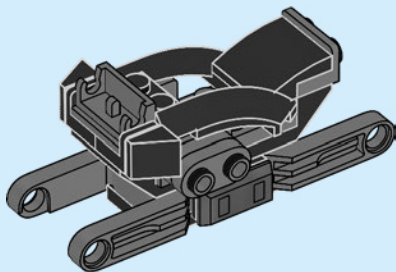

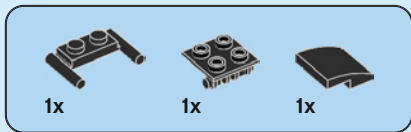

# 14

1

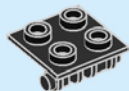

2

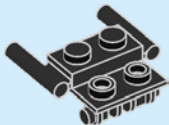

3



4

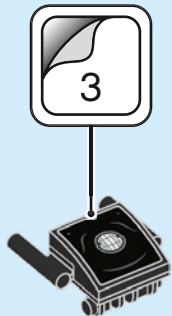

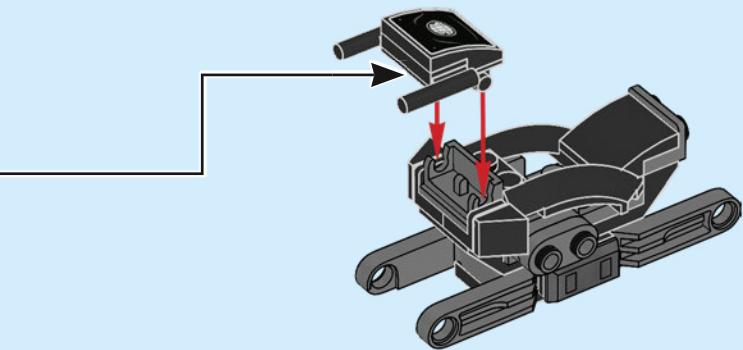



2x

15

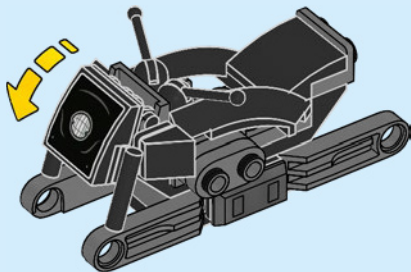



2x

# 16

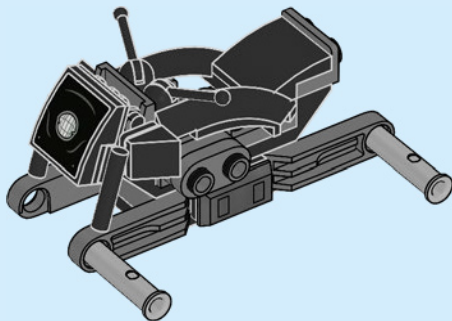



2x



2x

# 17



2x

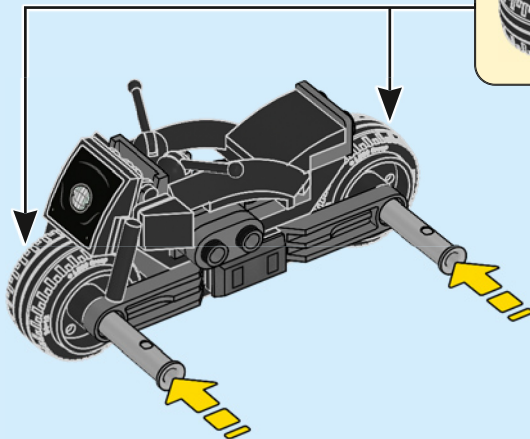

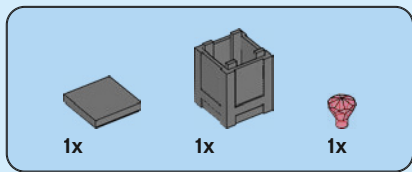

18

1

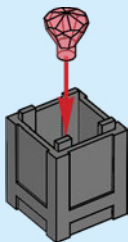

2

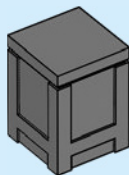

3

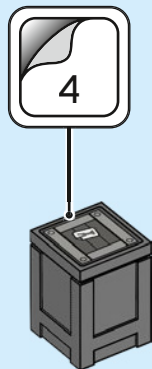

LEGO and the LEGO logo are trademarks of the/son des marques de commerce du/son marcas registradas de LEGO Group.

©2022 The LEGO Group. 6411880



THE BATMAN and all related characters and elements © & ™ DC Comics and Warner Bros. Entertainment Inc. WB SHIELD: © & ™ WBEI. (s22)

