

2

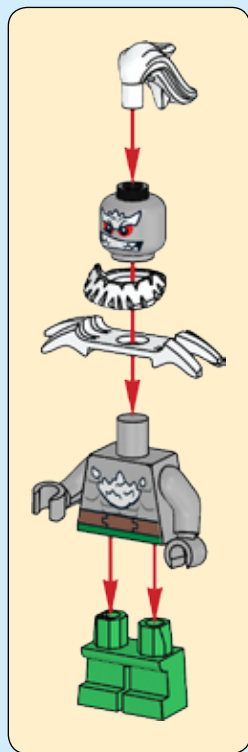

1



2

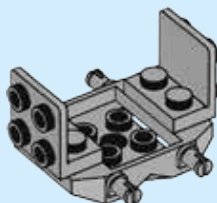

3

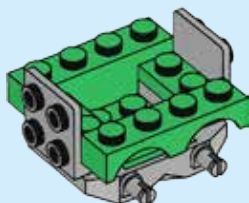

4

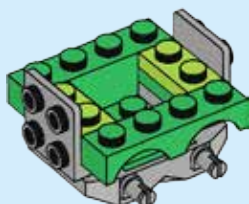

5

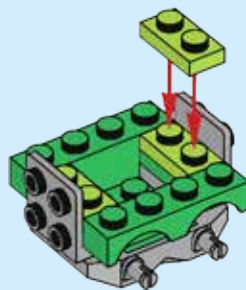

6

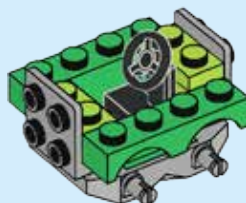

7

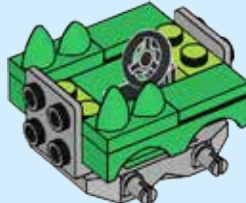

8

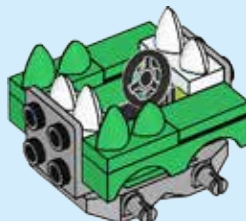

9

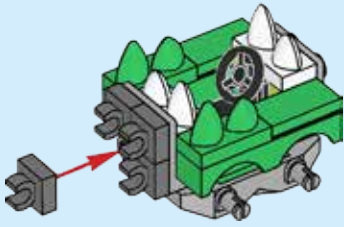

10

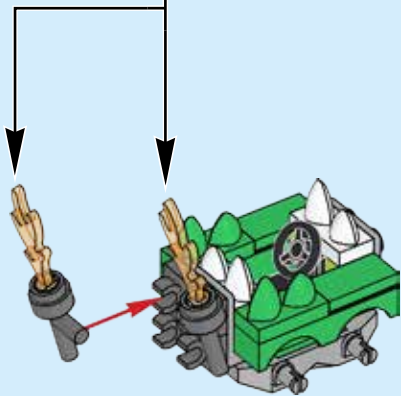
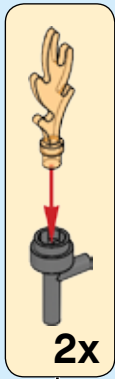

11



12

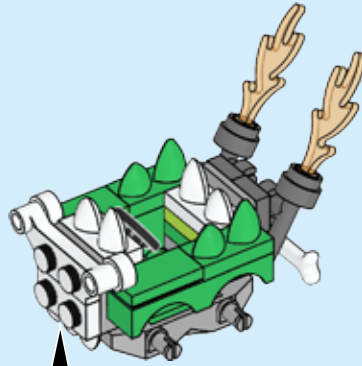
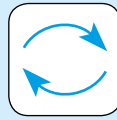

13

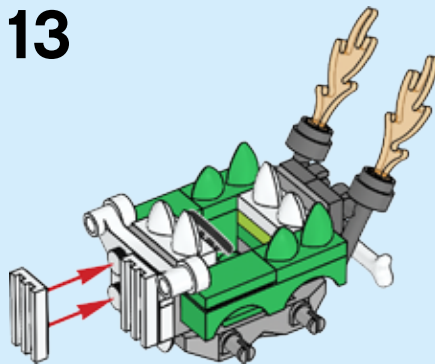

14

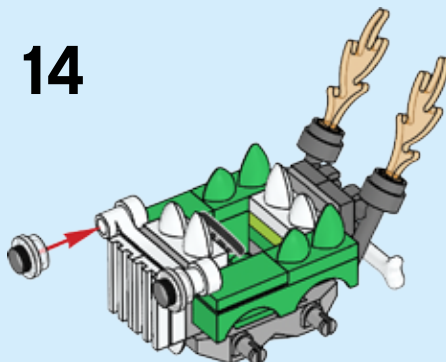

15

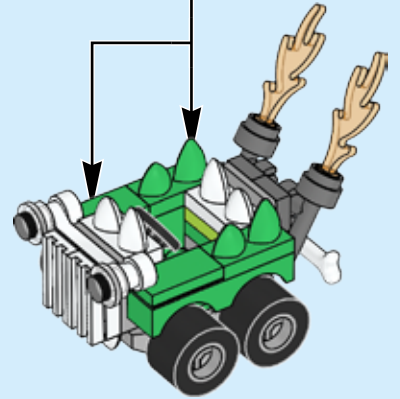
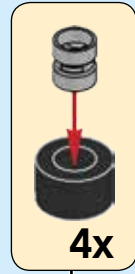

LEGO.com/service

LEGO and the LEGO logo are trademarks of the LEGO Group. ©2017 The LEGO Group. 6187722

DC All DC characters and elements © & ™ DC Comics.

WB SHIELD: TM & © WBEI. (s17)