



# MARVEL SUPER HEROES



76005



MARVEL  
ULTIMATE  
SPIDER-MAN™



1



2



3



4



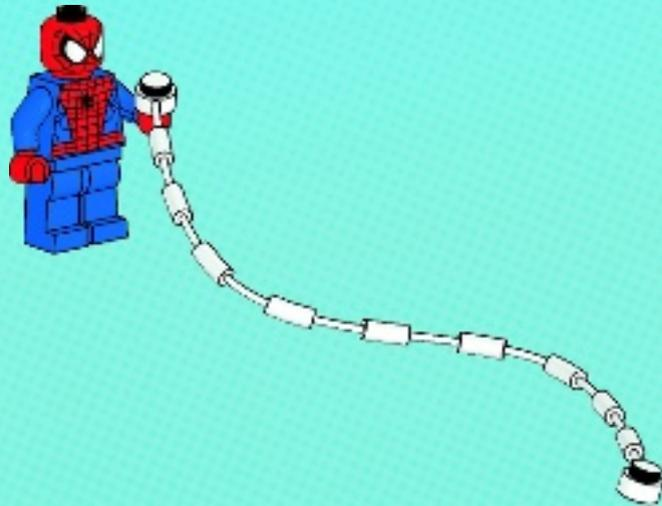
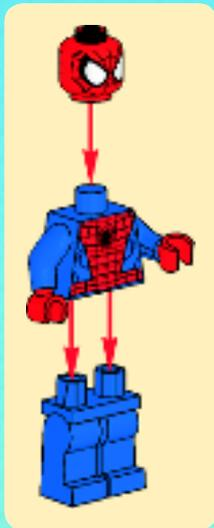
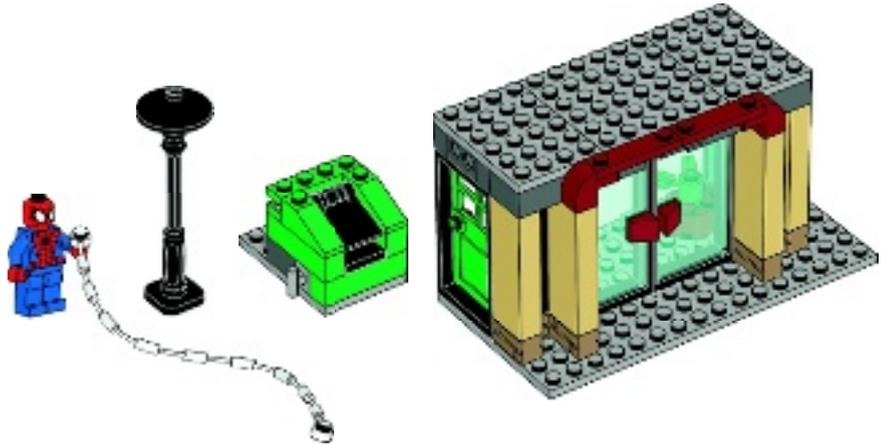

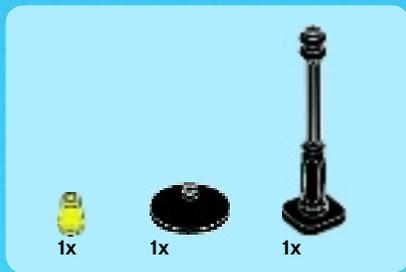

1

1



2



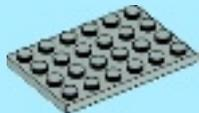

1x

1

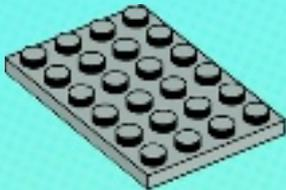

1x



2x

2

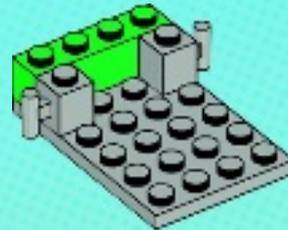



2x



1x

3

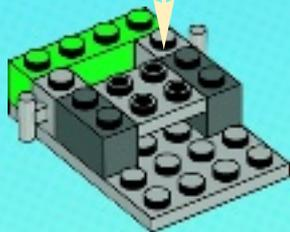
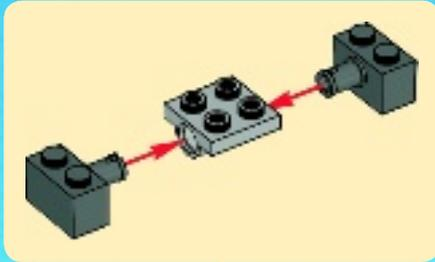

1x

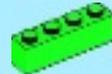

2x

4

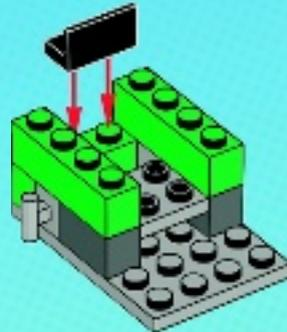



1x

5



2x

6

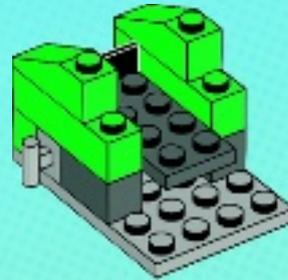
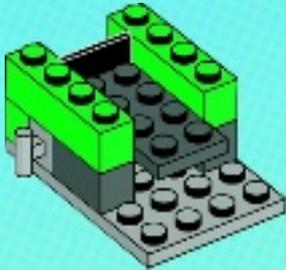



2x



1x



2x

# 7

1



2



3

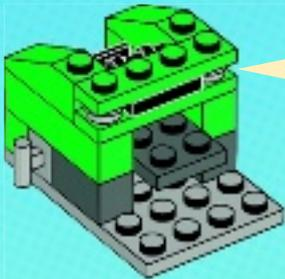
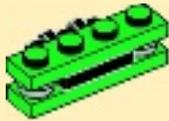

1x

# 8

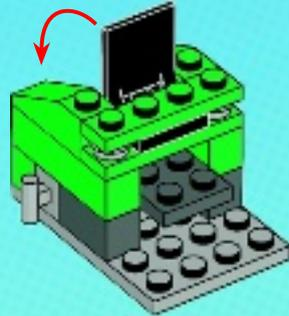

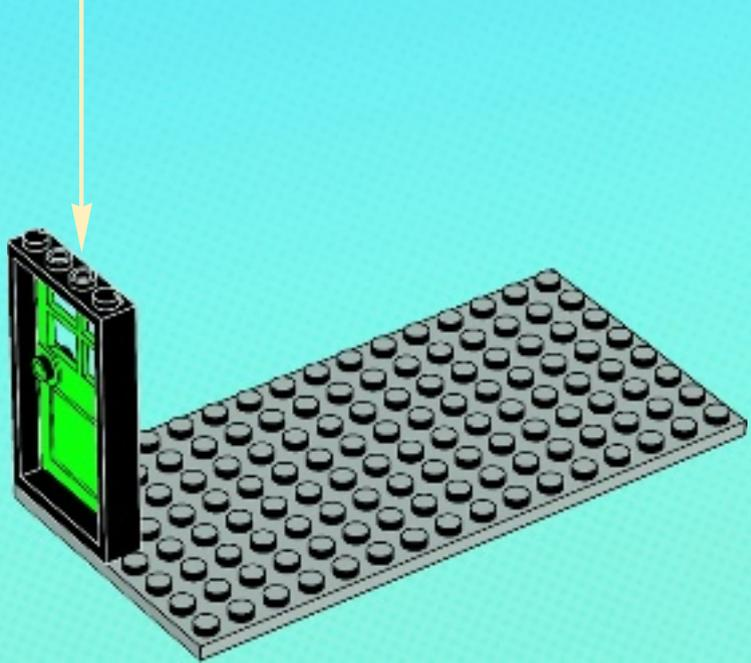
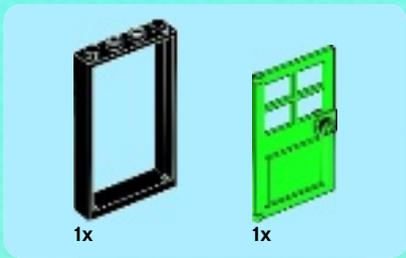
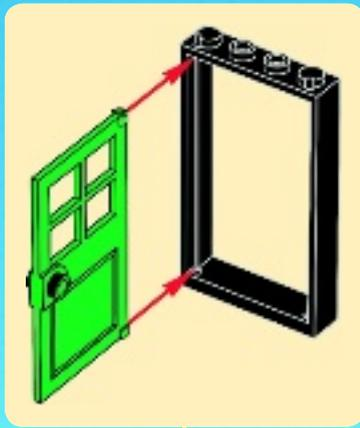

1



3x

2

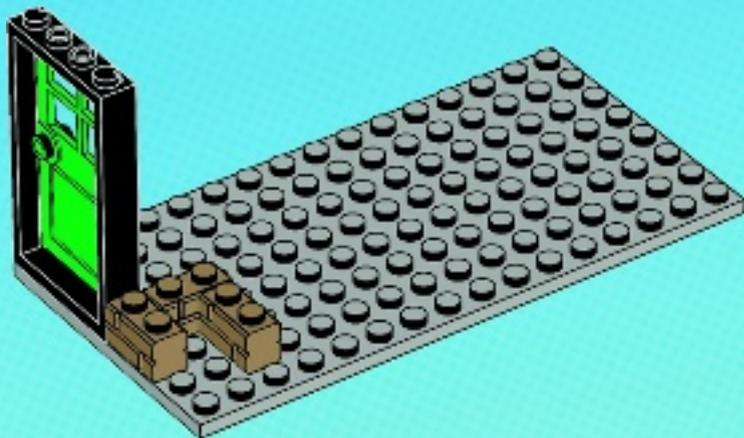

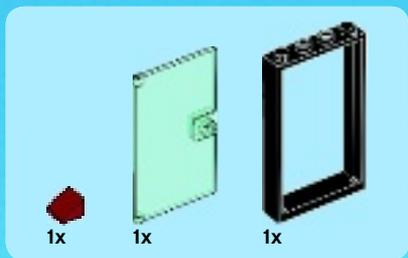

3

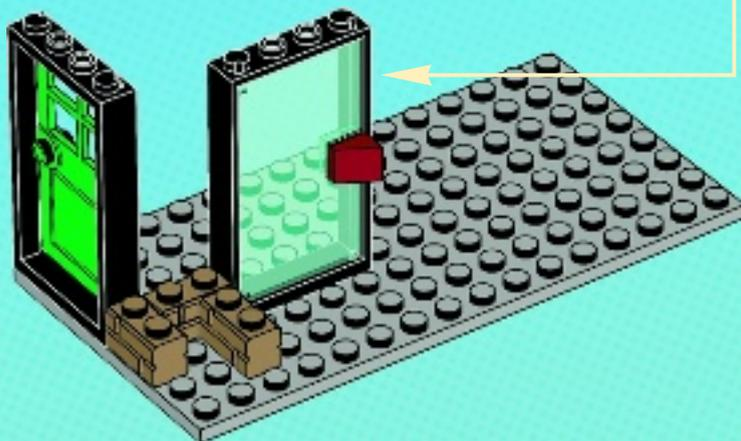
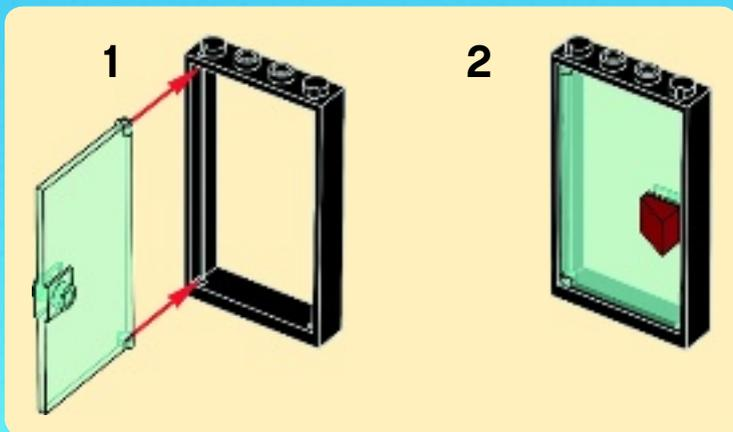

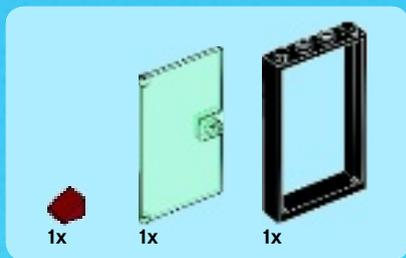

4

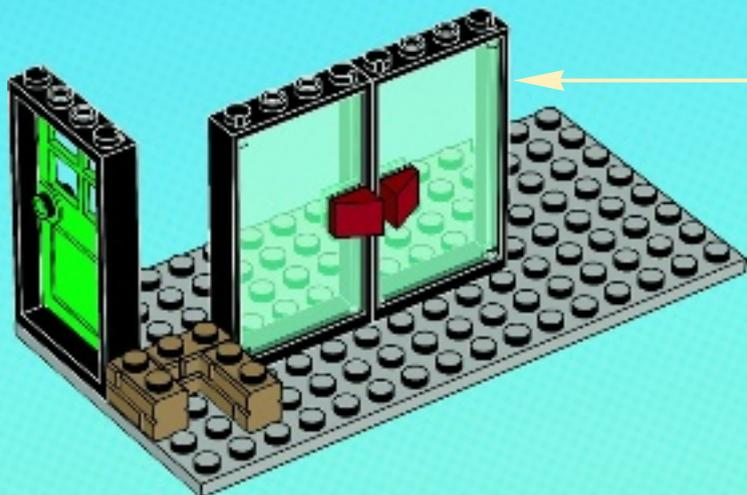
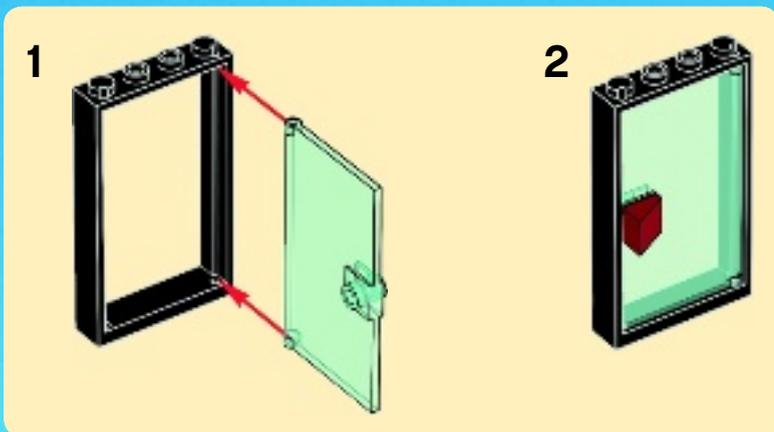



3x

5

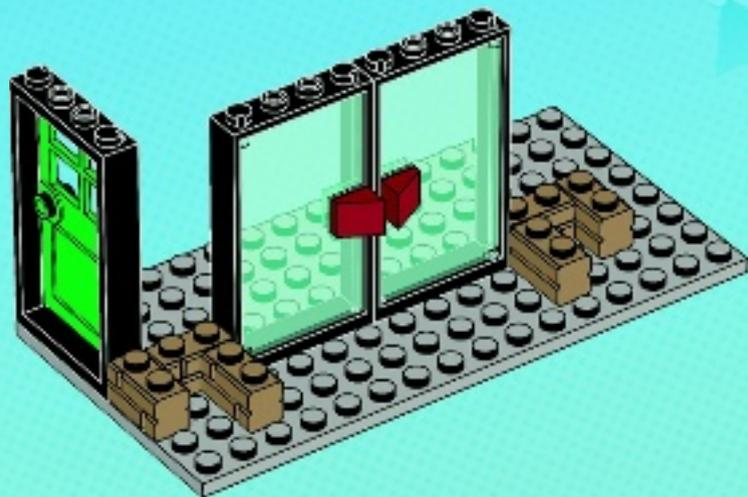



2x



4x

# 6

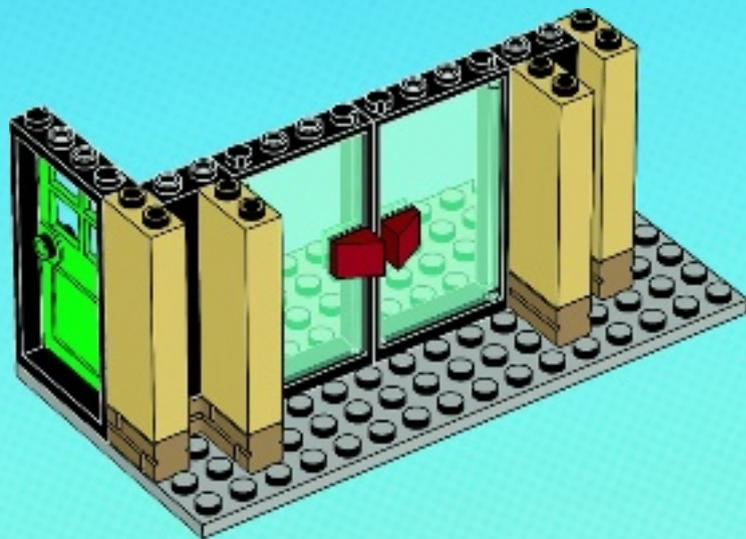

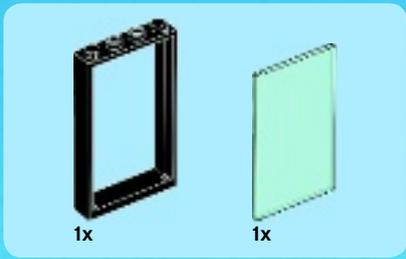

7

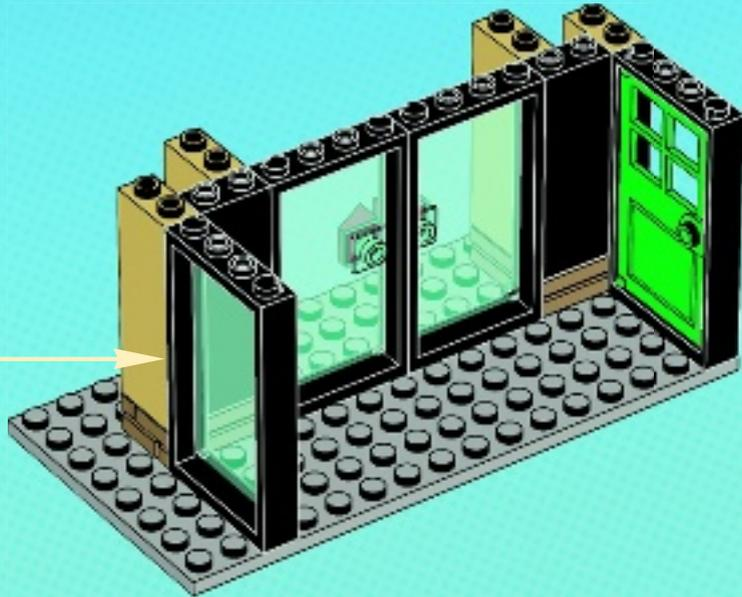
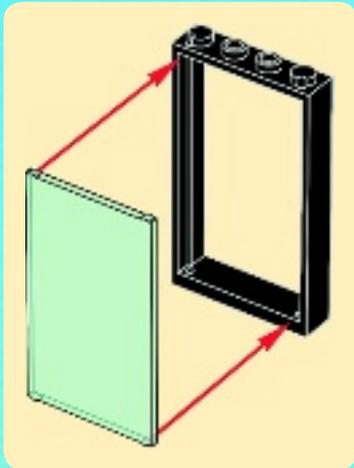



2x

8

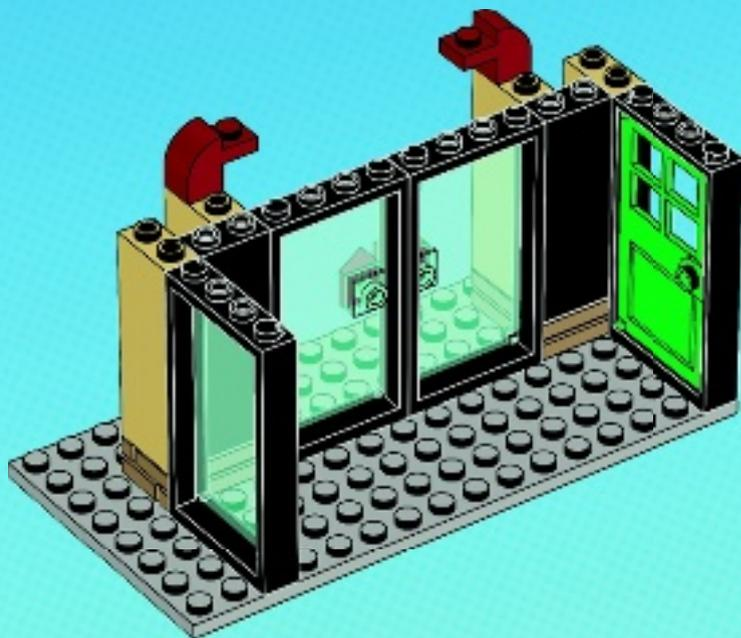



2x

9

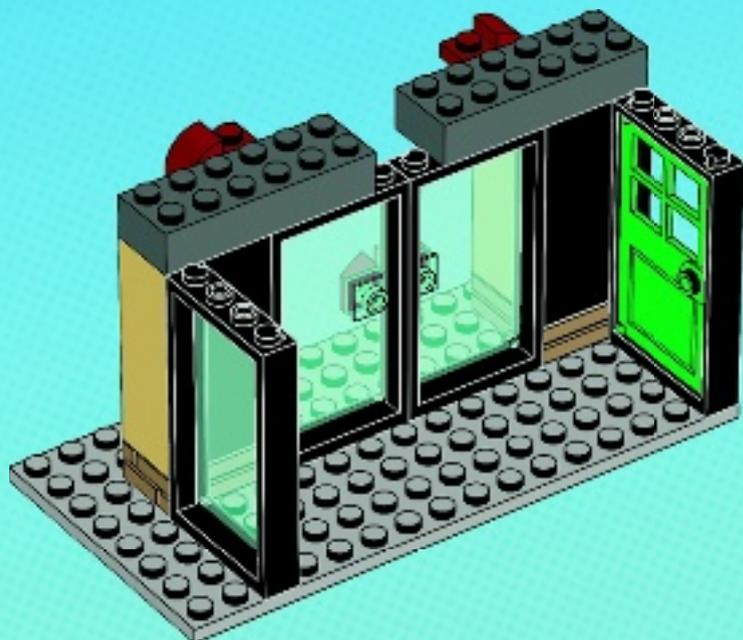



1x

# 10

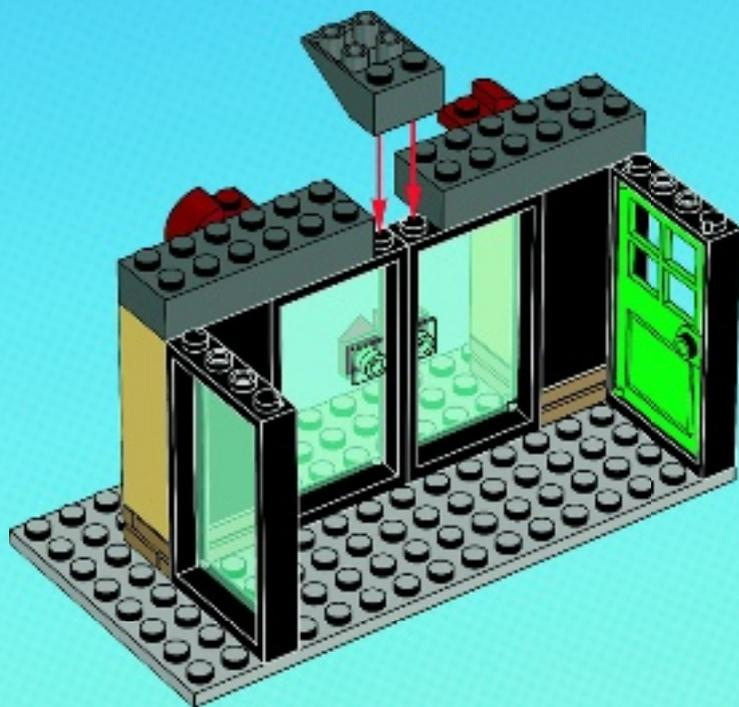



1x



1x

# 11

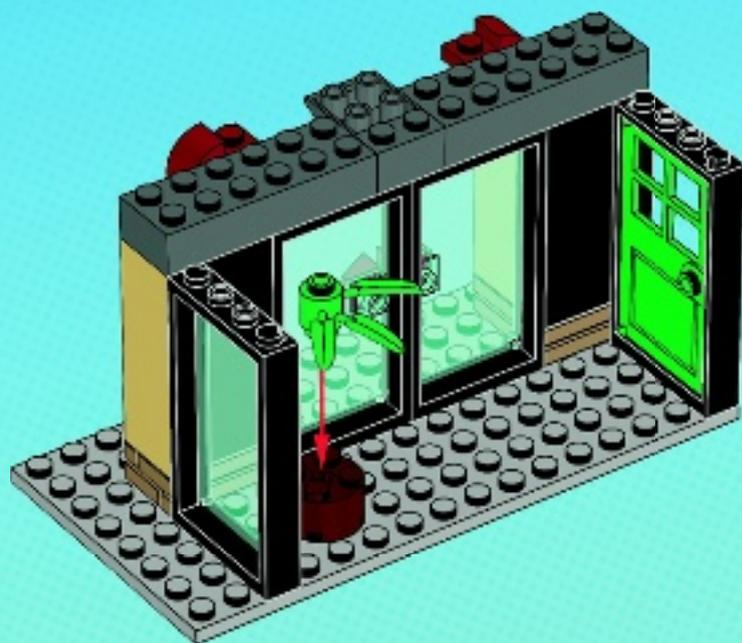



2x



2x

# 12

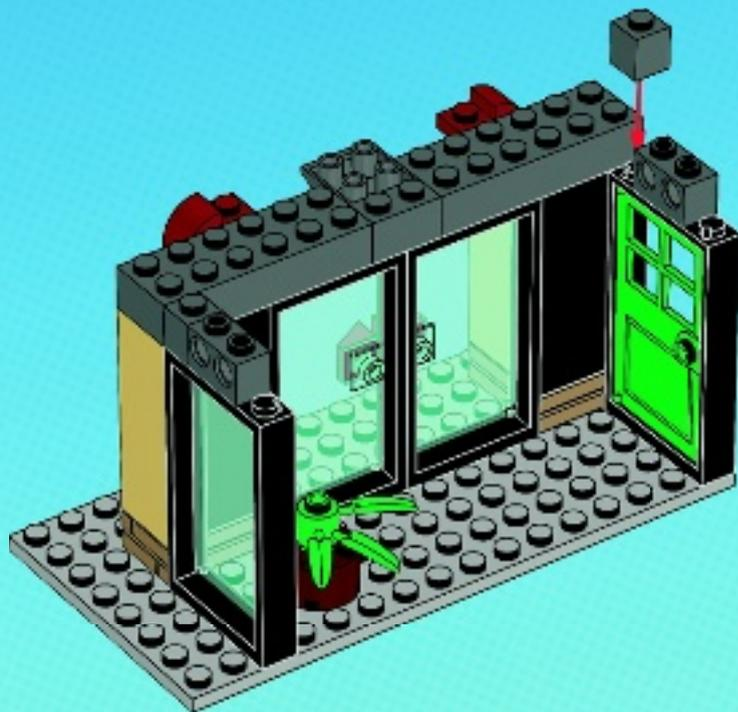



13

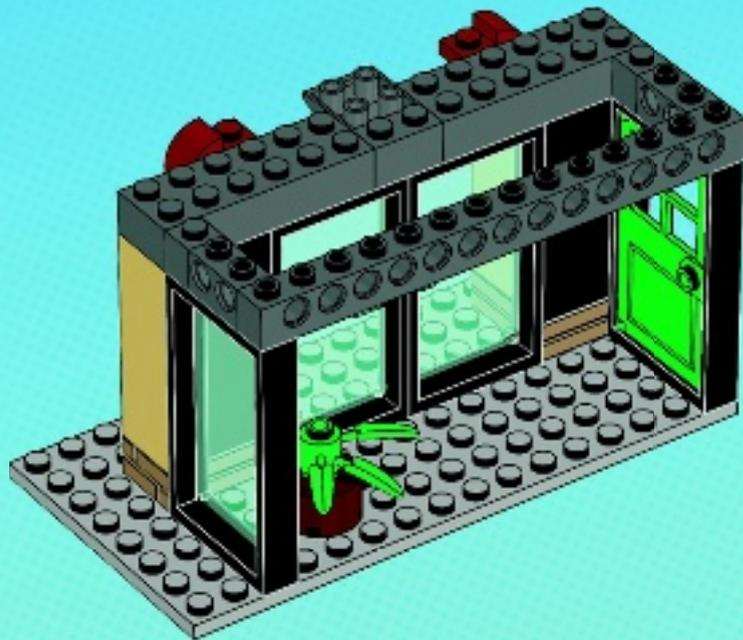

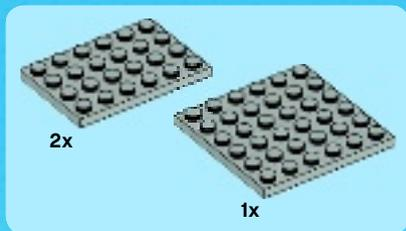

14

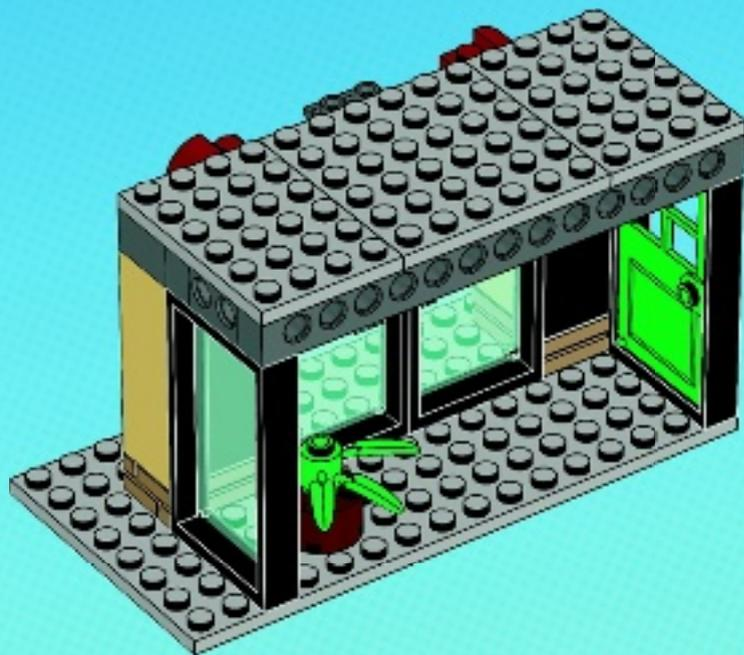



2x

# 15

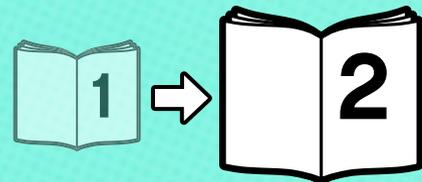
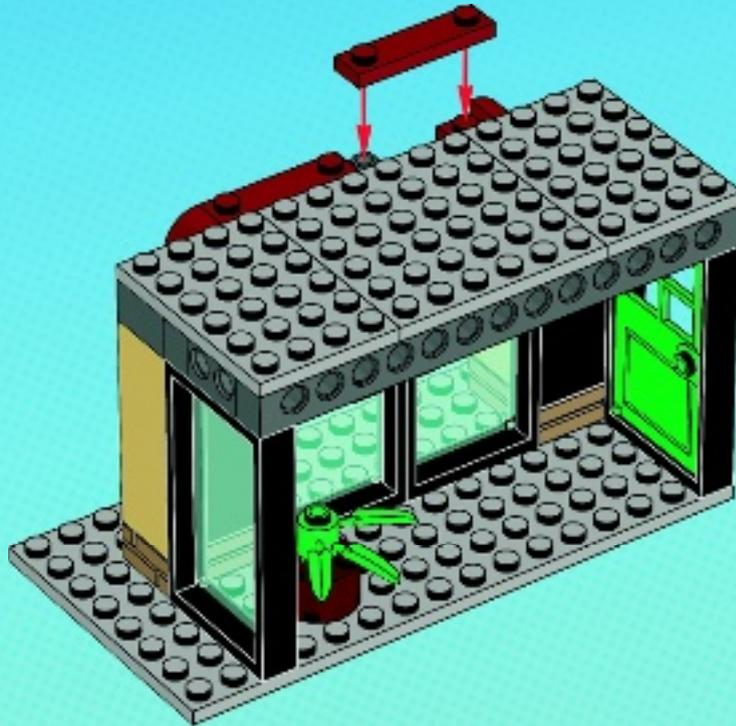



# WIN!

Go to [www.LEGOsurvey.com/product](http://www.LEGOsurvey.com/product) to fill out a survey for a chance to win a cool LEGO® Product.

No purchase necessary.

Open to all residents where not prohibited.



## [www.LEGOsurvey.com/product](http://www.LEGOsurvey.com/product)

### GEWINNE! WIN!

Nimm an der Umfrage auf [www.LEGOsurvey.com/product](http://www.LEGOsurvey.com/product) teil und hab die Chance ein cooles LEGO® Produkt zu gewinnen!

Die Teilnahme am Gewinnspiel führt zu keinerlei Kaufverpflichtungen. Teilnahme in allen nicht ausgeschlossenen Ländern möglich.

Ga naar [www.LEGOsurvey.com/product](http://www.LEGOsurvey.com/product), vul een enquêteformulier in en maak kans op een cool LEGO® product.

Geen aankoopverplichting, iedereen mag deelnemen, uitgezonderd ingezetenden van landen waar een enquêteverbod geldt.

### GAGNE! 当てよう!

Visite [www.LEGOsurvey.com/product](http://www.LEGOsurvey.com/product) pour répondre à un questionnaire et avoir une chance de gagner un produit LEGO® très cool!

Aucune obligation d'achat. Ouvert à tous les résidents des pays autorisés.

[www.LEGOsurvey.com/product](http://www.LEGOsurvey.com/product) にアクセスして、アンケートにご記入ください。当選者にはレゴ®製品を差し上げます。

お買い上げの必要はありません。

禁止されていない限り、すべての皆様にご利用いただけます。



6038418

TM & © 2013 Marvel & Subs.

LEGO and the LEGO logo are trademarks of the LEGO Group. ©2013 The LEGO Group.