



CREATOR

7292



1

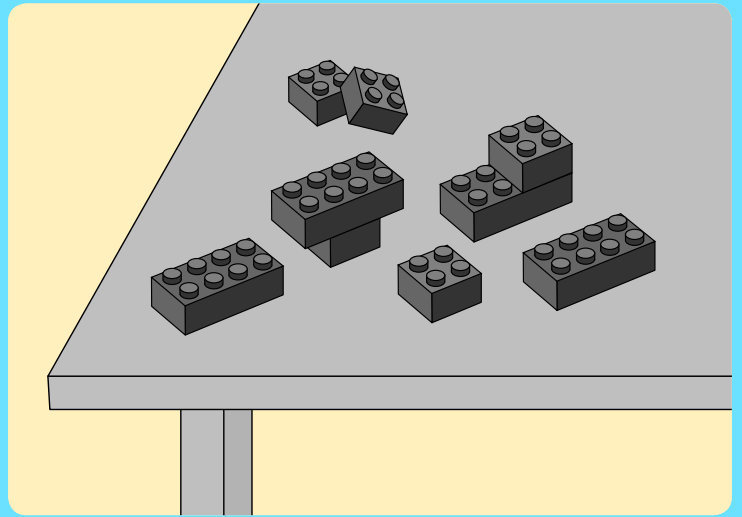
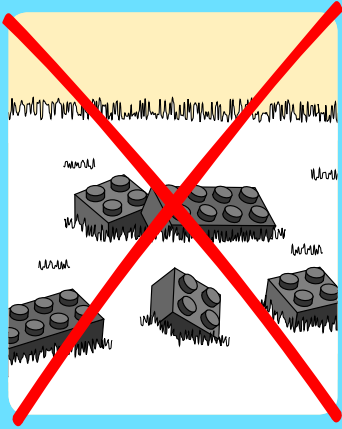

2

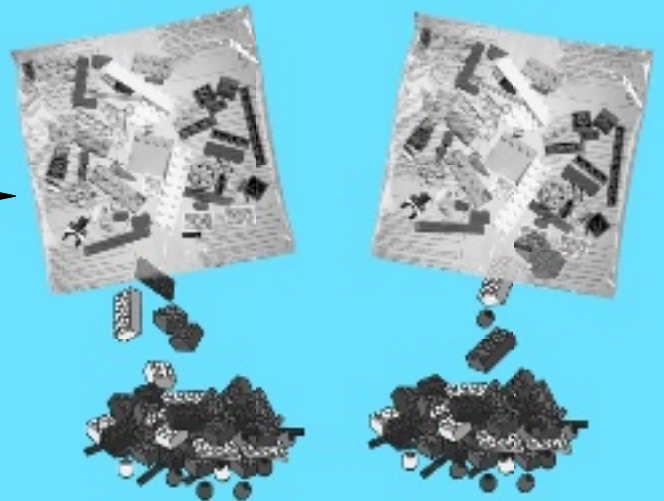

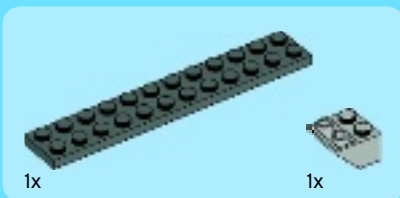

1

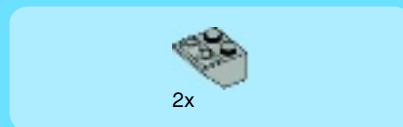
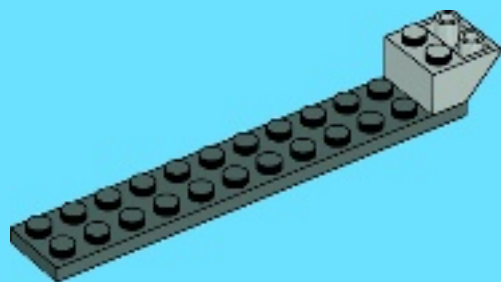

2

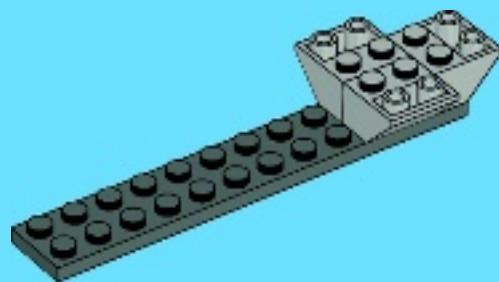



3x

3

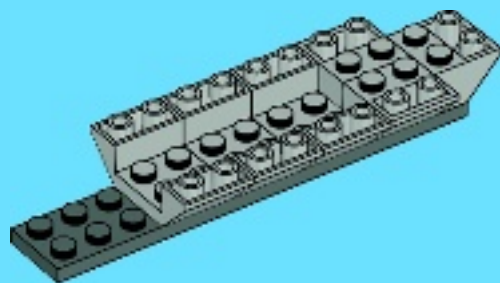

2x

4

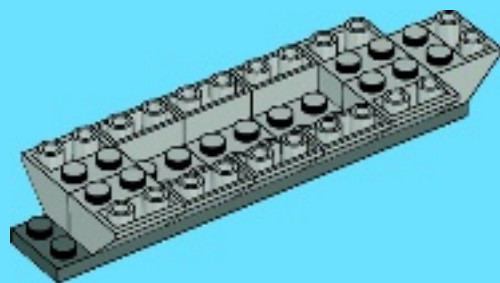

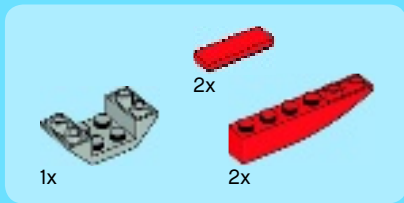

5

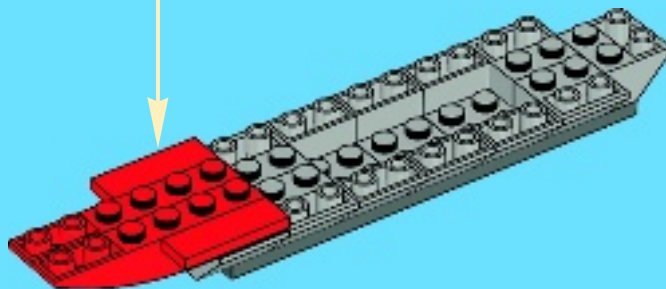
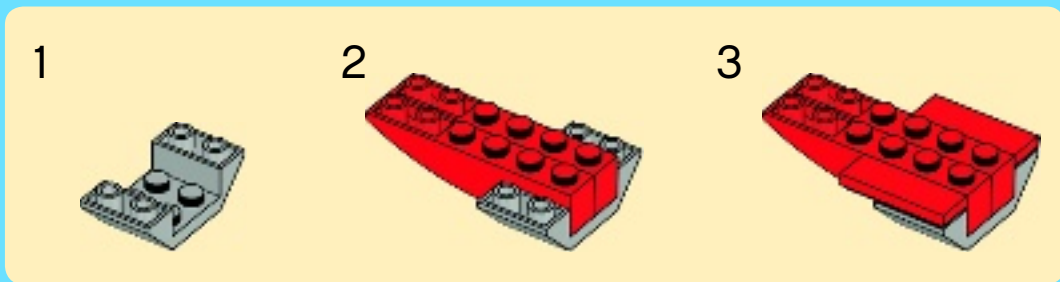

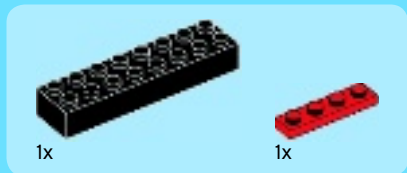

6

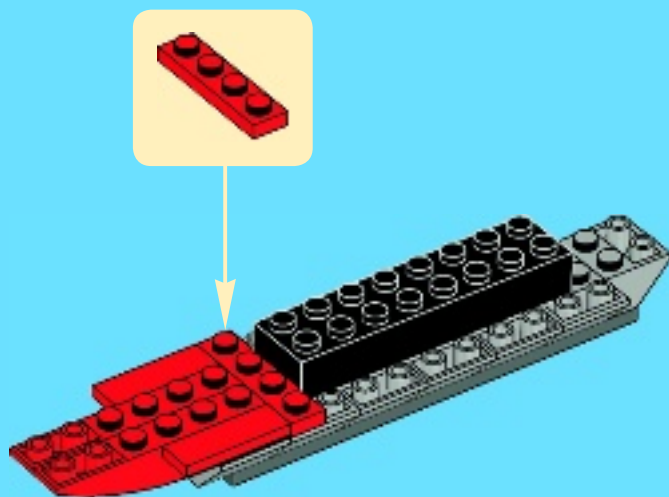

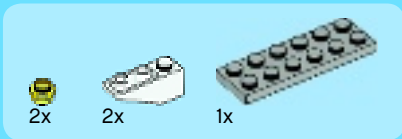

7

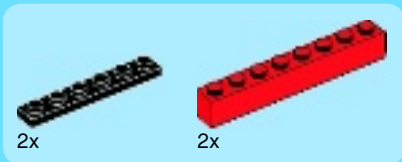
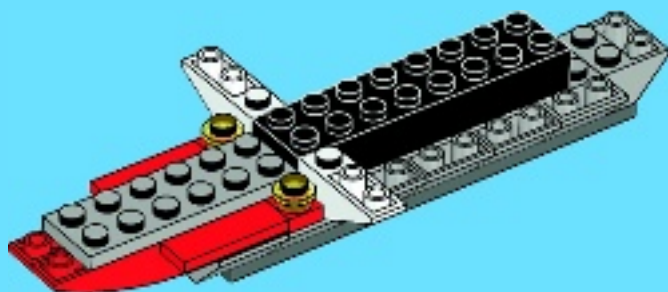

8

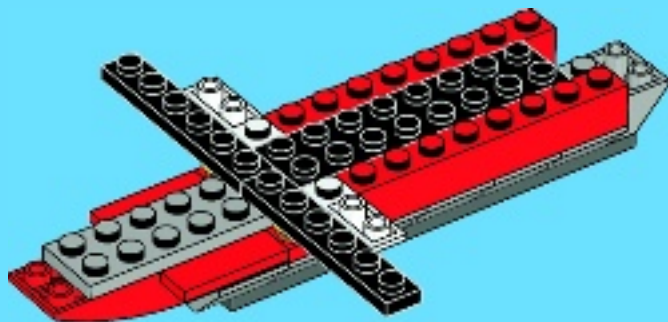

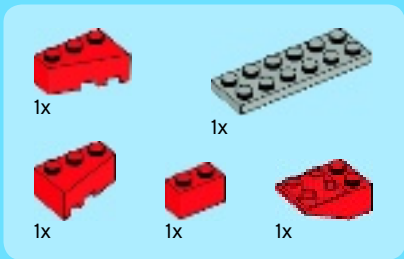

9

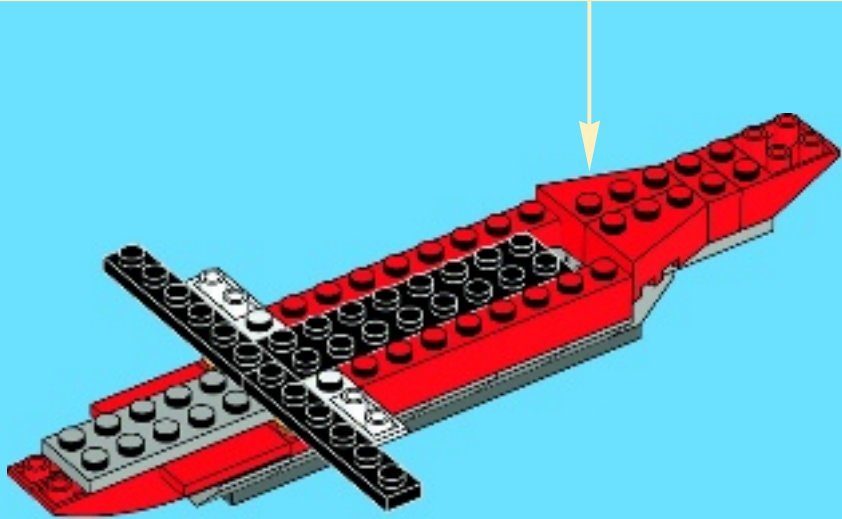
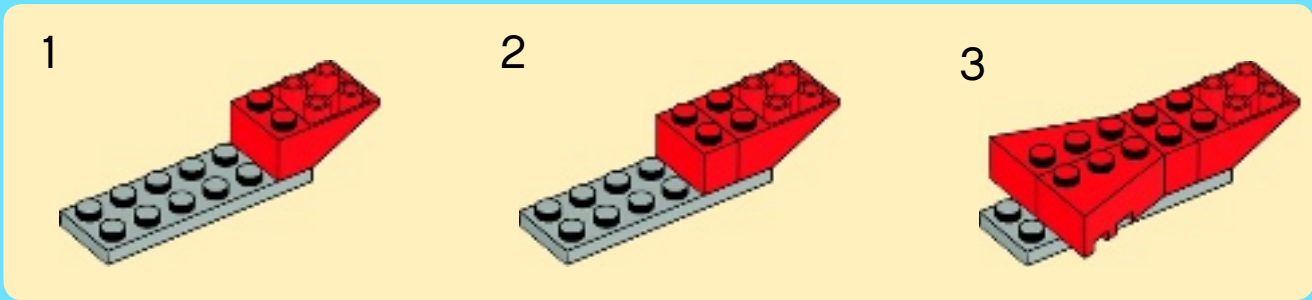

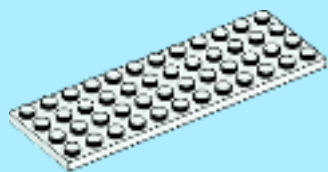

1x

10

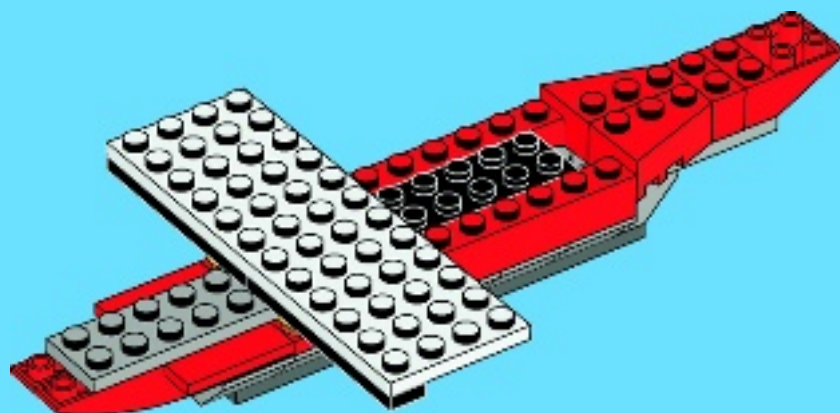

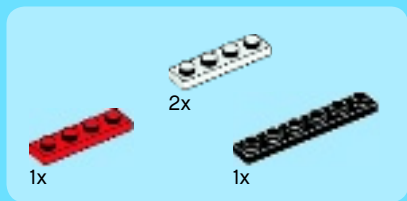

11

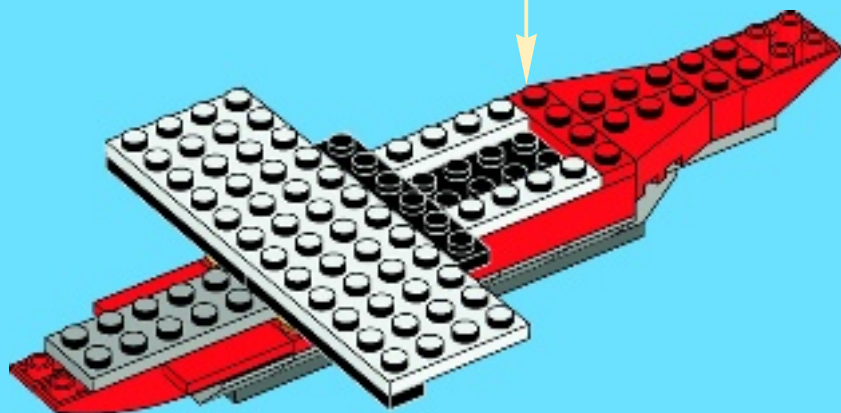



1x



1x

12

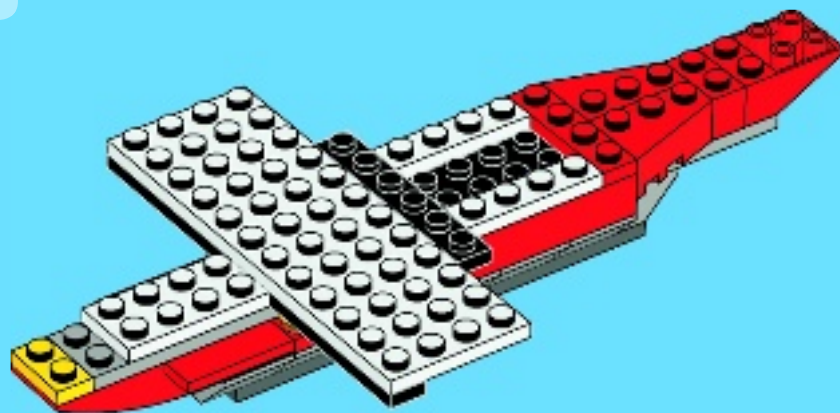

2x



2x

13

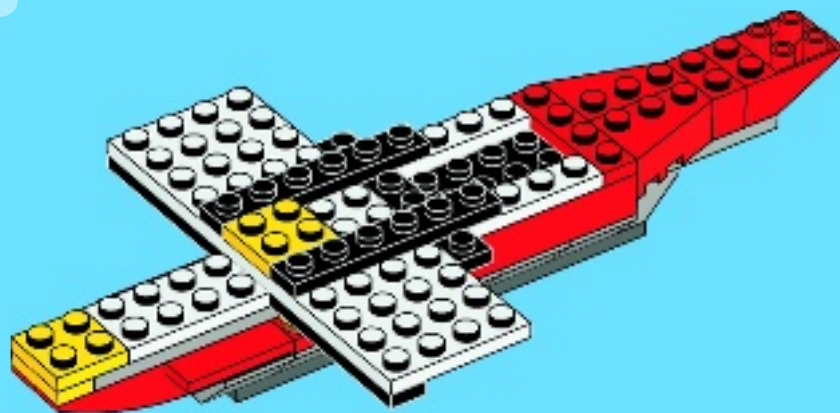



1x



2x

14

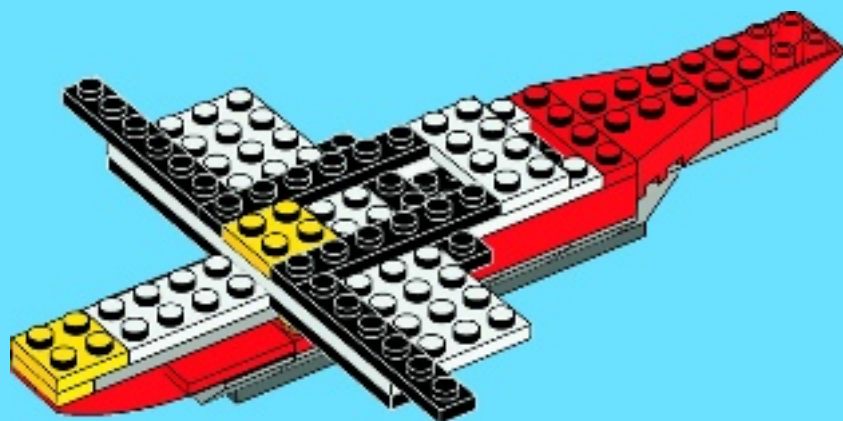



1x



1x



1x

15

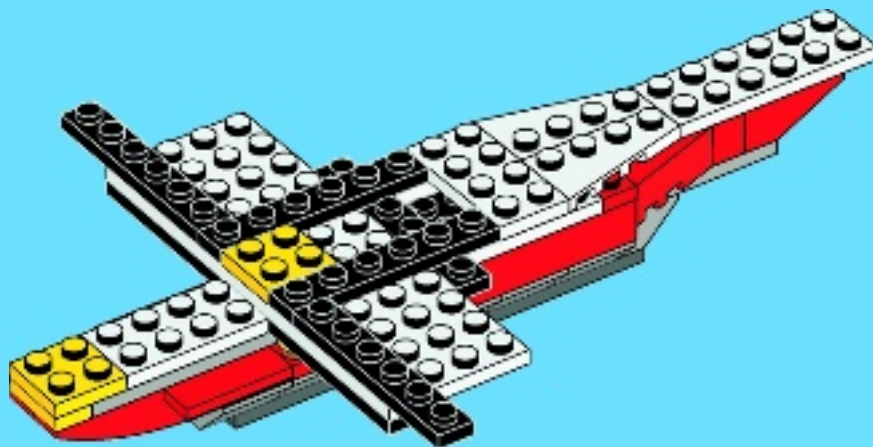



1x



1x

1

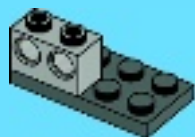

3x

2



1x

4



1x

3





1x



1x

5



1x



4x

6

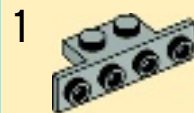



1x



1x

7

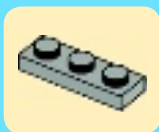

1x



1x



1x

8

1



2

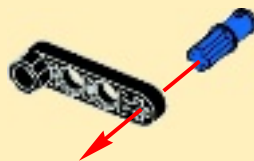

3





1x



1x



1x

9

1



2

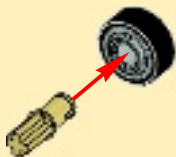

3



1x



1x



1x



1x

10

1

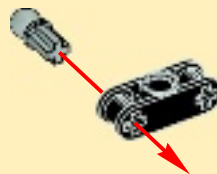

2

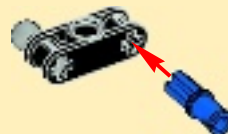

3





1x



2x

11

1

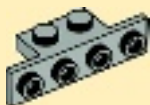

2



2x



1x



1x

12

1

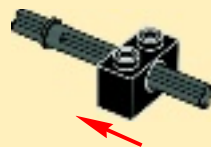

2



3

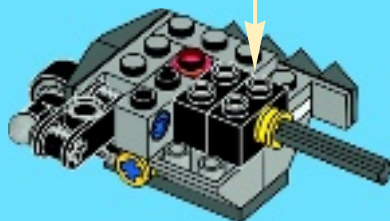
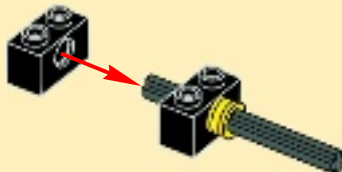



1x

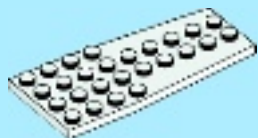

1x

13

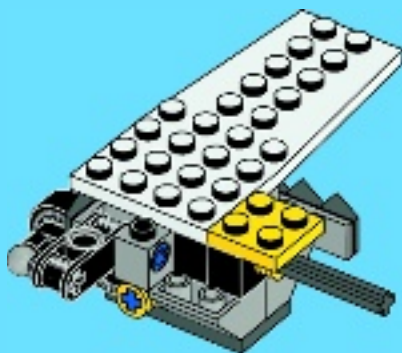

1x



1x

14

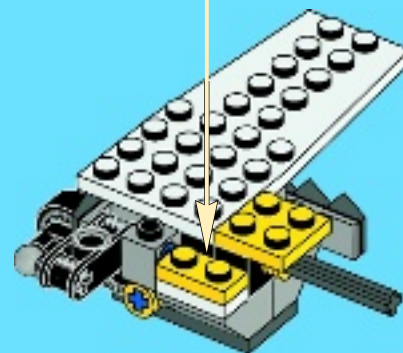
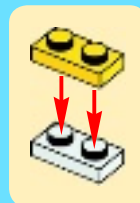



2x

15

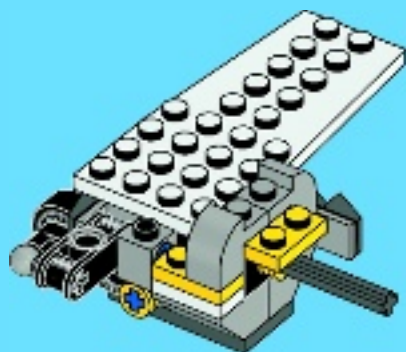

1x

16

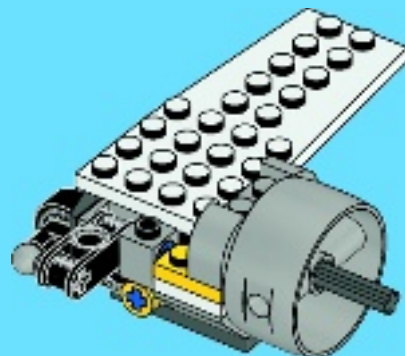



6x



1x

17

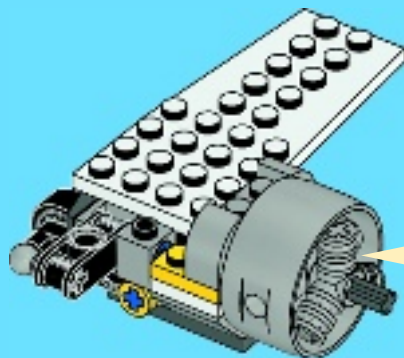
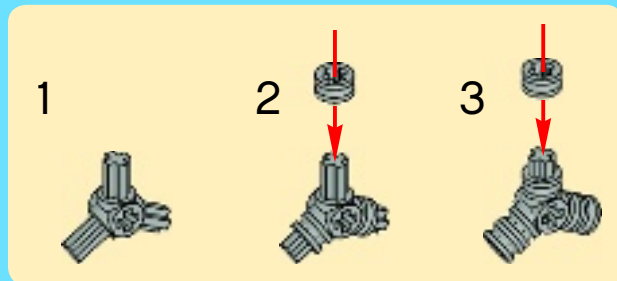



1x



1x

18

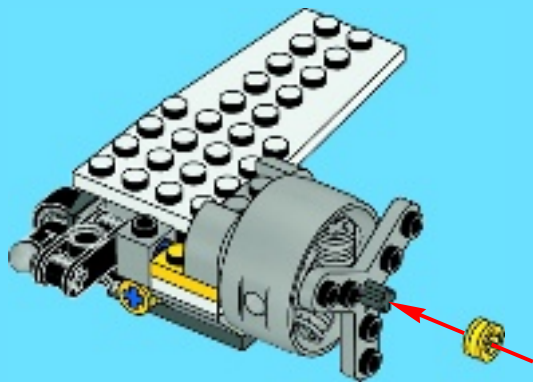

19

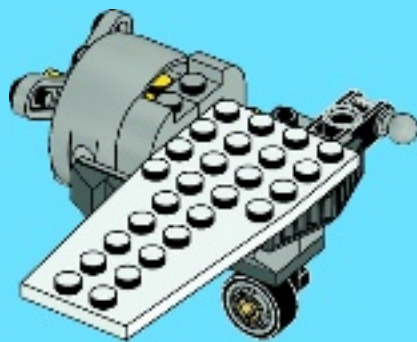

20

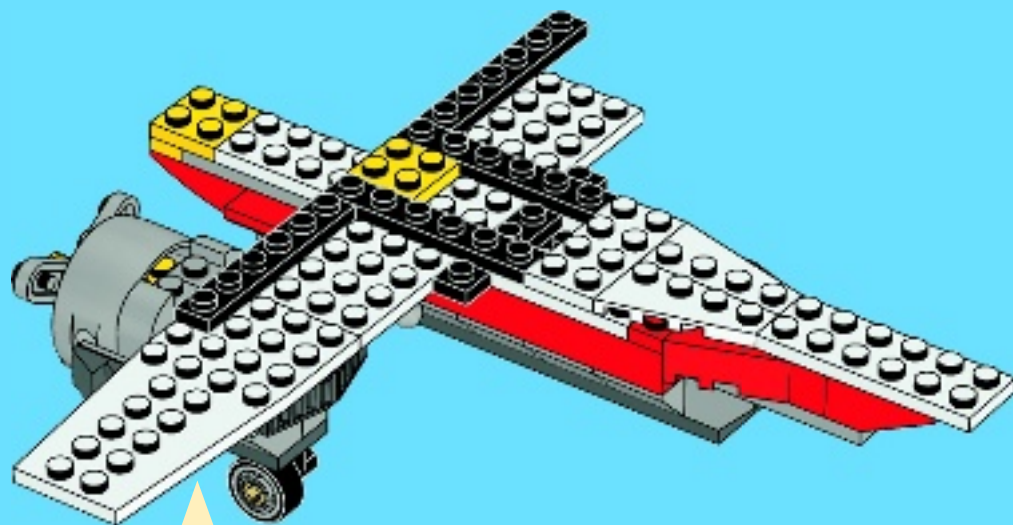

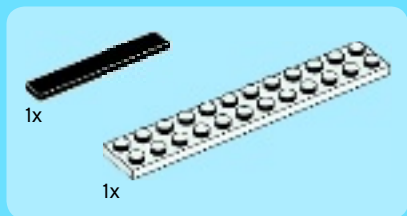

21

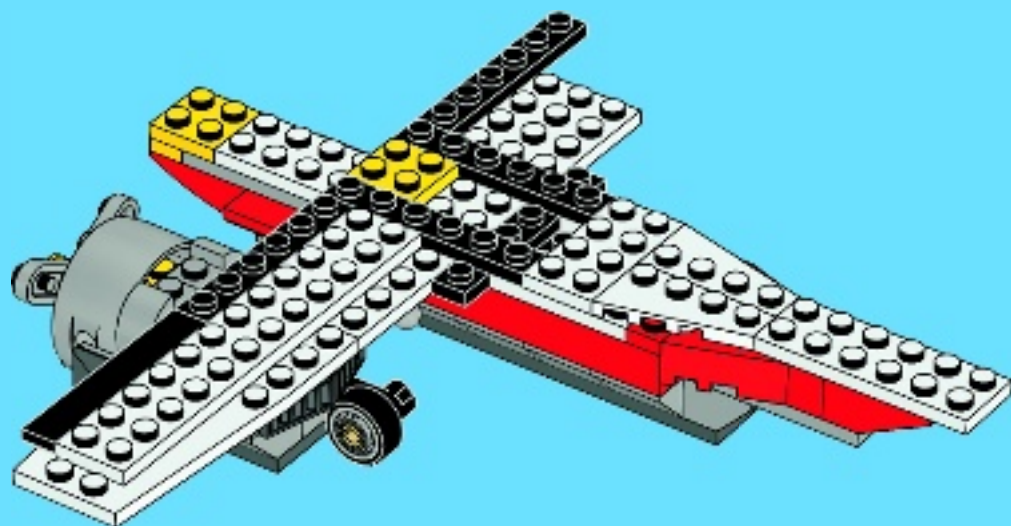

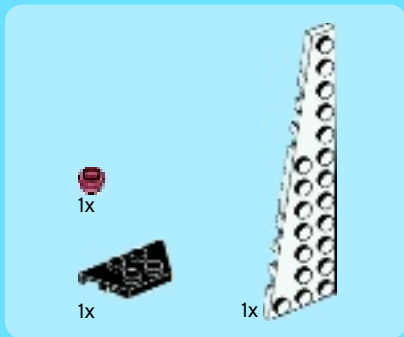

22

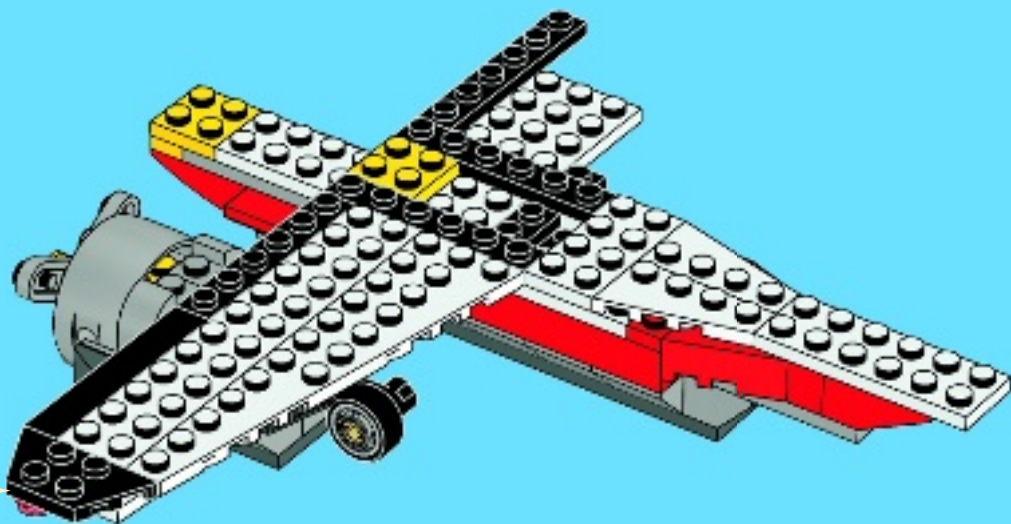
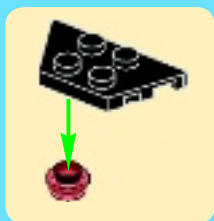



1

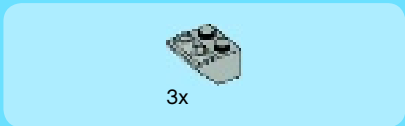
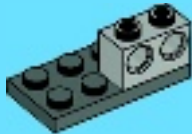

2

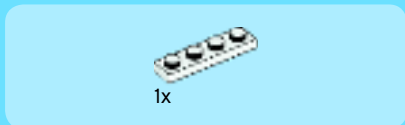

3

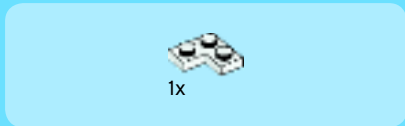

4





1x



1x

5



1x



4x

6

1

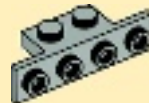

2





1x



1x

7

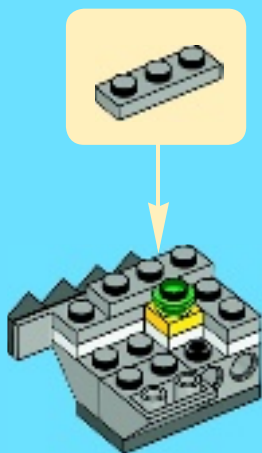

1x



1x



1x

8

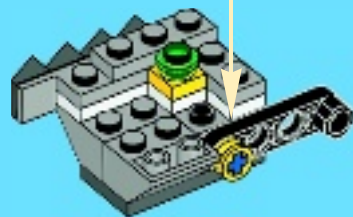
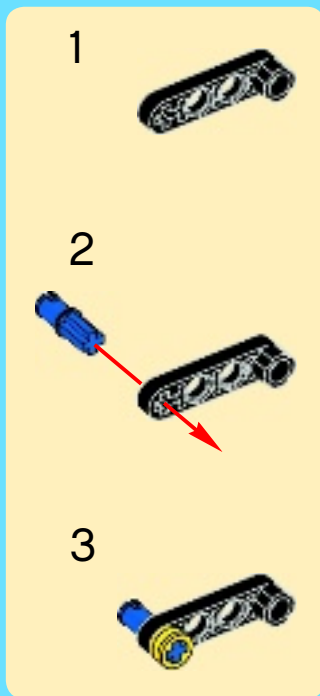



1x



1x



1x

9

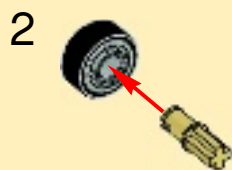
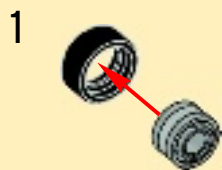

1x



1x



1x



1x

10

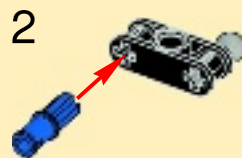



1x



2x

11

1

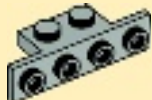

2



2x



1x



1x

12

1

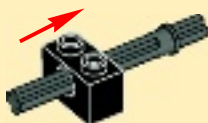

2



3

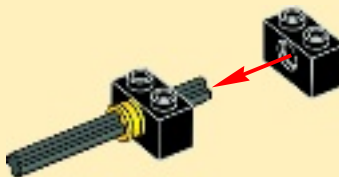

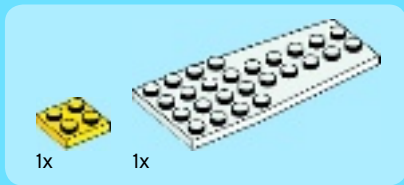

13

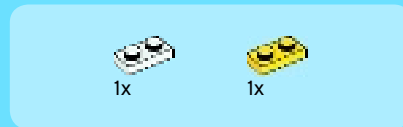
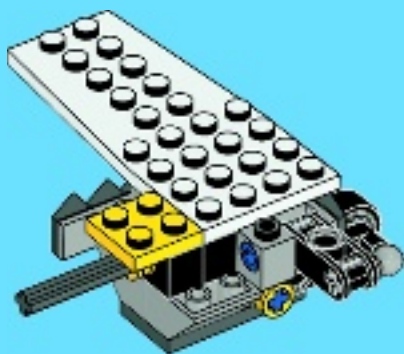

14

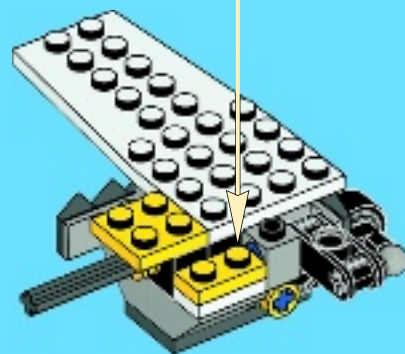
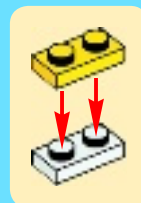



2x

15

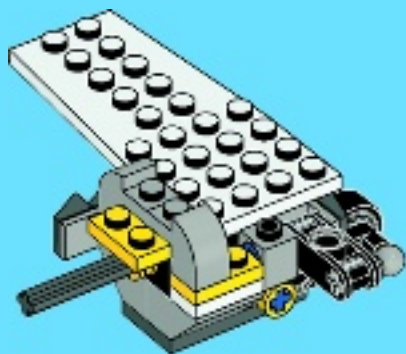

1x

16

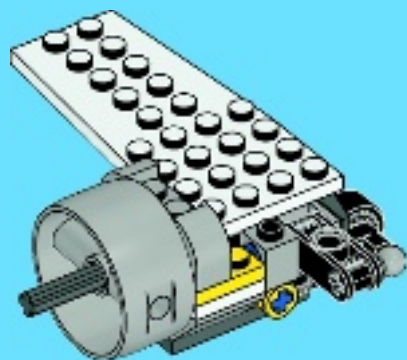



6x



1x

17

1



2

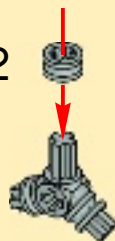

3

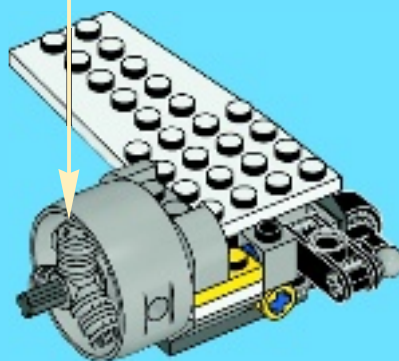
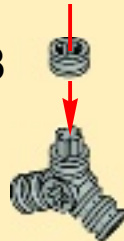



1x



1x

18

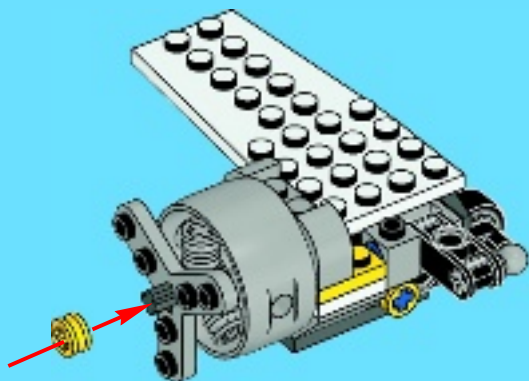

19

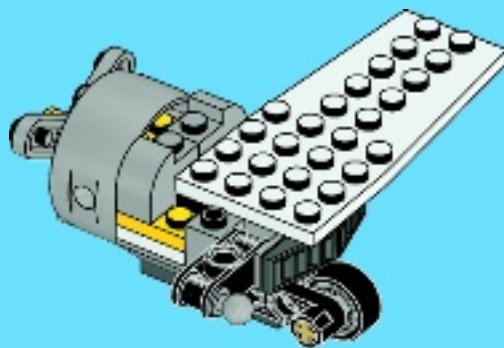

20

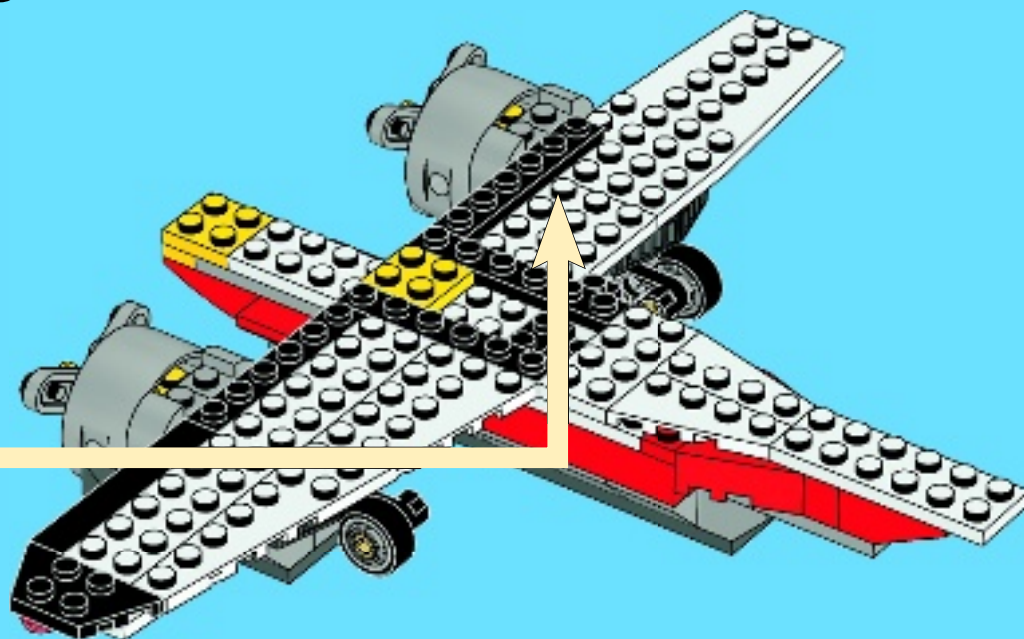

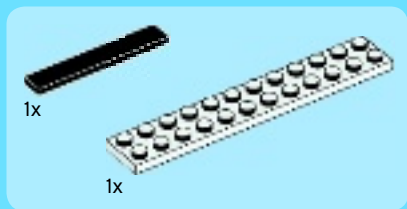

21

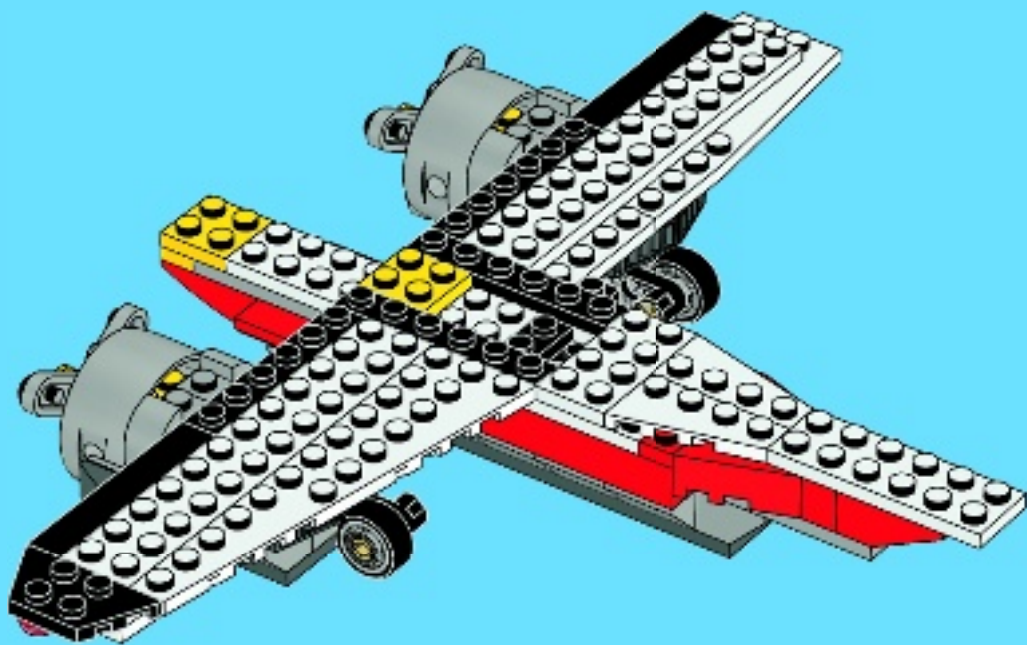

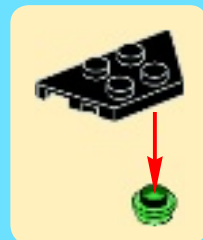
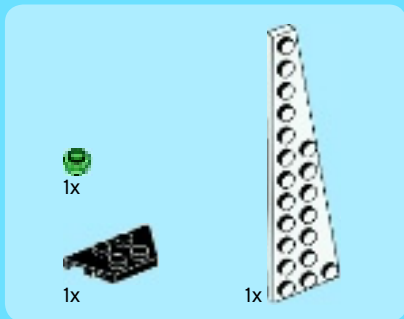

22

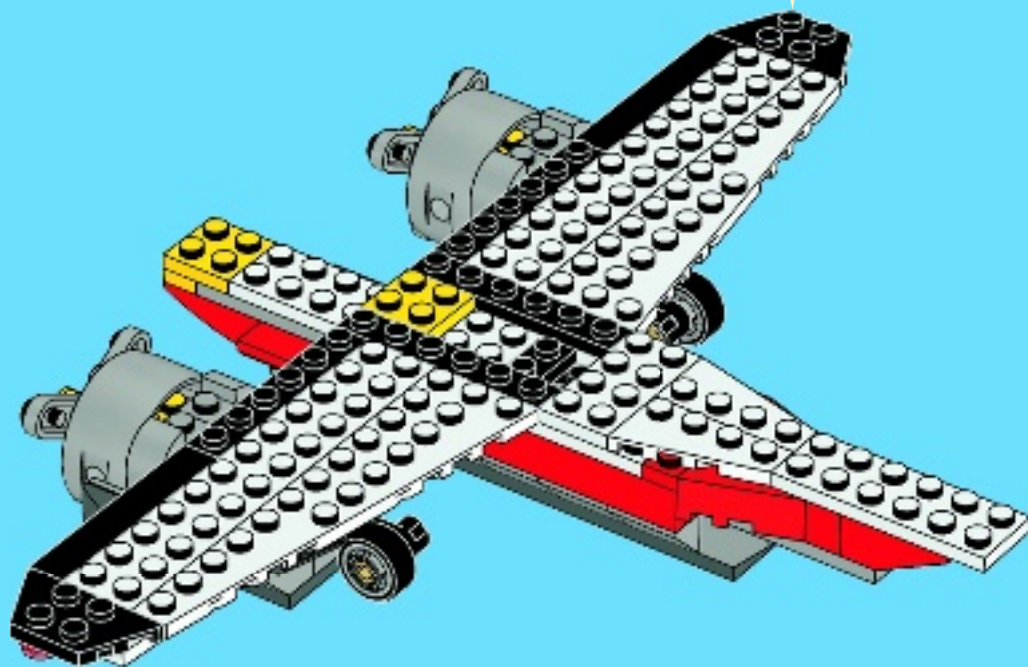



2x



2x



2x

23

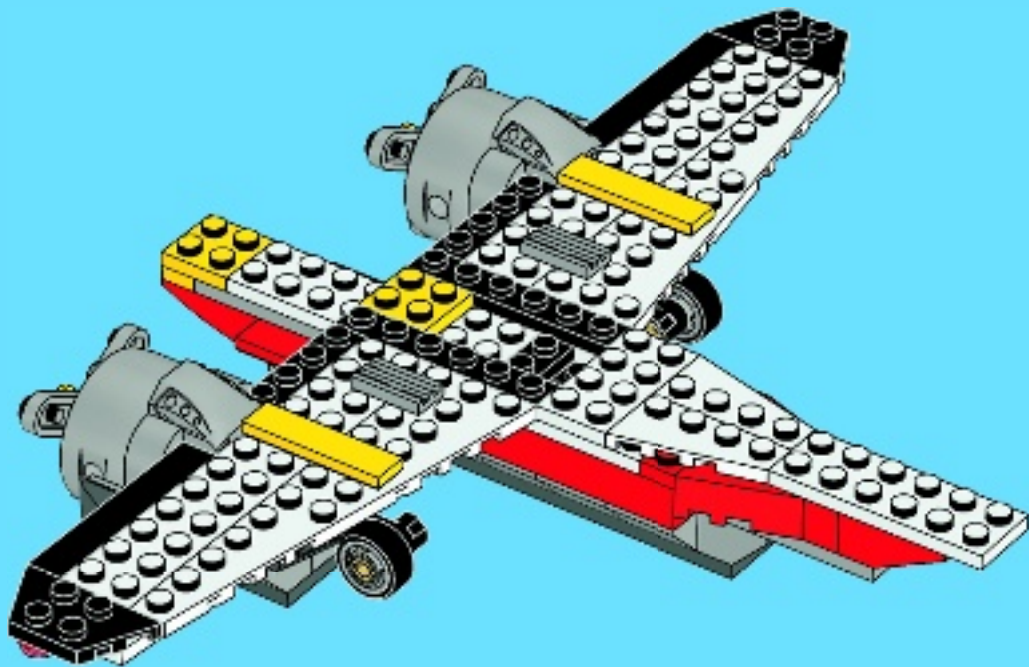



2x



4x

24

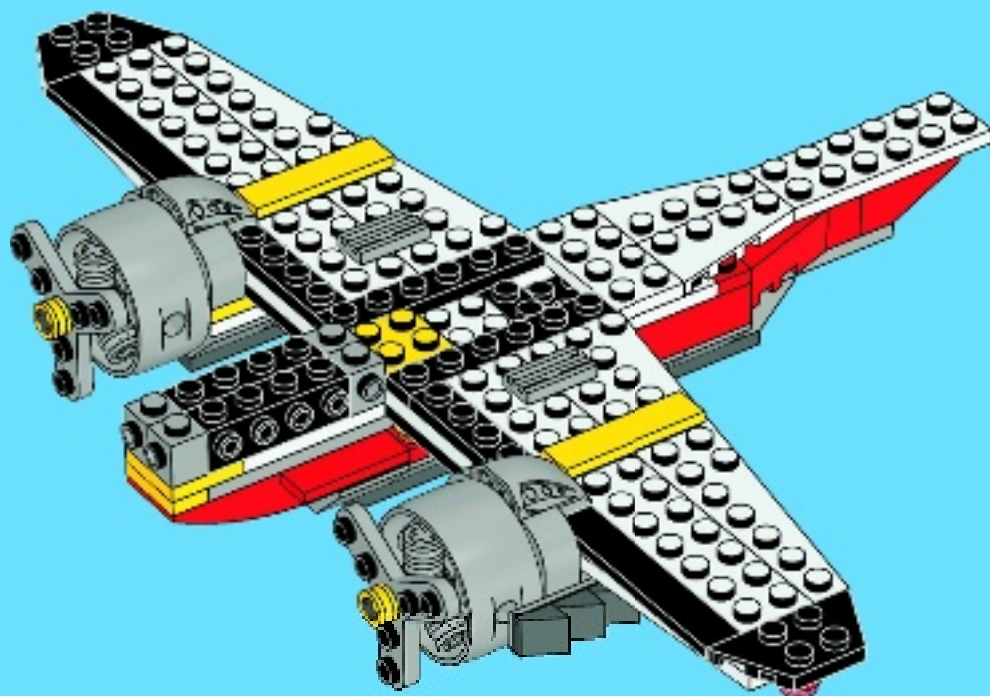



2x



1x

25

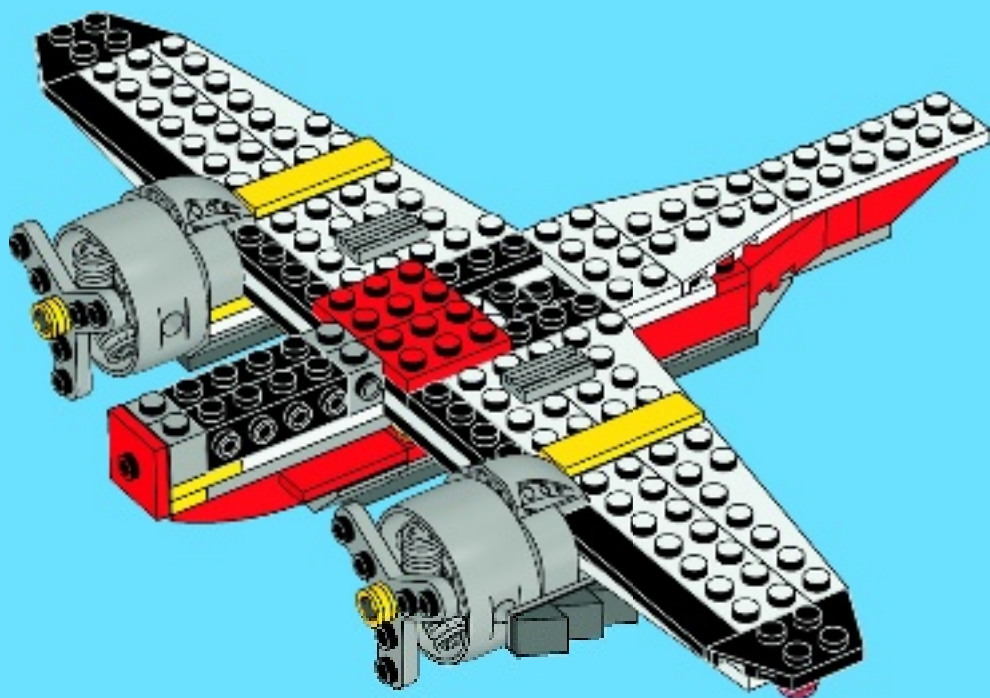



1x



2x

26

1



2

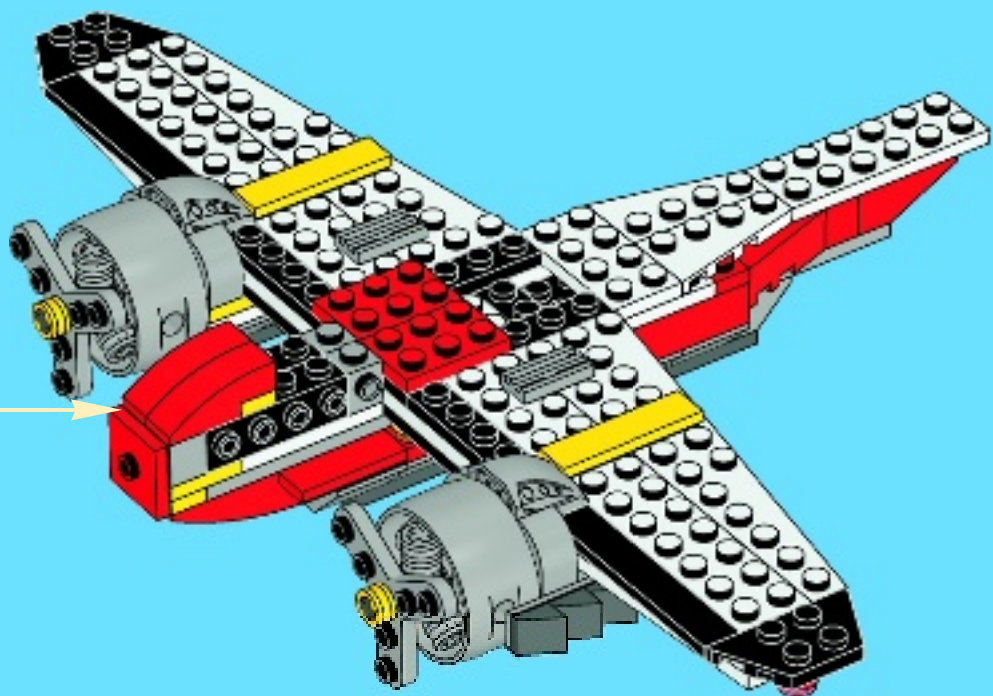

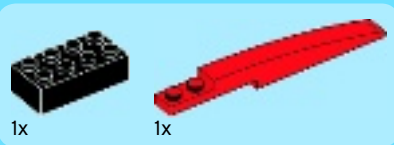

27

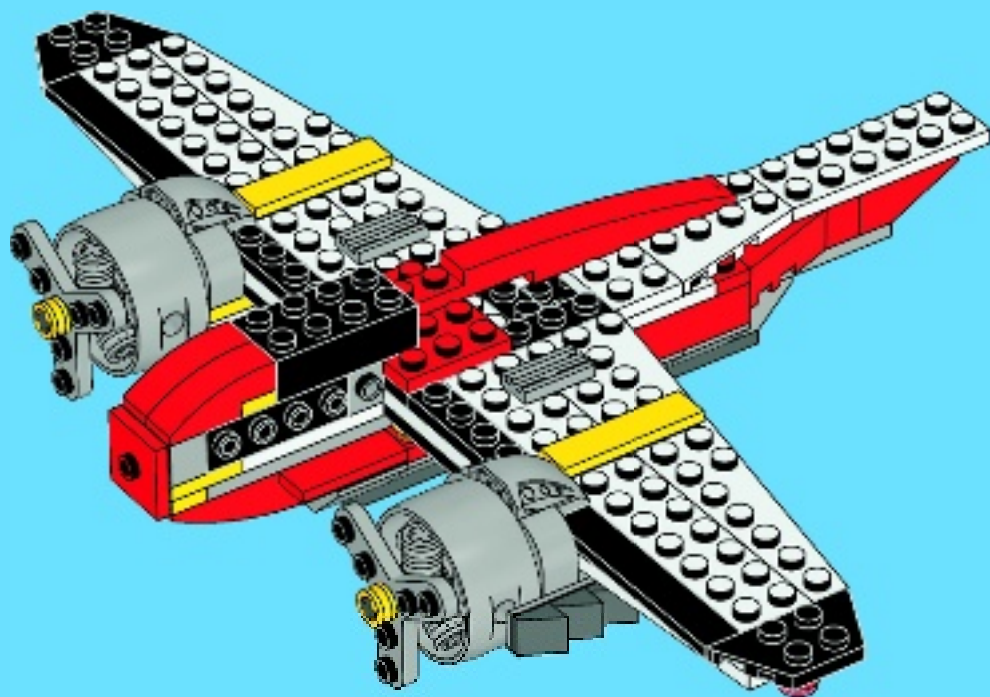



1x

28

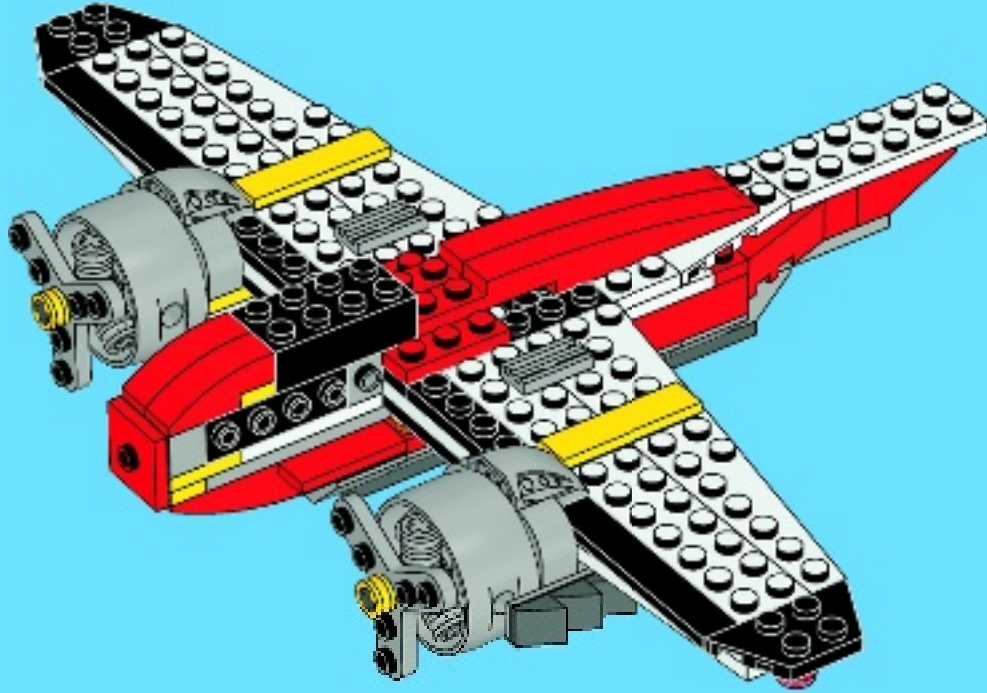



1x



1x



2x

29

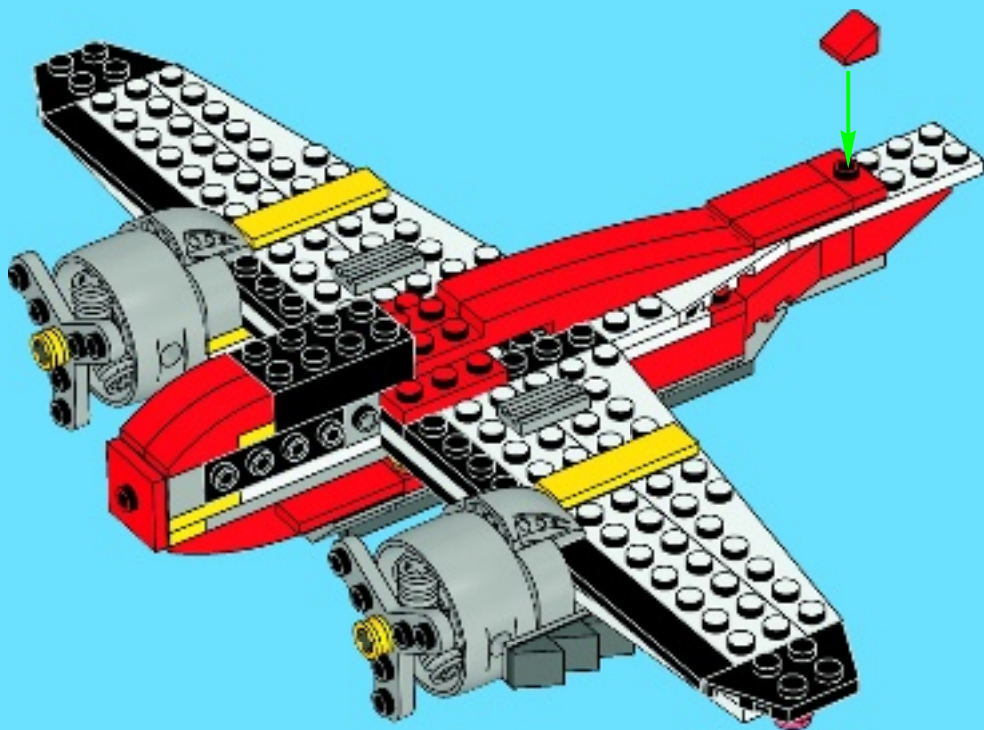



1x



1x

30

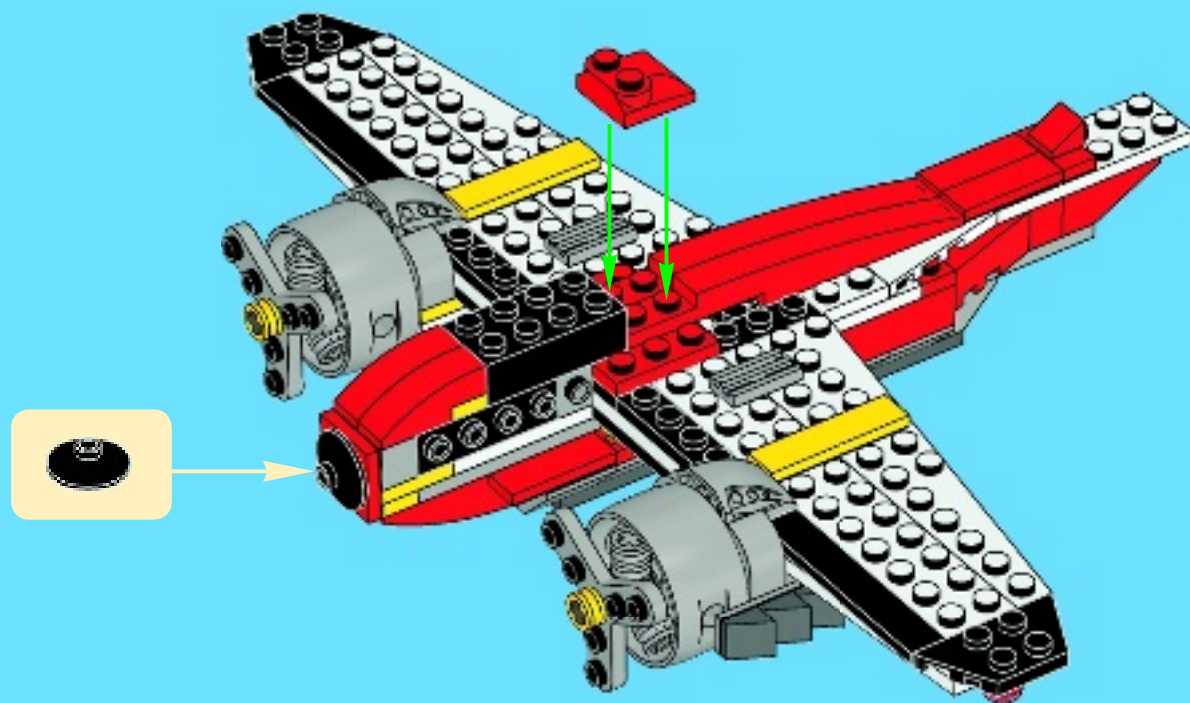

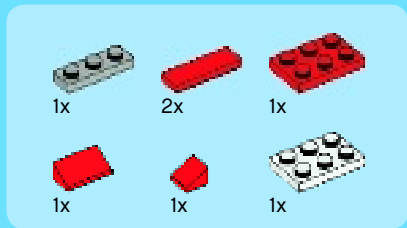

31

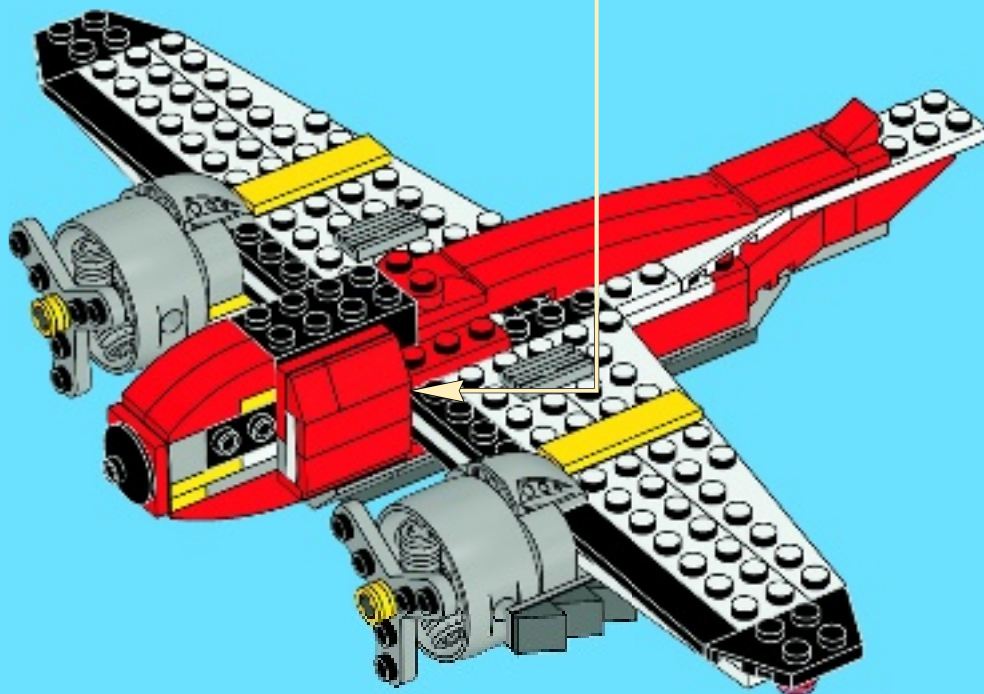
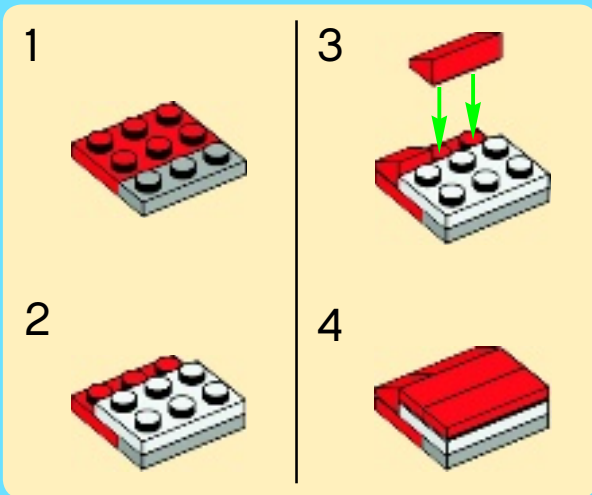

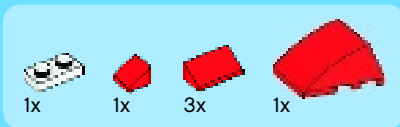

32

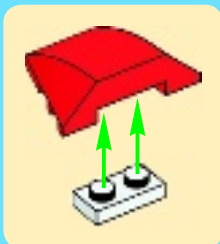
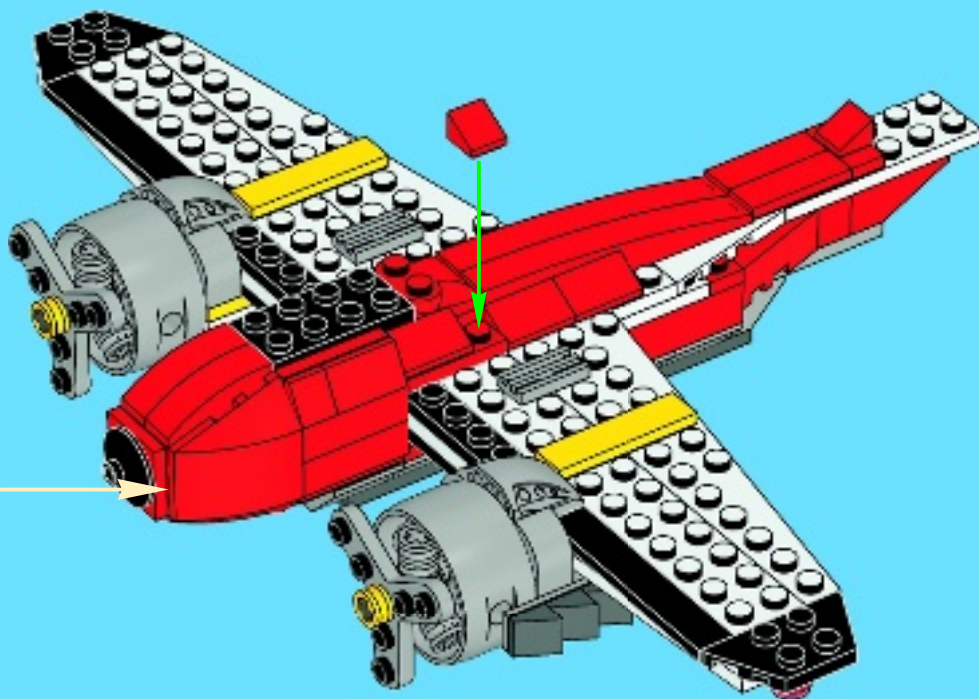



1x



2x



1x



1x



1x



1x

1



2



3

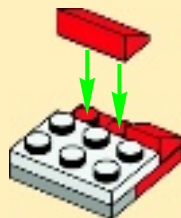

4

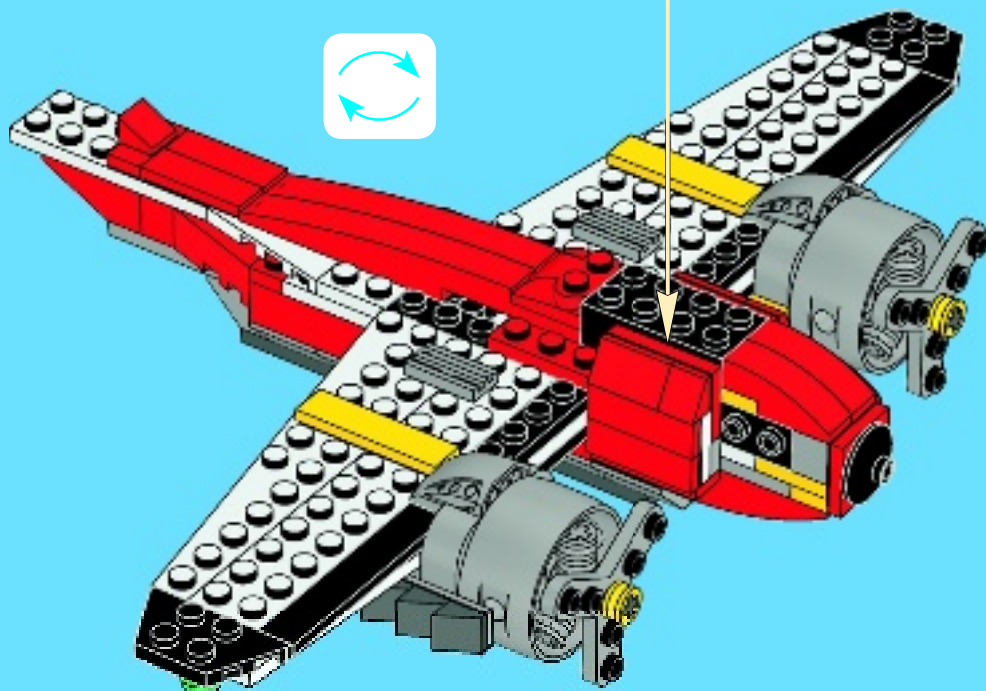

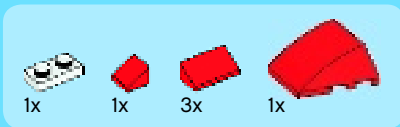

34

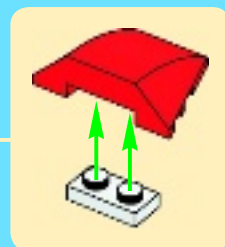
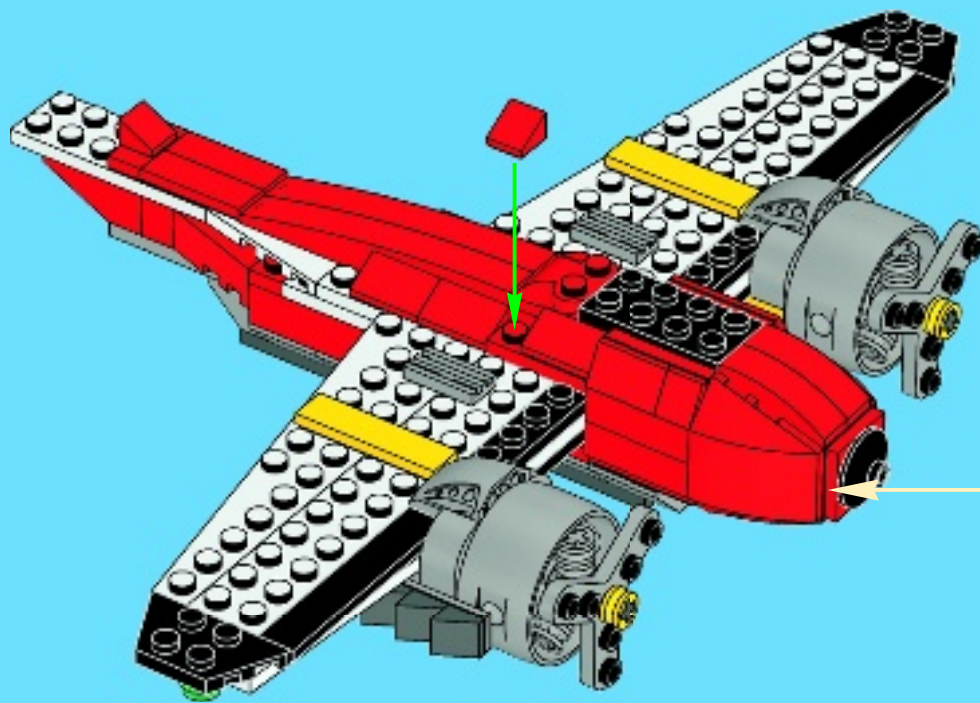



2x

35

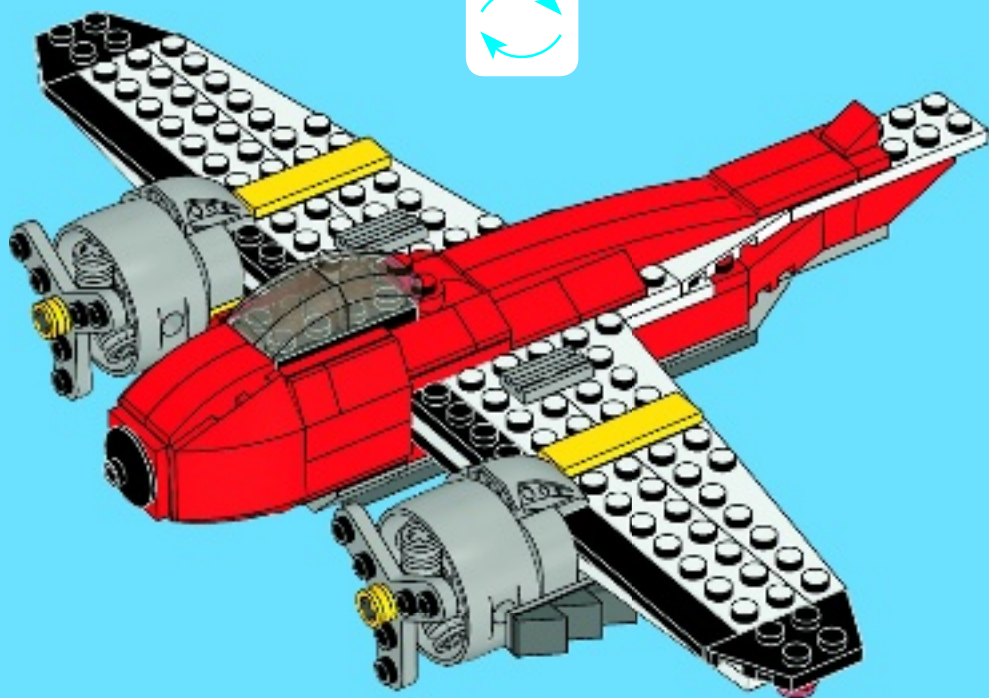



2x

1

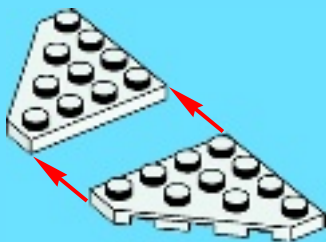

4x

2



1x

3



1x



1x

4





1x



1x

5



1x

6



36

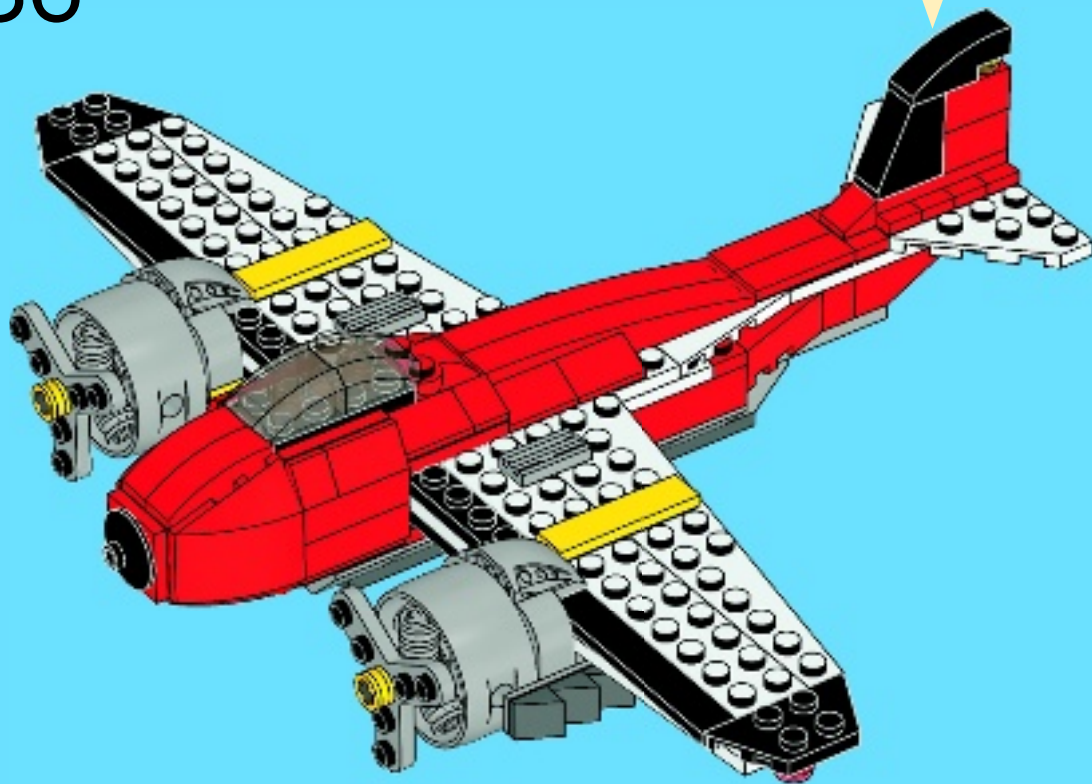



37

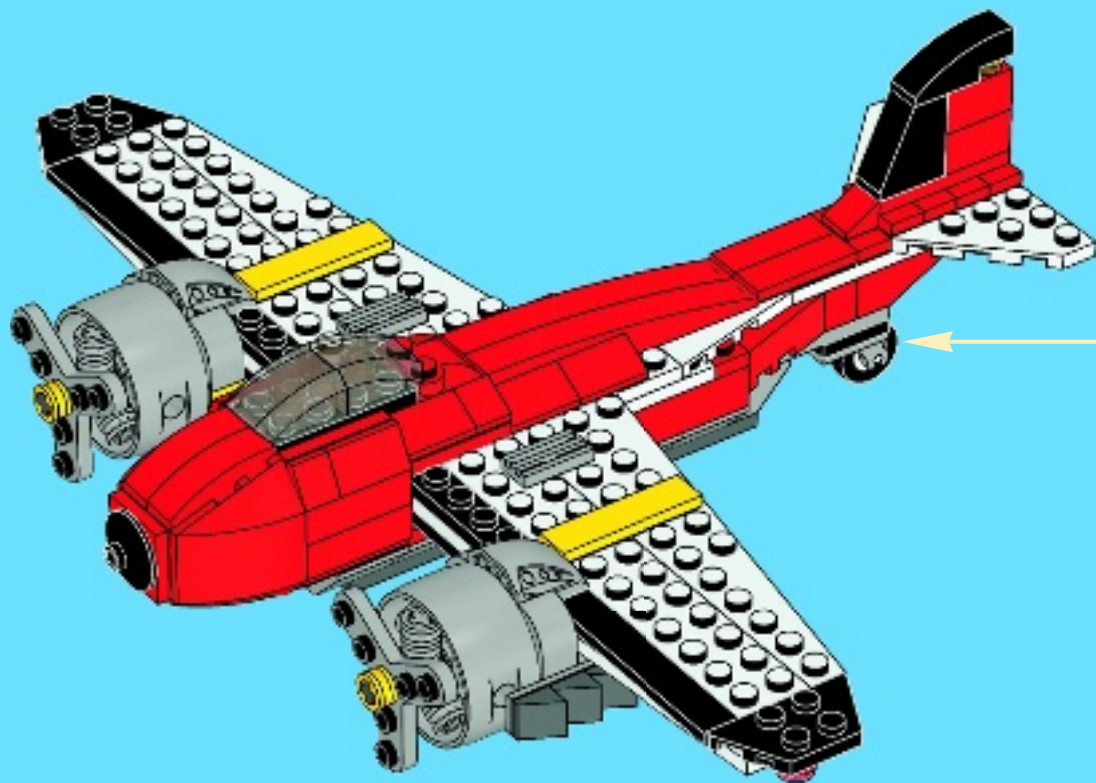
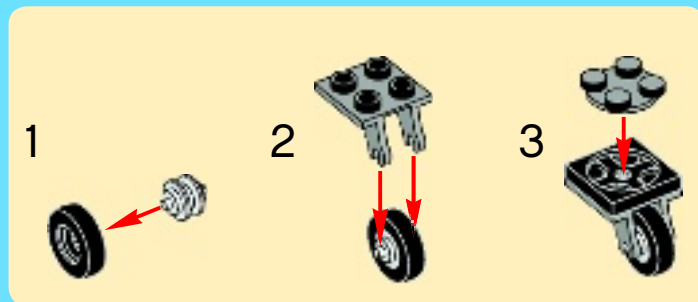

38

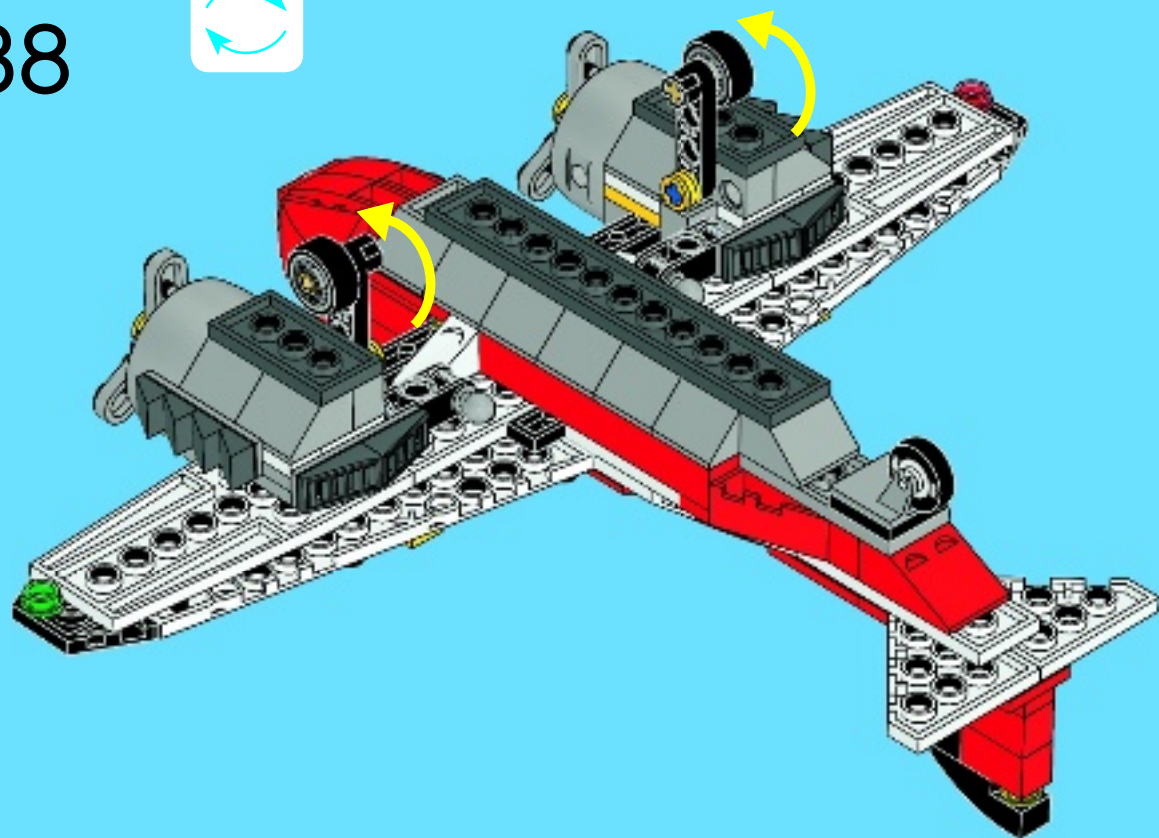

39

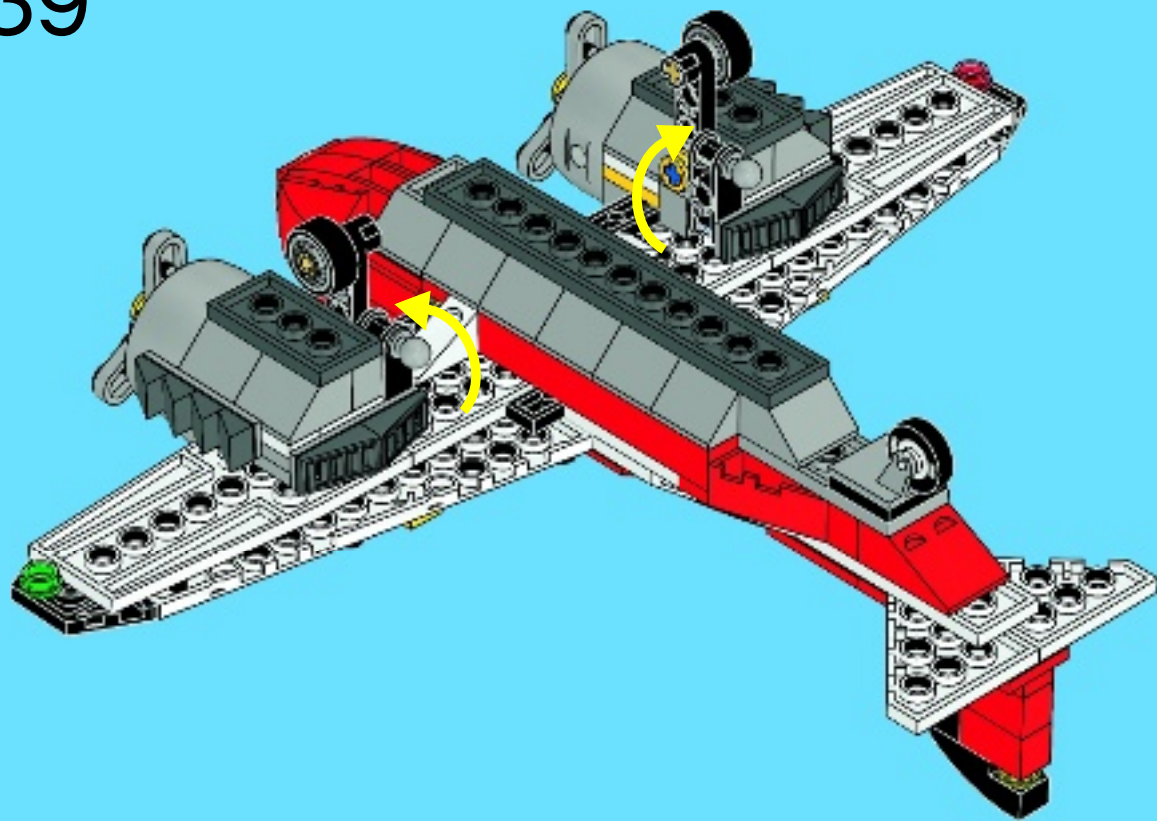



6x



6x

40

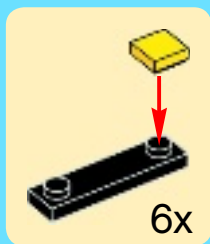

6x

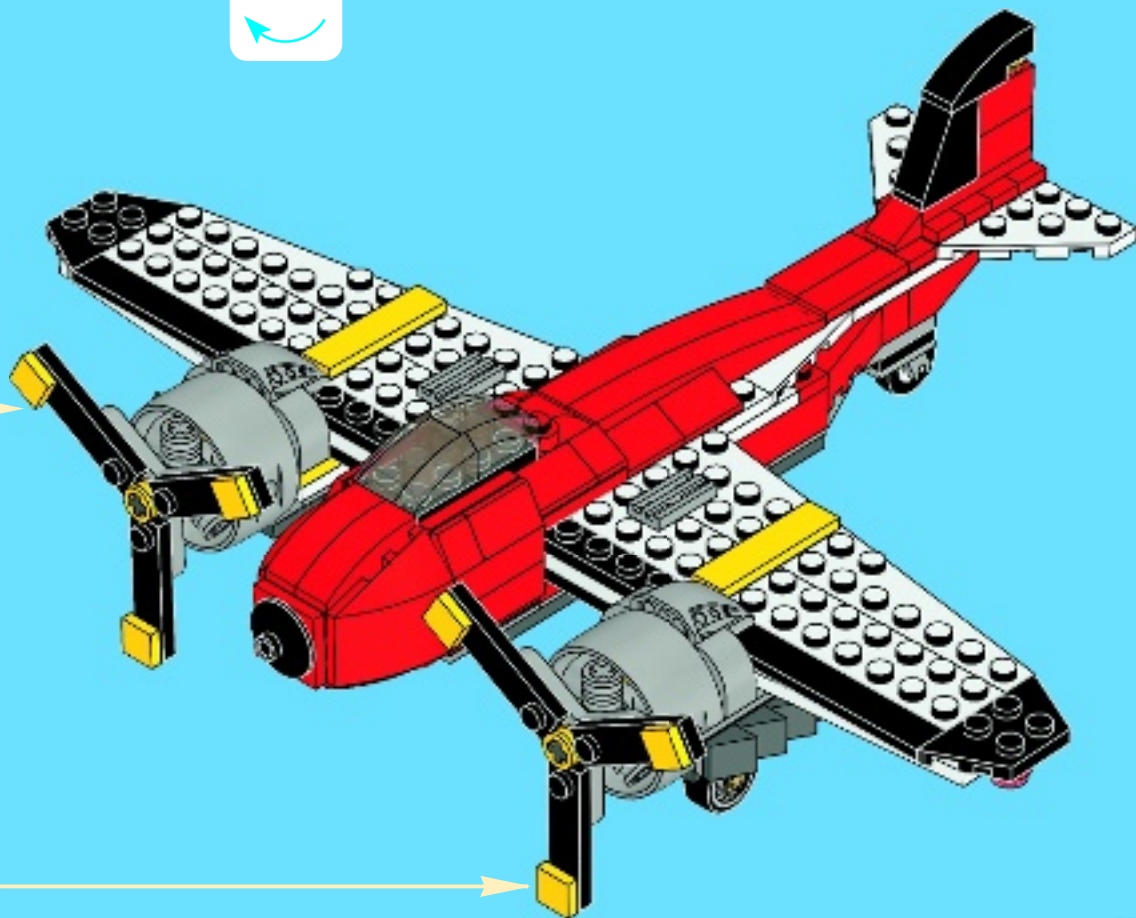

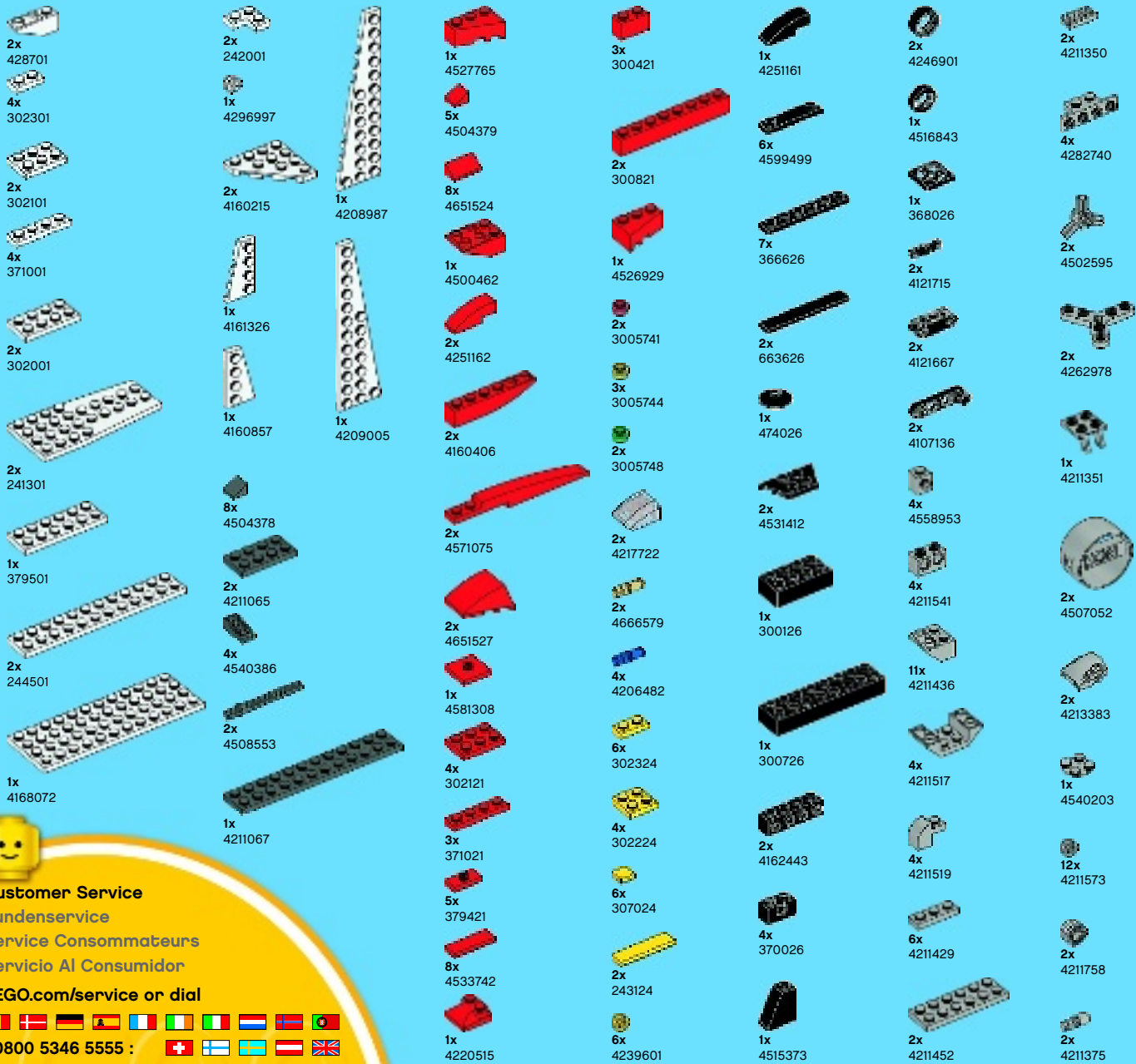

Customer Service

Kundenservice

Service Consommateurs

Servicio Al Consumidor

LEGO.com/service or dial



00800 5346 5555 :



1-800-422-5346 :



3 IN 1 + 1

Join the LEGO® Club and be the first to get access to building instructions for an extra model

Inscris-toi au LEGO® Club et sois le premier à accéder aux instructions de montage pour un modèle supplémentaire

Werde Mitglied im LEGO® Club und erhalte als einer der Ersten eine Bauleitung für ein Extra-Modell!

Únete a LEGO® Club y sé el primero en acceder a las instrucciones de construcción de otro modelo más

Torna-te membro da LEGO® Club e sê o primeiro a ter acesso a instruções de construção para um modelo extra

Csatlakozz a LEGO® Clubhoz és légy te az első, aki hozzáférhet egy extra modell építési utasításaihoz



creator.LEGO.com



WIN!

Go to www.LEGOsurvey.com/product to fill out a survey for a chance to win a cool LEGO® Product. No purchase necessary. Open to all residents where not prohibited.



LEGO.com



www.LEGOsurvey.com/product

GEWINNE! WIN!

Nimm an der Umfrage auf www.LEGOsurvey.com/product teil und hab die Chance ein cooles LEGO® Produkt zu gewinnen!

Die Teilnahme am Gewinnspiel führt zu keinerlei Kaufverpflichtungen. Teilnahme in allen nicht ausgeschlossenen Ländern möglich.

Ga naar www.LEGOsurvey.com/product, vul een enquêteformulier in en maak kans op een cool LEGO® product.

Geen aankoopverplichting. Iedereen mag deelnemen, uitgezonderd ingezetenden van landen waar een enquêteverbod geldt.

GAGNE! 当てよう!

Visite www.LEGOsurvey.com/product pour répondre à un questionnaire et avoir une chance de gagner un produit LEGO® très cool!

Aucune obligation d'achat. Ouvert à tous les résidents des pays autorisés.

www.LEGOsurvey.com/product にアクセスして、アンケートにご記入ください。当選者にはレゴ製品を差し上げます。

お買い上げの必要はありません。

禁止されていない限り、すべての皆様にご利用いただけます。