



ULTIMATE COLLECTOR SERIES

TIE INTERCEPTOR

STAR
WARS

7 1 8 1

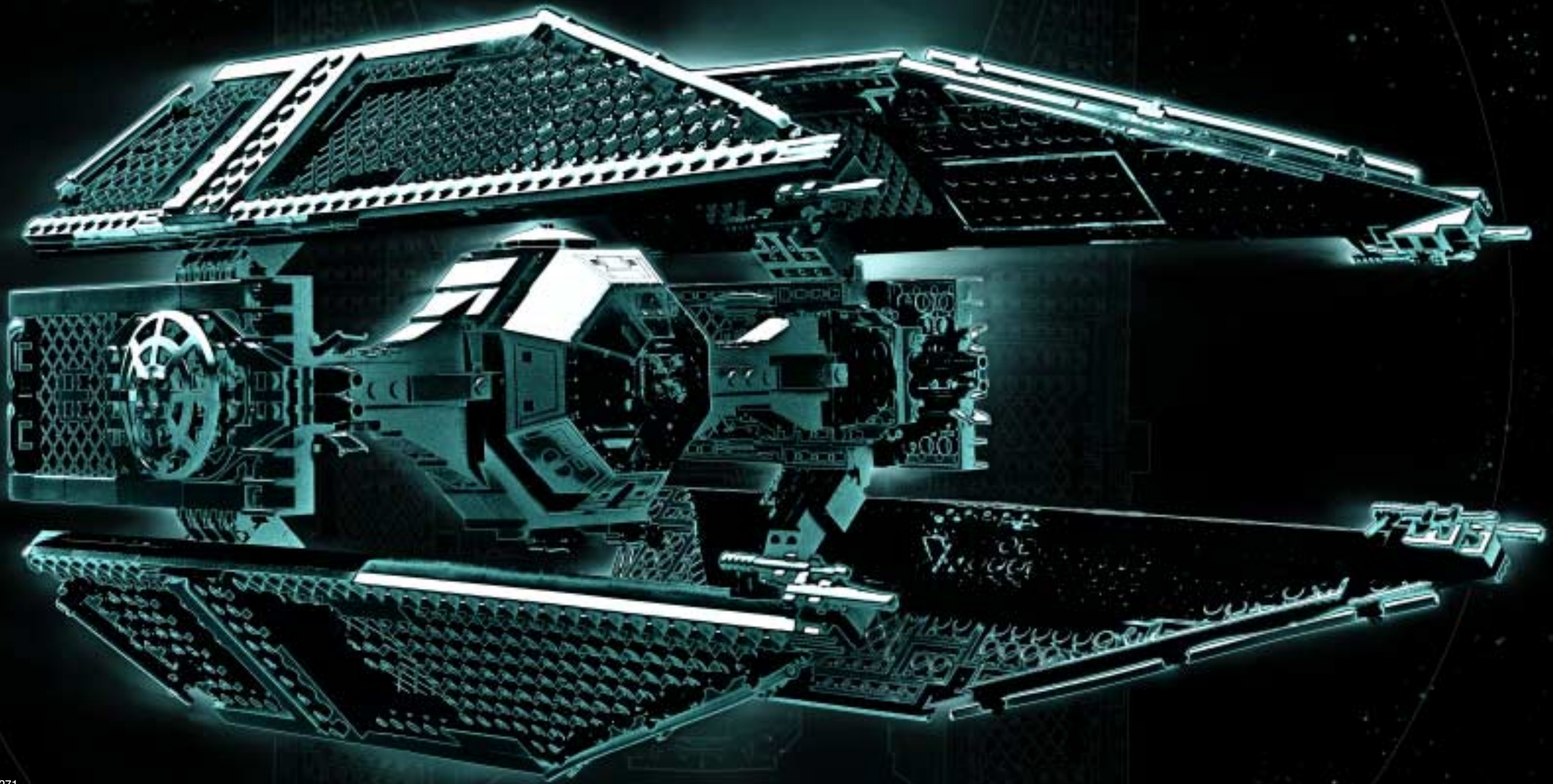



COCKPIT - PAGES 4-15

CENTER WING - PAGES 16-21

LOWER WING - PAGES 22-28

UPPER WING - PAGES 29-36

PEDESTAL - PAGES 37-45

INFO - PAGES 46-47

LOWER WING - PAGES 22-28

CENTER WING - PAGES 16-21

UPPER WING - PAGES 29-36

COCKPIT - PAGES 4-15

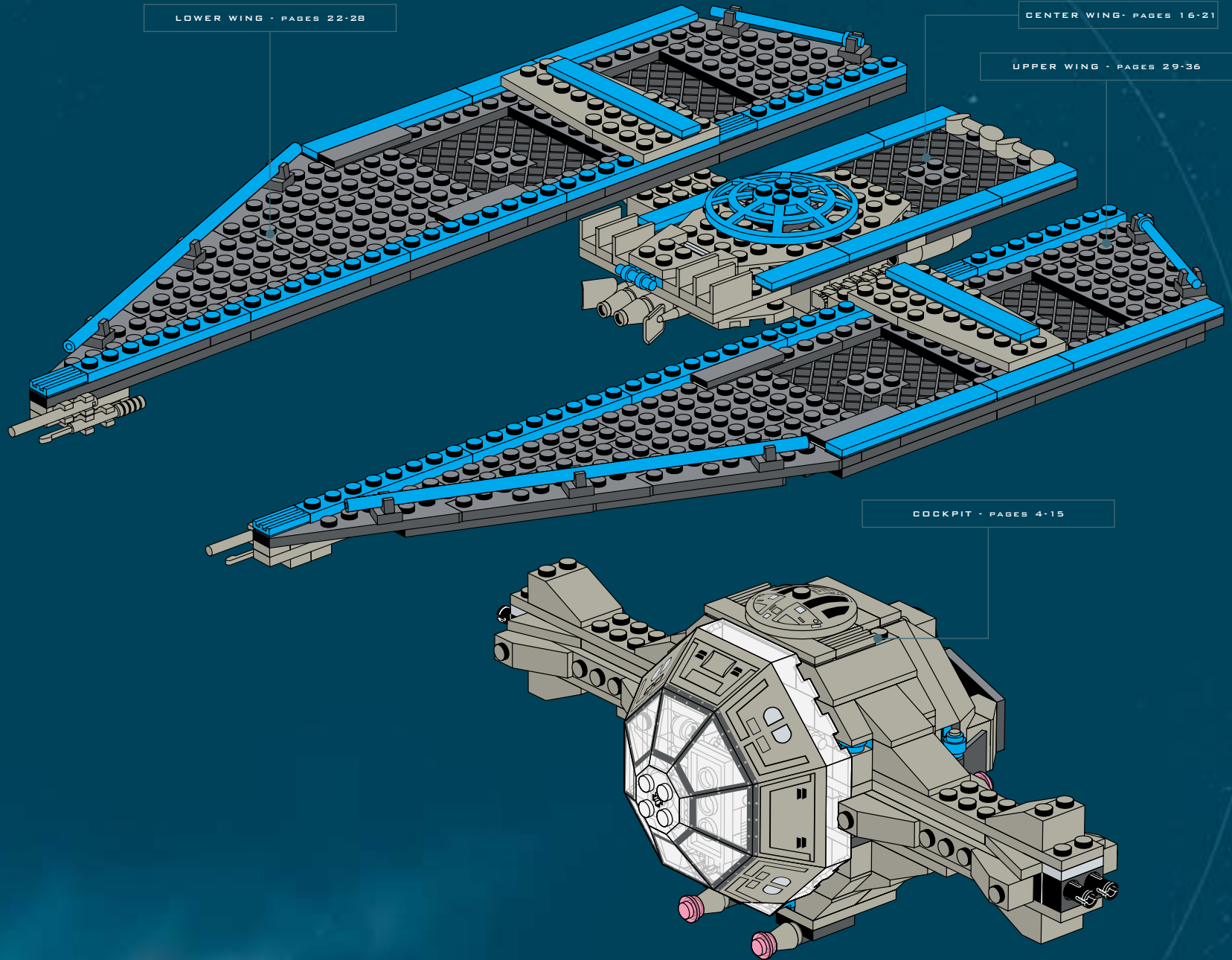

LOWER WING - PAGES 22-28

CENTER WING - PAGES 16-21

UPPER WING - PAGES 29-36

PEDESTAL - PAGES 37-45

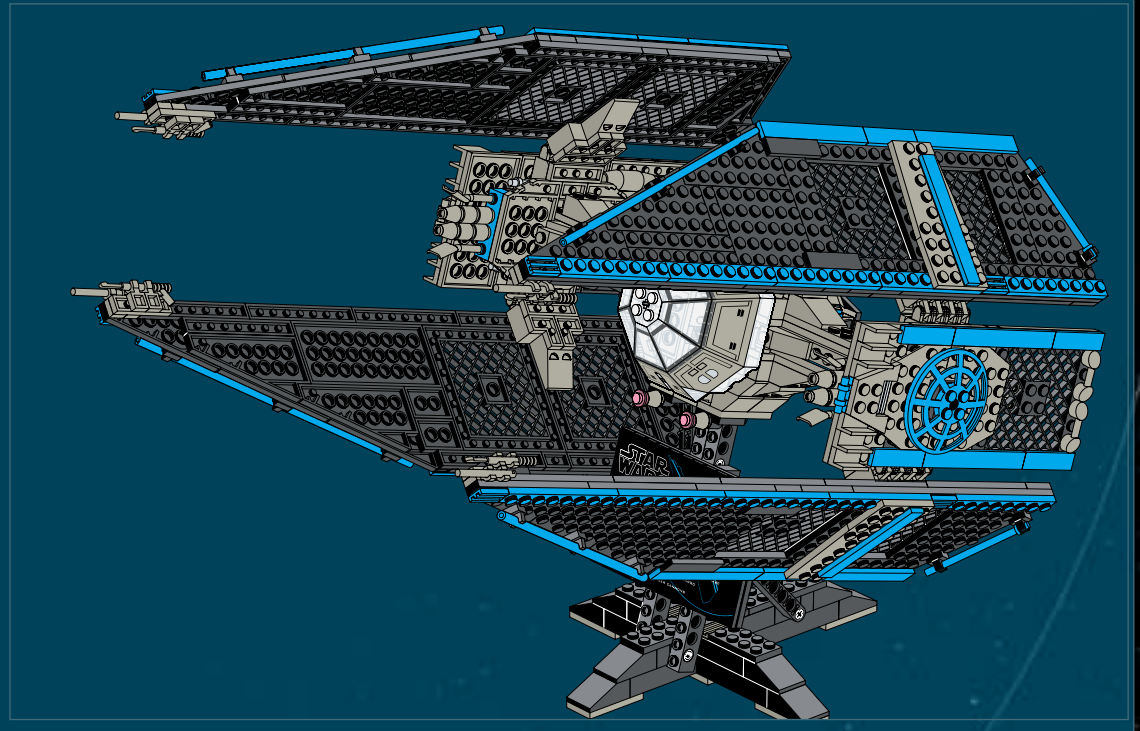



COCKPIT - PAGES 4-15

CENTER WING - PAGES 16-21

LOWER WING - PAGES 22-28

UPPER WING - PAGES 29-36

PEDESTAL - PAGES 37-45

INFO - PAGES 46-47

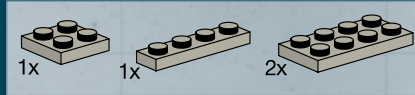
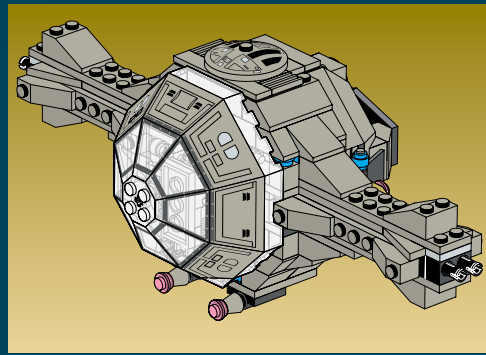

1

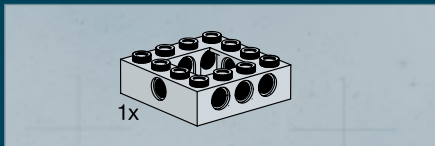
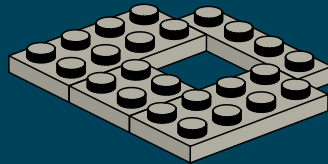

2

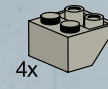
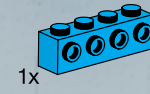
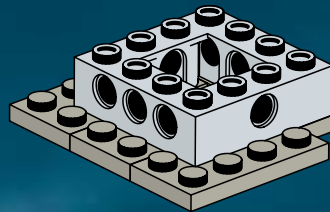

3

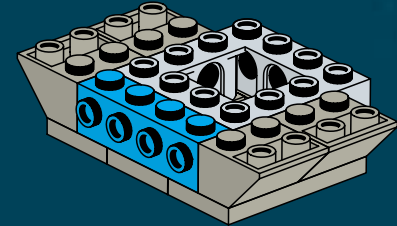

4

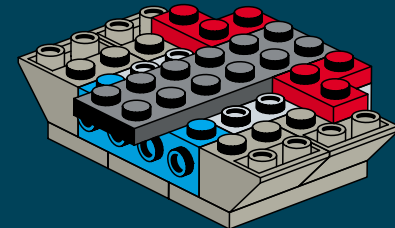

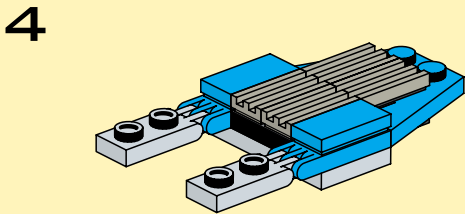
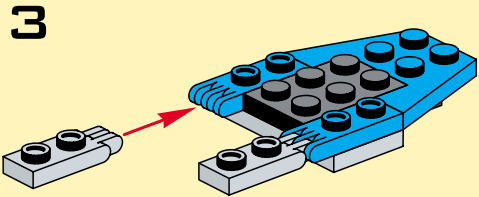
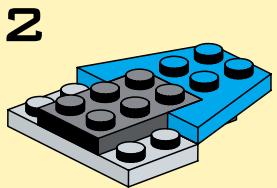
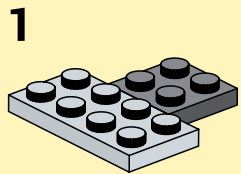
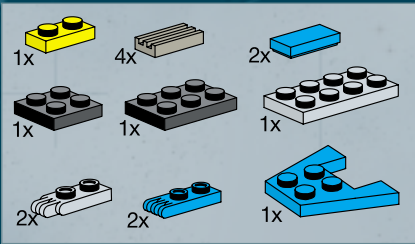

5

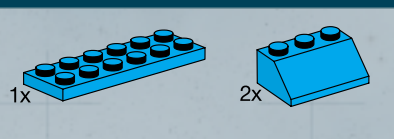
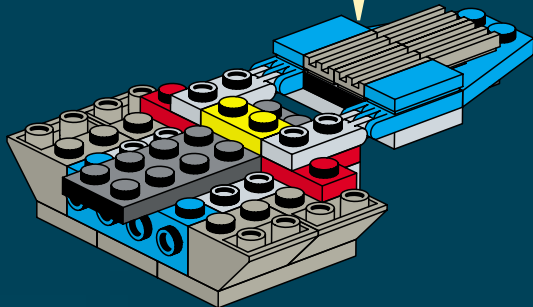

6

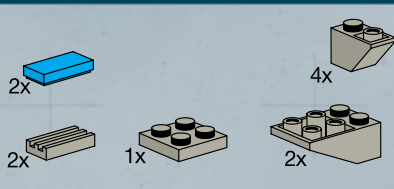
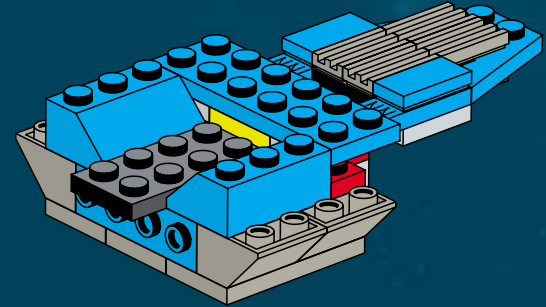

7

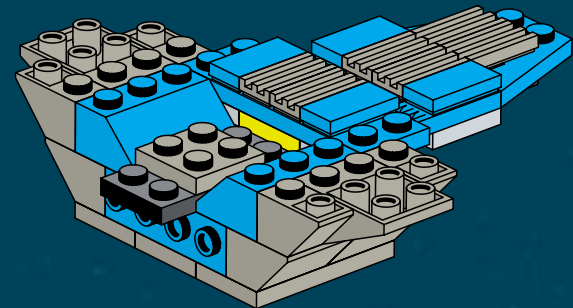



SIENAR FLEET SYSTEMS

TIE INTERCEPTOR™

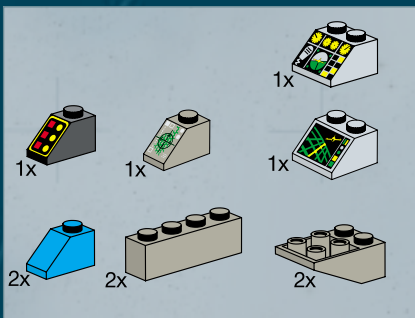

8

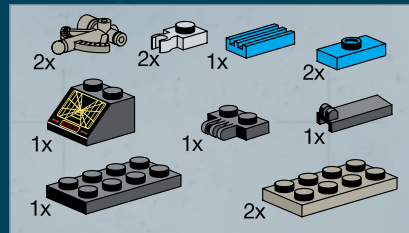
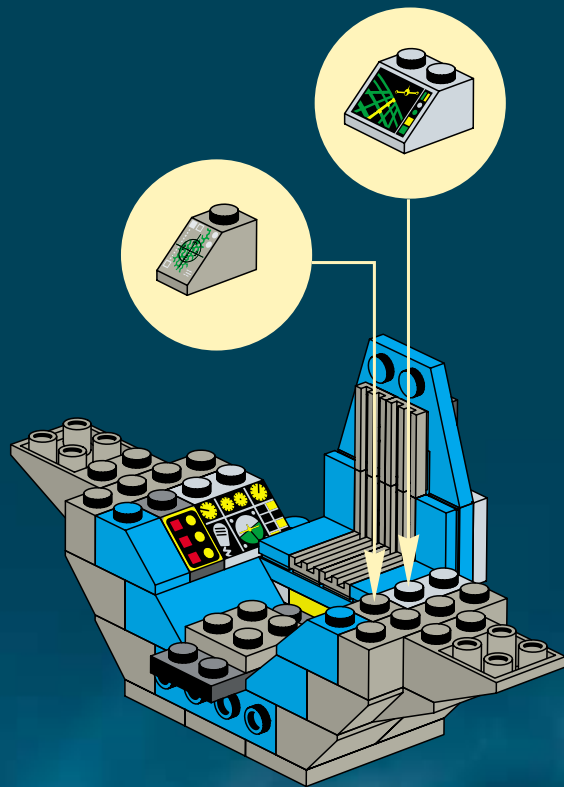

9

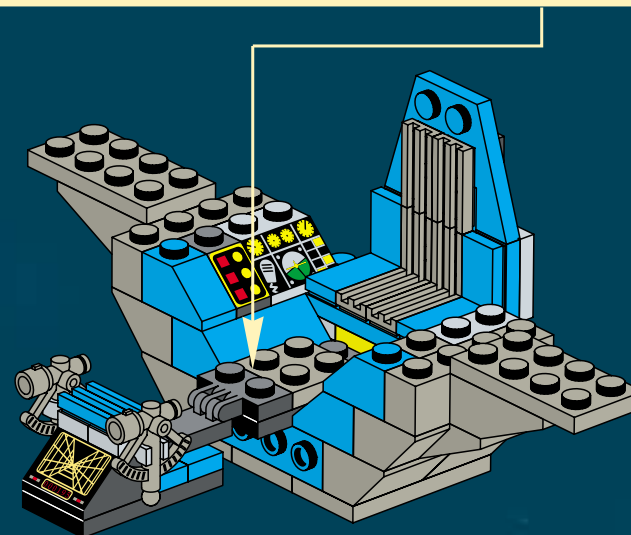
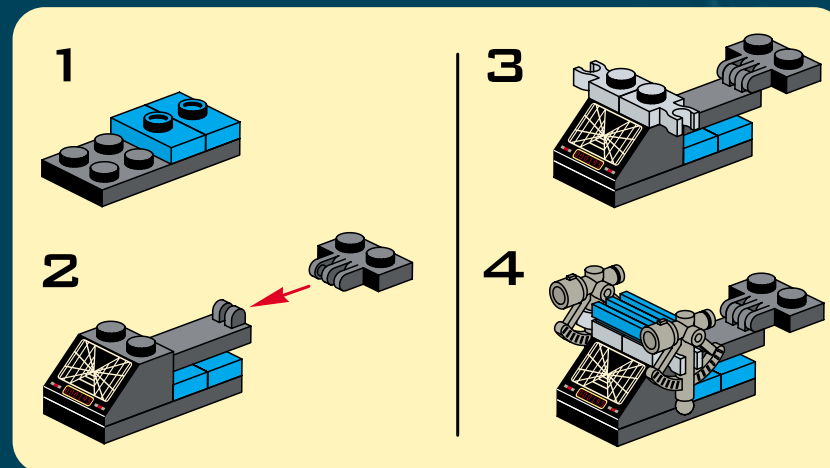

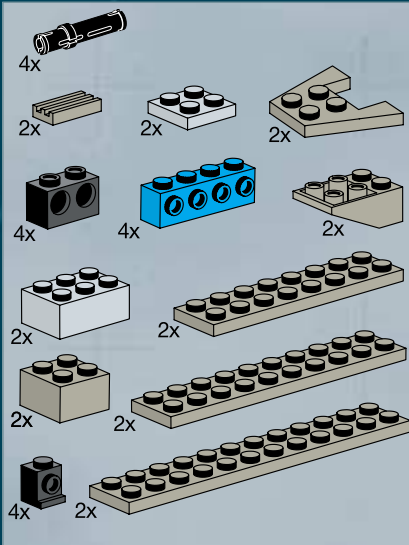

11

1

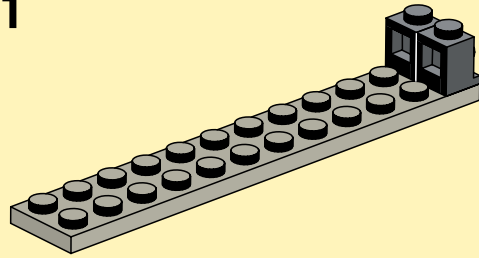

1

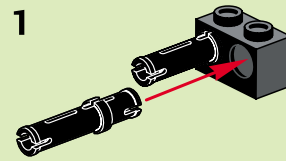

2

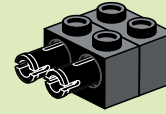

2

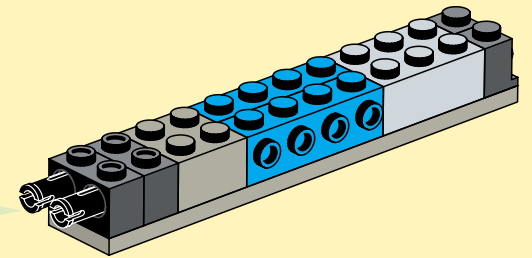

3

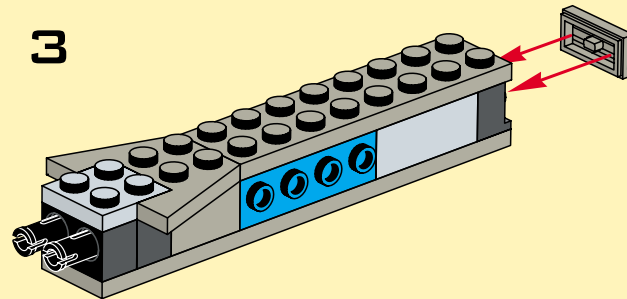

4

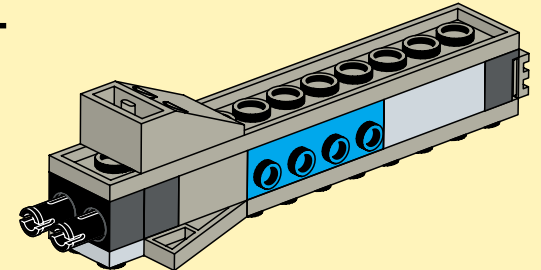

5

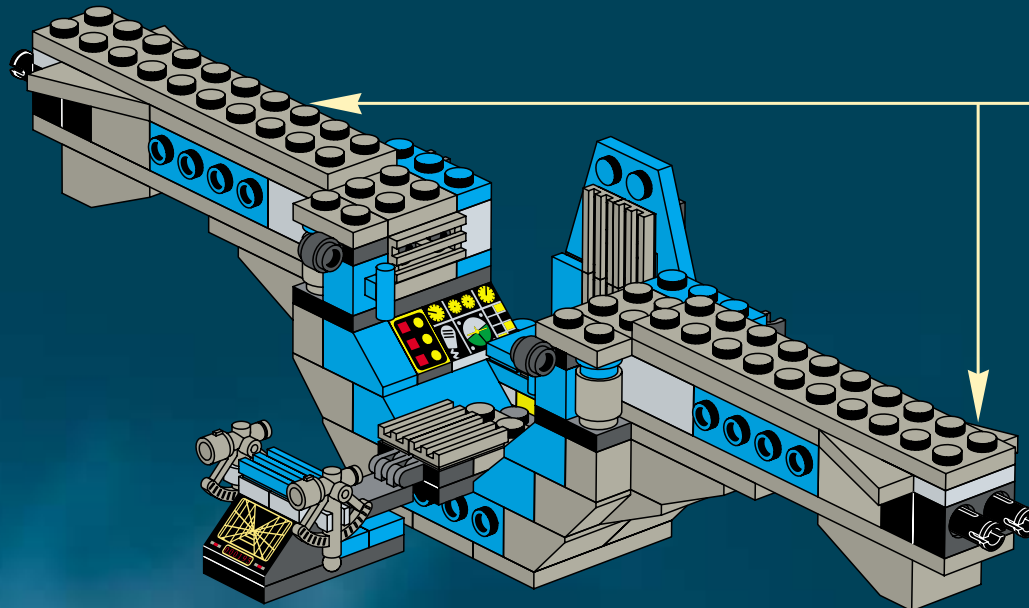
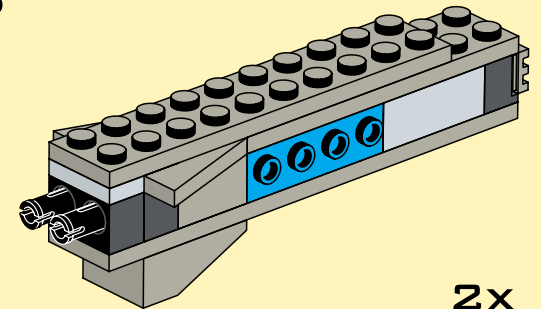



12

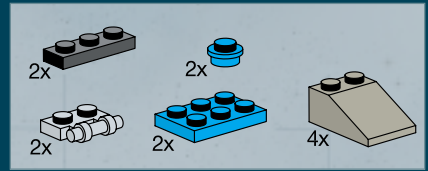
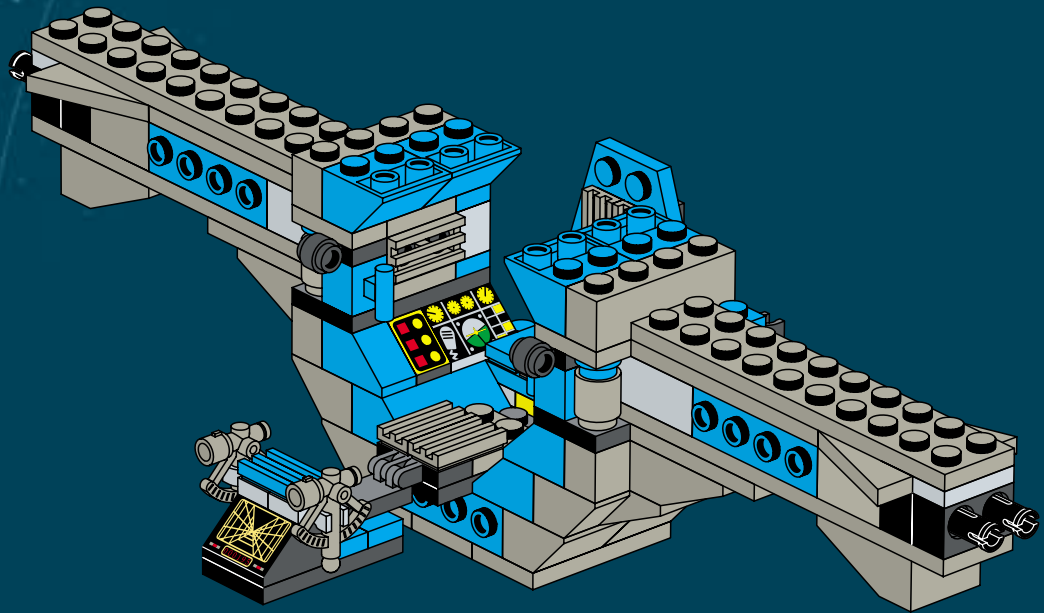

13

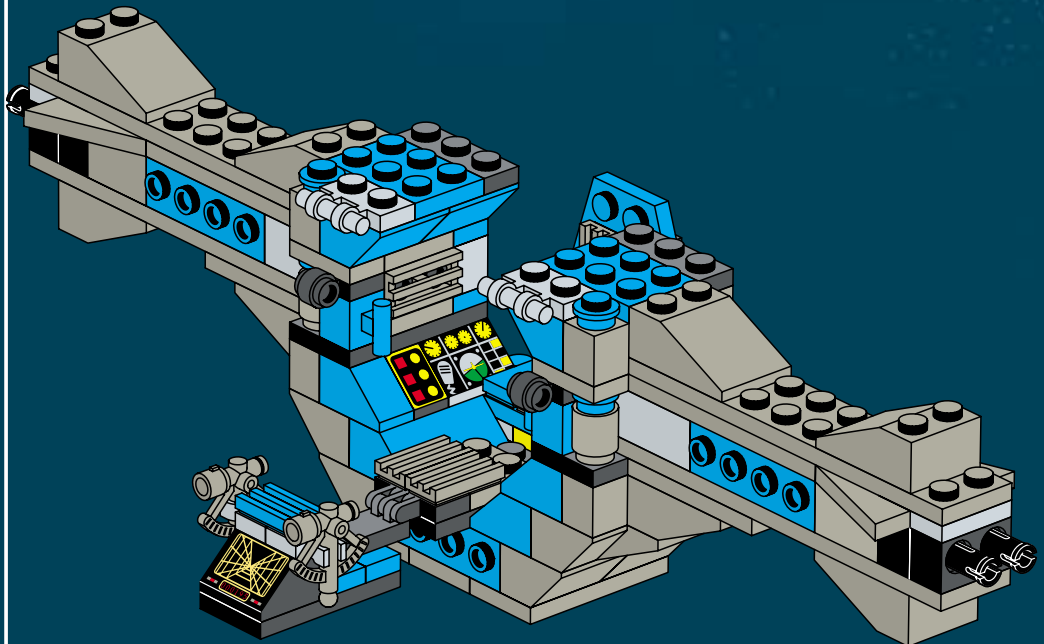



SIENAR FLEET SYSTEMS

TIE INTERCEPTOR™

4x



4x



2x

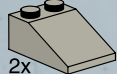

14

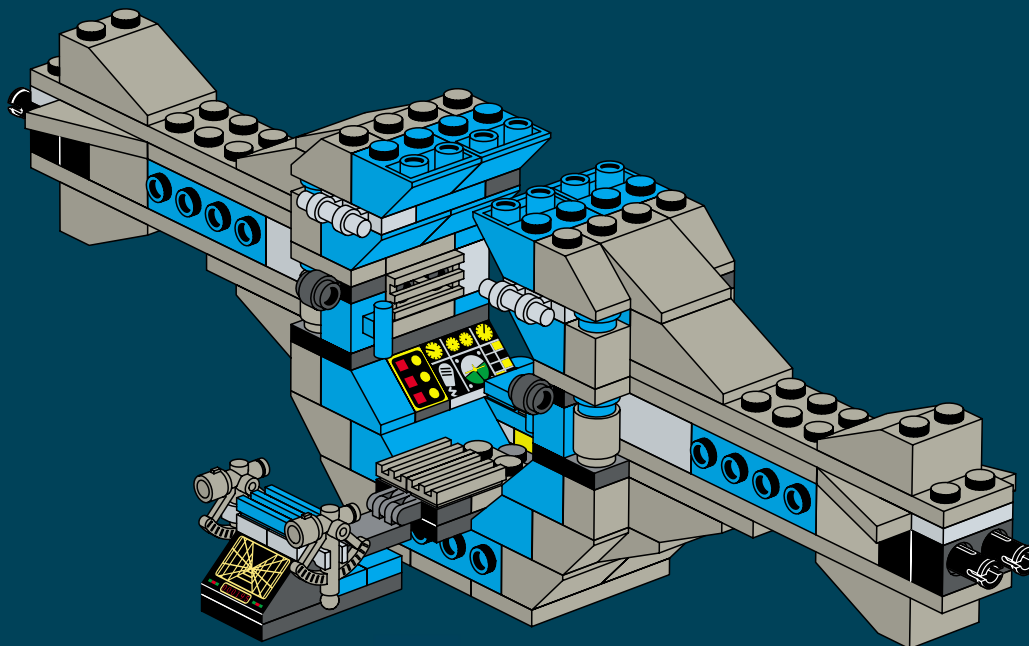

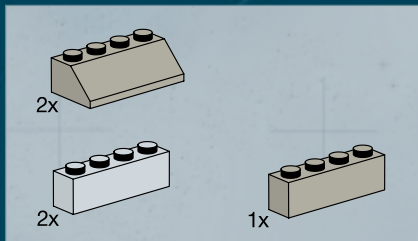

15

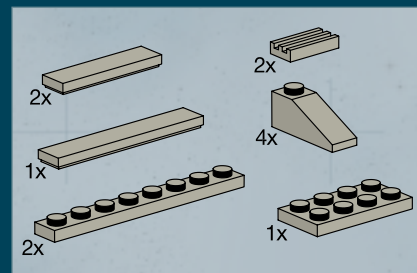
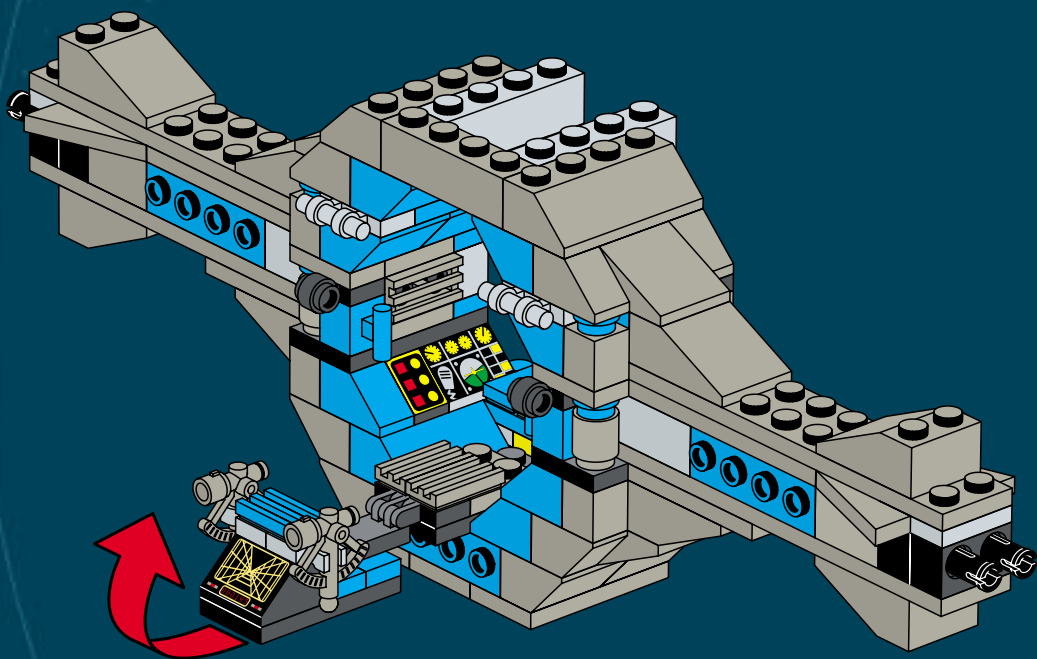

16

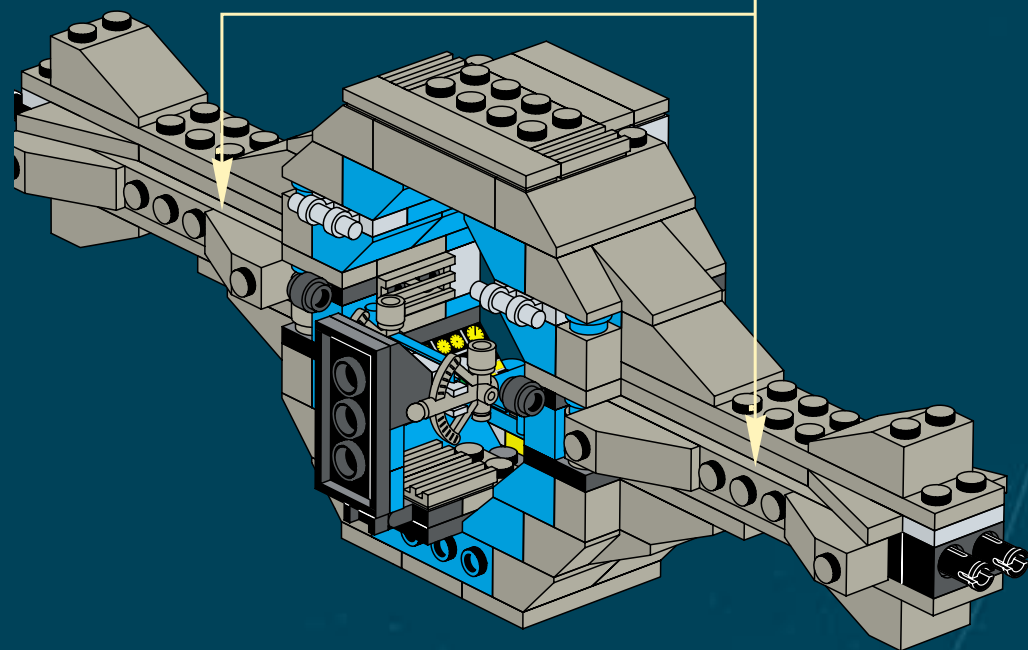
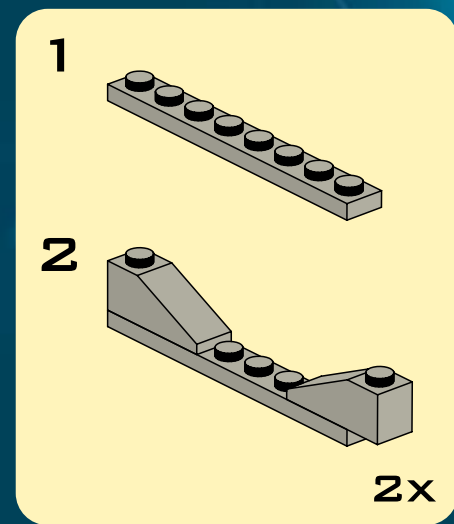



SIENAR FLEET SYSTEMS

TIE INTERCEPTOR™

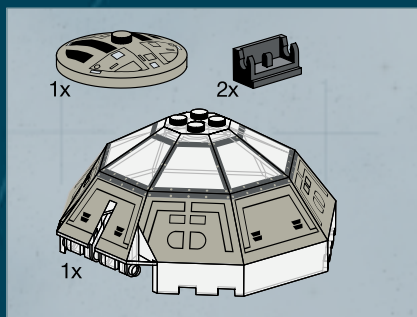

17

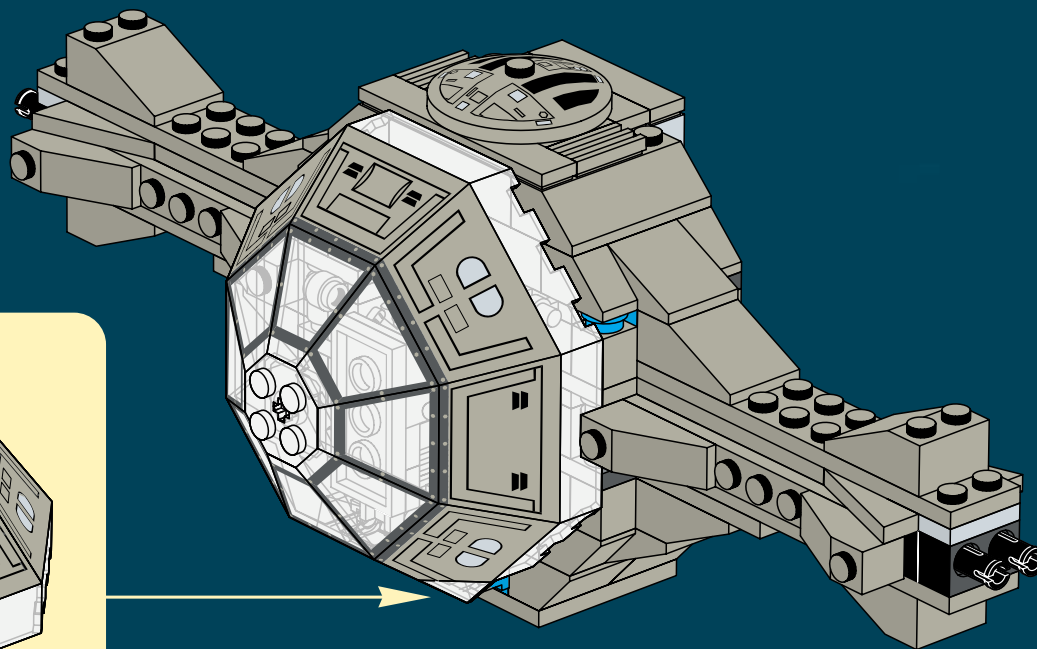
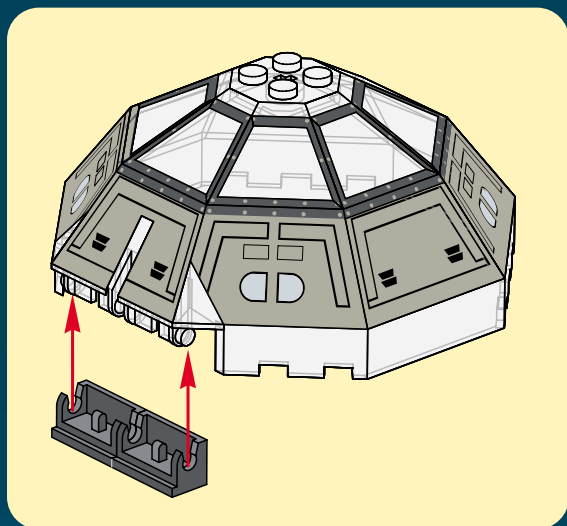

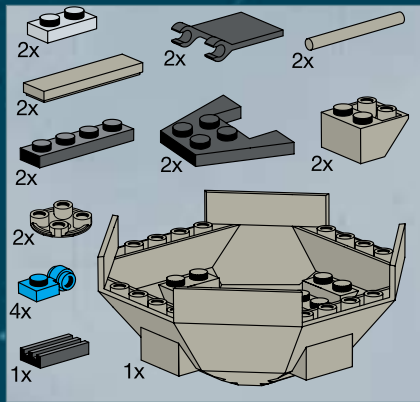

18

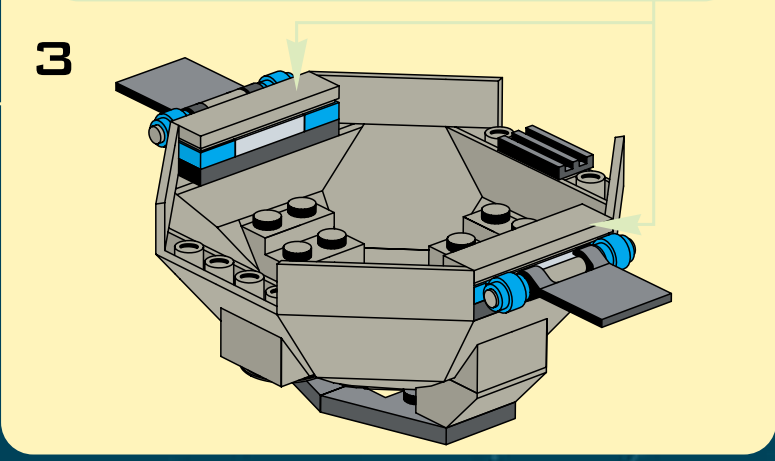
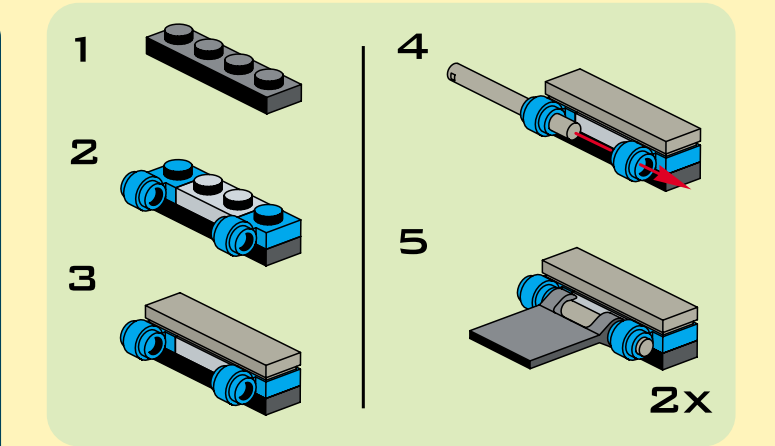
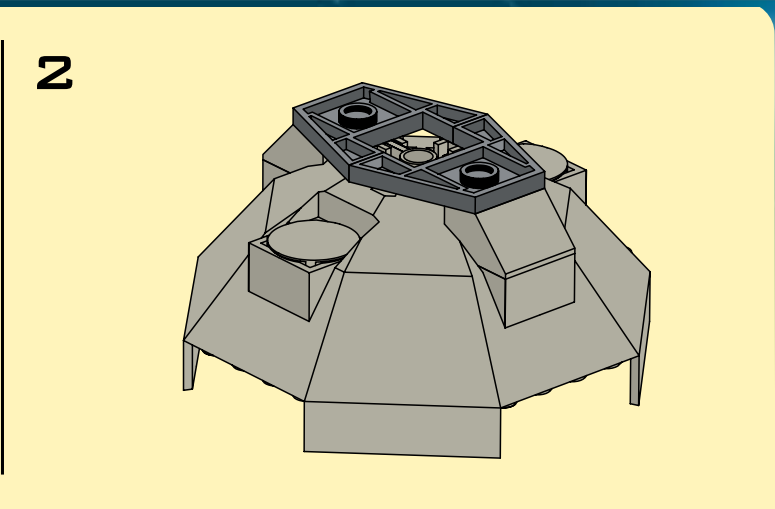
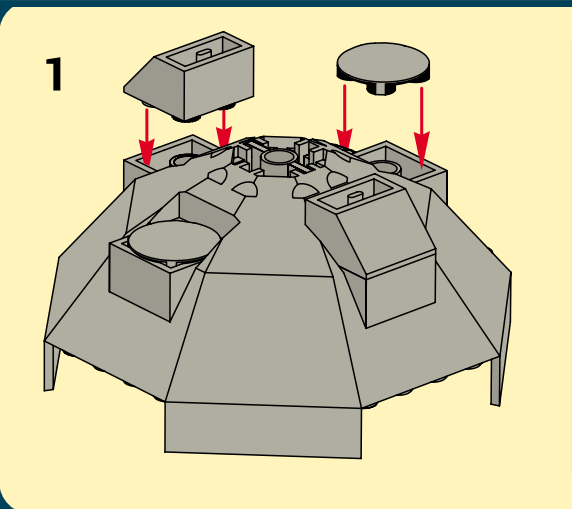
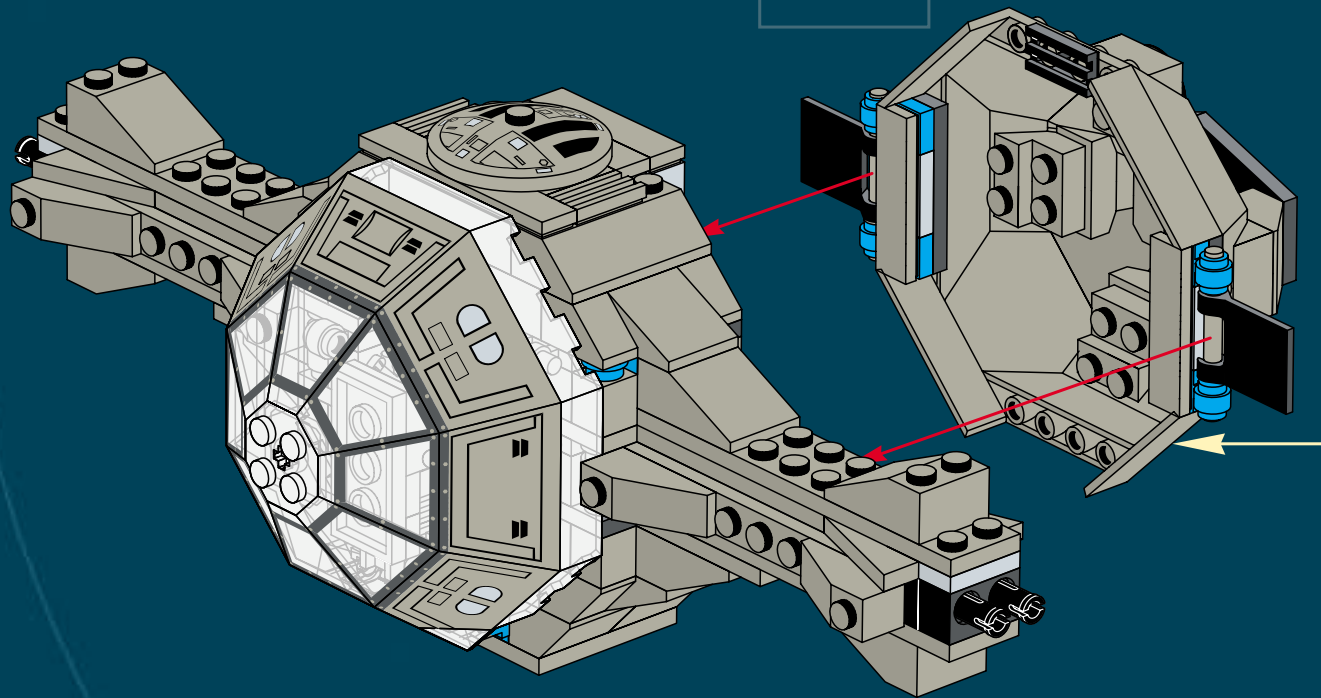



SIENAR FLEET SYSTEMS

TIE INTERCEPTOR™

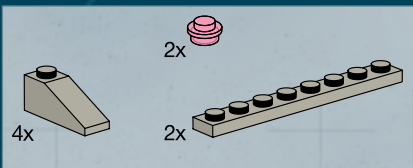

19

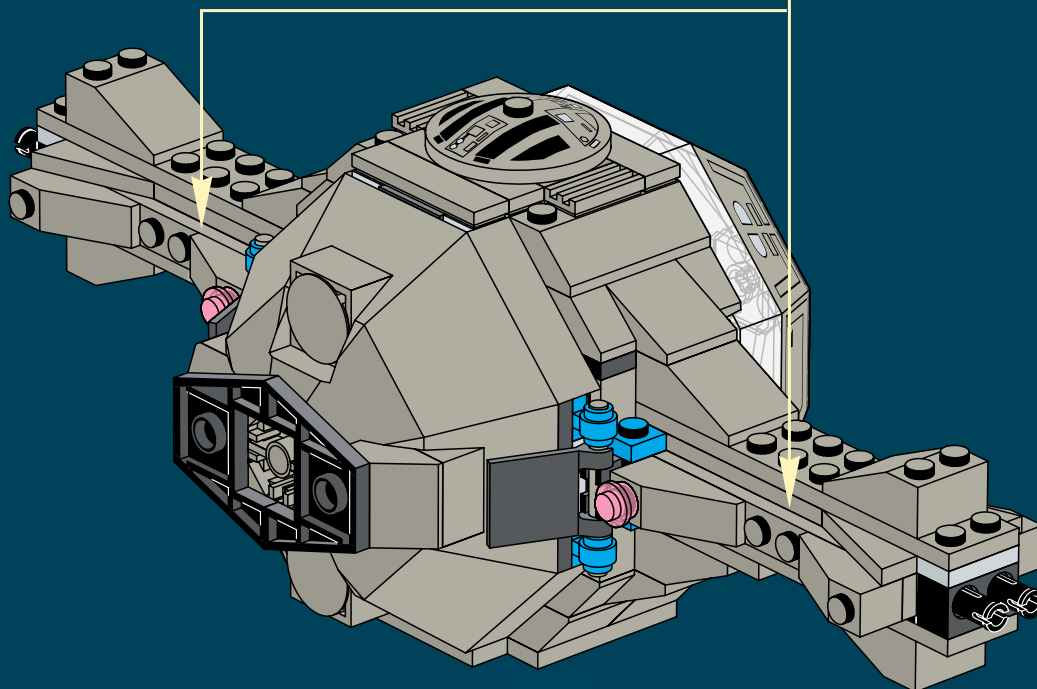
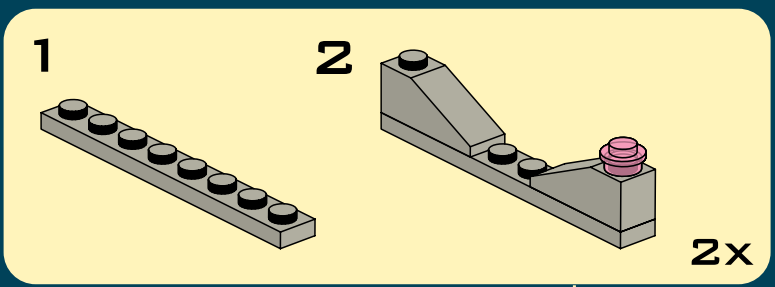



20

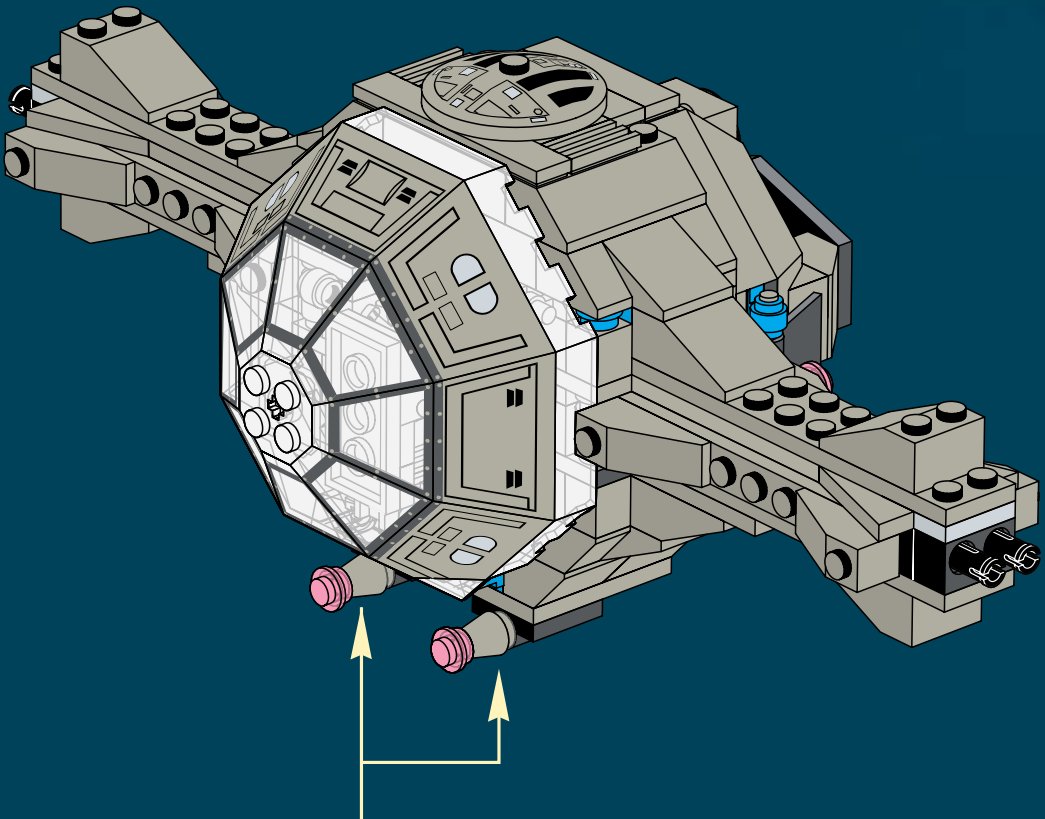

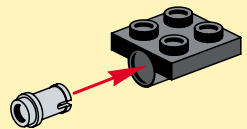
1 

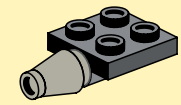
2 

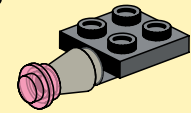
3 

2x



COCKPIT - PAGES 4-15

CENTER WING - PAGES 16-21

LOWER WING - PAGES 22-28

UPPER WING - PAGES 29-36

PEDESTAL - PAGES 37-45

INFO - PAGES 46-47

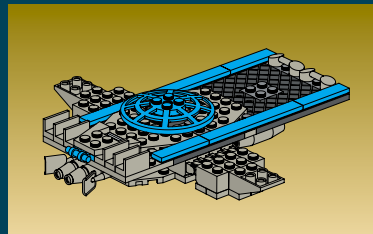
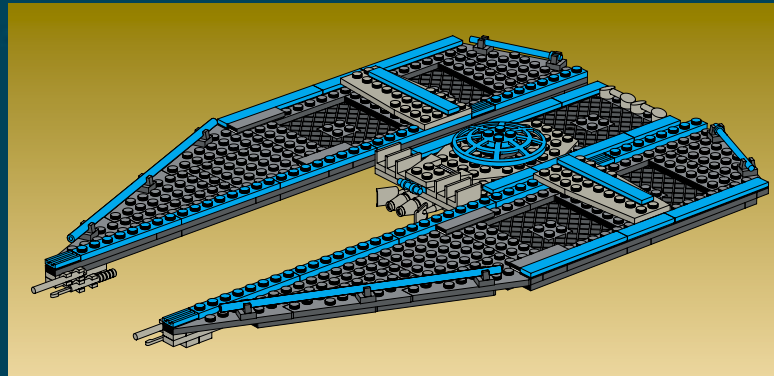

1

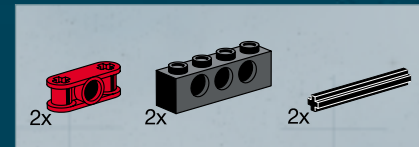
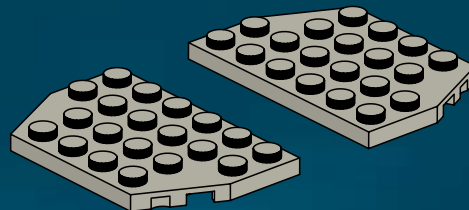

2

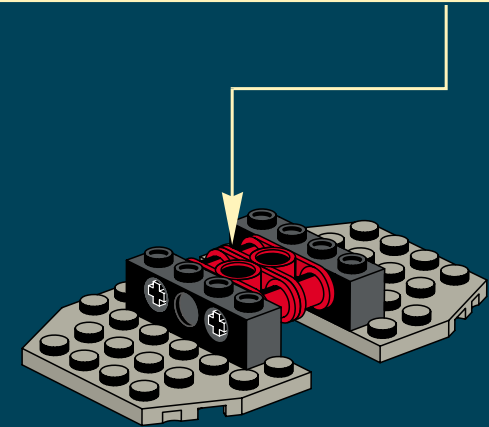
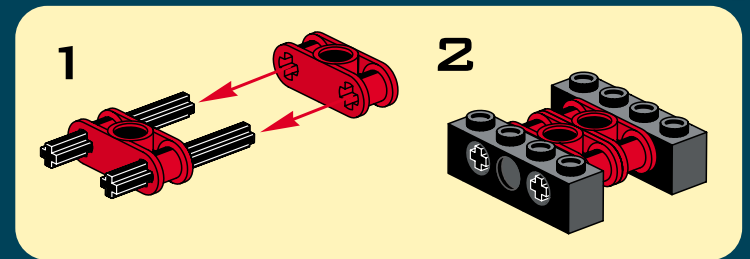

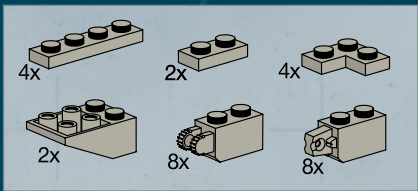

3

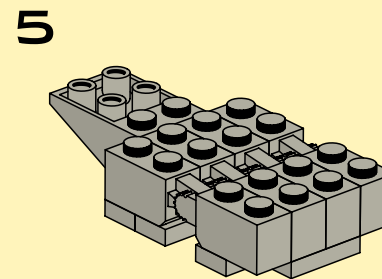
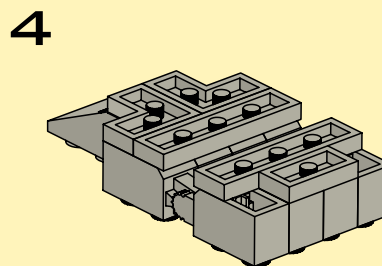
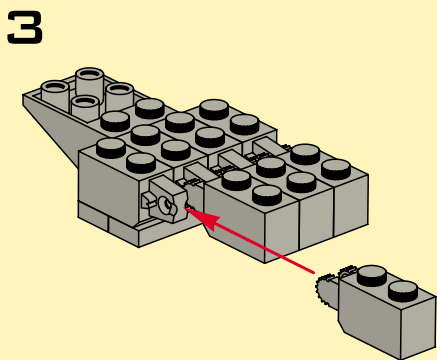
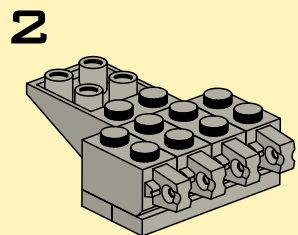
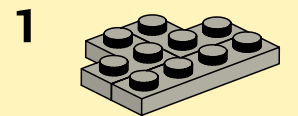

2x

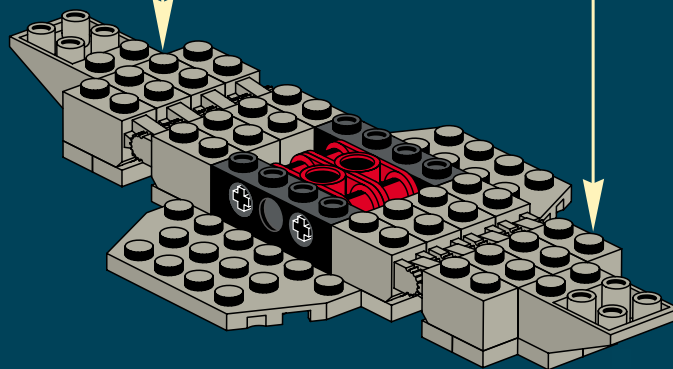

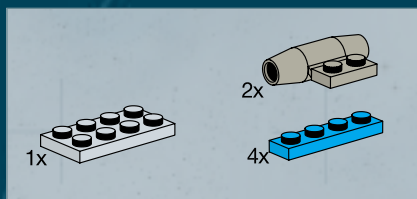

4

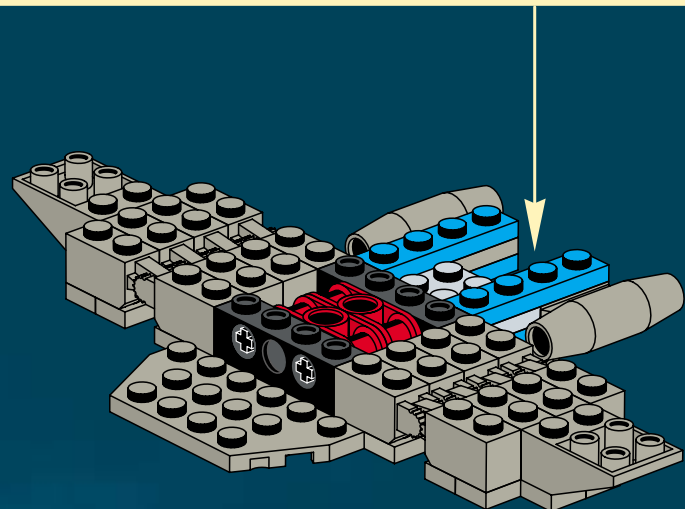
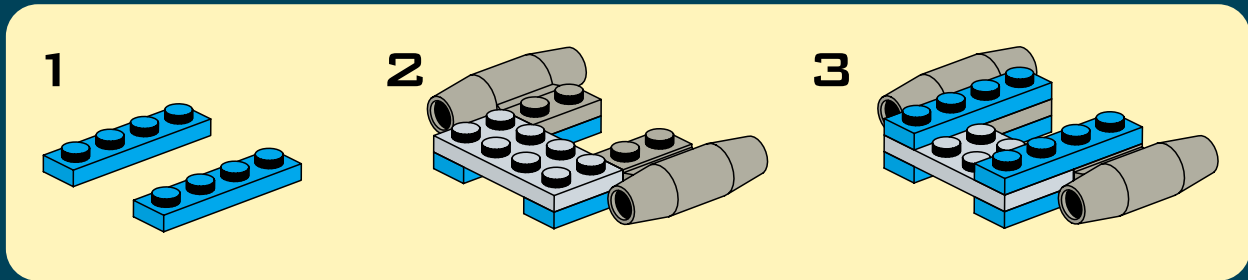

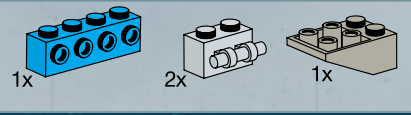

5

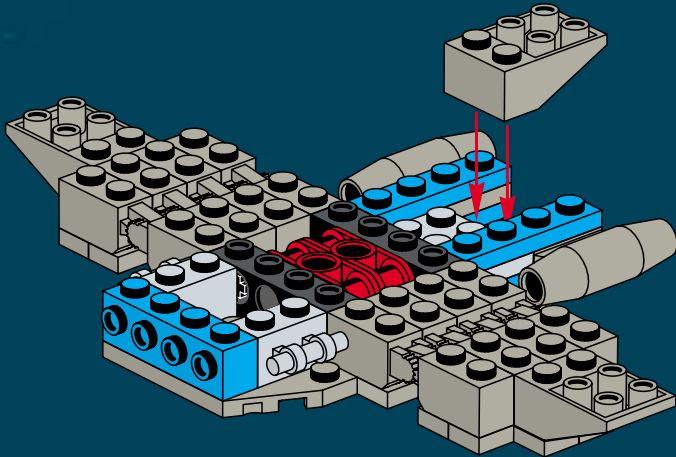

6

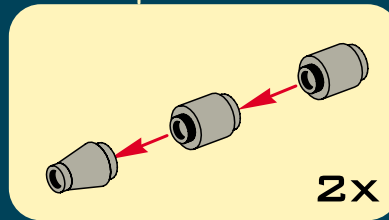
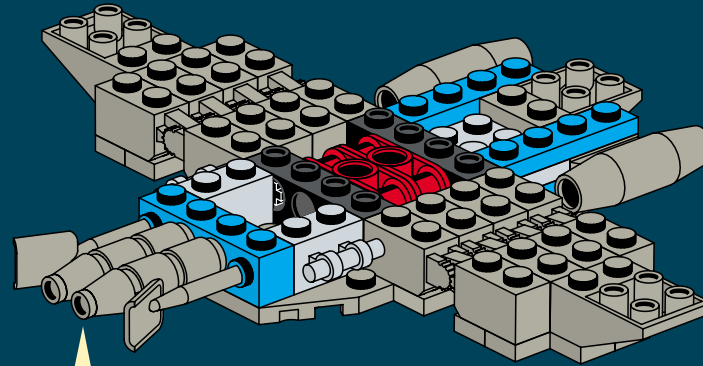

3

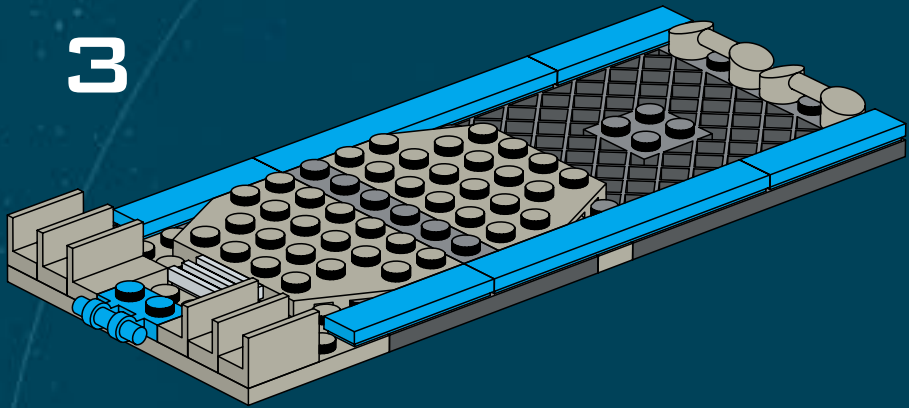

4

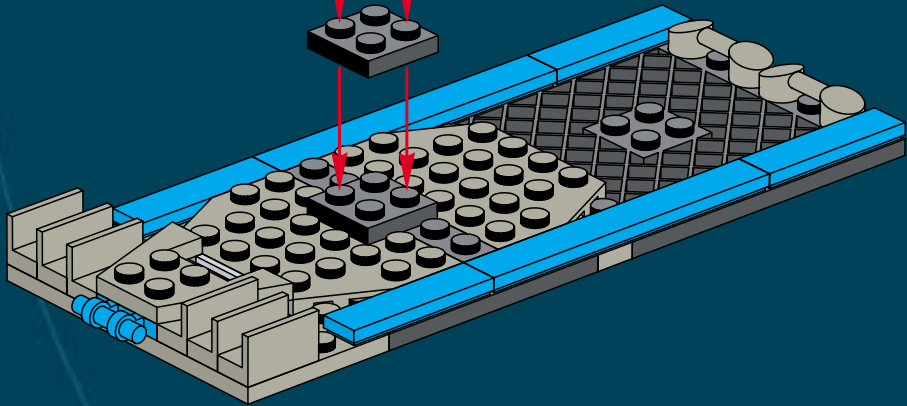
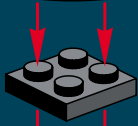

7

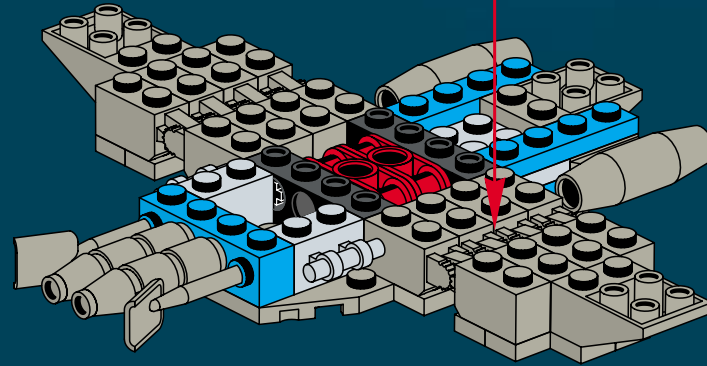
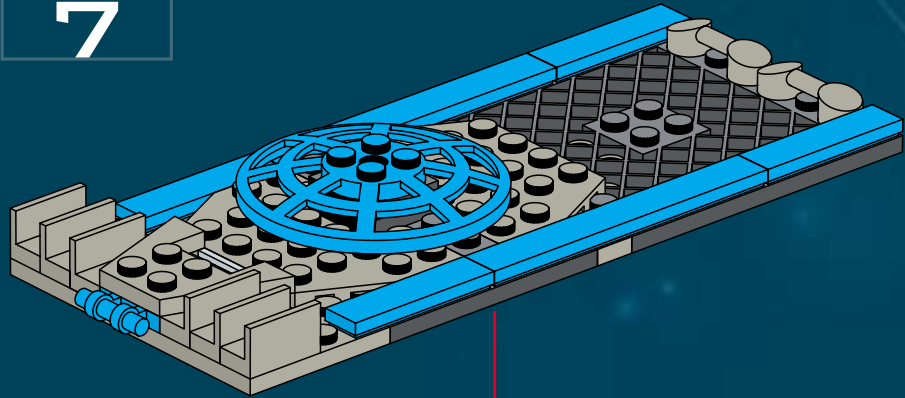

8

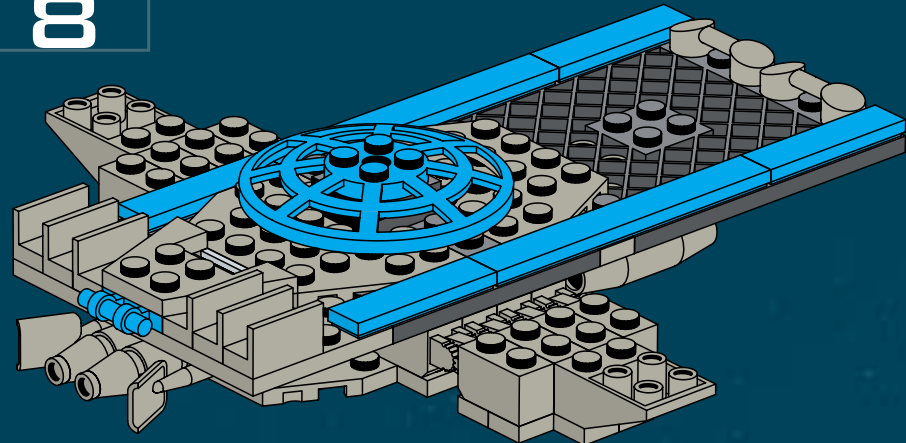



COCKPIT - PAGES 4-15

CENTER WING - PAGES 16-21

LOWER WING - PAGES 22-28

UPPER WING - PAGES 29-36

PEDESTAL - PAGES 37-45

INFO - PAGES 46-47

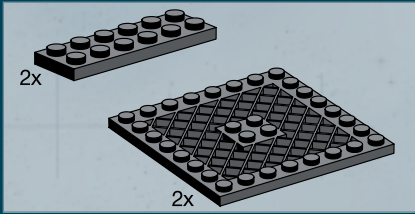
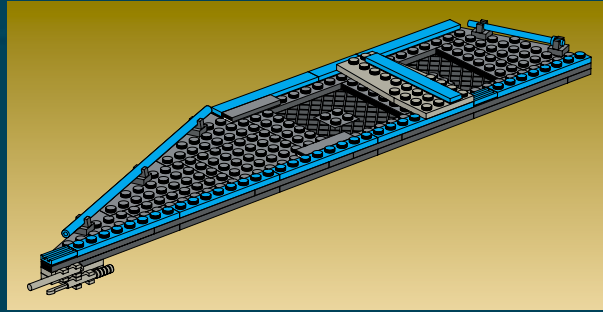

1

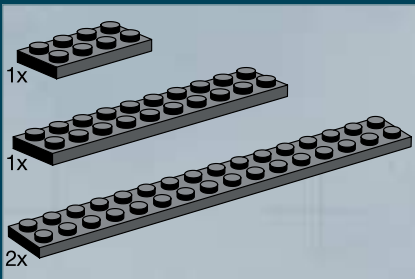
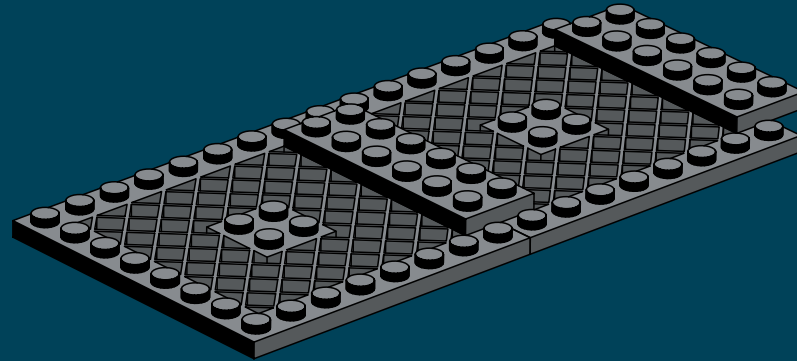

2

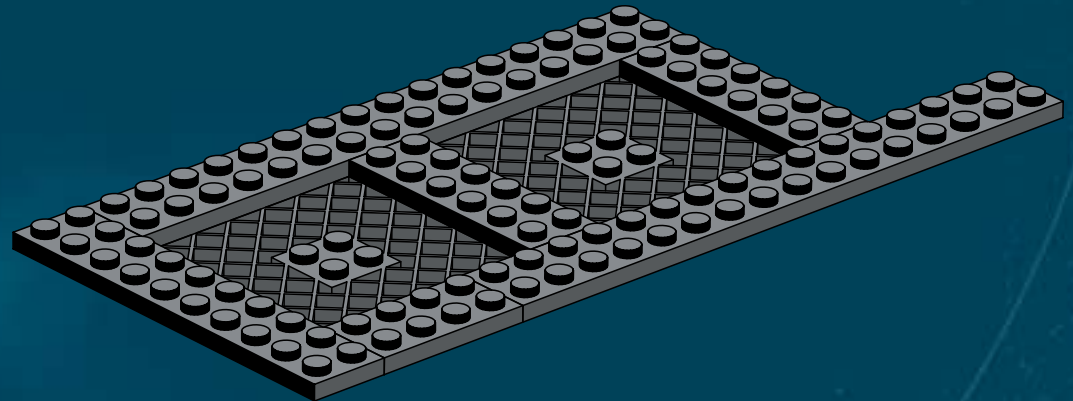

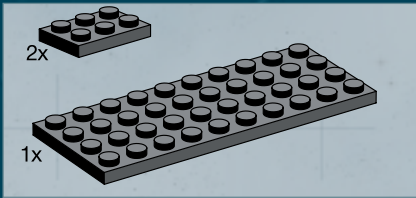

3

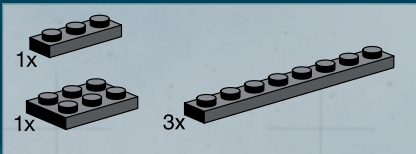
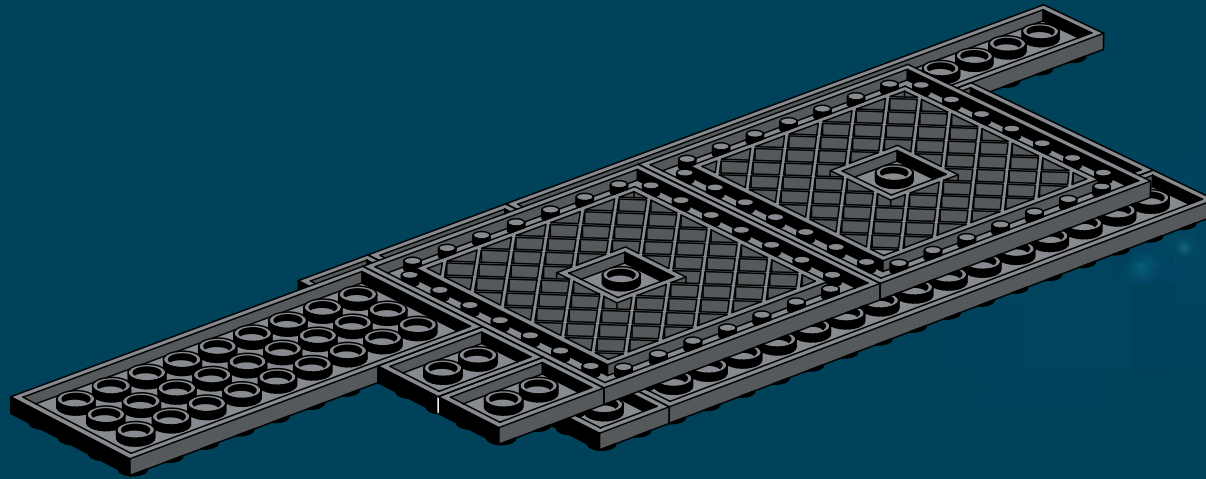

4

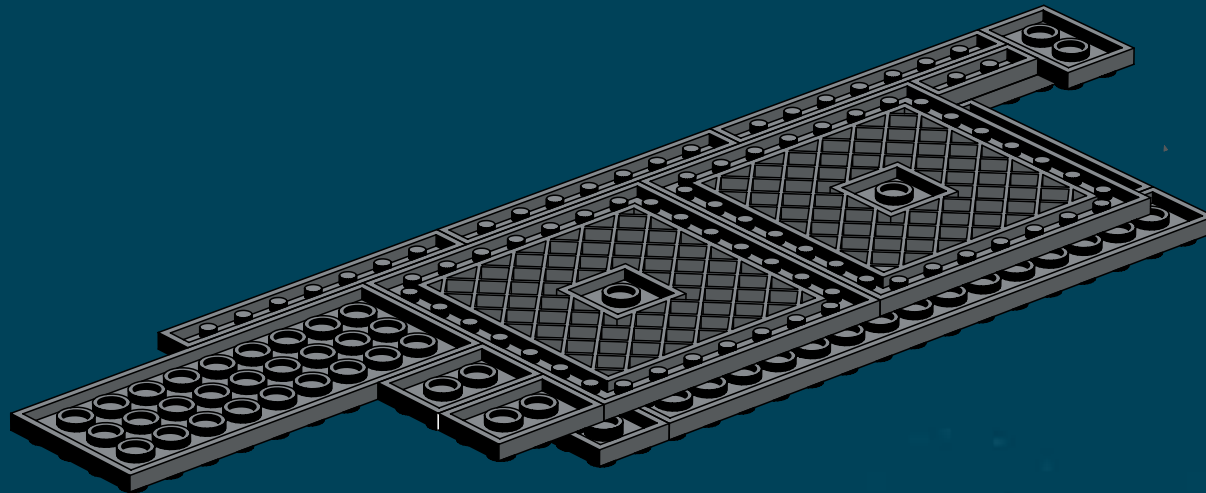



SIENAR FLEET SYSTEMS

TIE INTERCEPTOR™

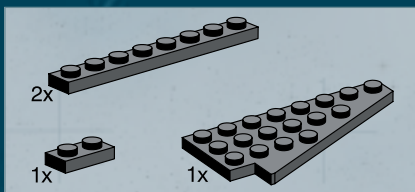

5

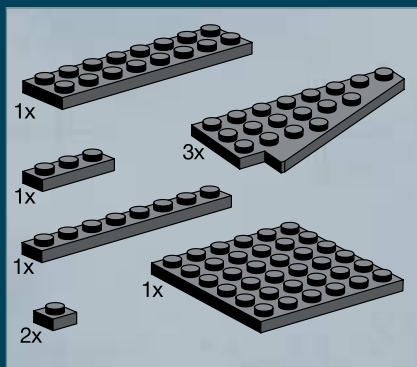
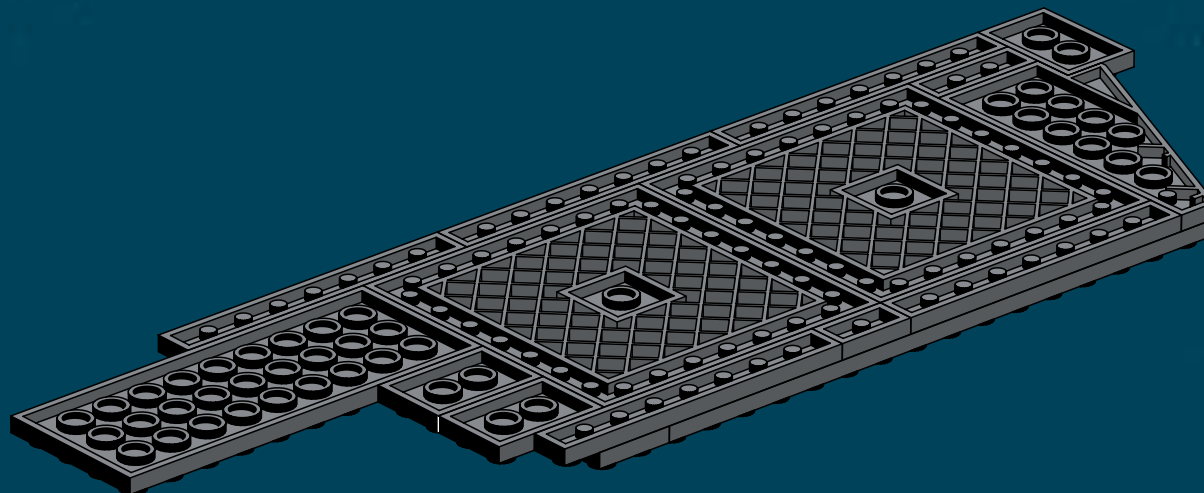

6

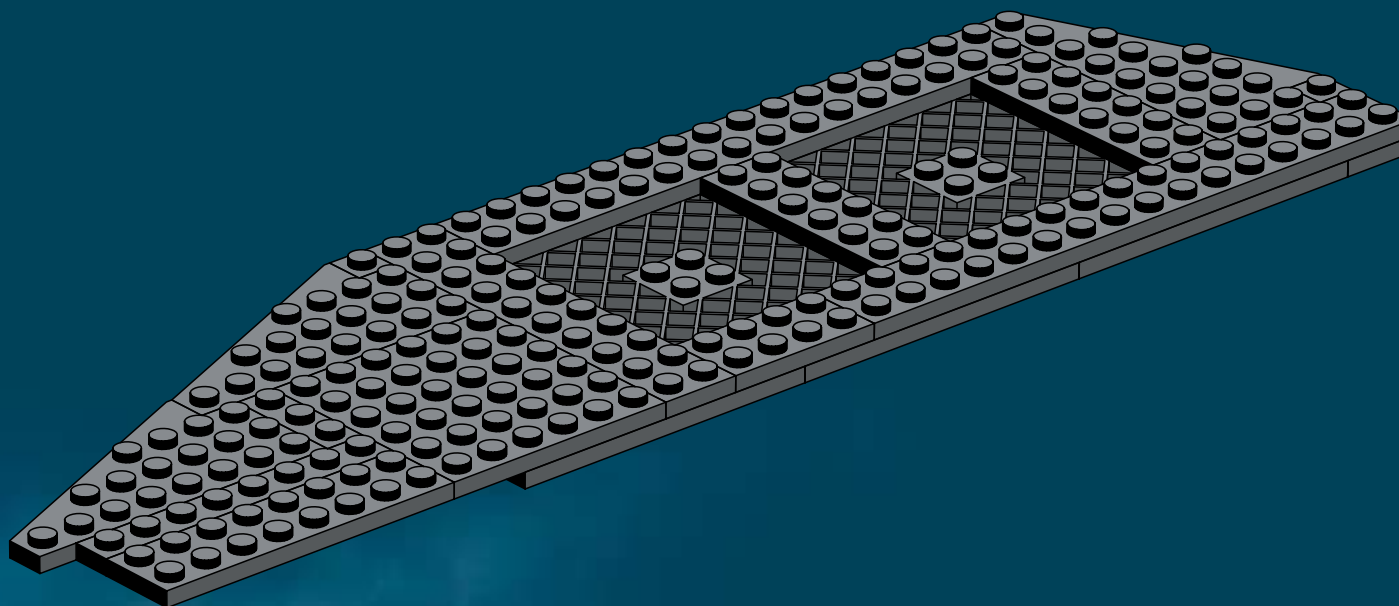

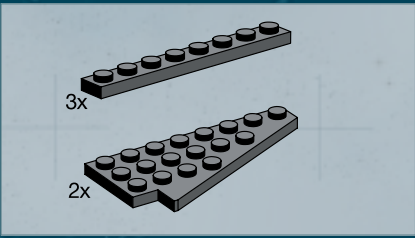

7

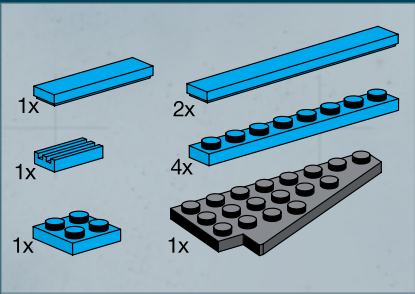
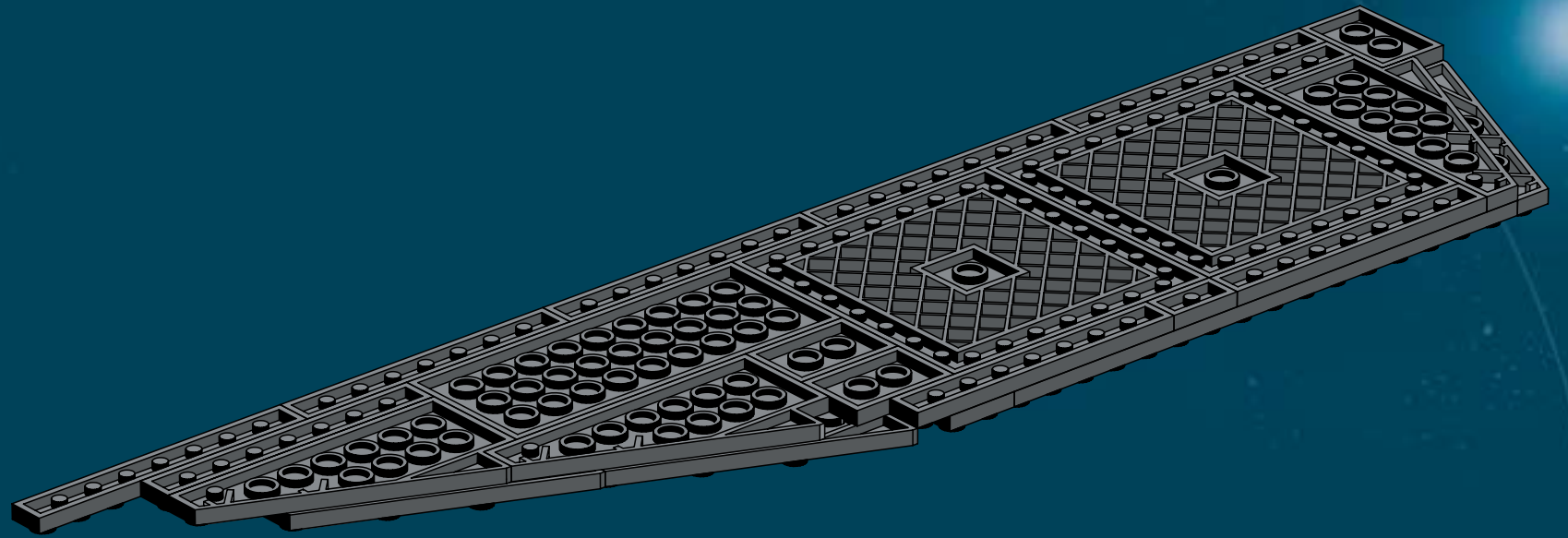

8

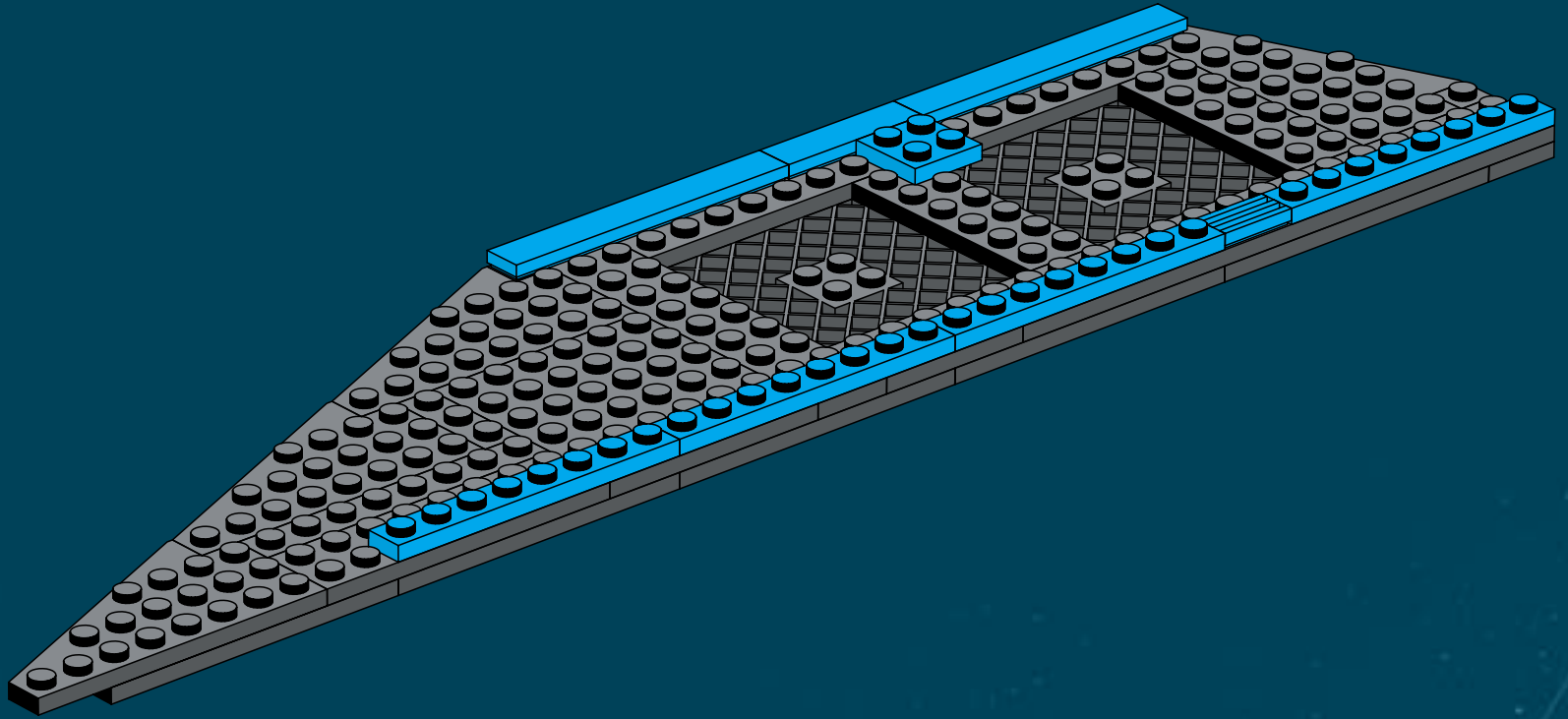



SIENAR FLEET SYSTEMS

TIE INTERCEPTOR™

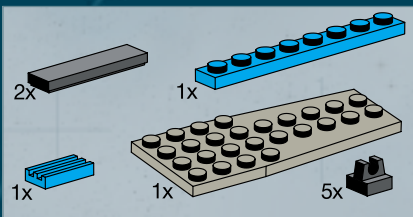

9

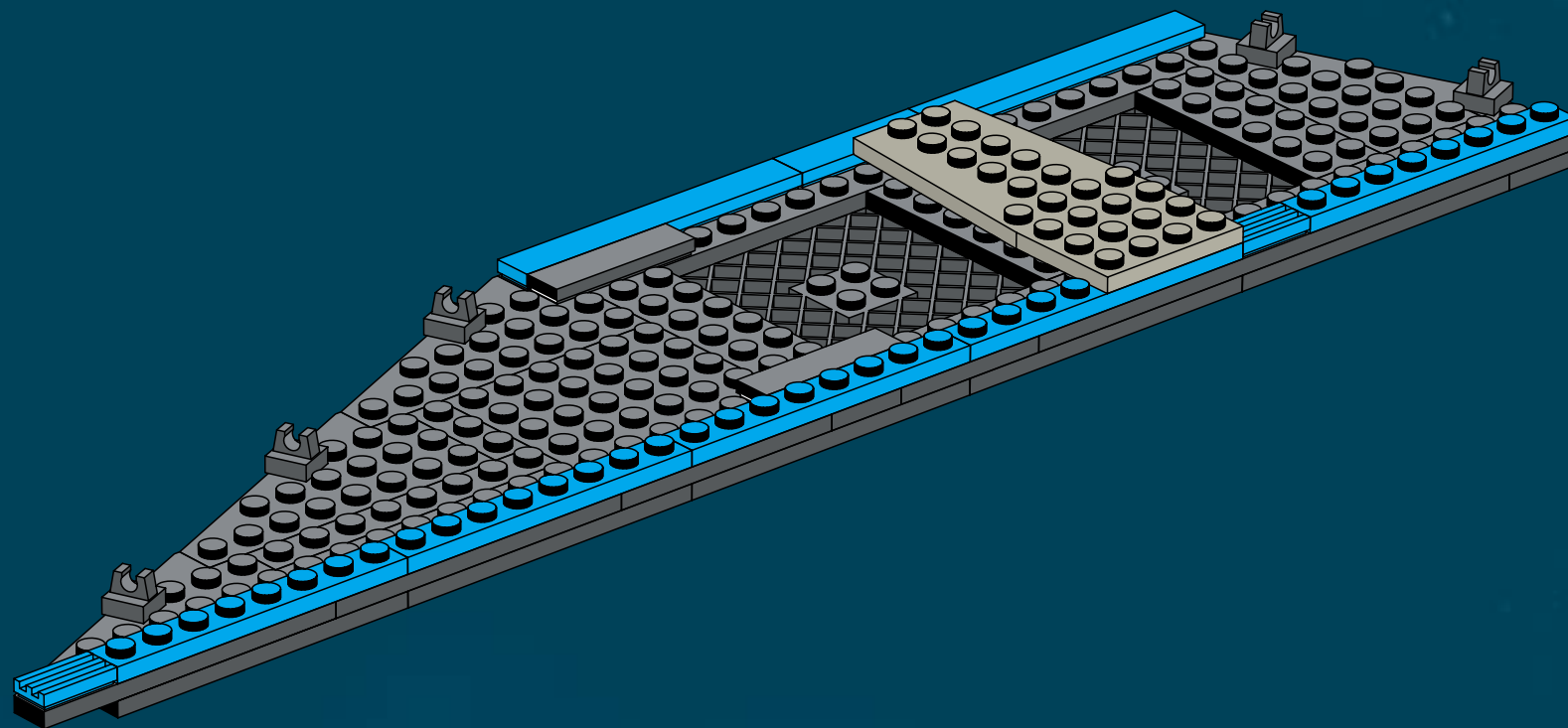

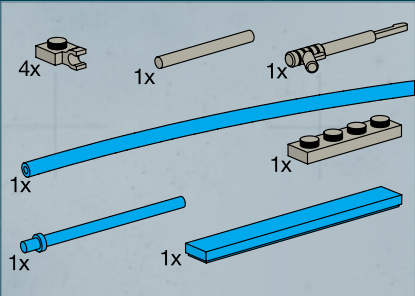

10

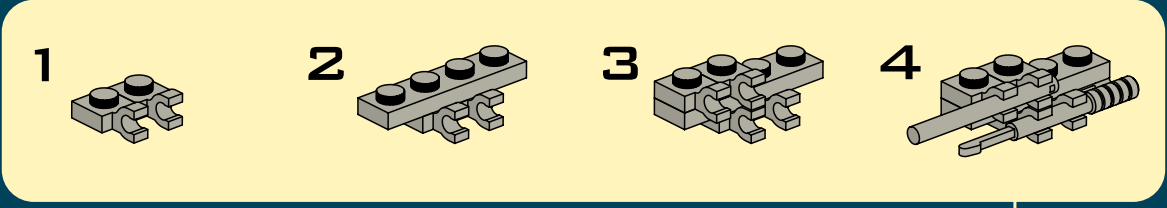
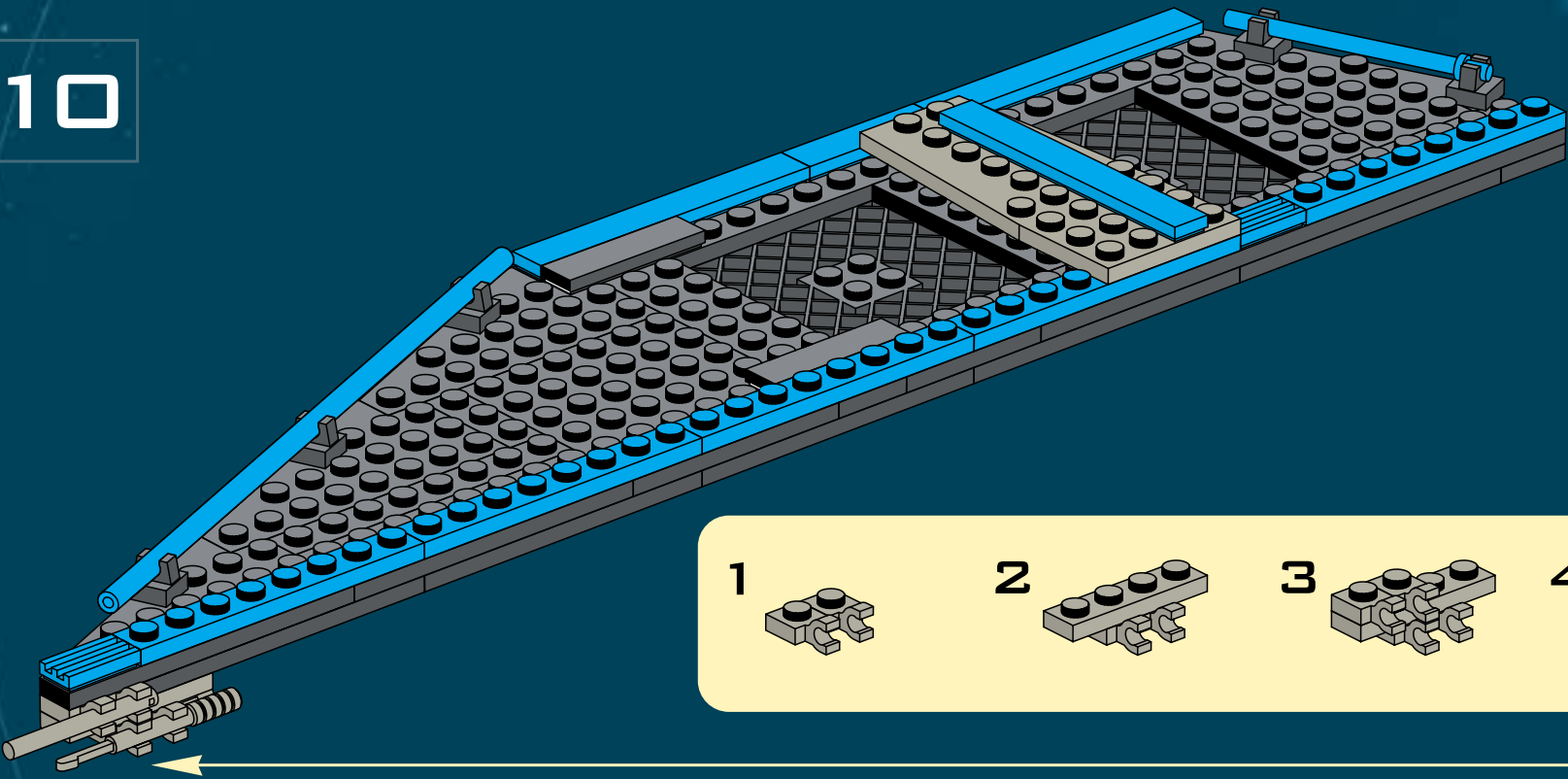



SIENAR FLEET SYSTEMS

TIE INTERCEPTOR™

11

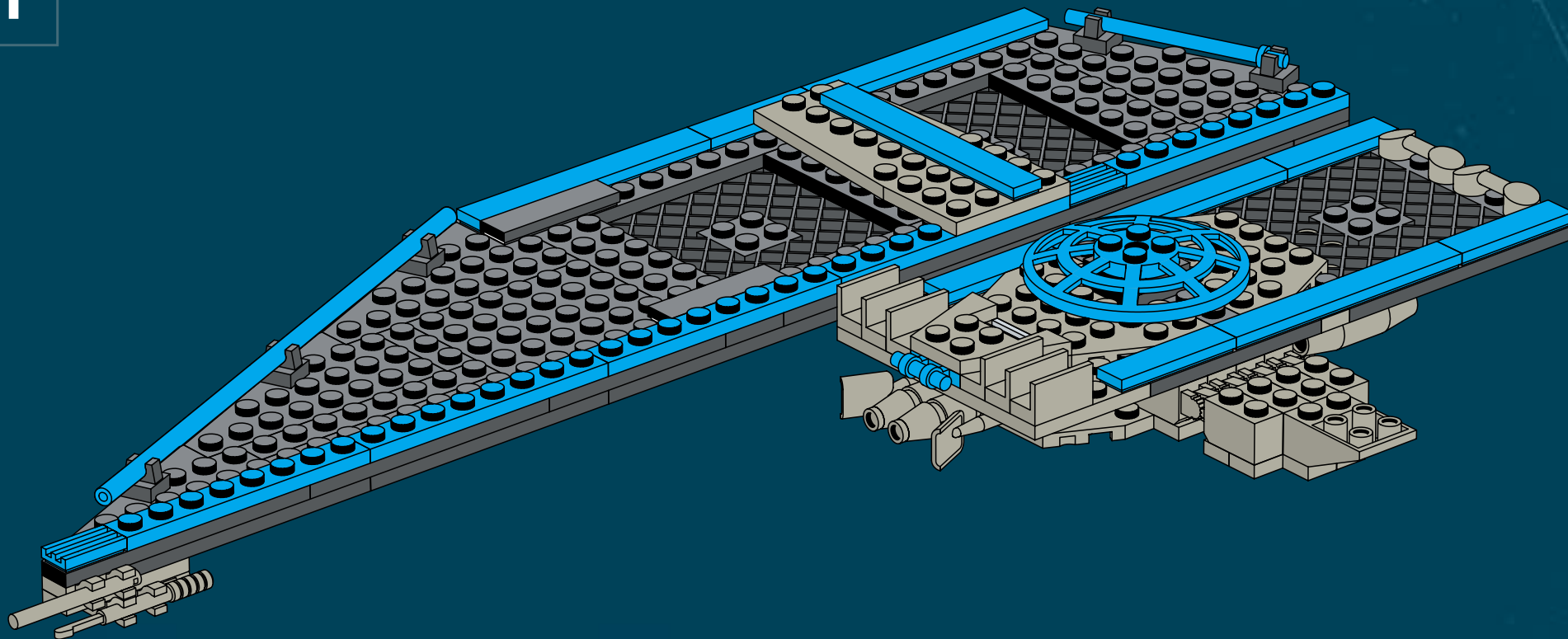



COCKPIT - PAGES 4-15

CENTER WING - PAGES 16-21

LOWER WING - PAGES 22-28

UPPER WING - PAGES 29-36

PEDESTAL - PAGES 37-45

INFO - PAGES 46-47

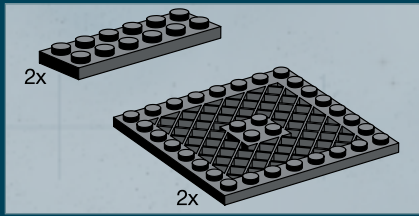
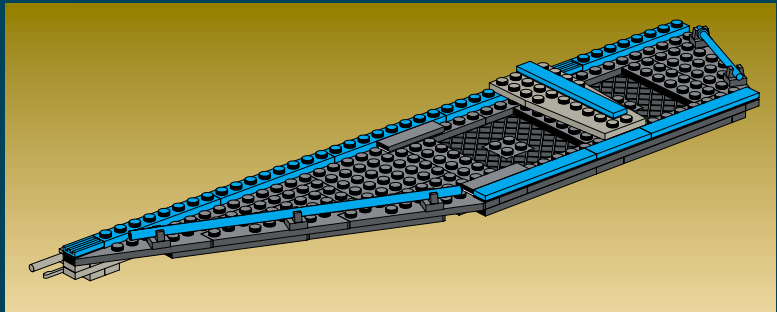

1

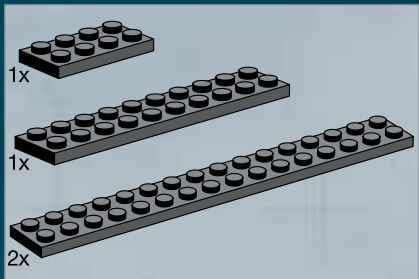
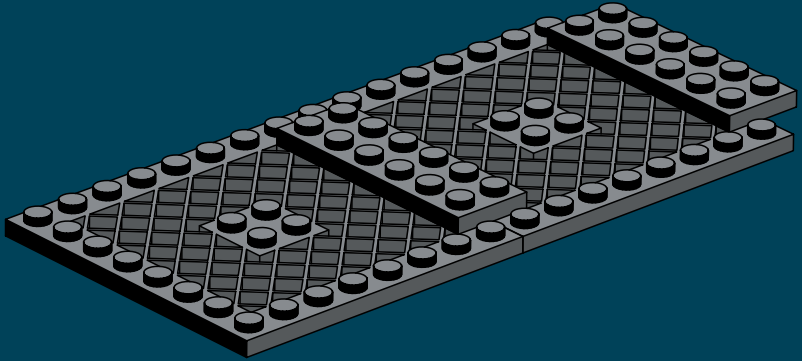

2

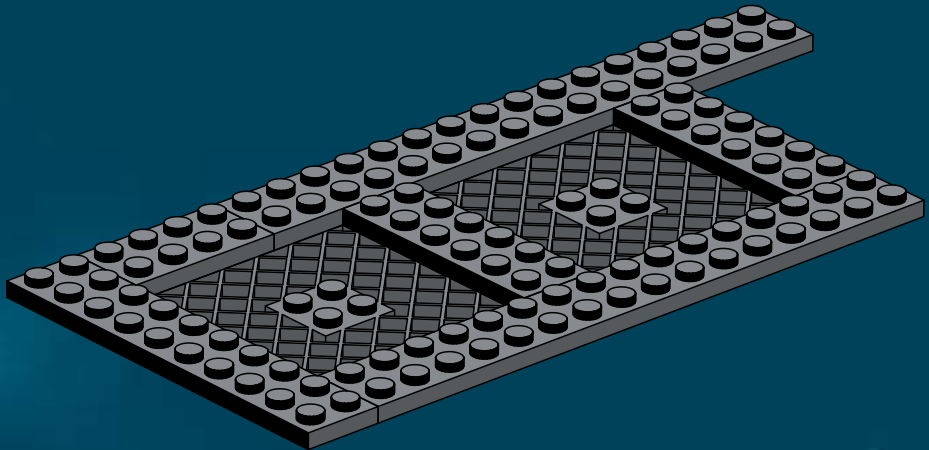



SIENAR FLEET SYSTEMS

TIE INTERCEPTOR™

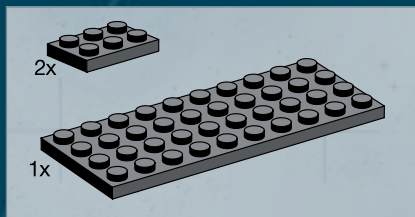

3

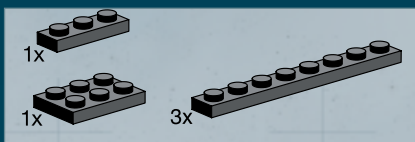
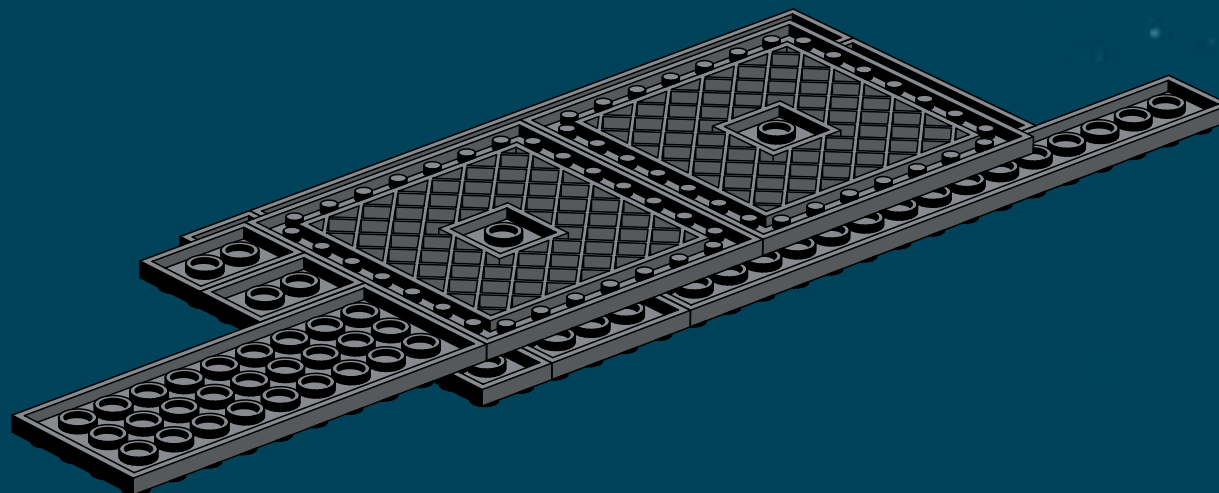

4

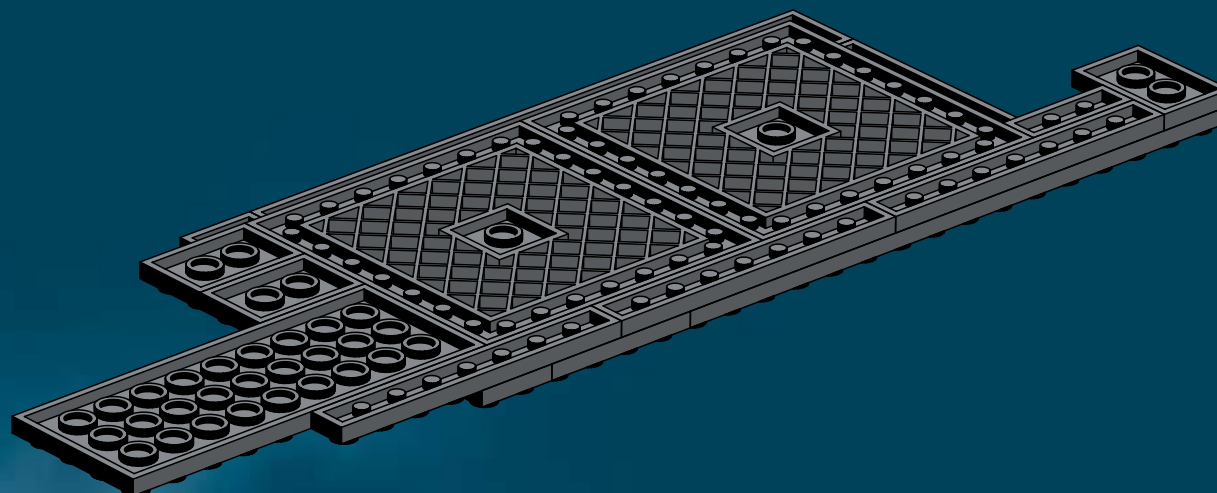

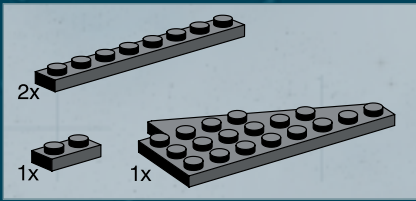

5

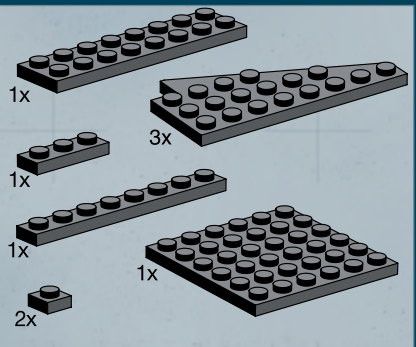
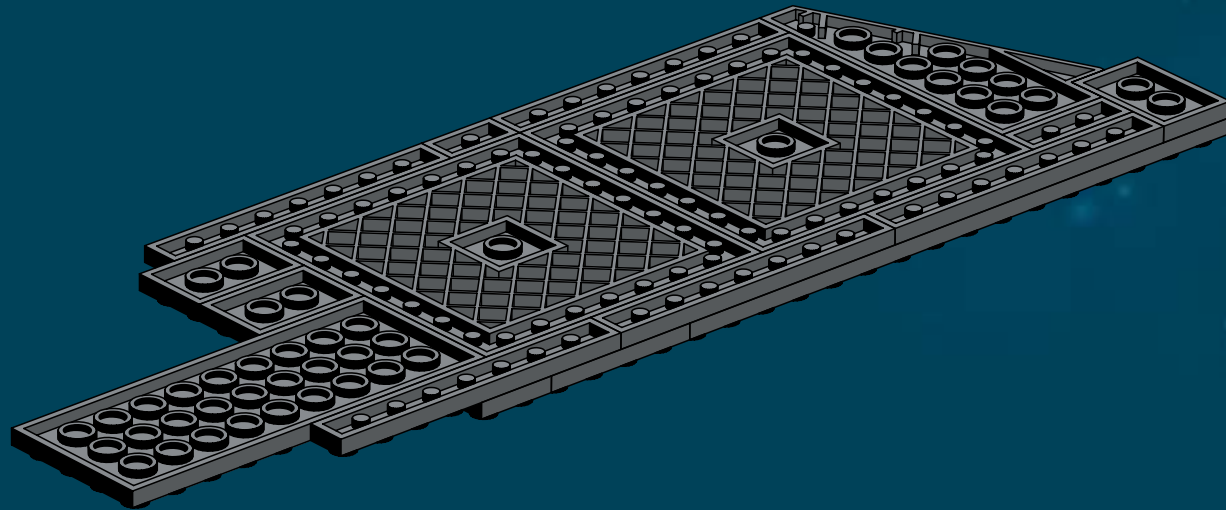

6

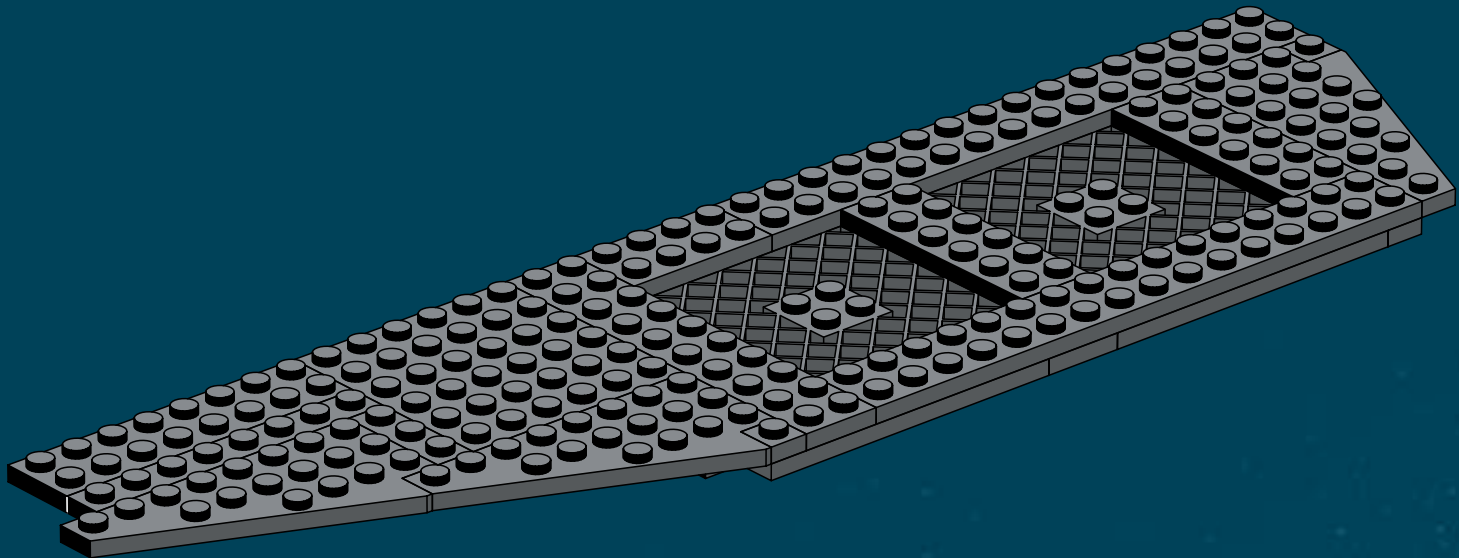



SIENAR FLEET SYSTEMS

TIE INTERCEPTOR™

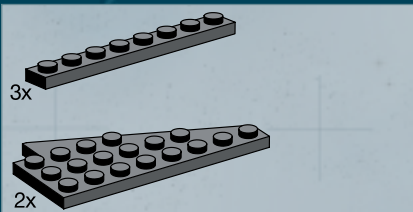

7

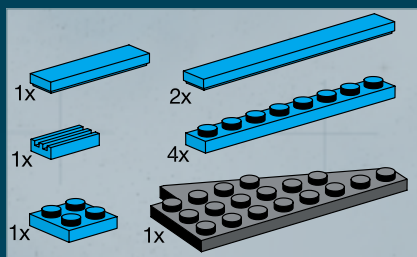
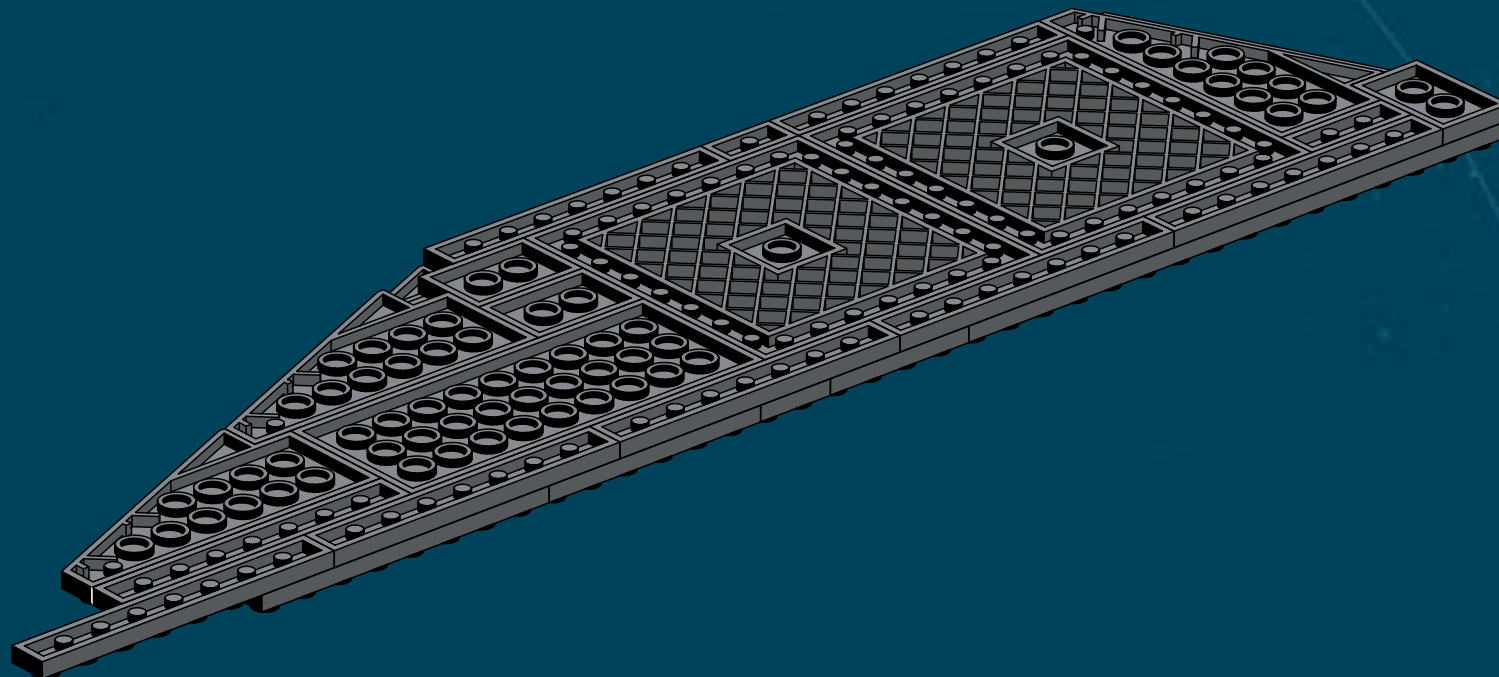

8

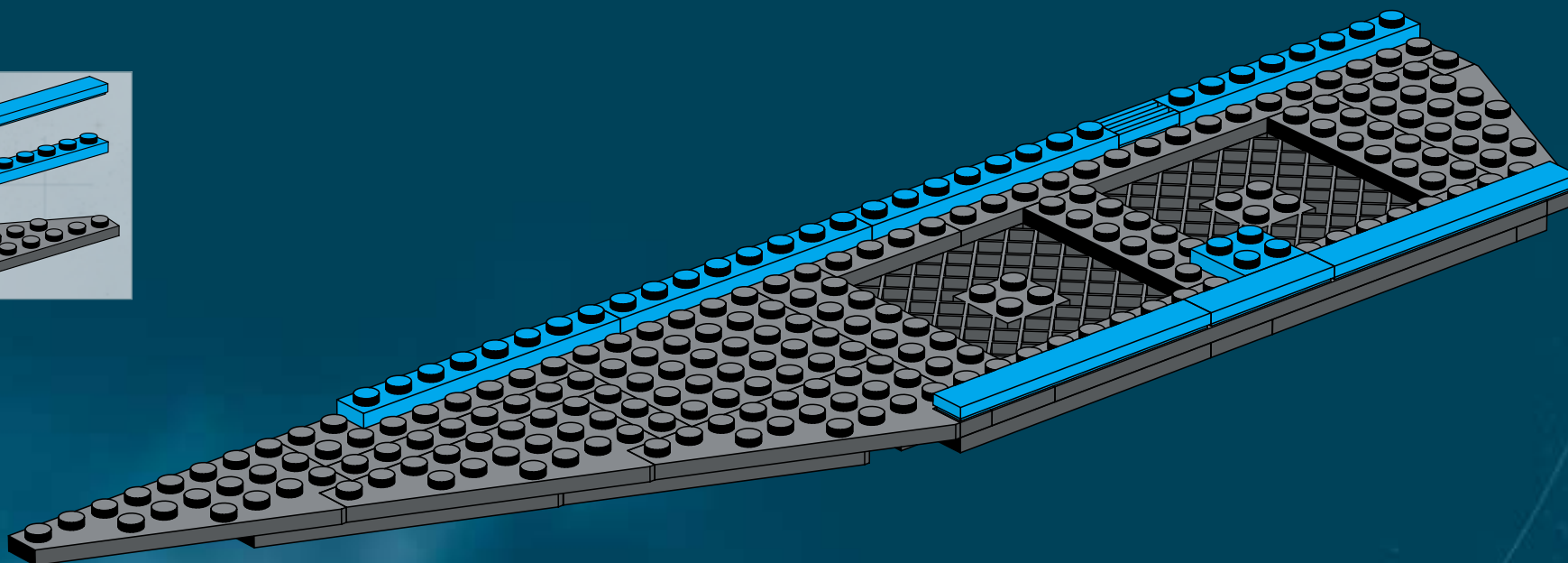

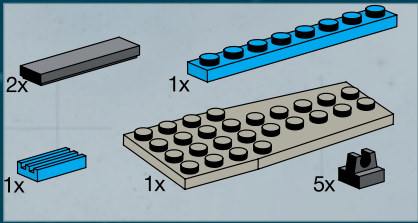

9

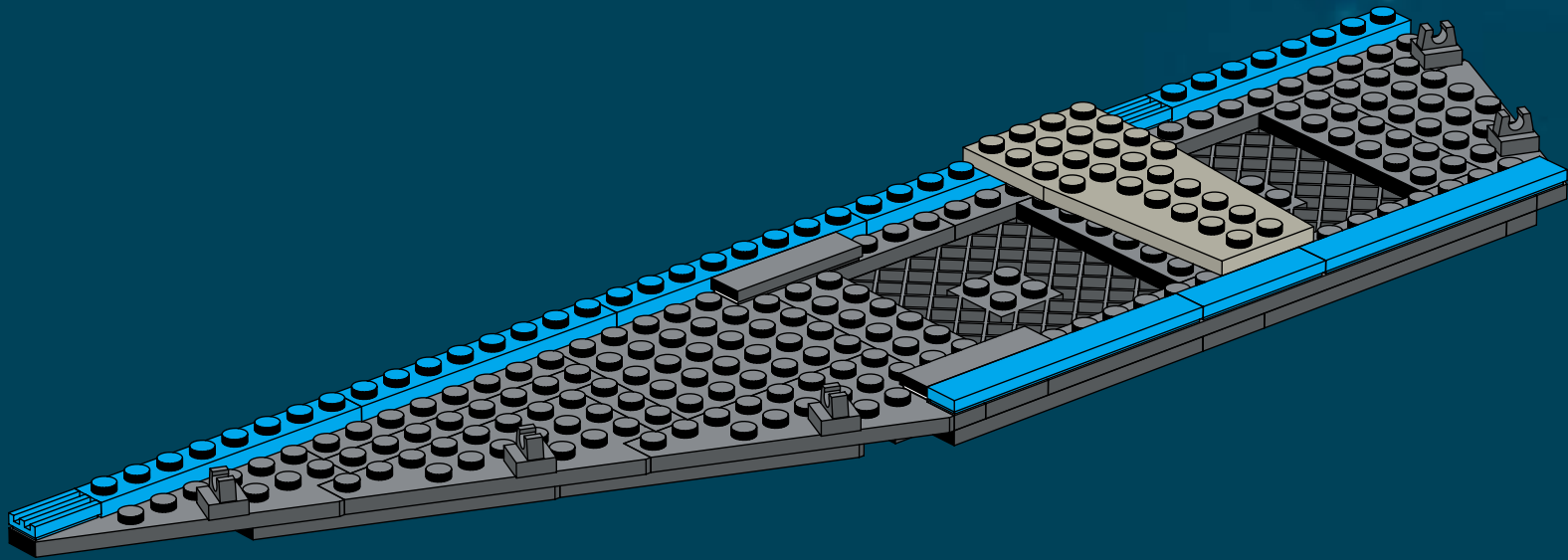



SIENAR FLEET SYSTEMS

TIE INTERCEPTOR™

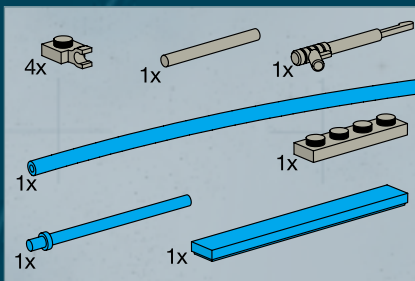

10

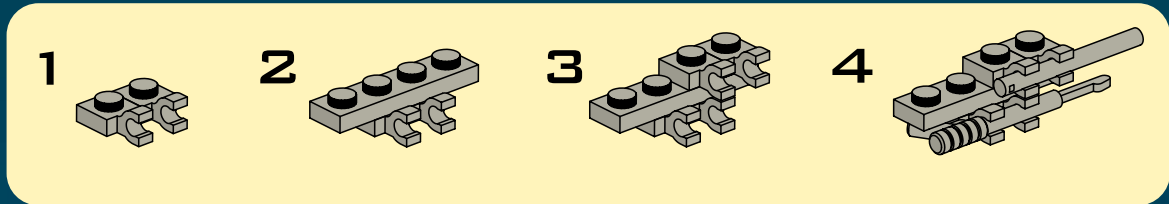
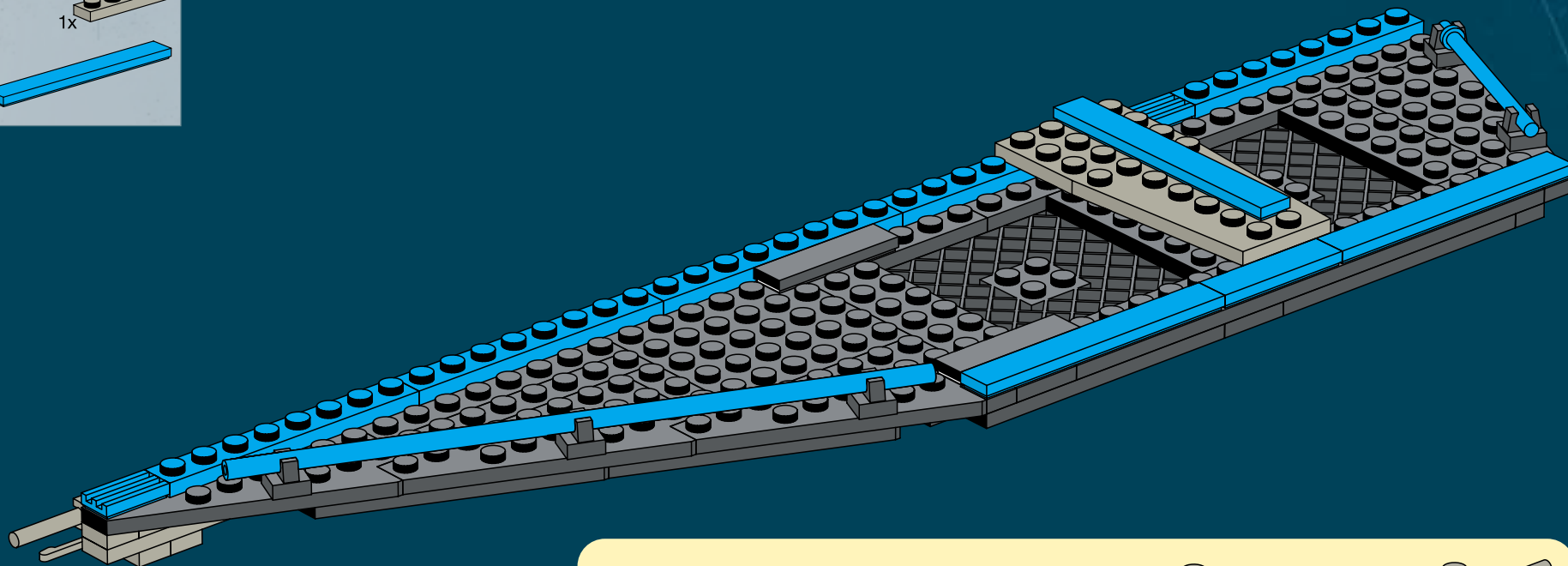

11

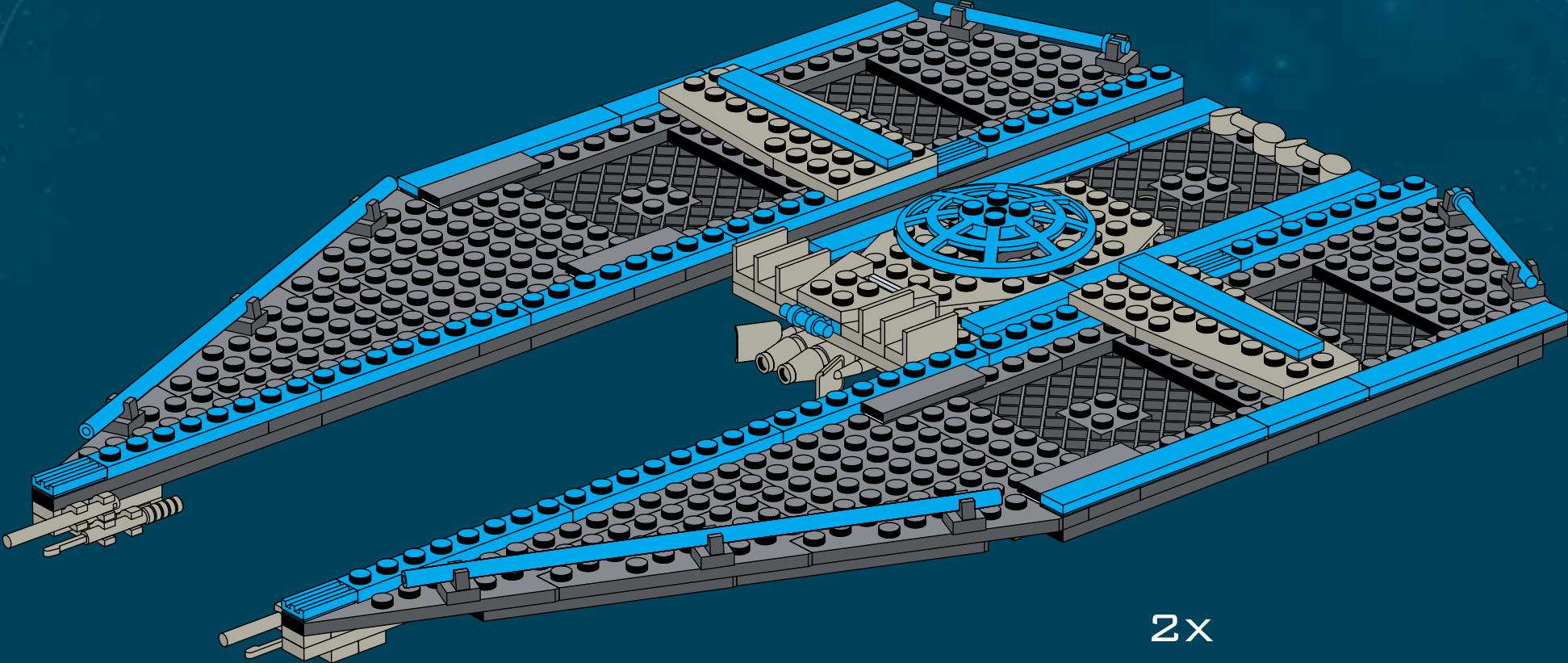



SIENAR FLEET SYSTEMS

TIE INTERCEPTOR™

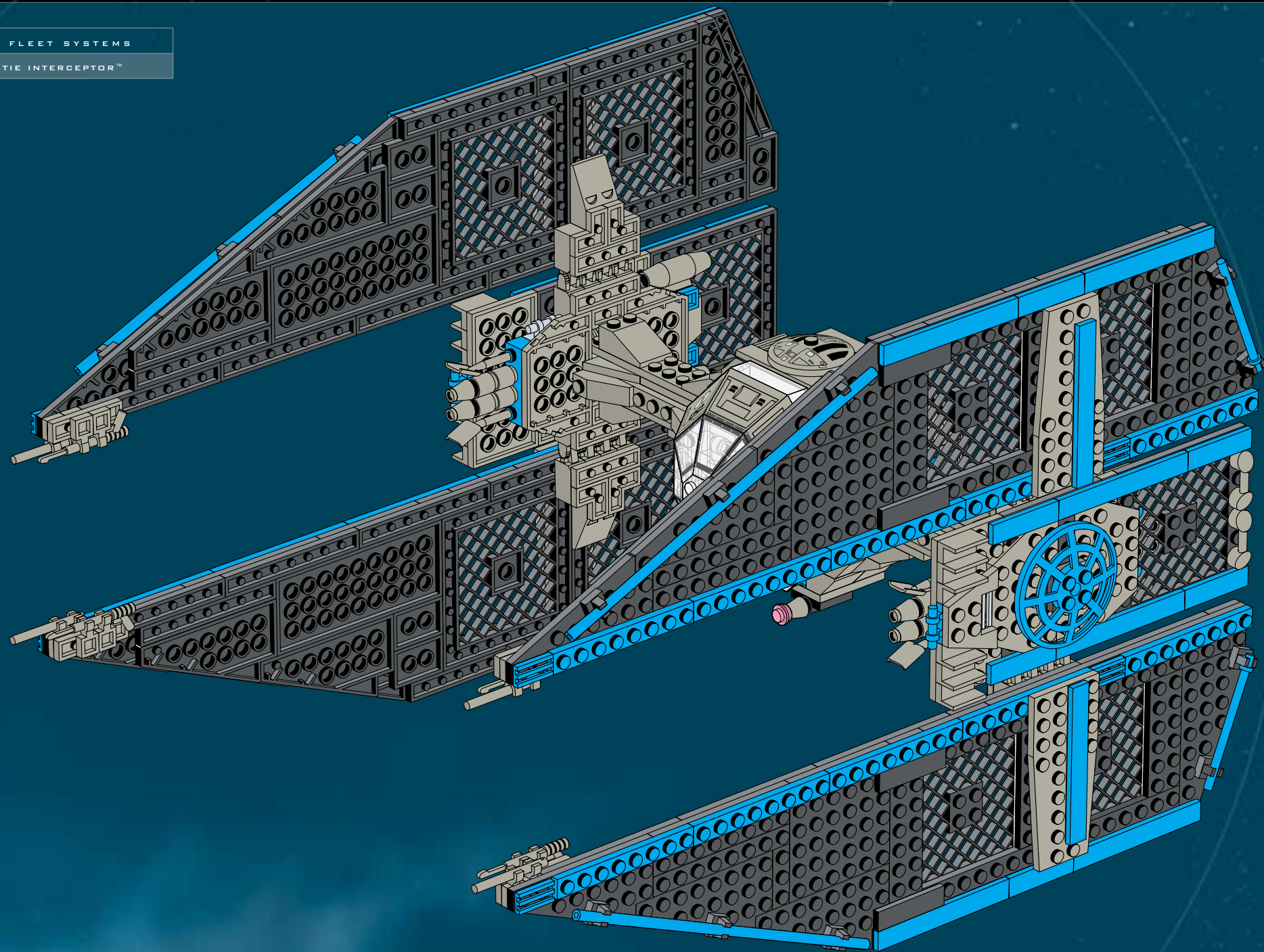



COCKPIT - PAGES 4-15

CENTER WING - PAGES 16-21

LOWER WING - PAGES 22-28

UPPER WING - PAGES 29-36

PEDESTAL - PAGES 37-45

INFO - PAGES 46-47

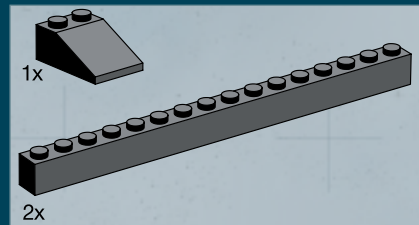
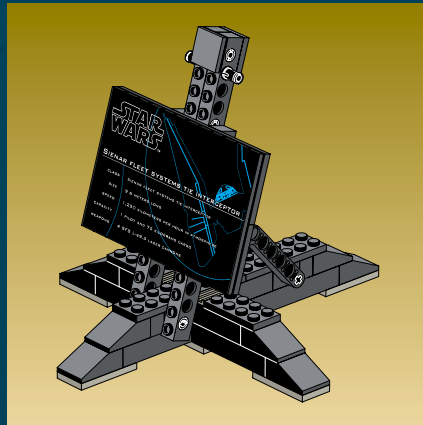

1

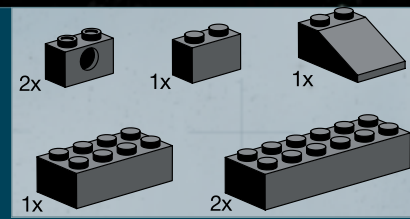
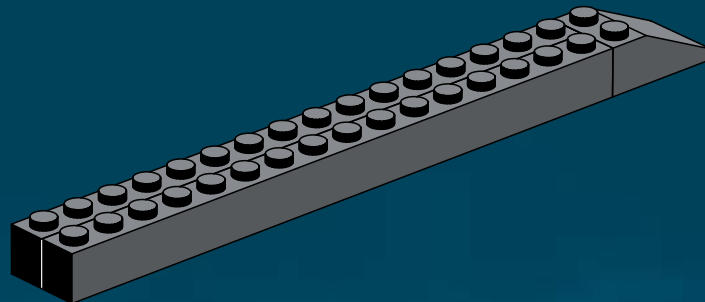

2

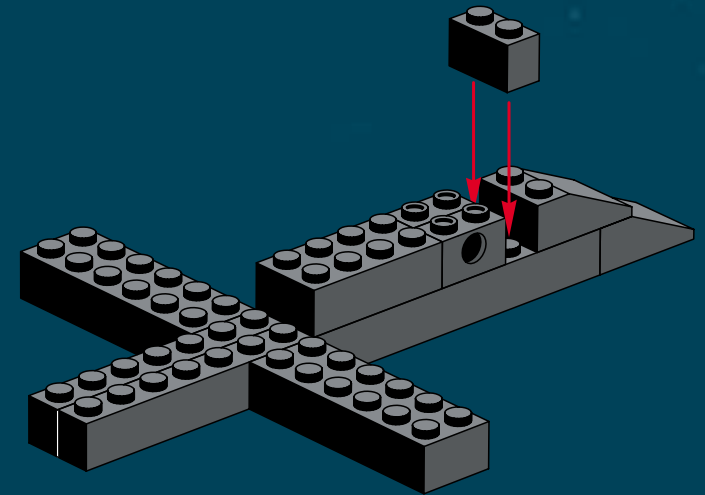



SIENAR FLEET SYSTEMS

TIE INTERCEPTOR™

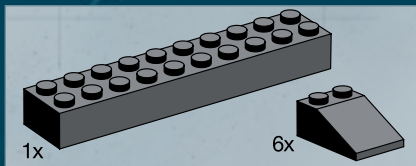

3

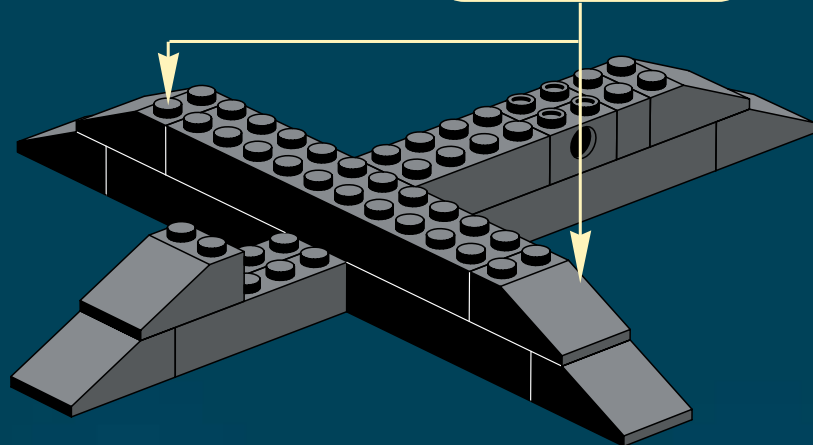
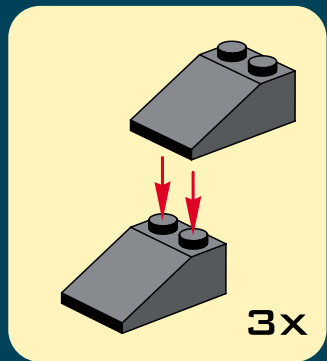

4

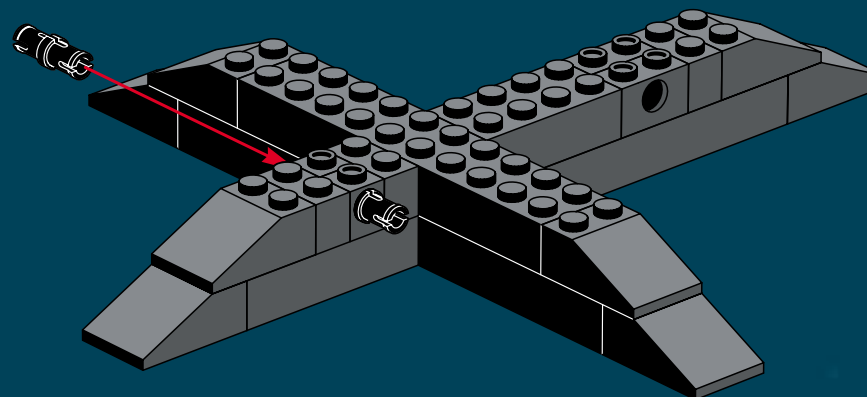

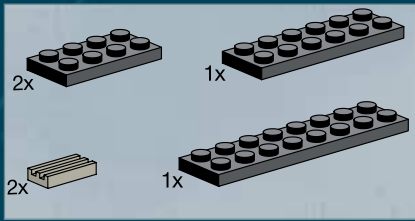

5

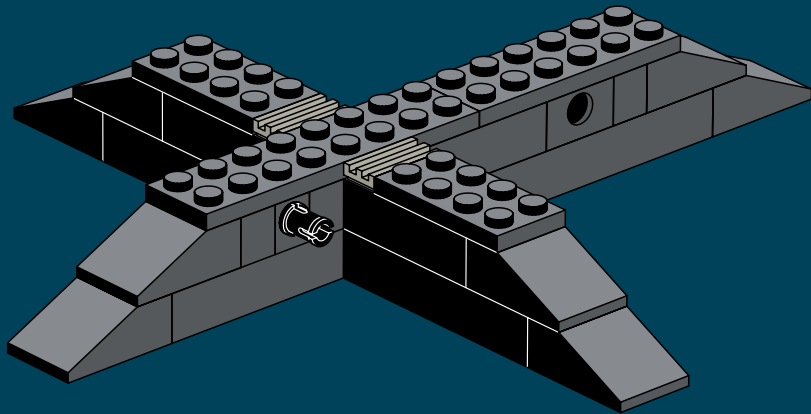

6

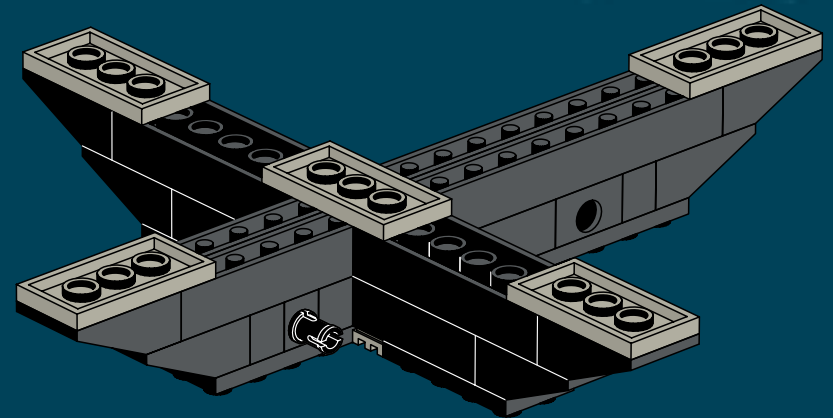

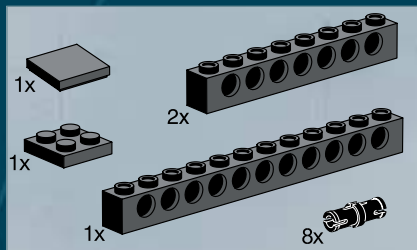

7

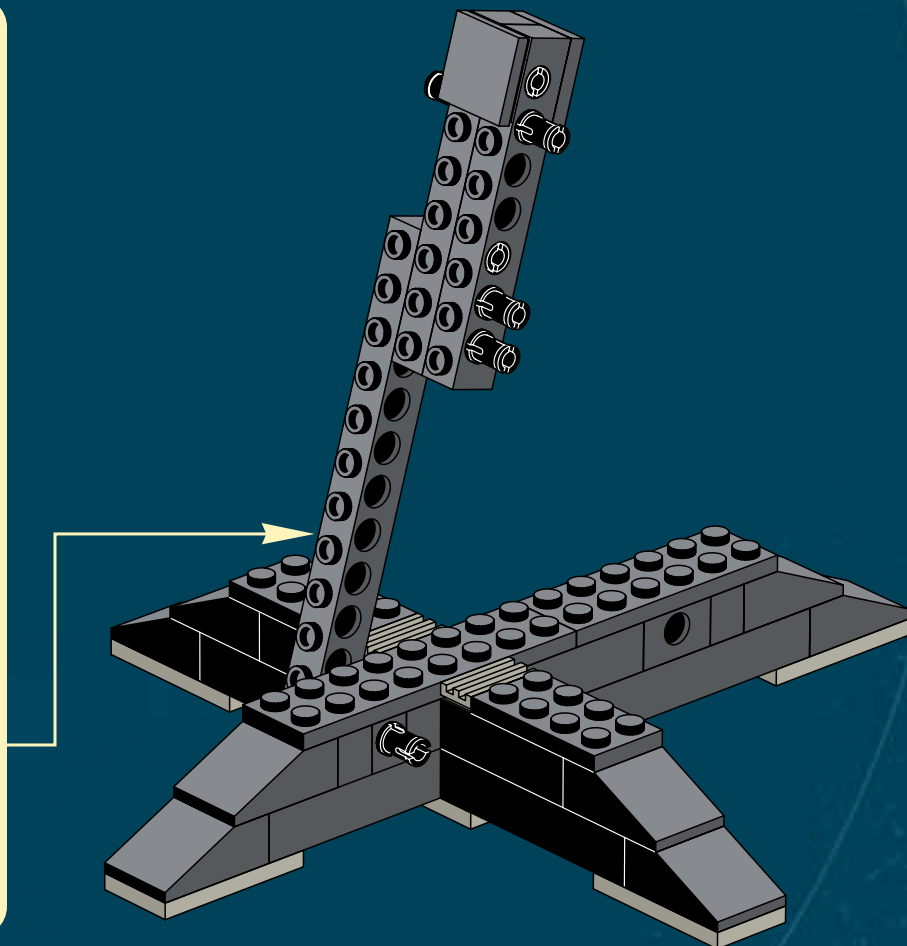
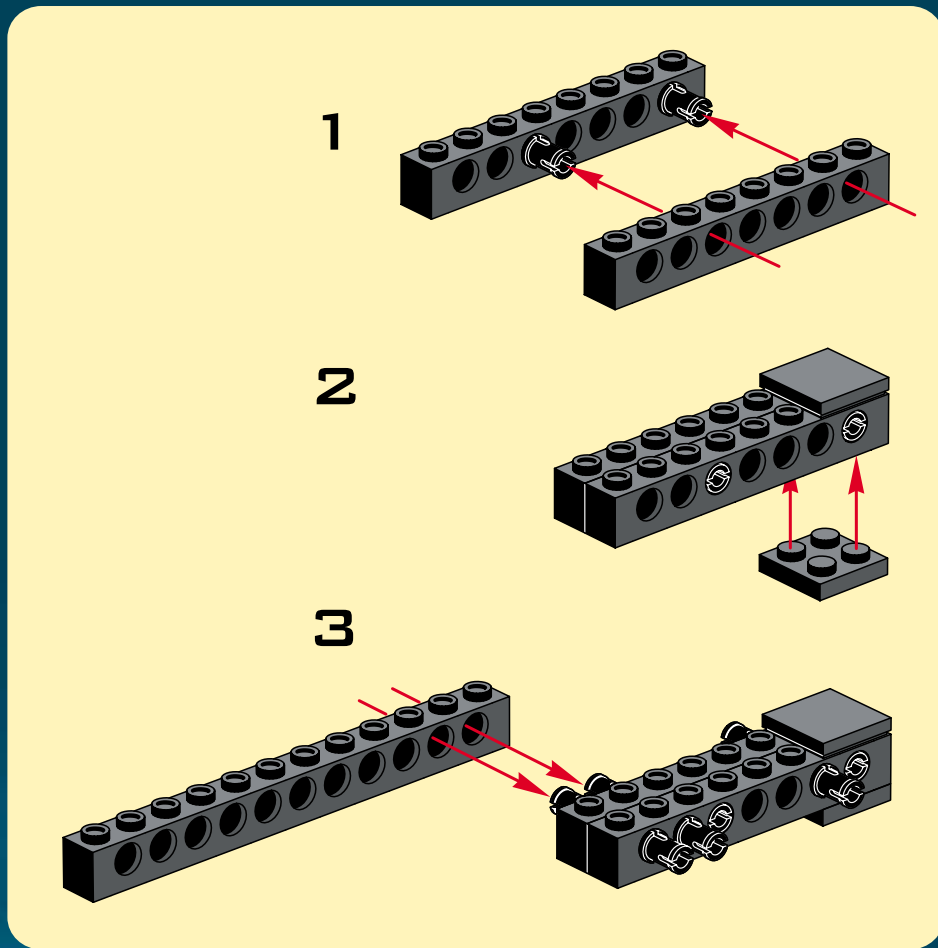

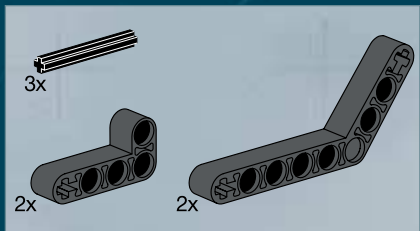

8

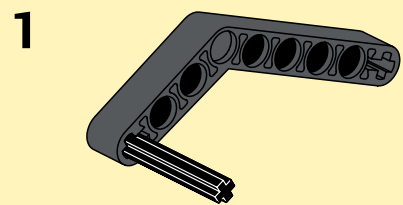

2

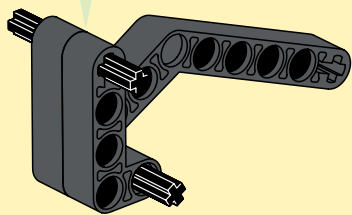
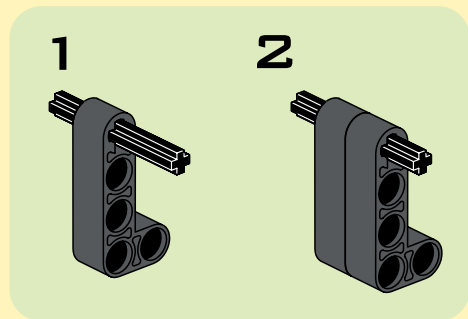

3

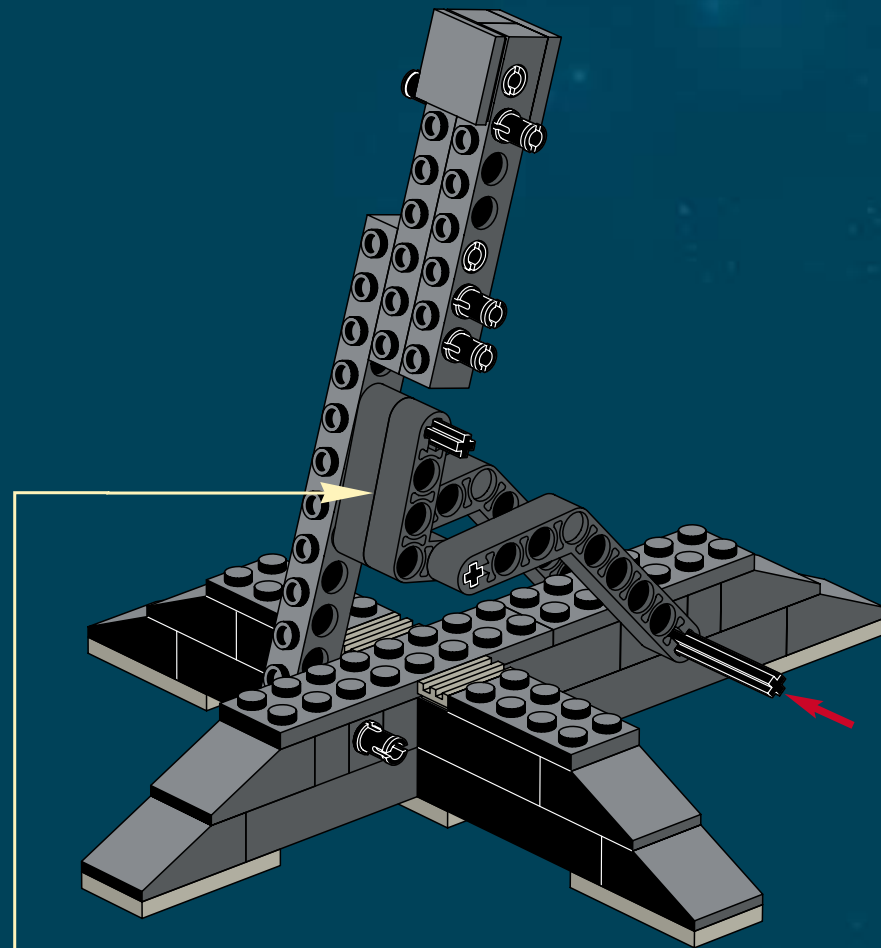
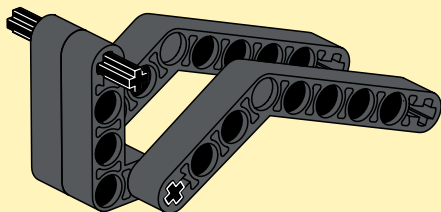



SIENAR FLEET SYSTEMS

TIE INTERCEPTOR™

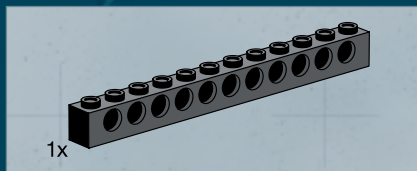

1x

9

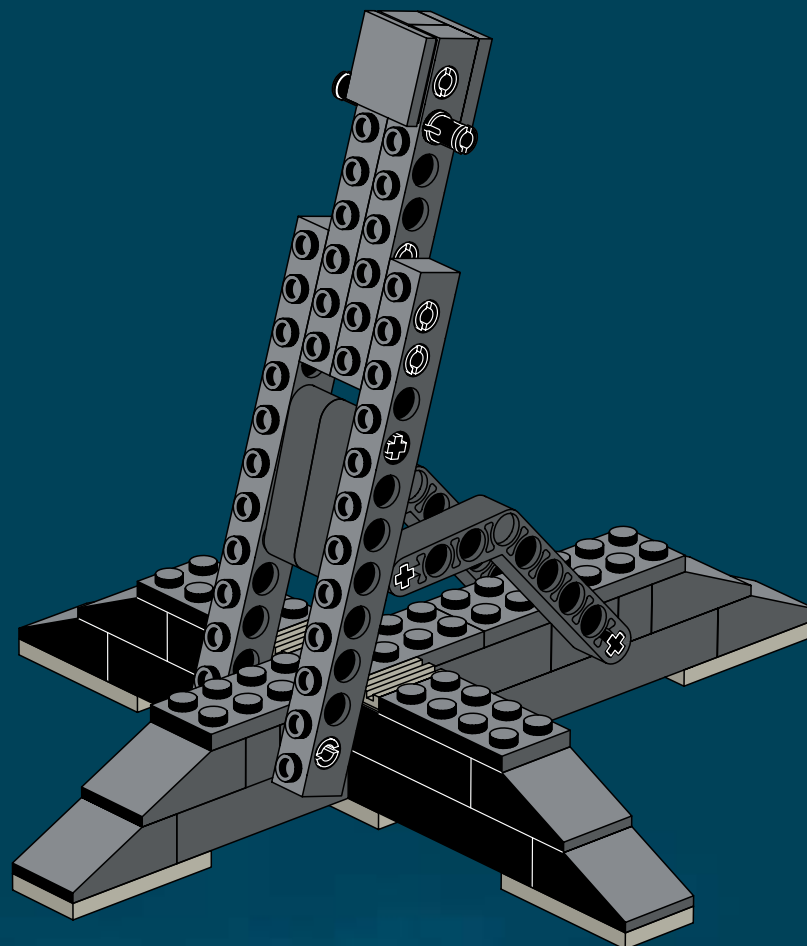

1x

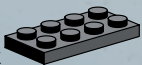

10

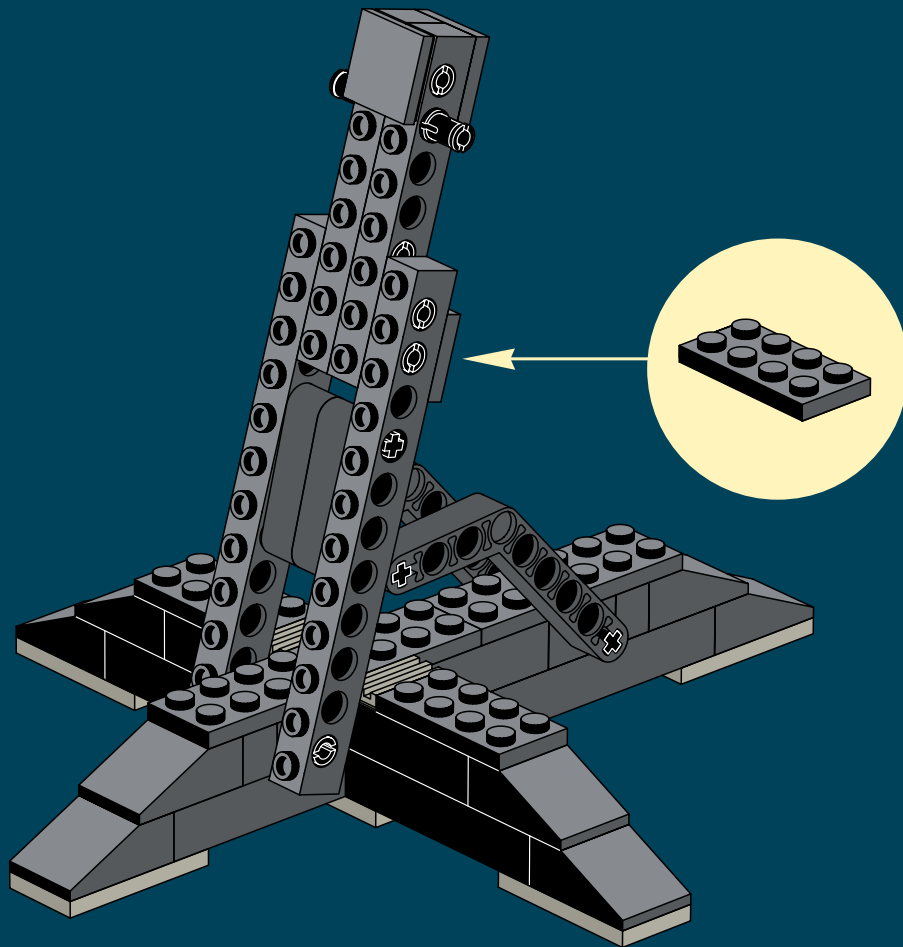

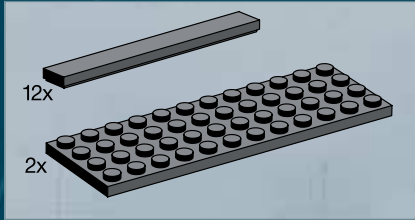

11

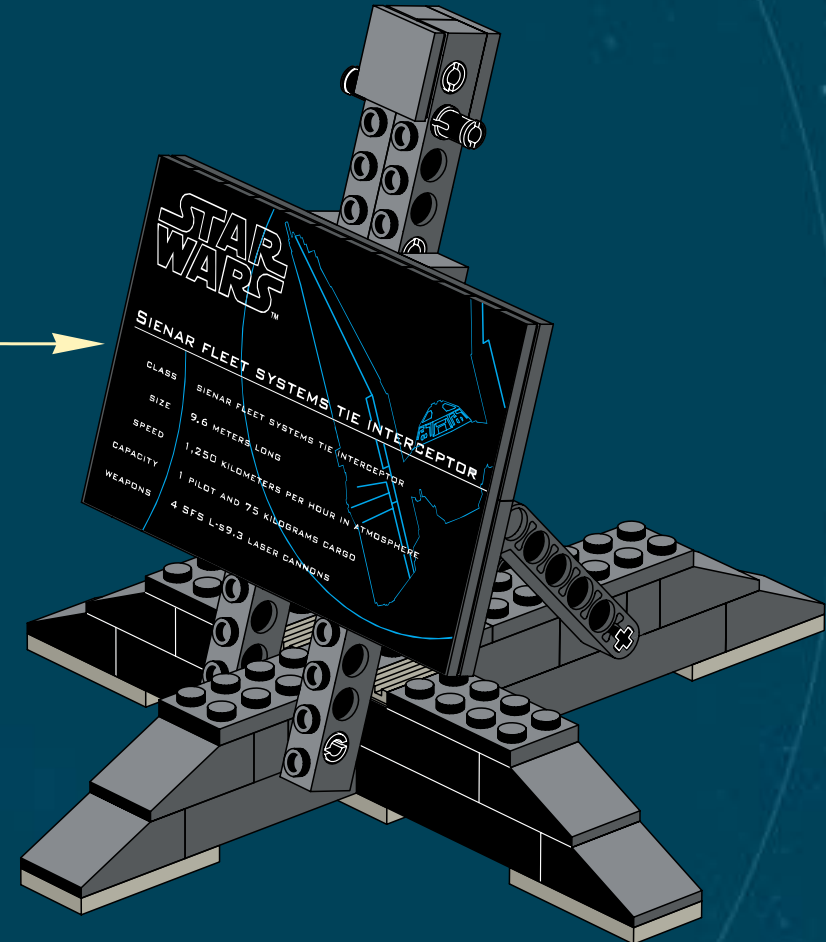
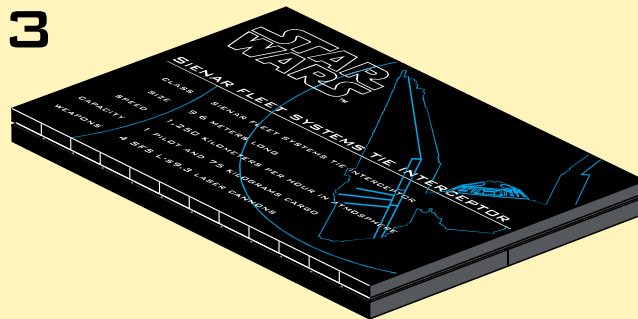
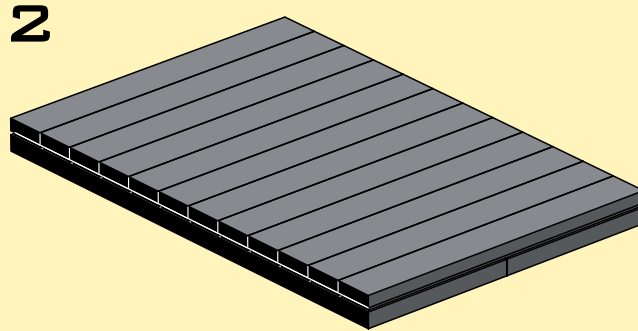
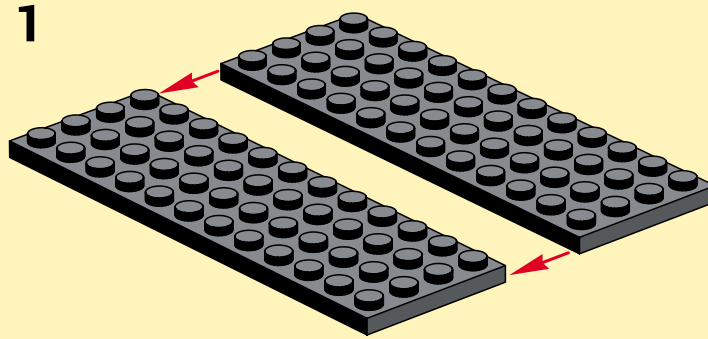

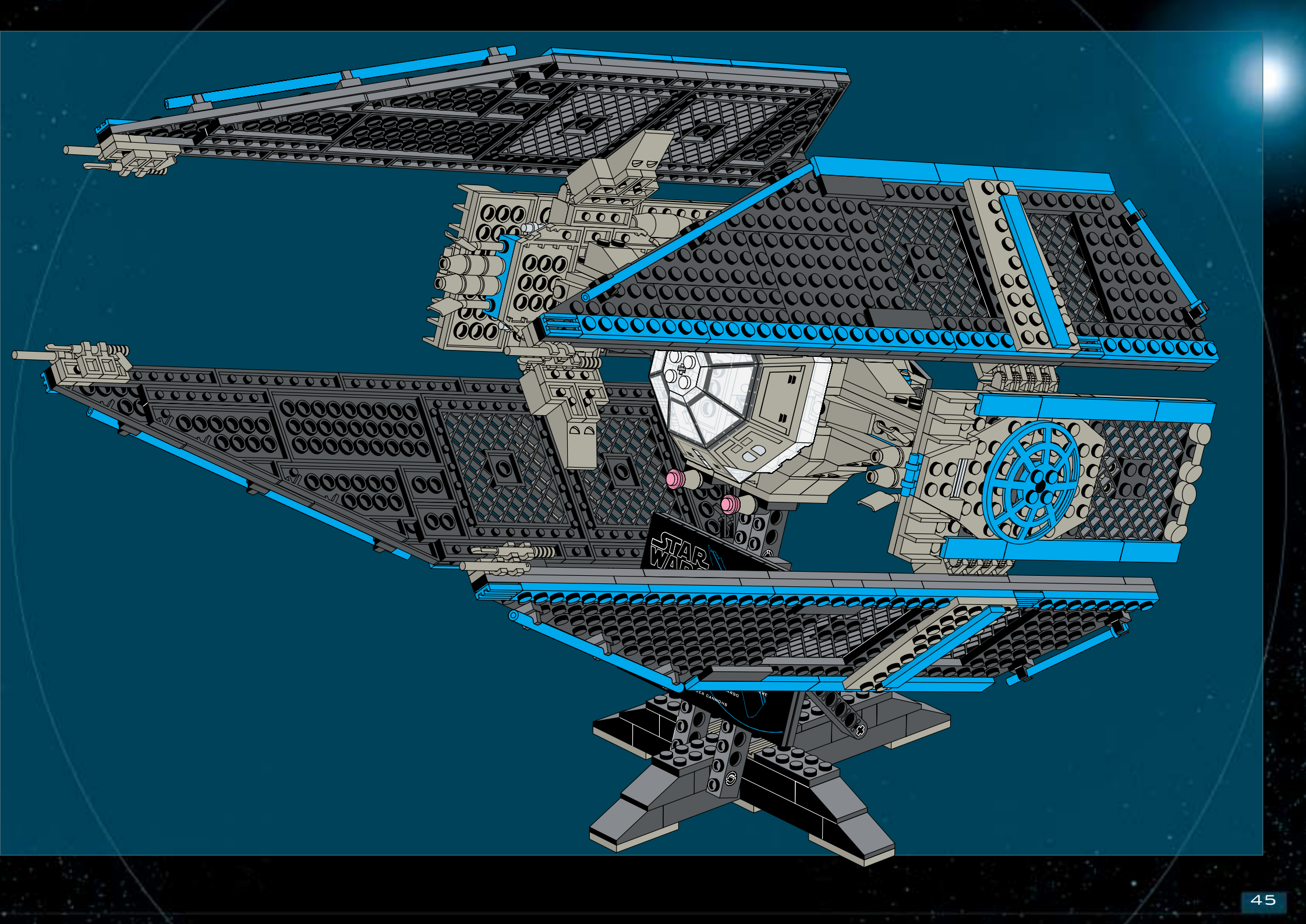

SIENAR FLEET SYSTEMS

PRODUCTION HISTORY

- DARTH VADER'S TIE FIGHTER (TIE ADVANCED X1 PROTOTYPE)
- IMPERIAL LANDING CRAFT (SENTINEL-CLASS LANDING CRAFT, MANUFACTURED WITH CYGNUS SPACEWORKS)
- INTERDICTOR CRUISER (IMMOBILIZER 41B)
- LAMBDA-CLASS SHUTTLE
- SCIMITAR ASSAULT BOMBER
- SKIPRAY BLASTBOAT (GAT-12H)
- TIE BOMBER
- TIE DEFENDER
- TIE/D FIGHTER
- TIE FIGHTER (TIE/IN)
- TIE INTERCEPTOR™

SIENAR FLEET SYSTEMS INFO

SIENAR FLEET SYSTEMS (SFS) IS A PRIME MILITARY CONTRACTOR AND THE MANUFACTURER OF THE EMPIRE'S TIE FIGHTERS. A SUBSIDIARY OF SANTHE/SIENAR TECHNOLOGIES, SFS IS ACKNOWLEDGED AS ONE OF THE DOMINANT FIGHTER MANUFACTURERS IN THE GALAXY, ALTHOUGH THE SUCCESS OF THE SKIPRAY BLASTBOAT AND THE INTERDICTOR CRUISER MAKES THE COMPANY A MAJOR PLAYER IN THE CAPITAL SHIP MARKET, AS WELL.

SIENAR'S TIE INTERCEPTOR IS THE EMPIRE'S NEWEST ADDITION TO ITS TIE SERIES OF STARFIGHTERS.

AFTER THE DESTRUCTION OF THE DEATH STAR AT THE BATTLE OF YAVIN, IMPERIAL COMMANDERS AND PILOTS CALLED A MEETING WITH TOP IMPERIAL DESIGNERS TO DECIDE HOW BEST TO COUNTER THE UNEXPECTEDLY HIGH LEVEL OF REBEL DARING AND INGENUITY AS EVIDENCED BY THE PERFORMANCE OF REBEL ALLIANCE PILOTS AND MACHINES DURING THE COMBAT. AFTER MUCH DEBATE, THE PANEL CONCLUDED THAT THE EMPIRE NEEDED A FIGHTER THAT WAS FASTER, MORE MANEUVERABLE, AND MORE LETHAL - A FIGHTER, IN SHORT, THAT COULD FAR SURPASS THE REBELLION'S X-WINGS AND Y-WINGS.

THE NUMBER OF TIE INTERCEPTORS THAT HAVE ACTUALLY COME OFF THE ASSEMBLY LINE IS UNKNOWN, BUT SOURCES SPECULATE THAT A SIZEABLE FORCE IS READY TO FLY.

SIENAR'S MOST RECENT DESIGN IS THE SCIMITAR ASSAULT BOMBER WHICH COMBINED THE BEST FEATURES OF THE TIE INTERCEPTOR, THE TIE BOMBER, AND ALLIANCE STARFIGHTERS TO CREATE A DEDICATED ASSAULT BOMBER, YET ANOTHER STUNNING SUCCESS FOR THE COMPANY.

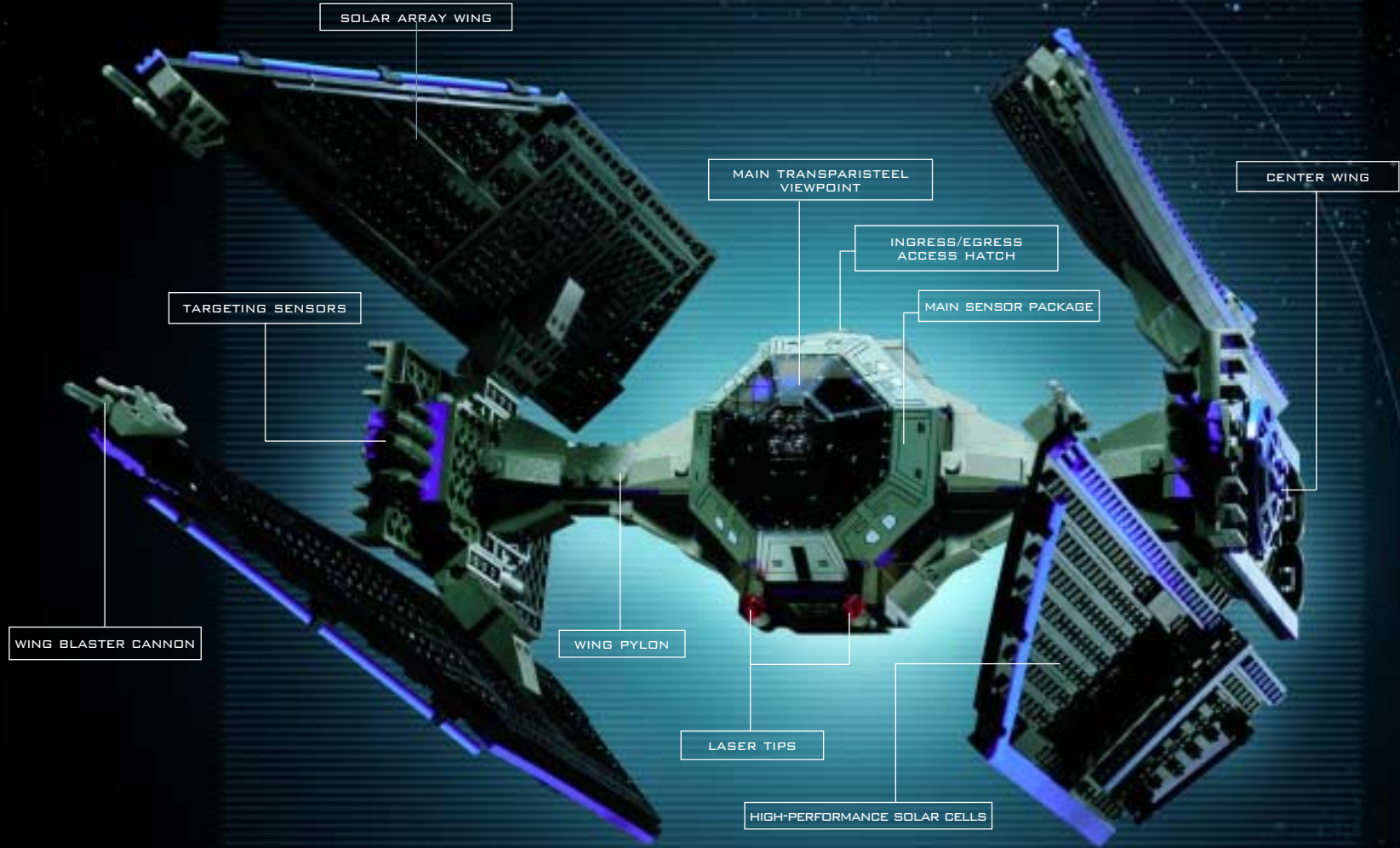

TIE INTERCEPTOR™ INFO

THE MAXIMUM SPEED OF THE NEW TIE INTERCEPTOR WAS ENHANCED BY INCREASING THE SIZE OF THE STANDARD TWIN ION ENGINES AND PROVIDING THE NECESSARY ADDITIONAL POWER INPUT BY INCREASING THE SIZE OF THE SOLAR PANELS. THIS WAS AVOIDED IN THE ORIGINAL TIE SERIES FIGHTERS TO MAXIMIZE PILOT VISIBILITY, BUT IN THE INTERCEPTOR THE PANELS HAVE BEEN STREAMLINED AND RESHAPED. THEY UTILIZE THE NEW BENT-WING FORMAT FOUND ON VADER'S PROTOTYPE CRAFT, BUT ARE DAGGER-SHAPED INSTEAD OF RECTANGULAR TO SOLVE THE VISIBILITY PROBLEM.

FIREPOWER WAS INCREASED BY FORWARD-MOUNTING FOUR LASER CANNONS ON THE TIPS OF THE MODIFIED DAGGER-LIKE SOLAR PANELS AND DISPENSING WITH THE TWIN CHIN-MOUNTED CANNON FOUND ON THE STANDARD TIE FIGHTER.

MANEUVERABILITY WAS HARD TO IMPROVE UPON; THE TIE SERIES ALREADY IS ONE OF THE MOST MANEUVERABLE CRAFTS AVAILABLE. BUT A NEW SYSTEM OF ION STREAM PROJECTION WAS DEVELOPED THAT ALLOWS THE PILOT TO EXECUTE TIGHTER TURNS AND ROLLS, AND THE BENT-WING AND LARGER PANELS COMPENSATE FOR ANY LOSS IN STABILIZATION.

ALT. MODEL / TOPVIEW

ALTERNATIVE FIGHTER DESIGN

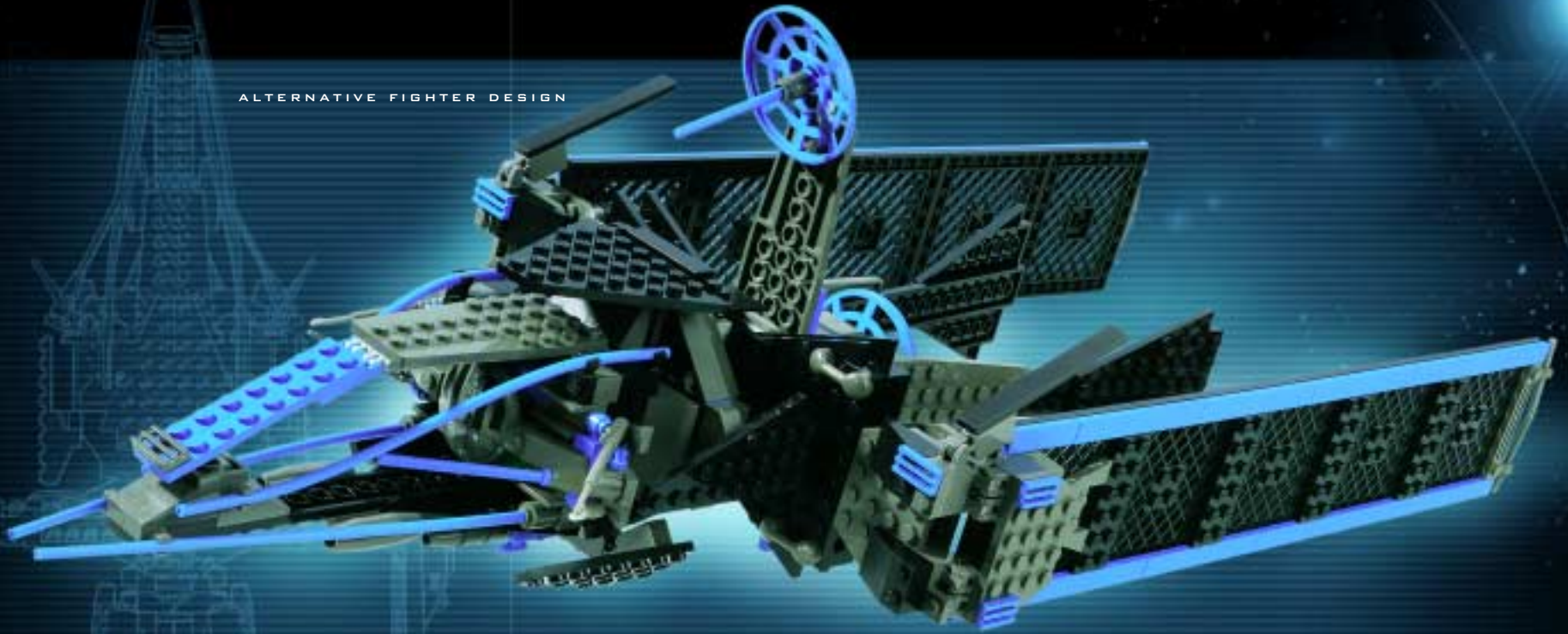

WEB LINKUP - FOR FURTHER INFO

www.lego.com/ultimate_collector

ALT. MODEL / FRONTVIEW



©2000 LEGO Group.
 The LEGO logo and the minifigure are trademarks of the LEGO Group.

© Lucasfilm Ltd. & TM. All rights reserved.
 Used under authorization.

7 1 8 1



TIE INTERCEPTOR™

ULTIMATE COLLECTOR SERIES

STAR WARS

SIENAR FLEET SYSTEMS TIE INTERCEPTOR

CLASS	SIENAR FLEET SYSTEMS TIE INTERCEPTOR
PILOT	1 (PILOT AND 75 KILOGRAMS CARGO)
WEAPONS	4 SFS L'90-3 LASER CANNONS
REAL SIZE	9.6 METERS LONG
MODEL SIZE	34 CM LONG 19 CM TALL WITHOUT PEDESTAL 26 CM WIDE

CLASS SIENAR FLEET SYSTEMS TIE INTERCEPTOR

SPEED 1250 KILOMETRES PER HOUR IN ATMOSPHERE

CAPACITY 1 PILOT AND 75 KILOGRAMS CARGO

WEAPONS 4 SFS L'90-3 LASER CANNONS

REAL SIZE 9.6 METERS LONG

1:28

MODEL SIZE 34 CM LONG
19 CM TALL WITHOUT PEDESTAL
26 CM WIDE

SIENAR FLEET SYSTEMS

TIE INTERCEPTOR™

DESIGNED AND BUILT BY SIENAR FLEET SYSTEMS, THE TIE FIGHTER COMES IN A VARIETY OF SPECIAL ASSIGNMENT MODELS.

THE ORIGINAL TIE STARFIGHTER WAS DEVELOPED WHILE SFS WAS STILL REPUBLIC SIENAR SYSTEMS. THE UPGRADED TIE WAS PRODUCED AFTER THE COMPANY CAME UNDER THE DIRECT CONTROL OF THE IMPERIAL NAVY. THE TIE IN IS THE STANDARD FULL-SCALE TIE FIGHTER. IT CARRIES A SEPARATE POWER GENERATOR FOR ITS LASER CANNONS.

TWIN ION ENGINES PROVIDE THE PROPULSION FOR THESE FIGHTERS, WHICH ARE CONTROLLED BY A SINGLE PILOT.

