

The LEGO logo is displayed in its characteristic white font with a black outline, set against a red rectangular background.

BIONICLE

71306



WARNING: CHOKING HAZARD.
Toy contains small parts and a small ball.
Not for children under 3 years.



LEGO.com/bionicle





AVERTISSEMENT :

RISQUE D'ÉTOUFFEMENT. Le jouet contient des petites pièces ainsi qu'une petite boule. Il ne convient pas aux enfants de moins de 3 ans.



ADVERTENCIA:

PELIGRO DE ASFIXIA.

Juguete que contiene partes pequeñas y una pelota pequeña. No recomendado para niños menores de 3 años.

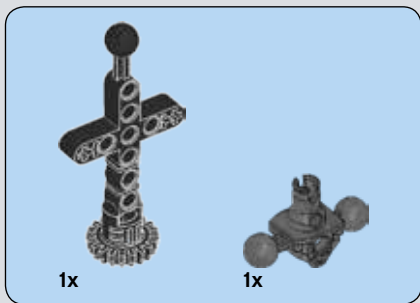

1

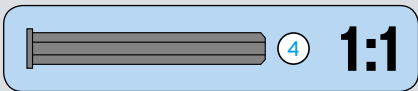
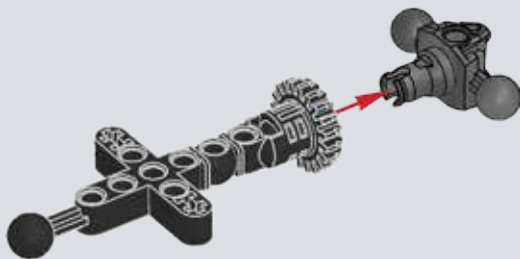

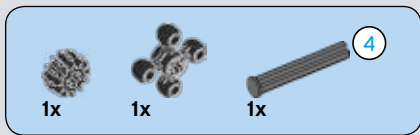

2

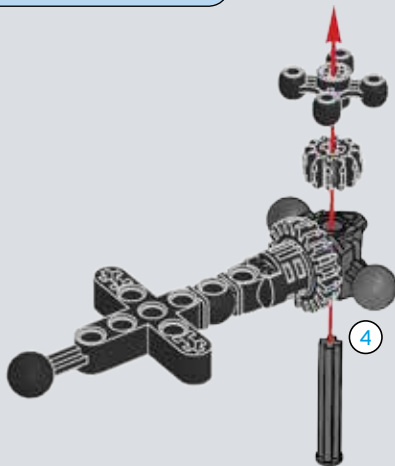

3

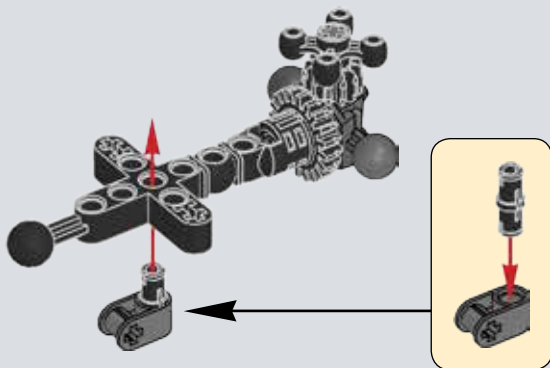



2x



1x

4

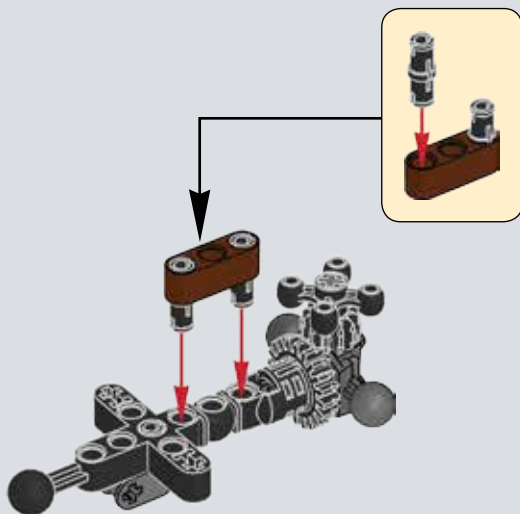

6

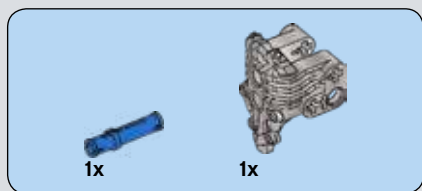

5

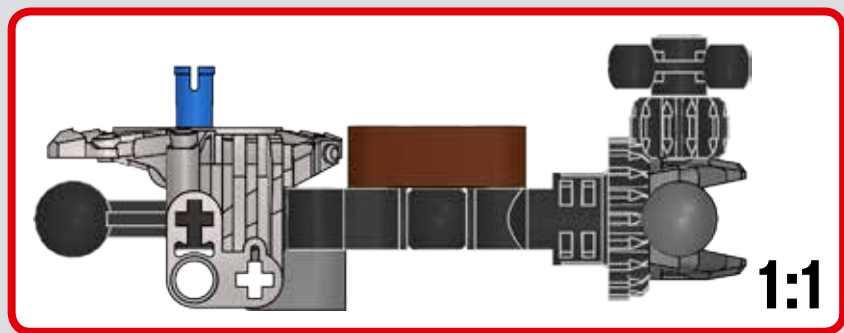
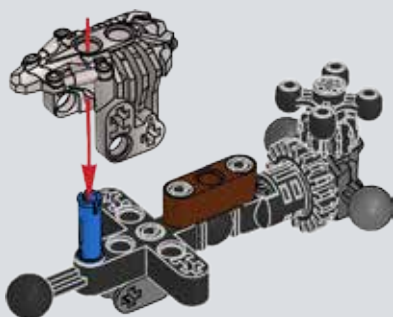

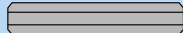
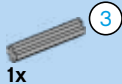

3

1:1

6

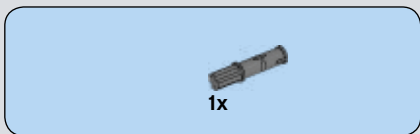
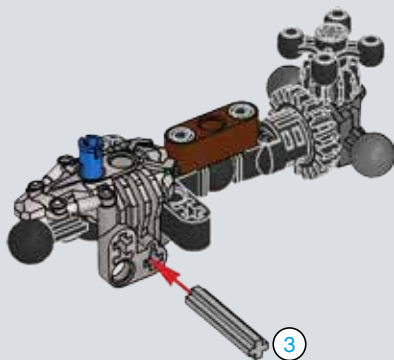

7

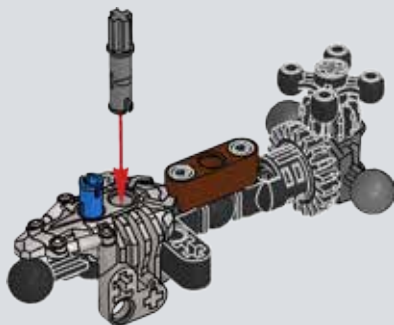

8

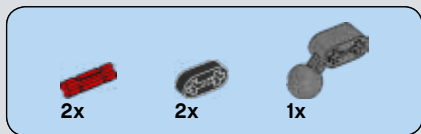

8

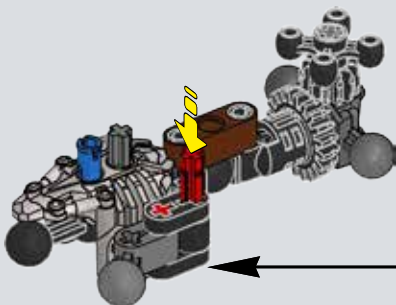

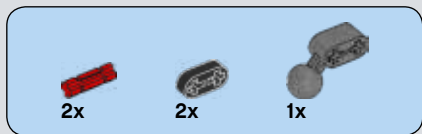

9

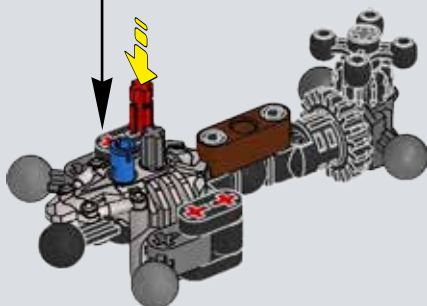
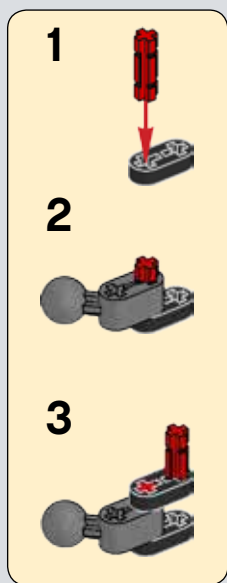

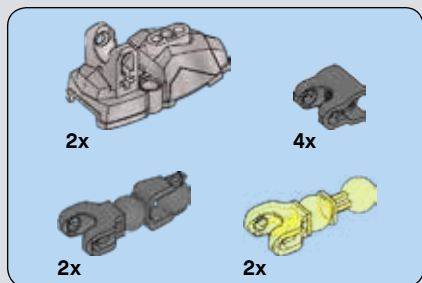

10

1

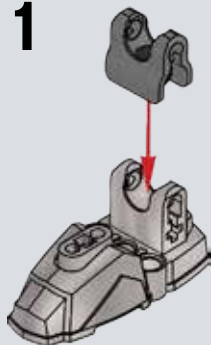

2

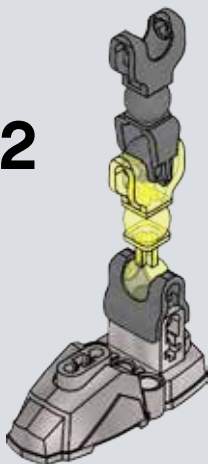

3

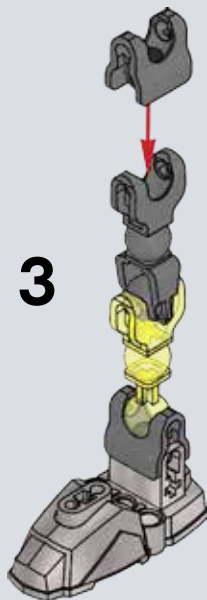

2x

11

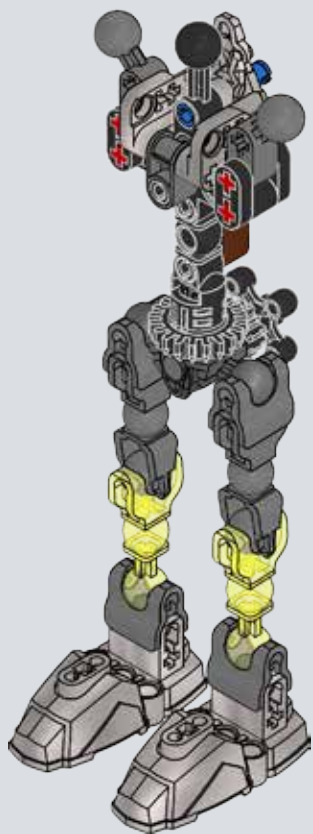

12



2x

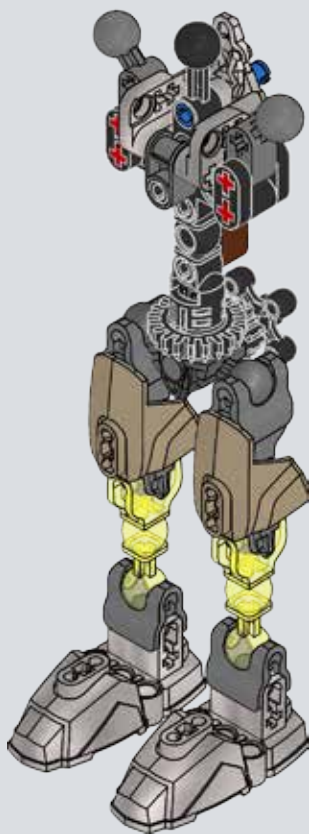



13

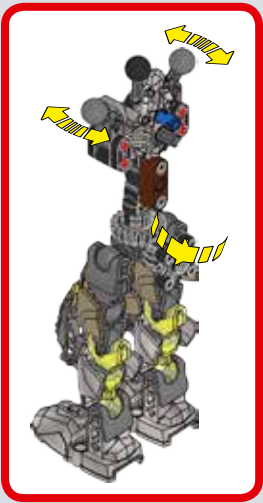
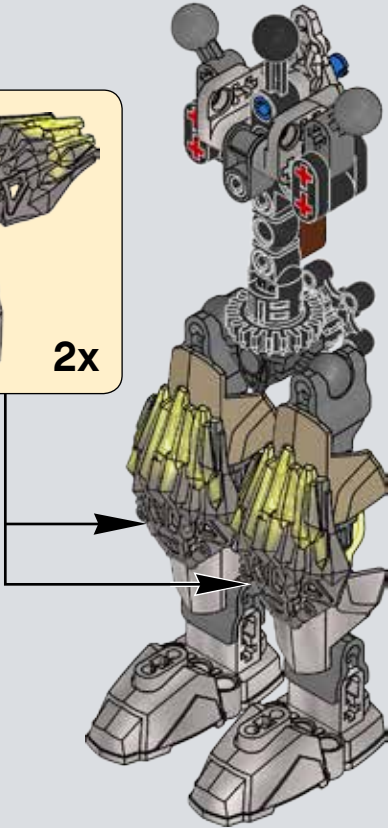
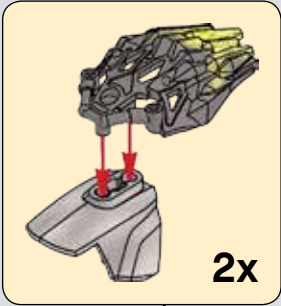

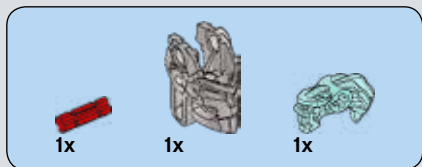

14

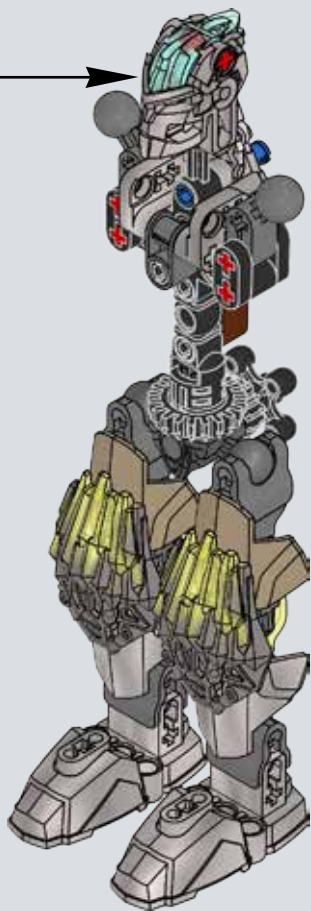
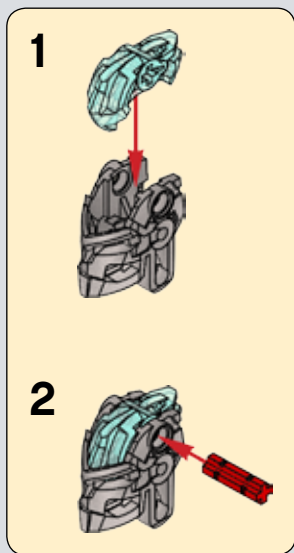



15

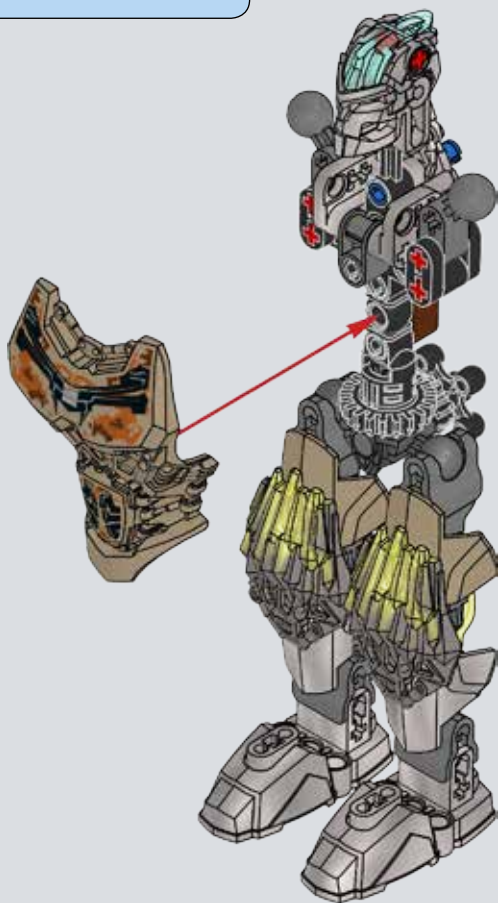



2x



2x



2x

16

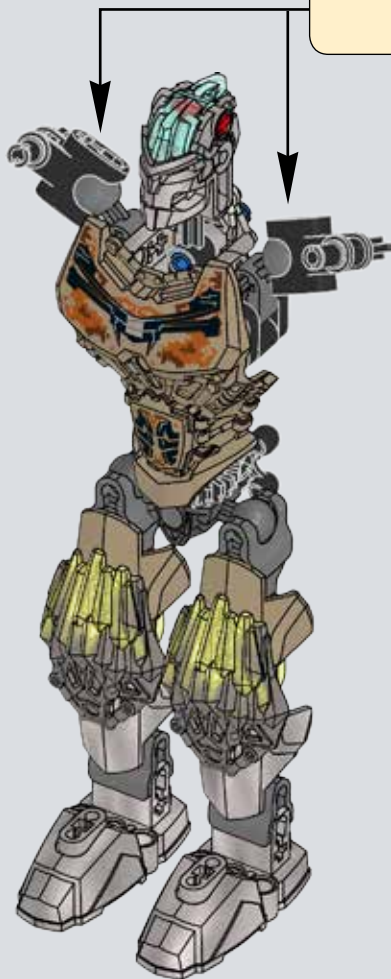

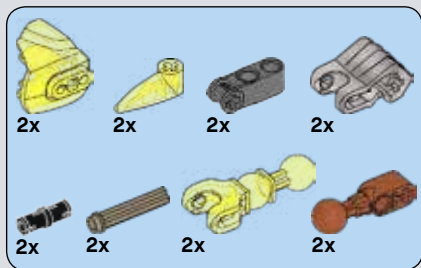

17

1

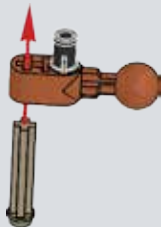

2

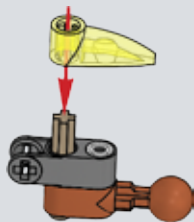

3

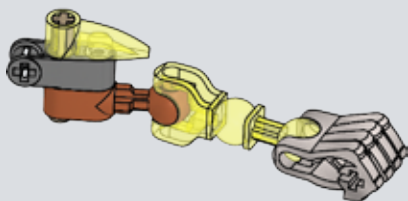

4

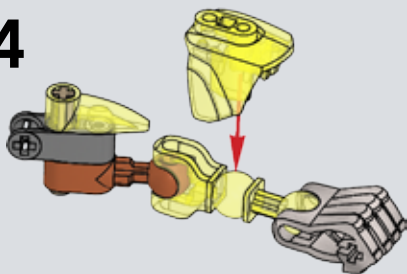

2x 17

18

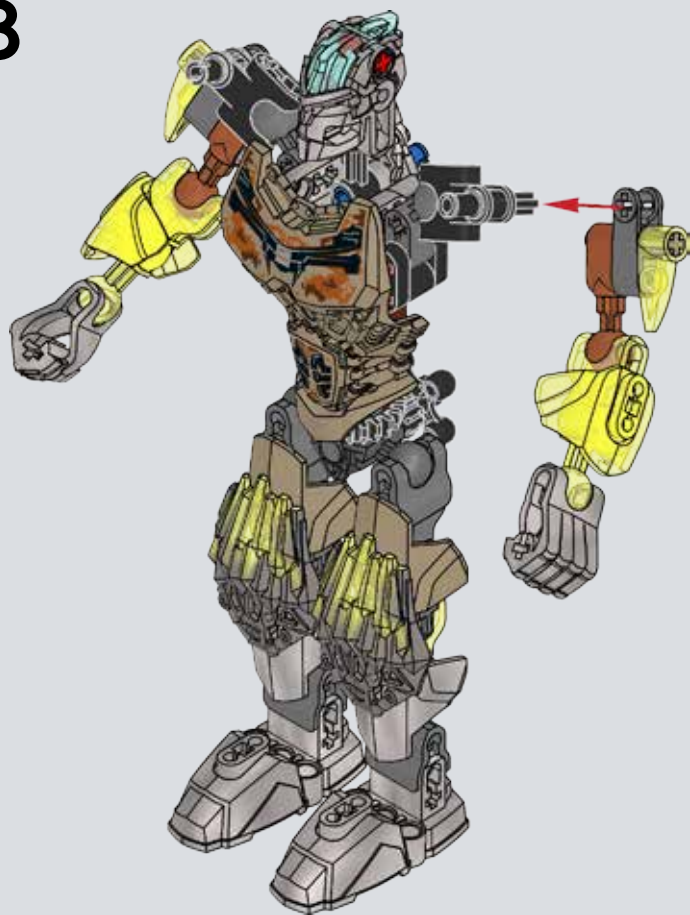



2x

19

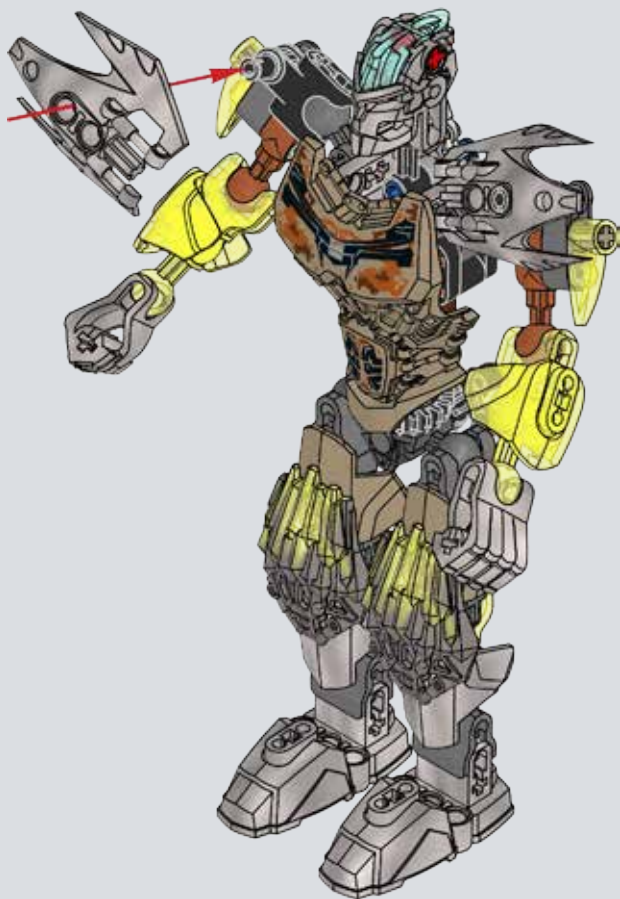

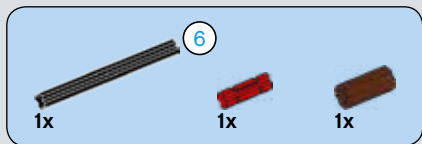

20

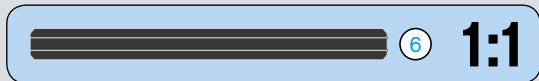
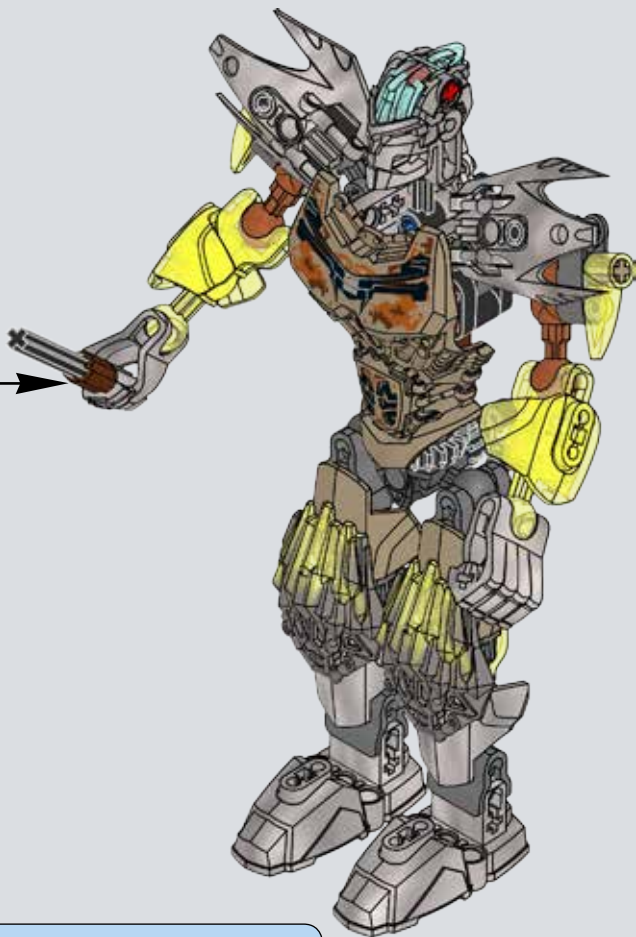
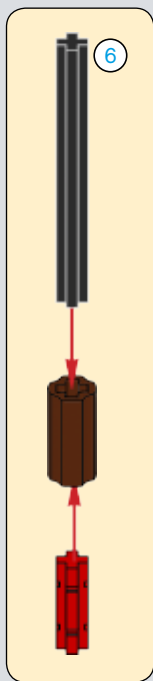

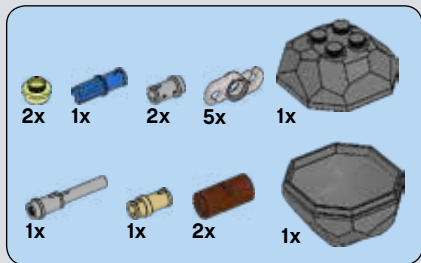

21

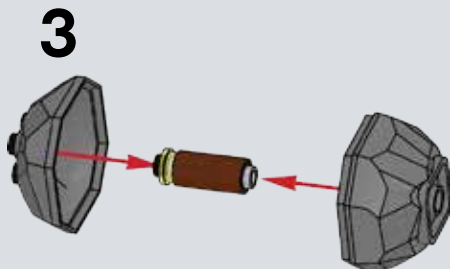
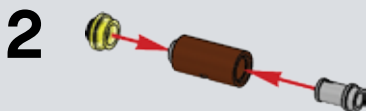
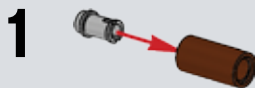

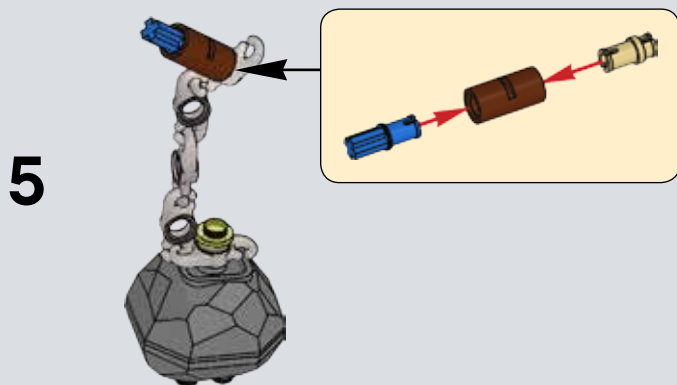
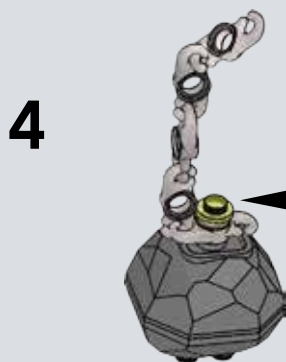
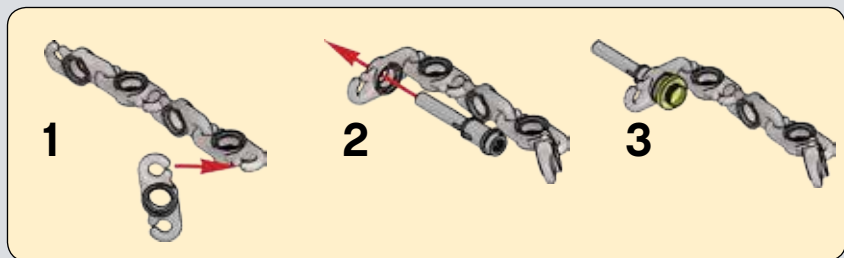

22

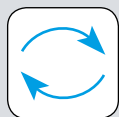

23

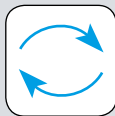
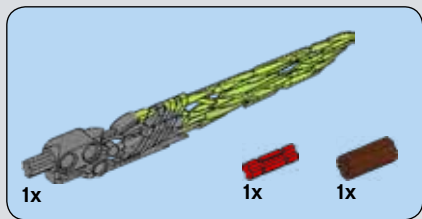

23

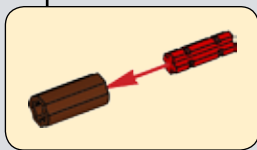
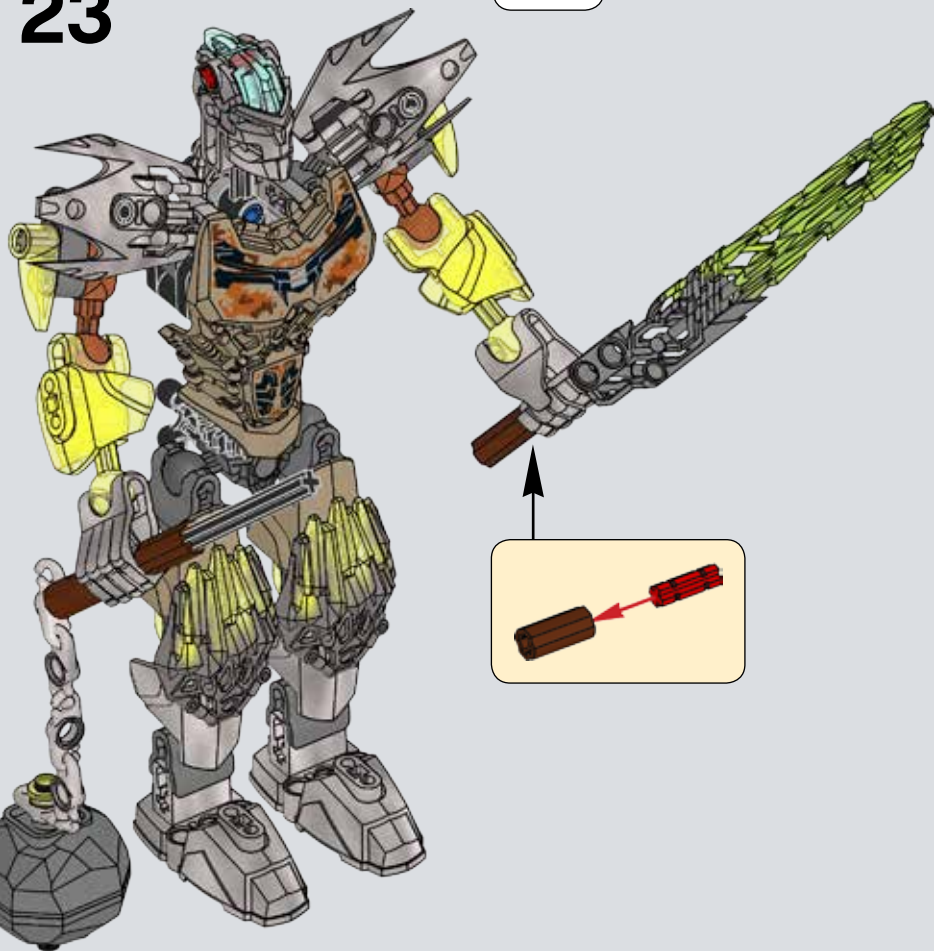



24

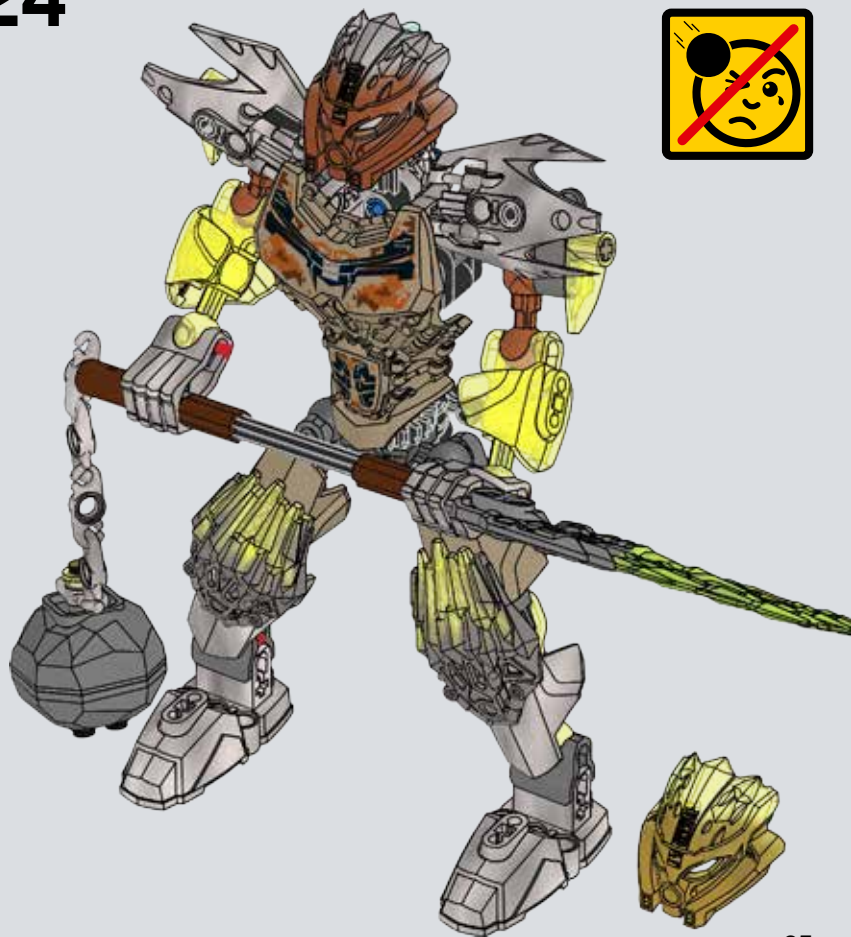

1x
6013938

7x
4142865

1x
4206482

1x
4514553

1x
4177431

4x
4164133

5x
4121715

1x
4248204

2x
6089119

2x
4610948



1x
6135125



2x
6139208

1x
6135238

2x
3005749

2x
4163577

2x
6061058

4x
6078388

2x
4531751

2x
6055781

1x
6121726

2x
4211483

1x
4211815

1x
4520320

1x
4210851

4x
6106472

2x
4210857

1x
6015356

2x
4289258

2x
6031821

1x
6083620

1x
4506778

1x
4506779

2x
4622903

5x
6124042

1x
6102606

2x
6016585

2x
6120582

1x
6135034

1x
6150660



1x
6139240

1x
6139106

2x
6139222

1x
6135035

2x
6135094

2x
4619077

1x
6135237

2x
4632585



Customer Service

Kundenservice

Service Consommateurs

Servicio Al Consumidor

LEGO.com/service or dial



00800 5346 5555 :

1-800-422-5346 :

LEGO

BIONICLE

71310



UNITE for battle



71301+71306



LEGO.com/bionicle

**UNIS-LES pour le combat
Sólo podemos luchar UNIDOS**

Download App
Télécharger l'application
Descarga la App



NETFLIX



Download on the
App Store

Apple, the Apple logo, iPad, iPhone and iPod touch are trademarks of Apple Inc.
Apple, le logo Apple, iPad, iPhone et iPod touch sont des marques de commerce d'Apple Inc.
Apple, el logotipo de Apple, iPad, iPhone e iPod touch son marcas comerciales de Apple Inc.

GET IT ON

Google play

Google Play is a trademark of Google Inc.
Google Play est une marque de commerce de Google Inc.
Google Play es una marca comercial de Google Inc.



71300



71305



71301



71306



71302



71307



71303



71308



71304



71309



71311



71311





71311

71302

71301

71311

71307

71306



71303



71300



71304



71308



71305



71309

