



BIONICLE®

71304









1x



1x

1

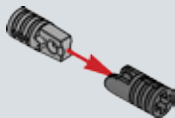

4



2

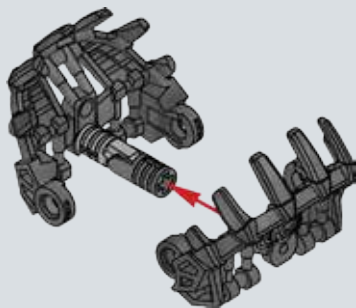



2x



1x

3

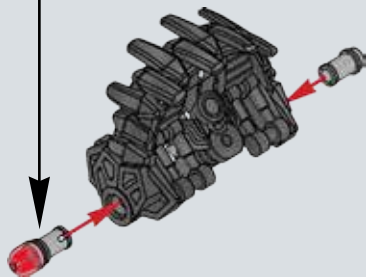
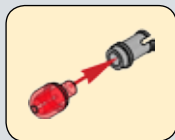

6

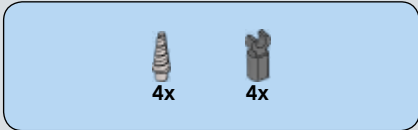

4

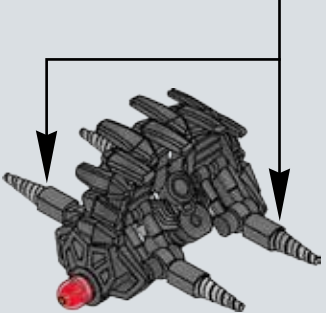
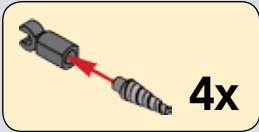

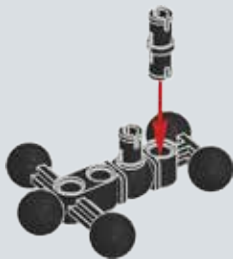
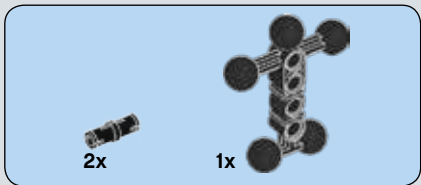

1



1x

2

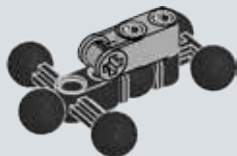

1x

3

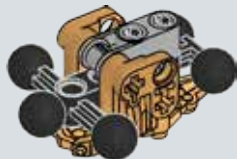

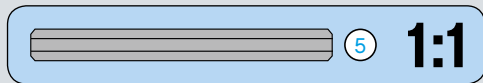
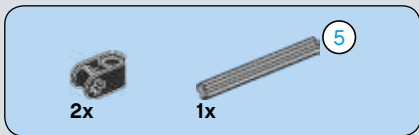

4

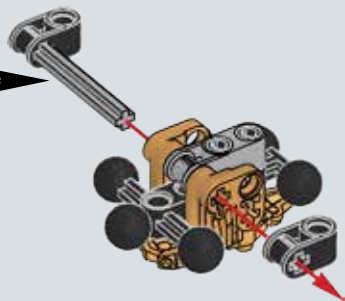
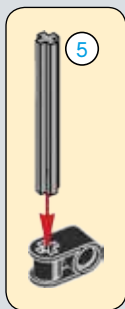



2x

5

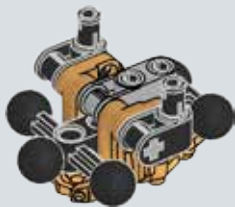

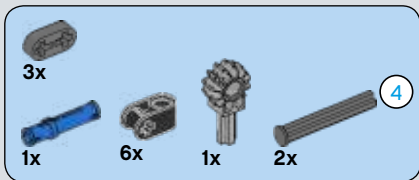

6

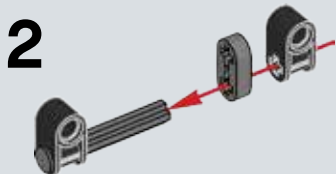
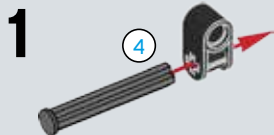

12

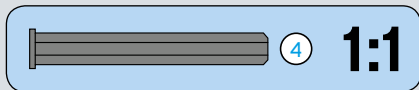

3

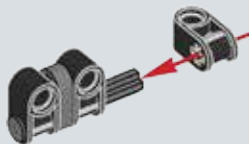

4

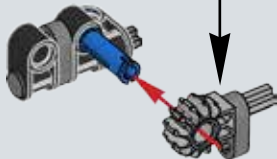
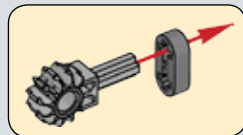

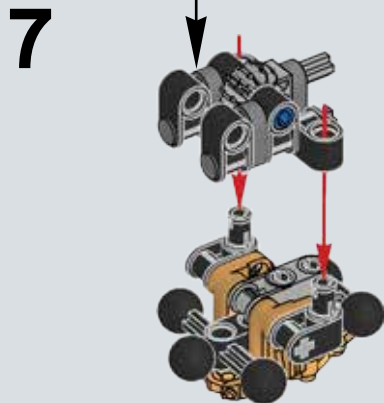
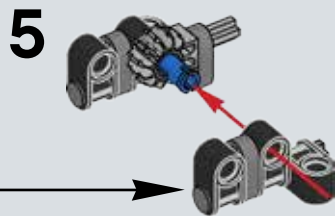
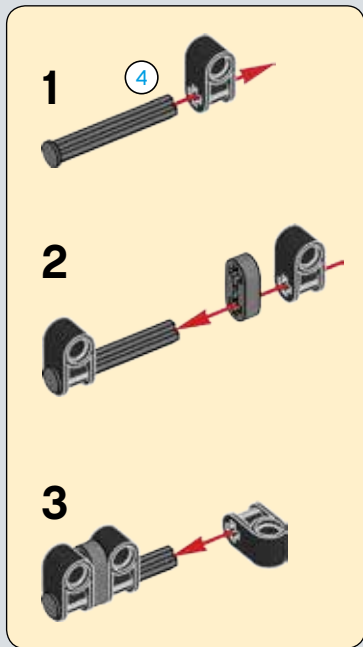

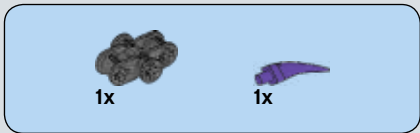

8

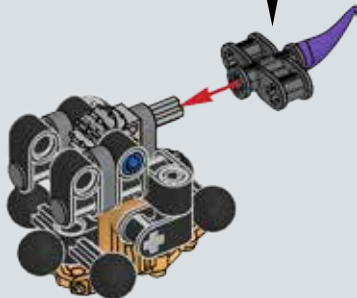
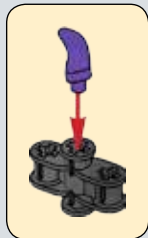

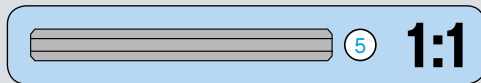
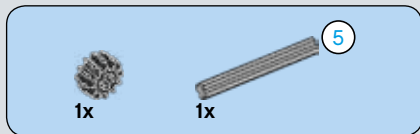

9

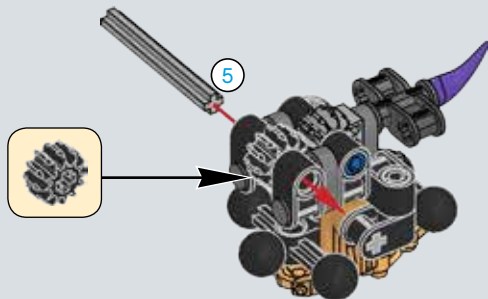

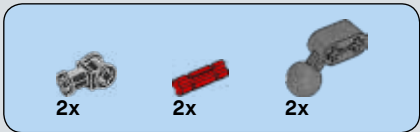

10

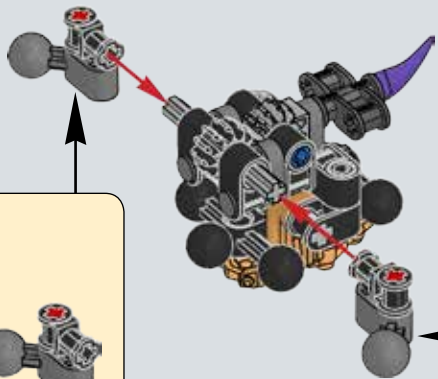
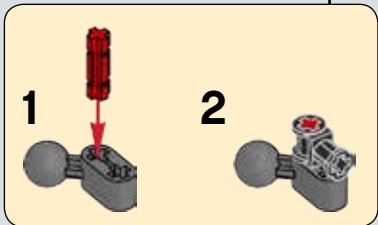
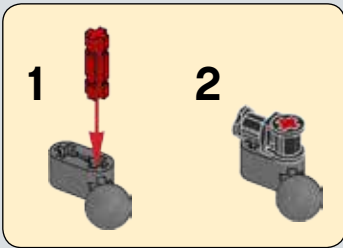

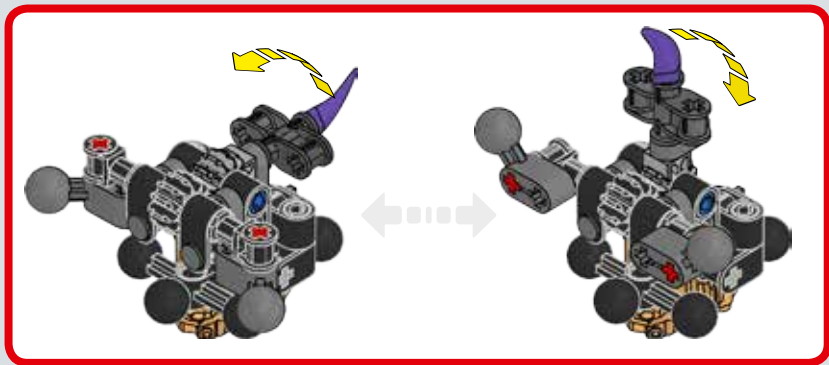



2x



2x

11

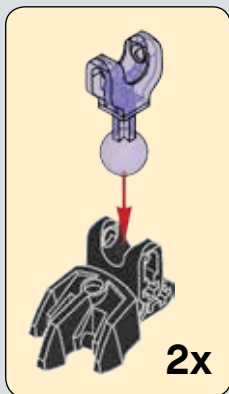

2x

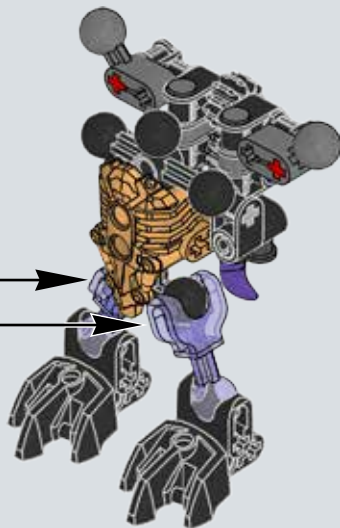



2x

12

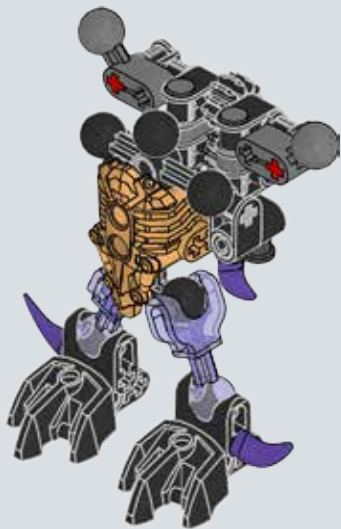



2x



1x



1x

13

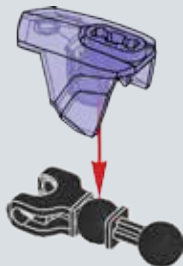

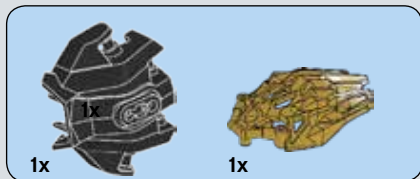

14

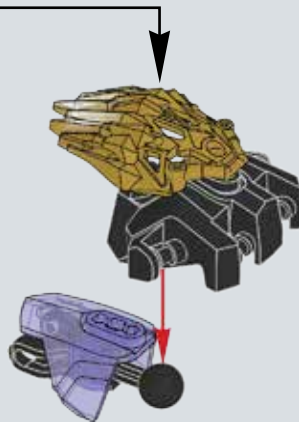
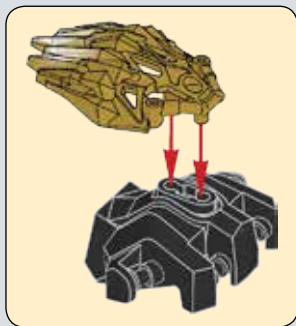



4x

15



2x

16

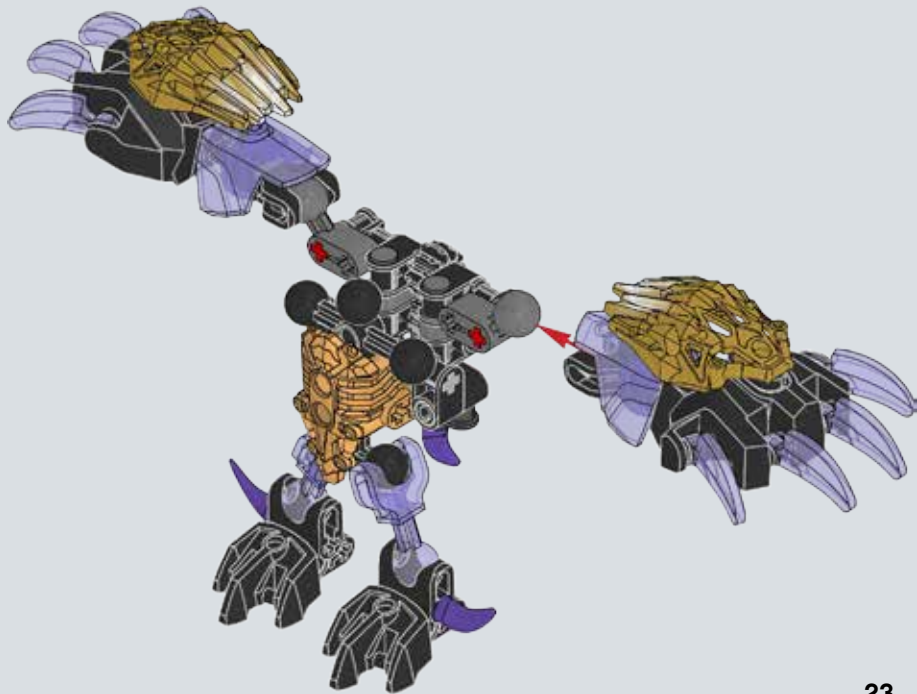

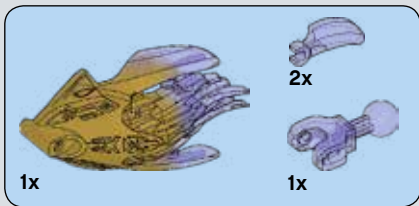

17

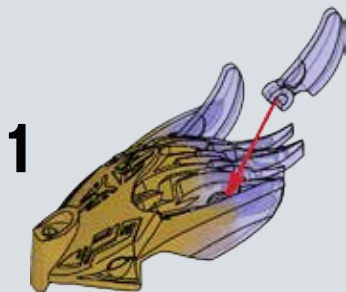

2

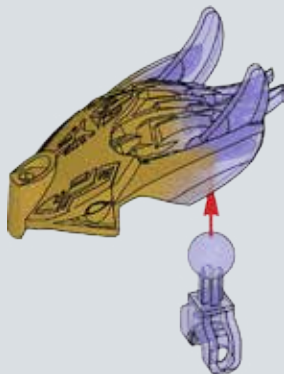

18

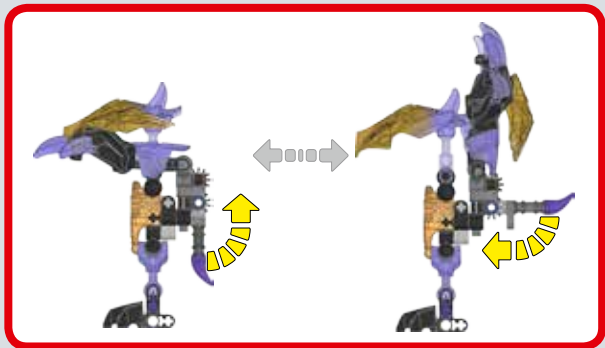

2x
4142865

1x
4514553

1x
4177431

4x
4121715

2x
6133711

8x
4173668

1x
4667277

2x
6057727

2x
4593555

2x
4107081

1x
4497943

1x
6135190

10x
6133713

2x
6139221

2x
6147740

3x
6106242

1x
6135053

1x
6134848

1x
4211679

1x
4211779

2x
4211639

2x
4211483

3x
4210980

1x
4210695

2x
4289258

2x
6083620

4x
6015890

3x
6058227

4x
4612829

1x
6022718

2x
6135124



Customer Service

Kundenservice

Service Consommateurs

Servicio Al Consumidor

LEGO.com/service or dial



00800 5346 5555 :



1-800-422-5346 :





BIONICLE

71310



 LEGO.com/bionicle

Download App
Télécharger
l'application
Descarga la App



 Download on the
App Store

GET IT ON
 **Google play**

Apple, the Apple logo, iPad, iPhone and iPod touch are trademarks of Apple Inc.

Apple, le logo Apple, iPad, iPhone et iPod touch sont des marques de commerce d'Apple Inc.

Apple, el logotipo de Apple, iPad, iPhone e iPod touch son marcas comerciales de Apple Inc.

Google Play is a trademark of Google Inc.

Google Play est une marque de commerce de Google Inc.

Google Play es una marca comercial de Google Inc.



UNITE for battle



71304+71309

UNIS-LES pour le combat • Sólo podemos luchar UNIDOS



71300

71305



71303

71308



71301

71306



71304

71309



71302

71307



71311

71311



71311

71302

71301

71311

71307

71306



71303



71300



71304



71308



71305



71309

