

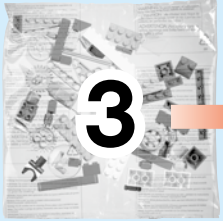

THE NINJAGO MOVIE

70612





3

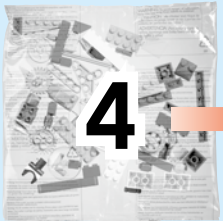
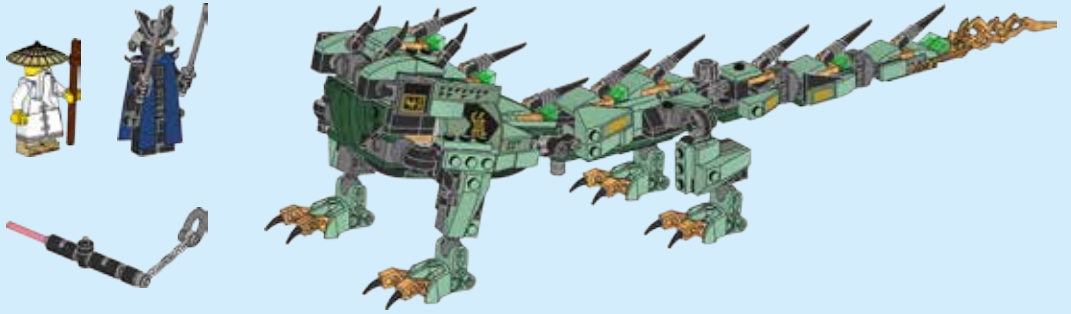

4



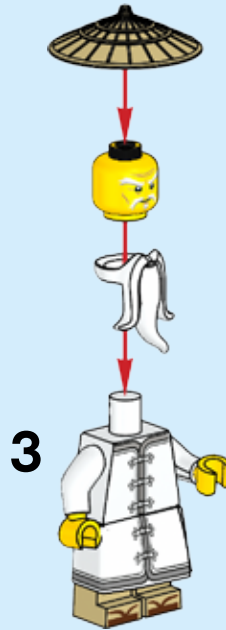
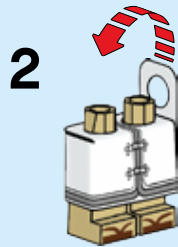
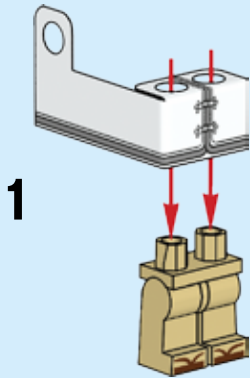
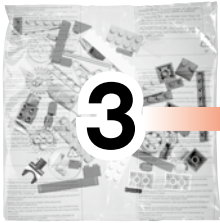

1



2



3



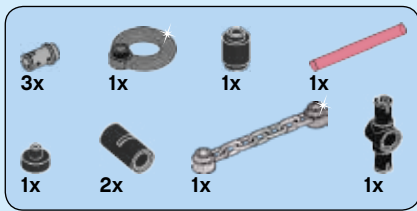

4

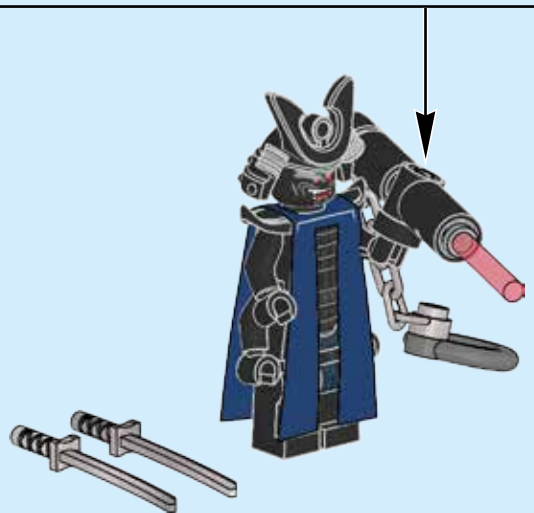
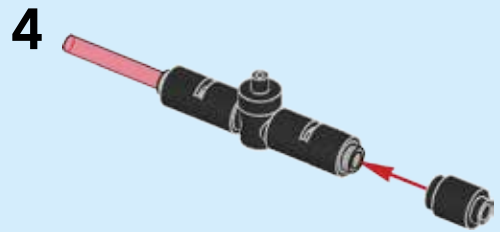
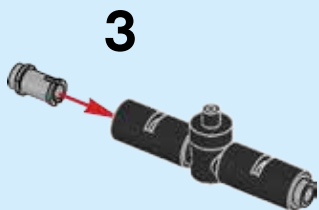
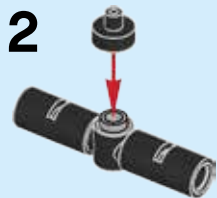

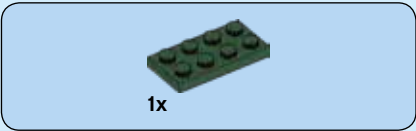

1x

86

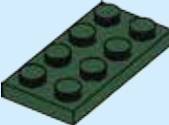

1x

87

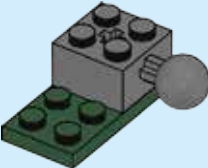

1x

1x

88

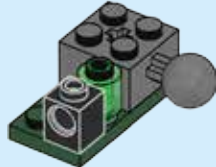

1x

1x

89

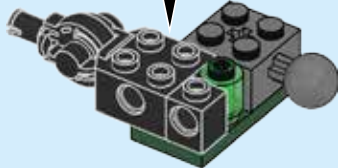
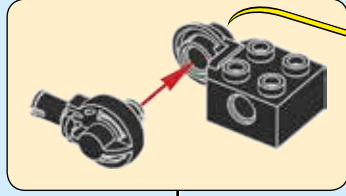

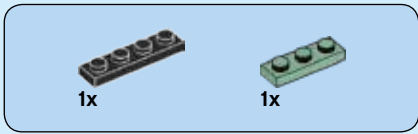

90

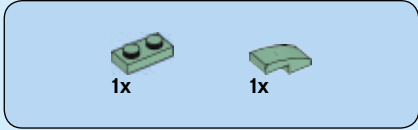
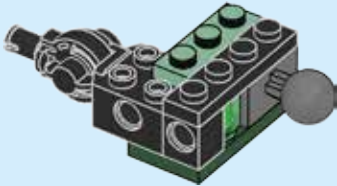

91

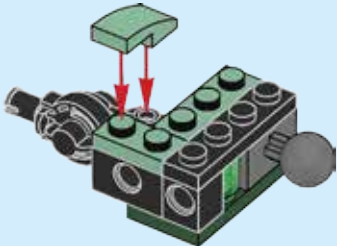

92

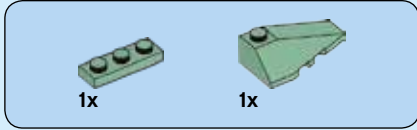
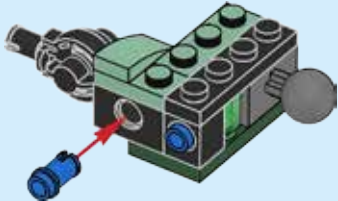

93

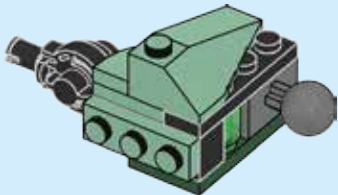

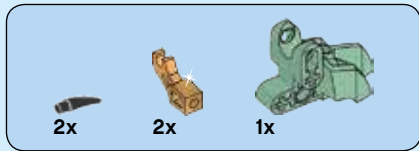

94

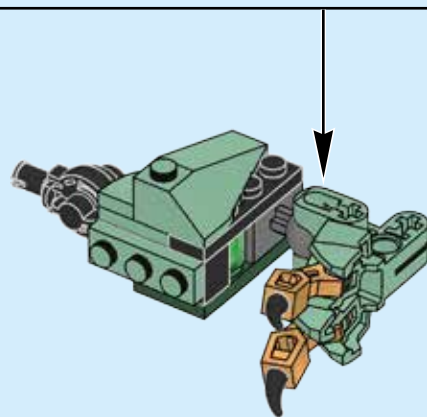
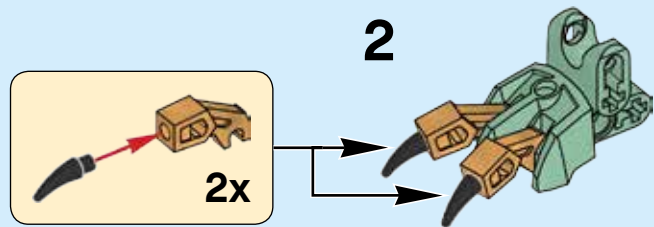
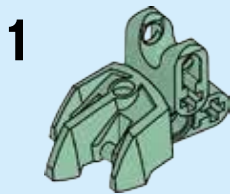

95

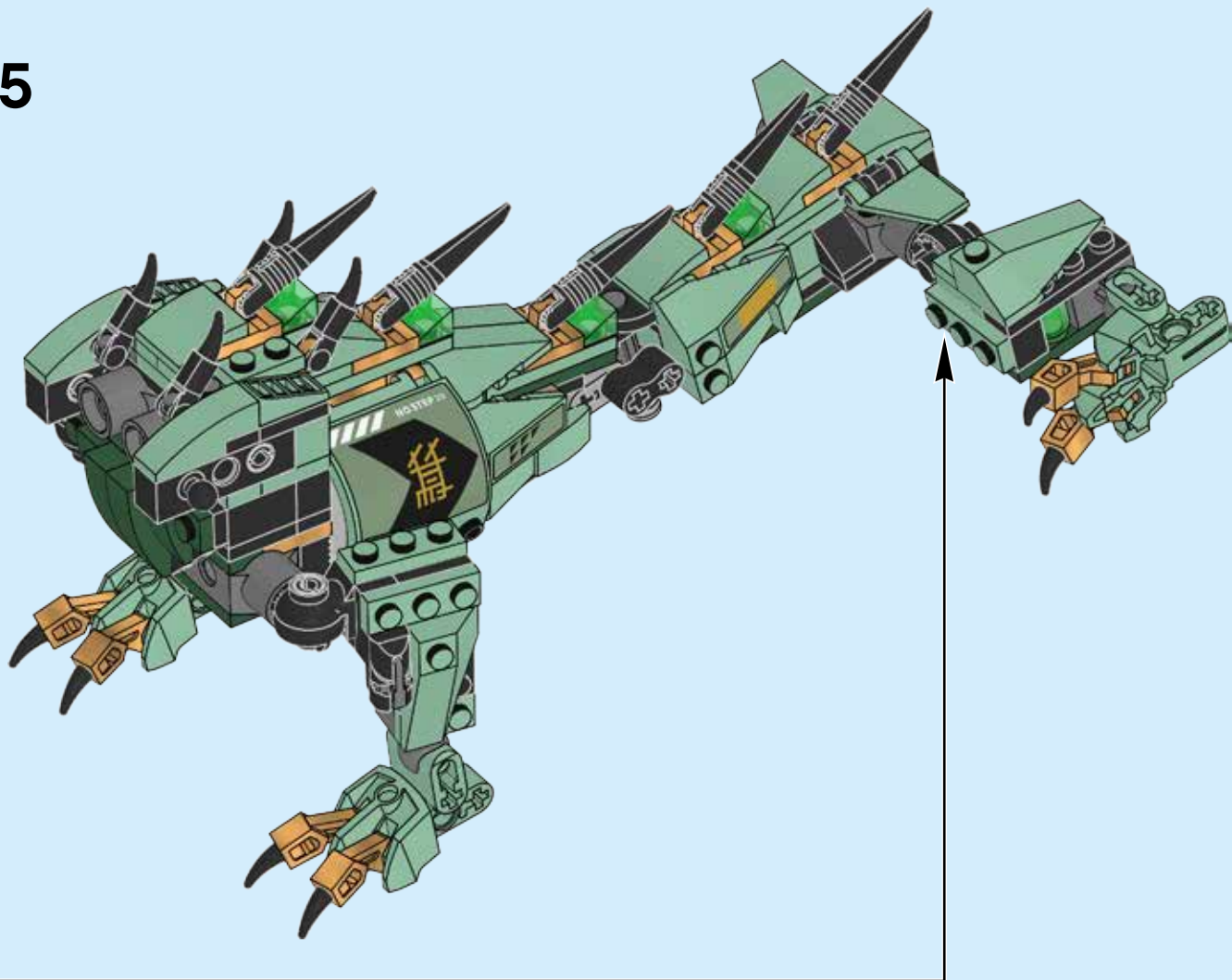

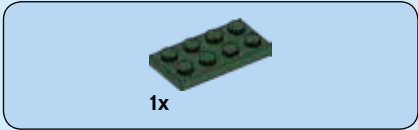
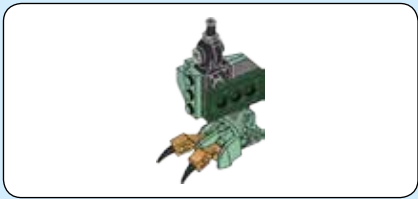

96

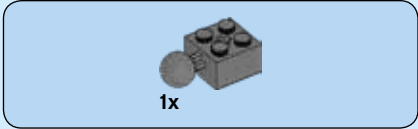
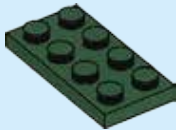

97

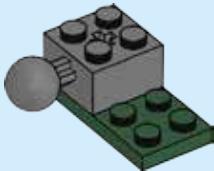

98

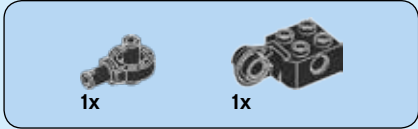
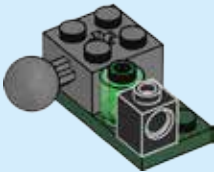

99

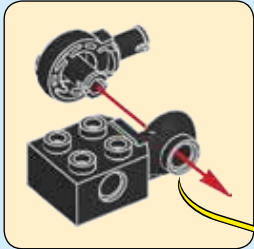

CLICK CLIC

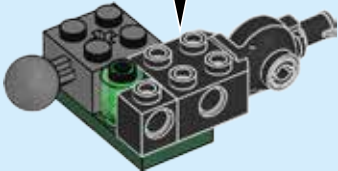

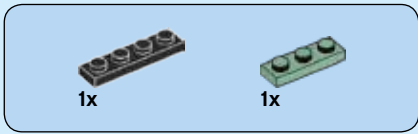

100

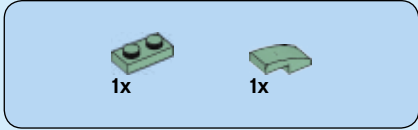
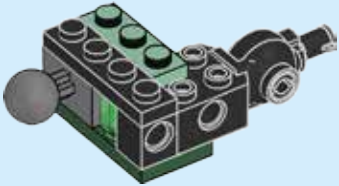

101

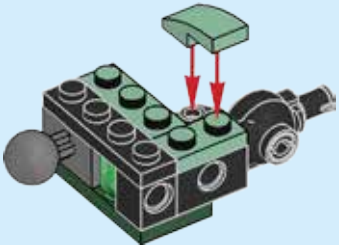

102

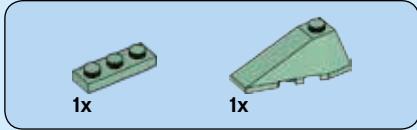
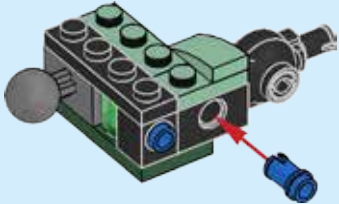

103

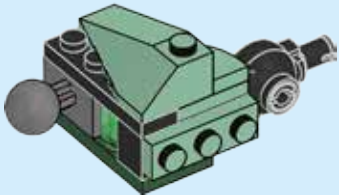

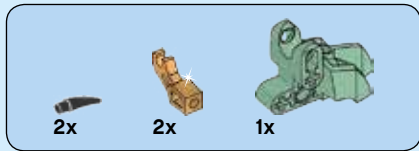

104

1



2

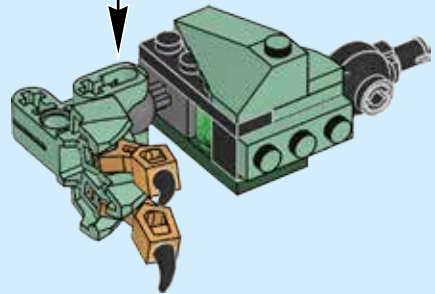
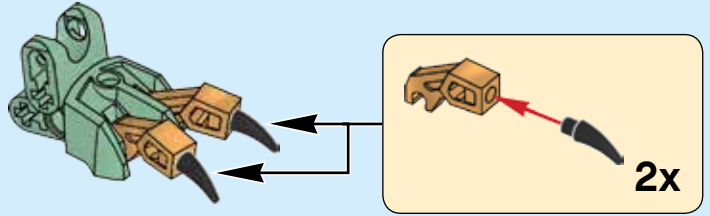

105

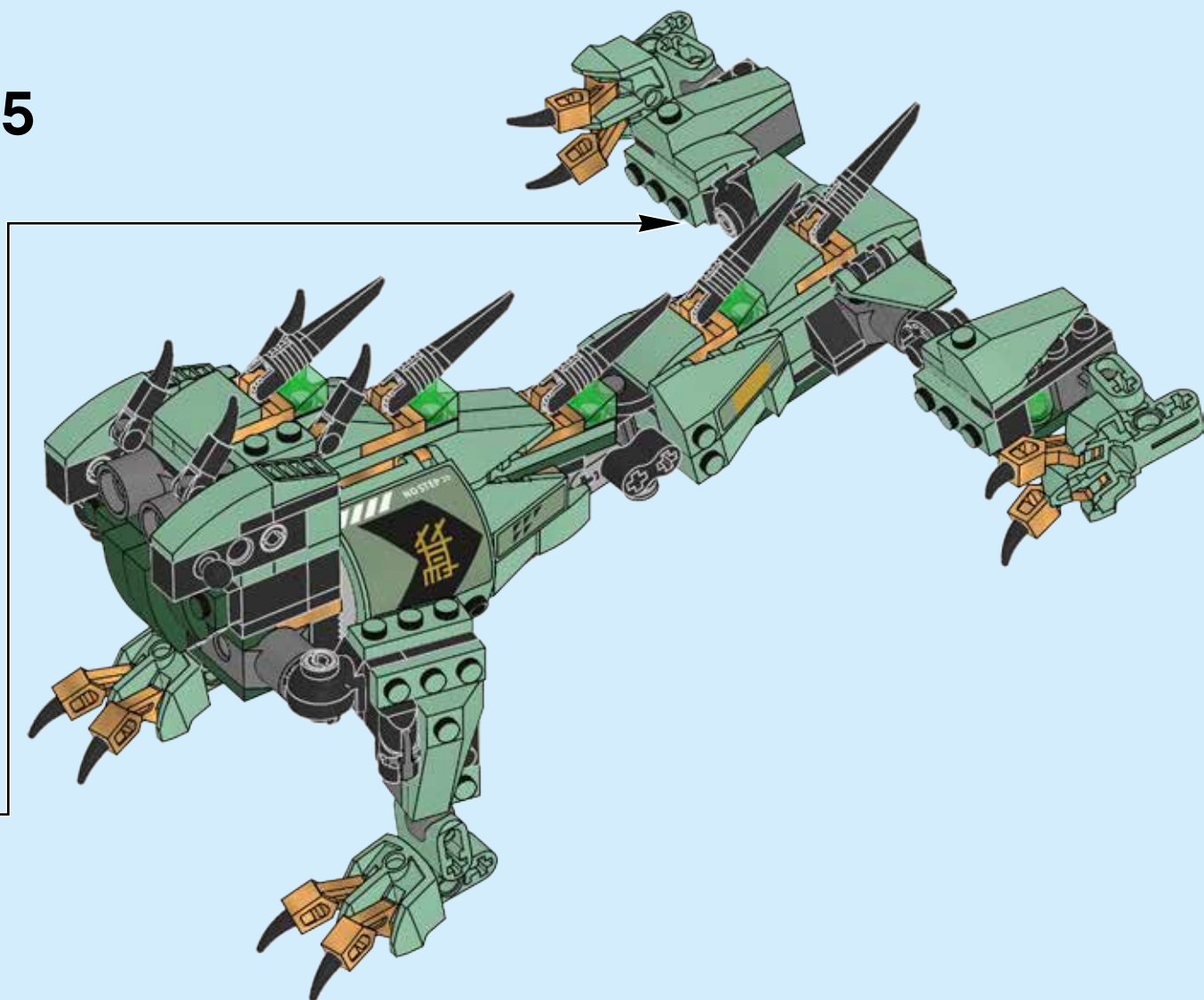

106

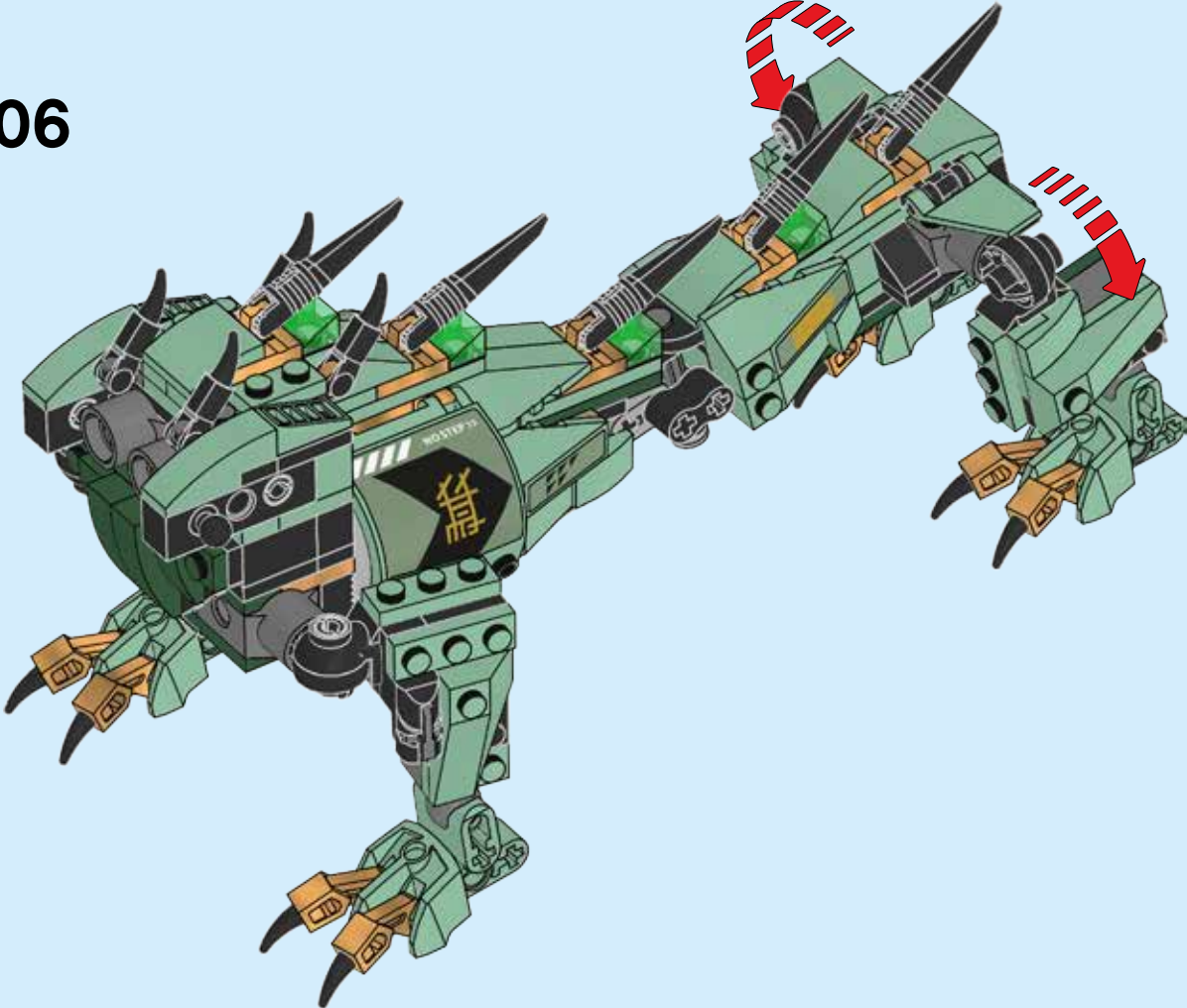



1x

1x

107

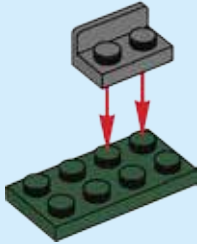

1x

1x

108

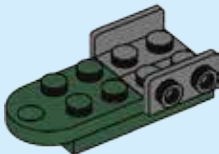

1x

109

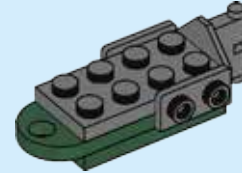

1x

110

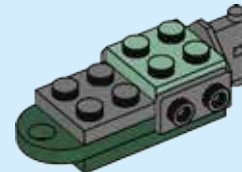



111

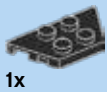
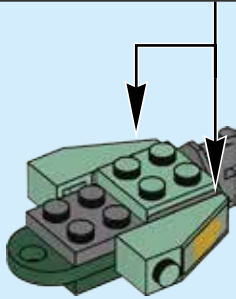
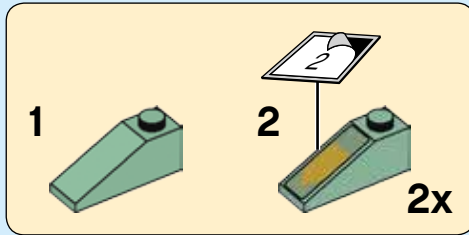

112



113

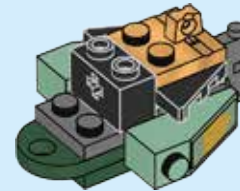

114

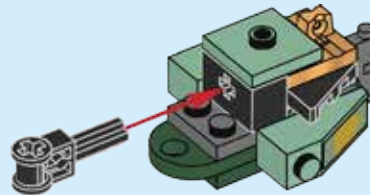

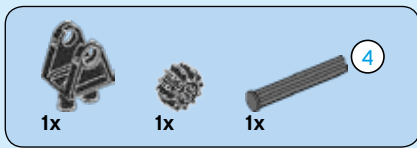

115

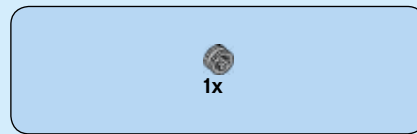
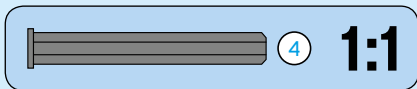
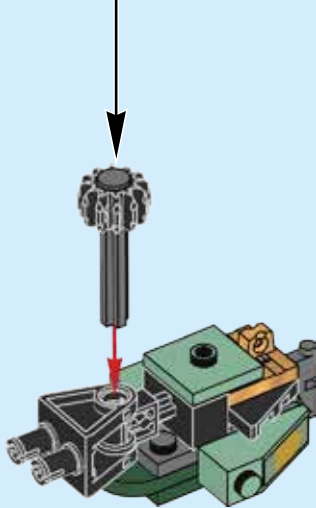
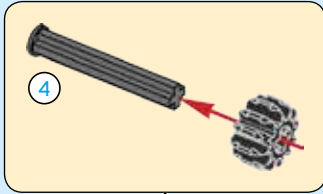

116

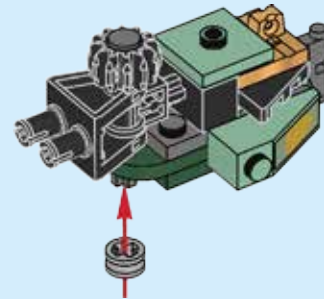

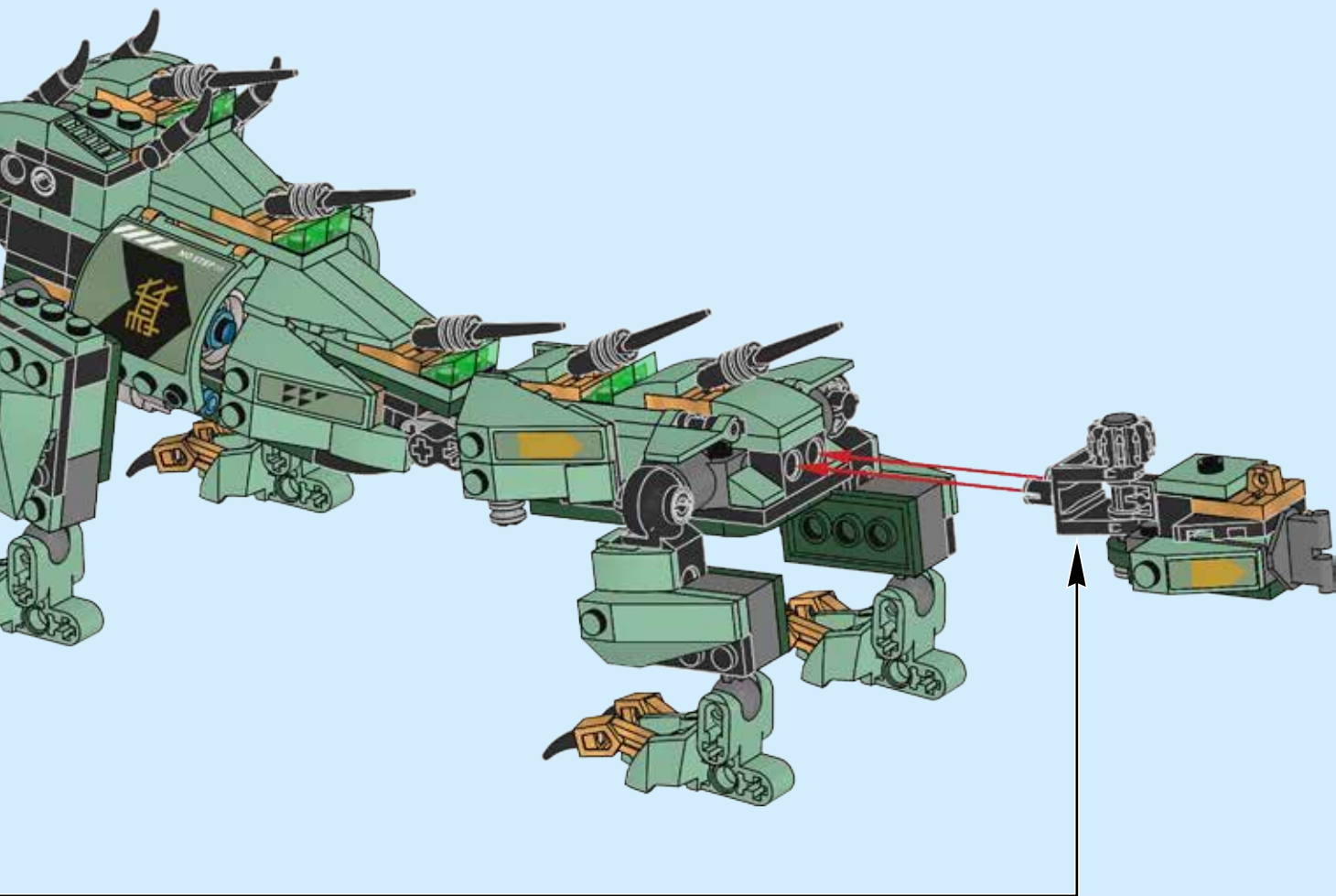

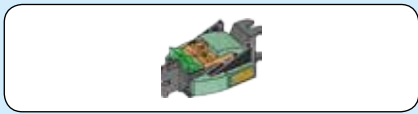

118

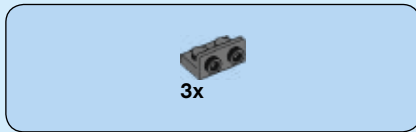
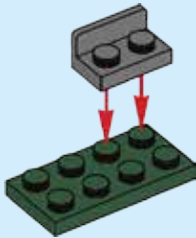

119

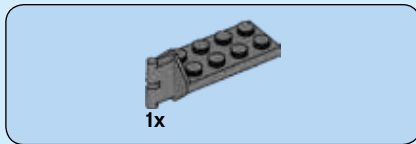
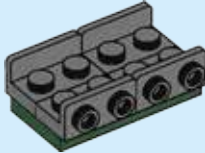

120

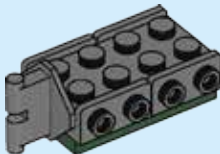

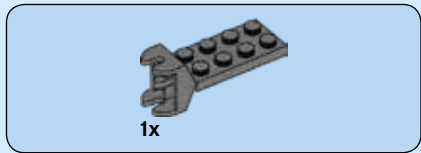

121

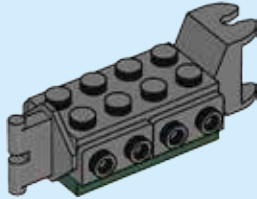

122

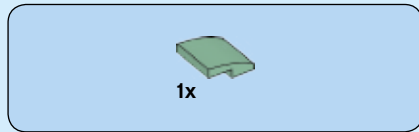
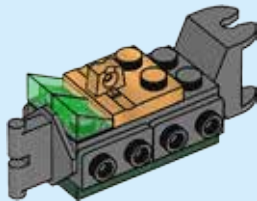

123

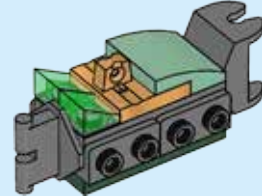

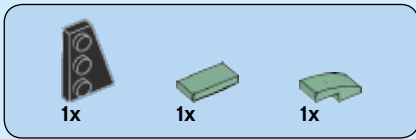

124

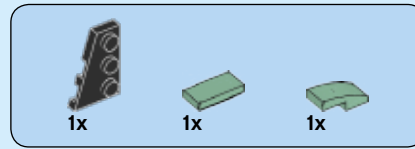
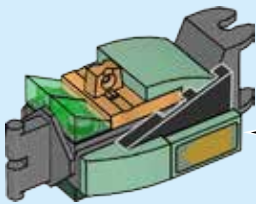
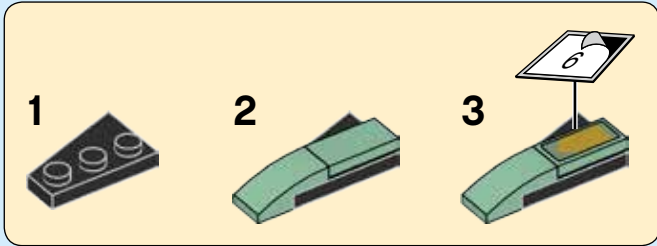

125

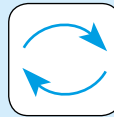
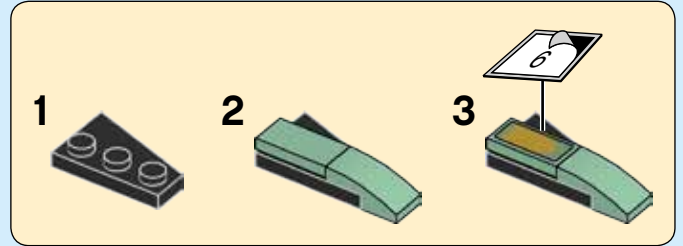

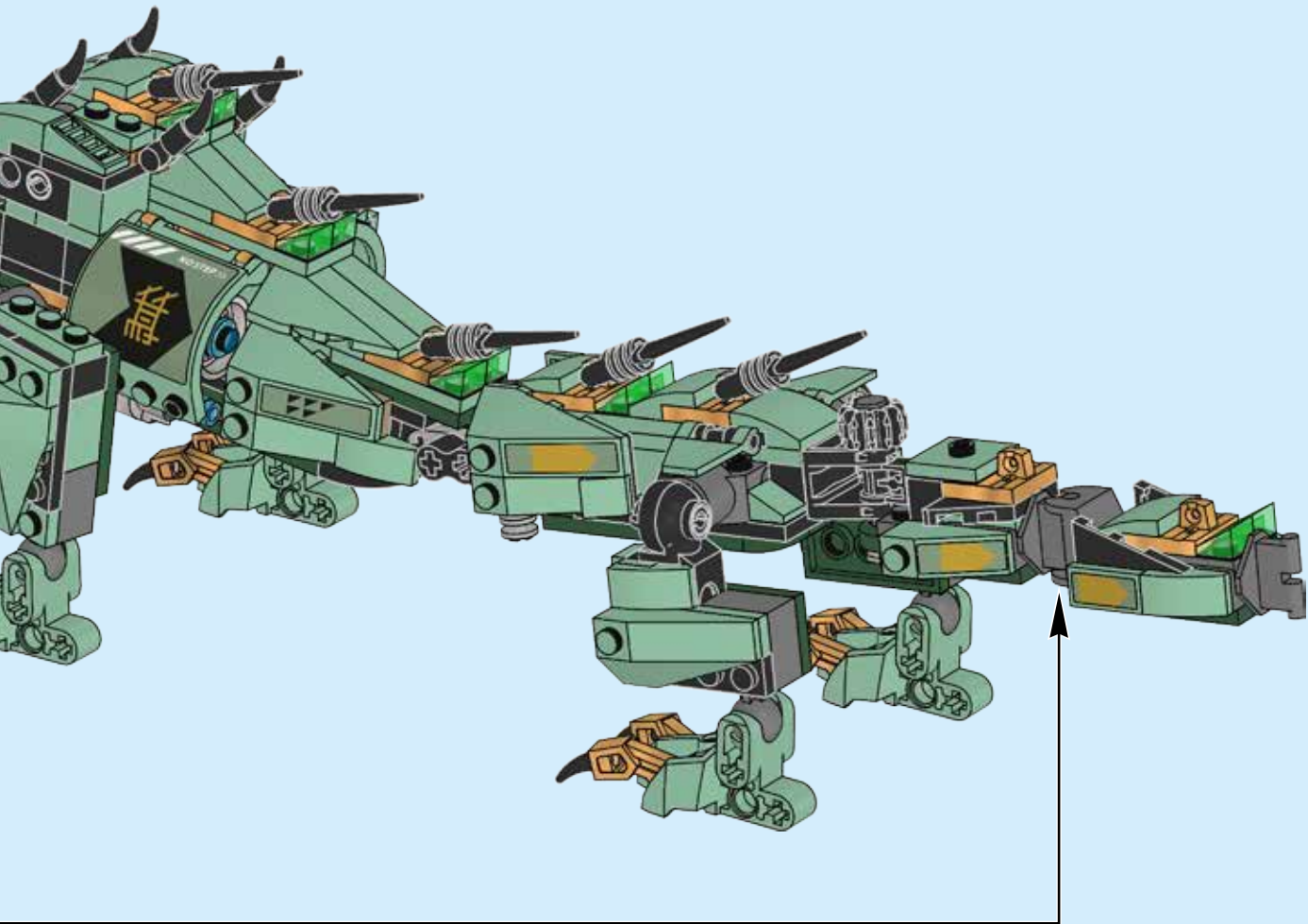

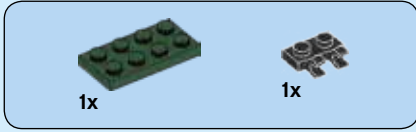

127

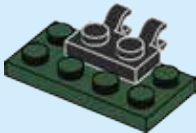

128

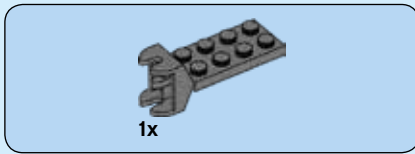
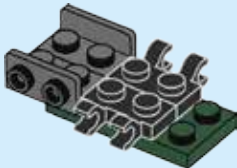

129

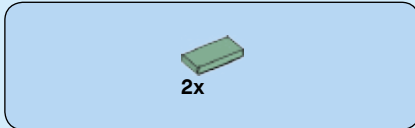
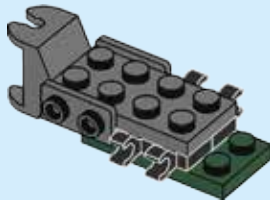

130

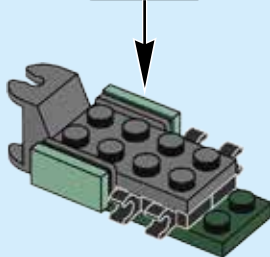



1x

131

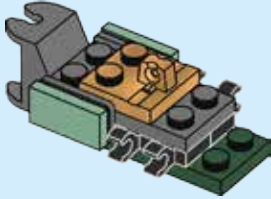

1x

132

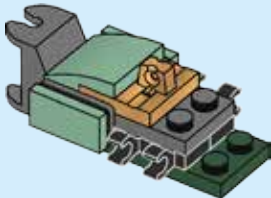

2x



1x



1x

133

1



2

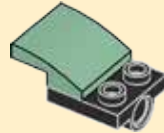

3

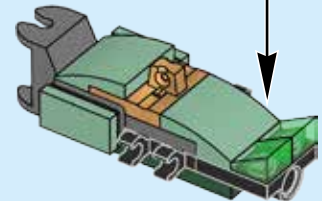

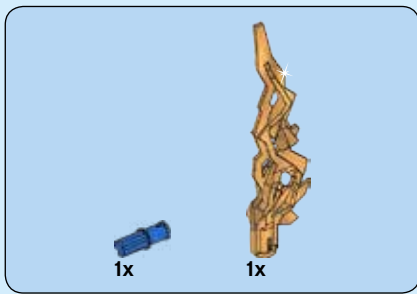

134

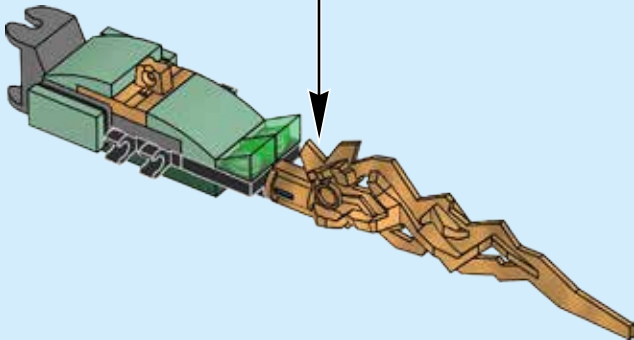
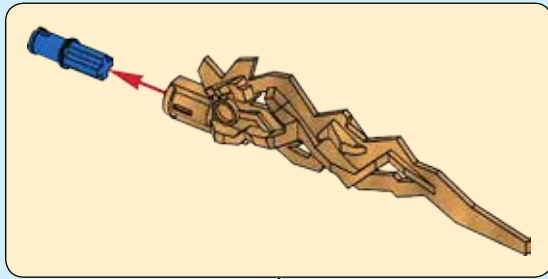

135

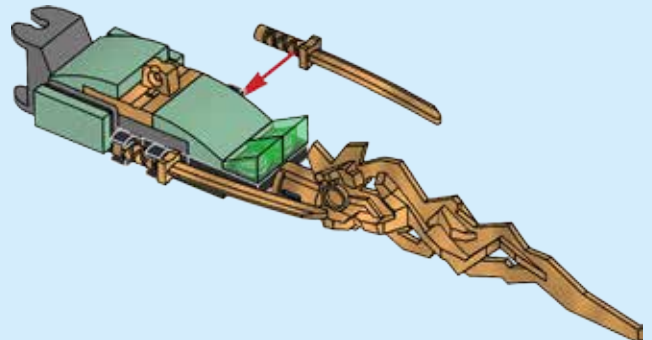

136

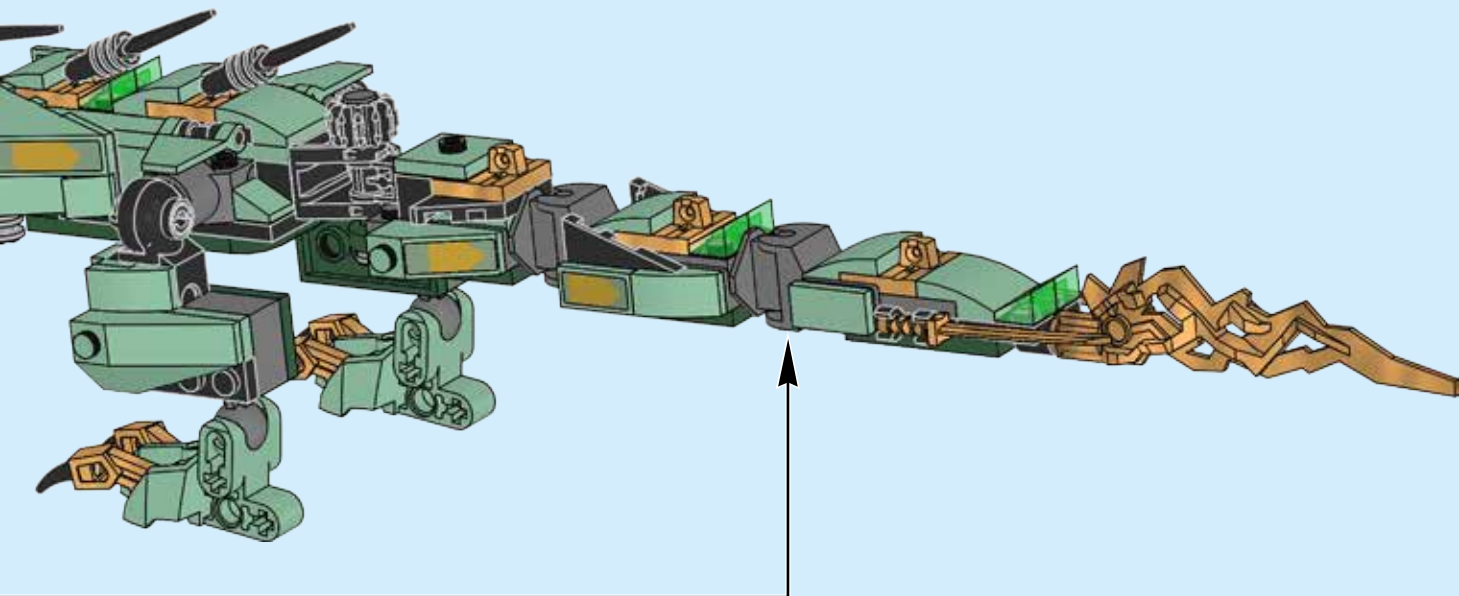



3x



3x

137



3x

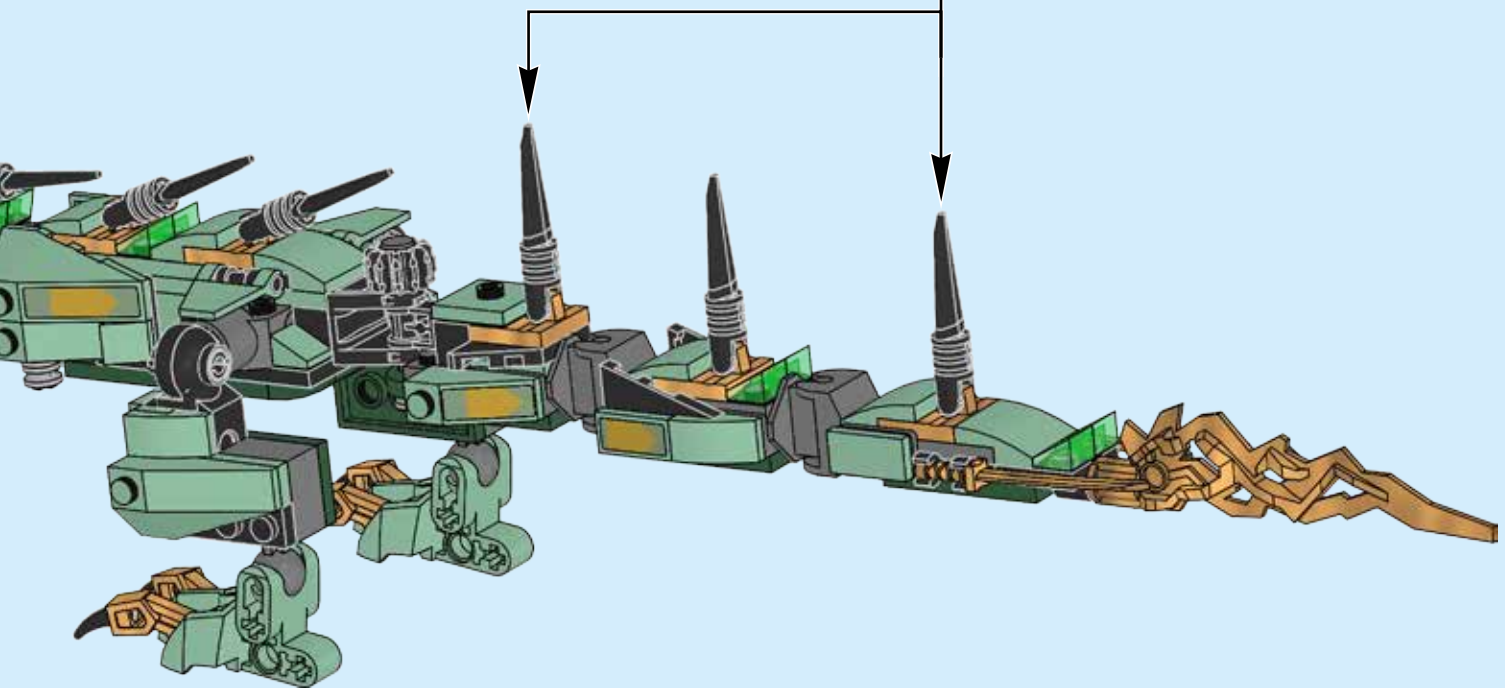

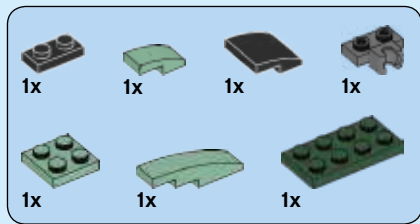

138

1

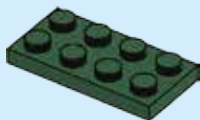

2



3

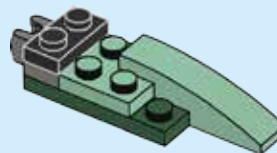

4

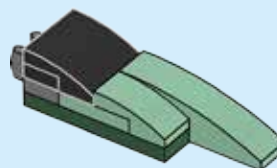

5

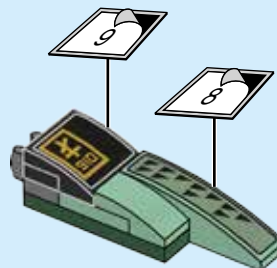

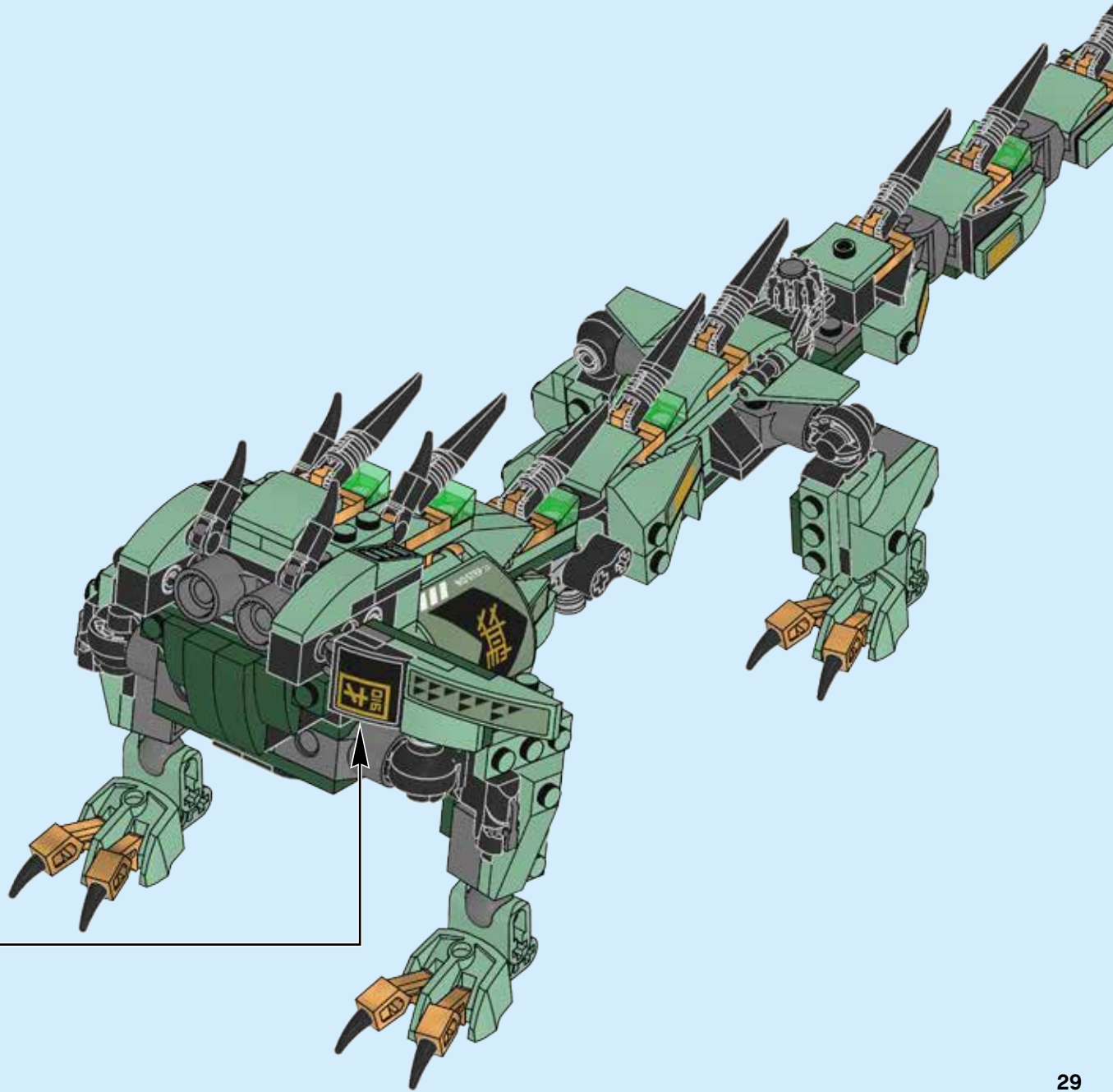

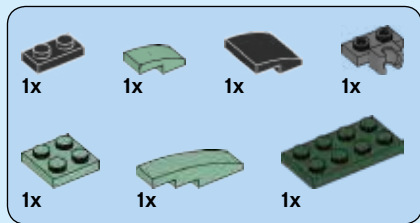

139

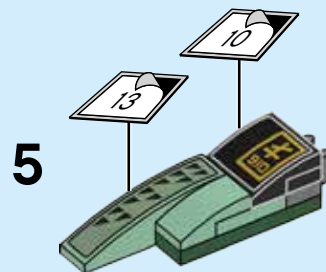
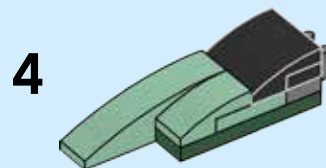
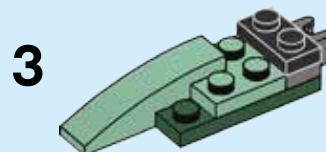
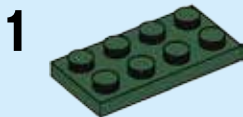

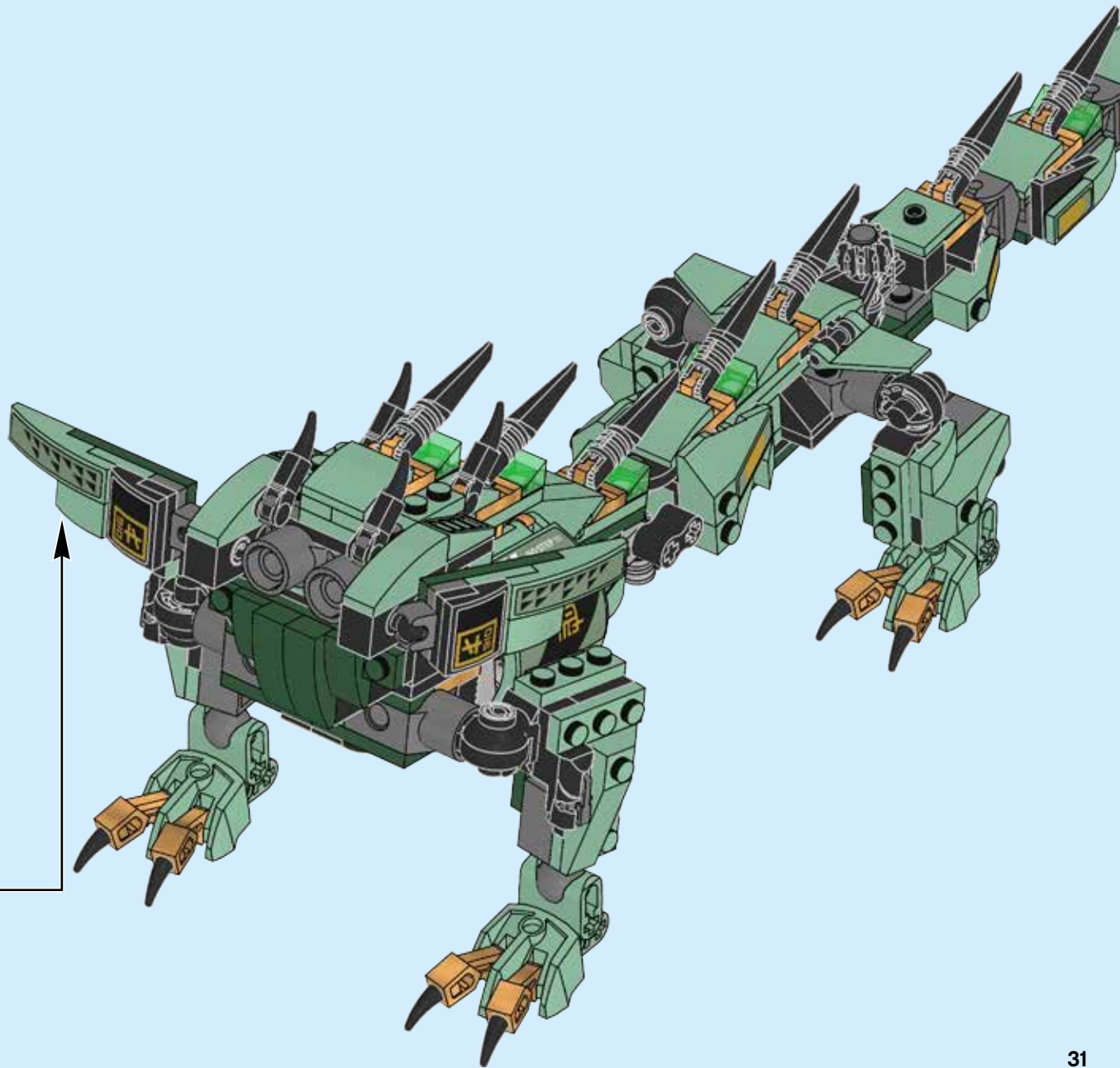

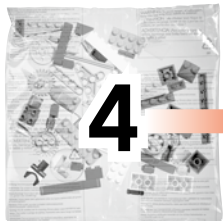

140

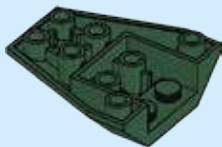

141





1x

142

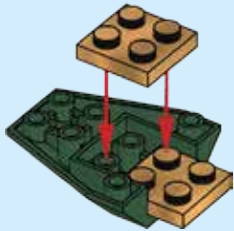

2x

143

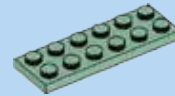
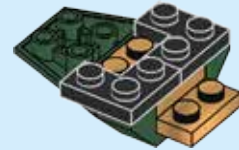

1x

144

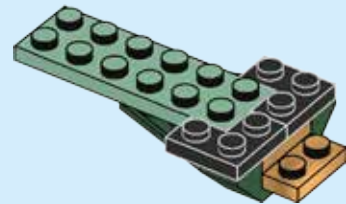

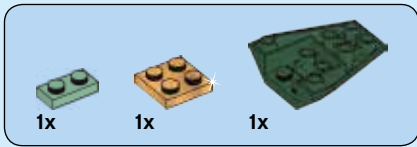

145

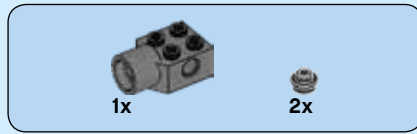
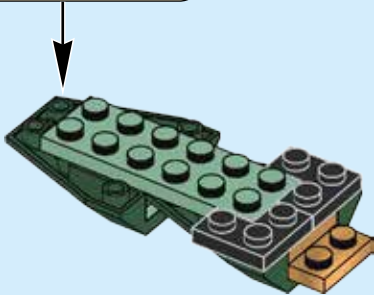
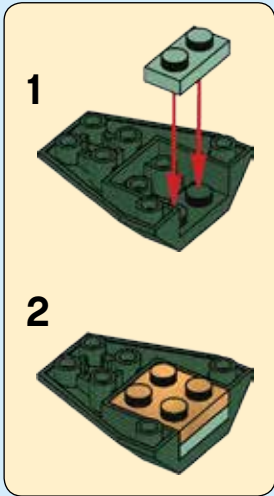

146

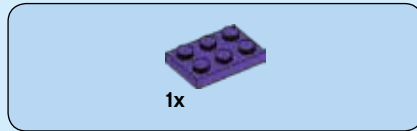
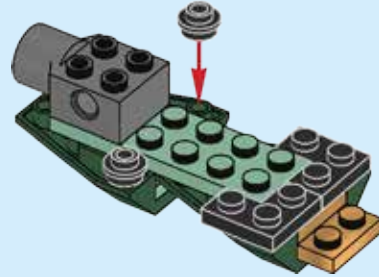

147

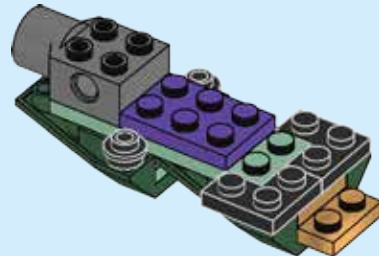



1x

148

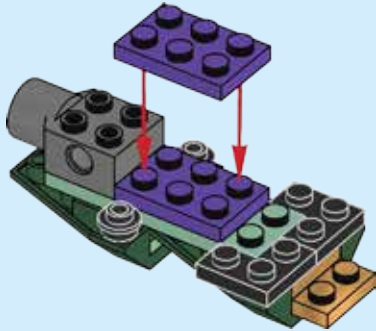

1x



2x

149

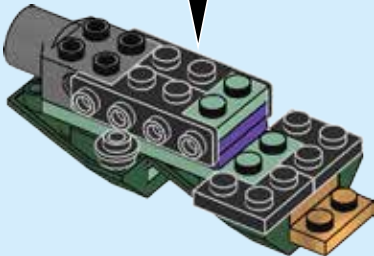
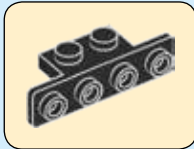

2x



2x

150

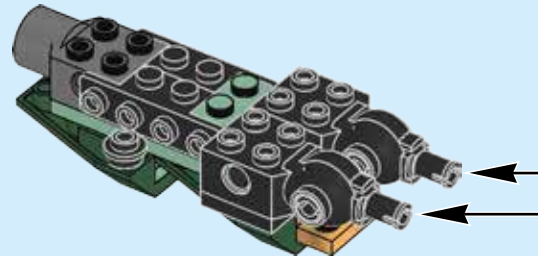
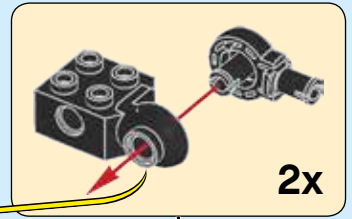

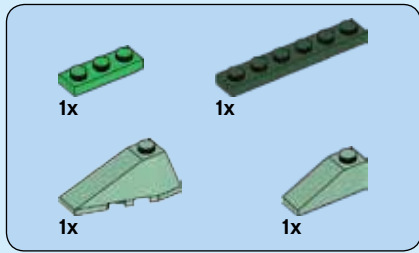

151

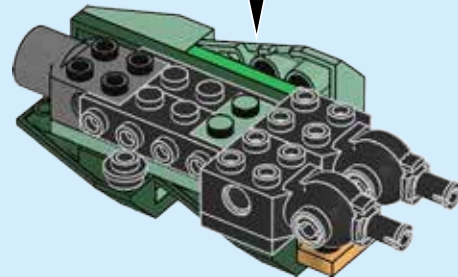
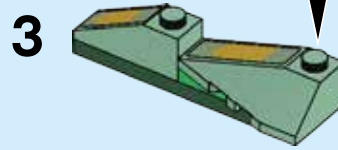
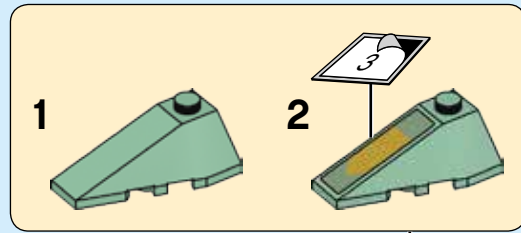
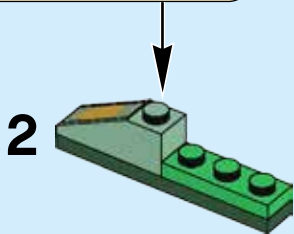
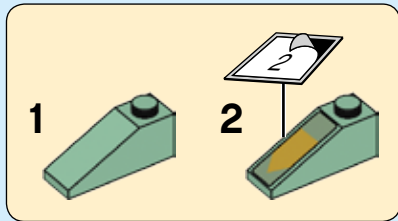
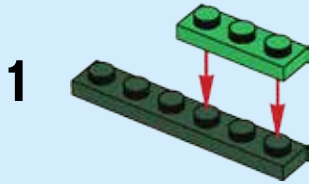

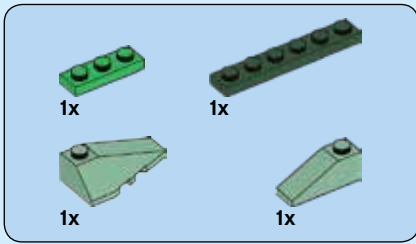

152

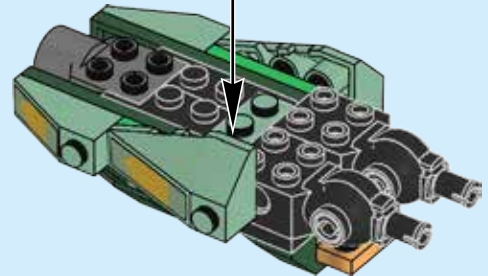
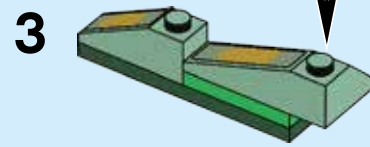
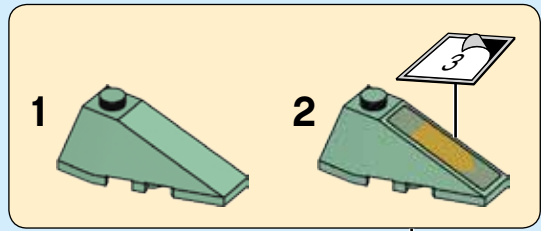
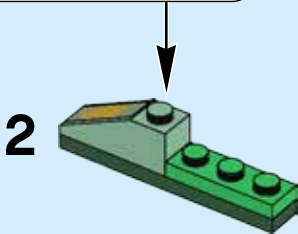
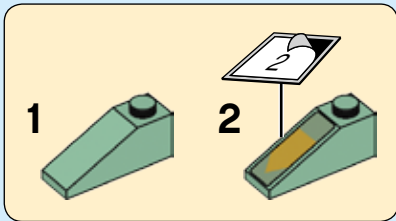
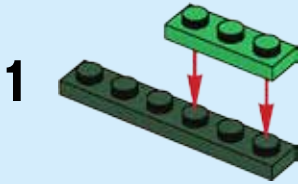

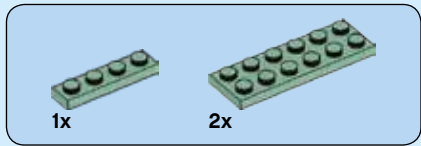

153

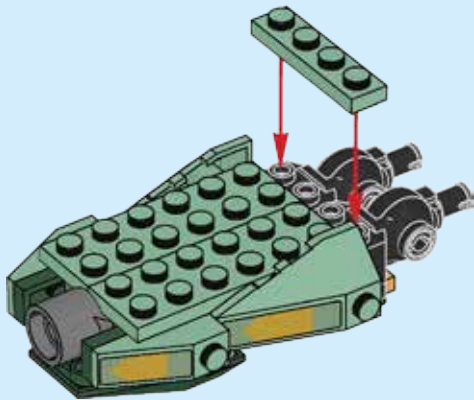

154

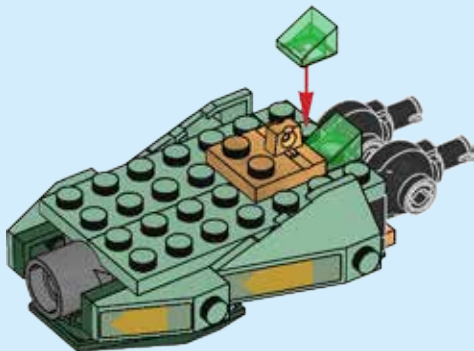

155

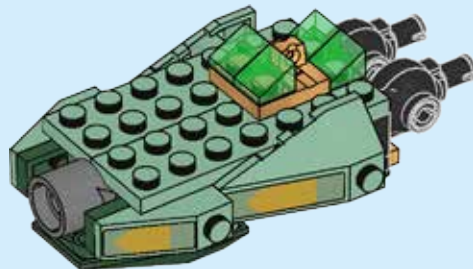



2x

156

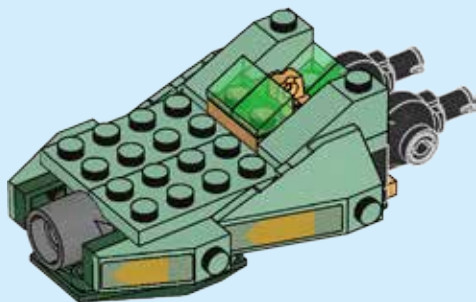

1x



2x

157

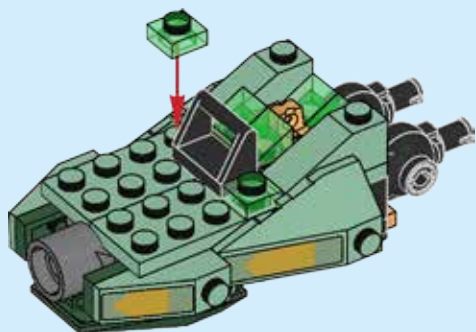

2x

158

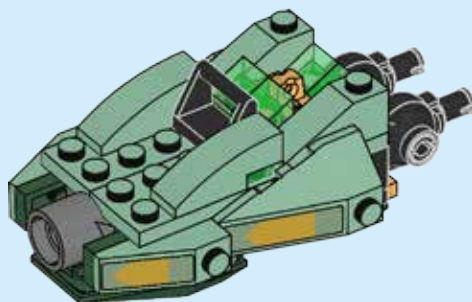



159

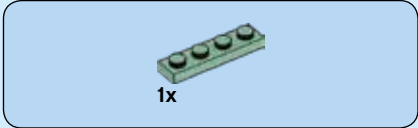
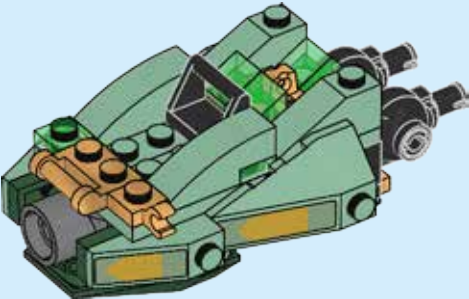

160

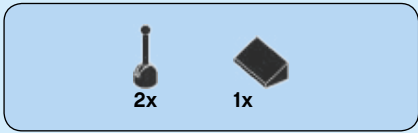
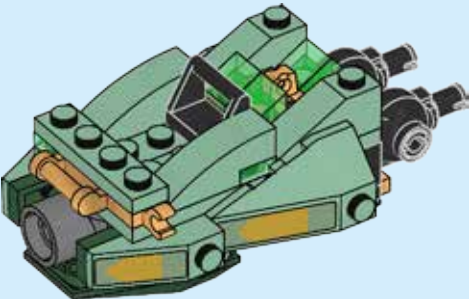

161

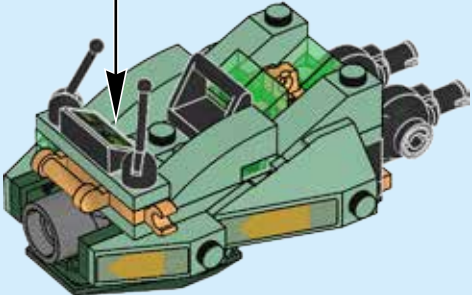
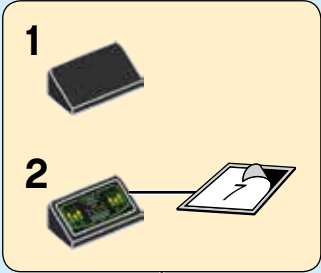



2x



1x

162

1



2

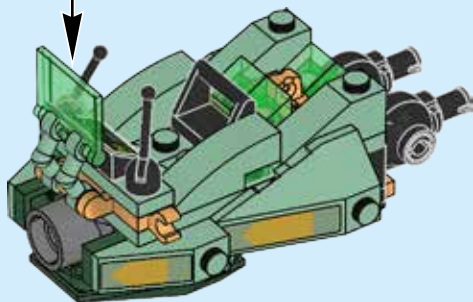
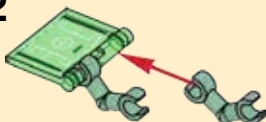

1x



1x

163

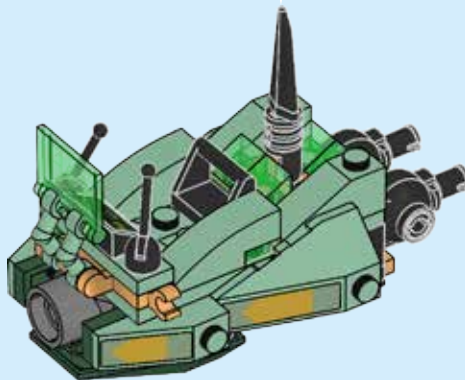
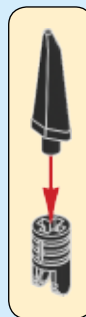

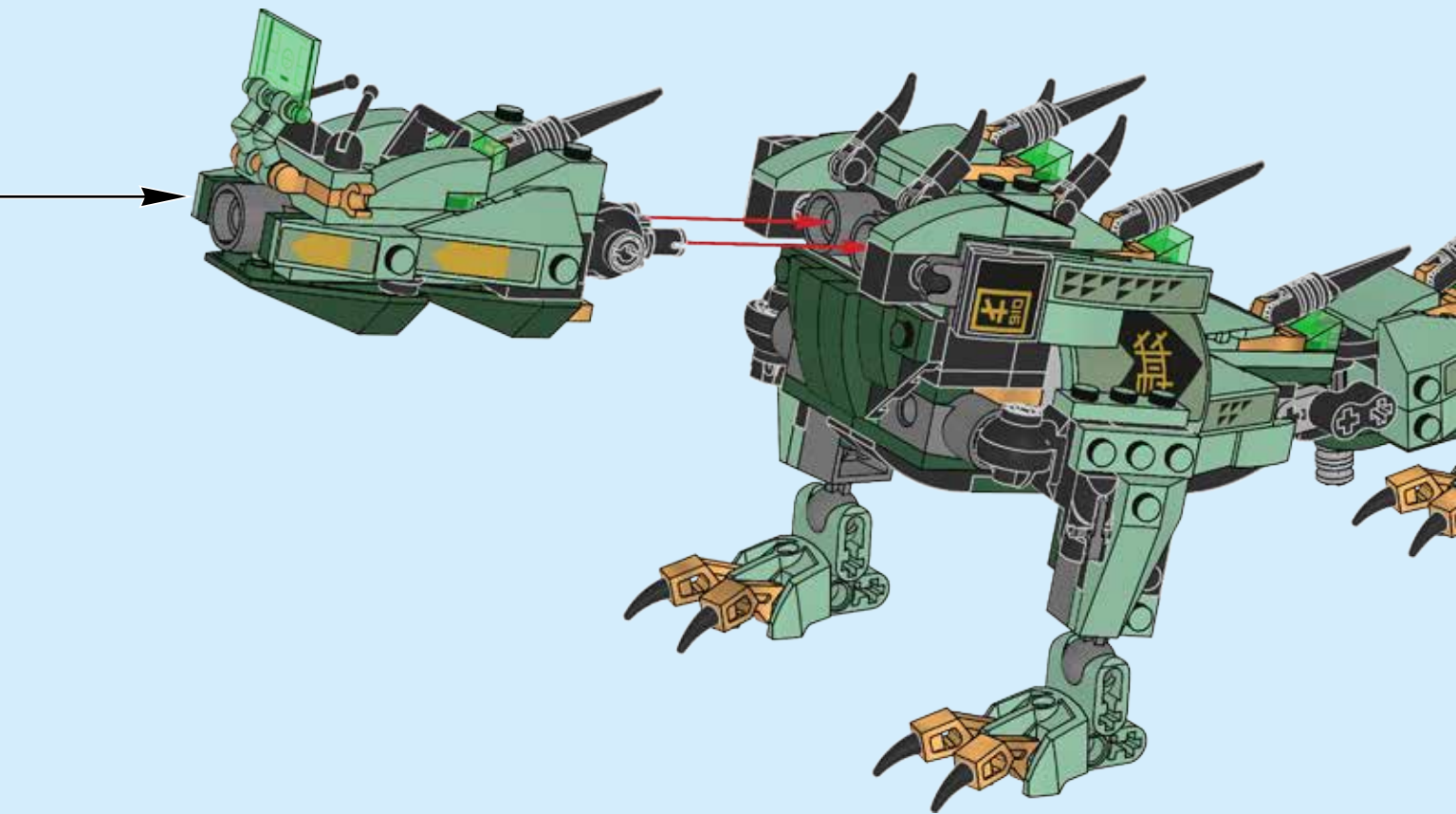

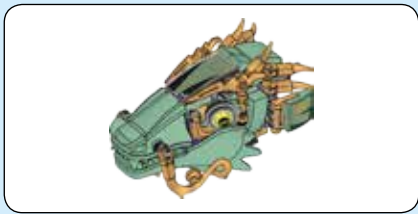

165

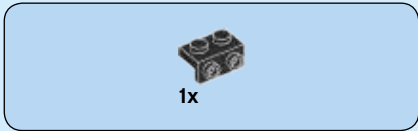
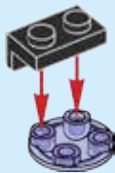

166

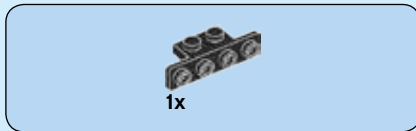
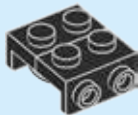

167

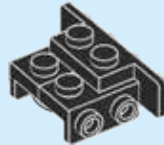

168

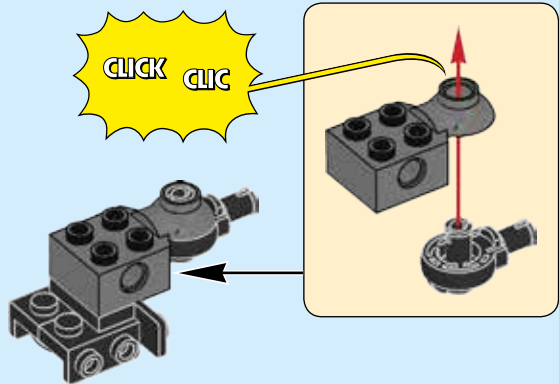

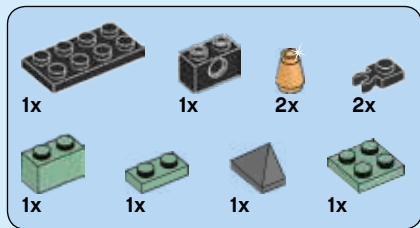

169

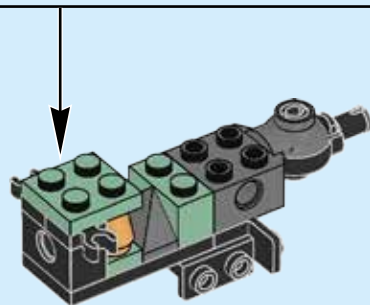
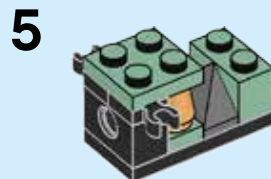
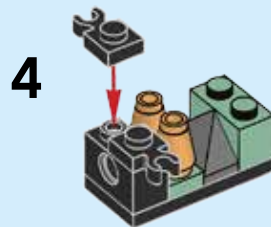
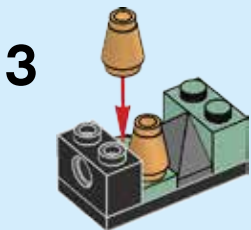
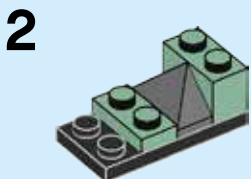
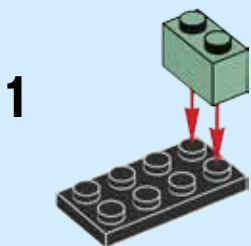



2x

170

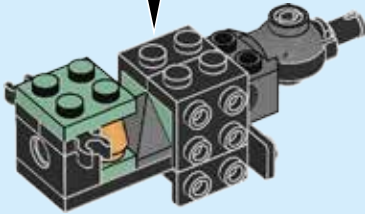
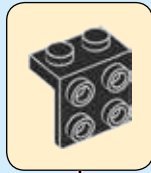

2x

171

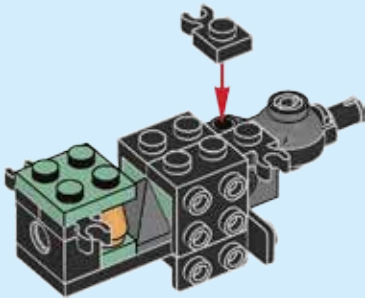

1x

172

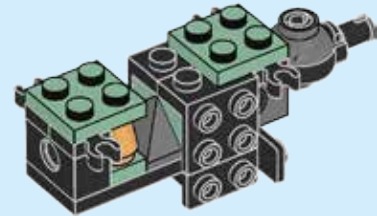



173

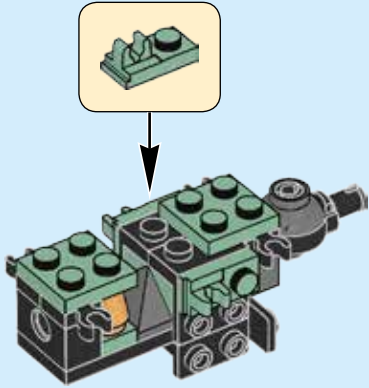

174

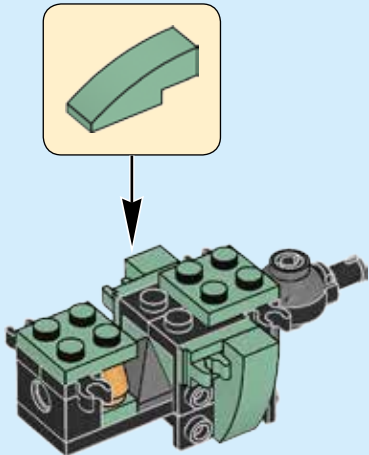

175

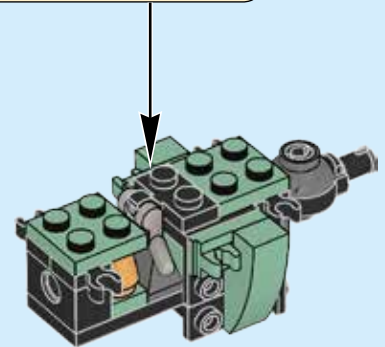
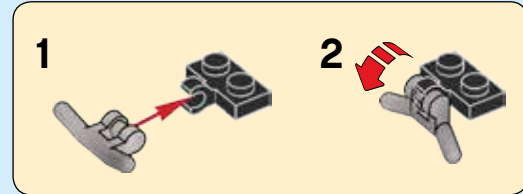



2x

176

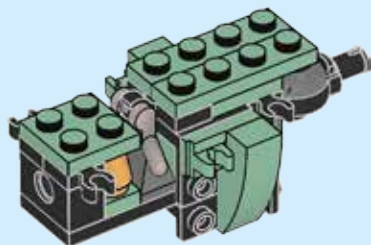

1x



2x

177

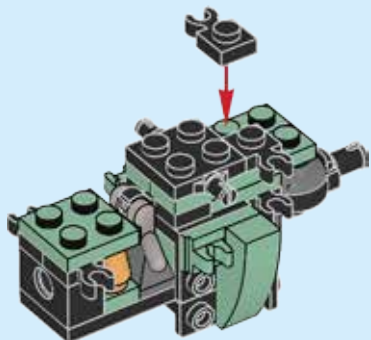

2x



1x

178

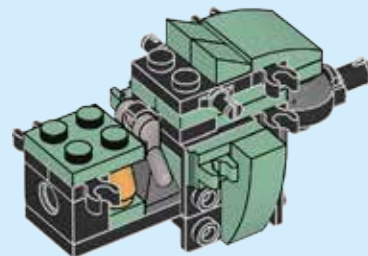

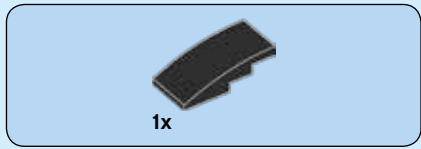

179

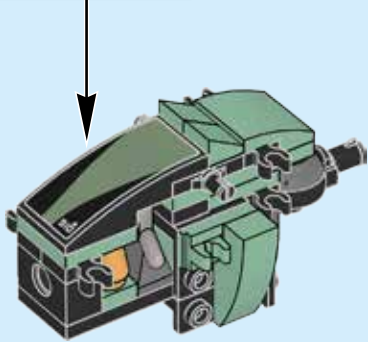
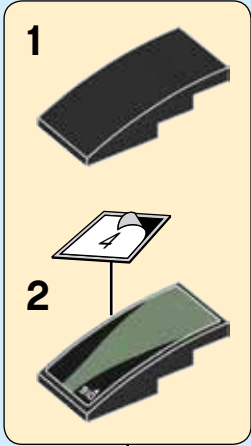

180

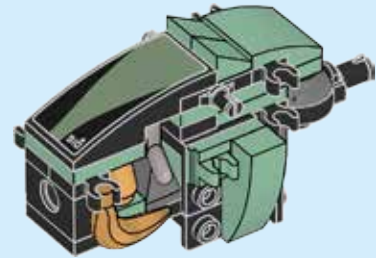



1x



1x

181

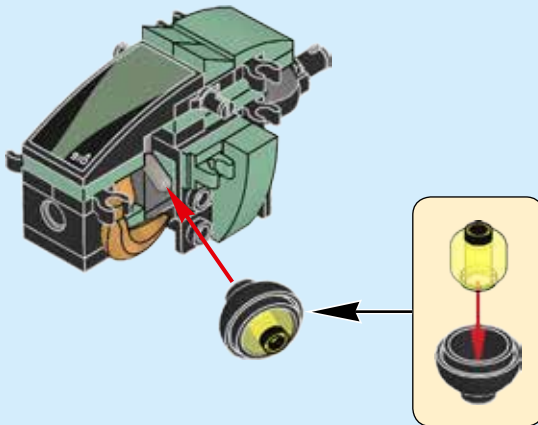

1x



1x

182

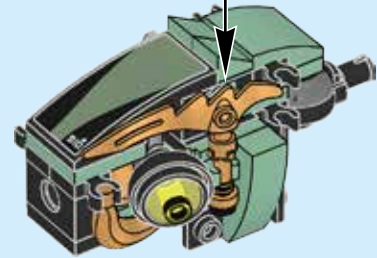
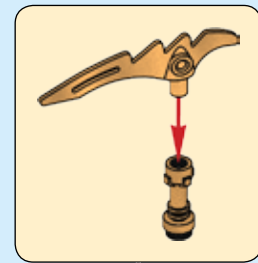



183

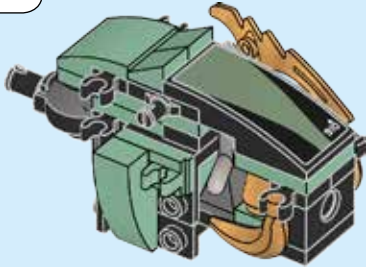
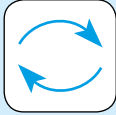

184

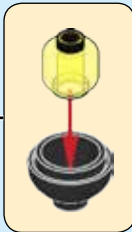
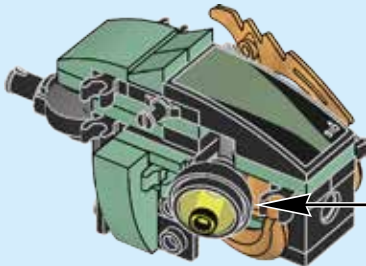

185

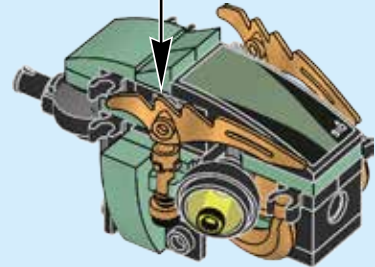
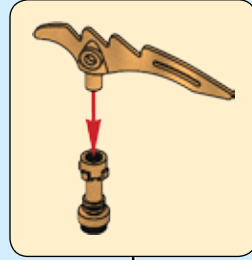

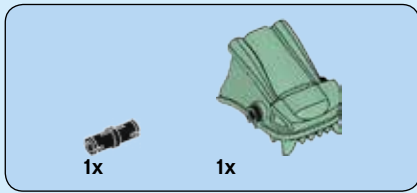

186

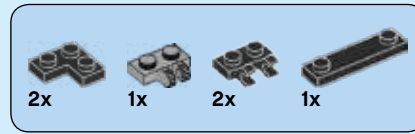
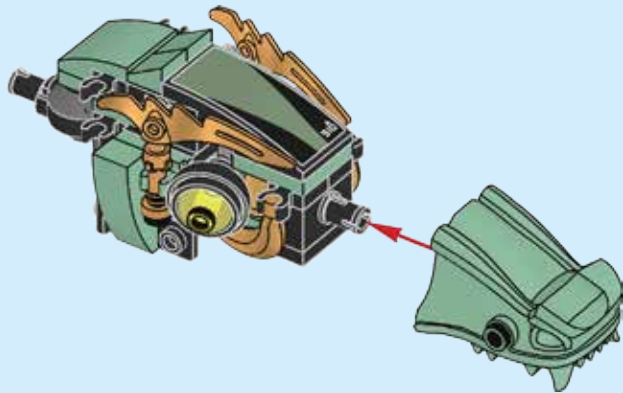

187

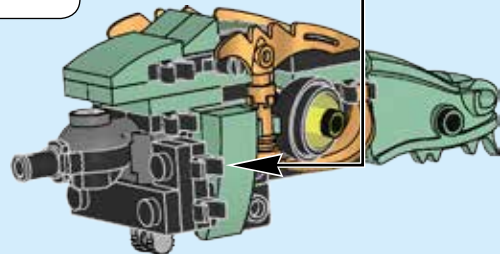
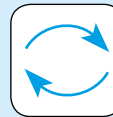
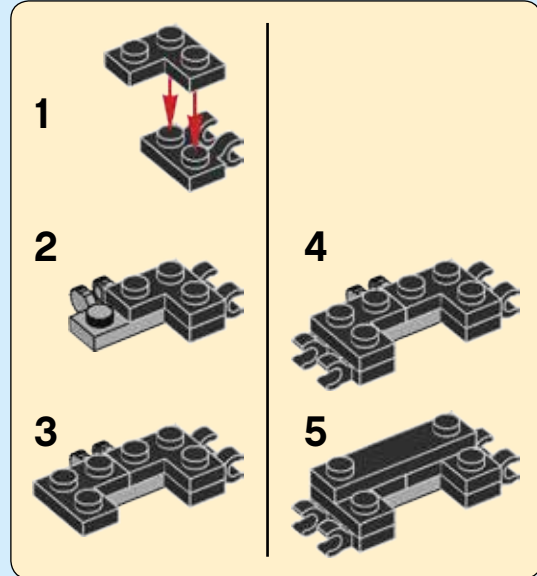

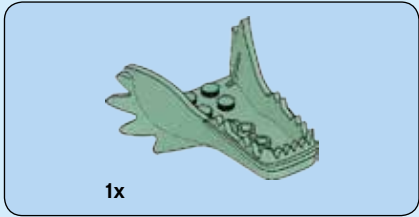

188

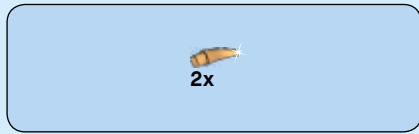
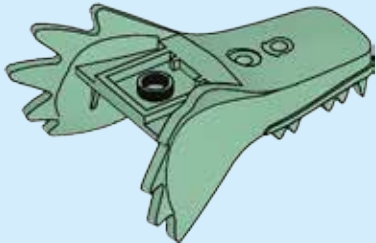

189

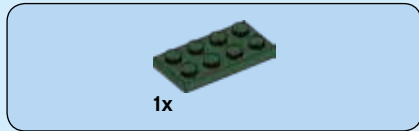
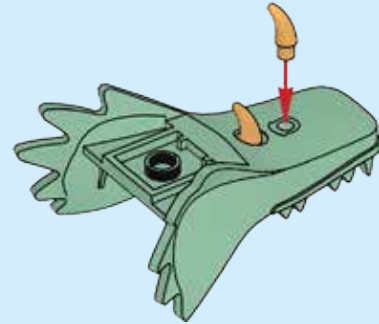

190

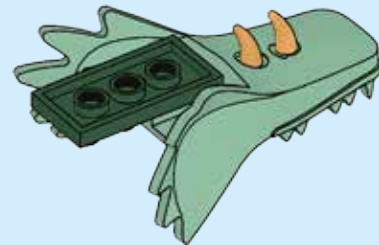



1x

191

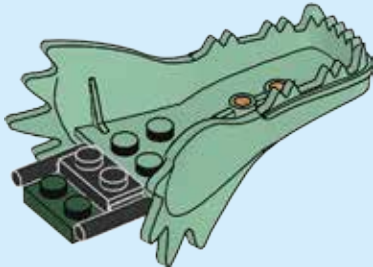
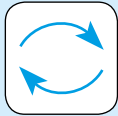

1x

192



1x

193

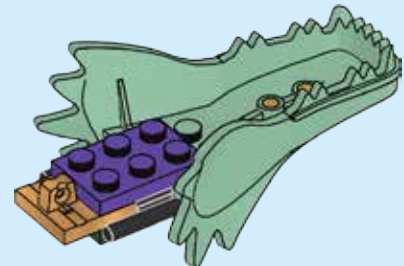

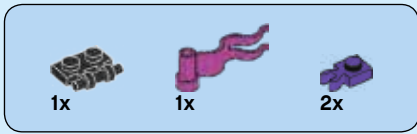

194

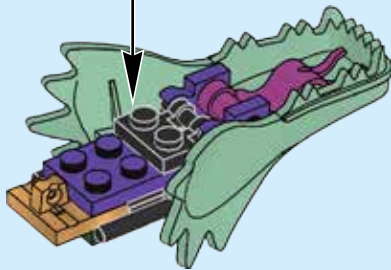
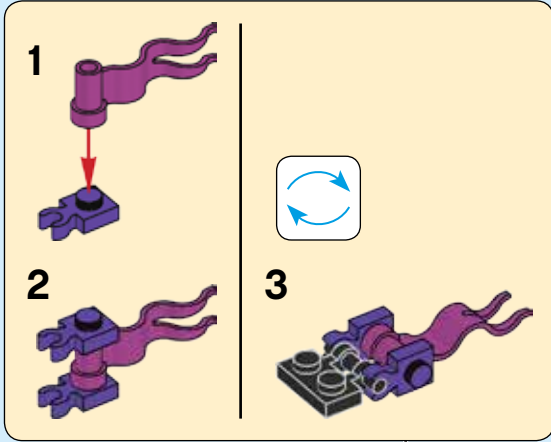

195

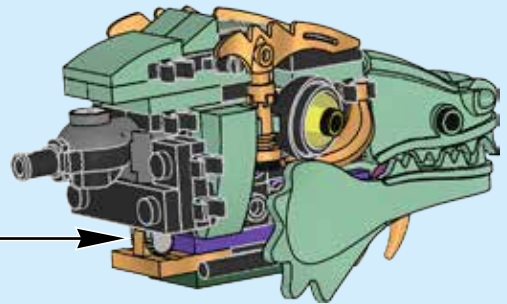



196

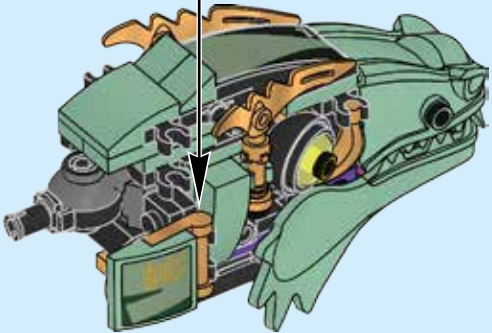
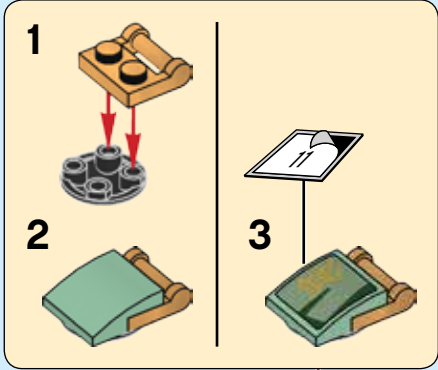

197

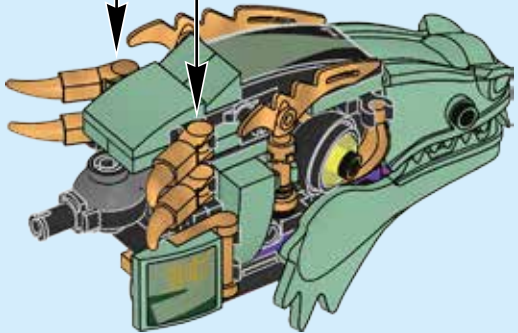
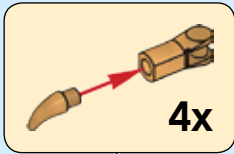



198

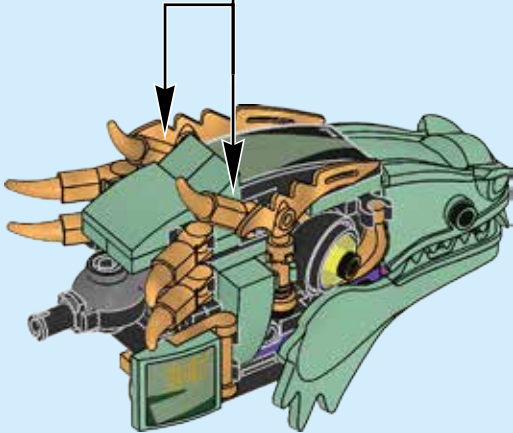
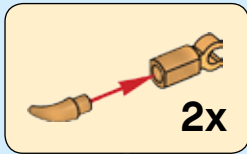

199

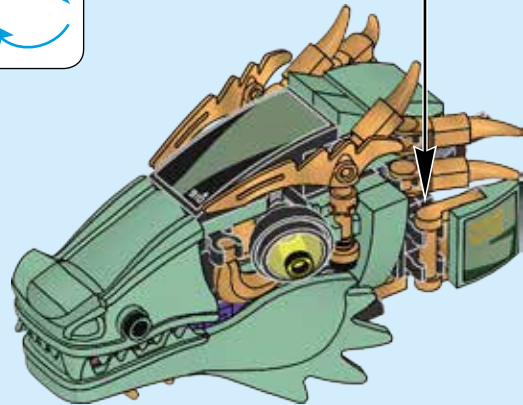
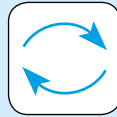
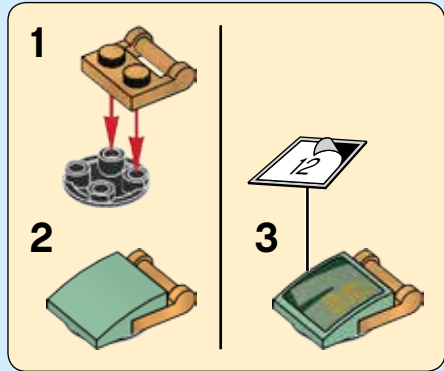



2x

200

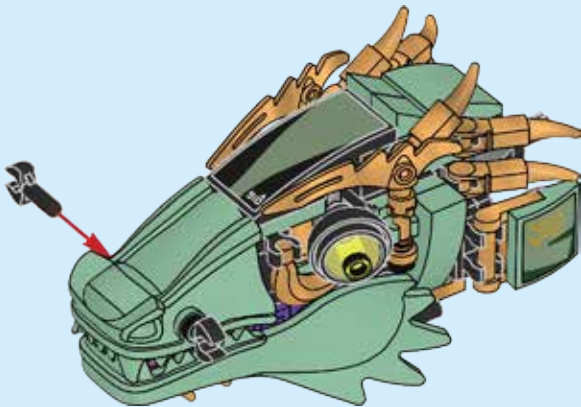

2x



2x

201

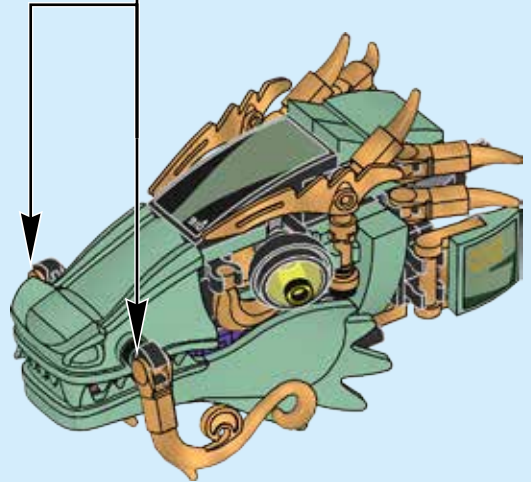
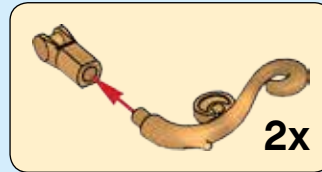

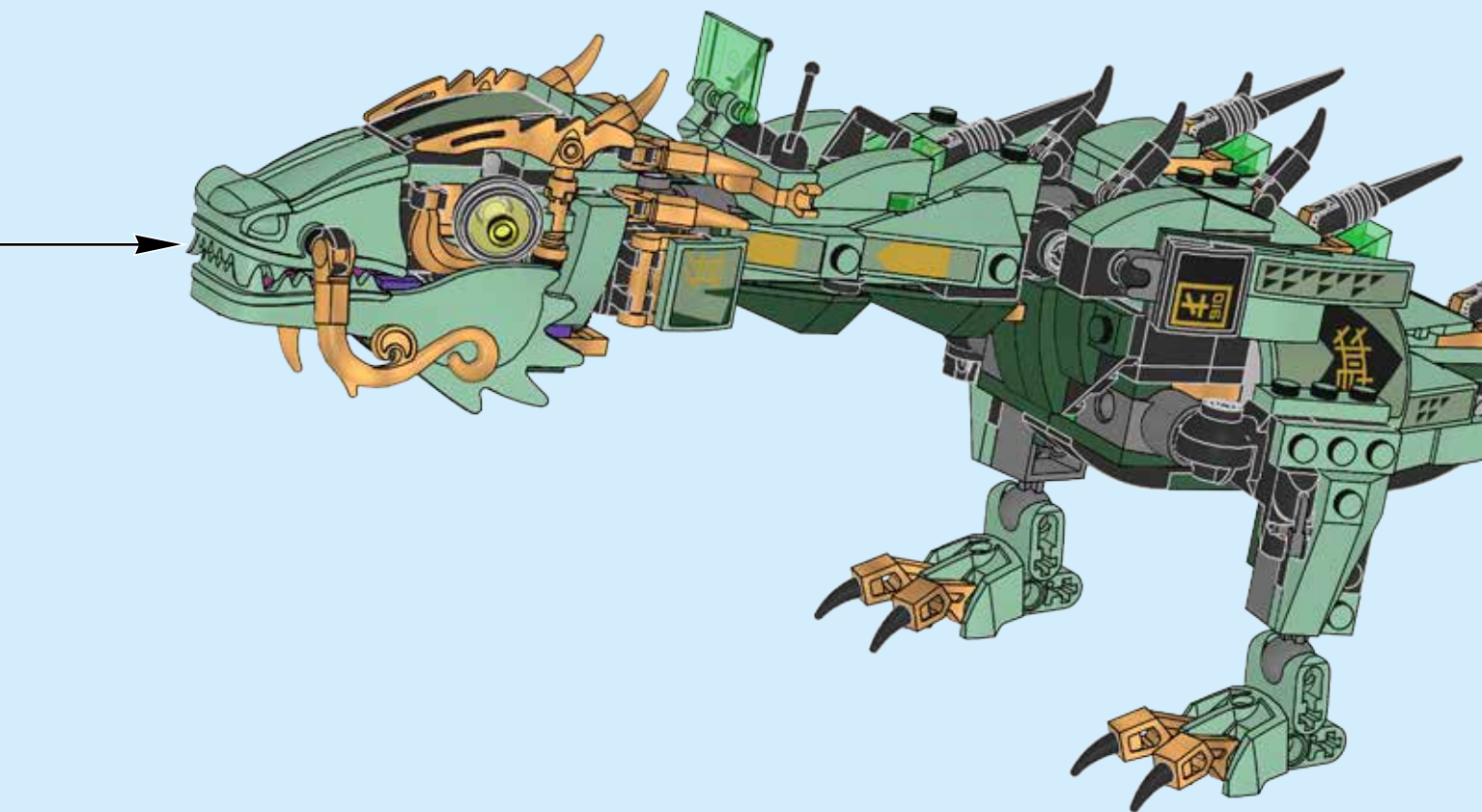



4x

203

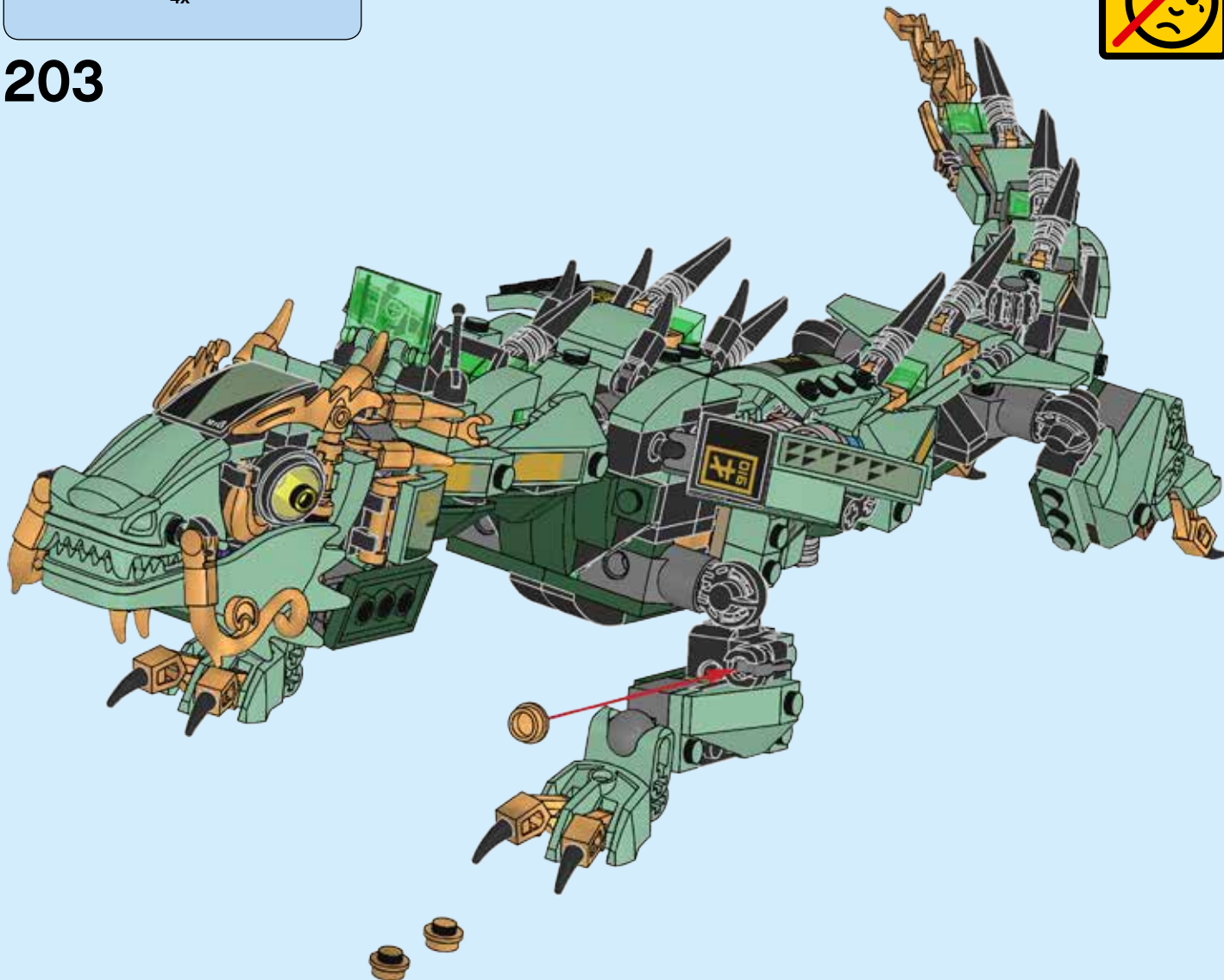

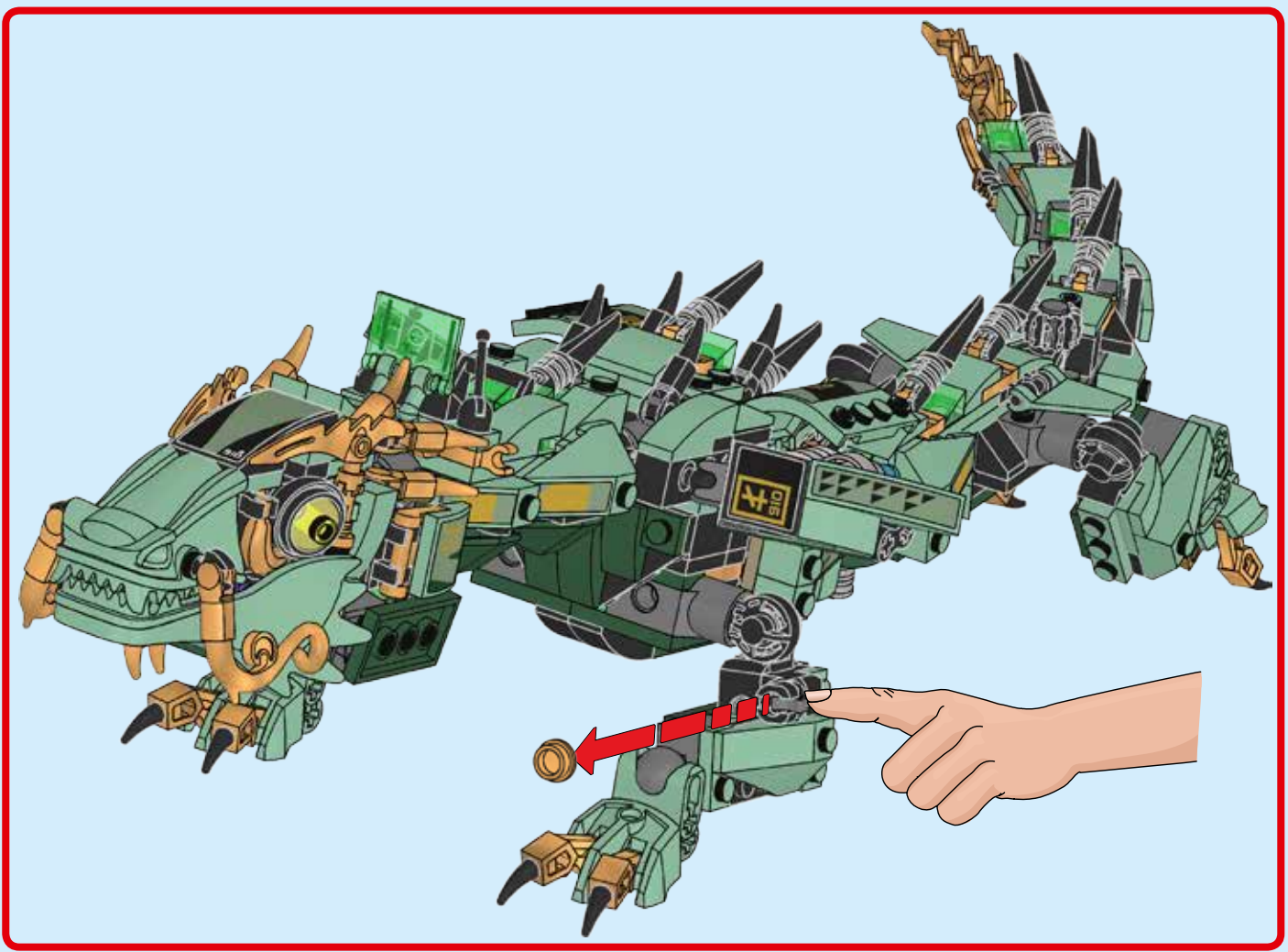

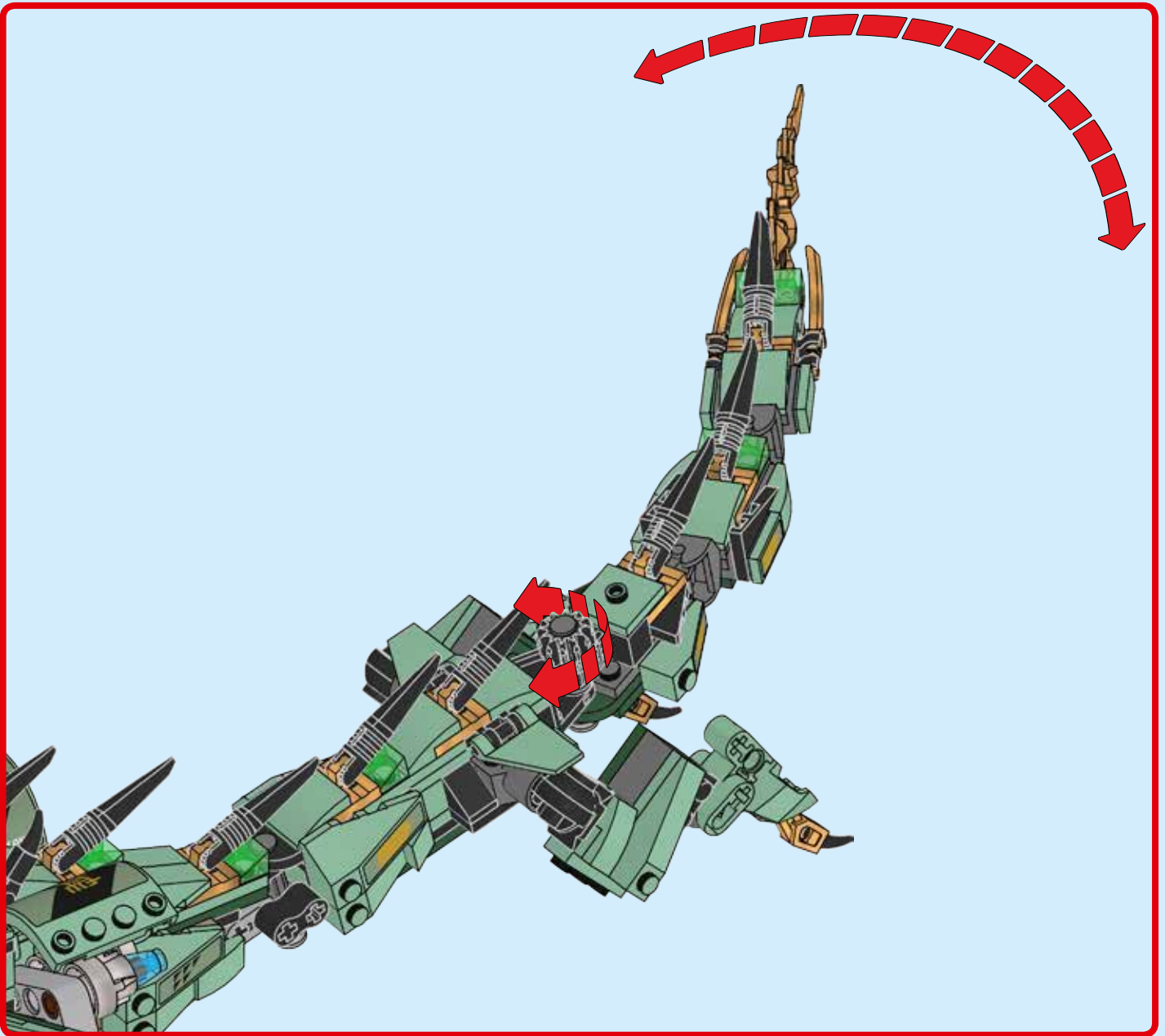

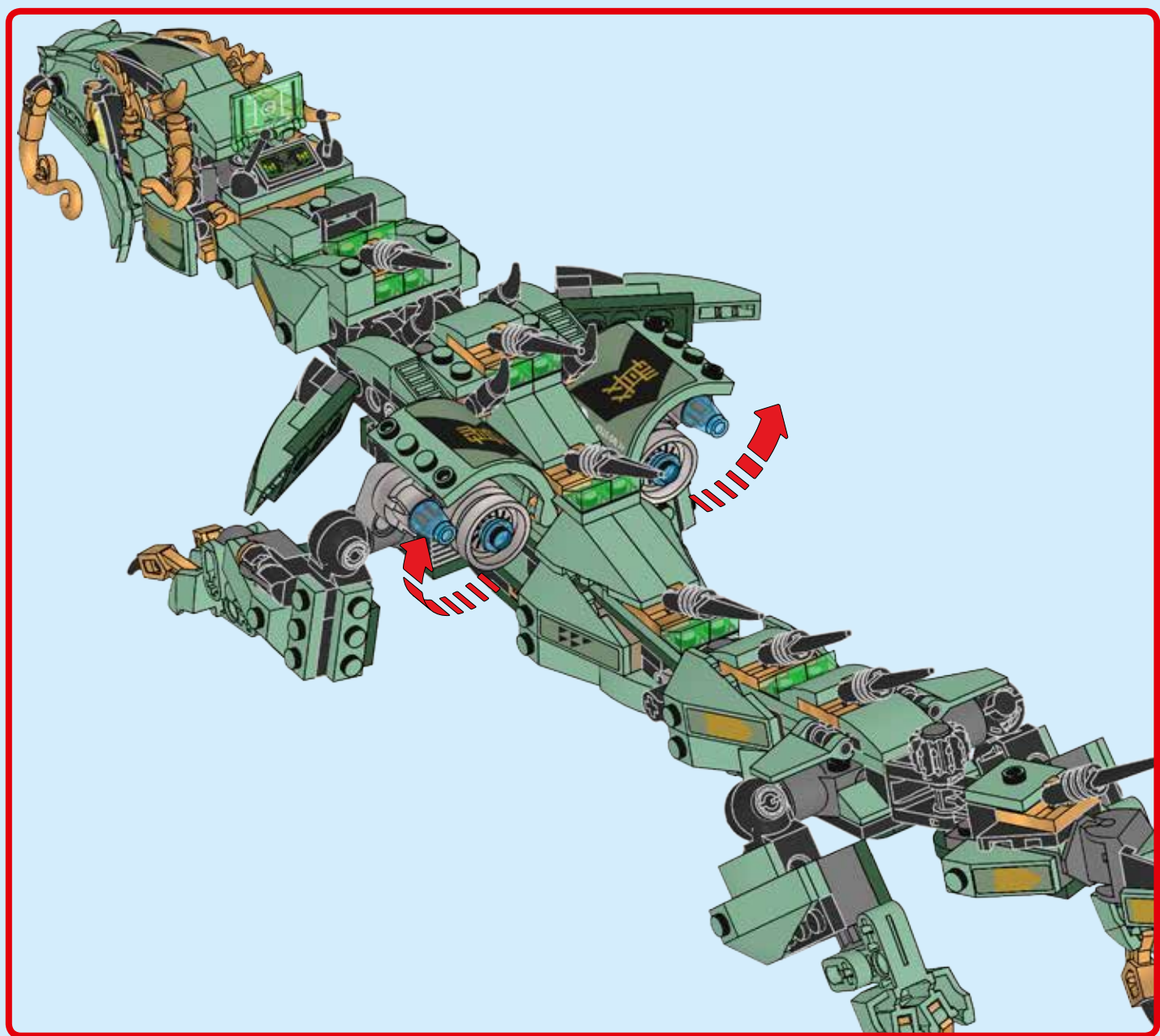

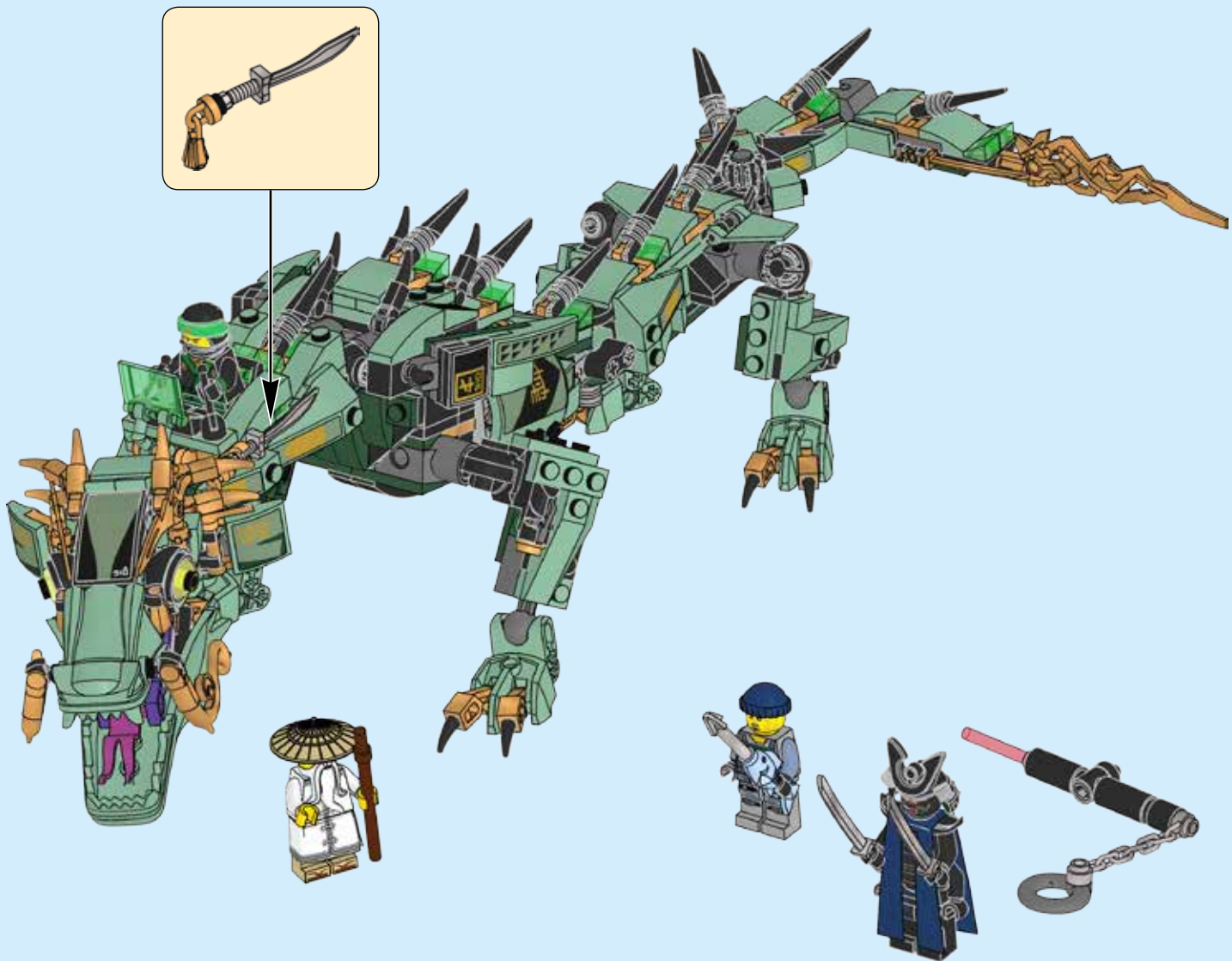

AVAILABLE
FALL 2017



DISPONIBLE
AUTOMNE 2017

DISPONIBLE
OTOÑO 2017



THE NINJAGO MOVIE VIDEOGAME



RATING PENDING
COTE EN ATTENTE

Visit esrb.org for
rating information
Visiter esrb.org
pour les classifications

RP
ESRB

LEGO.com/videogames



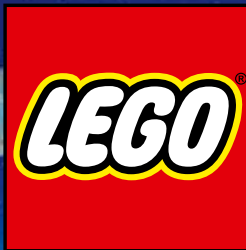

UNLOCK MODEL IN GAME / Separate purchase required
 MODÈLE À DÉVERROUILLER EN JEU / Achat séparé requis
 DESBLOQUEAR MODELO EN EL JUEGO / Se requiere la compra por separado

PPA72V



LEGO.com/worlds



LEGO WORLDS software © 2017 TT Games Ltd. Produced by TT Games under license from the LEGO Group. LEGO, the LEGO logo, the Brick and the Knob configurations and the Minifigure are trademarks of the LEGO Group. © 2017 The LEGO group. All other trademarks and copyrights are the property of their respective owners. All rights reserved. WB GAMES LOGO, WB SHIELD: ™ & © Warner Bros. Entertainment Inc. (s17)

Logiciel LEGO WORLDS © 2017 TT Games Ltd. Produit par TT Games avec l'autorisation du Groupe LEGO. LEGO, le logo LEGO, les configurations de briques et tenons et la minifigurine sont des marques de commerce du Groupe LEGO. © 2017 Le Groupe LEGO. Tous les autres droits d'auteur et marques de commerce sont la propriété de leurs propriétaires respectifs. Tous droits réservés. LOGO WB GAMES, LOGO WBIE, BOUCLIER WB : ™ et © Warner Bros. Entertainment Inc. (s17)

LEGO WORLDS software © 2017 TT Games Ltd. Producido por TT Games bajo licencia de LEGO Group. LEGO, el logotipo de LEGO, la configuración del Ladrillo y de la Perilla, y la Minifigura son marcas comerciales de LEGO Group. © 2017 The LEGO Group. Todas las demás marcas comerciales y derechos de autor son propiedad de sus respectivos propietarios. Todos los derechos reservados. LOGOTIPO DE WB GAMES, LOGOTIPO DE WBIE, ESCUDO DE WB: ™ y © Warner Bros. Entertainment Inc. (s17)

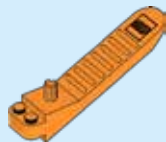

1x
4654448



1x
6134642



8x
4143005



3x
4206482



1x
6192537



1x
6172557



1x
6192818



1x
6191962



1x
6192506



1x
6195289



2x
73587



4x
6143318

66



1x
306226



2x
6168646



1x
6167933



2x
4289538



1x
6194096



1x
4560174



4x
654126



1x
6173926



12x
4568385



1x
6202746



1x
4177431



2x
4184169



6x
4550017



1x
4180508



1x
4180536



2x
6173119



9x
4143372



1x
4548180



1x
4109810



2x
6102341



2x
4278359



3x
4121715



2x
4198367



1x
6194166



2x
287726



1x
6191983



1x
3200026



3x
370026



1x
243226



1x
6178922



2x
302326



2x
4121966



1x
6132731



2x
6000650



4x
6016172



2x
6117973



4x
4556158



1x
6193903



3x
4140588



1x
4114671



7x
4213374



4x
242026



1x
6061032



2x
6065077



2x
6089119



2x
235726



1x
4107765



9x
6173917



2x
6102734



1x
6192798



1x
6190162



1x
6194128



1x
460026



1x
317626



1x
6195486



3x
6089577



1x
4531412



1x
383926



1x
370526



4x
6039869



1x
4599499



2x
371026



4x
370126



6x
6187578



3x
302026



1x
4647286



1x
6181757



1x
6181757



1x
241926



2x
366626



1x
4243819



3x
379526



1x
383226



1x
6129807



2x
4107758



1x
4124108



2x
4567331



2x
3005743



4x
3006848



3x
4217436



16x
4244573



1x
6197873



2x
6109893



3x
4211573



3x
4211483



2x
4211741



1x
6192577



1x
4515341



2x
4211610



2x
6170761



2x
6055225



2x
4267850



2x
6064112



2x
4650244



1x
6055239



11x
4586057

	2x 6196590		1x 6186826		1x 6195100		1x 6195100		1x 4609289		1x 4227395		2x 6179794		2x 4646871
	9x 4245566		2x 6075624		10x 6069257		2x 6196587		2x 302301		2x 4264952		8x 4618195		2x 6116596
	2x 6174940		6x 6100237		10x 6069257		2x 6196587		1x 6192727		2x 4265486		8x 6006741		1x 6162578
	6x 4652205		6x 6100237		6x 6100237		7x 6194726		2x 6051334		2x 4265486		7x 4523160		1x 6162578
	2x 6146094		12x 4598531		12x 4598531		7x 6194726		2x 6051334		1x 6195347		7x 4523160		1x 6162578
	4x 4616578		3x 6184348		3x 6184348		1x 6195101		1x 6076203		2x 6176821		2x 4490599		4x 6123838
	6x 4616581		10x 6100234		10x 6100234		1x 6195101		2x 6146792		3x 4225142		1x 6120120		1x 6158405
	2x 4625236		6x 6187610		6x 6187610		2x 6135494		10x 6000606		2x 6003147		3x 4585493		2x 6102594
	10x 4655080		2x 6187610		2x 6187610		1x 6081990		1x 6198035		1x 6182423		9x 6162885		2x 6116593
	8x 6196591		2x 6187611		2x 6187611		1x 6081990		1x 6198035		2x 6078364		10x 6195270		1x 6064049
	2x 6155256		4x 6197561		4x 6197561		1x 6133790		2x 4581225		6x 6197509		2x 6172437		
	2x 6155255		6x 6187609		6x 6187609		1x 6133790		7x 4225973		4x 4523159				
	10x 6080431		4x 6197561		4x 6197561		1x 4528604		2x 6083620		2x 4529247				
	5x 6186823		2x 6075626		2x 6075626		4x 4541618		4x 4497253						

Customer Service

Kundenservice

Service Consommateurs

Servicio Al Consumidor

LEGO.com/service or dial



: 00800 5346 5555

: 1-800-422-5346

LEGO **NINJAGO**
The Ride

THE LEGO NINJAGO MOVIE © & ™ Warner Bros. Entertainment Inc. & The LEGO Group. LEGO, the LEGO logo, NINJAGO and the Brick and Knob configurations are trademarks of the/son des marques de commerce du/son marcas registradas de LEGO Group. ©2017 The LEGO Group. All rights reserved/Tous droits réservés/Todos los derechos reservados. (s17)
6213512



LEGO
LEGOLAND
RESORTS
CALIFORNIA • FLORIDA

EXCLUSIVELY! • EXCLUSIVEMENT ! • ¡EN EXCLUSIVA! • EXCLUSIVELY!

LEGO
LEGOLAND
DISCOVERY CENTER

Arizona • Atlanta • Boston • Chicago
Dallas/Fort Worth • Kansas City
Michigan • Toronto • Westchester



LEGO, the LEGO logo, NINJAGO, the NINJAGO logo, the Minifigure and LEGOLAND are trademarks and/or copyrights of the/son des marques de commerce et/ou copyrights du/son marcas registradas, algunas de ellas protegidas por derechos de autor, de LEGO Group. ©2017 The LEGO Group. LEGOLAND is part of Merlin Entertainments plc.

LEGOLAND.COM