

HIDDEN SIDE™

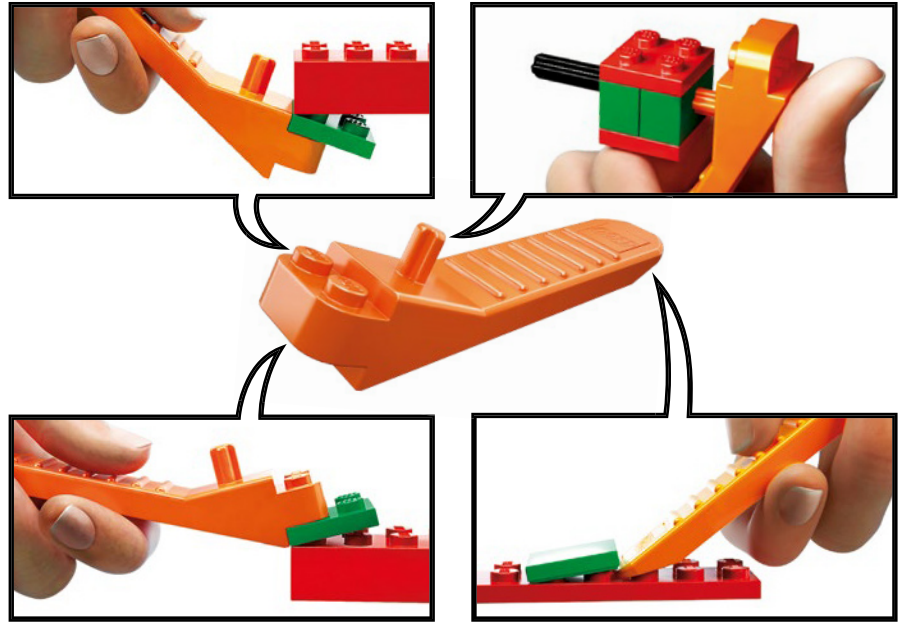

70432





LEGO.com/brickseparator

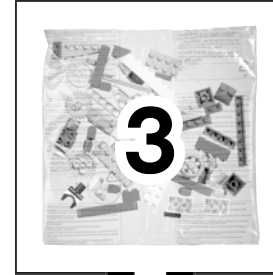
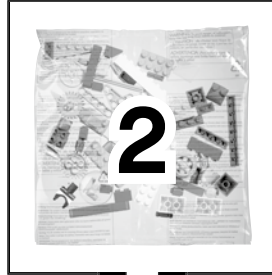

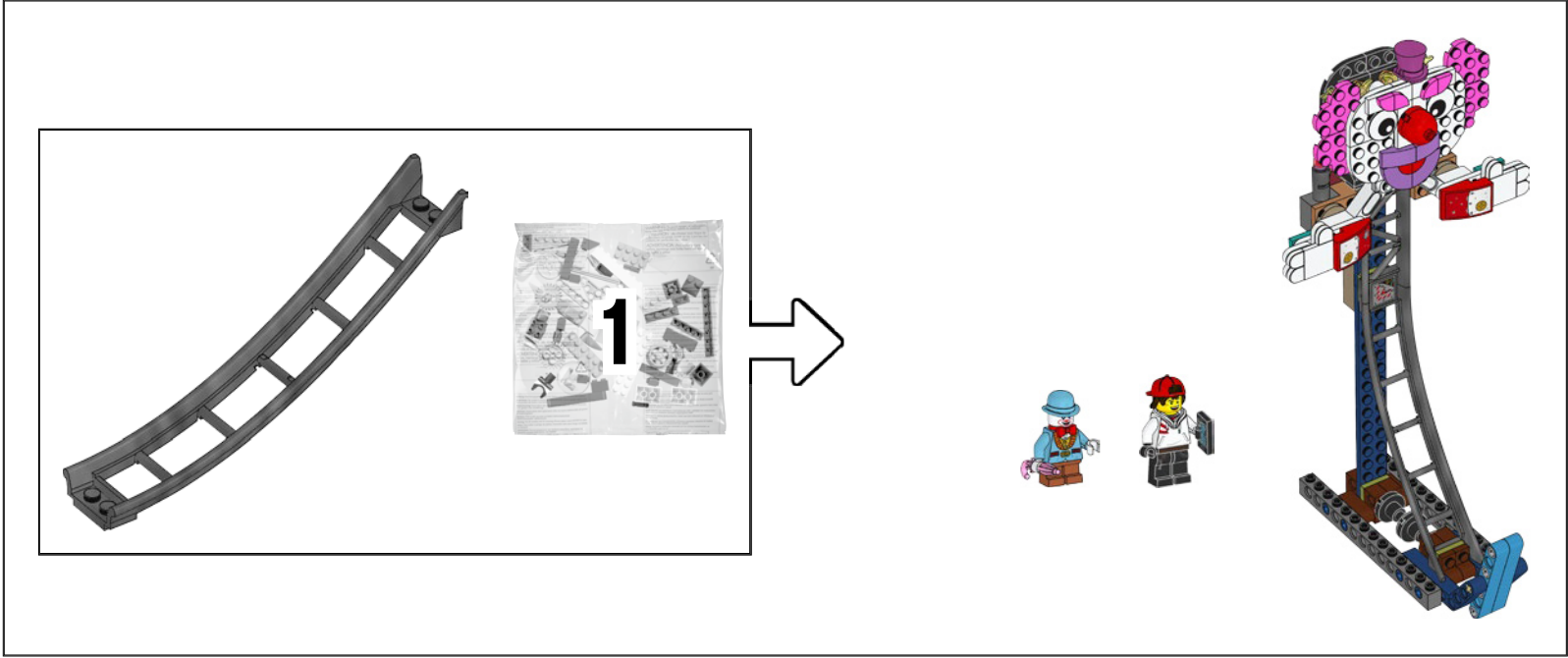



HIDDEN SIDE™

**FREE
INTERACTIVE APP**

**APPLICATION
INTERACTIVE
GRATUITE**

**APP INTERACTIVA
GRATIS**



LEGO® Hidden Side™
LEGO.com/devicecheck

Check for compatibility
Vérifier la compatibilité
Comprueba tu compatibilidad

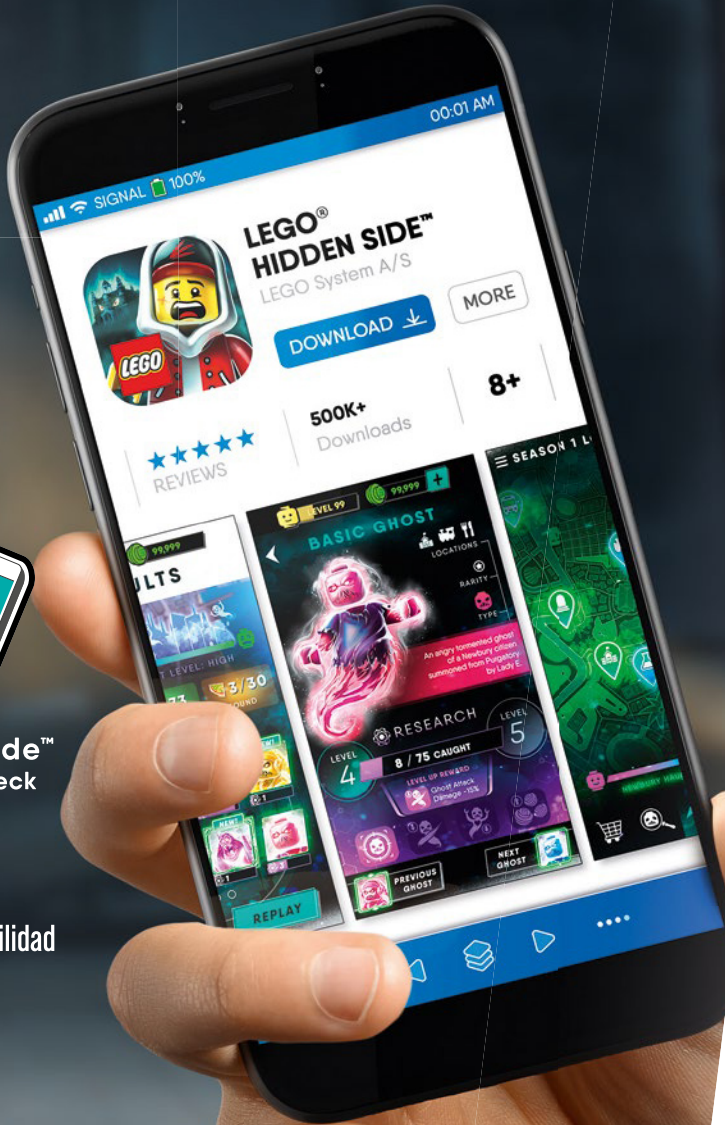

Play in a well-lit area.

**Joue dans un endroit
bien éclairé.**

**Juega en un área
bien iluminada.**



Play on a clean, flat surface.

Joue sur une surface propre et plane.

**Juega sobre una superficie
lisa y despejada.**



Avoid patterned and reflective surfaces.

**Évitez les surfaces à motifs et
réfléchissantes.**

**Evita las superficies decoradas
con patrones y reflejantes.**



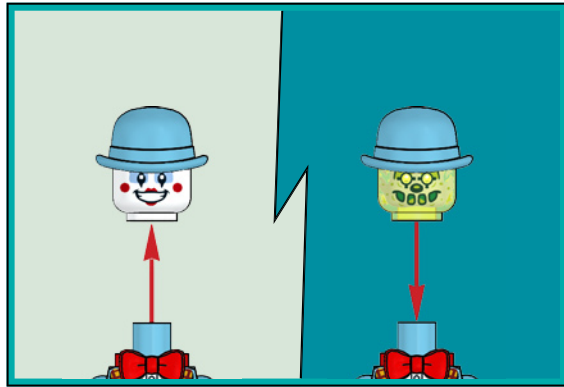
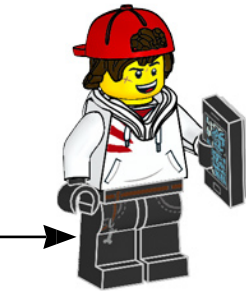
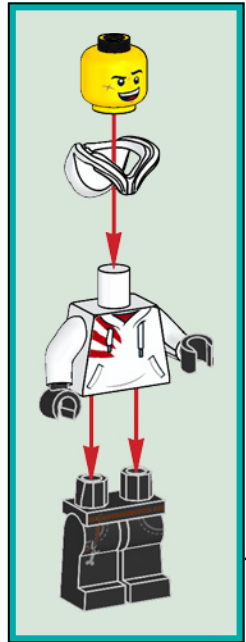

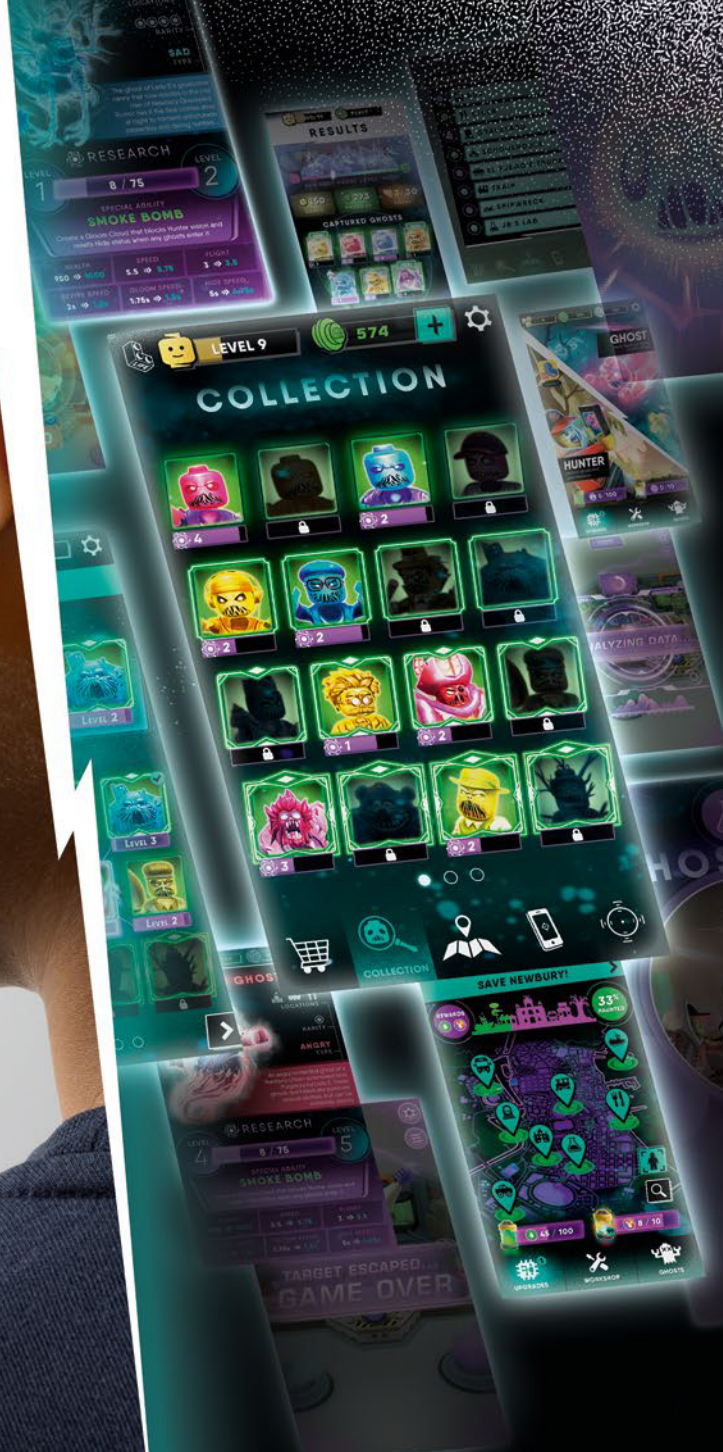

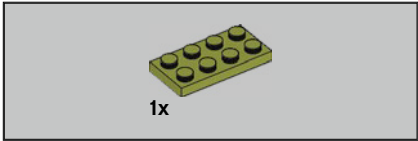
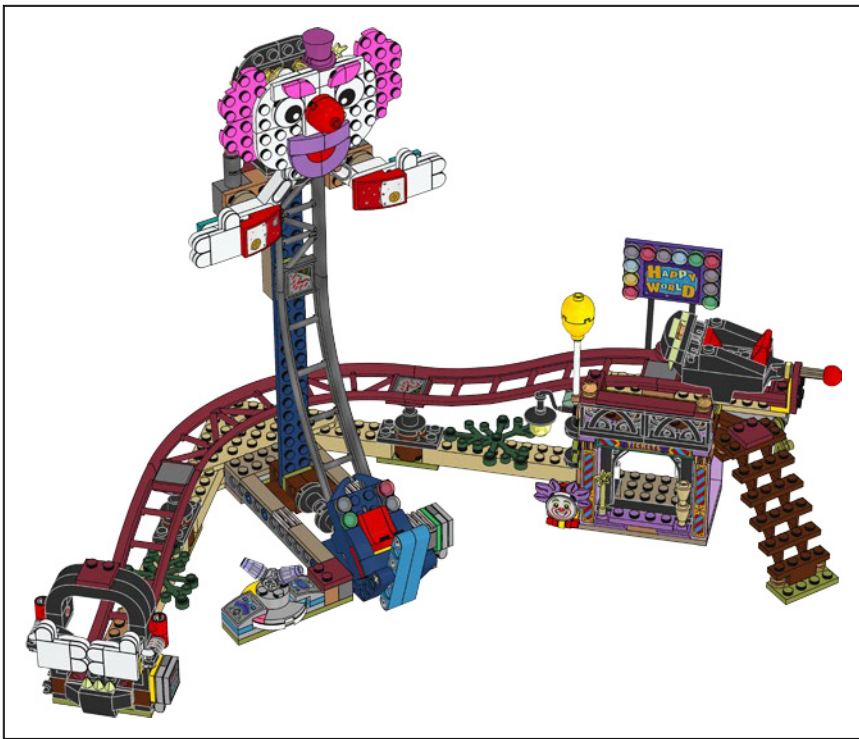

1

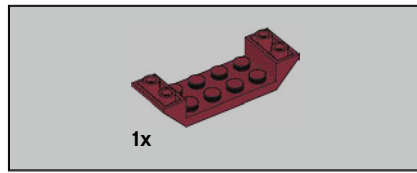
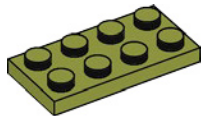

2

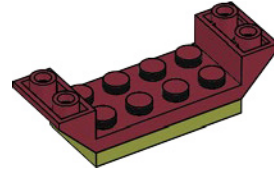

3

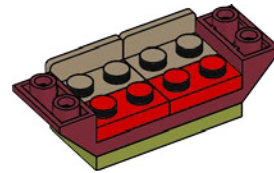

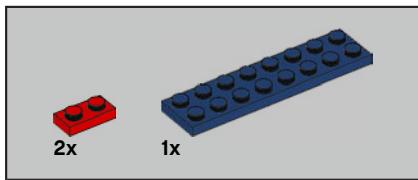

4

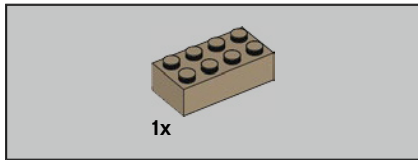
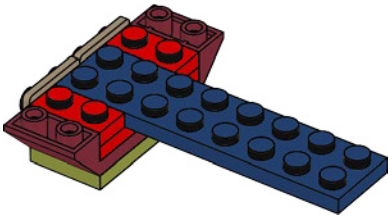

5

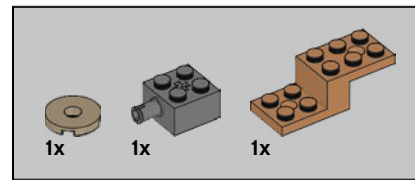
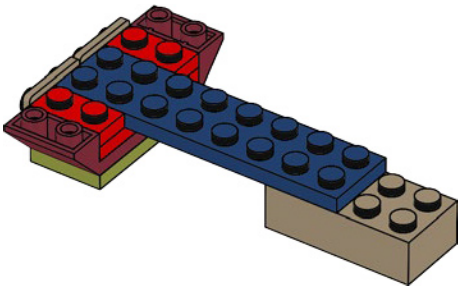

6

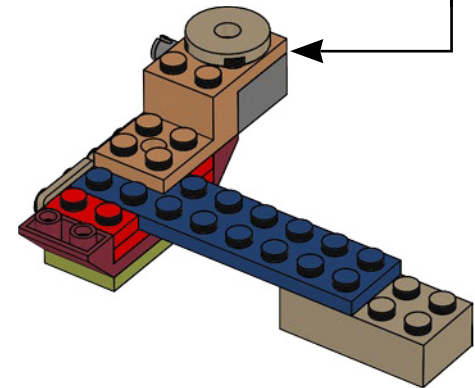
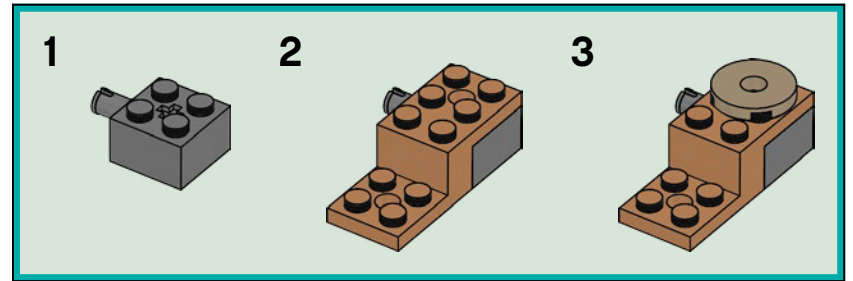

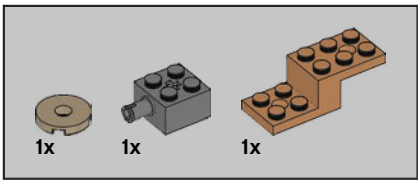

7

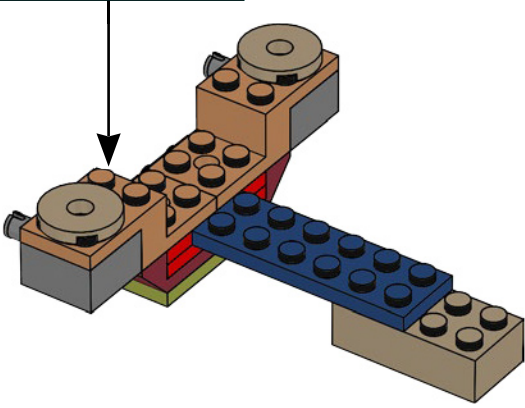
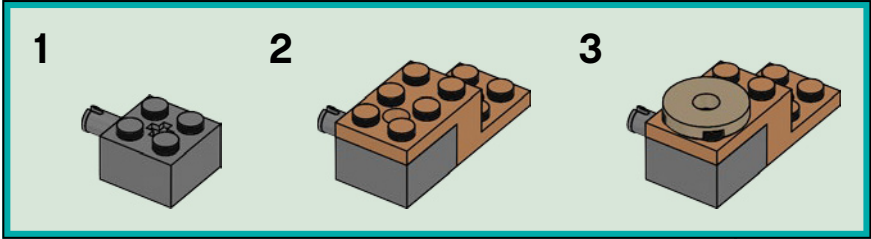

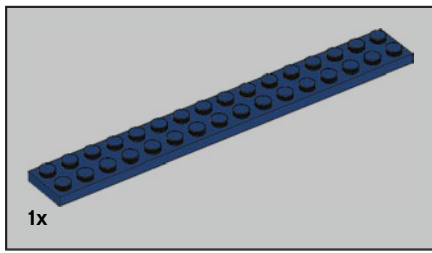

8

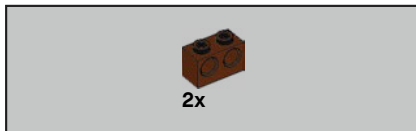
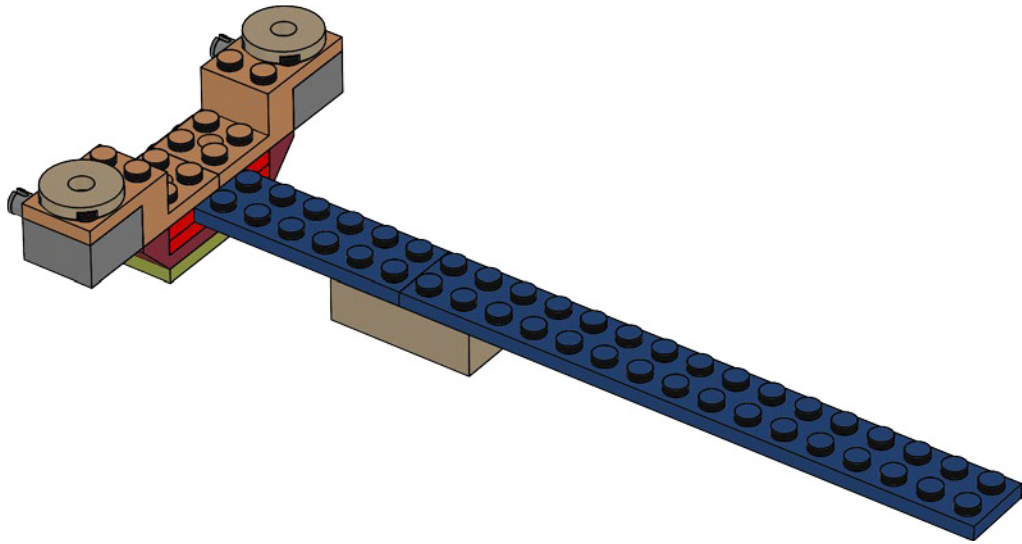

9

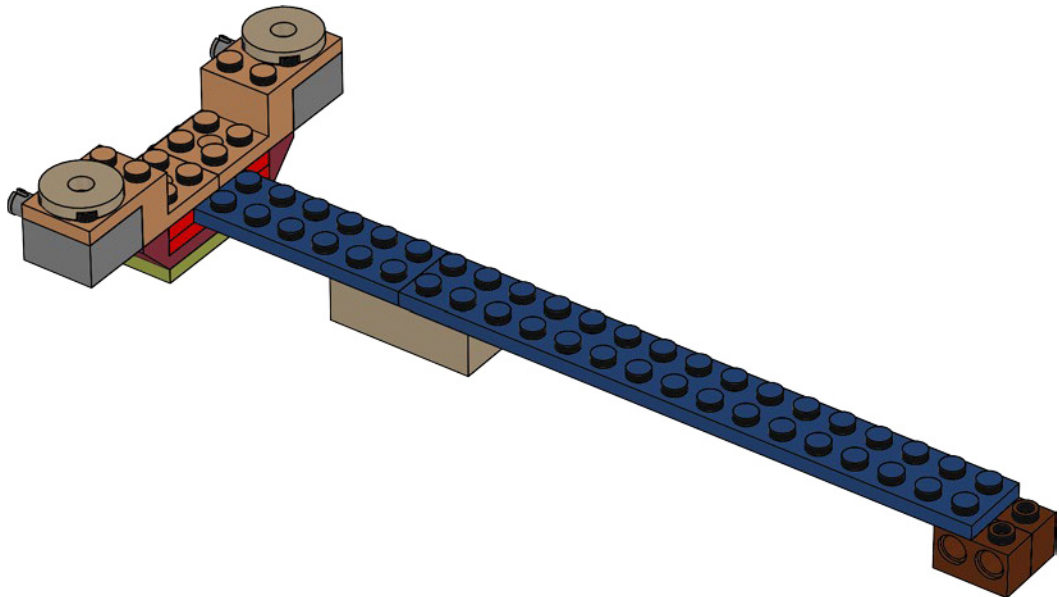



1x

10

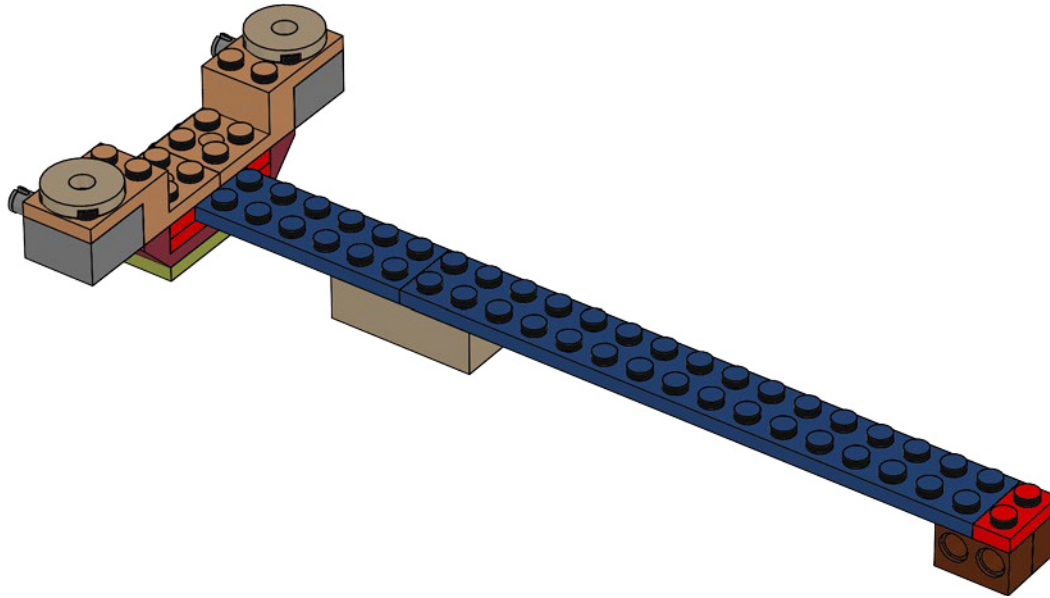

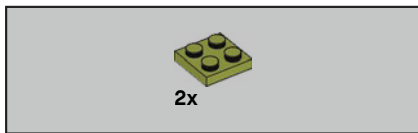

11

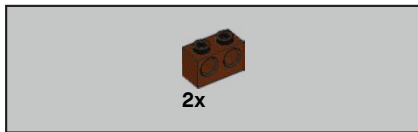
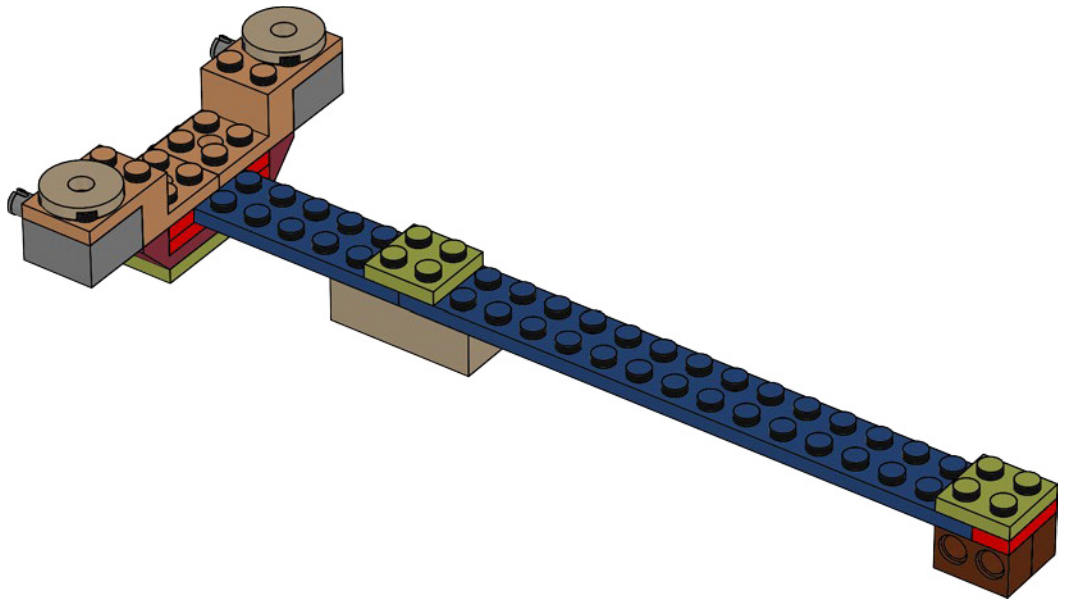

12

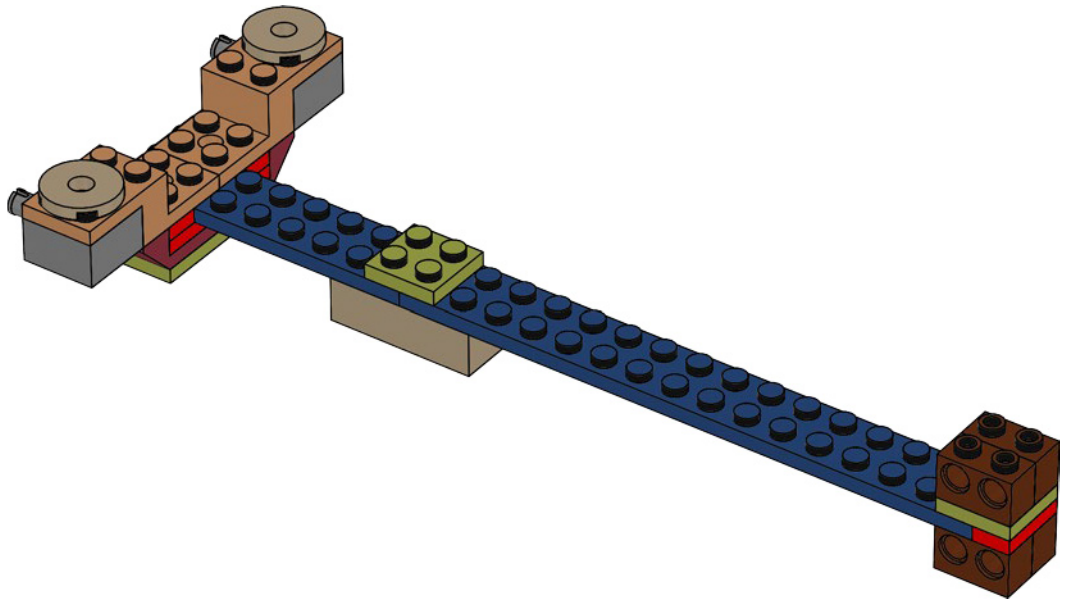



13

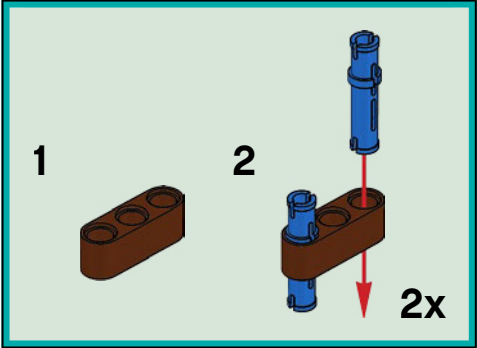
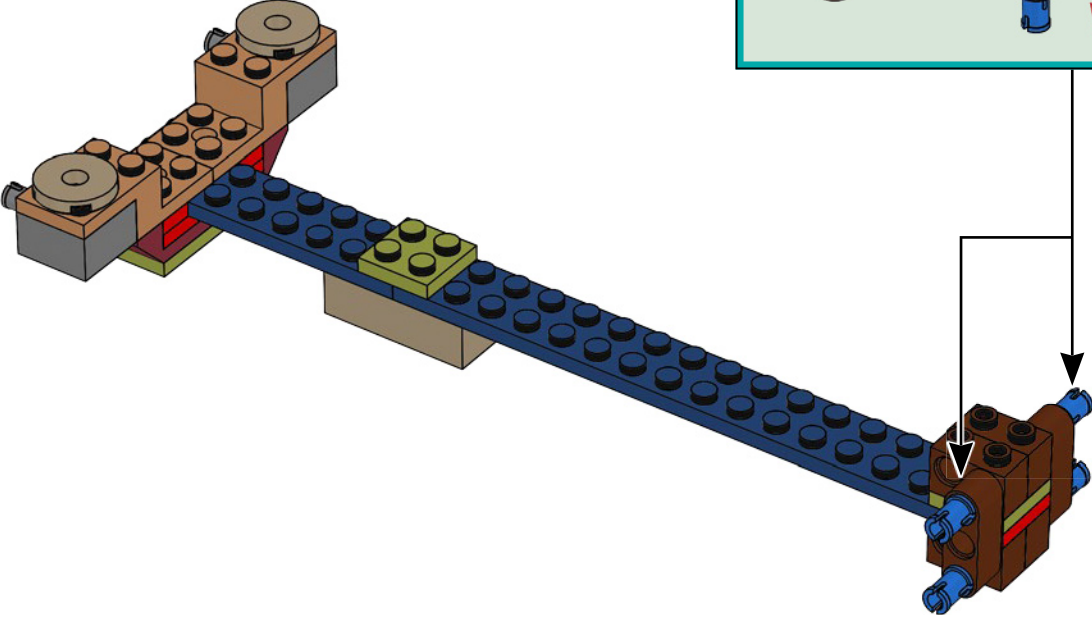

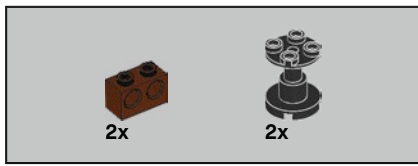

14

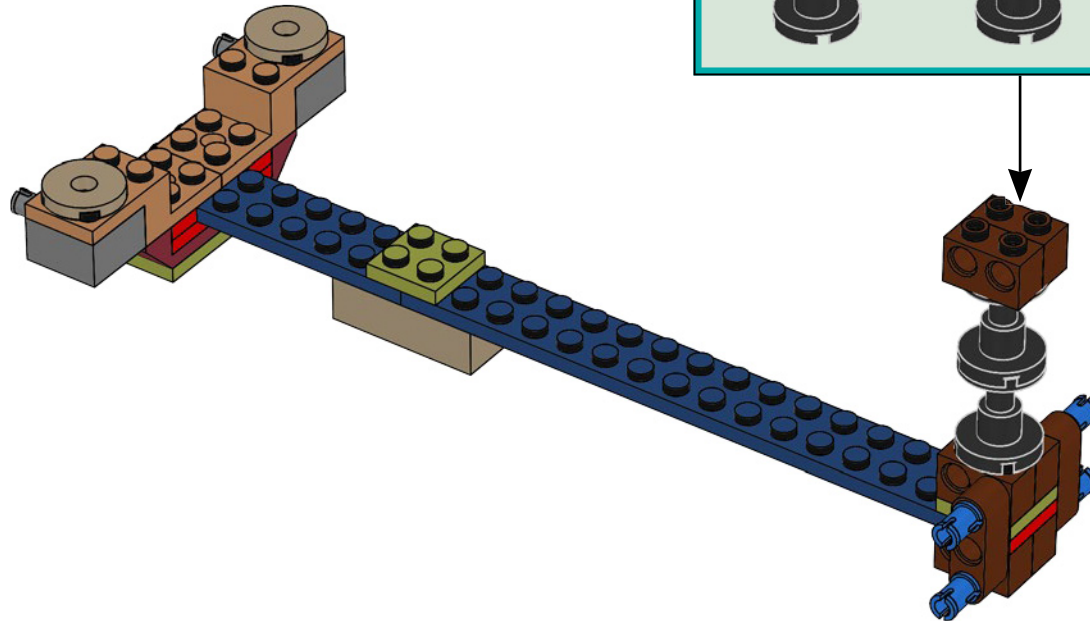
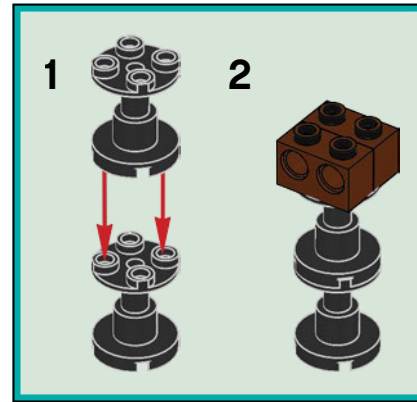

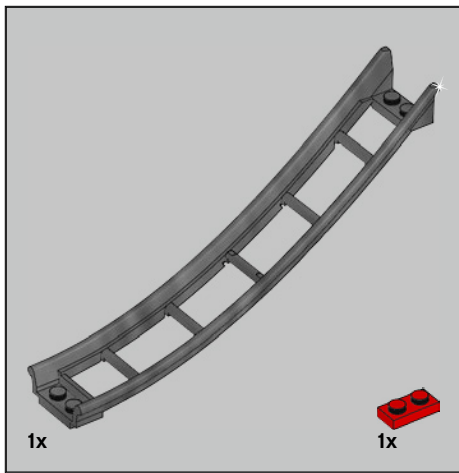

15

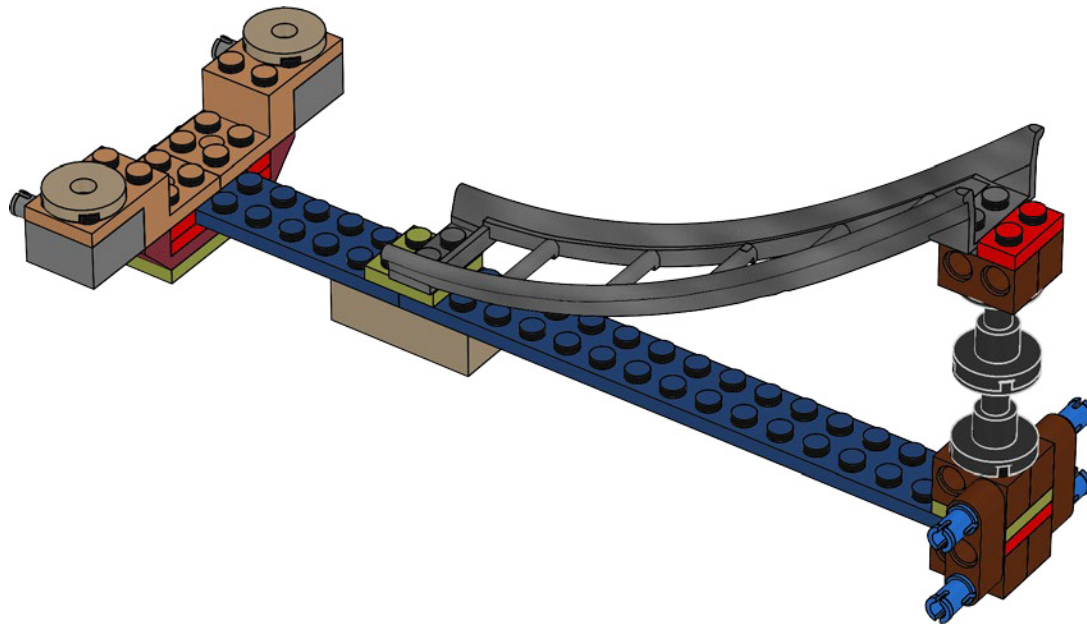

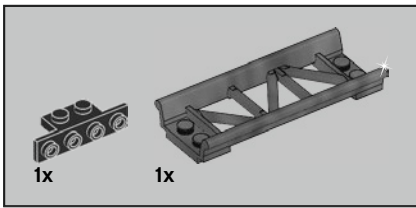

16

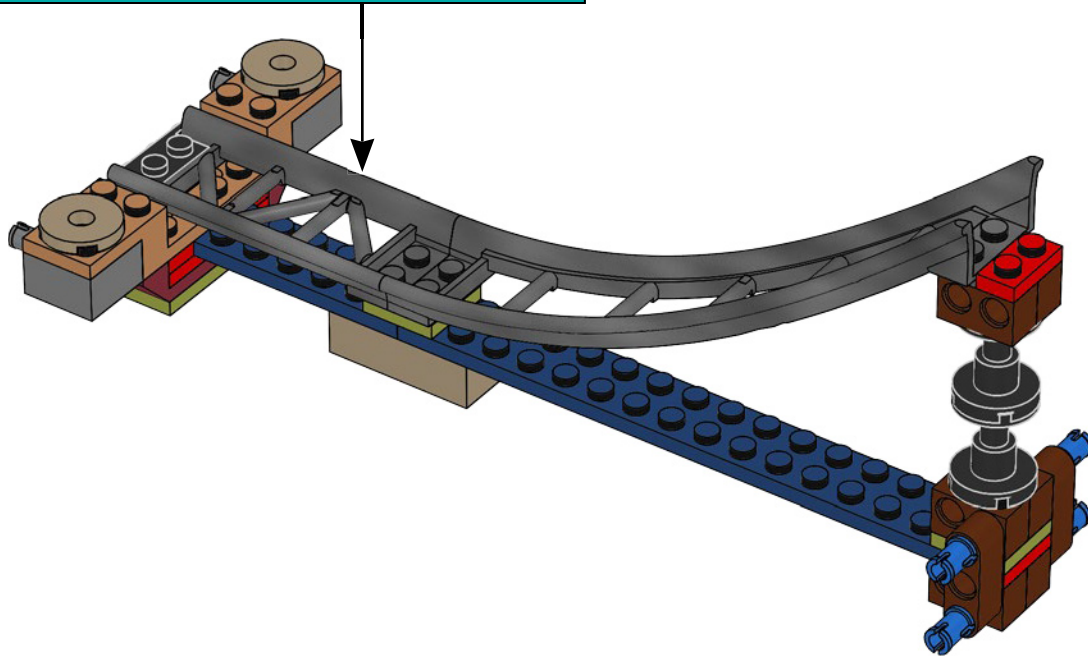
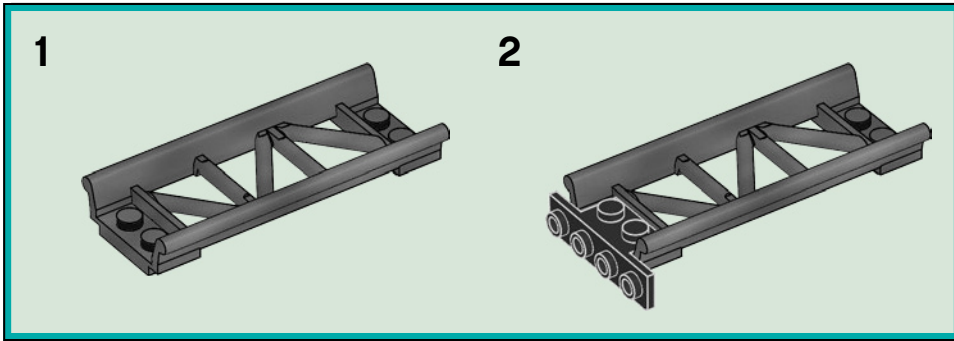

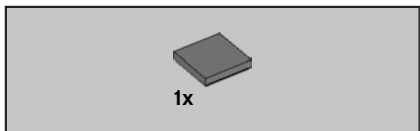

17

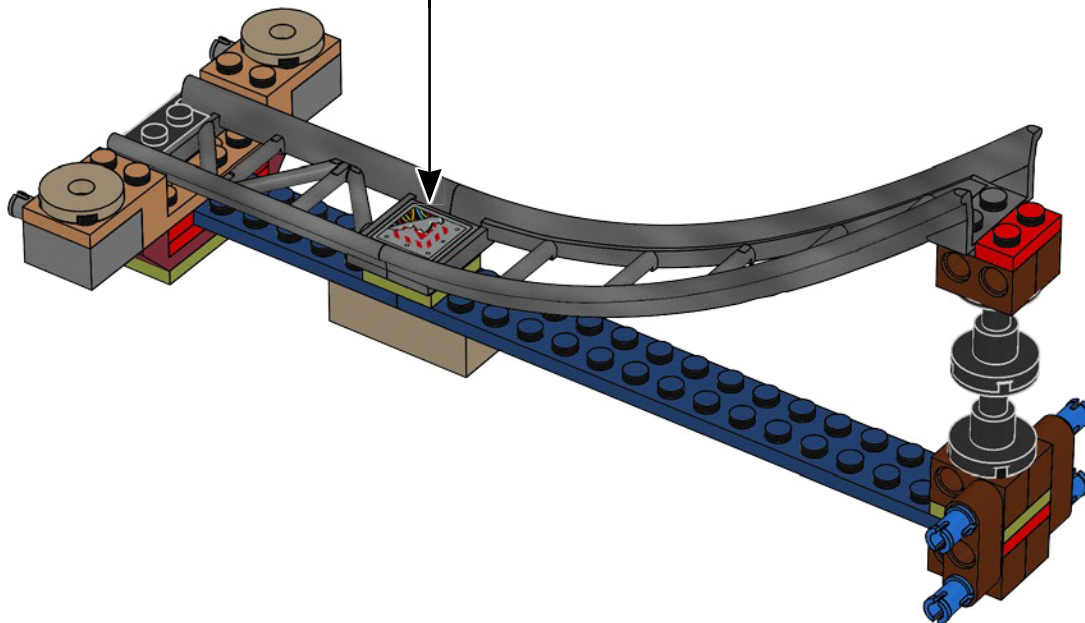
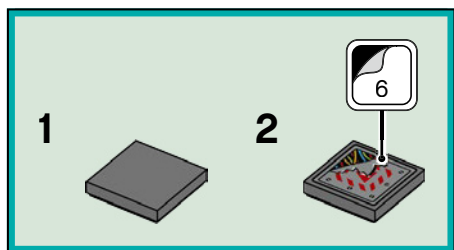

18



18

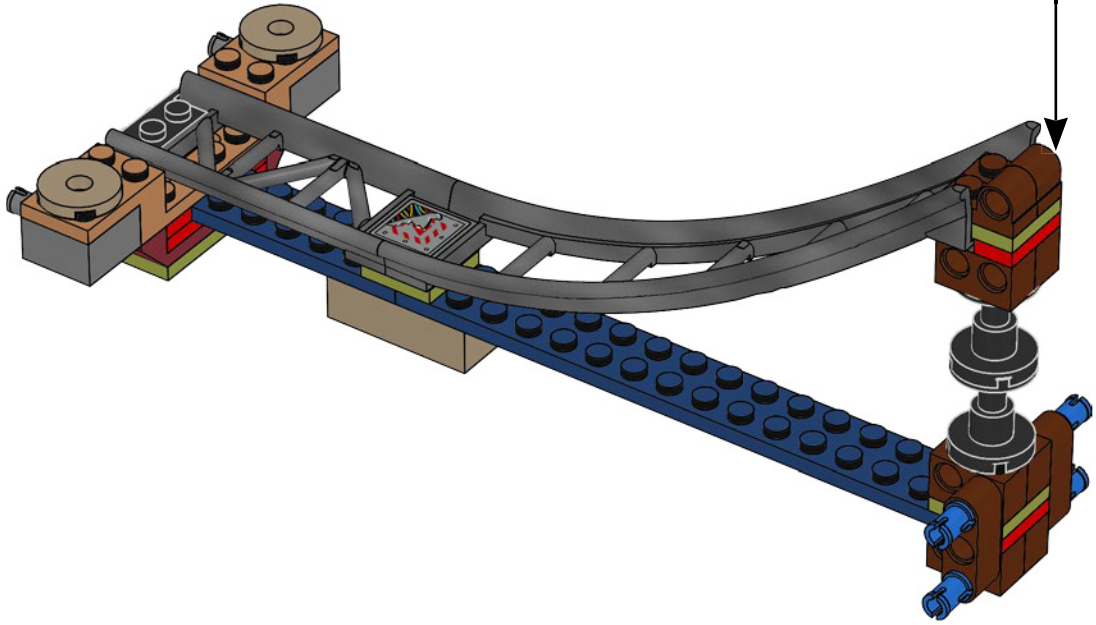
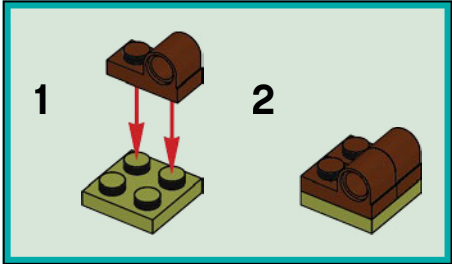

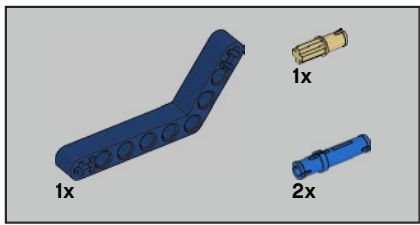

19

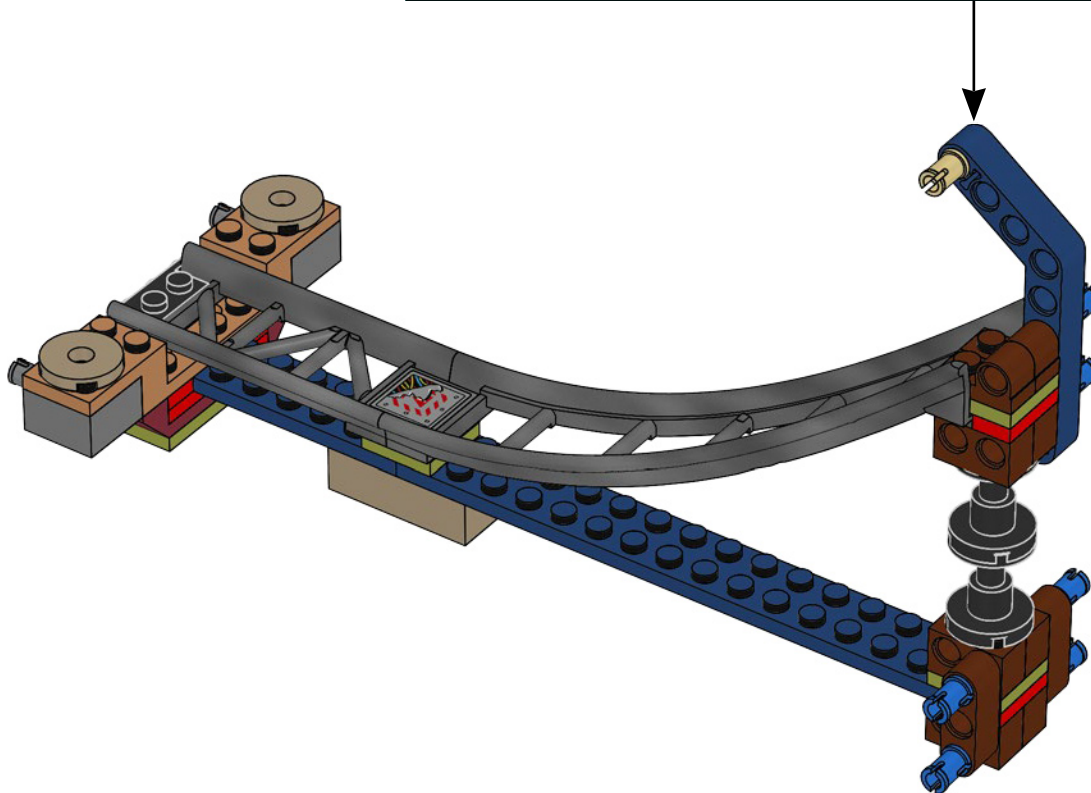
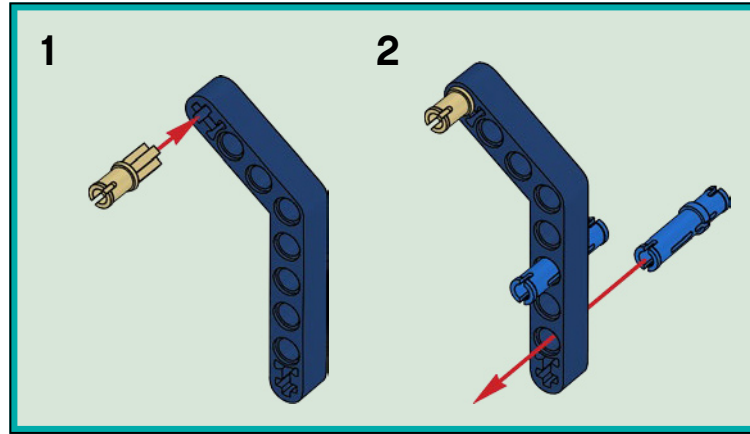

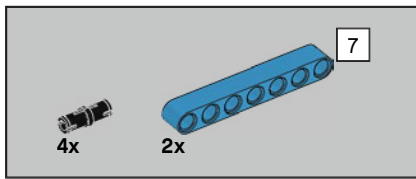

20

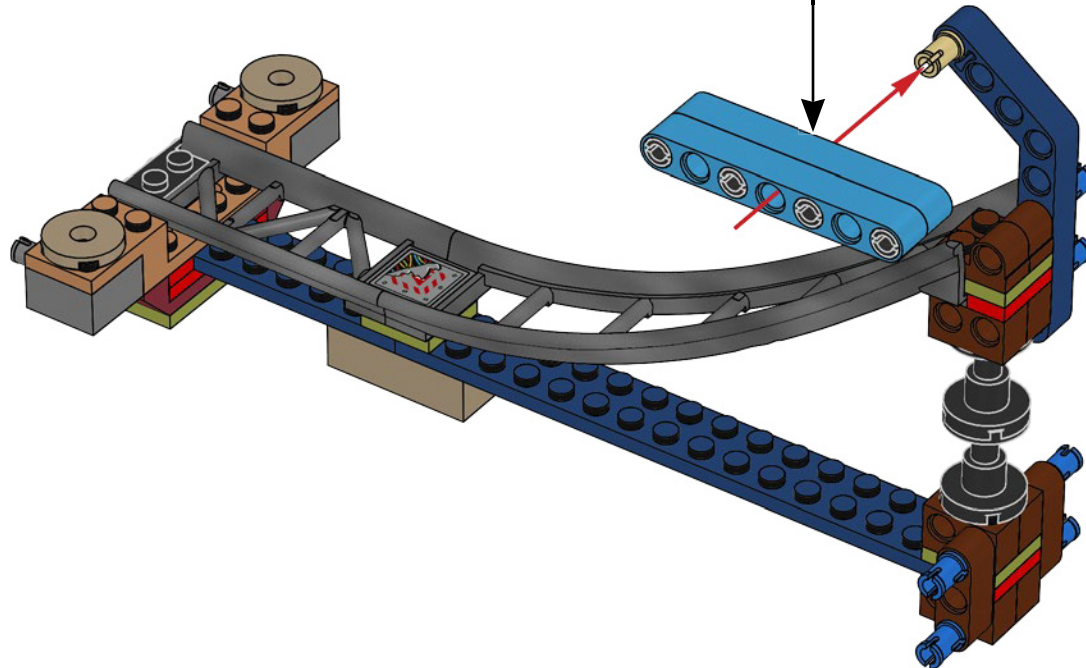
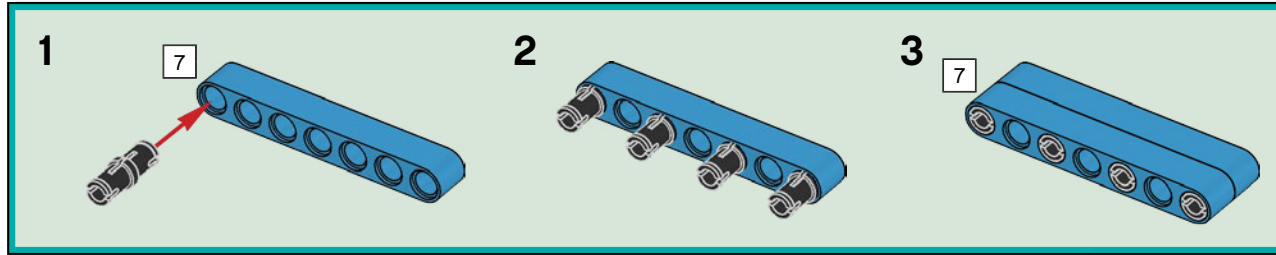

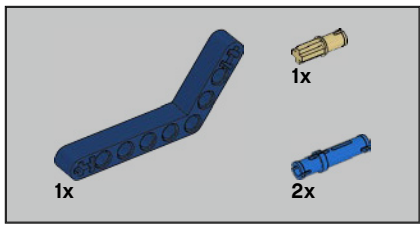

21

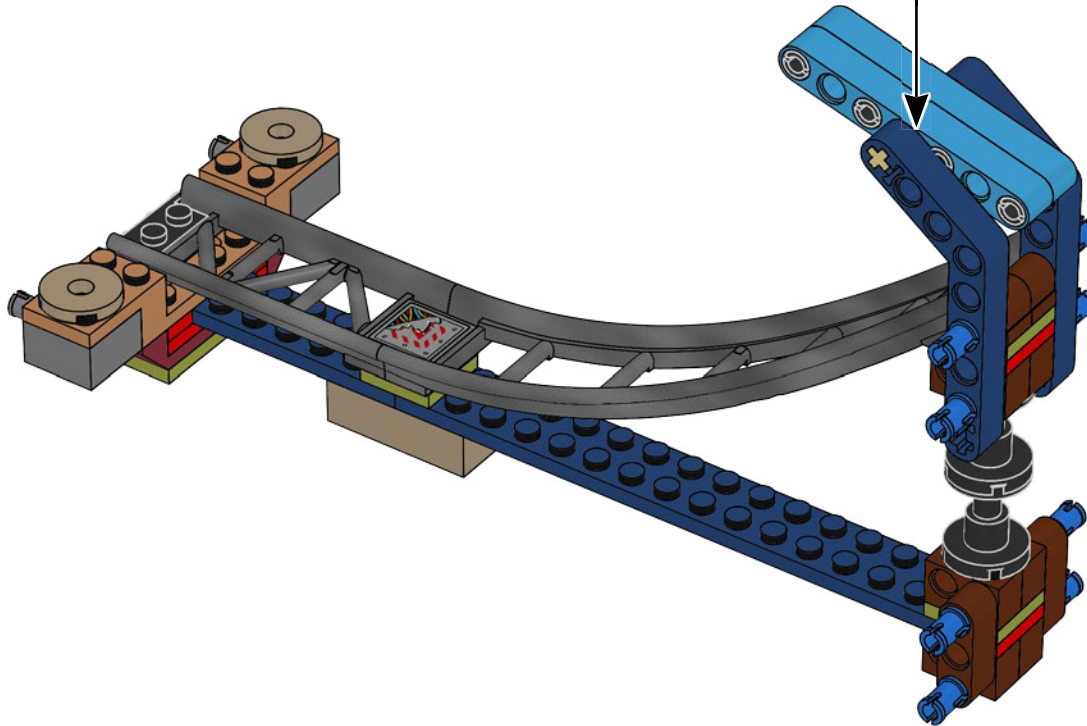
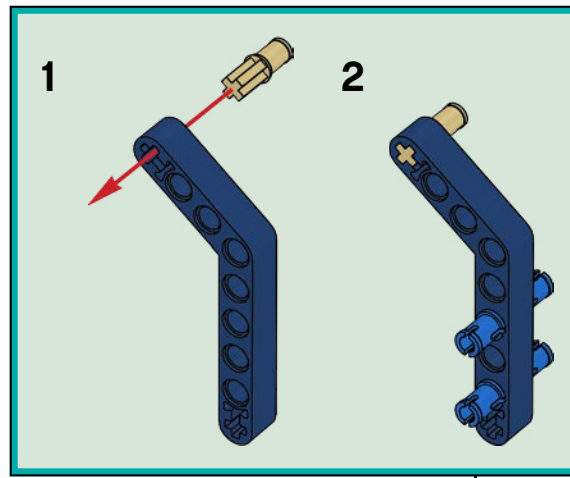

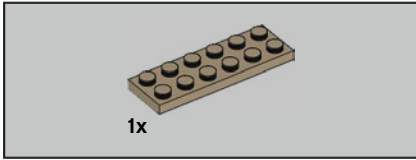
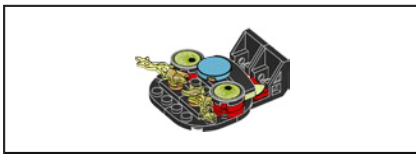

22

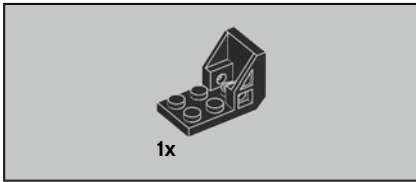
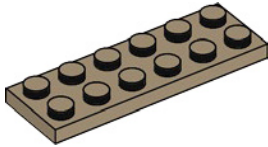

23

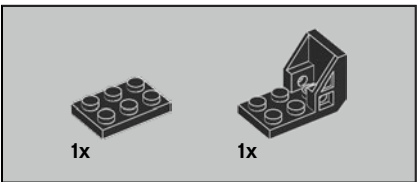
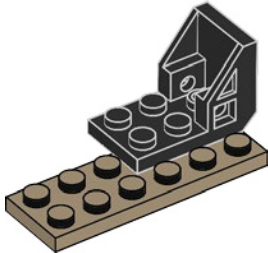

24

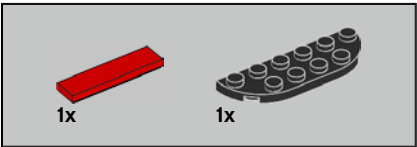
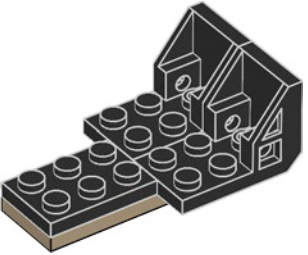

25

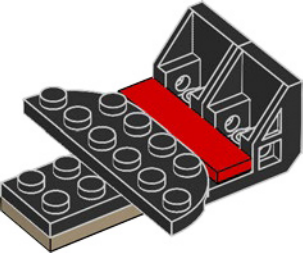

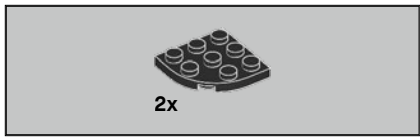

26

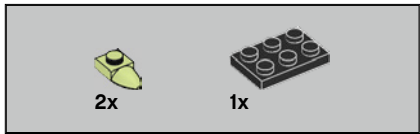
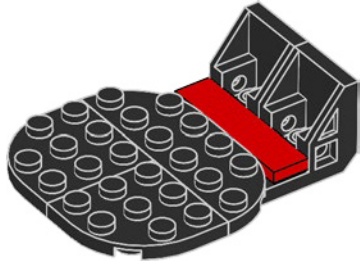

27

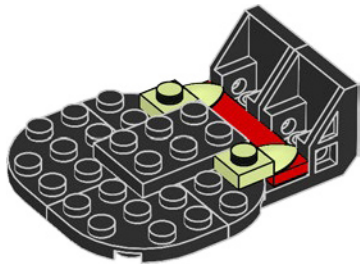

28

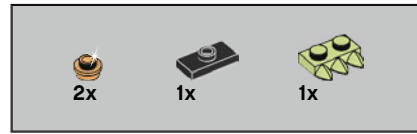
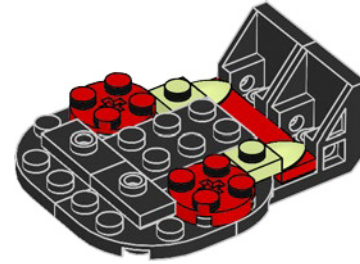

29

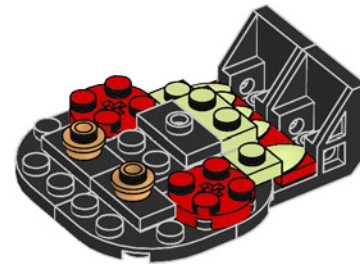



30

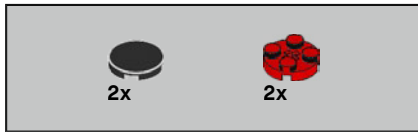
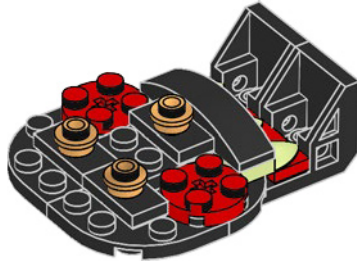

31

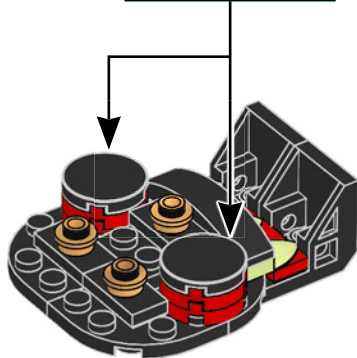
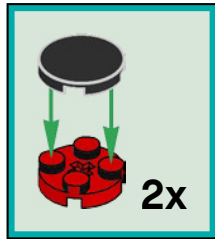

32

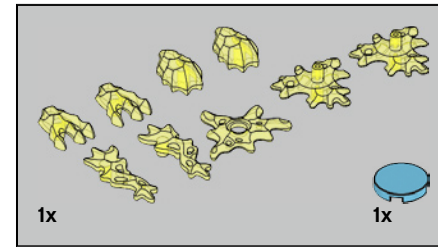
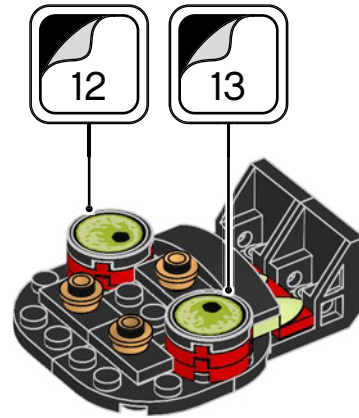

33



34

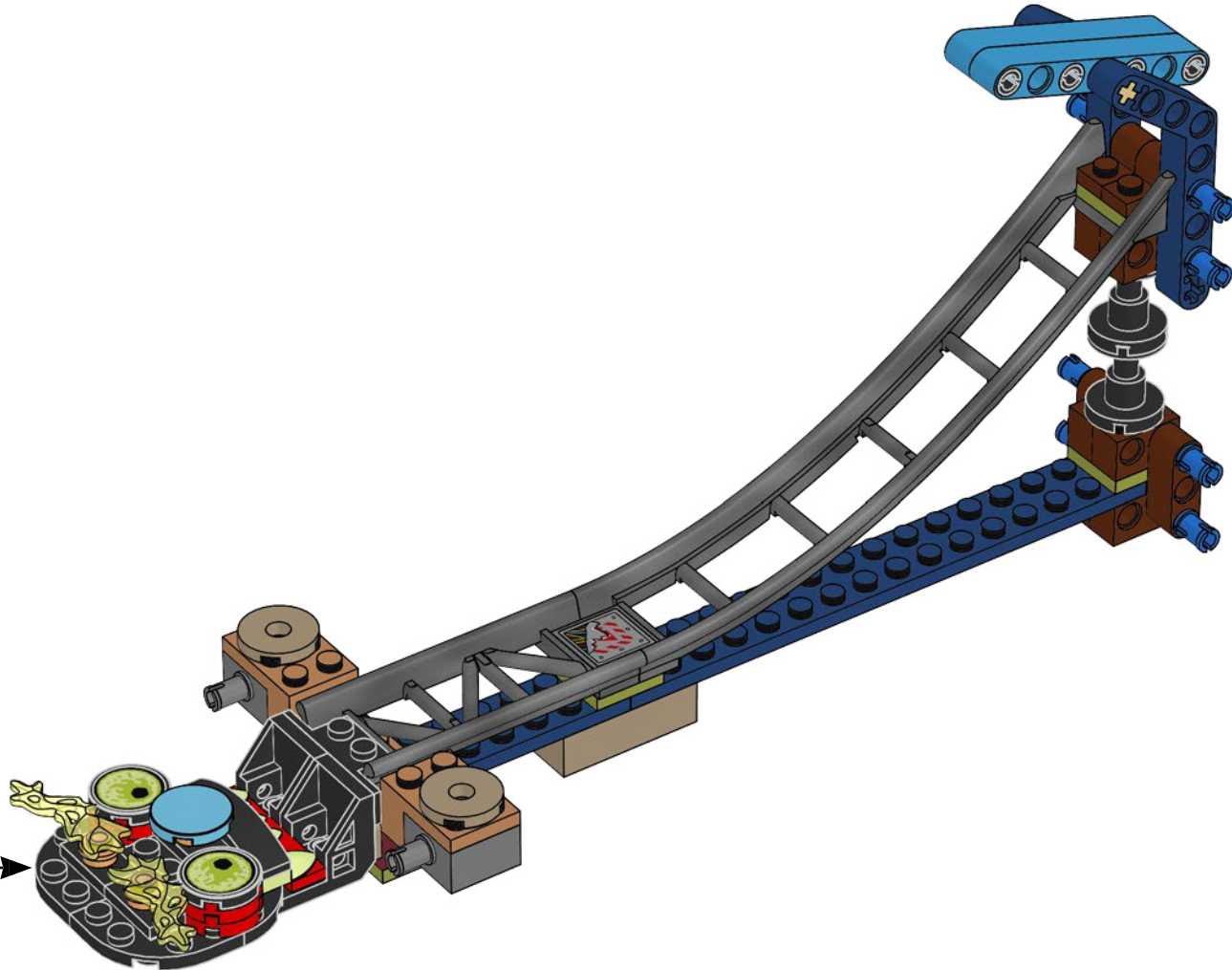



35

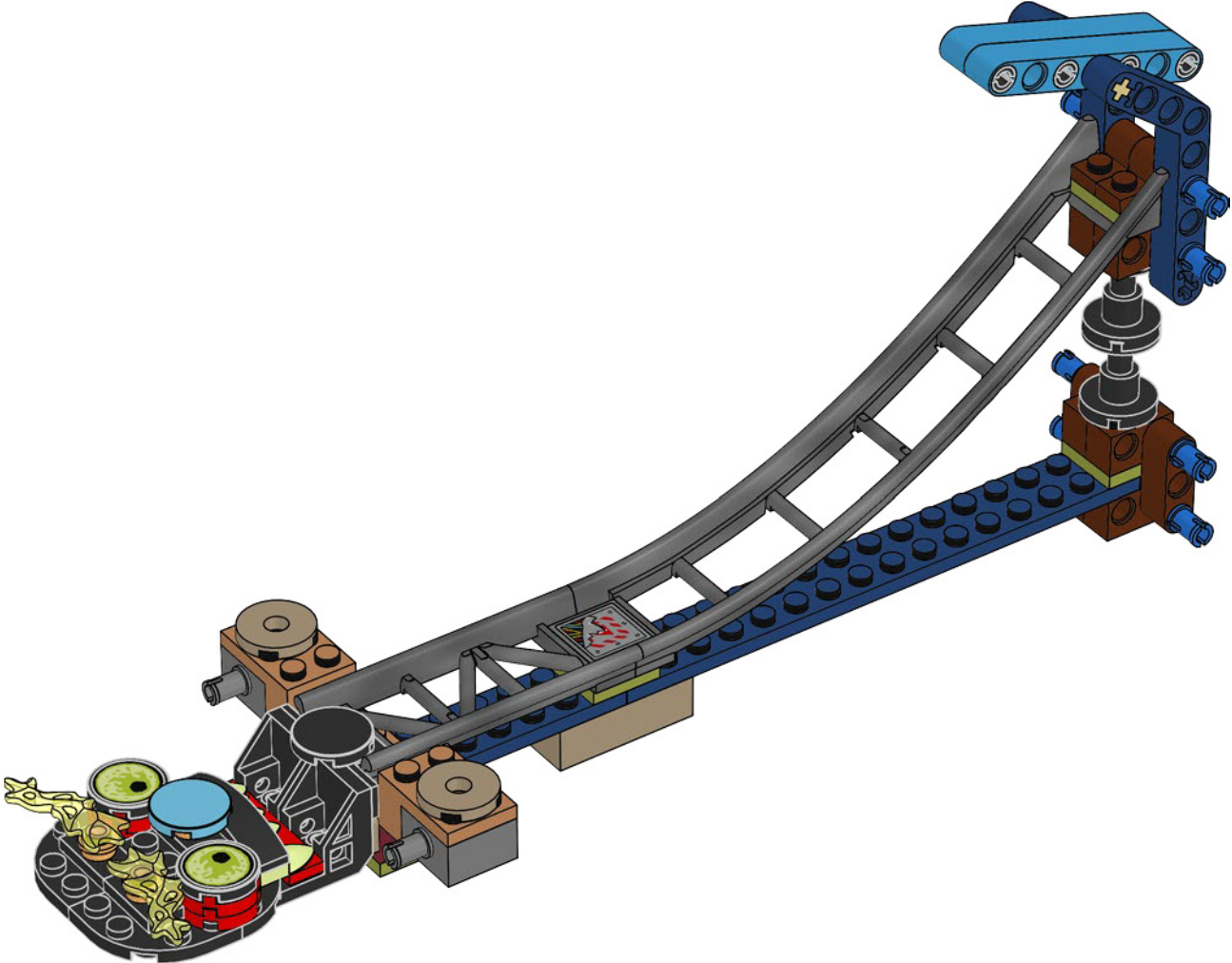

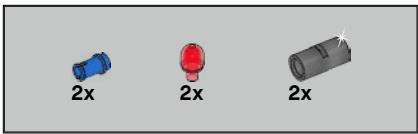

36

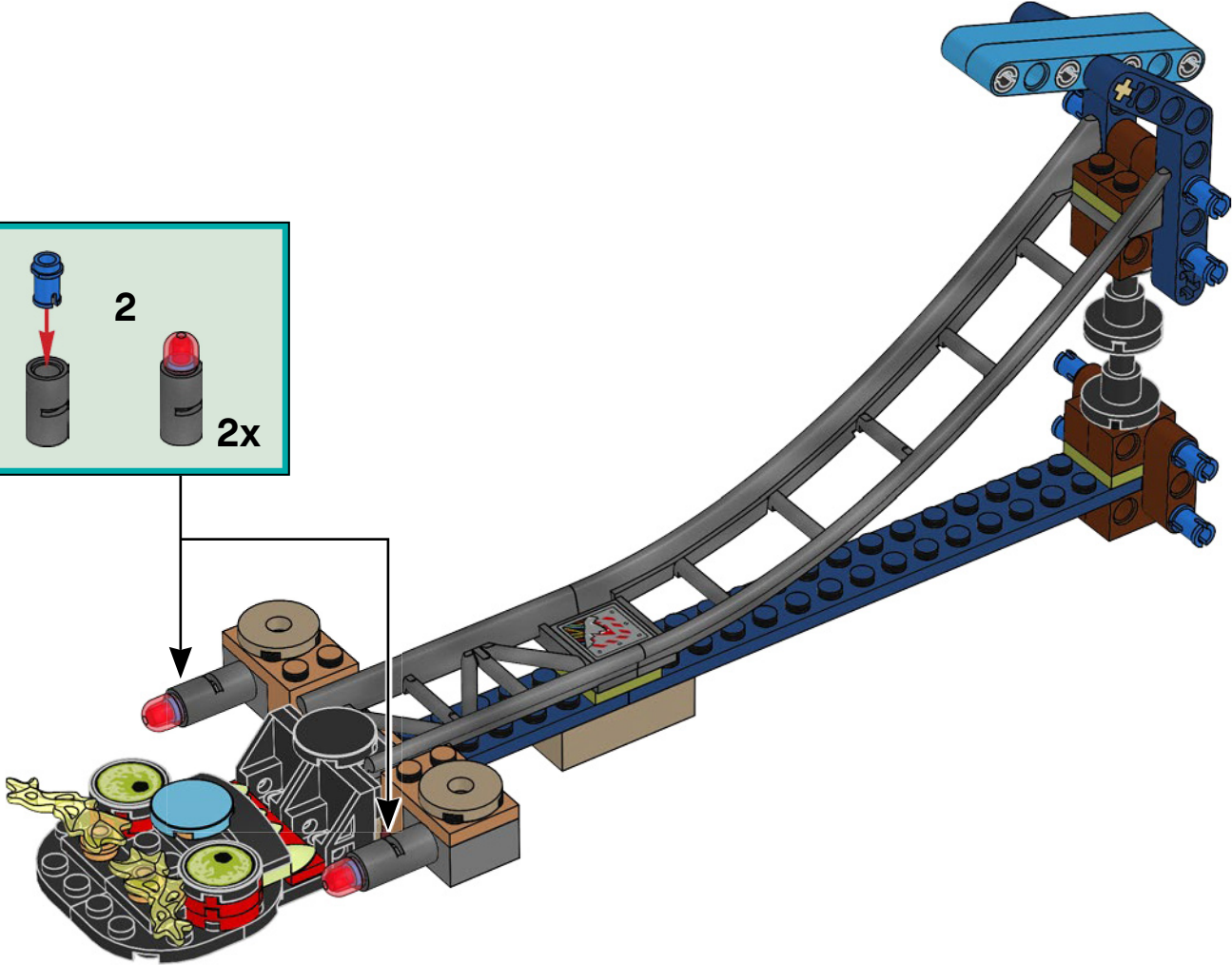
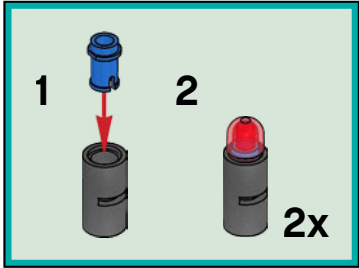

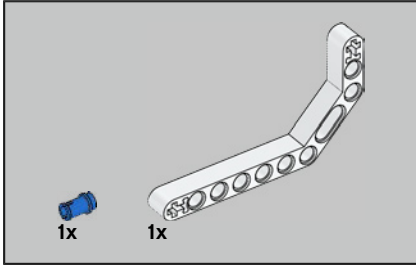
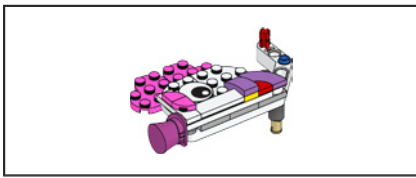

37

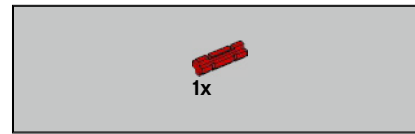
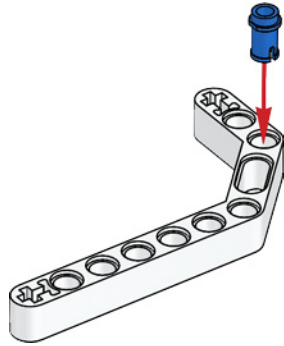

38

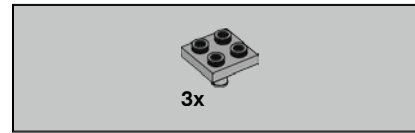
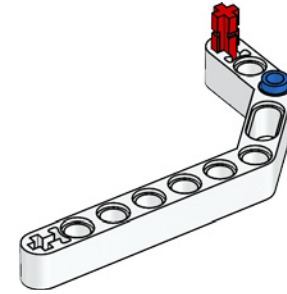

39

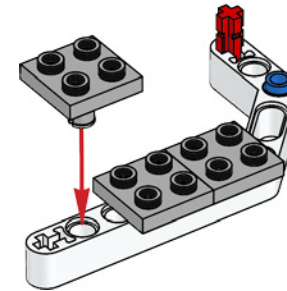

1x

40

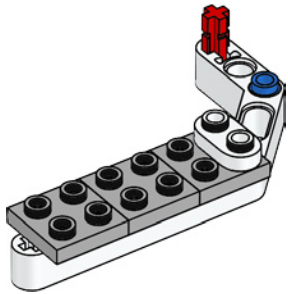

1x

1x

41

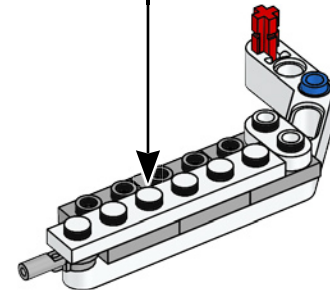
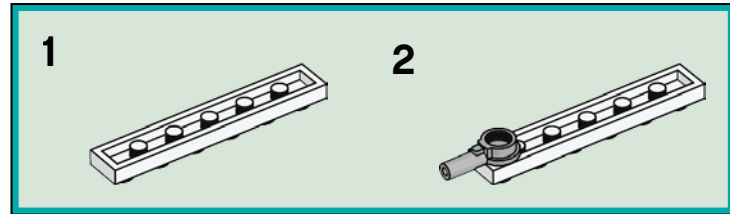

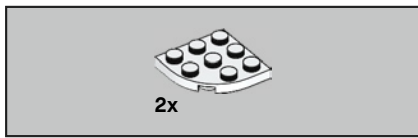

42

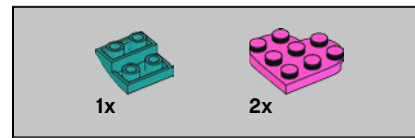
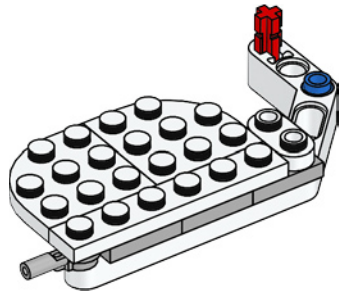

43

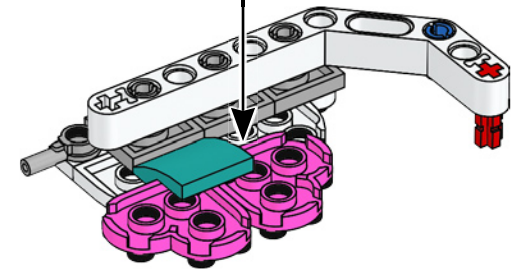
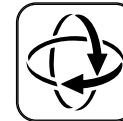
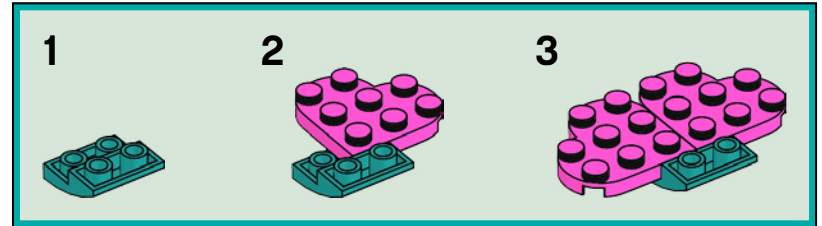

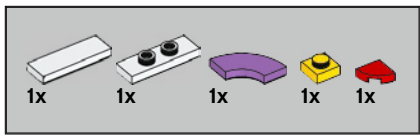

44

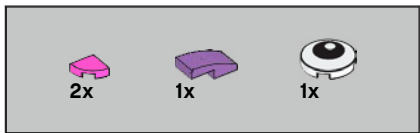
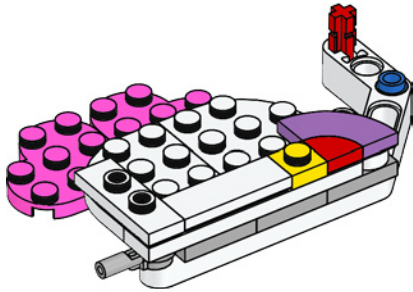

45

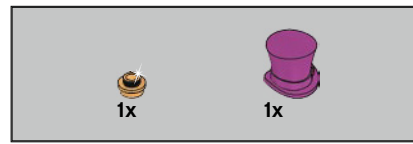
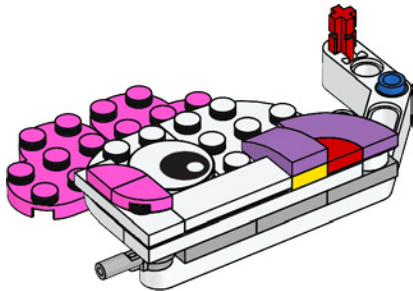

46

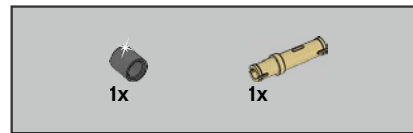
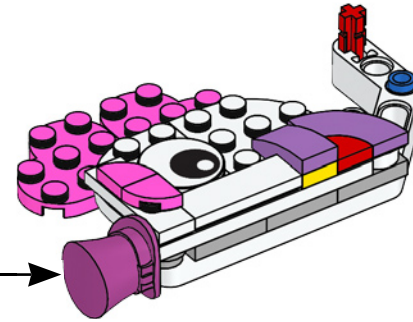
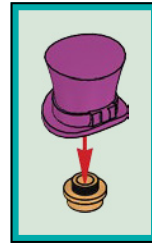

47

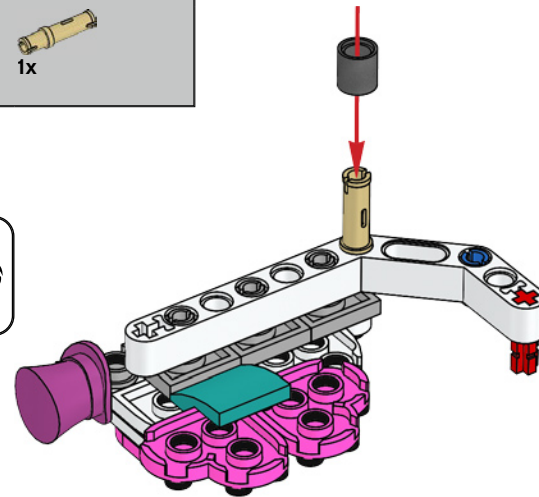
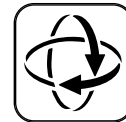

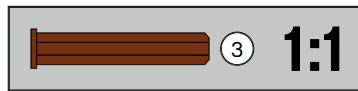
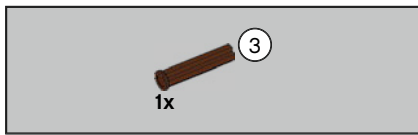

48

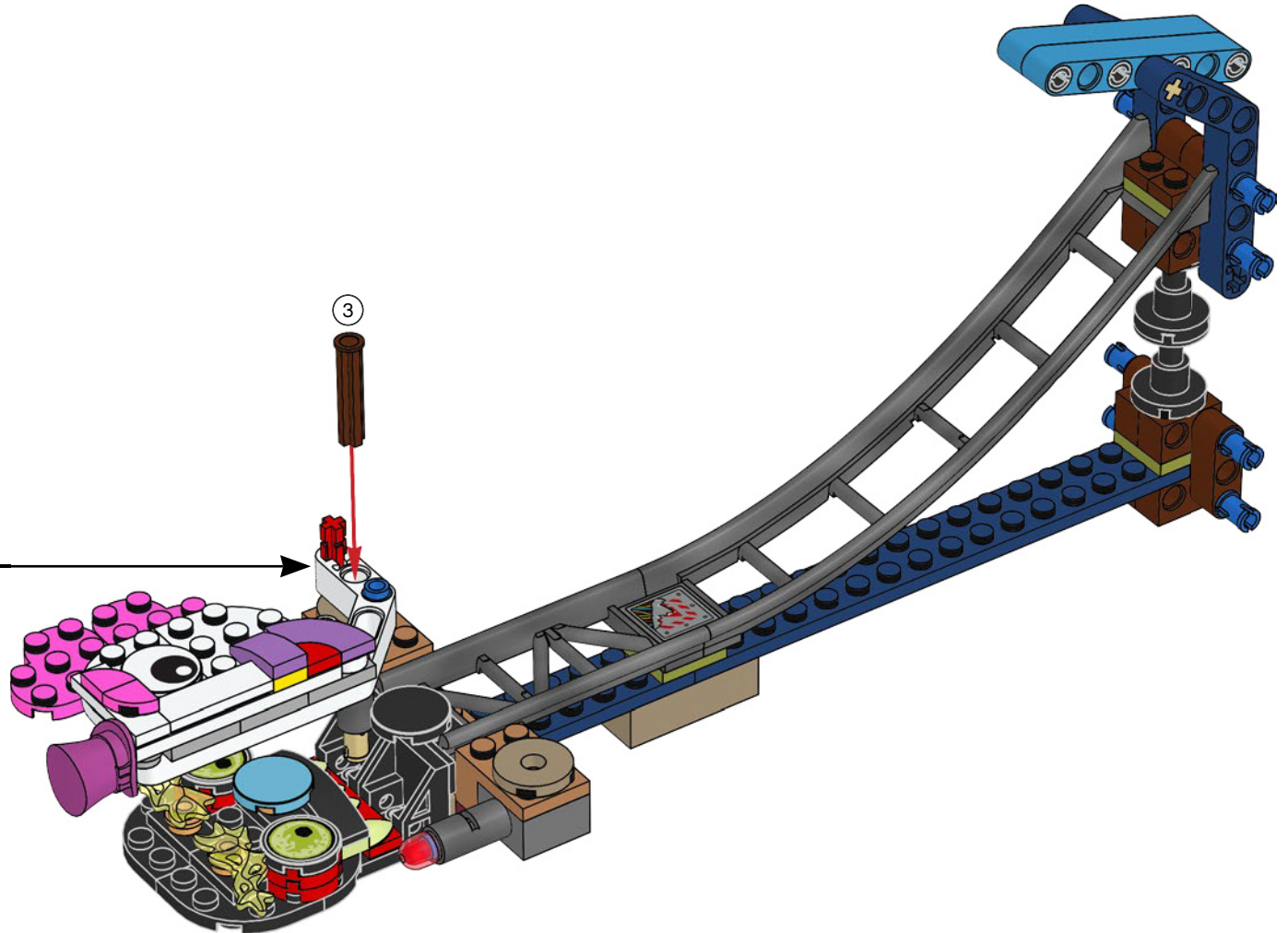

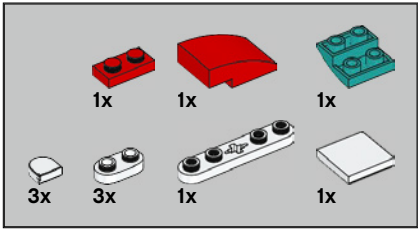
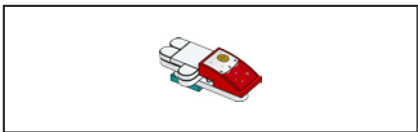

49

1

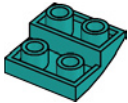

2

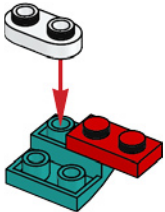

3

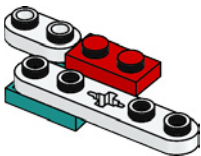

4

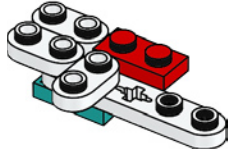

5

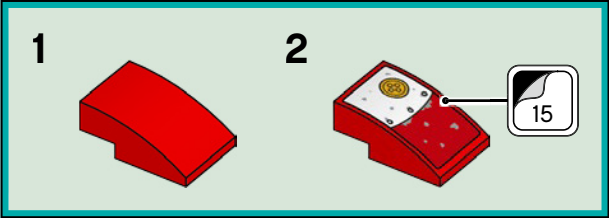
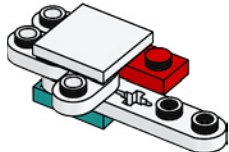

6

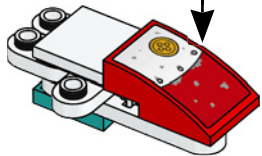

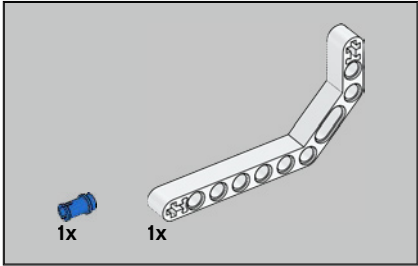
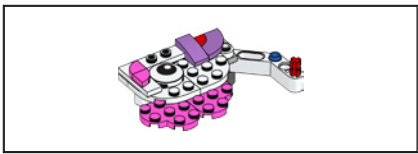

50

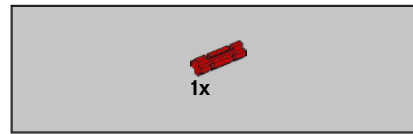
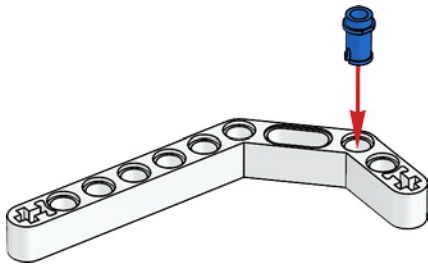

51

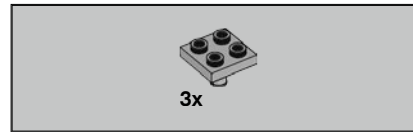
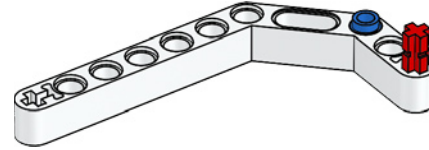

52

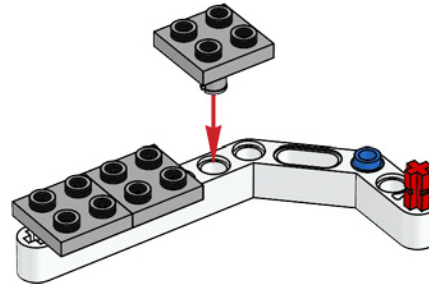

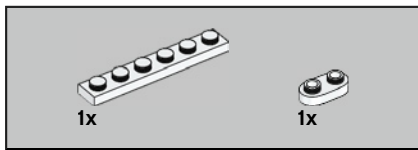

53

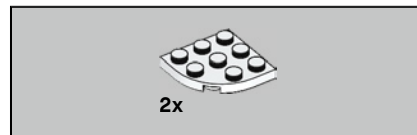
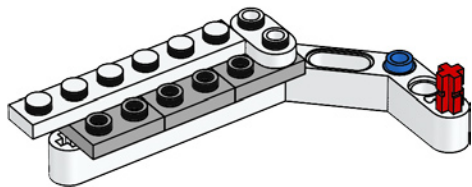

54

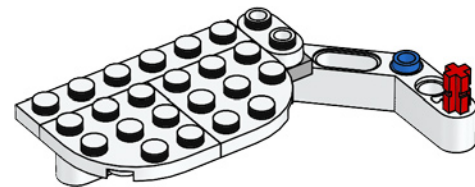

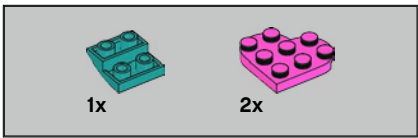

55

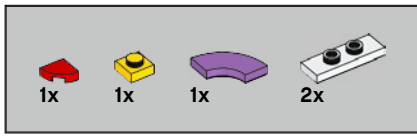
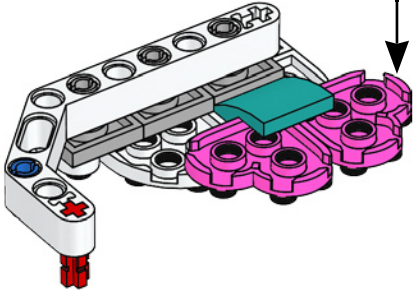
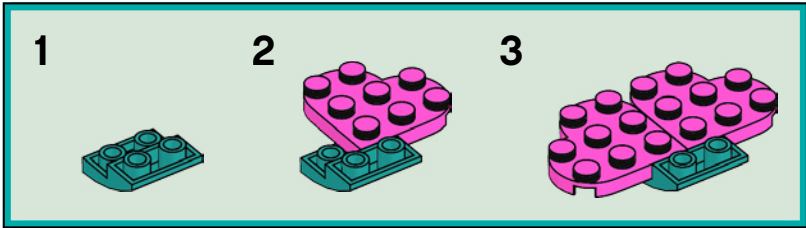

56

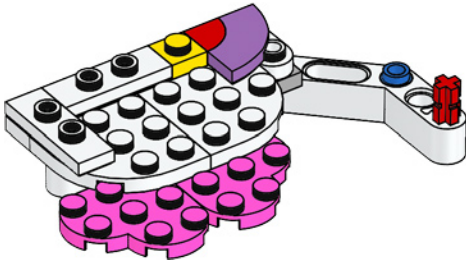



57

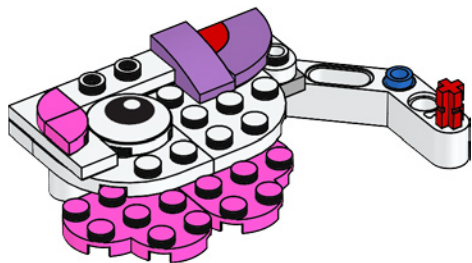

58

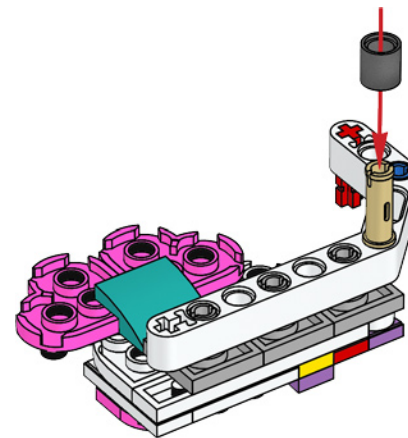

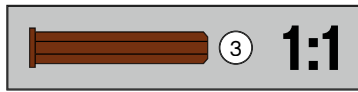
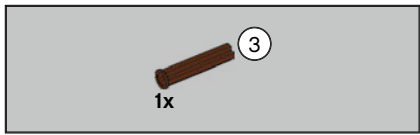

59

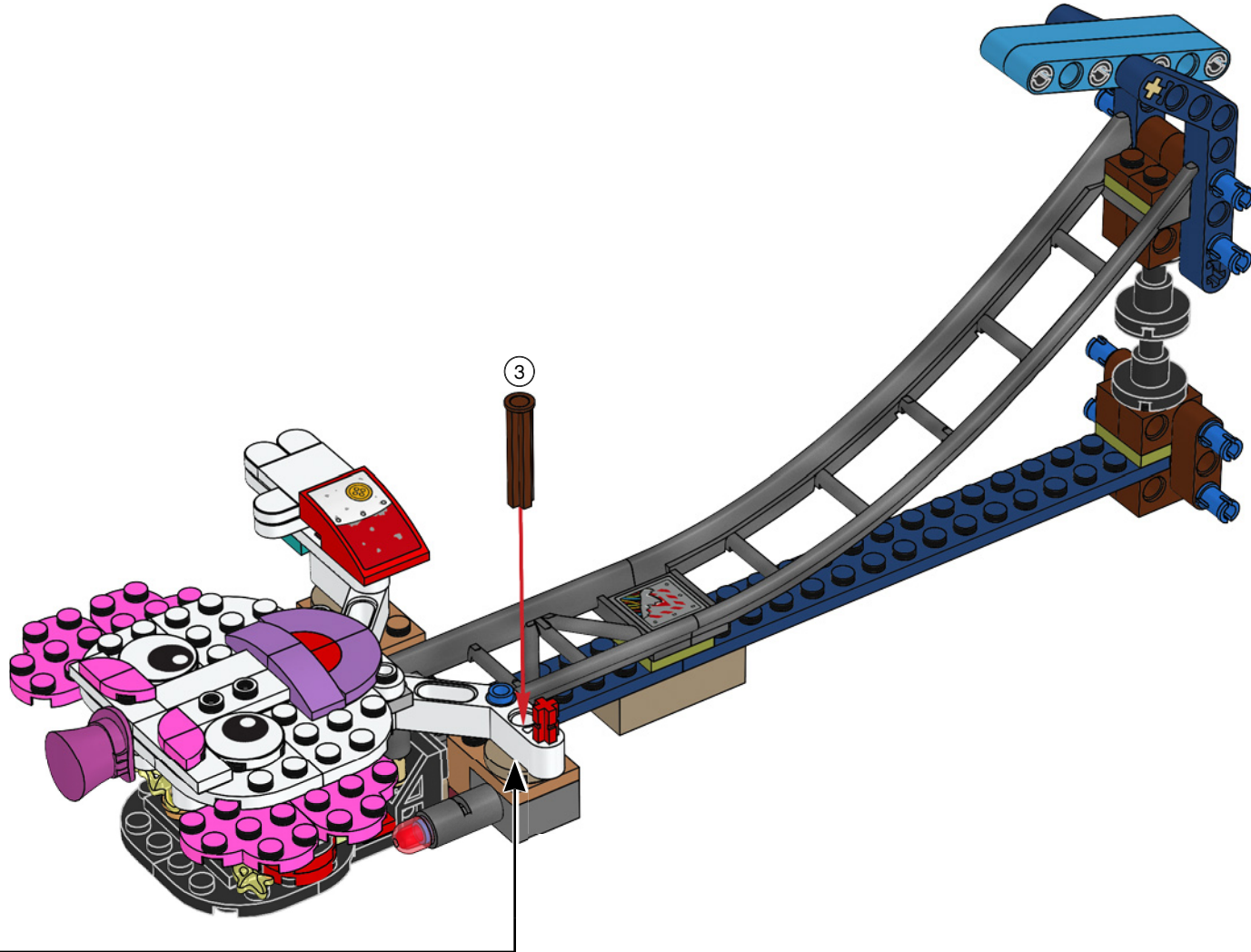

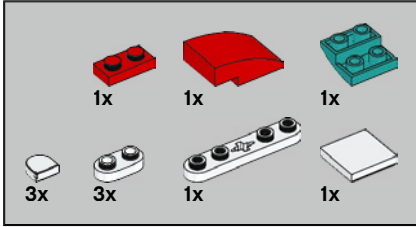

60

1

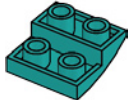

2

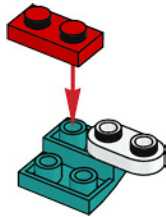

3



4

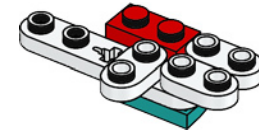

5

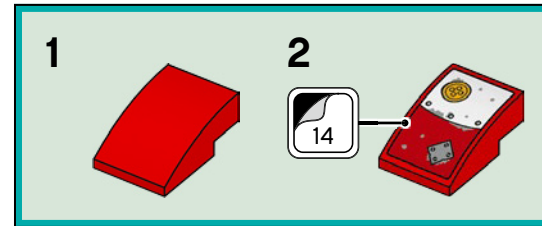
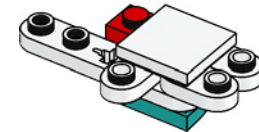

6

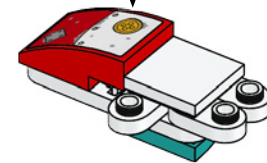

7

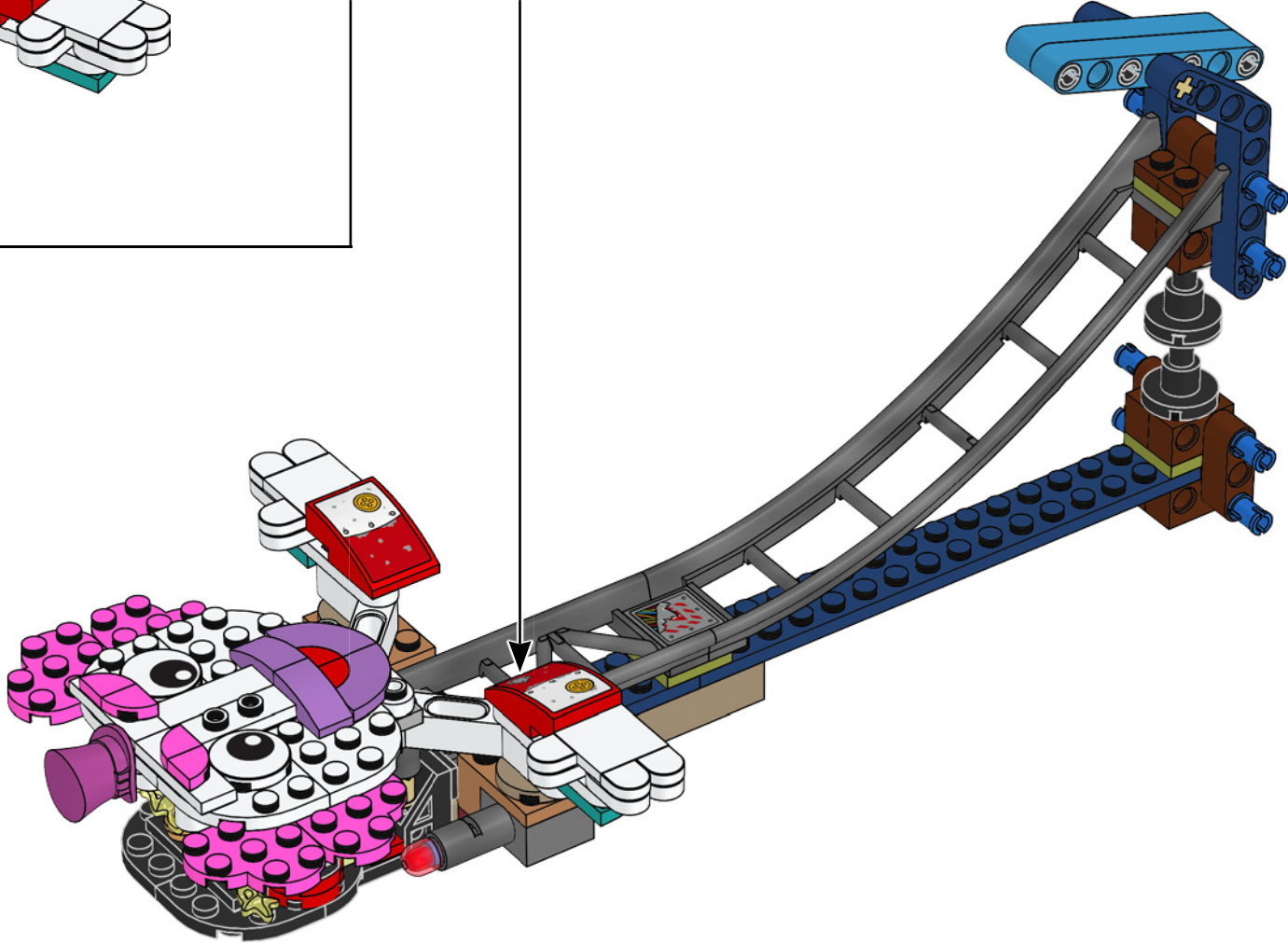
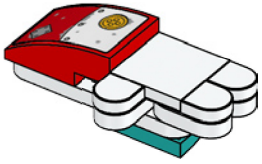

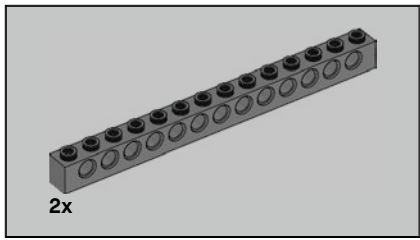

62



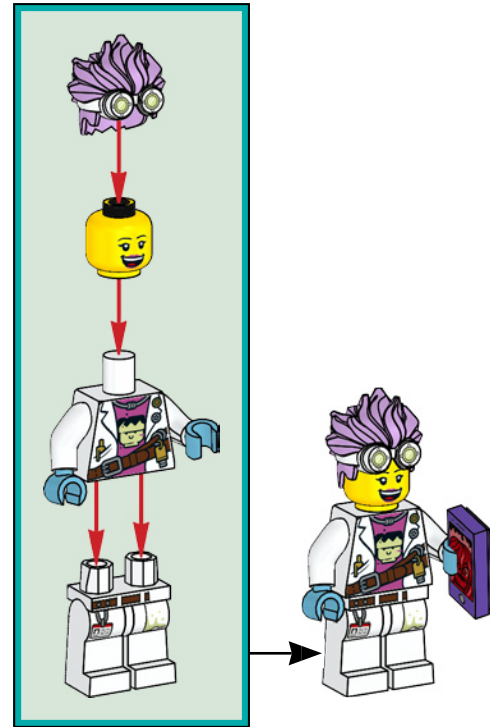
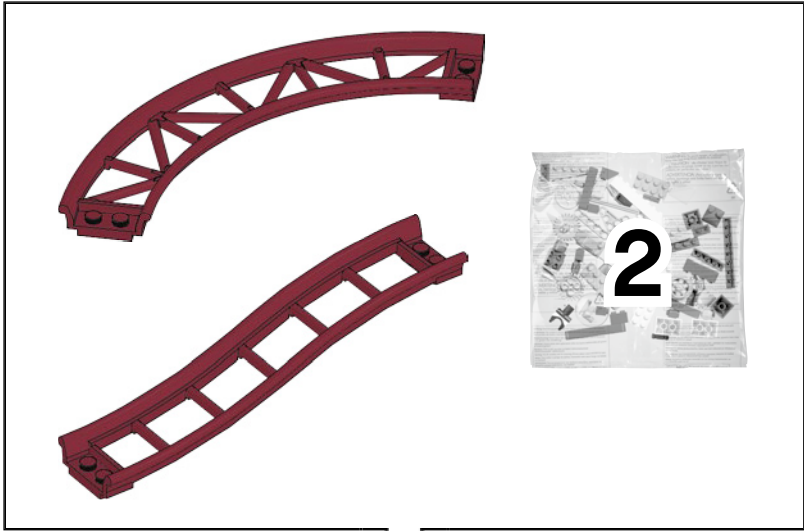

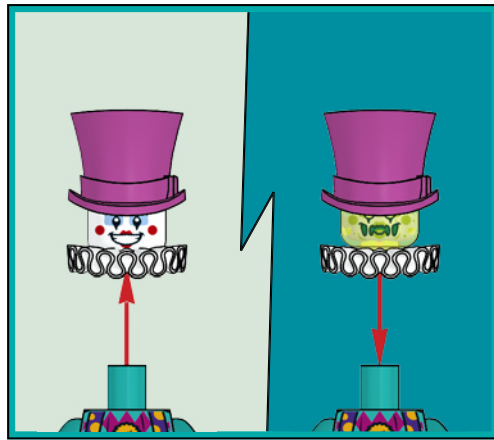
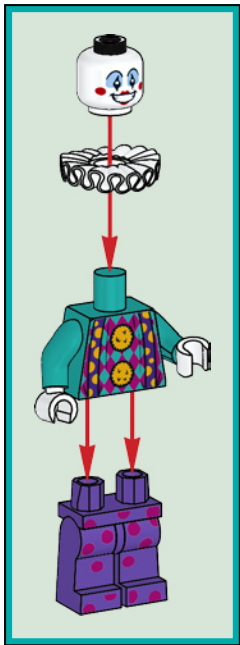

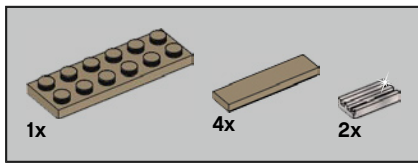

63

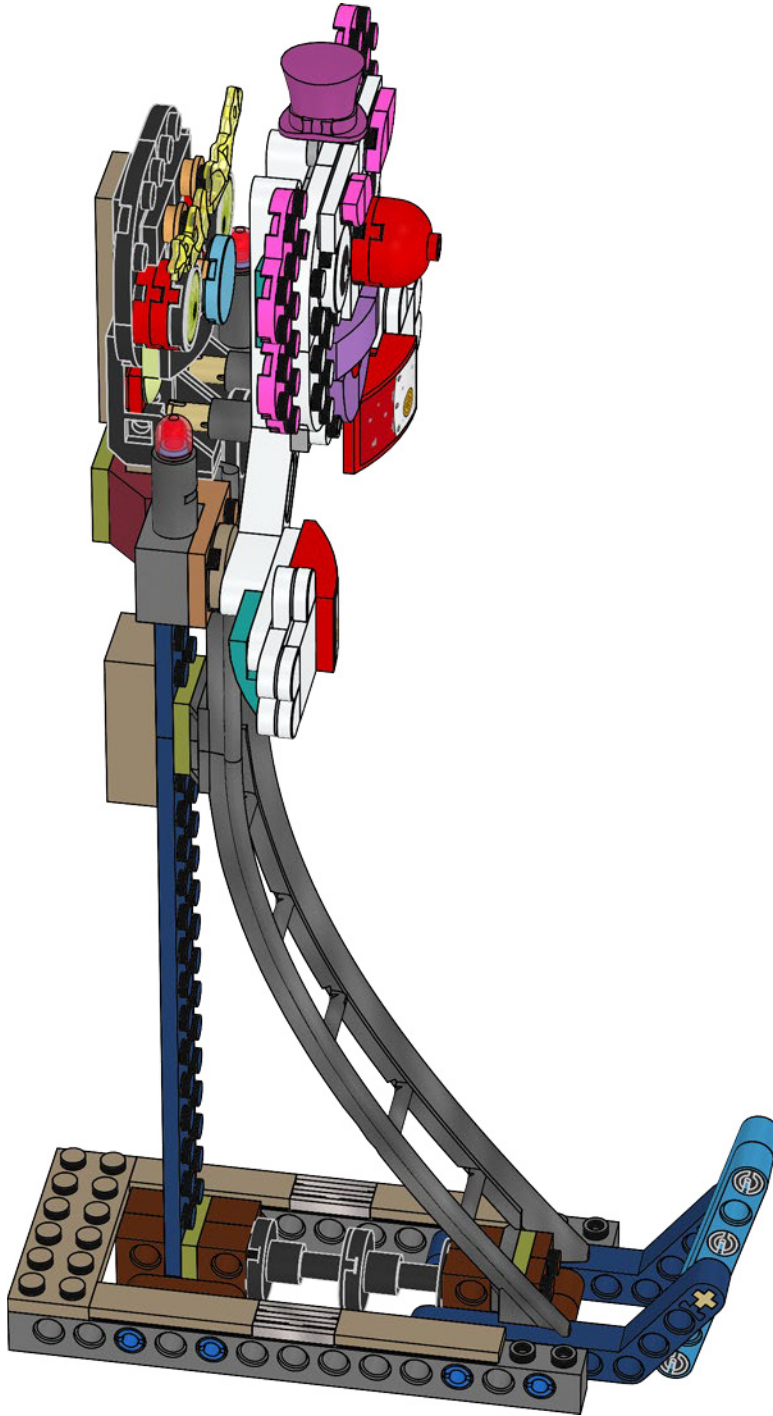

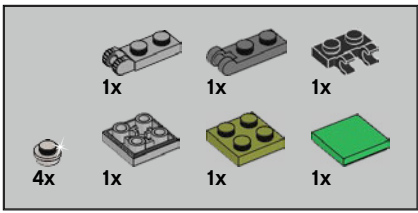

64

1

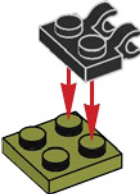

2

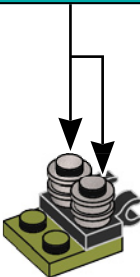
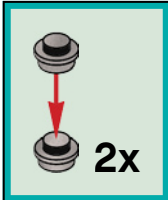

3

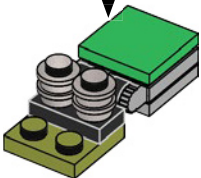
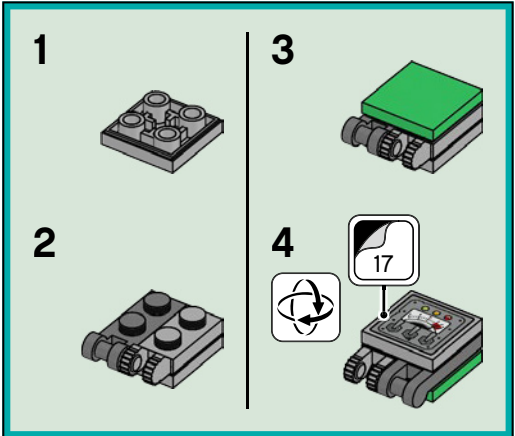

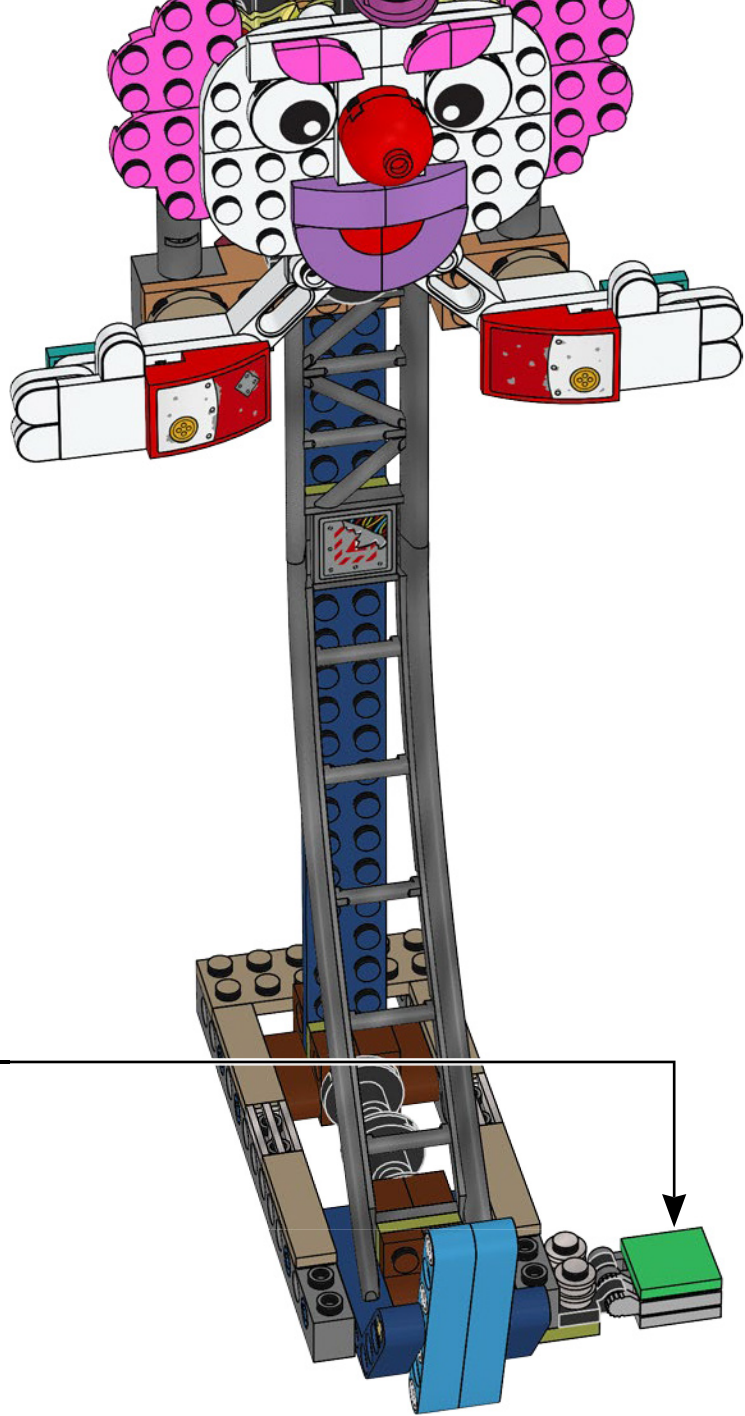

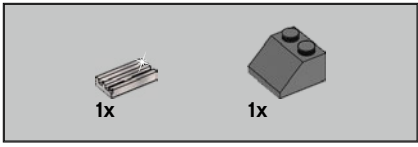

65

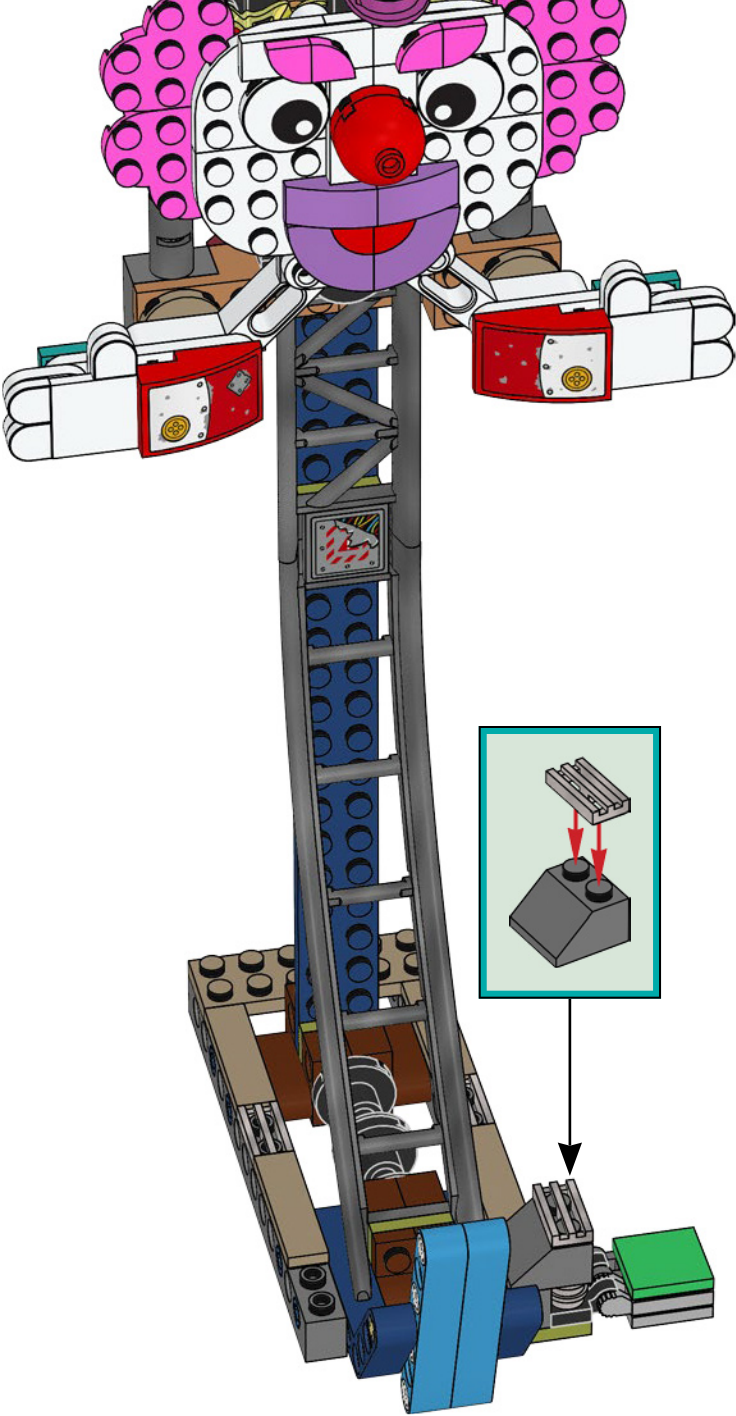

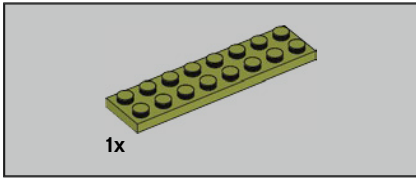
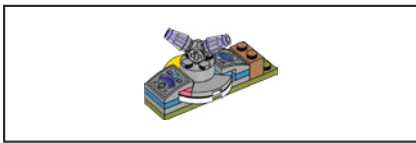

66

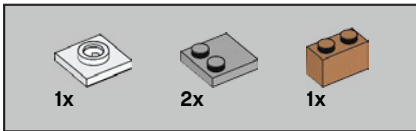
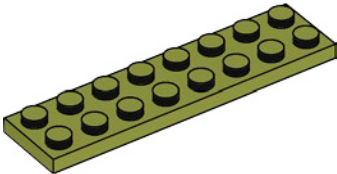

67

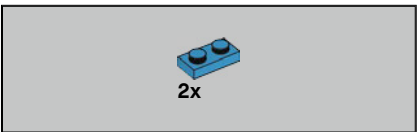
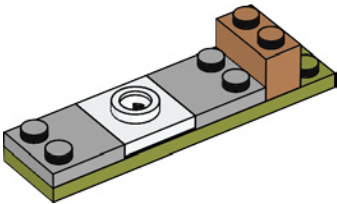

68

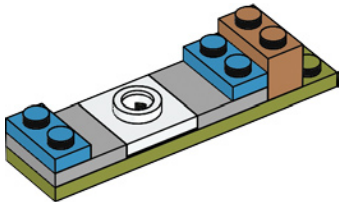

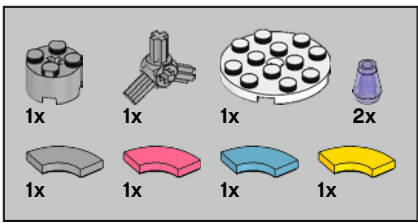

69

1



2

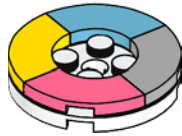

3

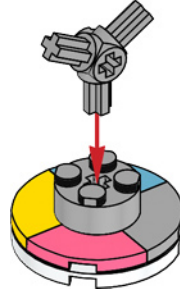

4

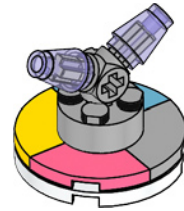

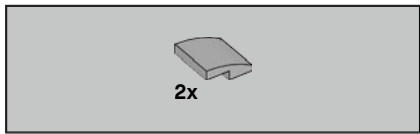

70

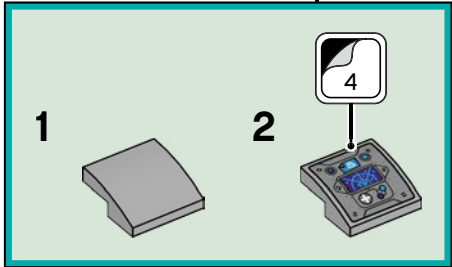
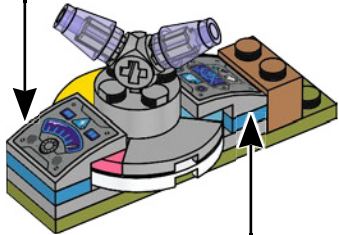
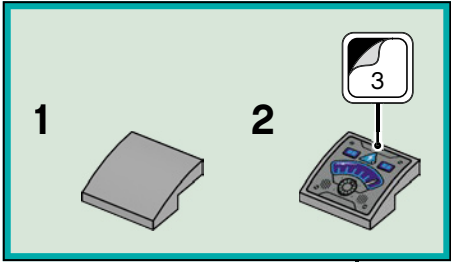

71

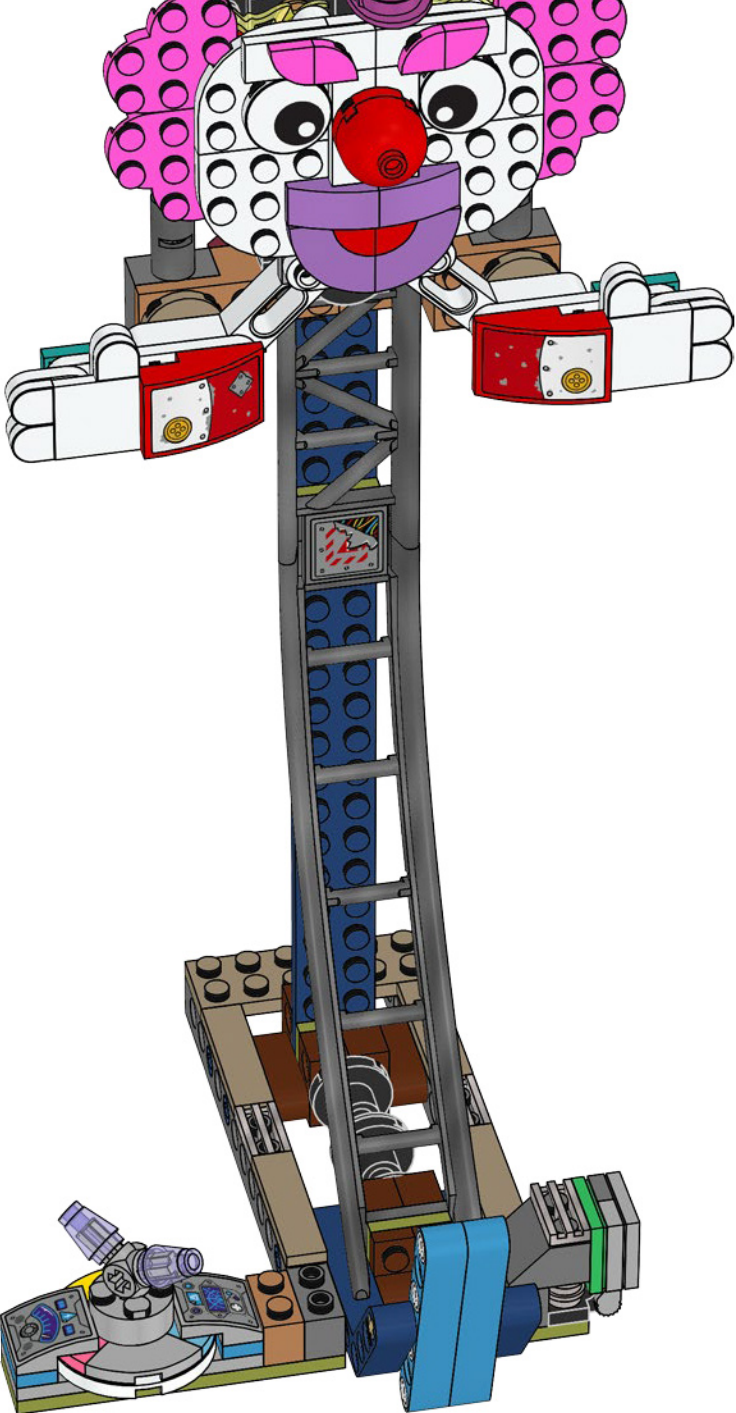



1x

72

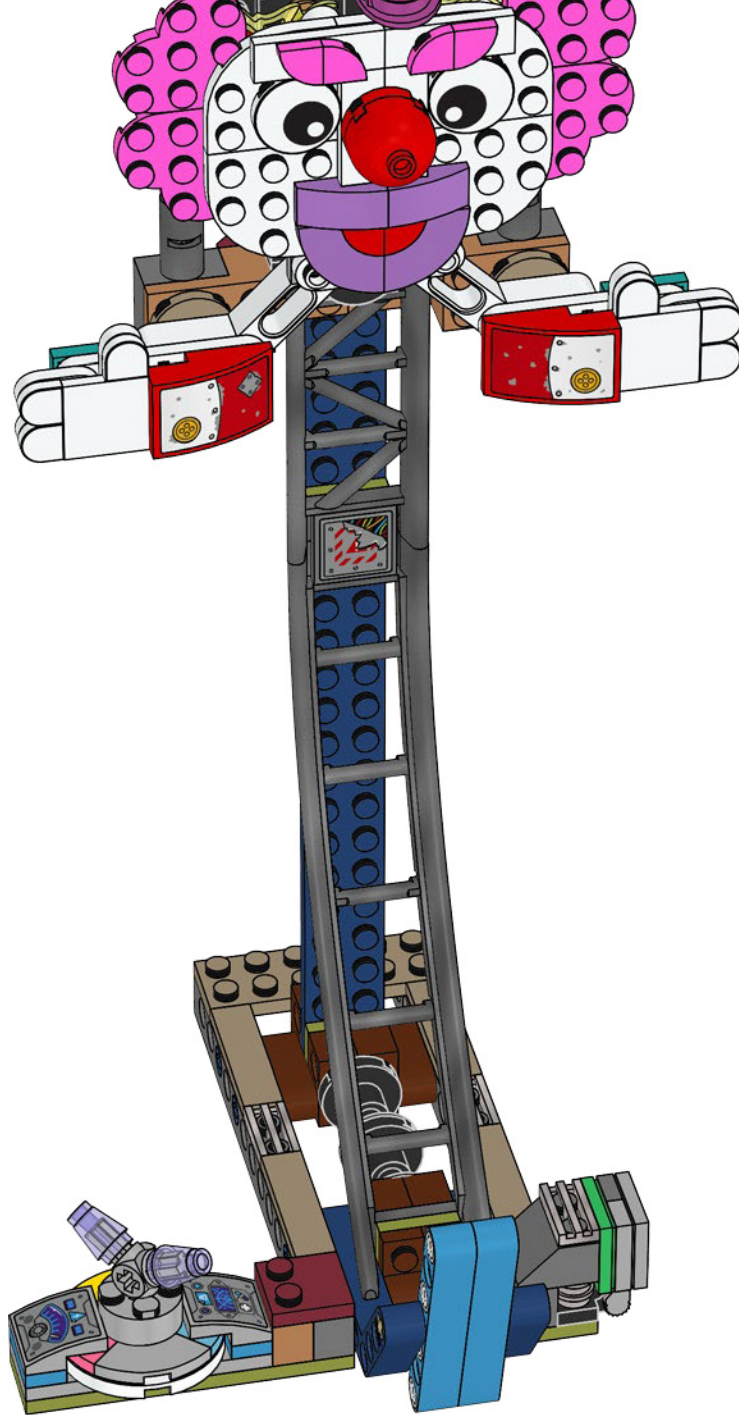

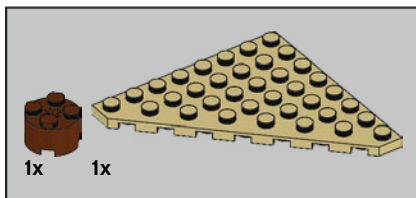
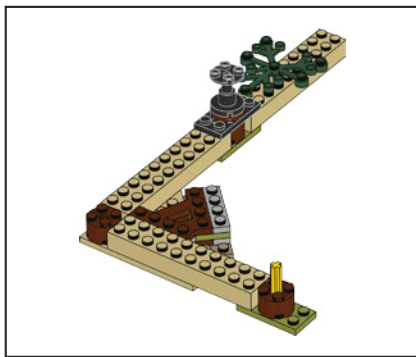

73

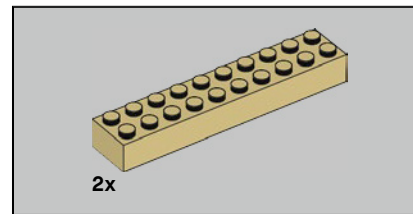
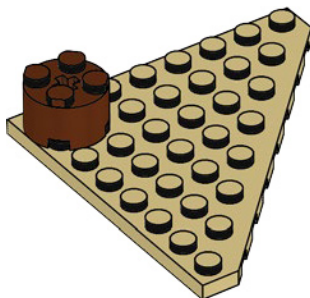

74

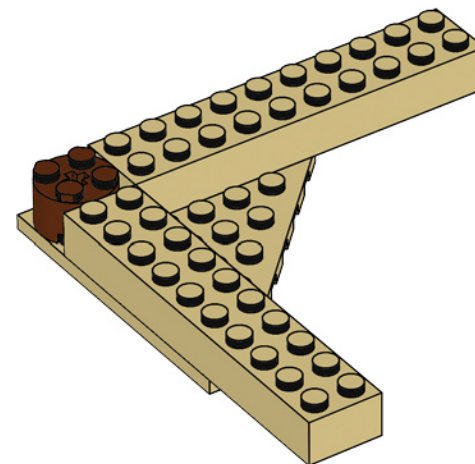

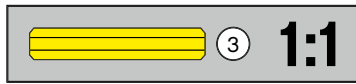
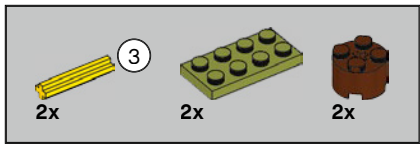

75

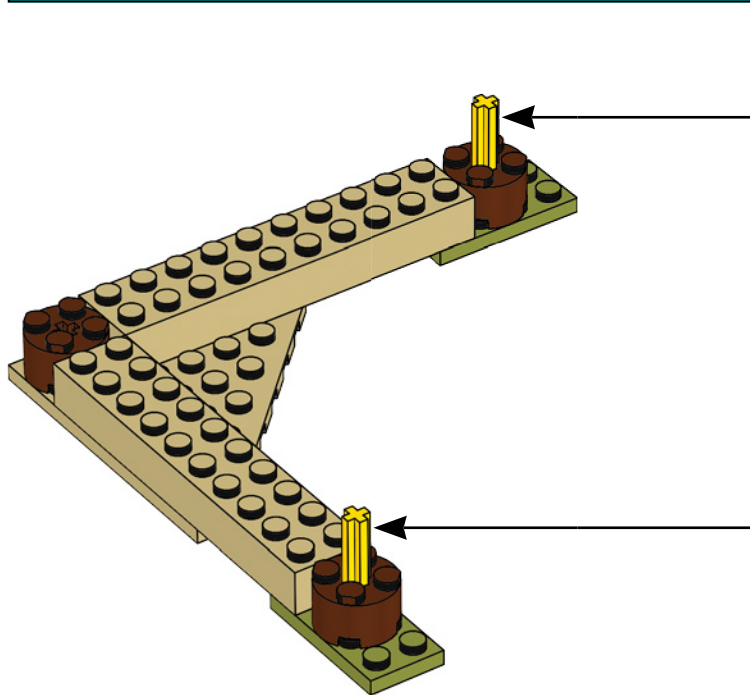
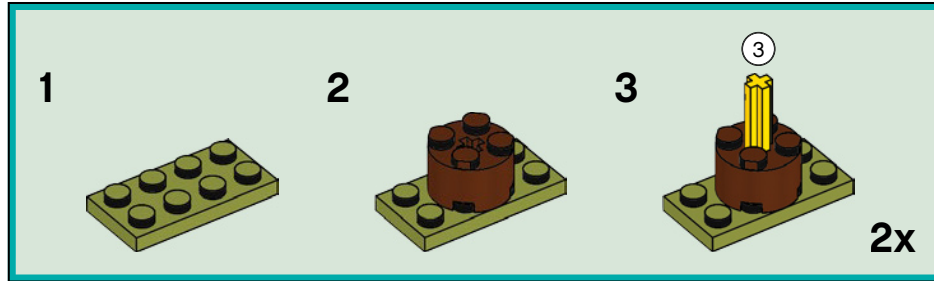

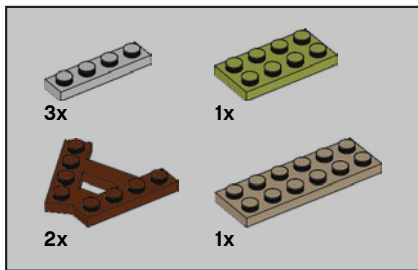

76

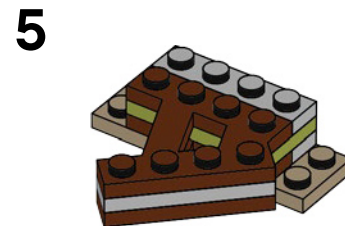
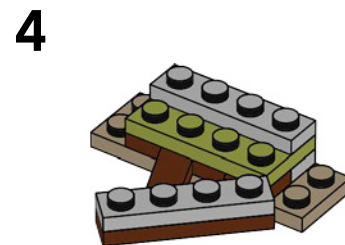
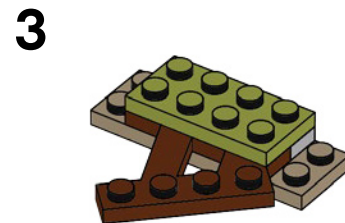
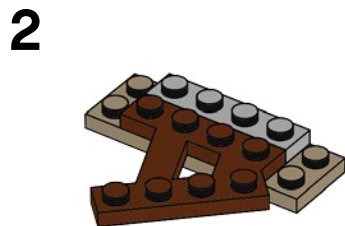
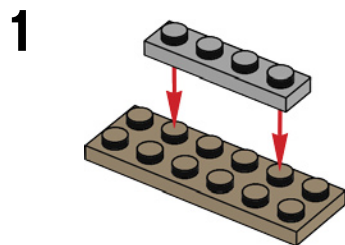

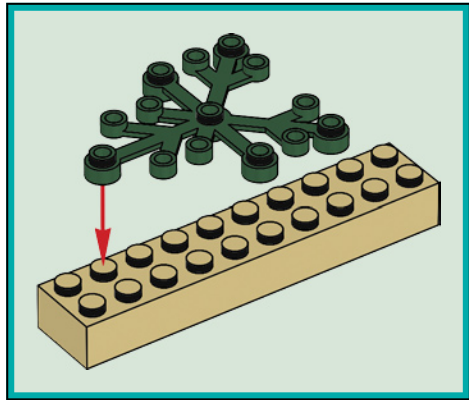
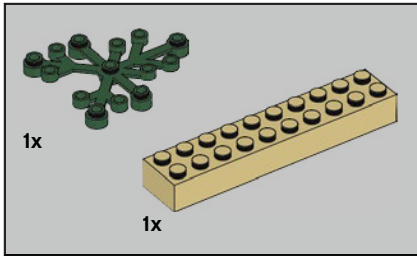

77

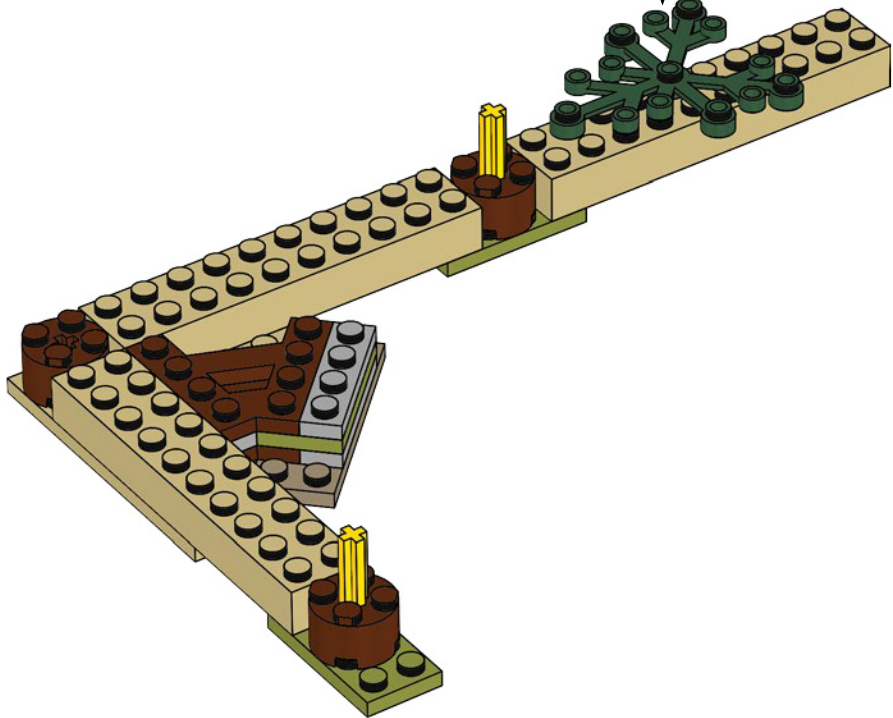
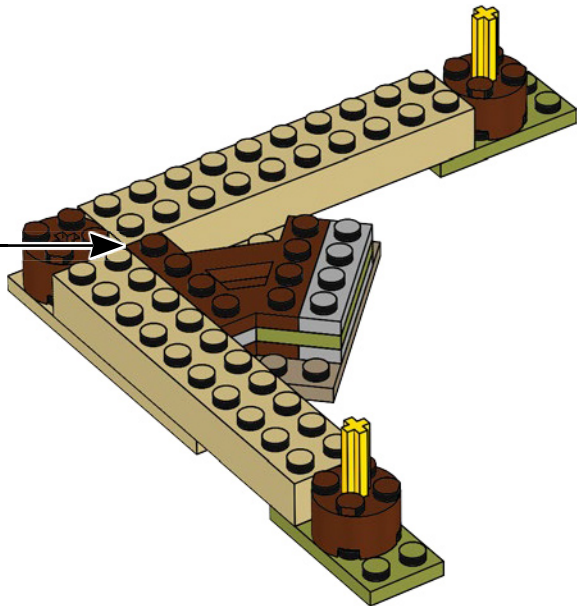

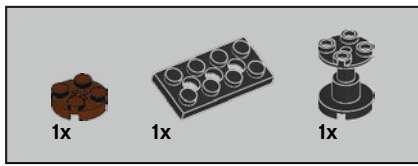

78

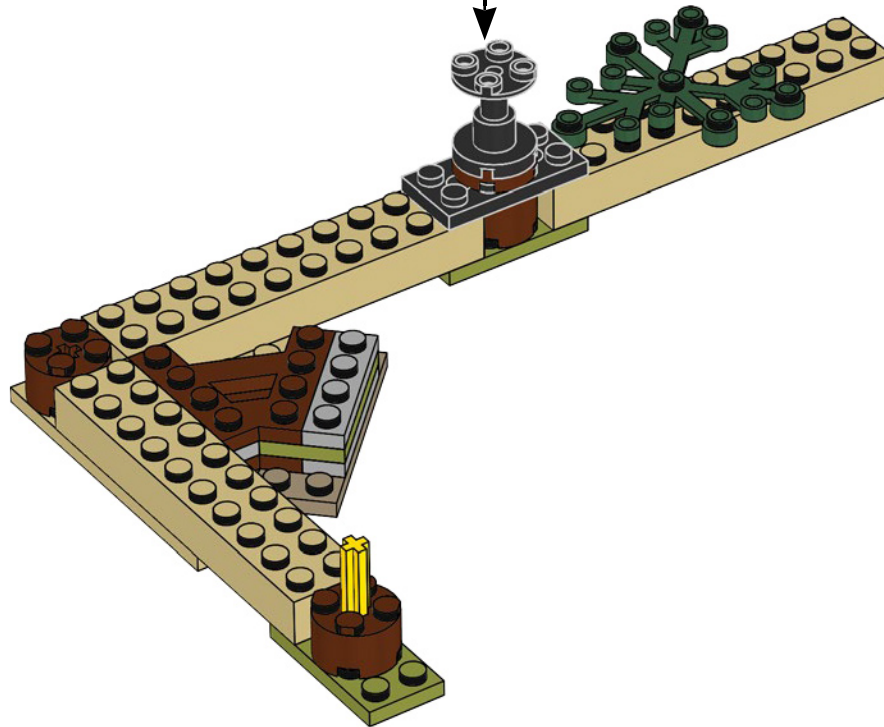
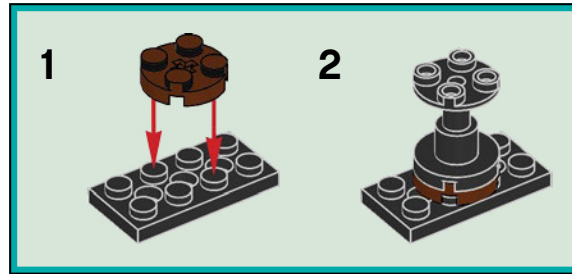

79

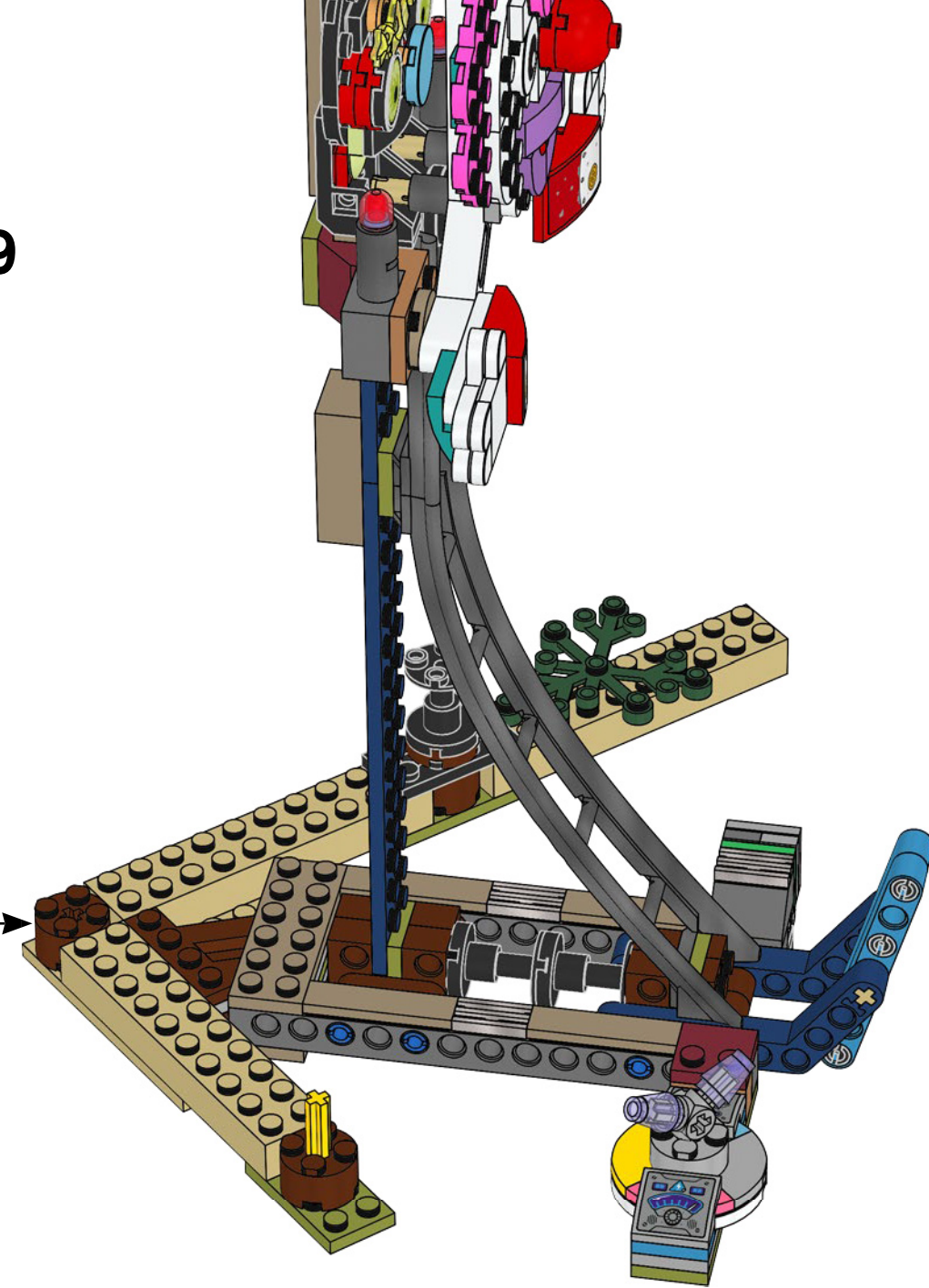

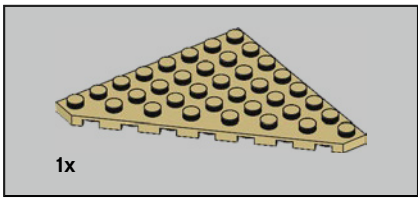

80

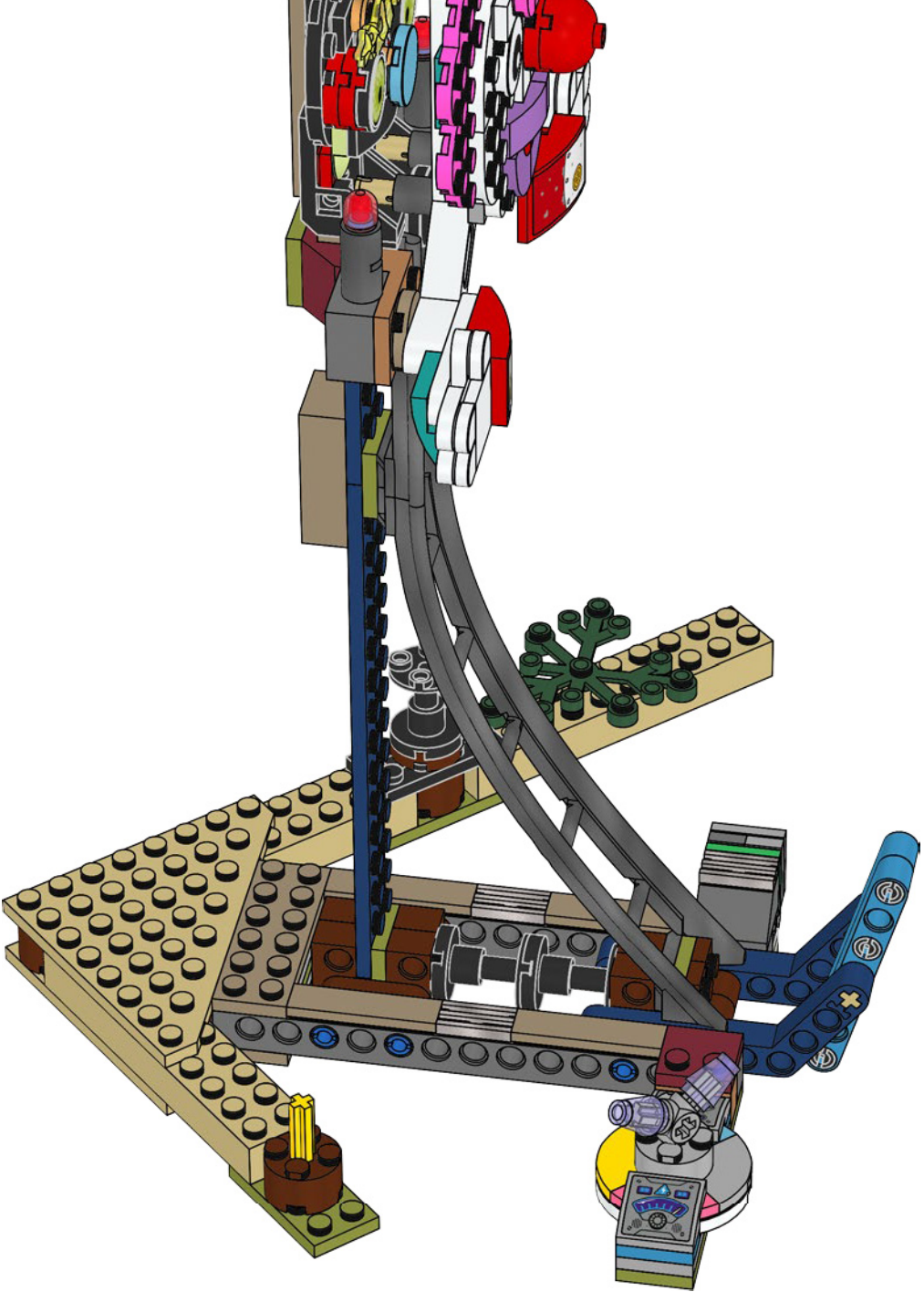

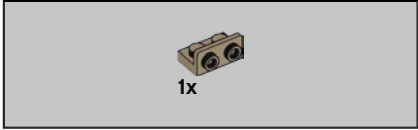
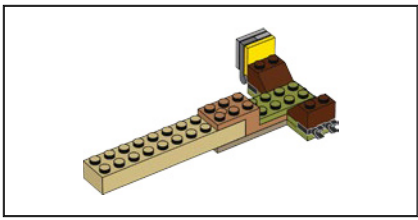

81

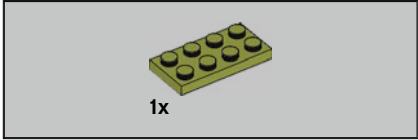

82

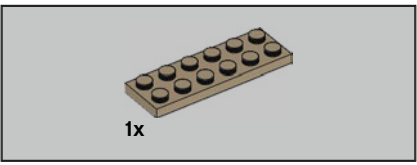
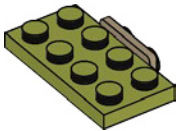

83

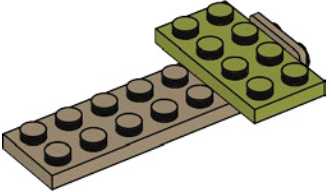

84

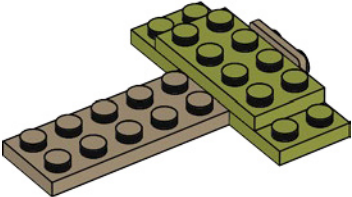



85

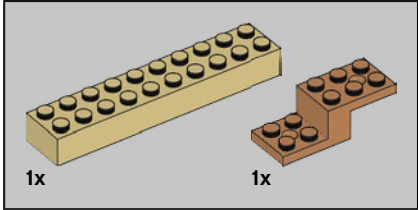
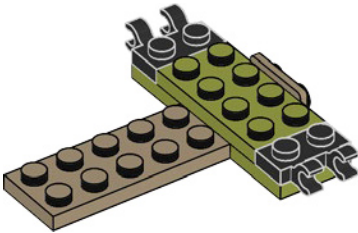

86

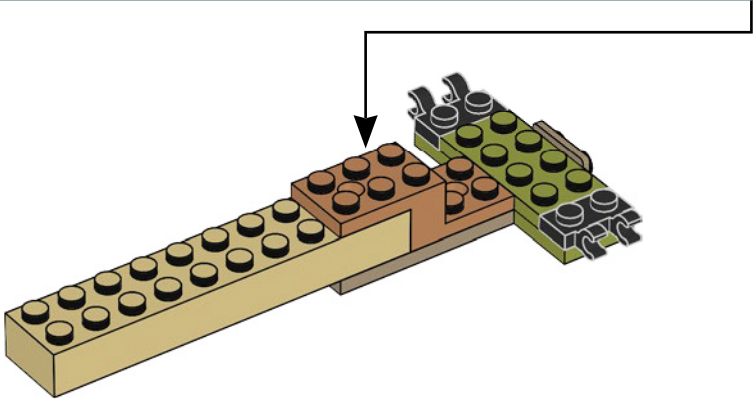
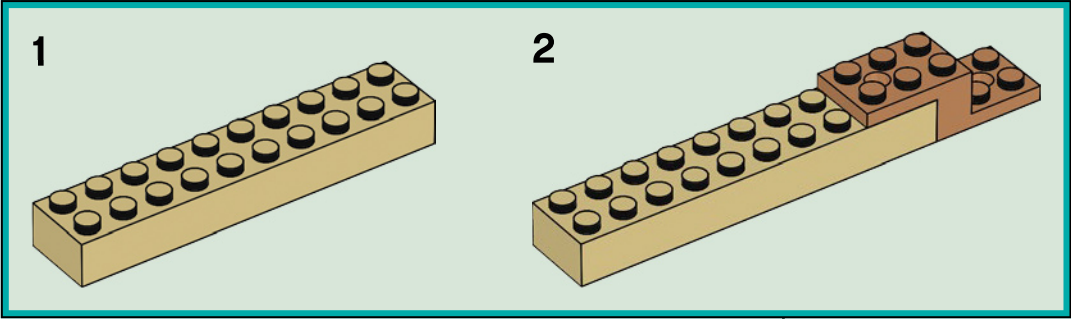

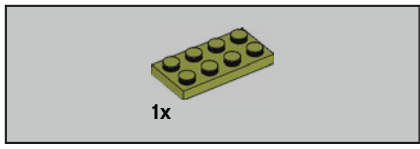

87

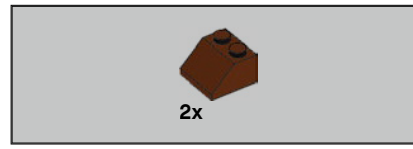
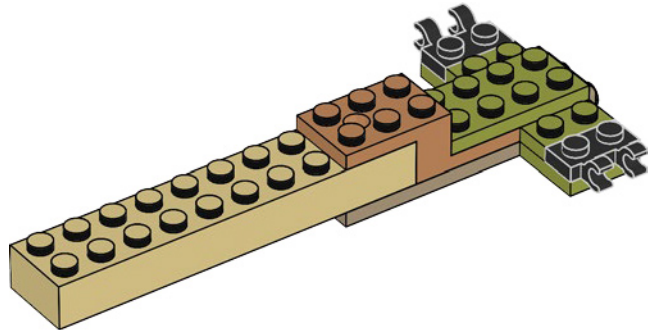

88

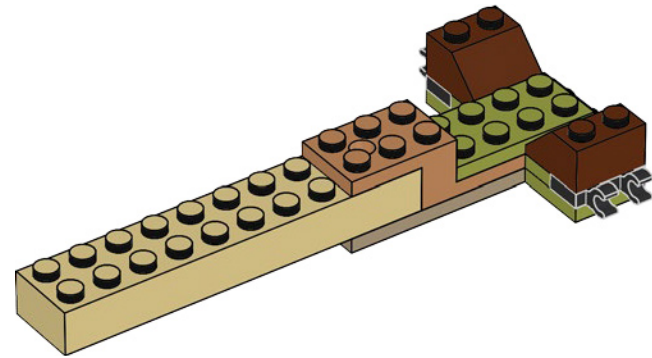

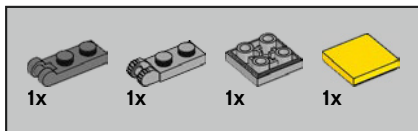

89

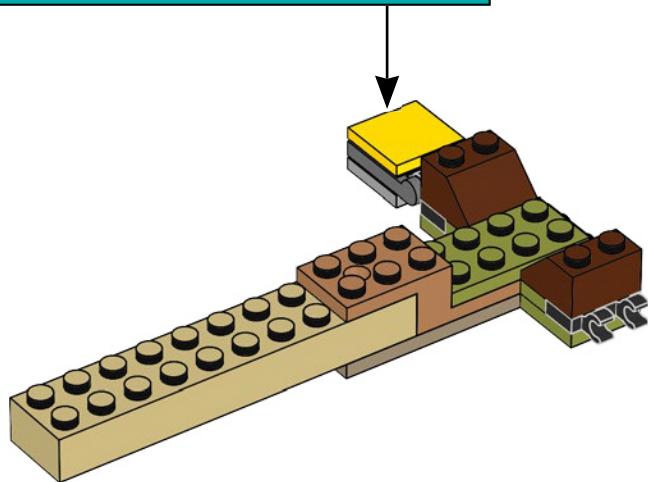
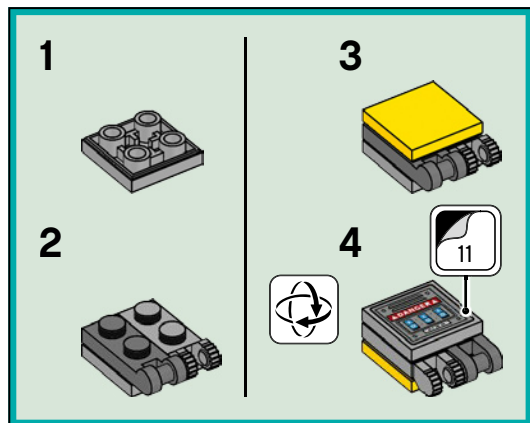

90

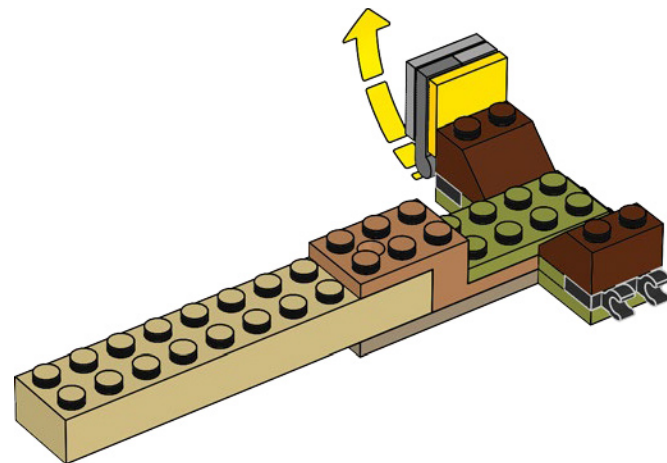

91

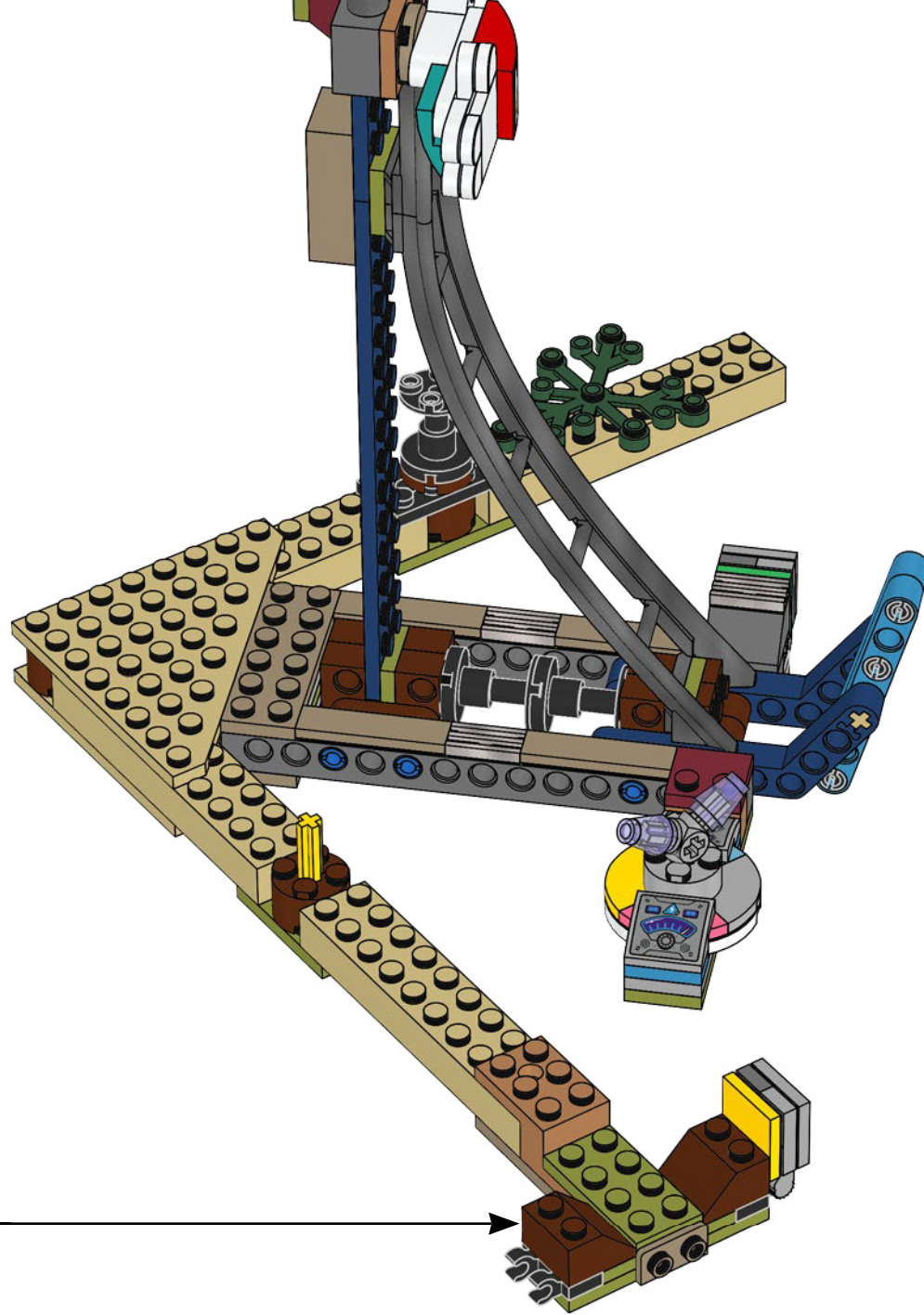

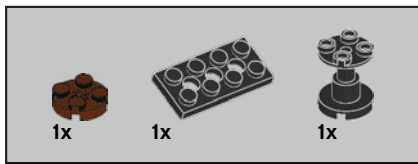

92

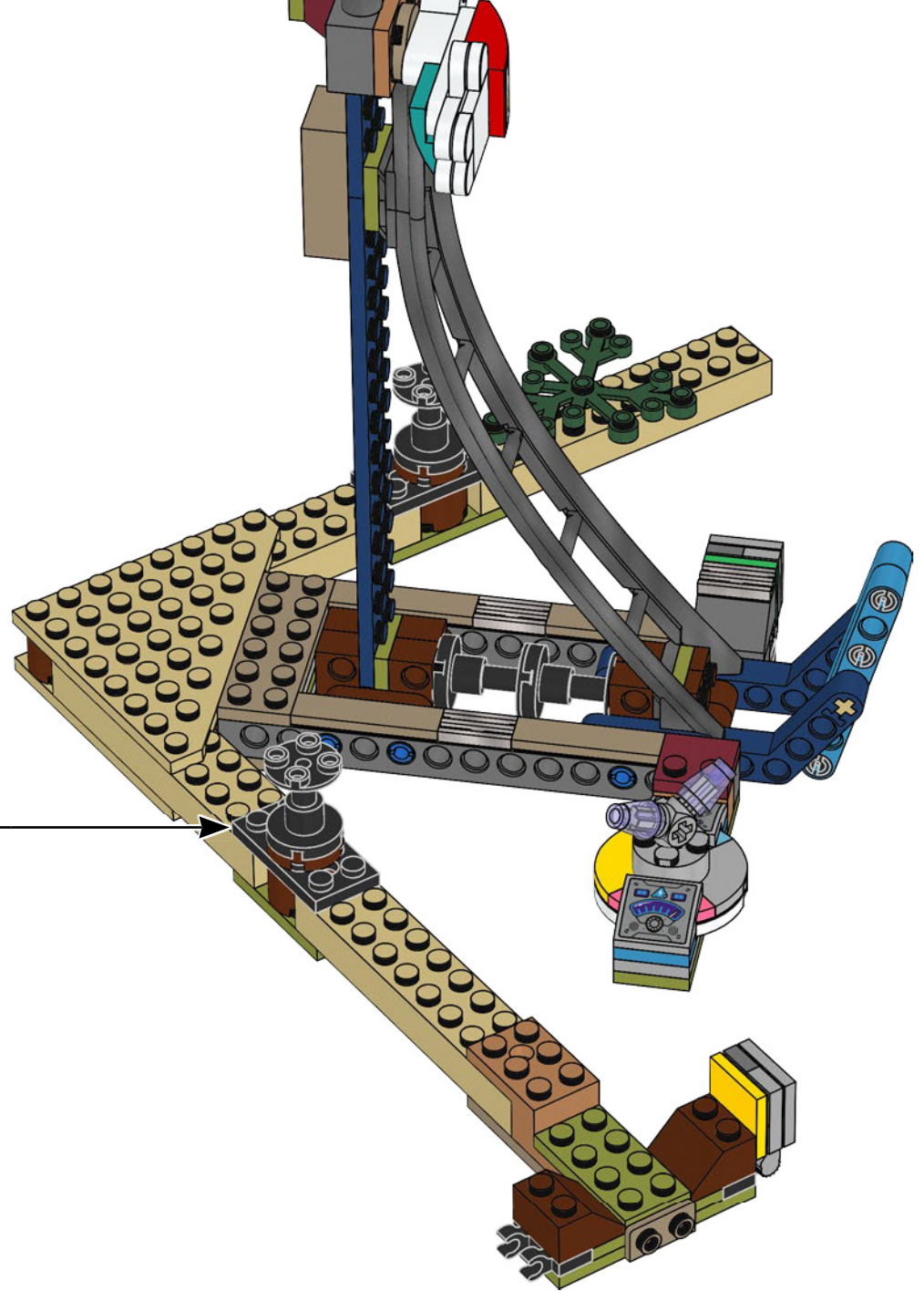
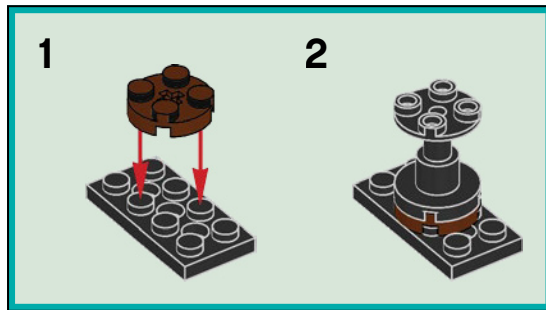

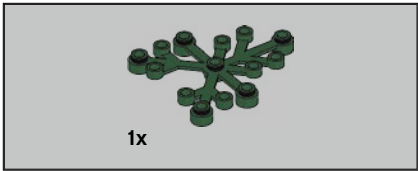

93

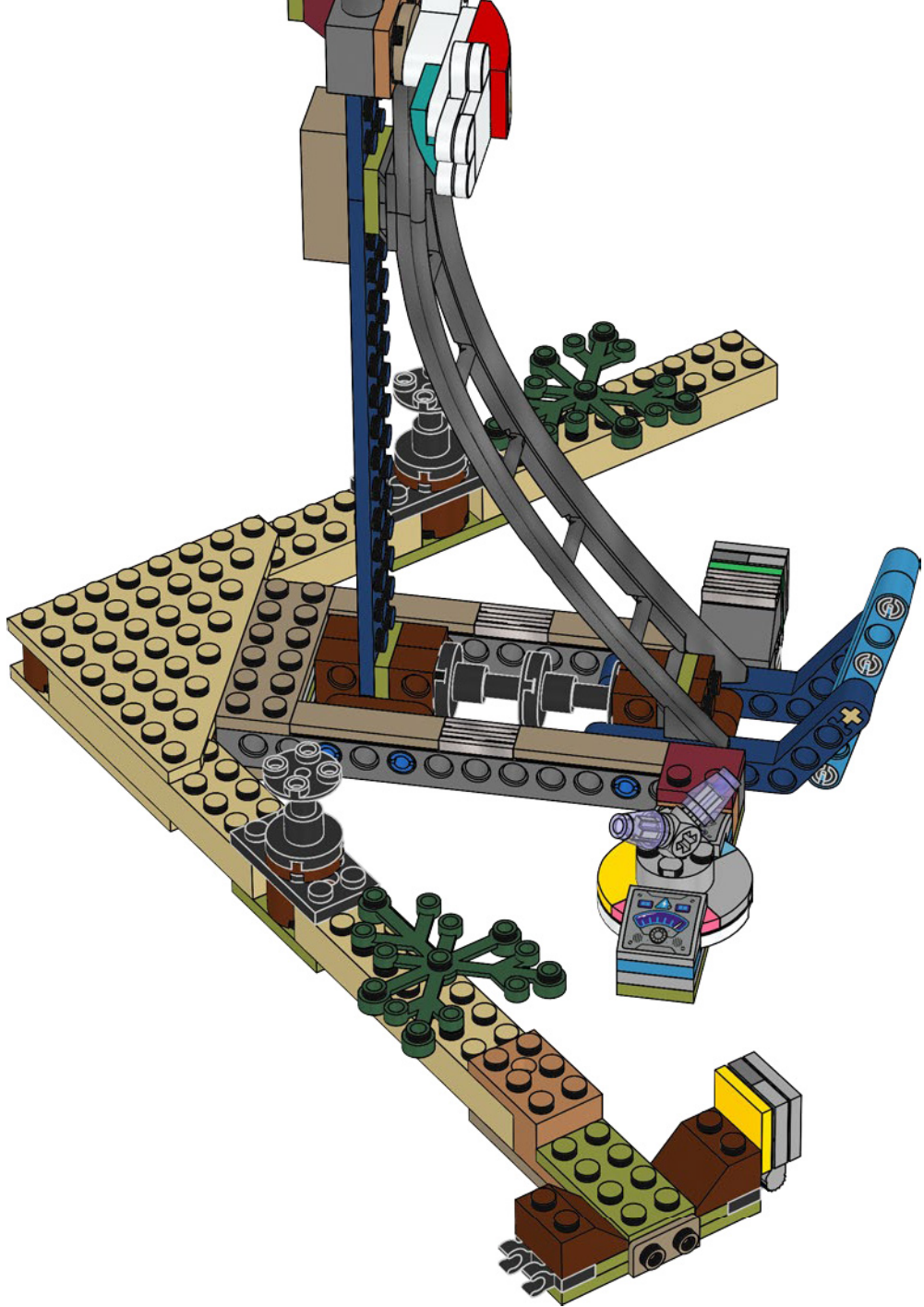

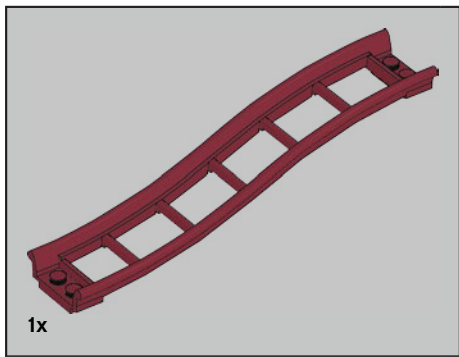

94



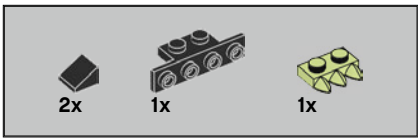

95

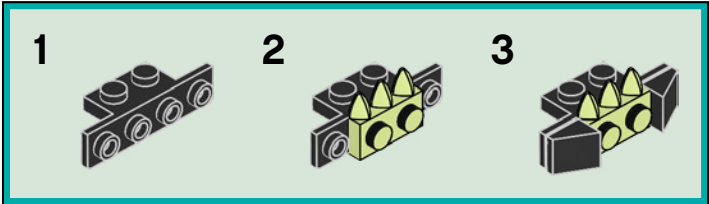
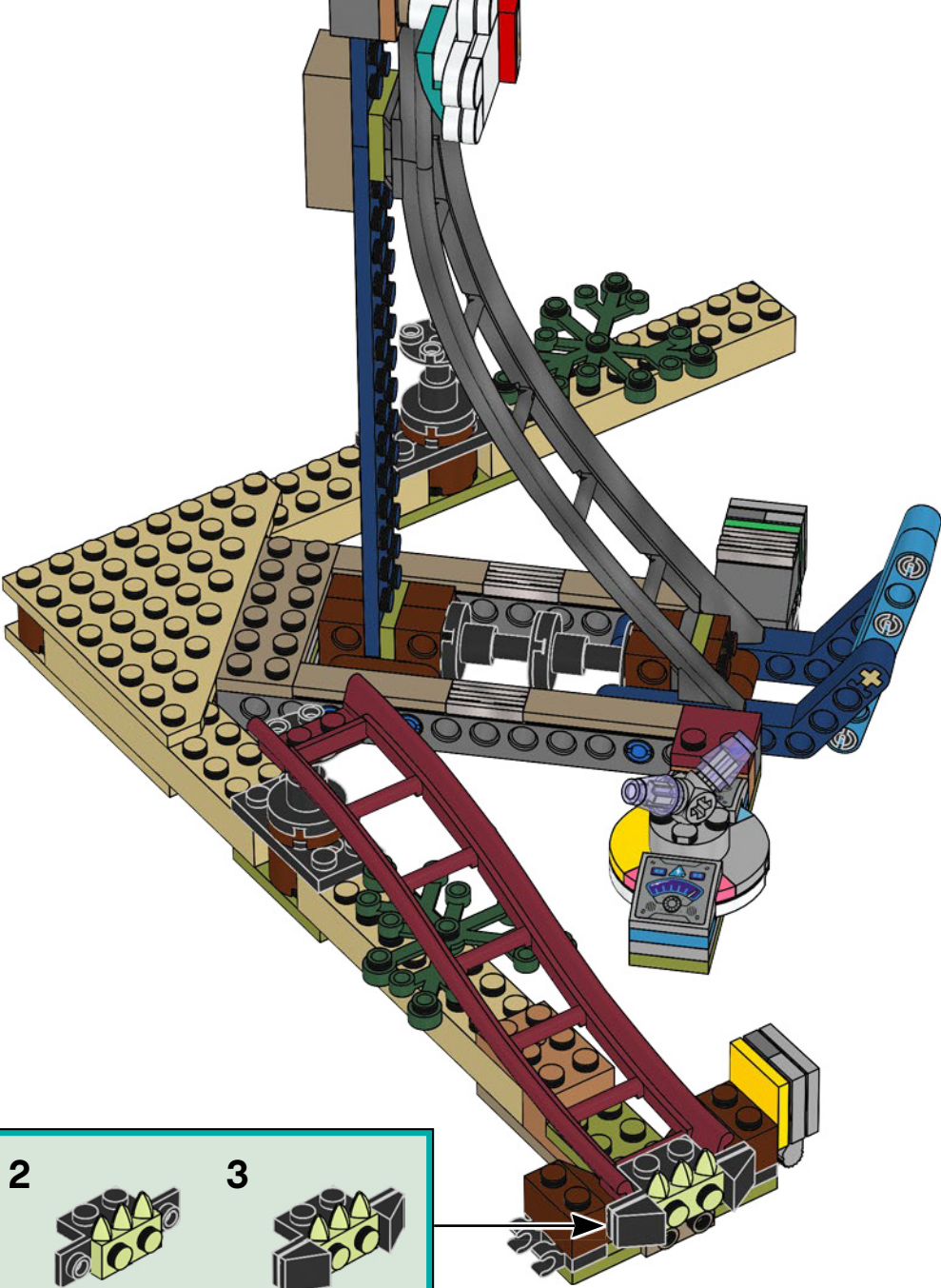



96

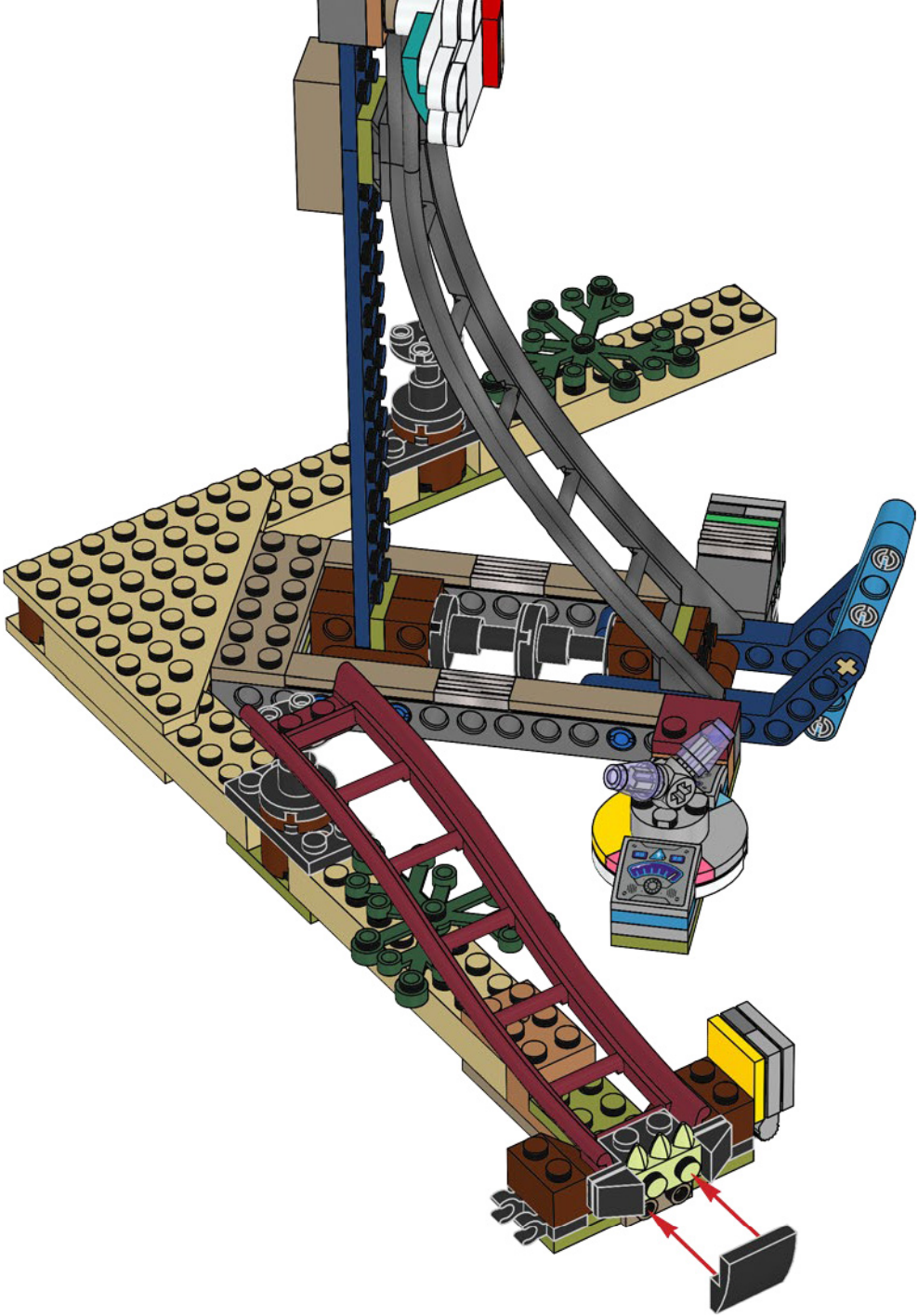

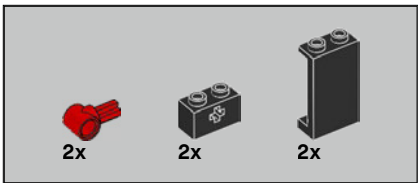

97

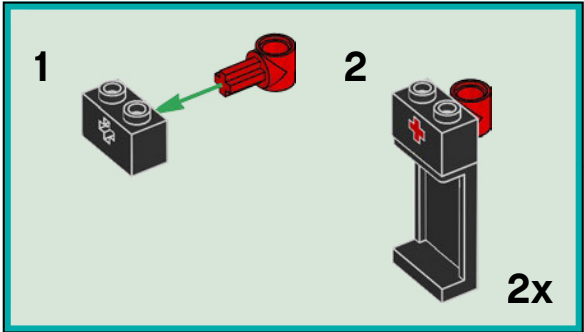
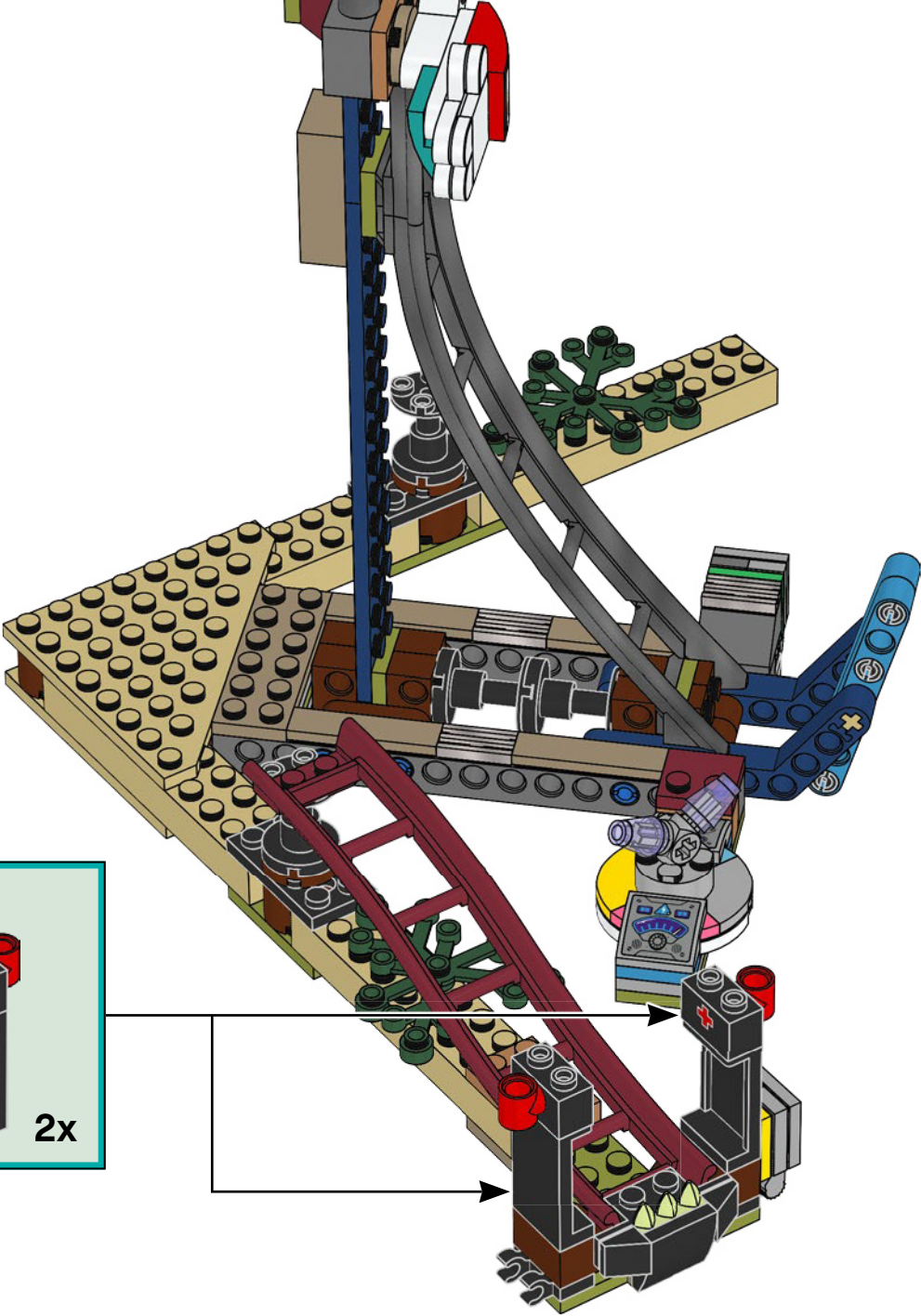

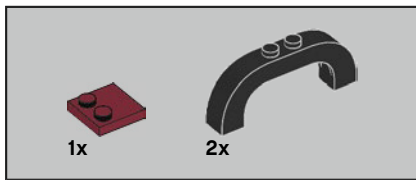

98

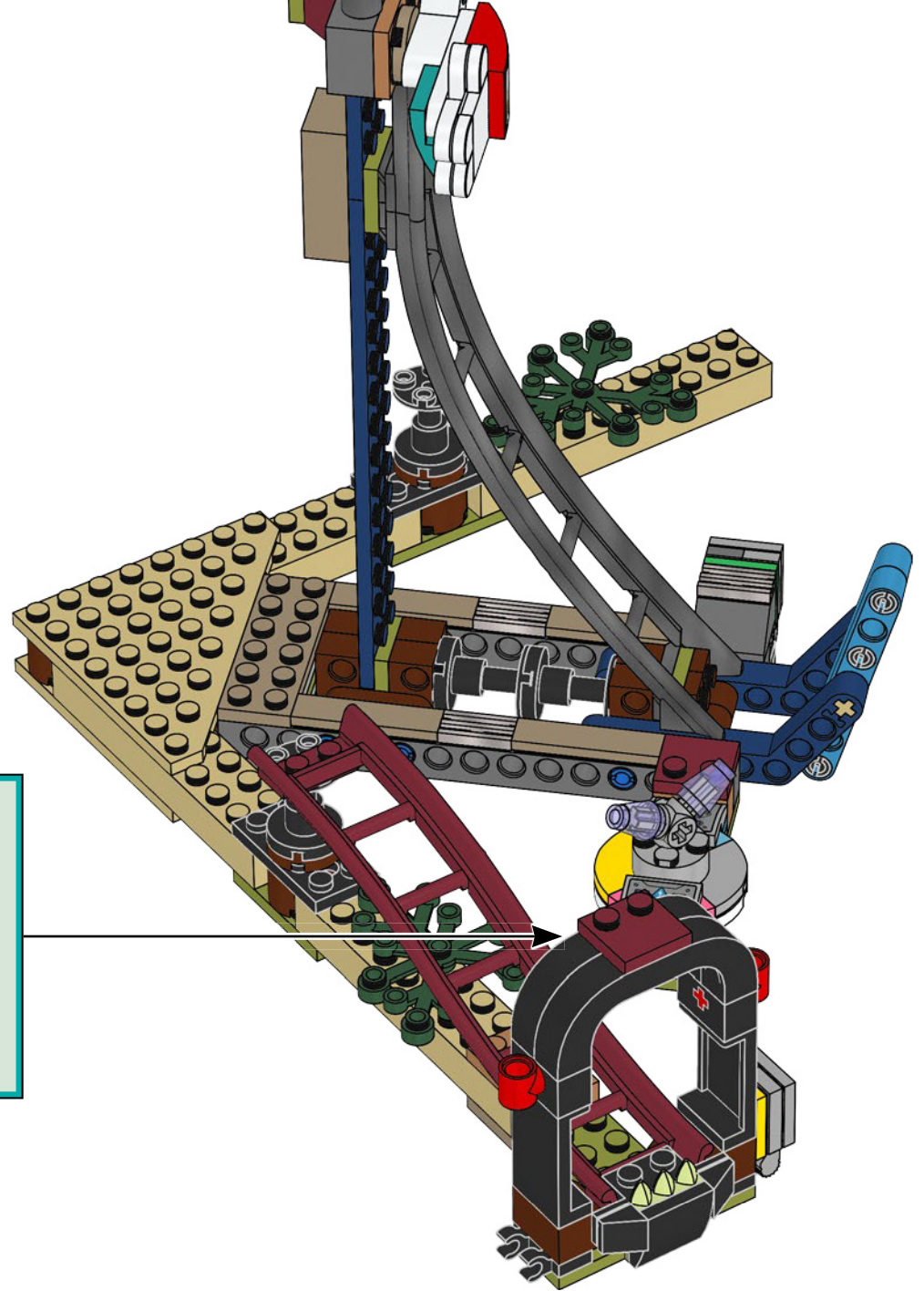
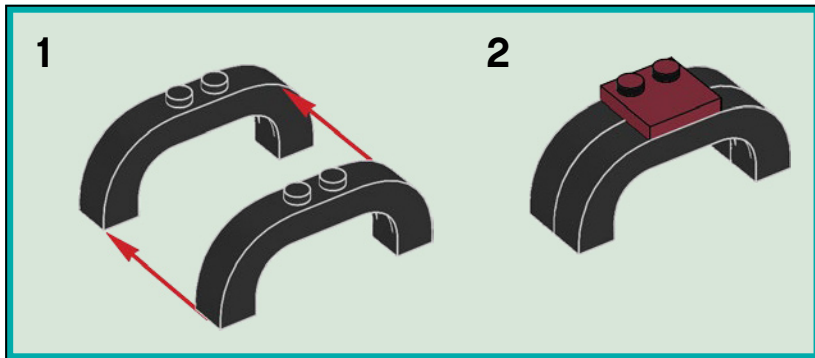

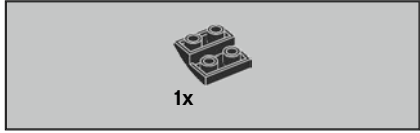
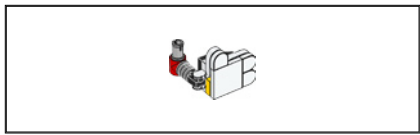

99

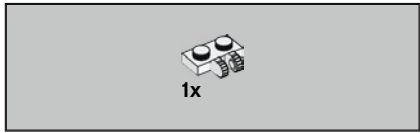
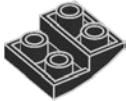

100

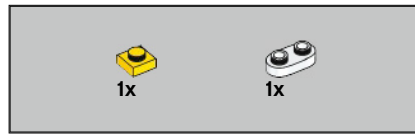

101

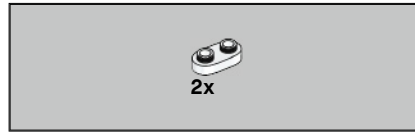

102



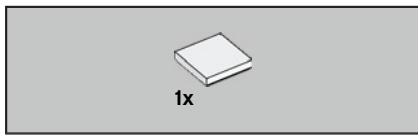

103

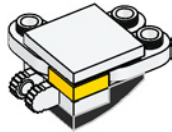

104



105

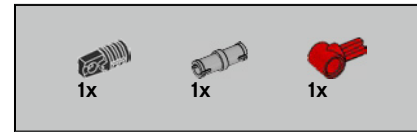
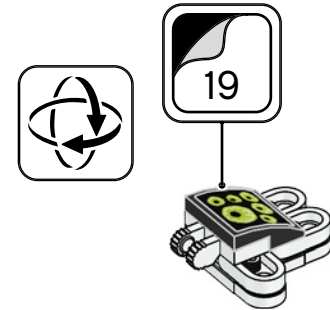

106

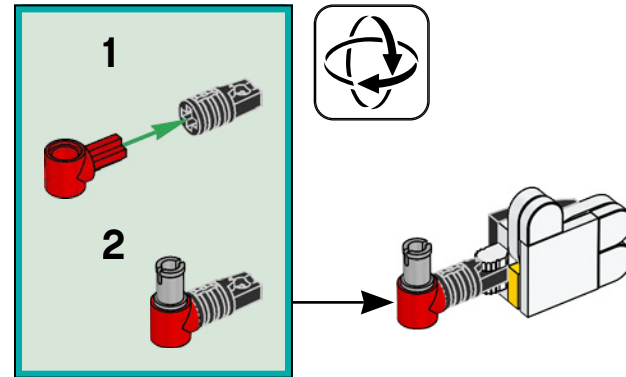

107

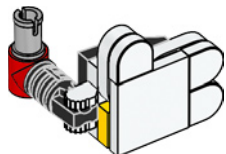

108

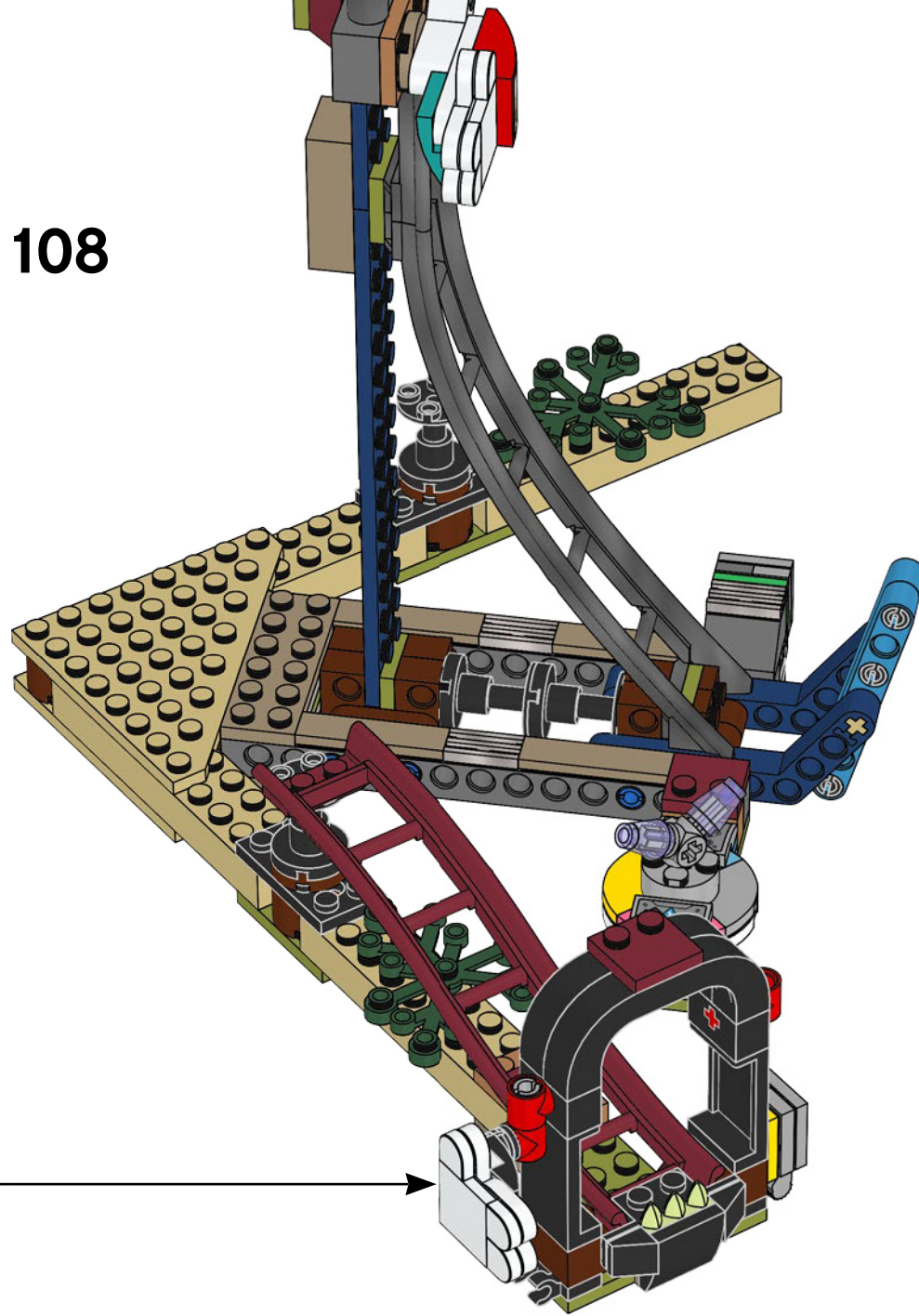

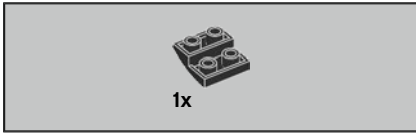
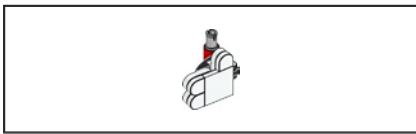

109

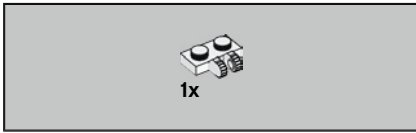

110

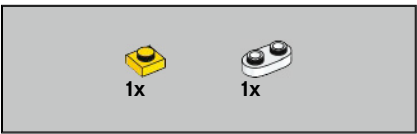

111



112



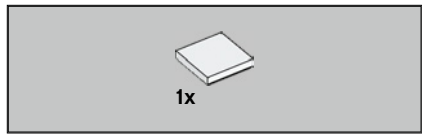

113



114



115

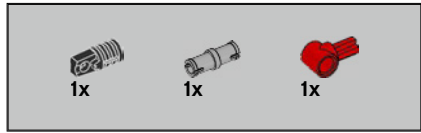
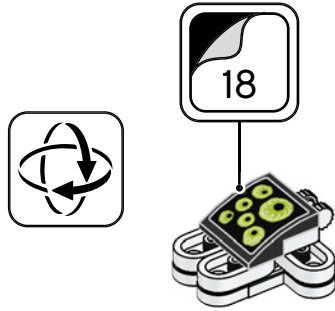

116

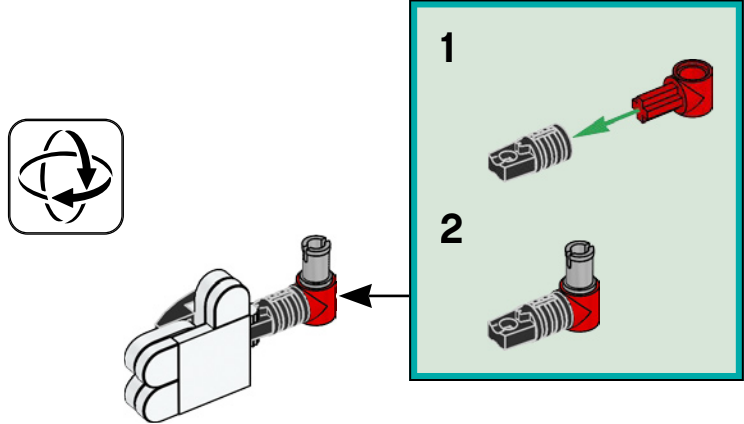

117

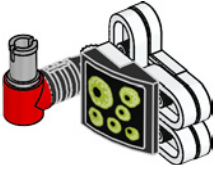

118

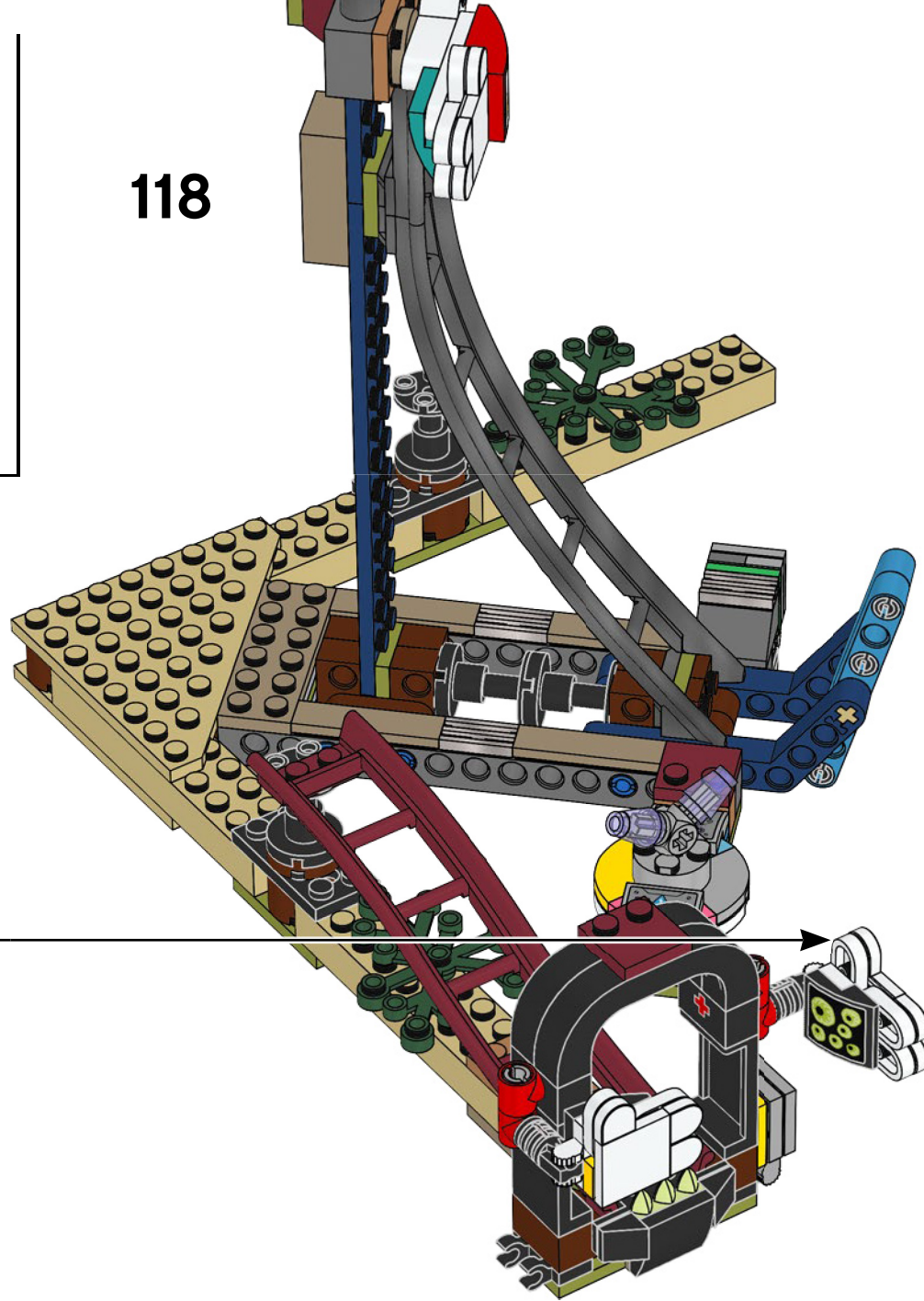

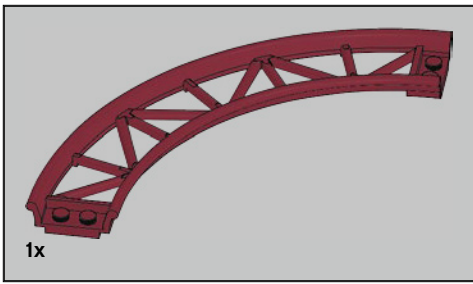

119

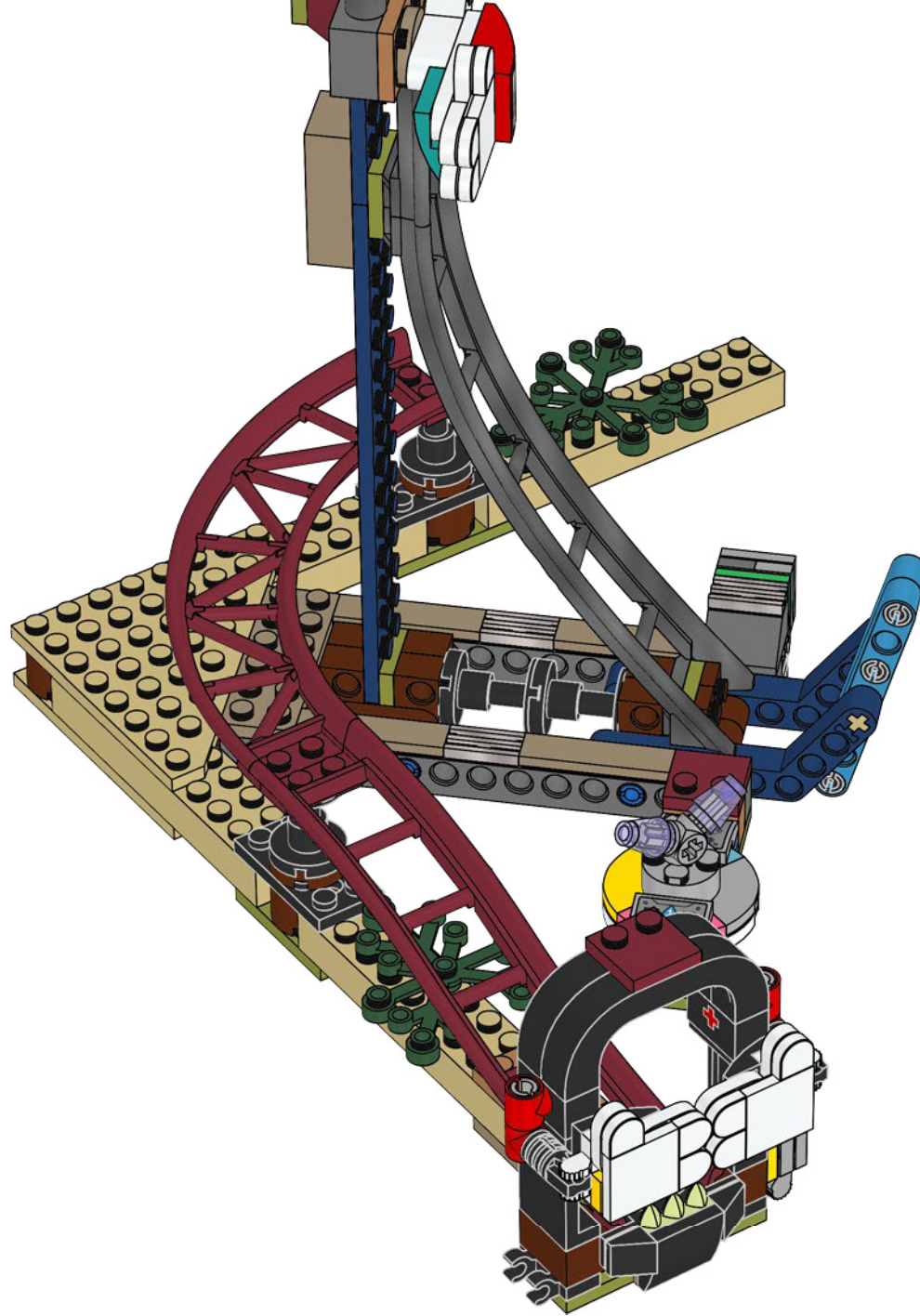

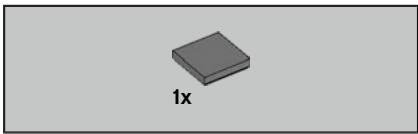

120

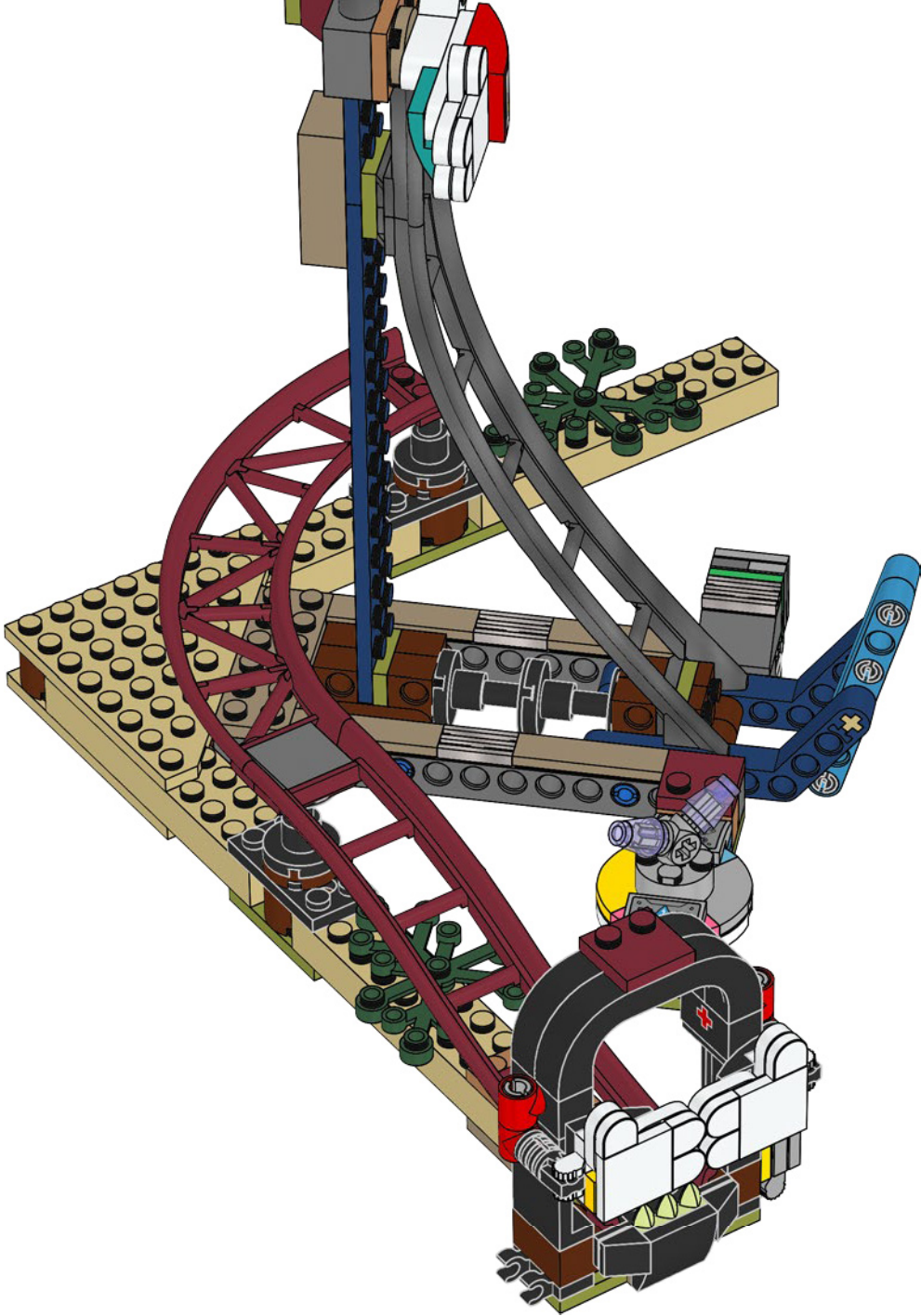

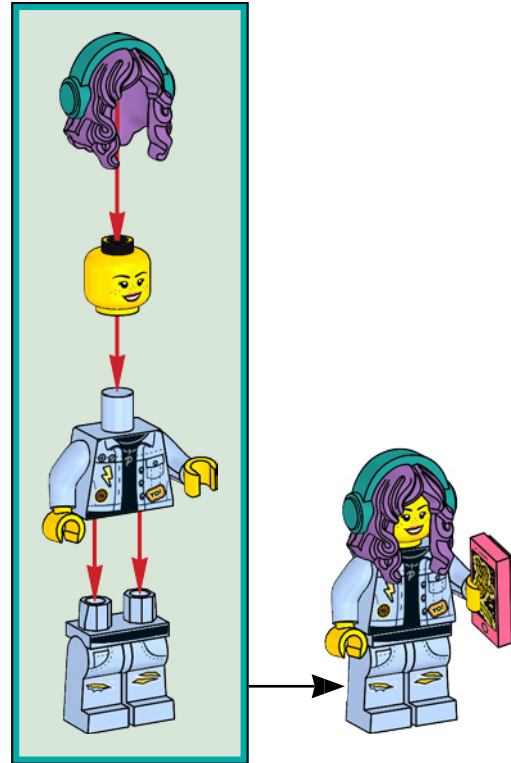
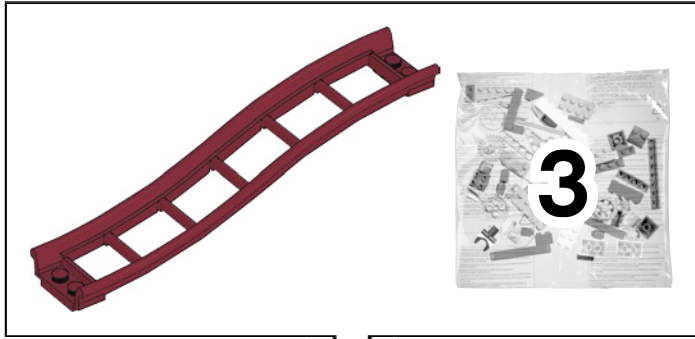

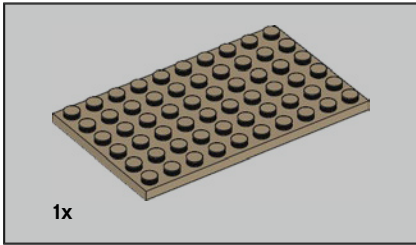
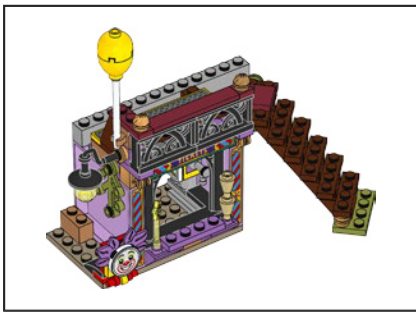

121

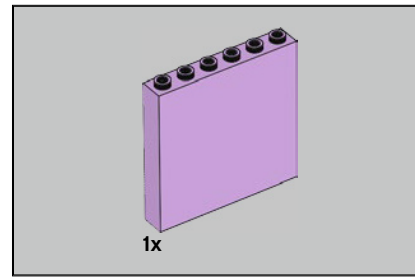
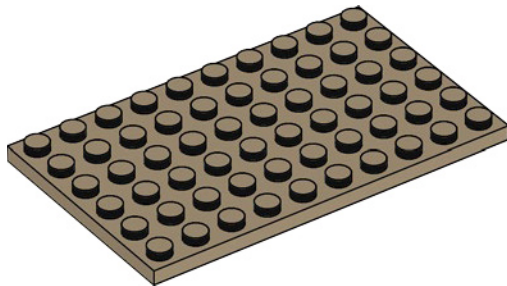

122

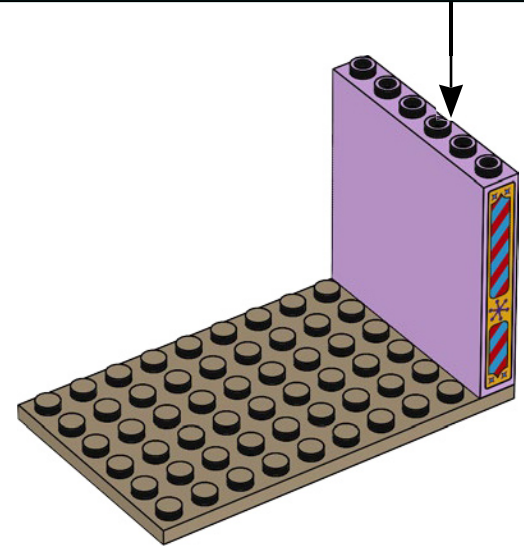
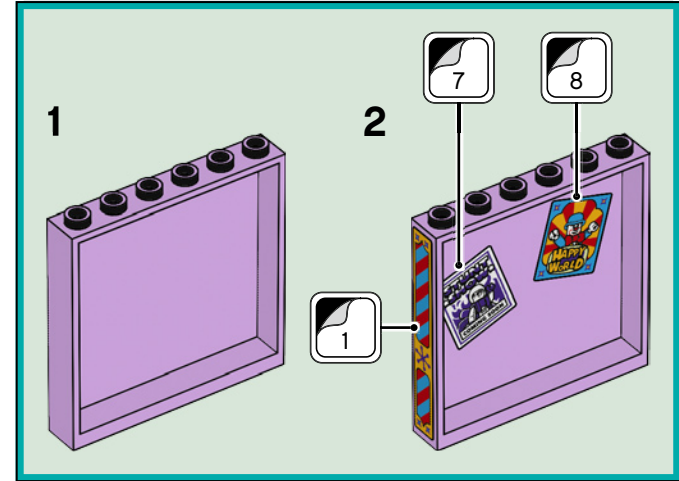

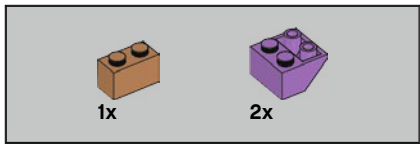

123

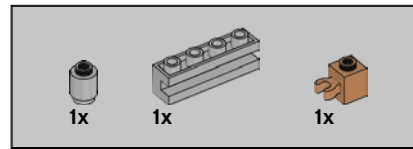
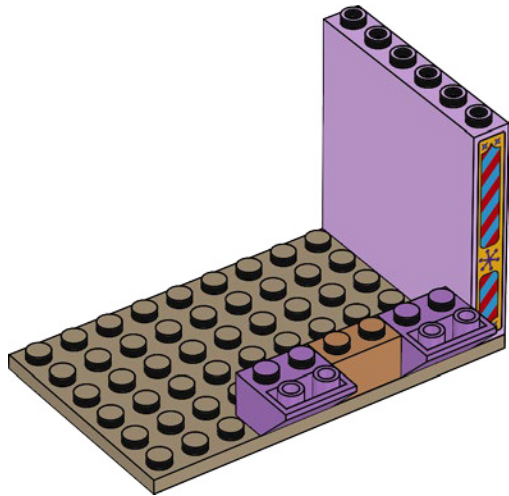

124

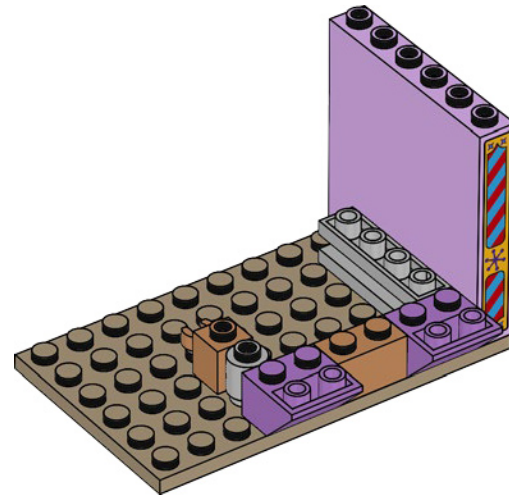

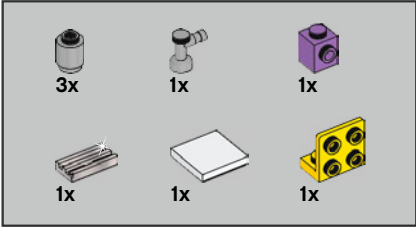
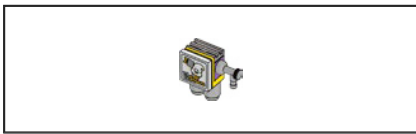

125

1



2



3

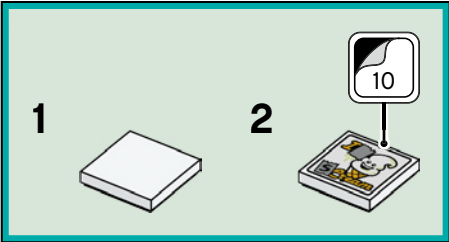

4



5



6

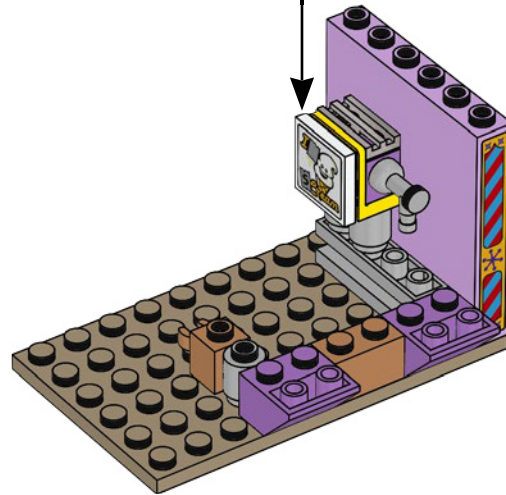



126

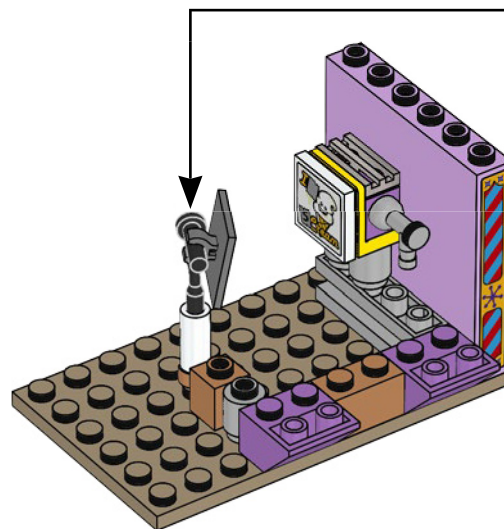
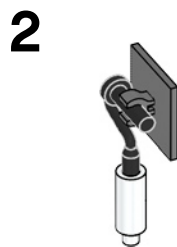
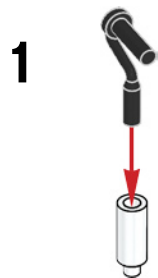

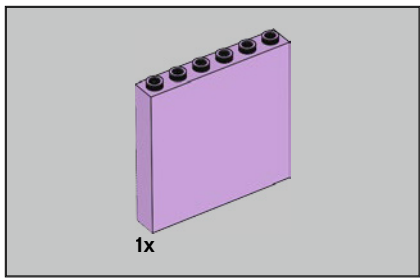

127

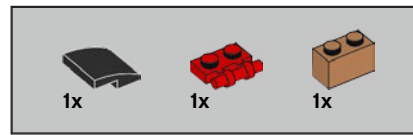
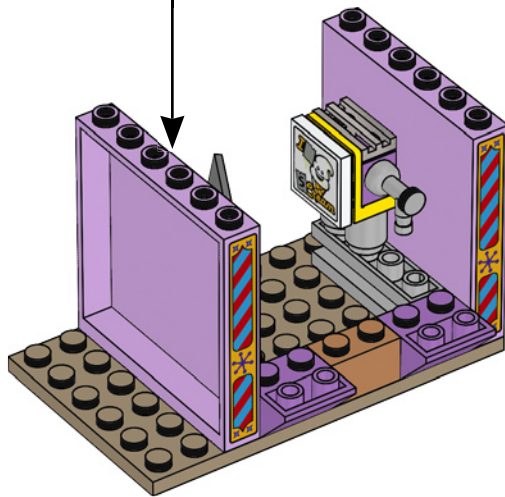
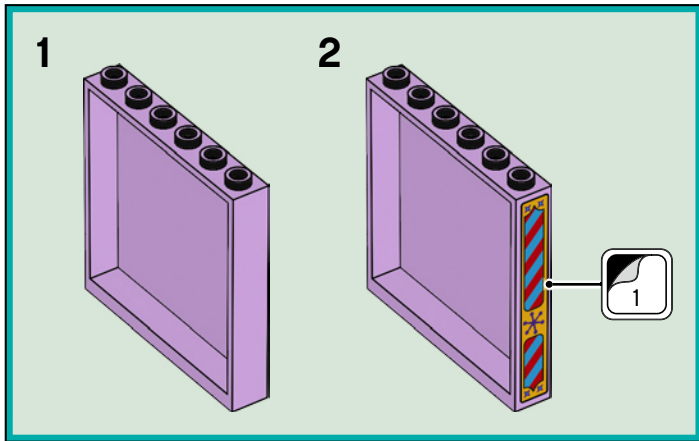

128

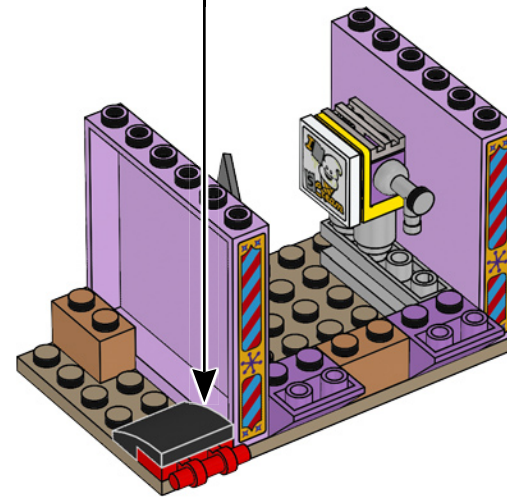
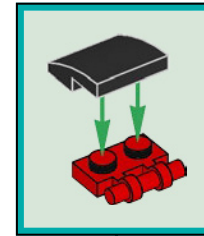

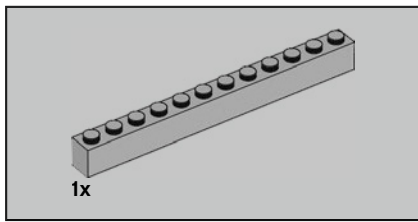

129

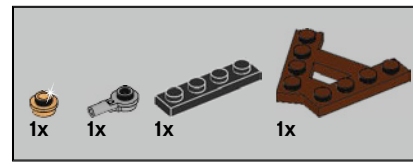
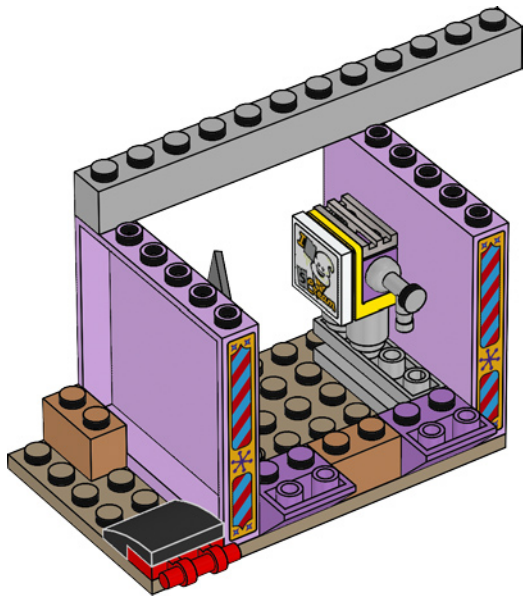

130

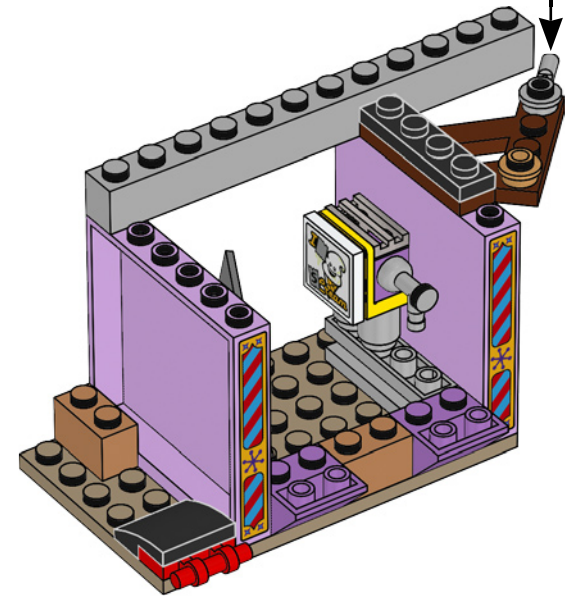
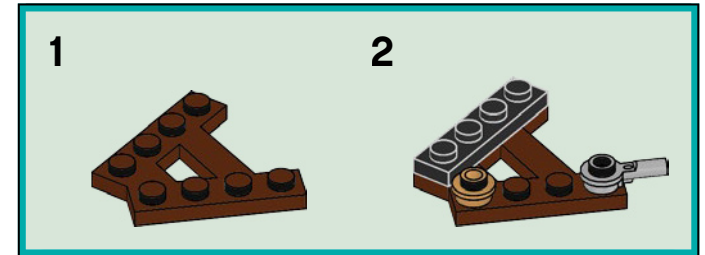

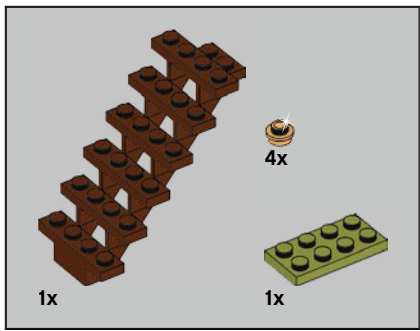

131

1

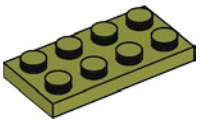

2

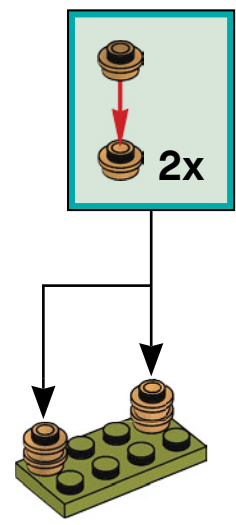

3

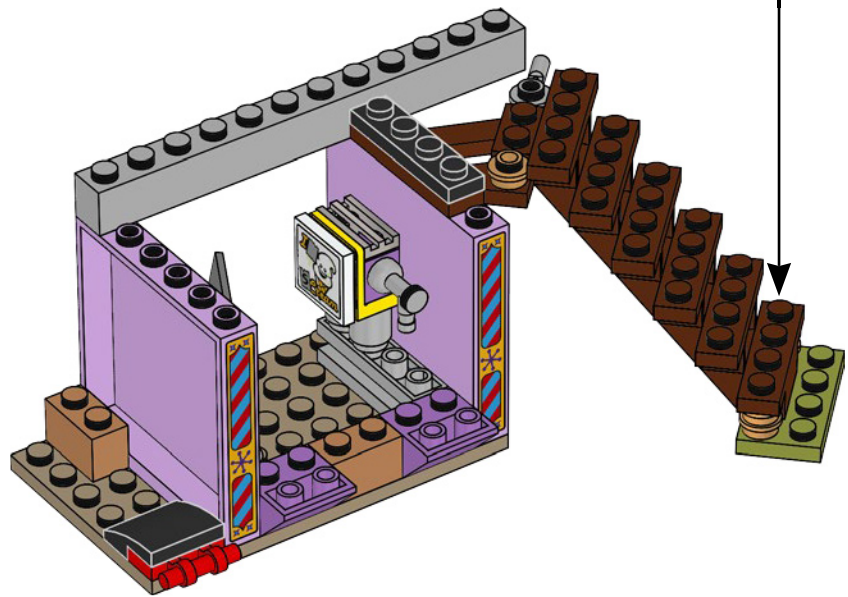
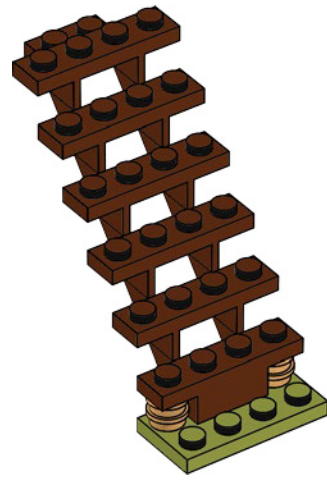

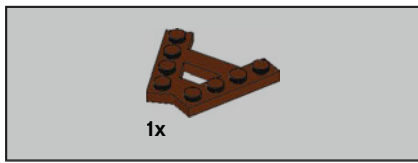

132

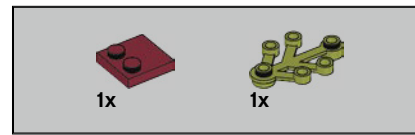
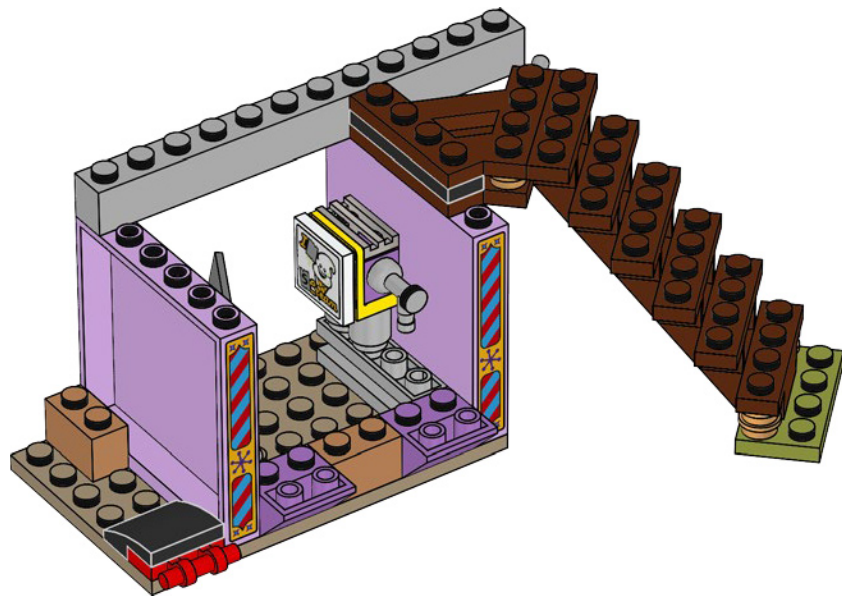

133

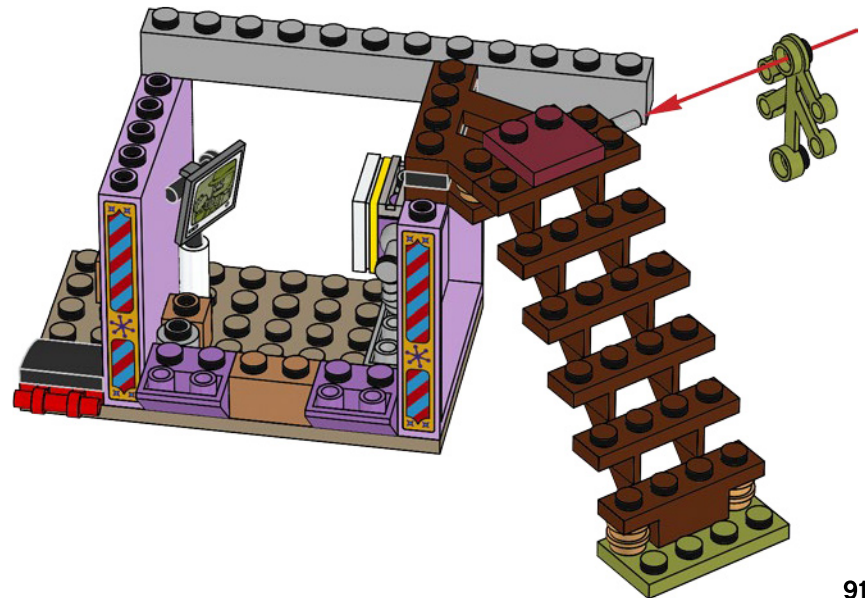

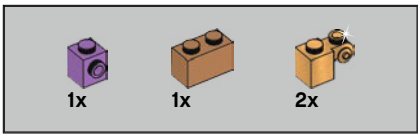

134

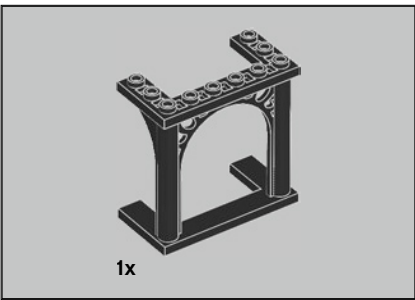
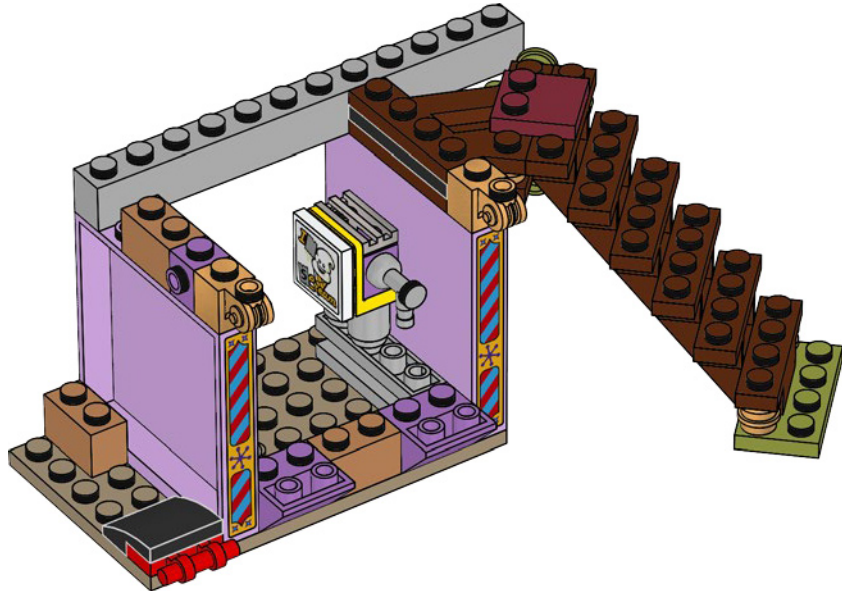

135

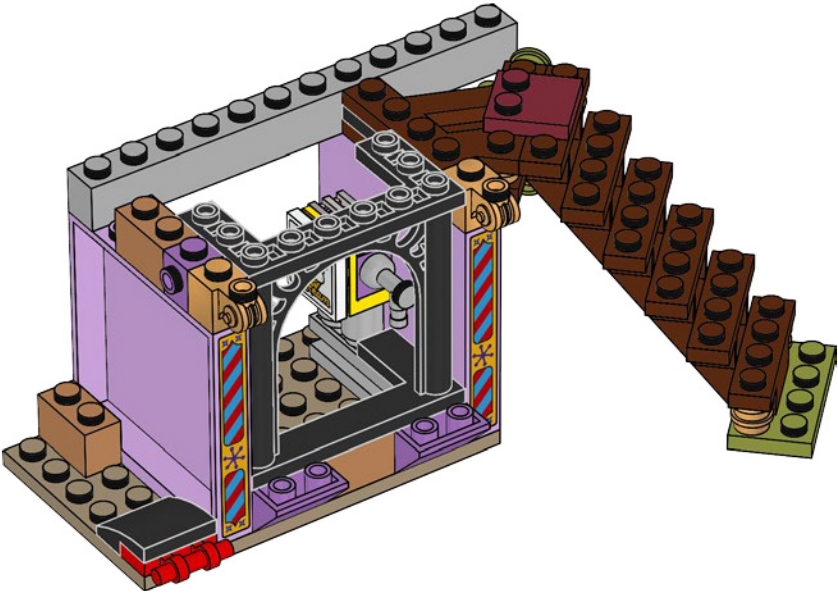

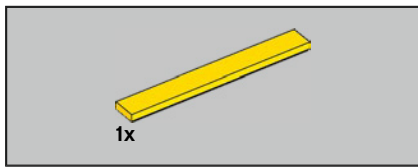

136

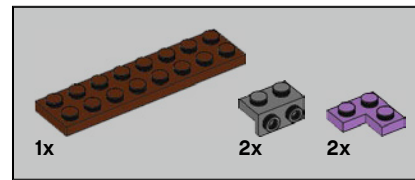
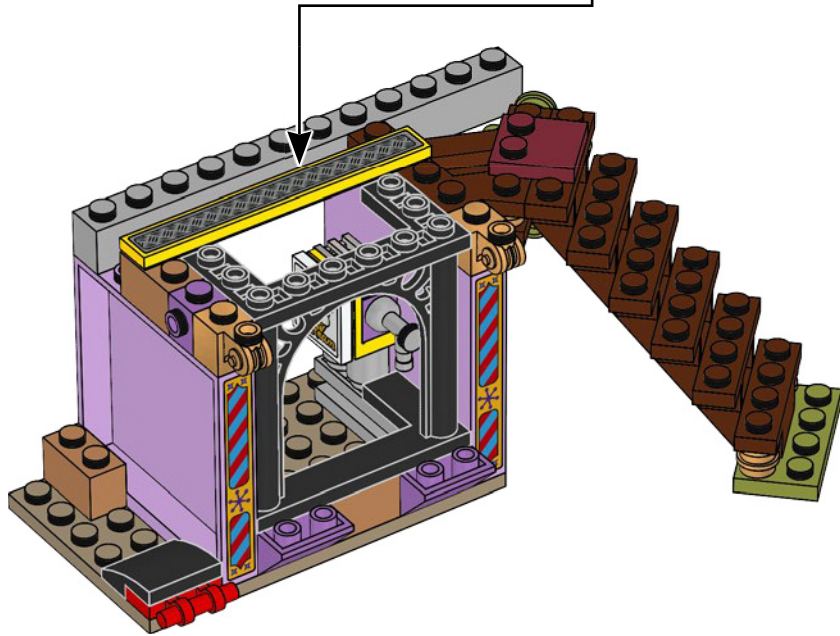
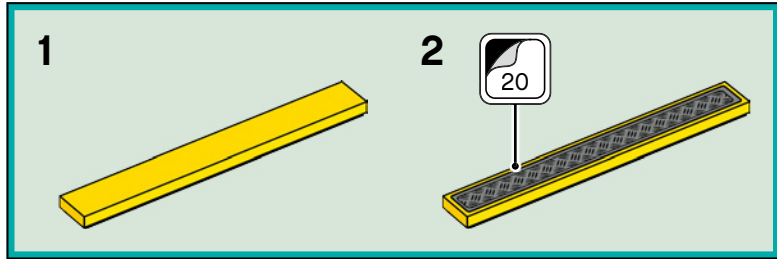

137

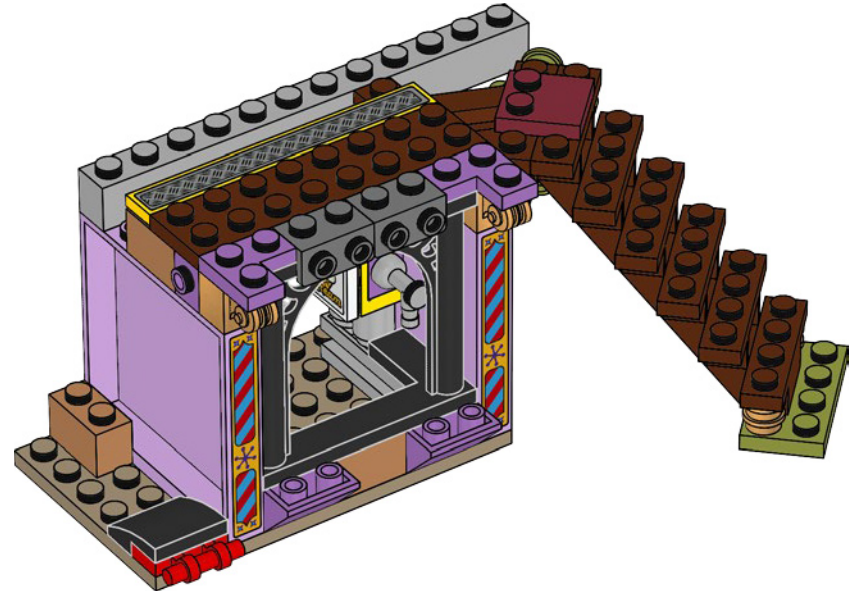

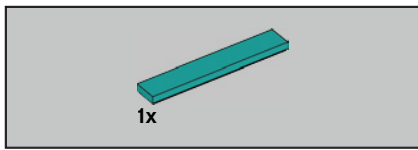

138

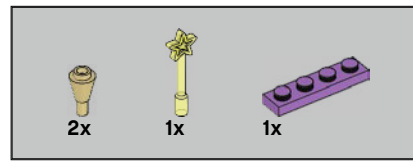
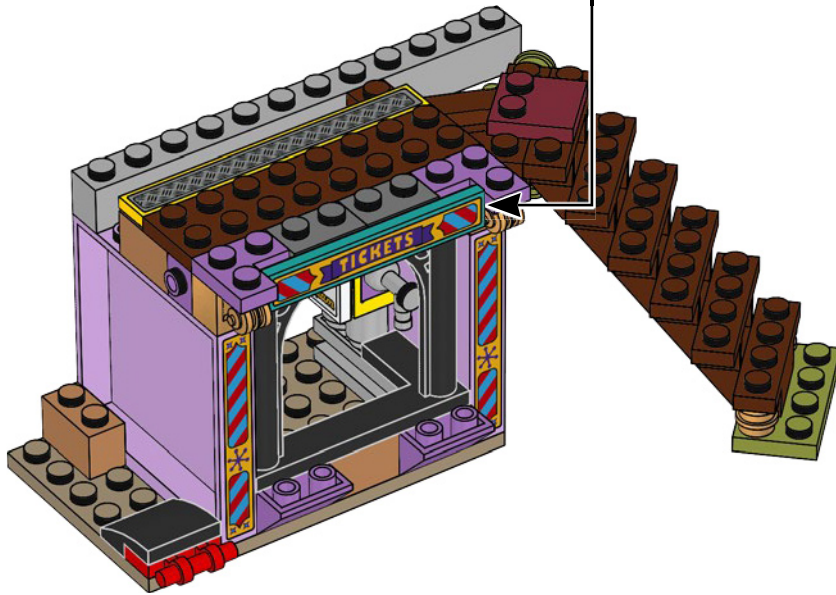
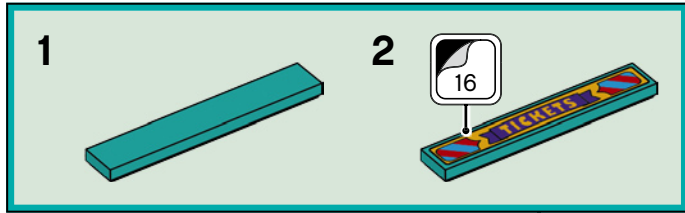

139

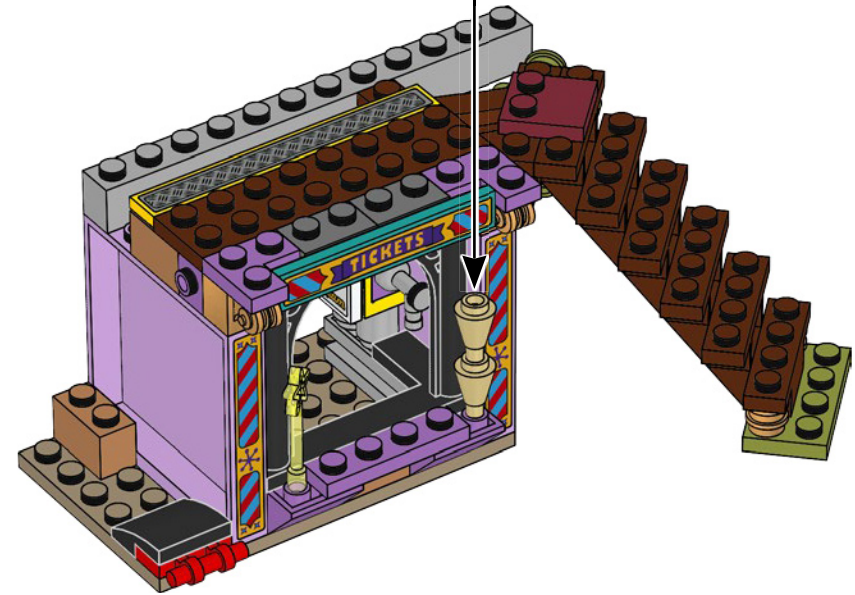
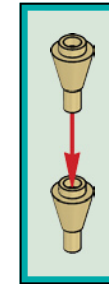

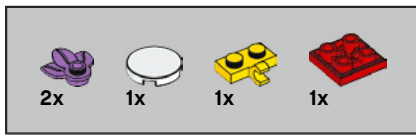

140

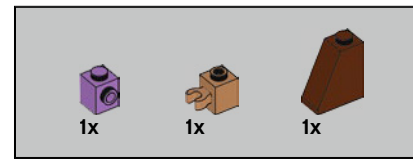
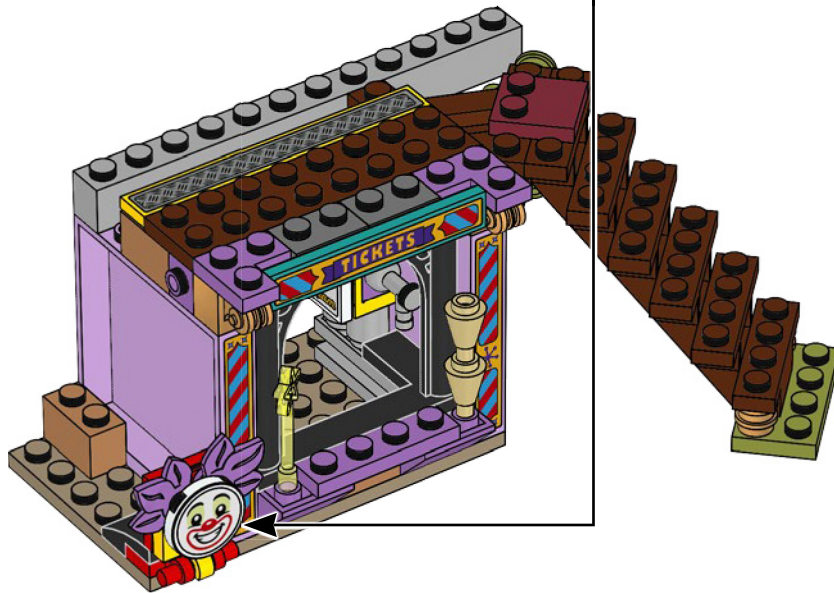
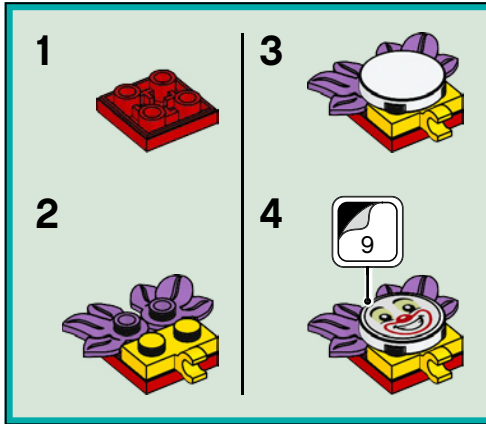

141

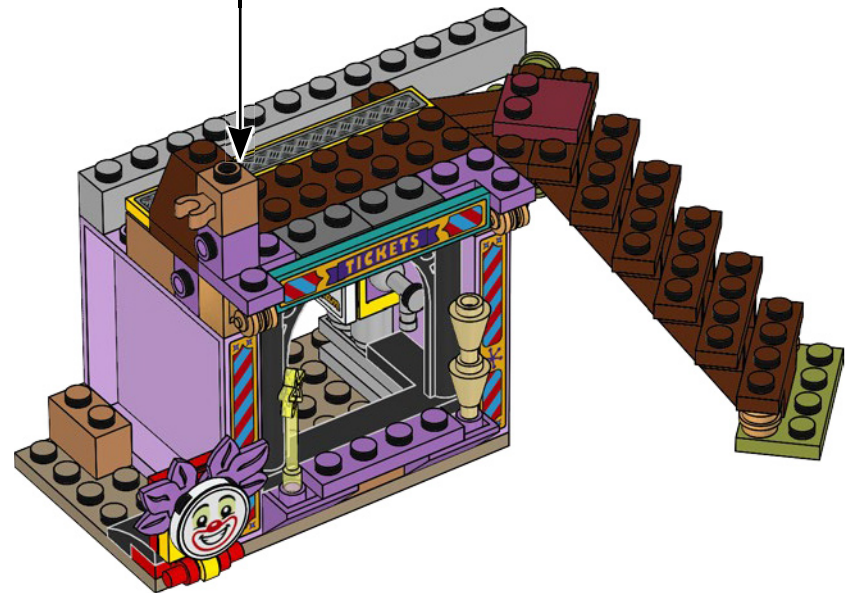
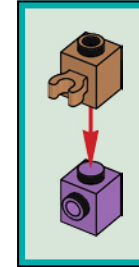

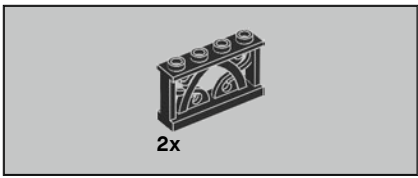

142

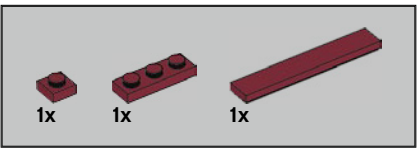
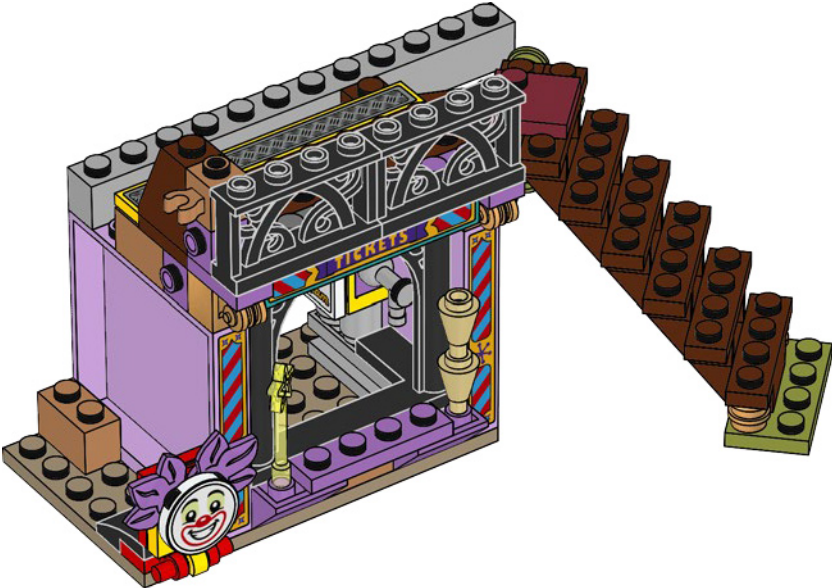

143

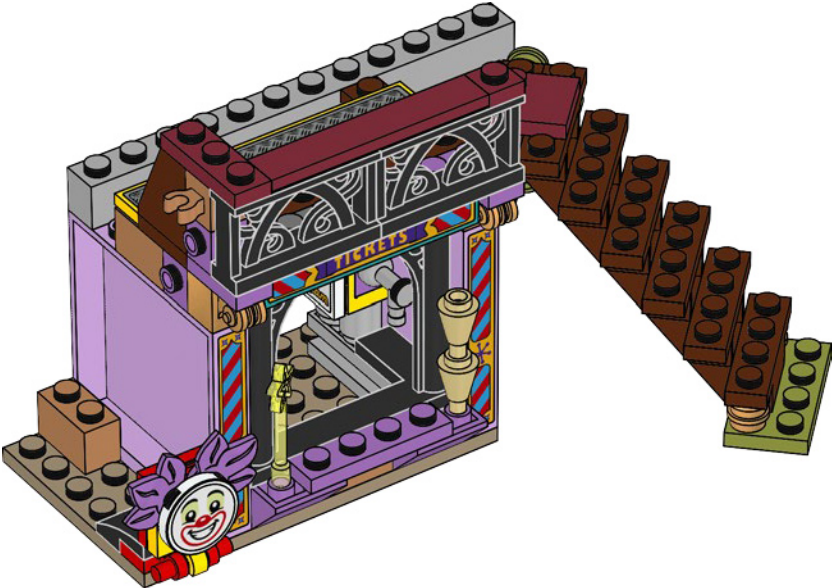

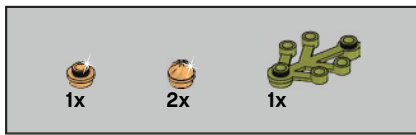

144

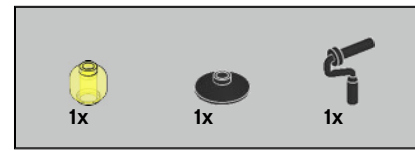
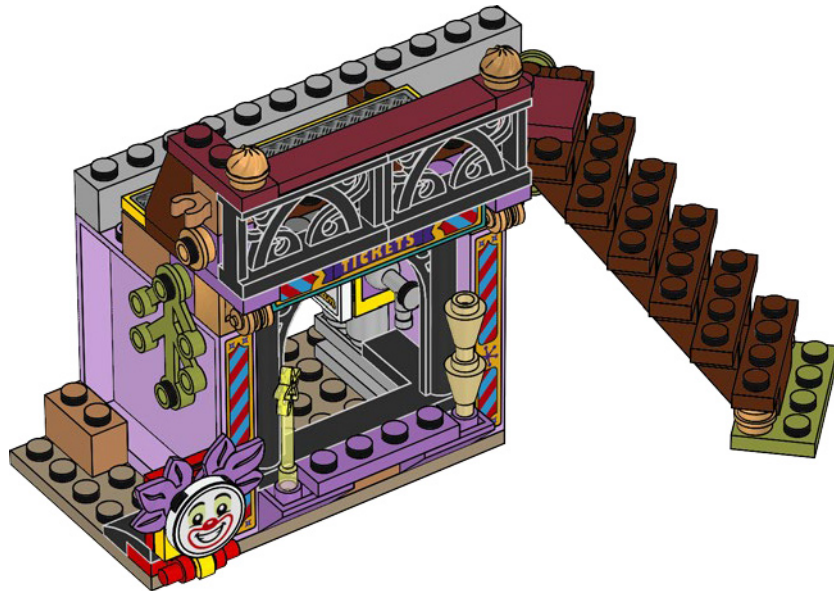

145

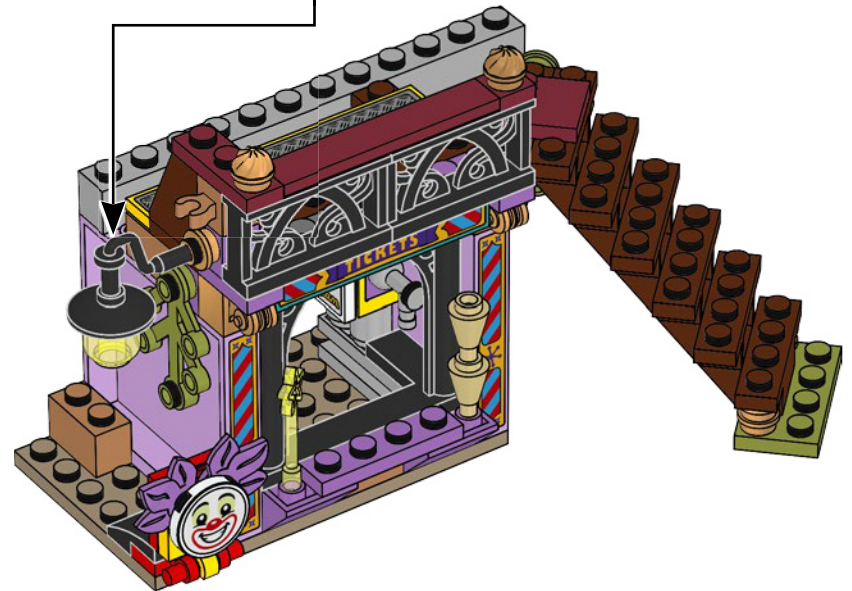
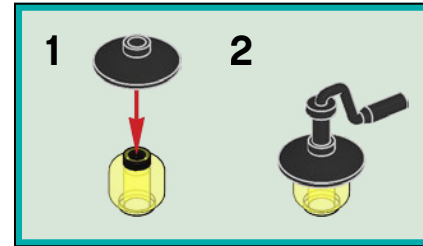

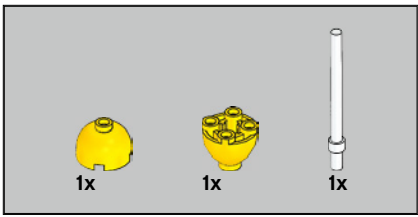

146

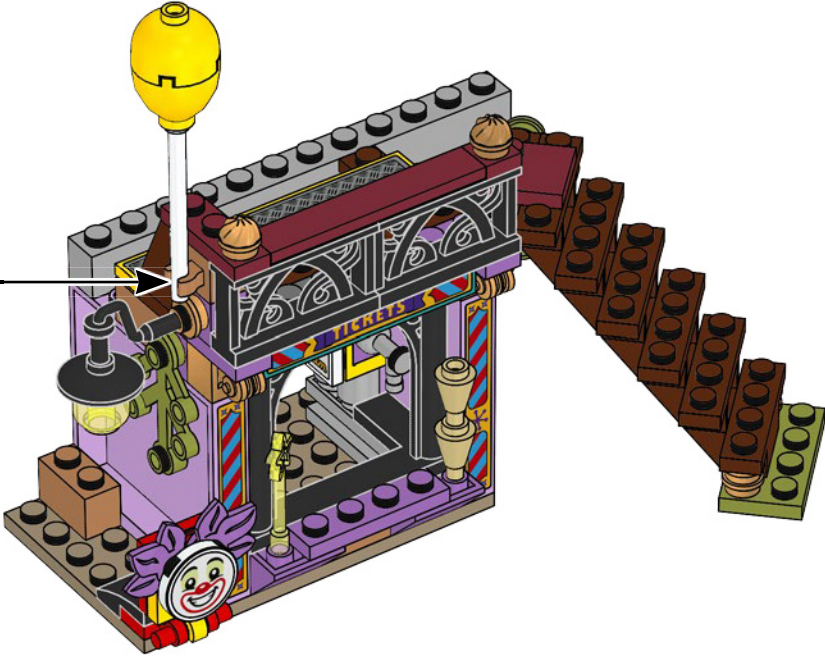
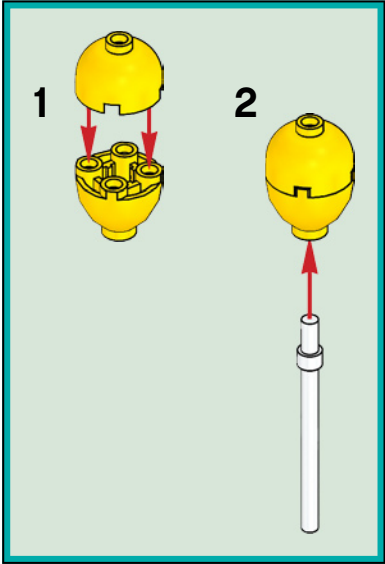

147

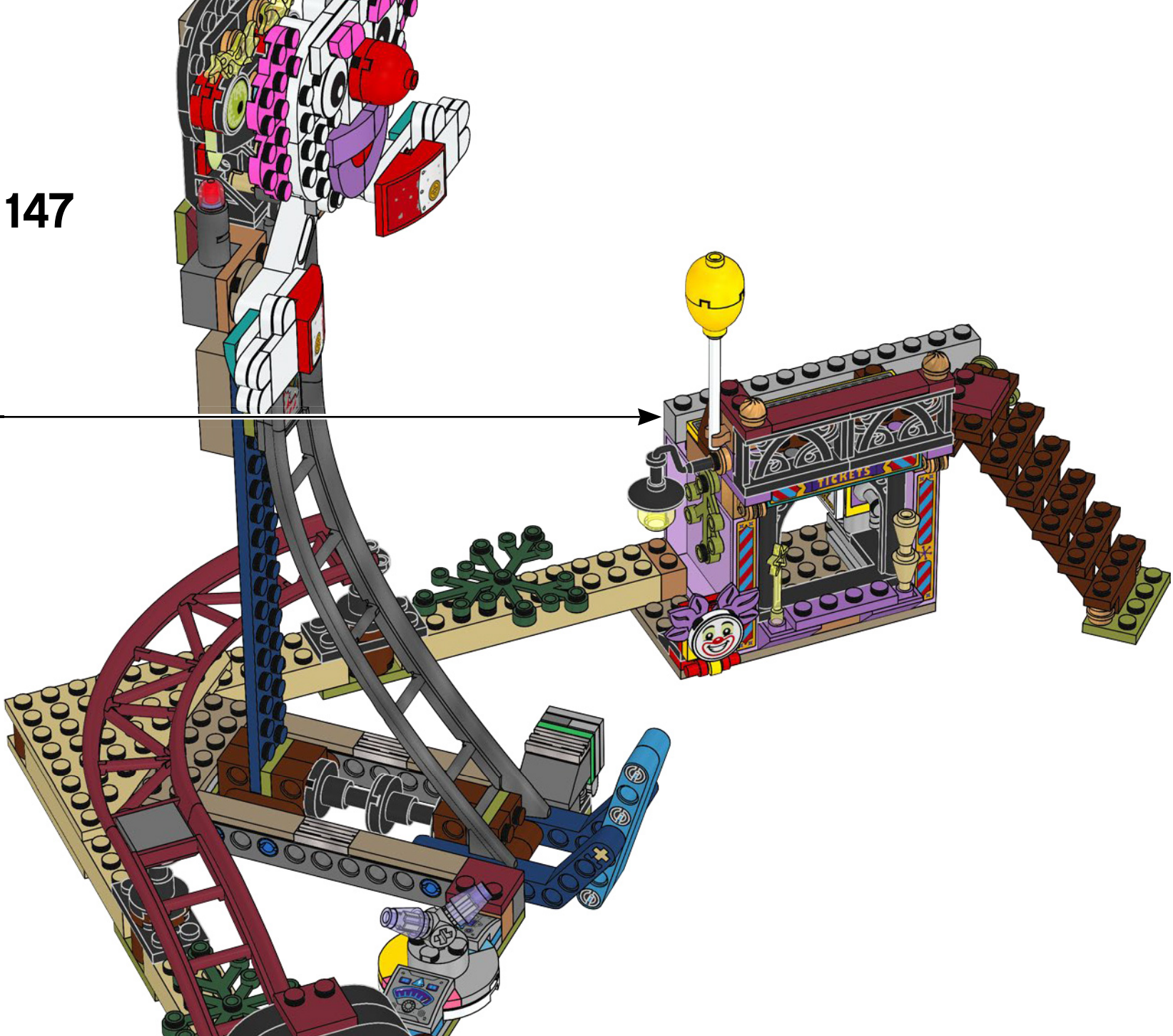

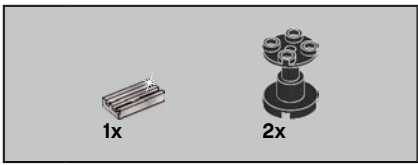

148

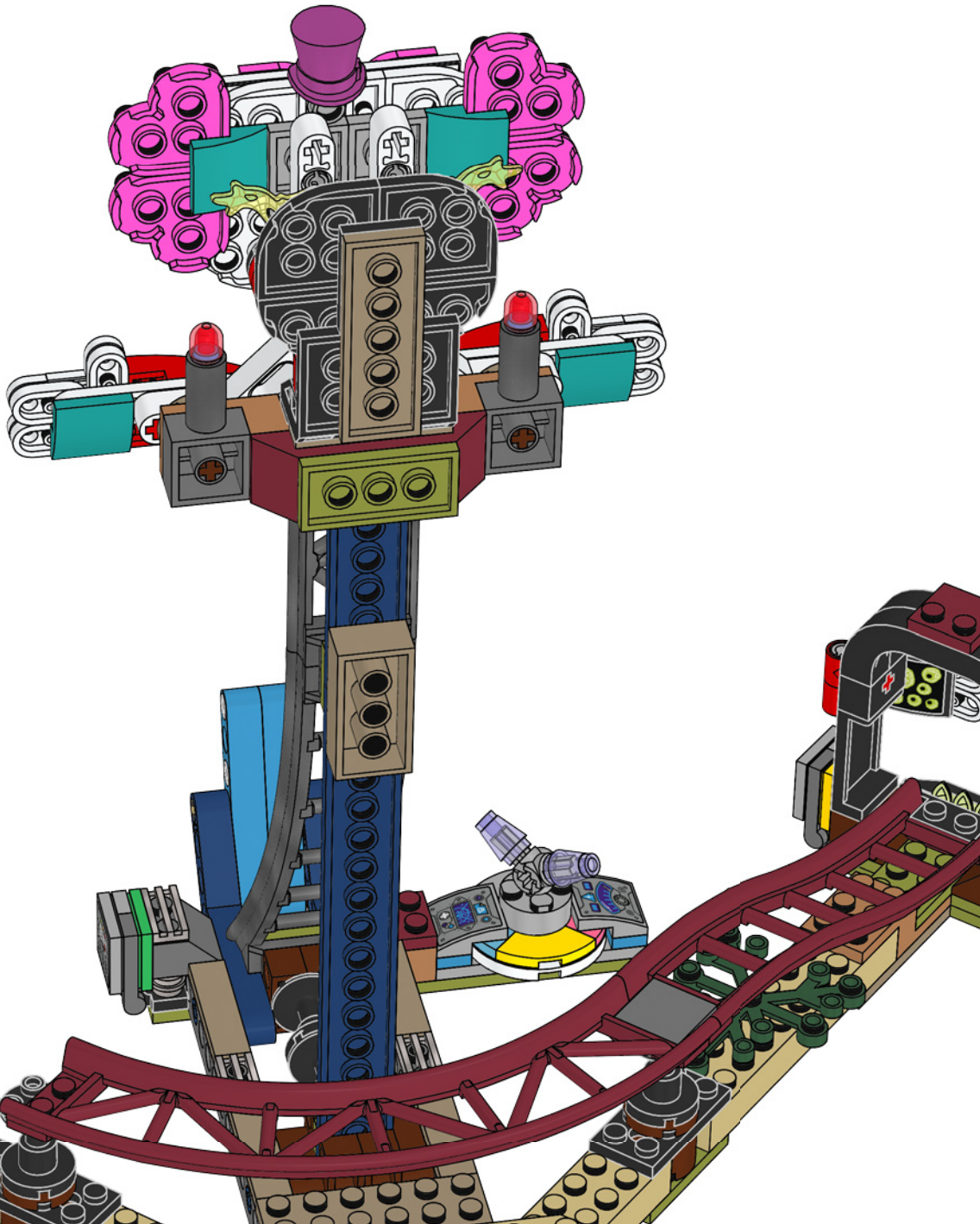
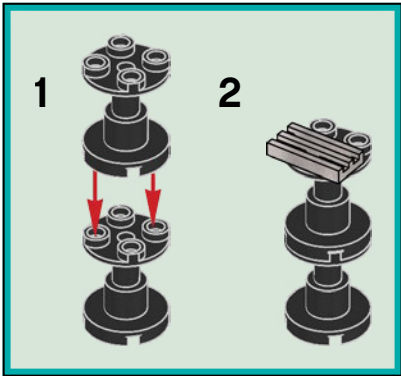

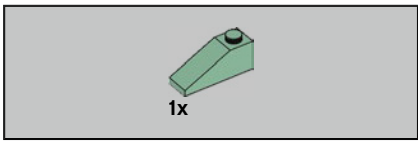

149





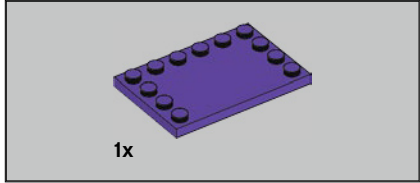

1x

151

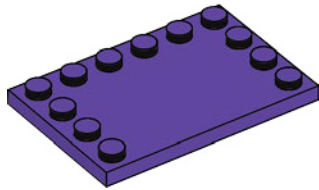

152



153

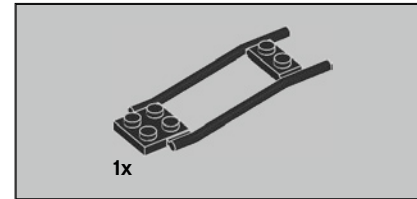

1x

154



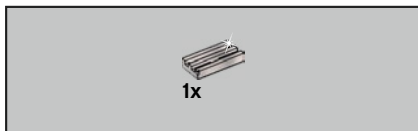

155

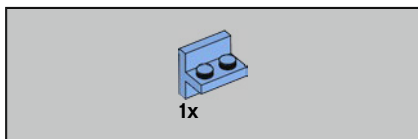

156

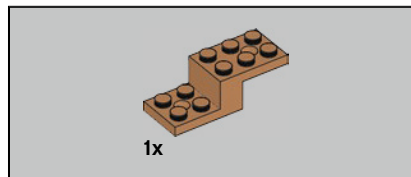
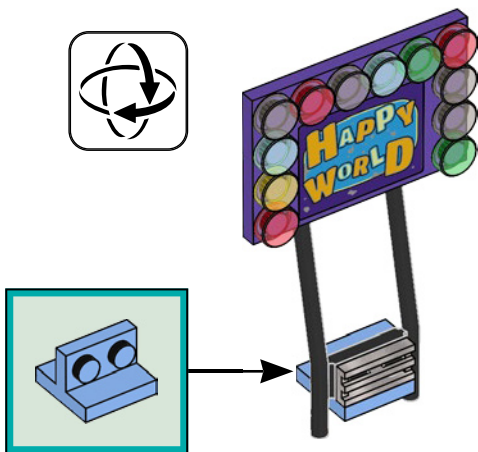

157



158

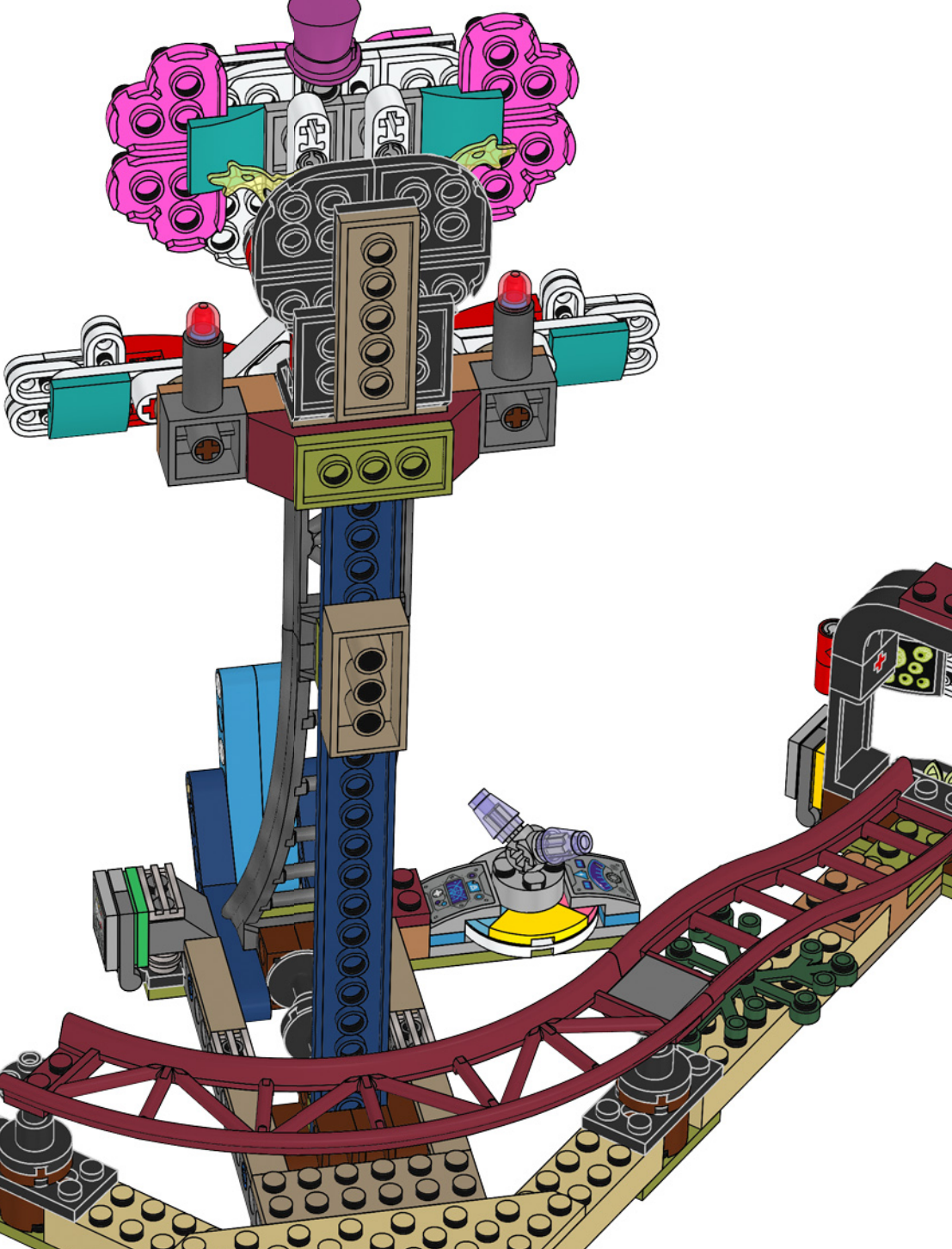
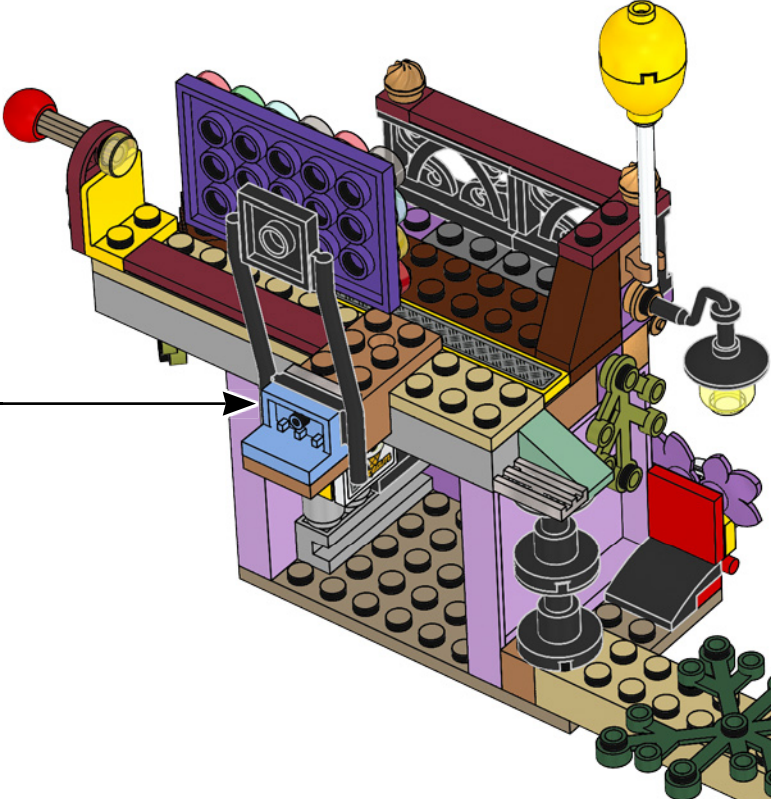

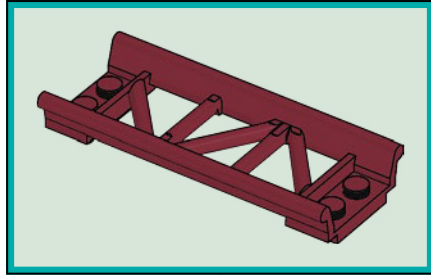
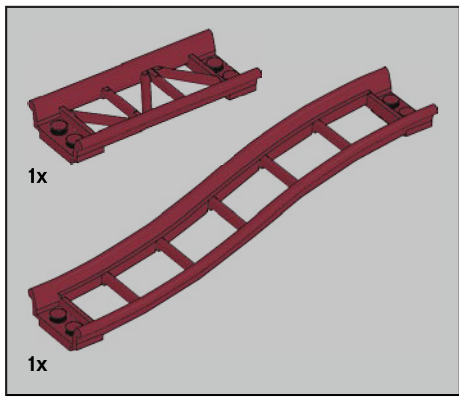

159

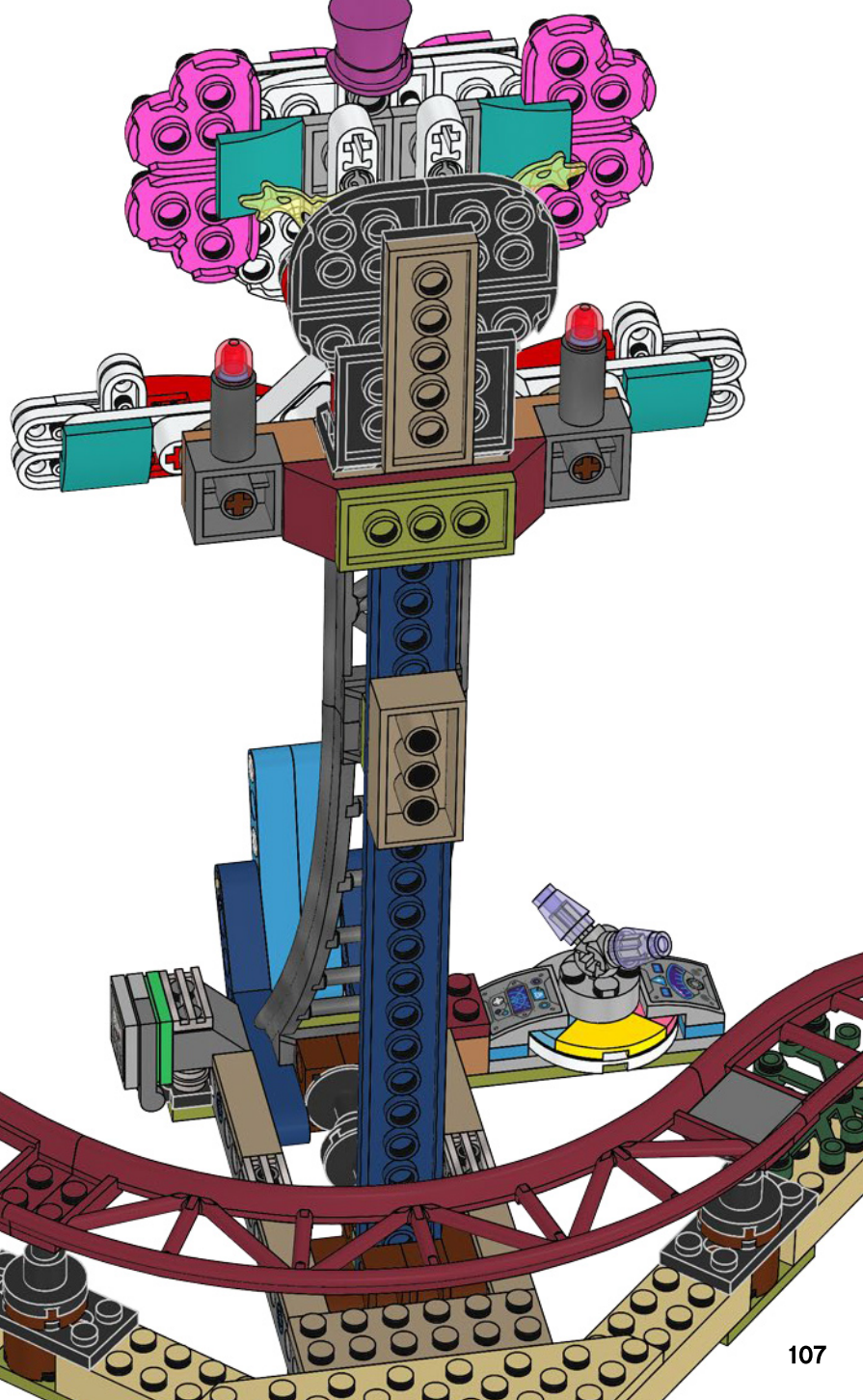
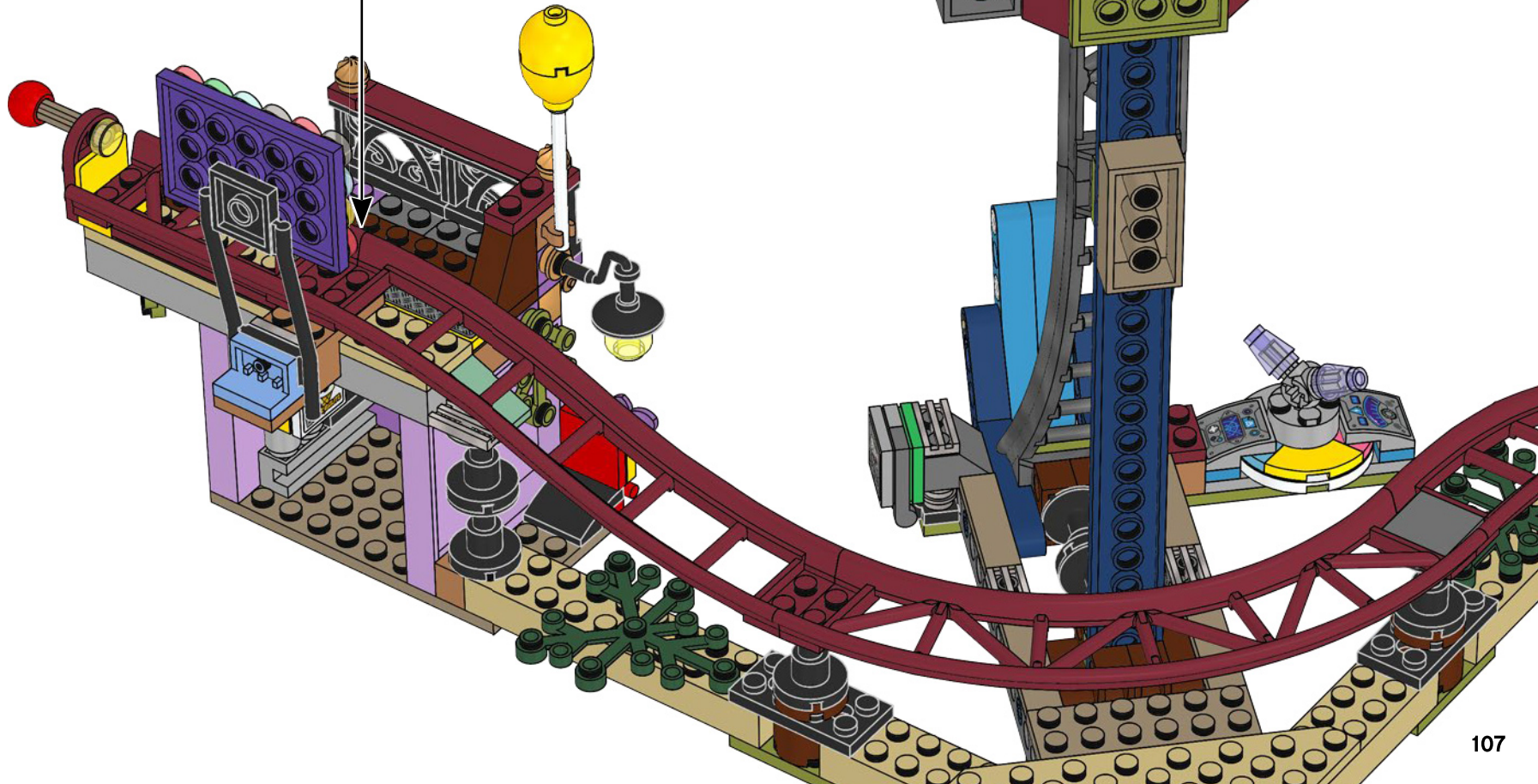

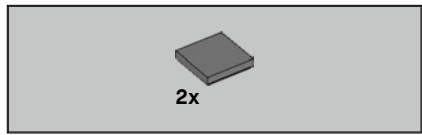

160

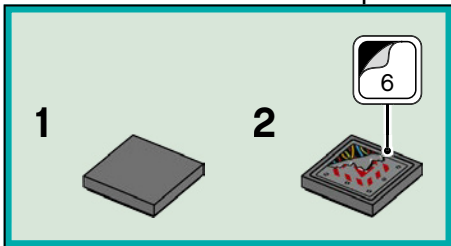
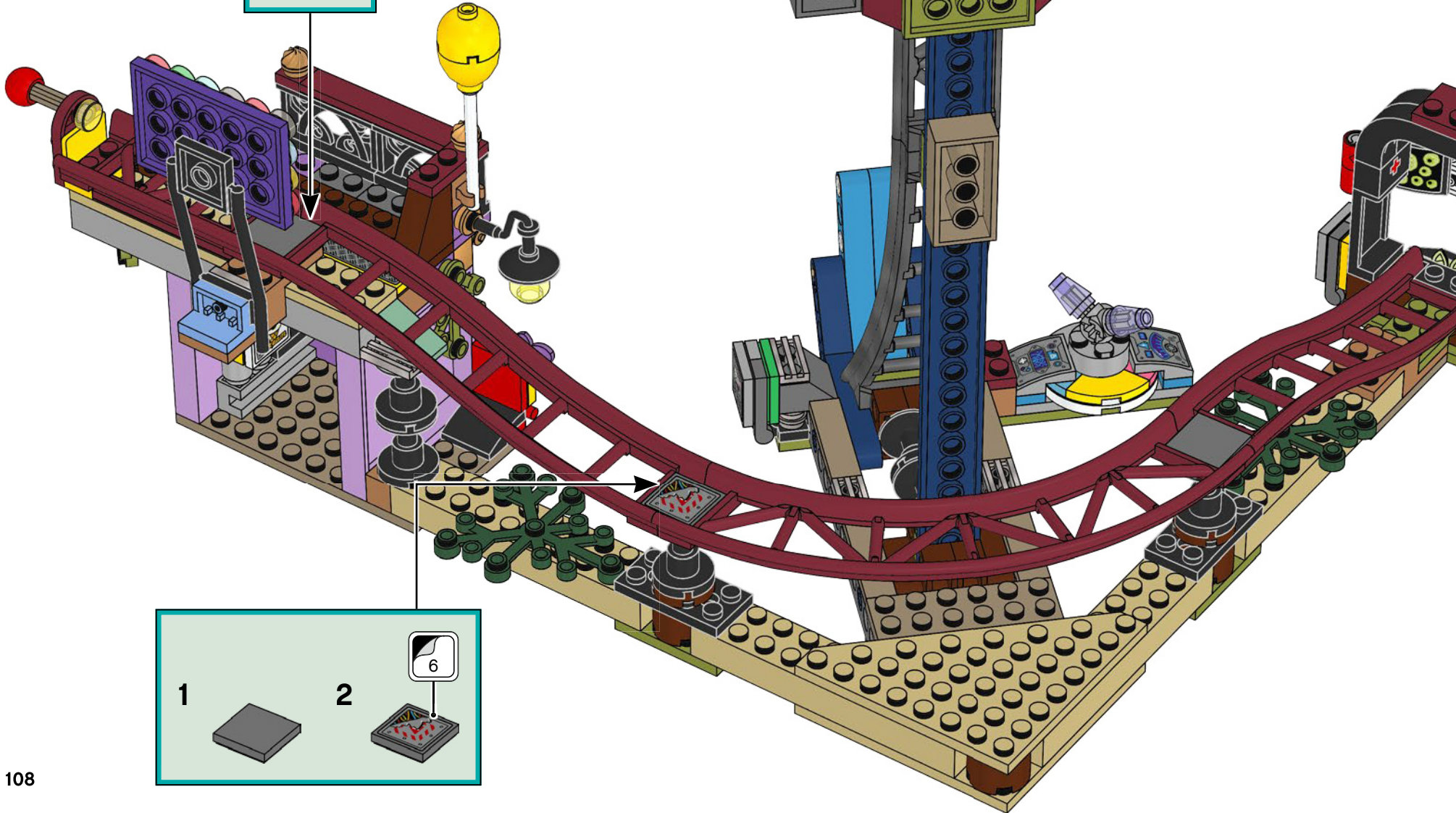
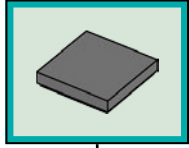

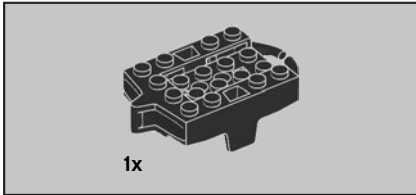
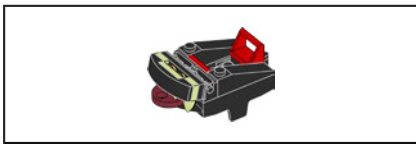

161

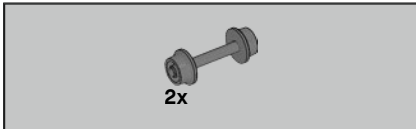
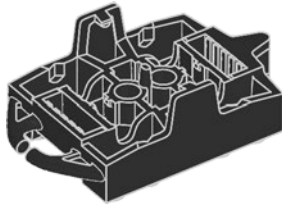

162

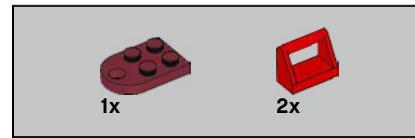
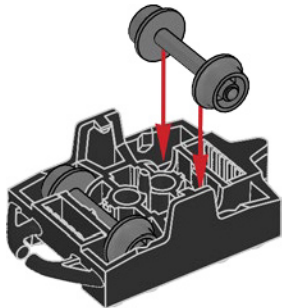

163

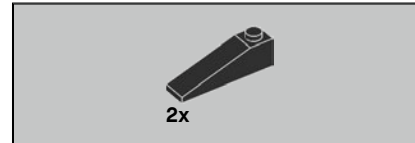
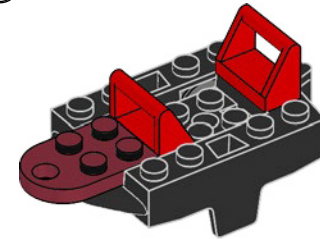

164

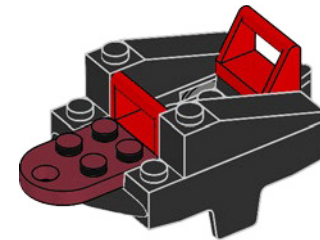



2x

165

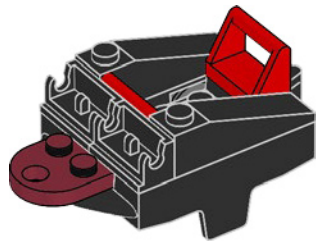

2x



1x



2x



2x

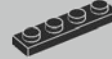

1x



1x

166

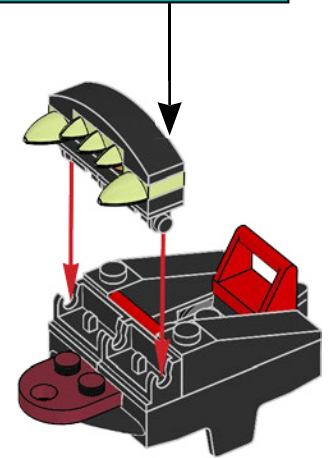
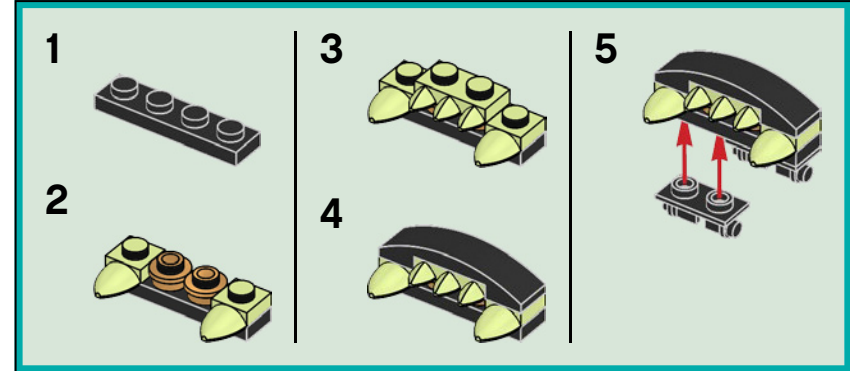

167

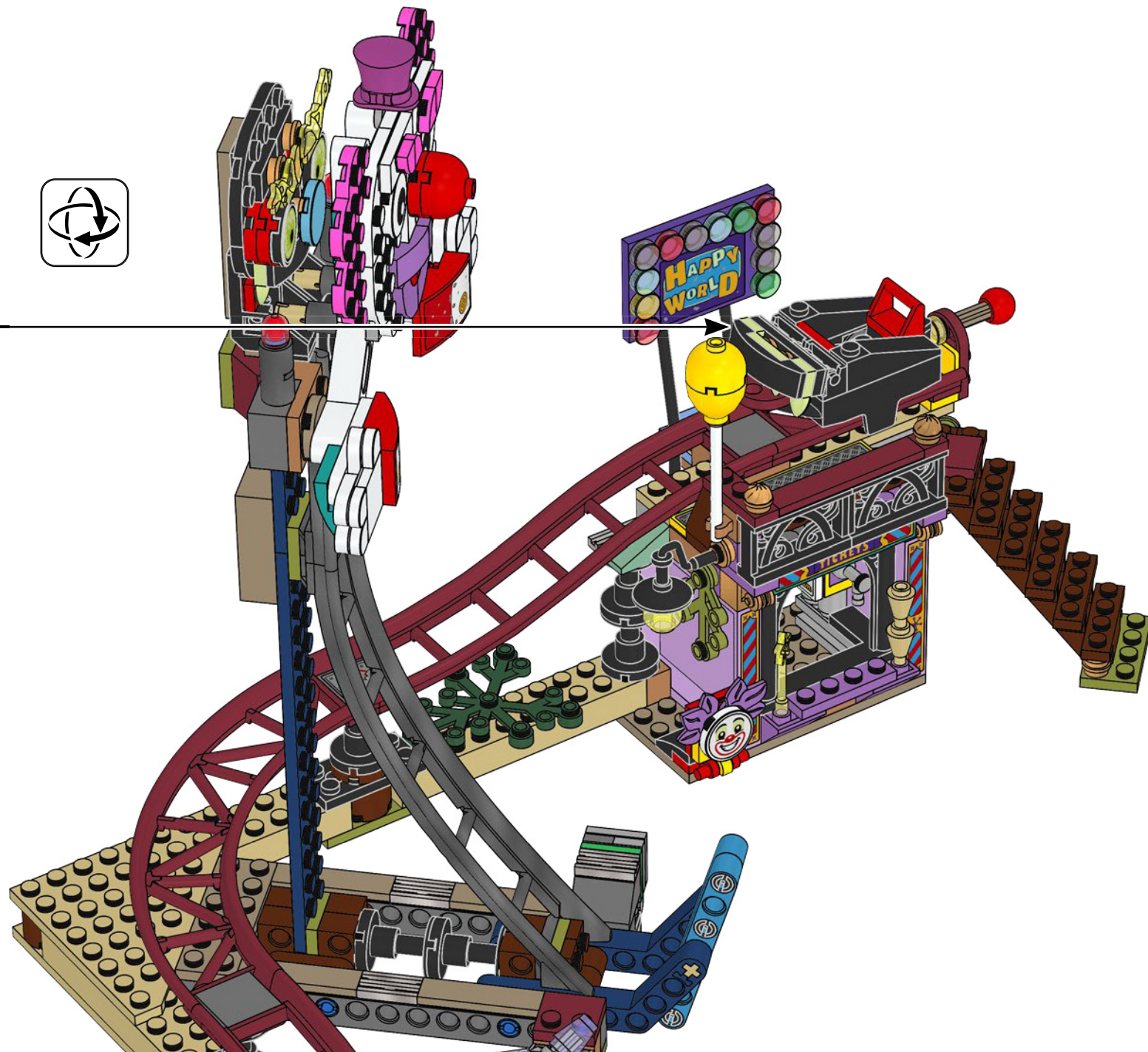

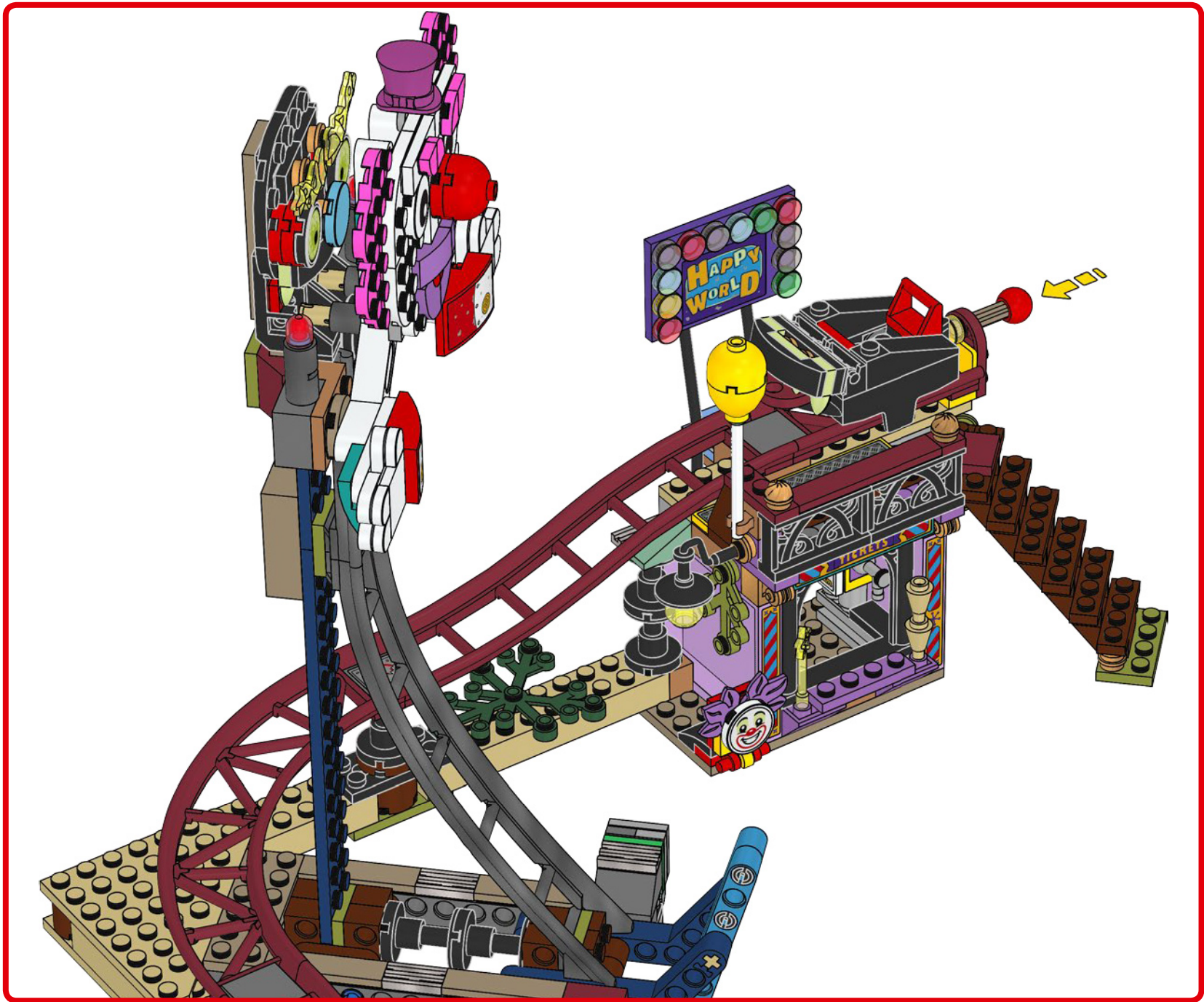

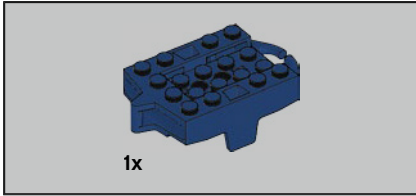
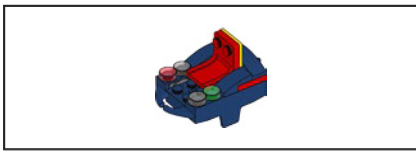

168

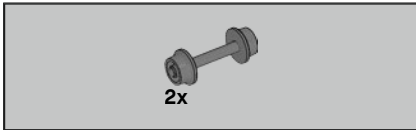
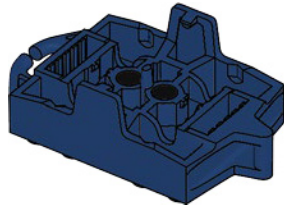

169

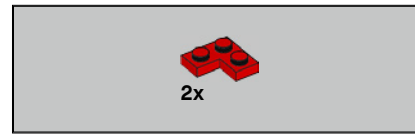
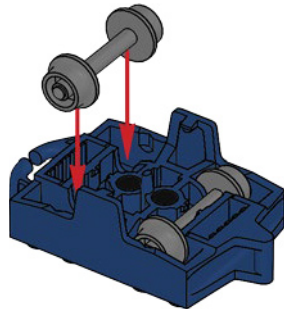

170

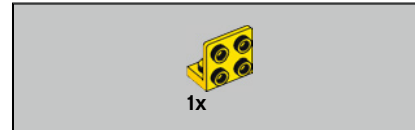
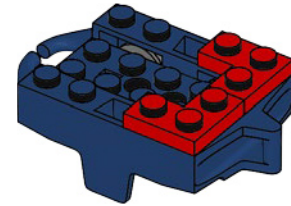
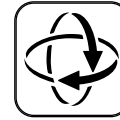

171

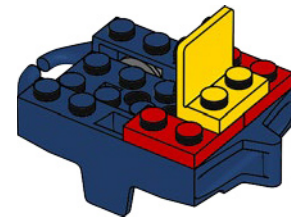

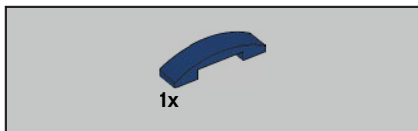

172



173

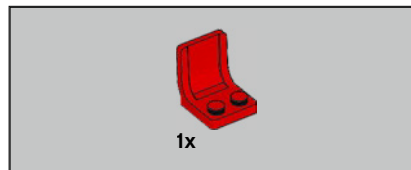
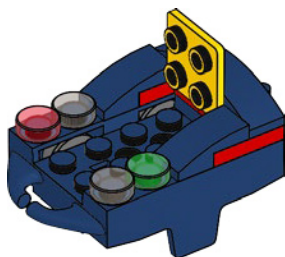

174



175

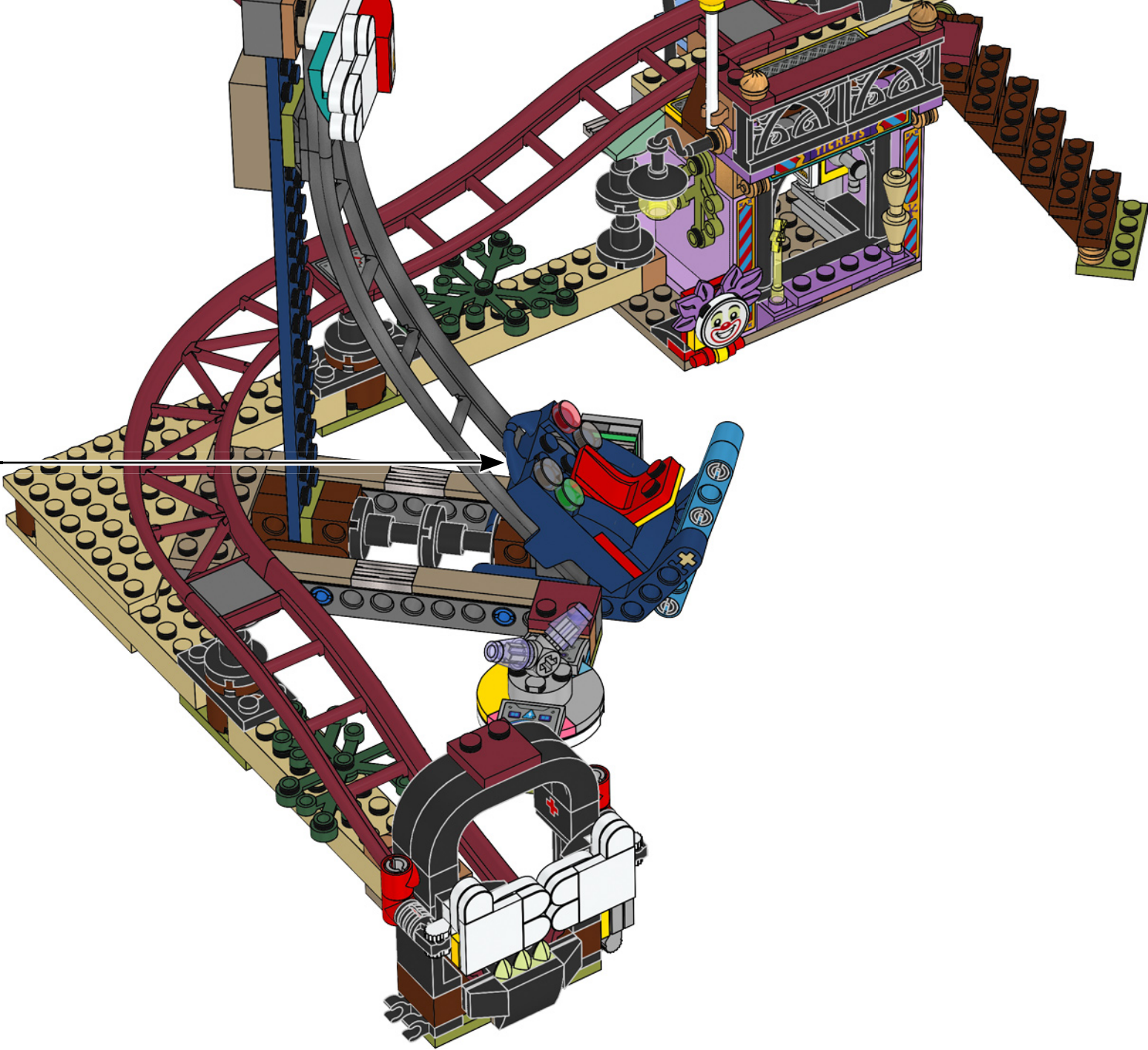

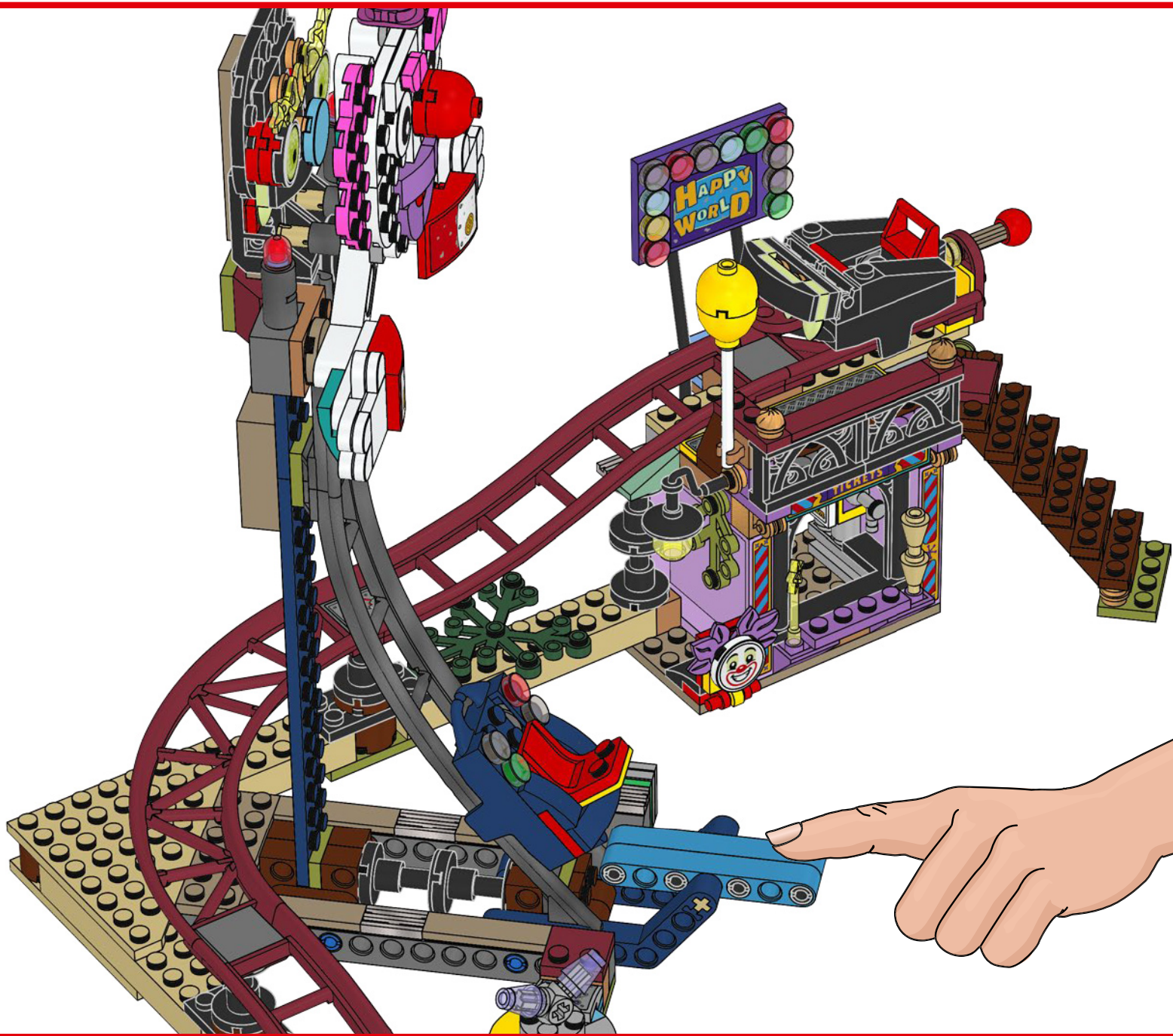

HIDDEN SIDE



70427



70428



70429



70432



70431



70430

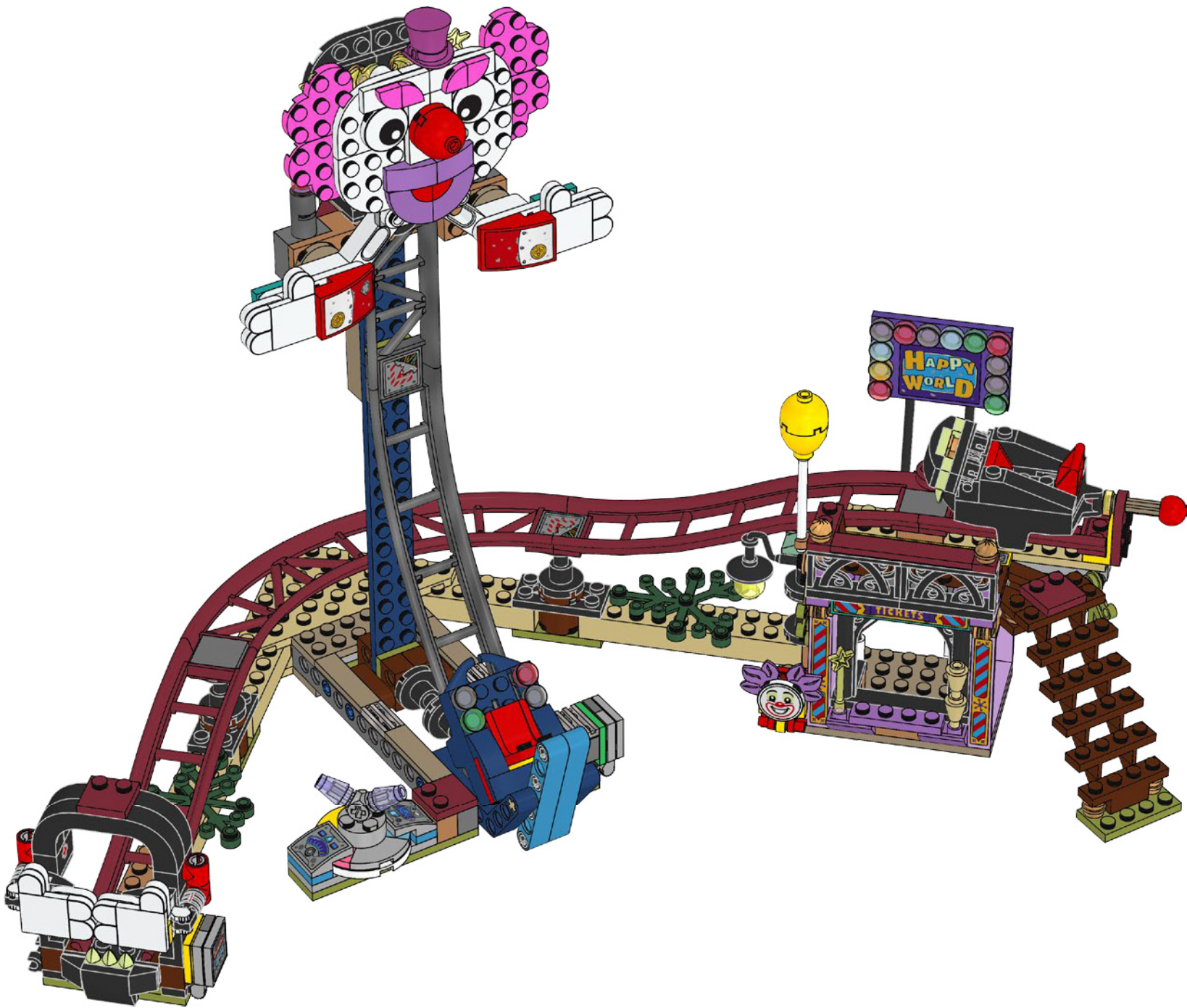



RESEARCH

LEVEL 1

8 / 75

LEVEL 2

SPECIAL ABILITY

SMOKE BOMB

Create a Ghost Cloud that blocks Hunter vision and makes them blind when any ghosts enter it

HEALTH: 950 → 1000

SPEED: 5.5 → 6.75

POWER: 3 → 4.5

LOCOMOTION SPEED: 24 → 30

WALK SPEED: 1.75 → 2.0

WHEEL SPEED: 64 → 72

LEVEL 9

574

COLLECTION

4	3	2	3
2	2	1	3
3	2	2	2
2	3	2	1

Level 2

Level 3

Level 4

Level 5

Level 6

Level 7

Level 8

Level 9

Level 10

Level 11

Level 12

Level 13

Level 14

Level 15

Level 16

Level 17

Level 18

Level 19

Level 20

Level 21

Level 22

Level 23

Level 24

Level 25

Level 26

Level 27

Level 28

Level 29

Level 30

Level 31

Level 32

Level 33

Level 34

Level 35

Level 36

Level 37

Level 38

Level 39

Level 40

Level 41

Level 42

Level 43

Level 44

Level 45

Level 46

Level 47

Level 48

Level 49

Level 50

Level 51

Level 52

Level 53

Level 54

Level 55

Level 56

Level 57

Level 58

Level 59

Level 60

Level 61

Level 62

Level 63

Level 64

Level 65

Level 66

Level 67

Level 68

Level 69

Level 70

Level 71

Level 72

Level 73

Level 74

Level 75

Level 76

Level 77

Level 78

Level 79

Level 80

Level 81

Level 82

Level 83

Level 84

Level 85

Level 86

Level 87

Level 88

Level 89

Level 90

Level 91

Level 92

Level 93

Level 94

Level 95

Level 96

Level 97

Level 98

Level 99

Level 100

RESEARCH

LEVEL 4

8 / 75

LEVEL 5

SPECIAL ABILITY

SMOKE BOMB

Create a Ghost Cloud that blocks Hunter vision and makes them blind when any ghosts enter it

HEALTH: 950 → 1000

SPEED: 5.5 → 6.75

POWER: 3 → 4.5

LOCOMOTION SPEED: 24 → 30

WALK SPEED: 1.75 → 2.0

WHEEL SPEED: 64 → 72

33%

45 / 100

6 / 10

WARRIORS

WORKSHOP

SHOPS

TARGET ESCAPED

GAME OVER

70421



70420



70419



70418



70425



70424



70423



70422



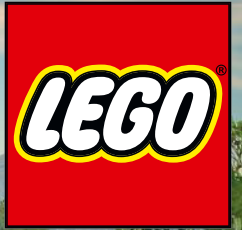

- 1x 6170419
- 1x 6234807
- 12x 6250591
- 1x 6289318
- 1x 6289331
- 14x 6210272
- 1x 6294387
- 1x 6294391
- 1x 6044691
- 2x 6060734
- 1x 6271763
- 2x 4515337
- 5x 306801
- 1x 6238334
- 3x 6195371
- 1x 4558168
- 1x 4515347
- 4x 4550745
- 2x 6280386
- 2x 366601
- 2x 4495412
- 1x 6275386
- 1x 6271761
- 1x 6295084
- 1x 6295080
- 1x 6145255
- 1x 6258069
- 2x 6132790
- 3x 6250168
- 1x 4290714
- 1x 6270152
- 2x 6170390
- 2x 4142865
- 5x 403221
- 1x 4216657
- 1x 6289340
- 4x 6167939
- 8x 302321
- 2x 243221
- 1x 4140585
- 1x 6013868
- 2x 242021
- 1x 407921
- 2x 6132210
- 1x 243121
- 1x 6271742
- 1x 6275429
- 1x 6289281
- 1x 6289314
- 1x 6271729
- 4x 302424
- 1x 6145704
- 1x 4216656
- 1x 6179329
- 3x 6208753
- 1x 306824
- 1x 6275508
- 2x 6130007
- 1x 4189400
- 2x 4504382
- 2x 6192778
- 2x 4158848
- 3x 6070695
- 6x 6106280
- 1x 474026
- 4x 4121715
- 1x 6271189
- 2x 4614788
- 1x 6271133
- 3x 6092585
- 2x 393826
- 2x 6178922
- 2x 393726
- 3x 6310268
- 2x 6211476
- 2x 6053077
- 2x 6168620
- 2x 302126
- 2x 4613153
- 2x 371026
- 2x 4515362
- 2x 6138726
- 2x 6021678
- 2x 4227392
- 2x 370926
- 1x 6105963
- 2x 6132770
- 1x 6203523
- 1x 6294677
- 1x 6284697
- 2x 6211928
- 2x 4653988
- 1x 4107762
- 1x 6295081
- 1x 6289334
- 1x 6275081
- 1x 6253657
- 1x 6031821
- 4x 6175927
- 1x 4247145
- 4x 4550329
- 1x 6096215
- 2x 6094143
- 1x 6037886
- 1x 6233695
- 2x 6279908
- 1x 6027627
- 1x 6120642
- 1x 6271130
- 4x 4143005
- 8x 4514553
- 1x 6295114
- 4x 6222950
- 1x 6264986
- 2x 6017003
- 2x 4666579
- 2x 4514554
- 1x 6294678
- 1x 6093864
- 2x 4626948

4x 4633691
 6x 4619636
 2x 6236395
 2x 6245501
 2x 6050916
 12x 6190252
 2x 6112307
 2x 4569385
 4x 4569382
 4x 6175943
 1x 6237878
 4x 6240462
 4x 6254513
 2x 6294375

4x 4211412
 1x 4211503
 2x 6227897
 1x 4211526
 2x 4211807
 1x 4502595
 2x 6132886
 2x 6212077
 6x 6276848
 2x 6102357
 1x 6163990
 2x 4211804
 1x 4211613
 3x 4211445
 1x 4211522

2x 4211159
 3x 4211166
 6x 6151461
 1x 4629736
 2x 6138664
 2x 4211202
 2x 6135494
 2x 6121726
 4x 6084573
 1x 4277751
 1x 4211211
 1x 6240515

1x 4598531
 2x 6294358
 1x 6294360
 1x 6294361
 1x 6287321
 2x 4211137
 1x 6313372
 4x 6267420
 3x 6267421
 2x 6266967

1x 4539114
 3x 6214309
 1x 4539076
 2x 4568753
 2x 4650865
 1x 6175590
 1x 6294376
 2x 4521187
 4x 4211055
 1x 6063616
 2x 6214341
 4x 6135290
 1x 4211054
 2x 4211046

2x 6171762
 4x 6258607
 6x 6079000
 2x 6274740
 2x 6274739
 3x 6274742
 2x 4567340
 1x 6245511
 1x 6168672
 1x 6289322
 1x 6289316
 1x 6299272
 1x 6275078
 1x 6250024

3x 6125776
 2x 6210460
 1x 6286505
 1x 6279104
 2x 6136331
 2x 6199900
 2x 4619517
 2x 6223452
 1x 4619524
 2x 6249322



Customer Service
 Kundenservice
 Service Consommateurs
 Servicio Al Consumidor
 LEGO.com/service or dial

: 00800 5346 5555
 : 1-800-422-5346

WIN

GO TO WWW.LEGO.COM/PRODUCTFEEDBACK AND
GIVE US YOUR SHORT **FEEDBACK** ABOUT THIS
LEGO® SET FOR A CHANCE TO WIN
A COOL LEGO PRIZE.

Terms & Conditions apply

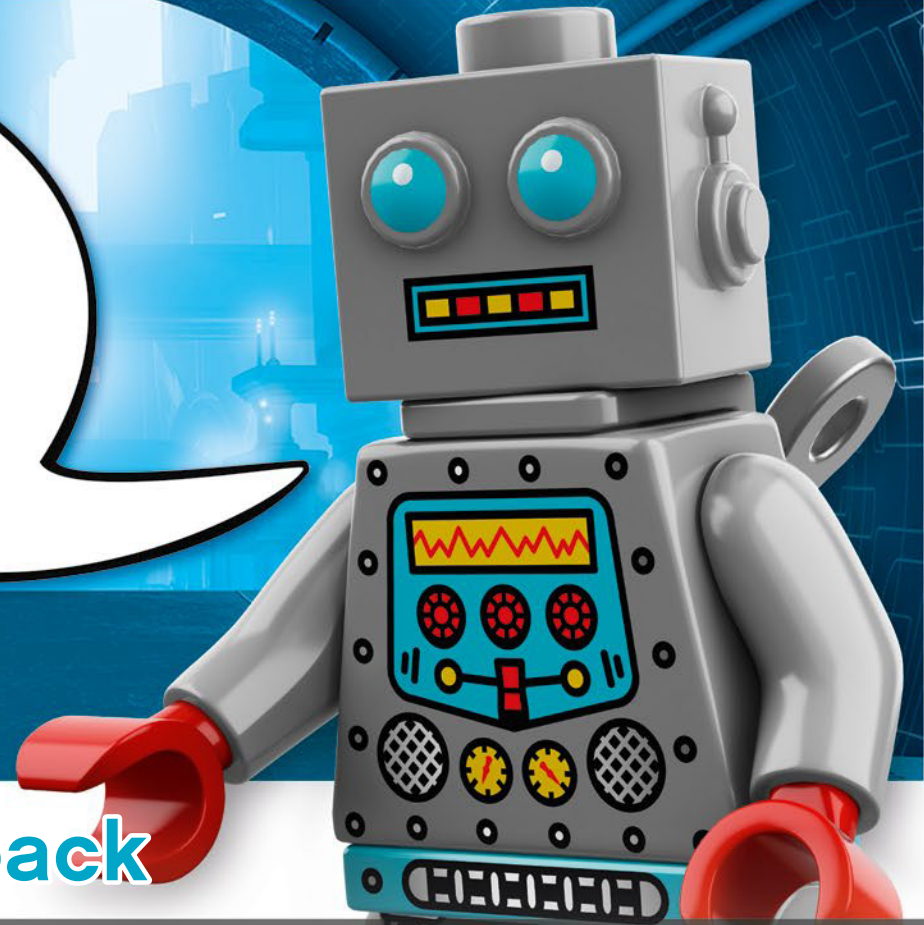

LEGO.com/productfeedback

GEWINNE

Erzähle uns auf
www.LEGO.com/productfeedback

etwas über die Erfahrungen, die
du mit diesem LEGO® Set gemacht
hast, und sichere dir die Chance
auf einen coolen LEGO Preis!

Es gelten die
Teilnahmebedingungen

GAGNE

Rends-toi sur
www.LEGO.com/productfeedback

et donne-nous quelques com-
mentaires sur ce produit LEGO®
pour avoir une chance de gagner
un prix LEGO !

Voir Conditions Générales

GANAN

Visita
www.LEGO.com/productfeedback

y envíanos tu opinión acerca de
este set LEGO®. ¡Participarás en el
sorteo de un premio LEGO!

Términos y Condiciones aplicables

获取奖品

登录
www.LEGO.com/productfeedback

给出关于此乐高®套装的简短反馈，
就有机会获得炫酷乐高奖品

《条款及条件》适用

경품 당첨 기회

www.LEGO.com/productfeedback

페이지로 이동하여 이 레고® 세트에
대한 간략한 피드백을 보내 주시고
멋진 레고 경품을 탈 수 있는 기회도
잡으십시오

약관 적용

ЗАПОЛНИ АНКЕТУ И ПОЛУЧИ ПРИЗ

Перейди по ссылке
www.LEGO.com/productfeedback

ответь всего на несколько во-
просов об этом наборе LEGO®,
и у тебя появится шанс выиграть
замечательный приз от компании
LEGO.

Применяются Условия и правила
участия