



CREATOR

6754







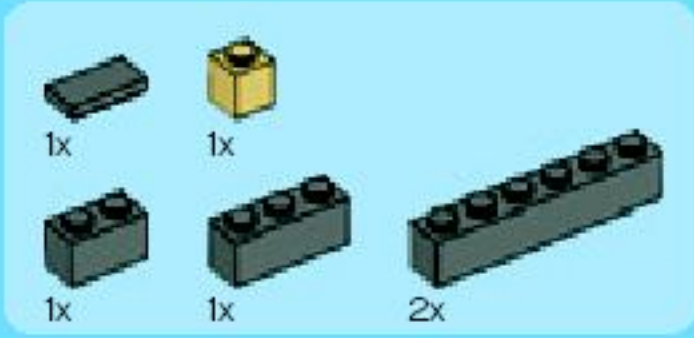

1

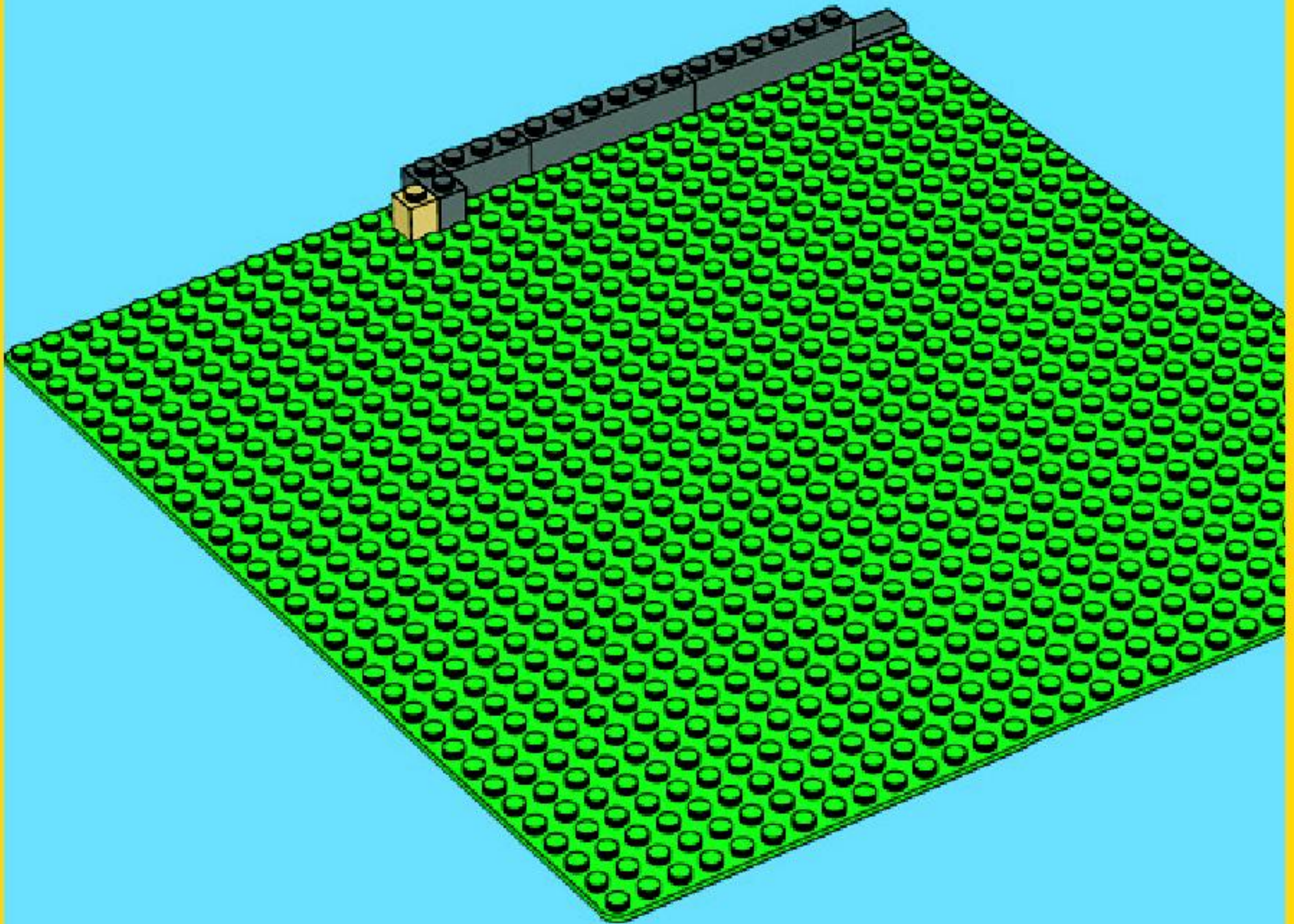

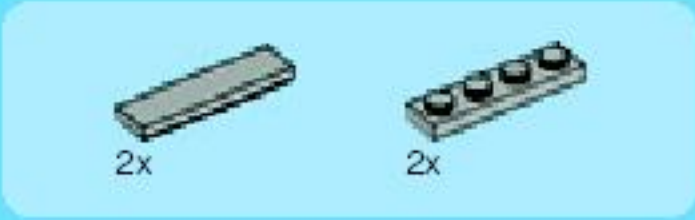

2

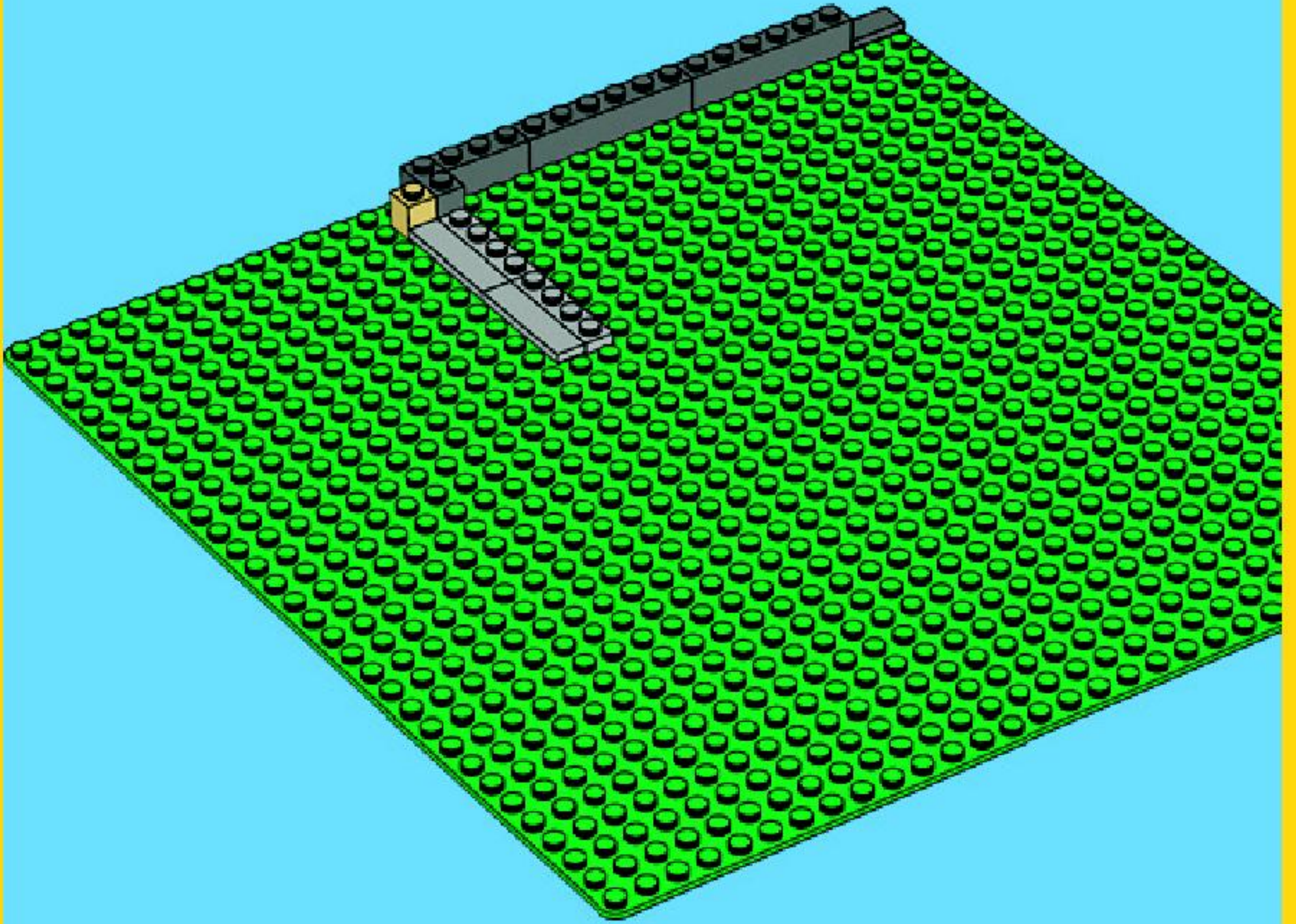

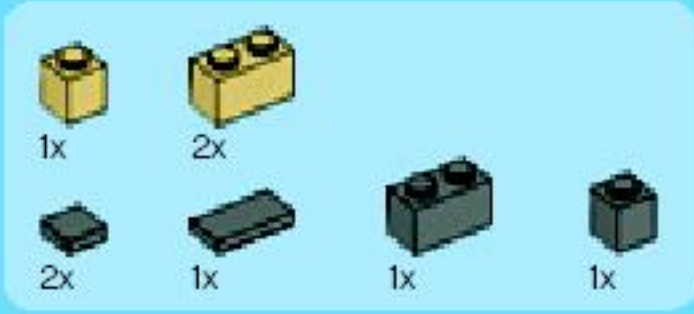

3

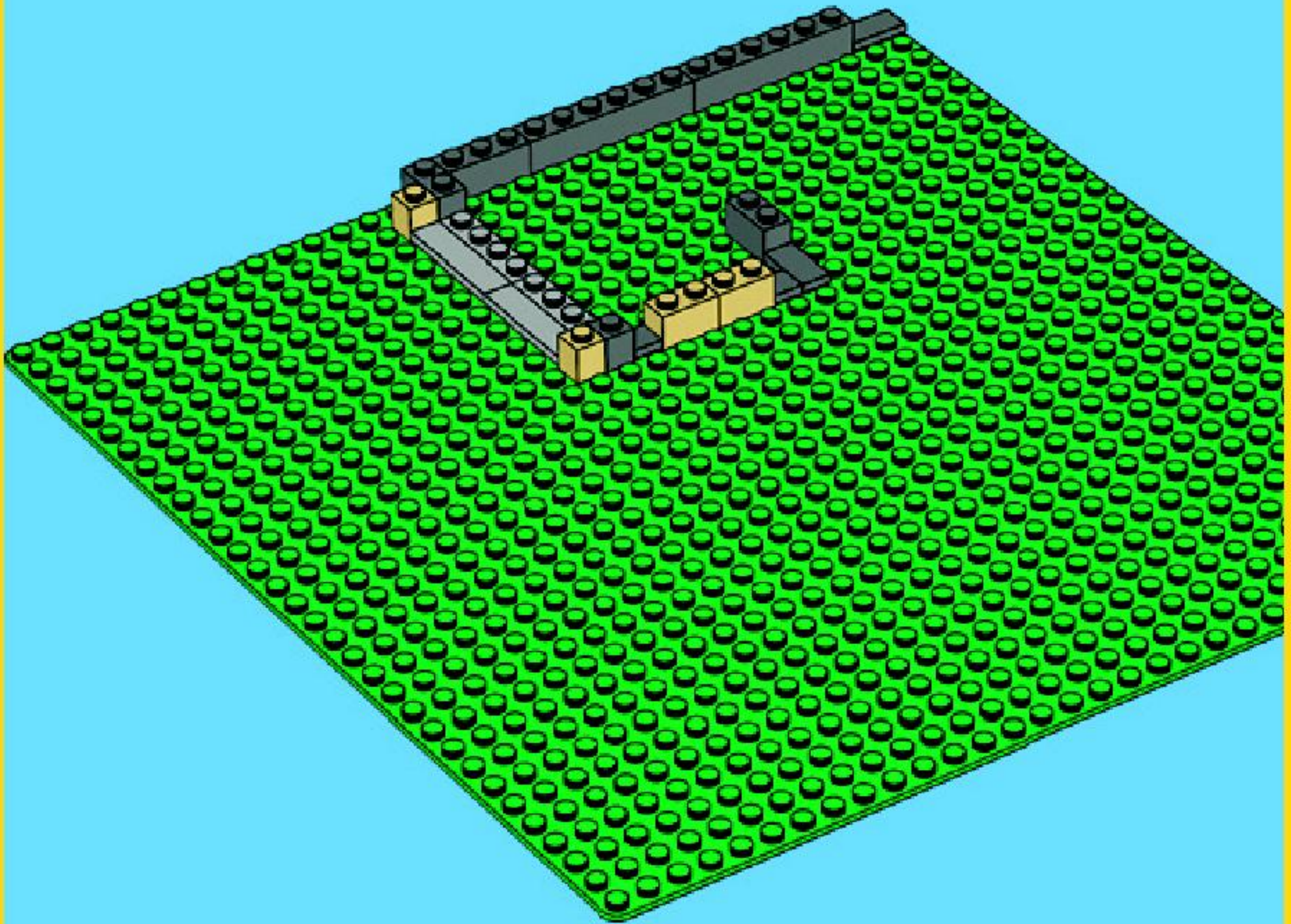

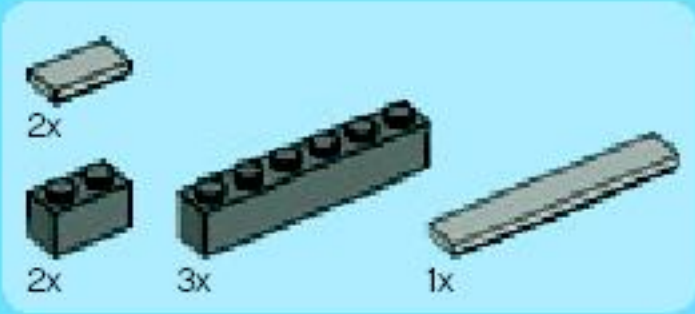

4

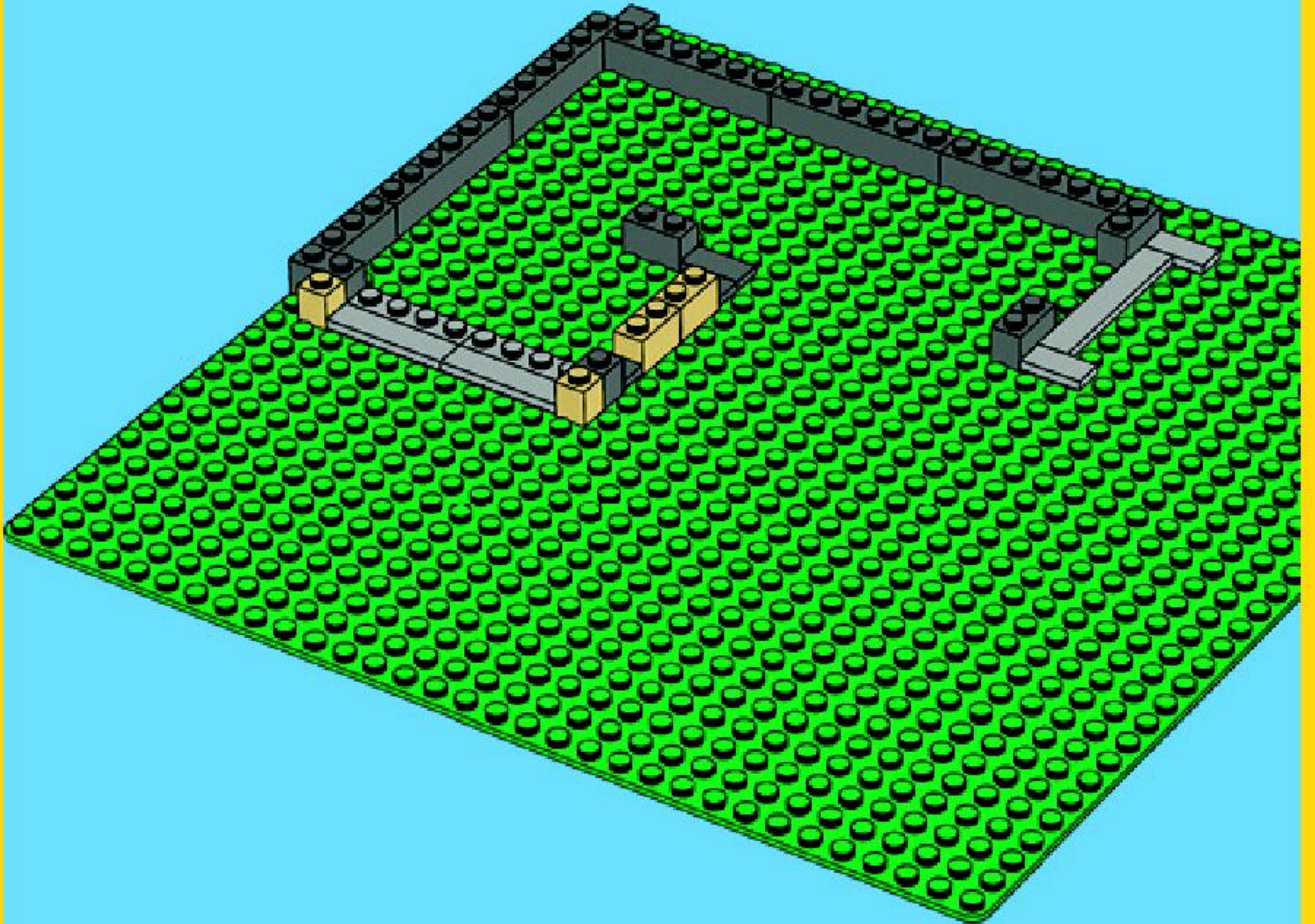

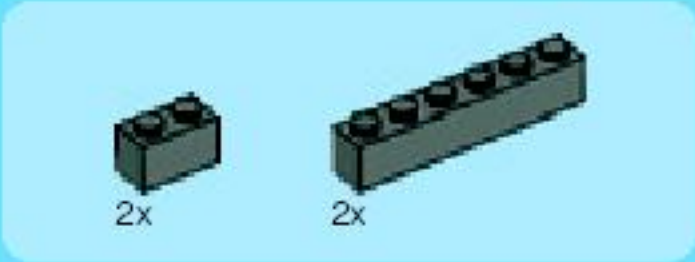

6

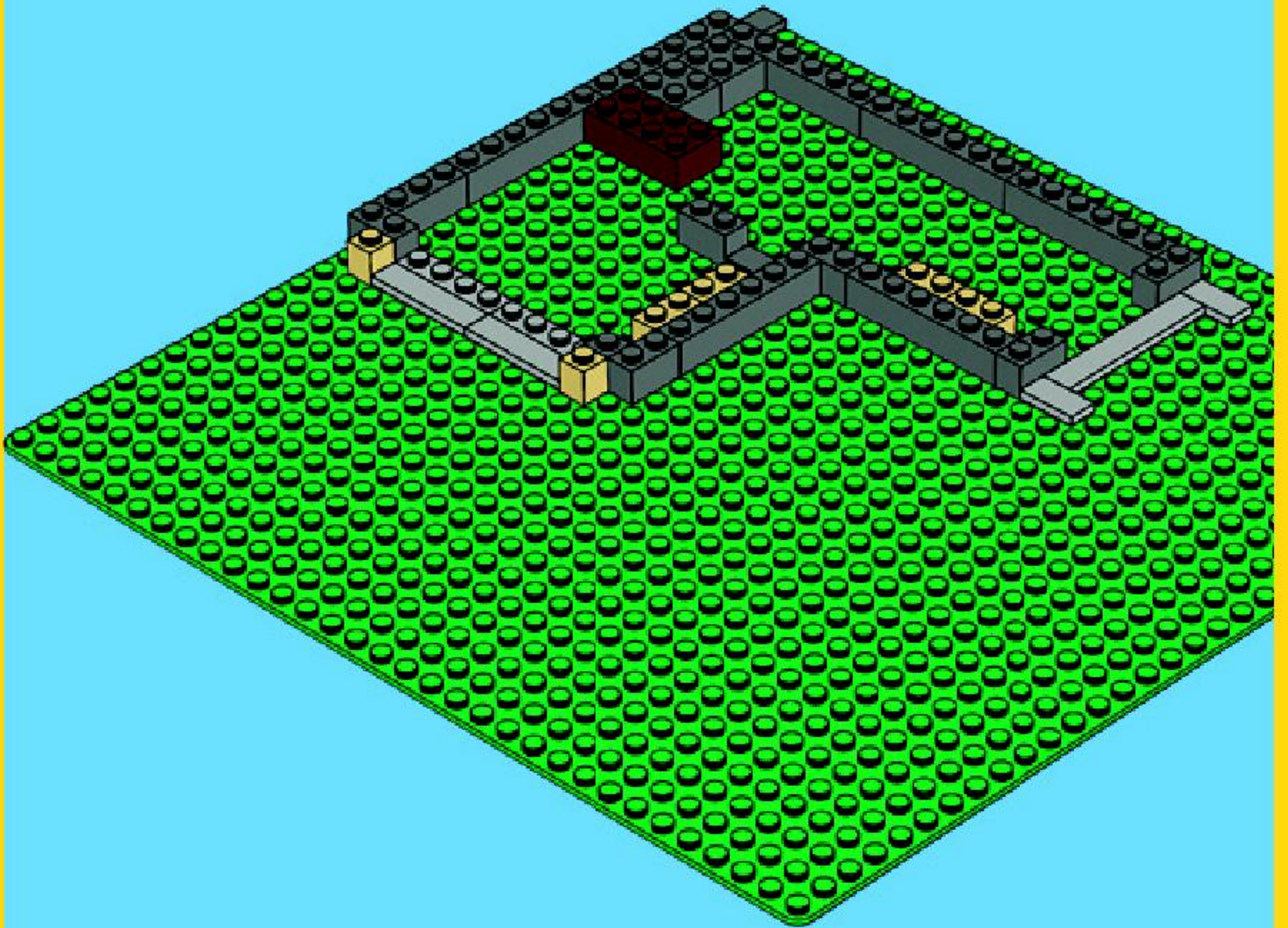

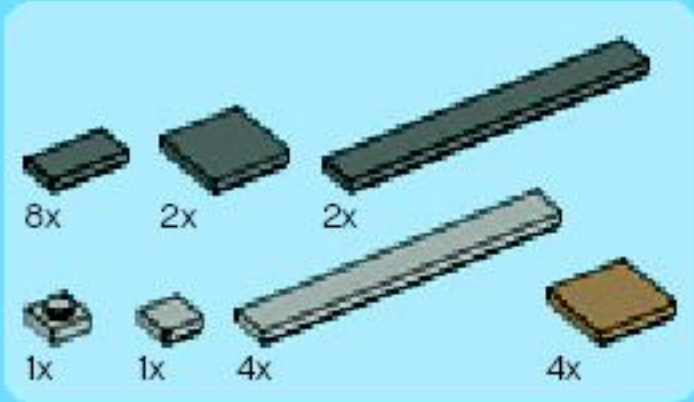

7

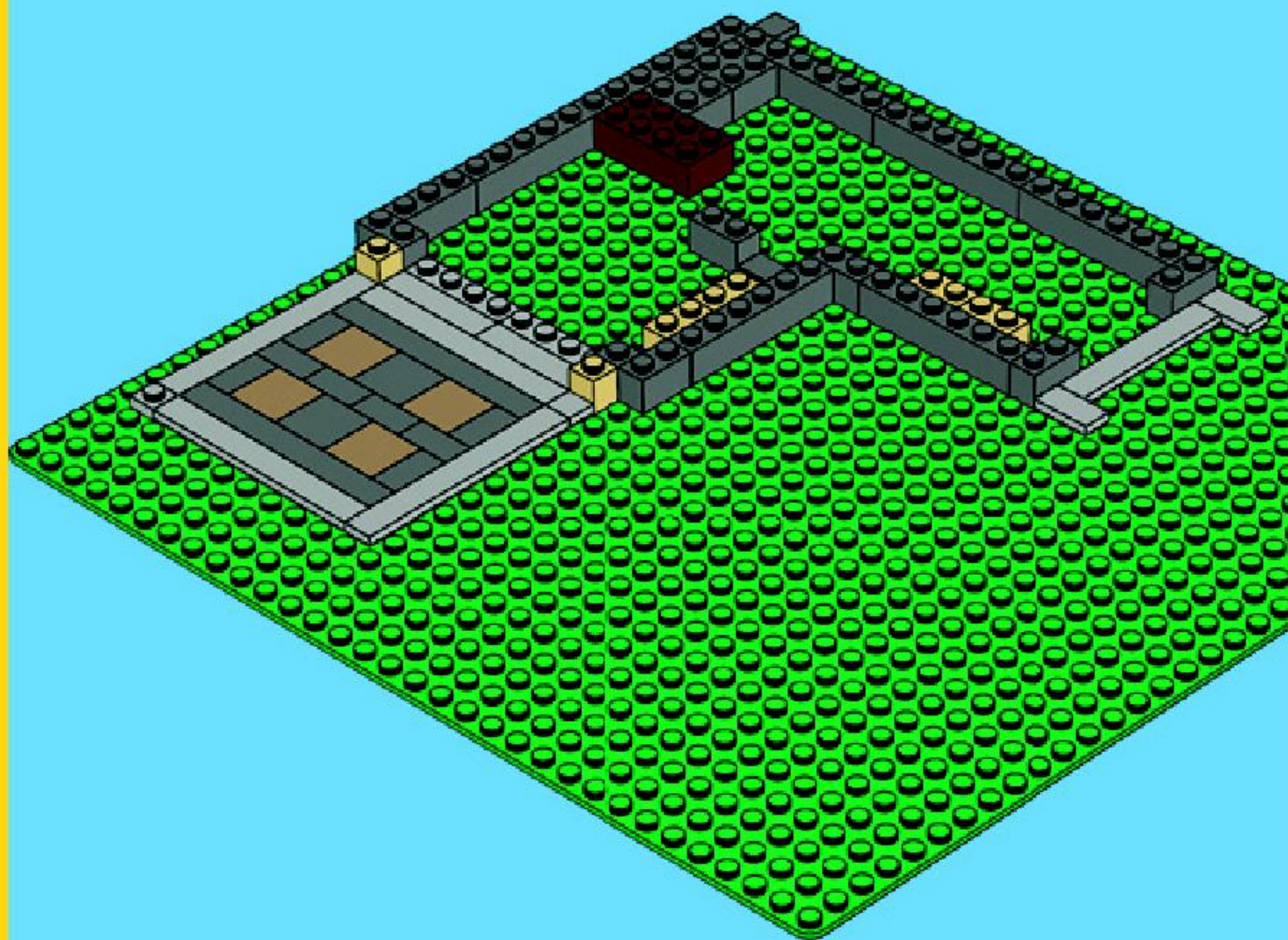



8

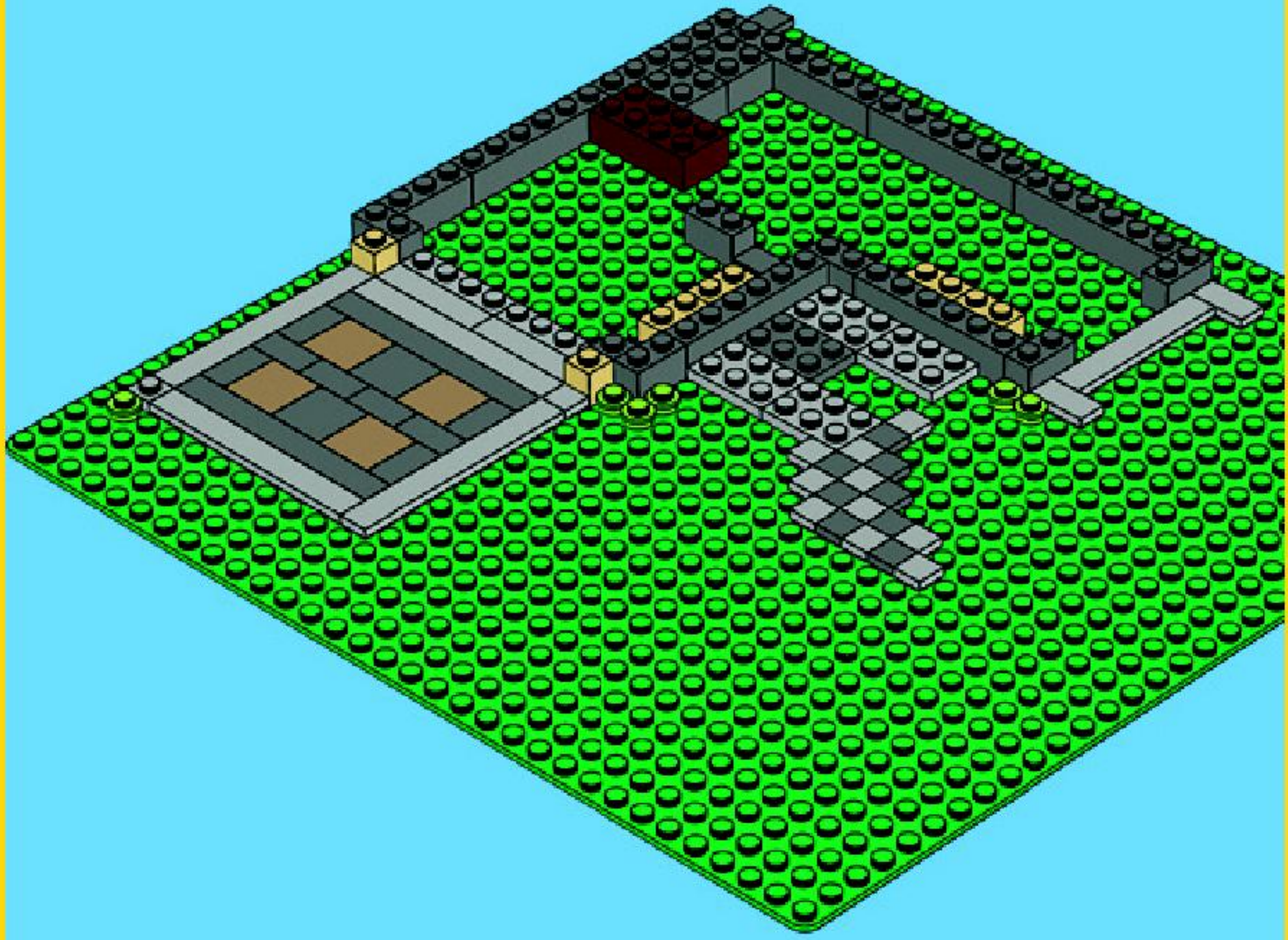



9

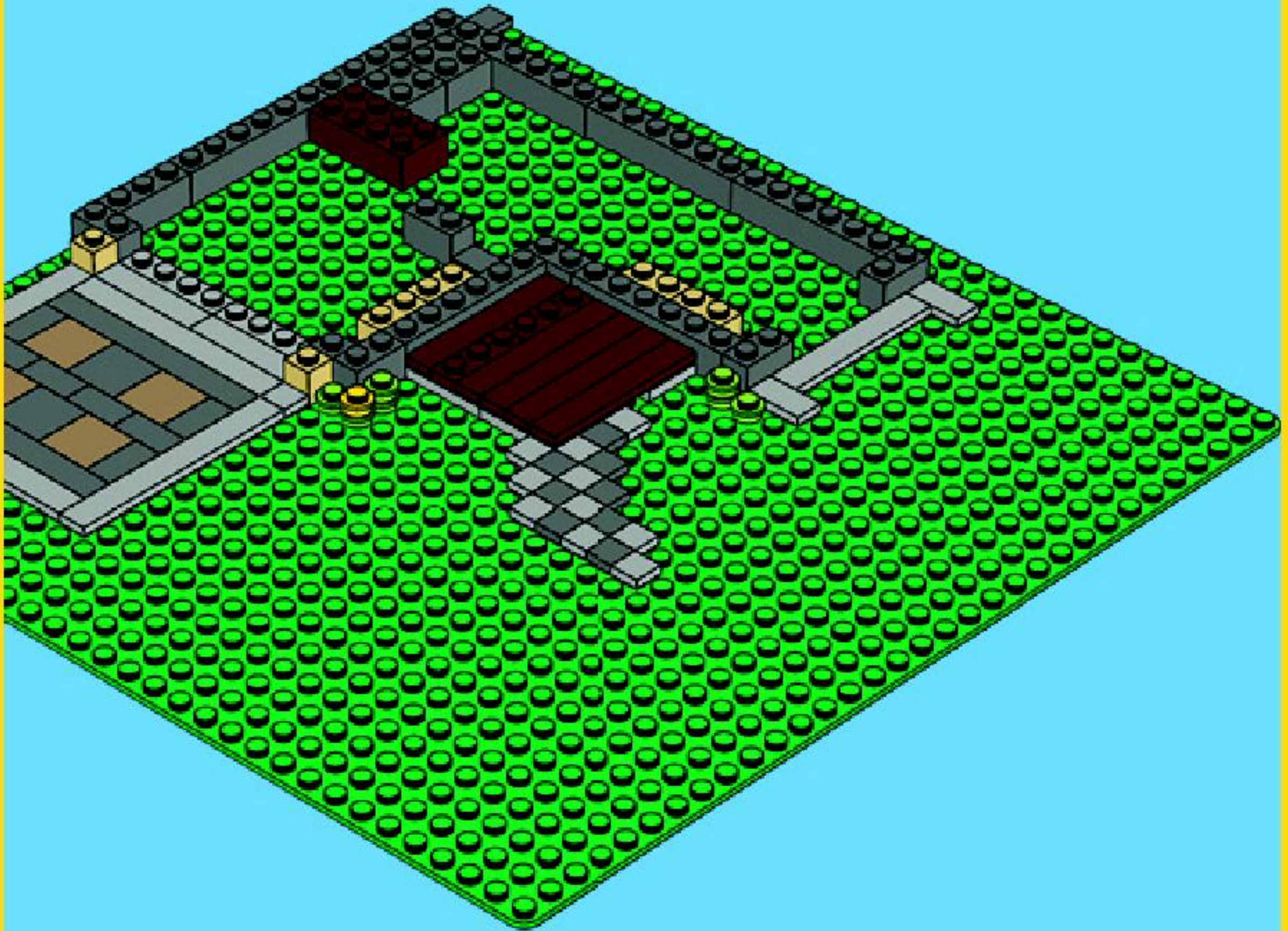



1x



9x



3x



12x

10

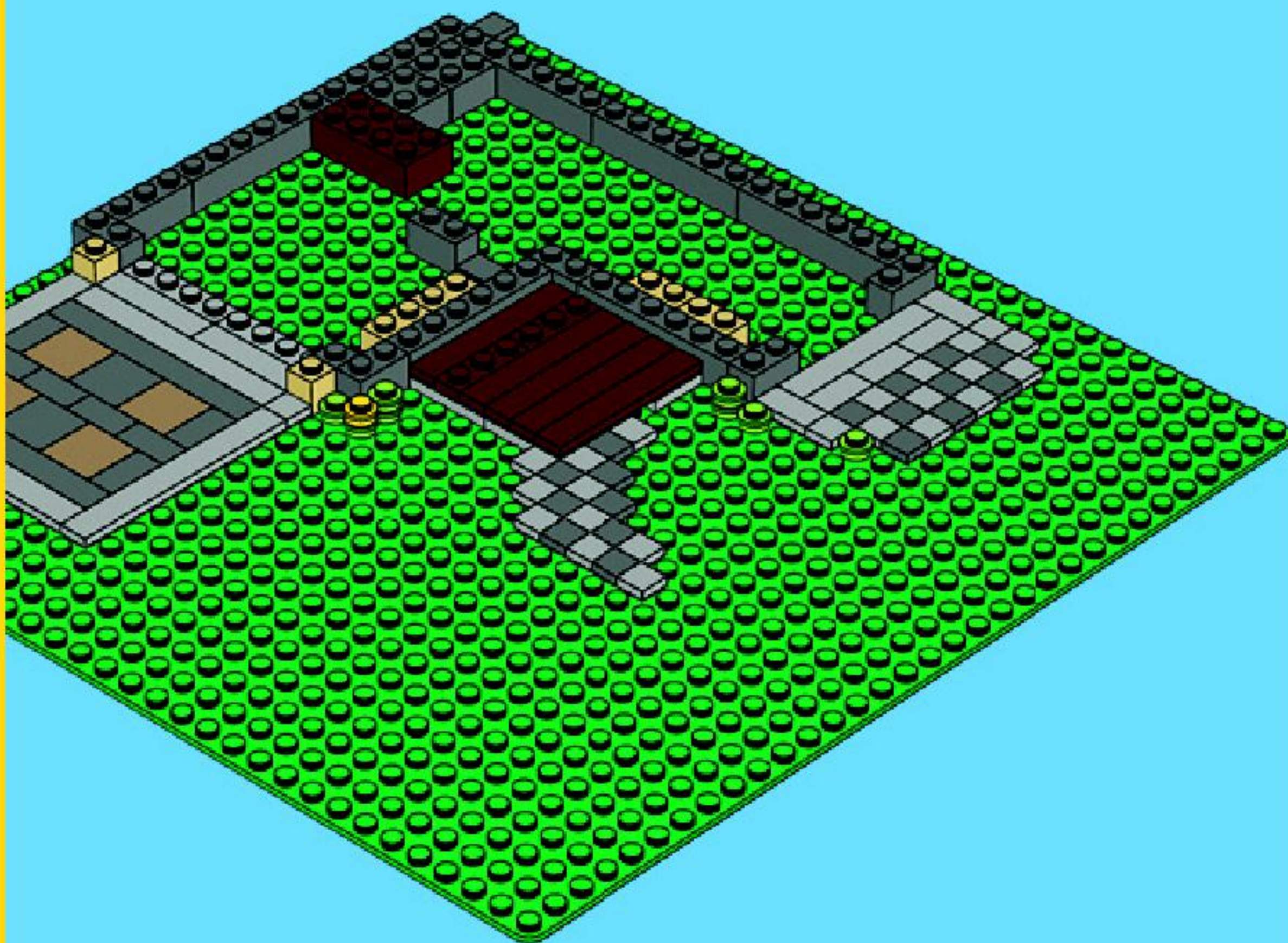

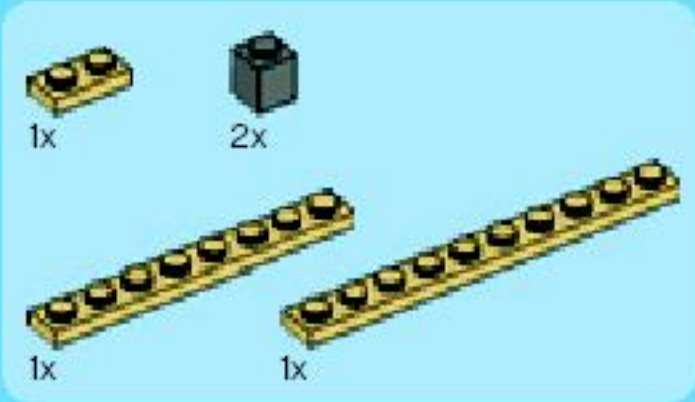

12

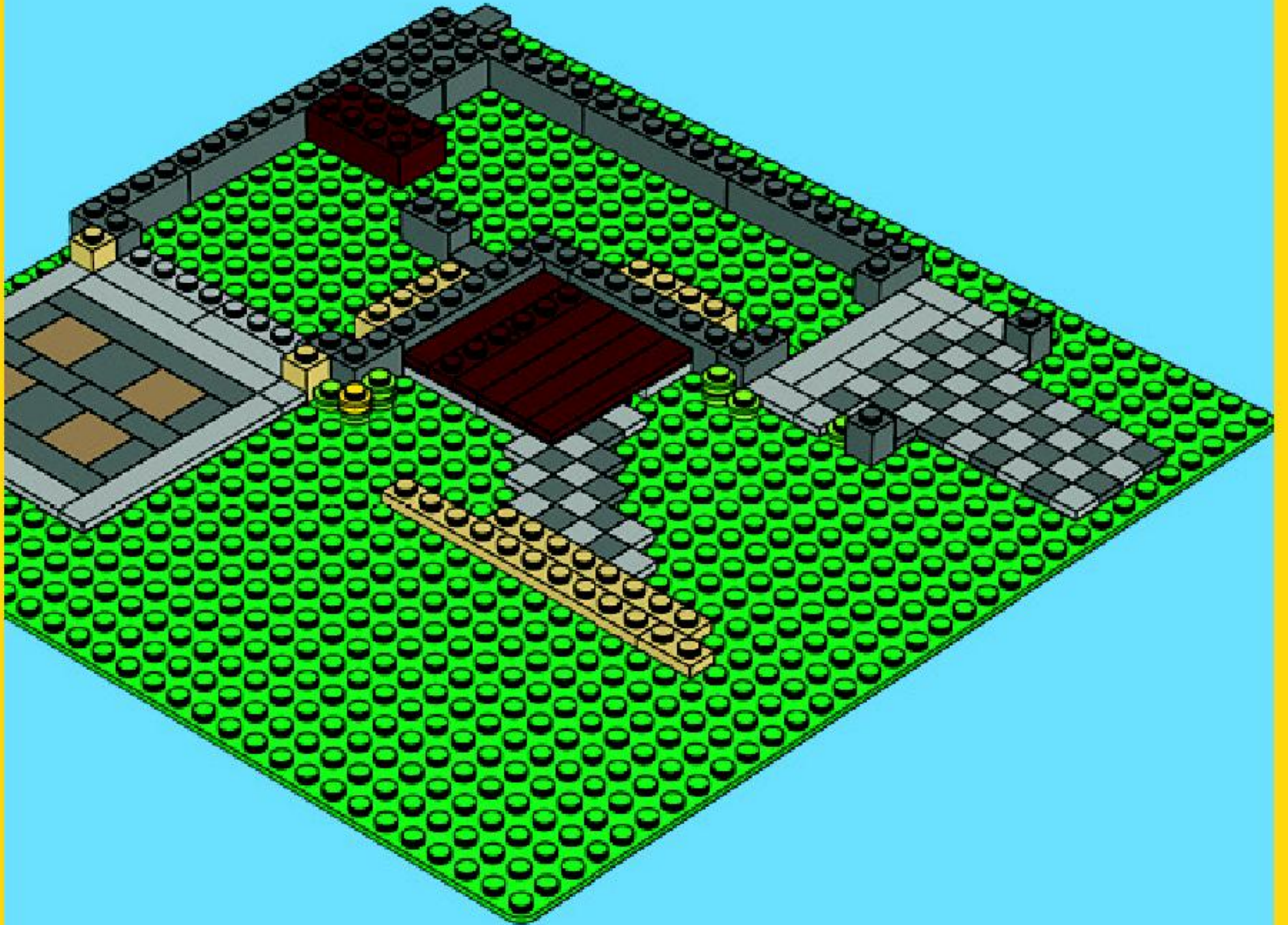

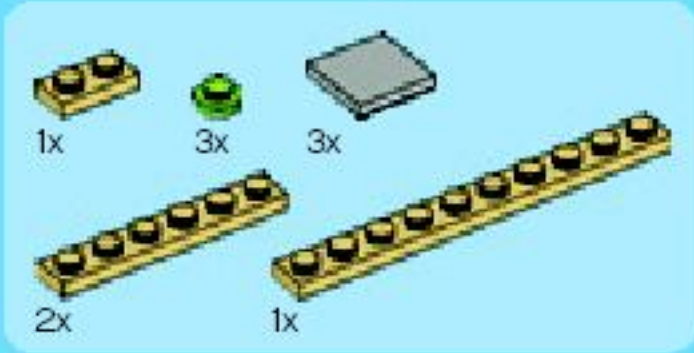

13

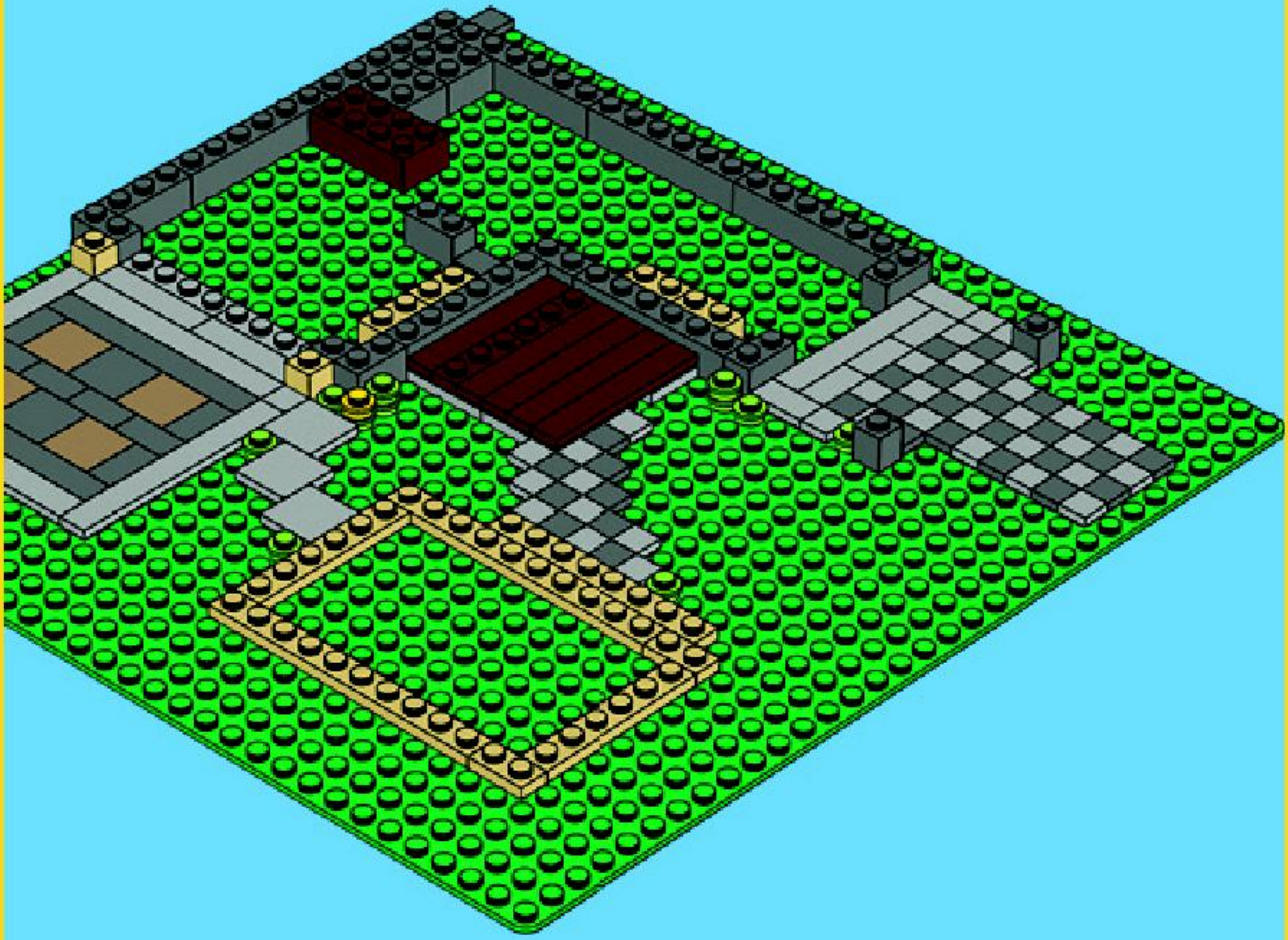



2x



6x



2x



1x

14

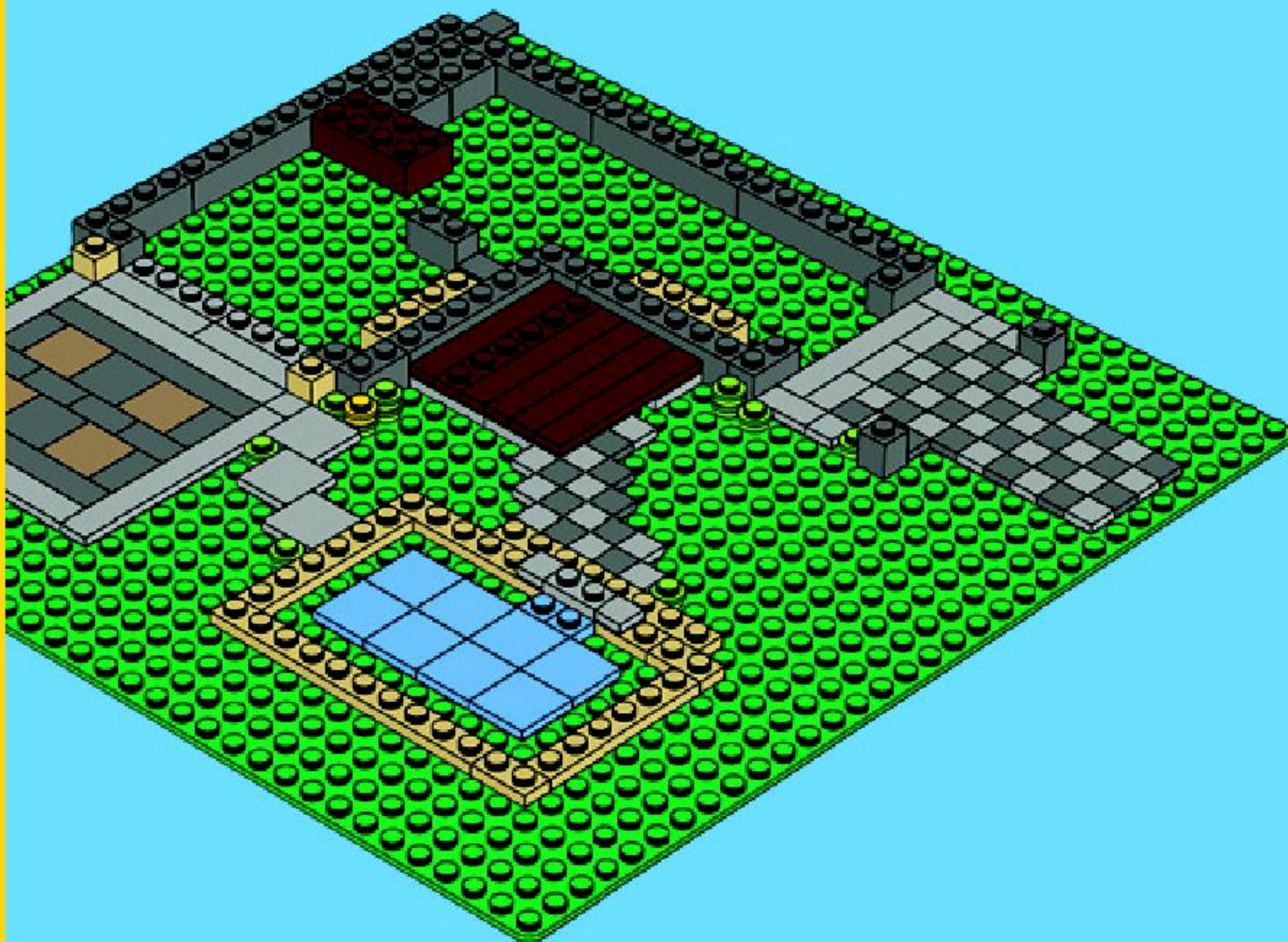

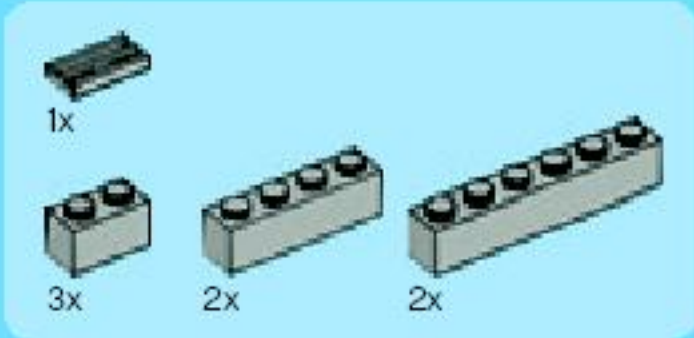

15

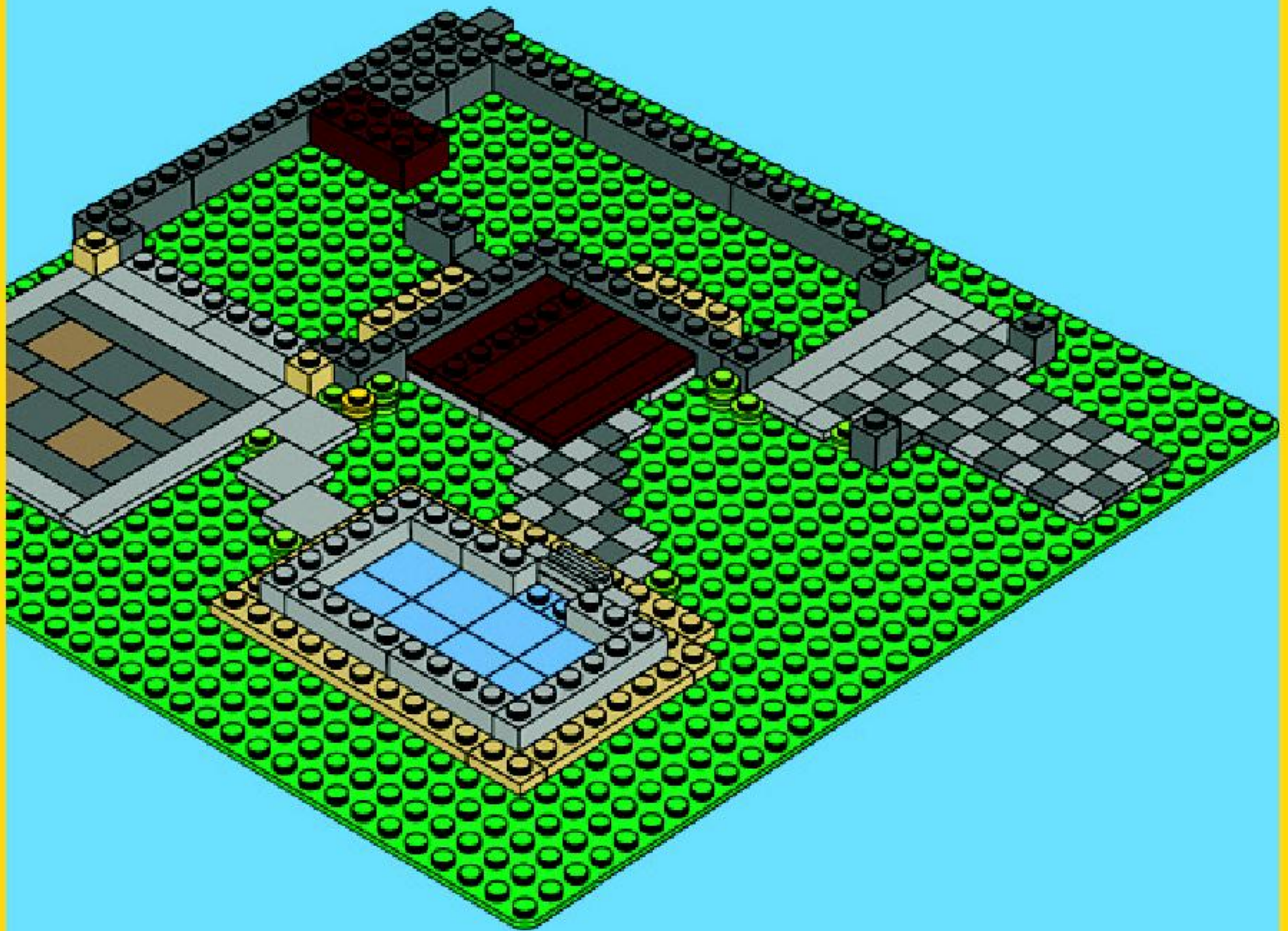

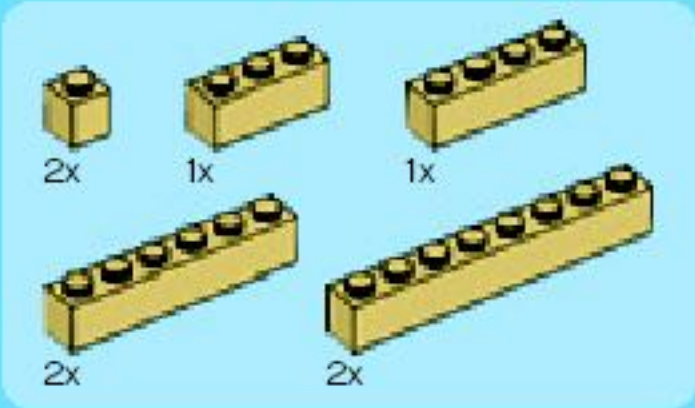

16

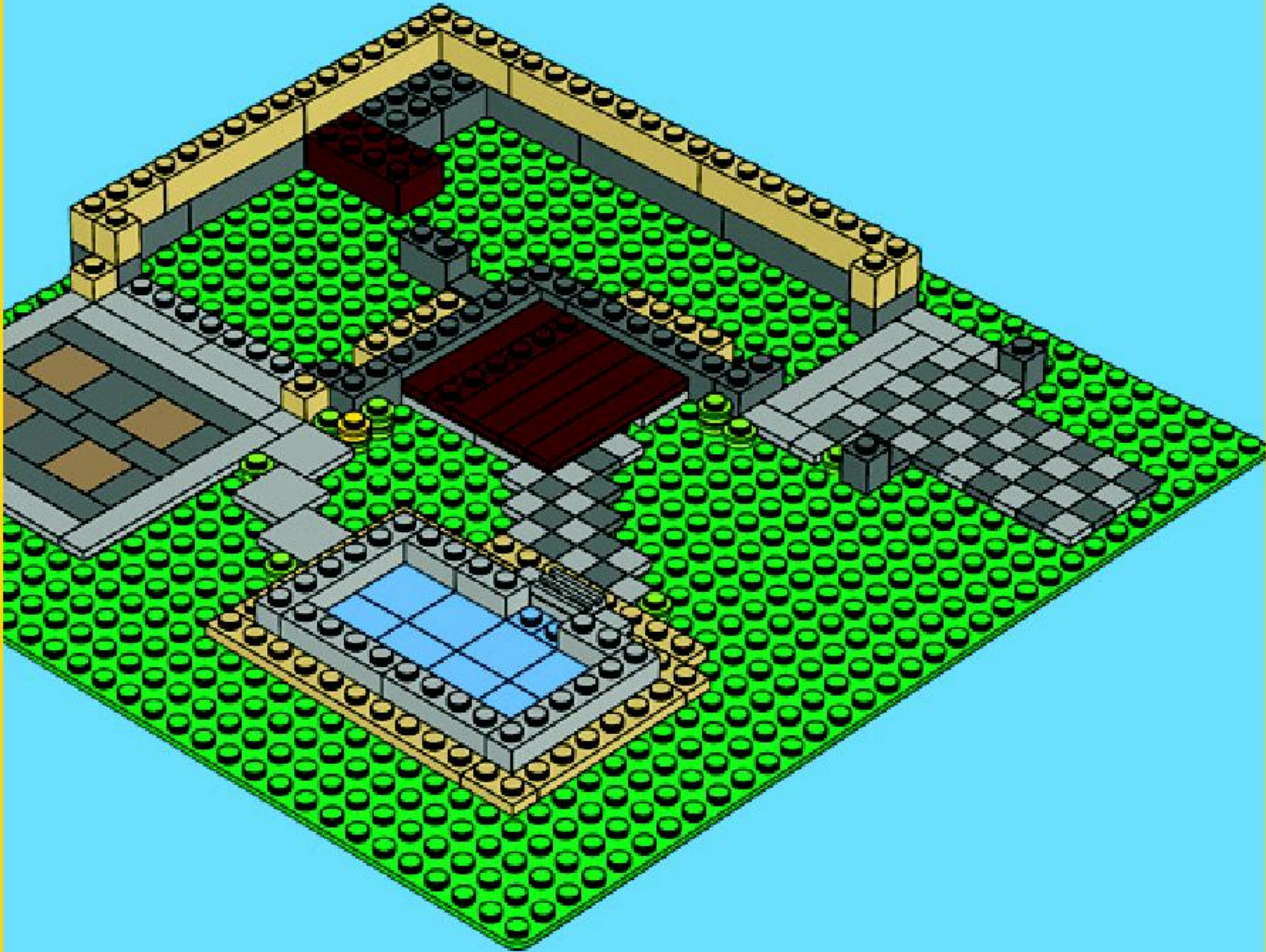

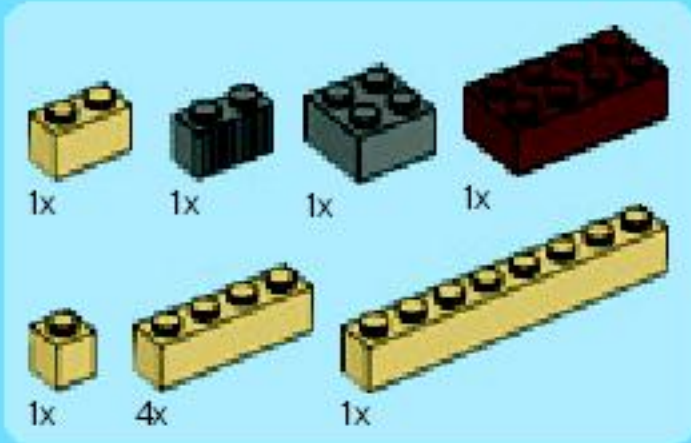

17



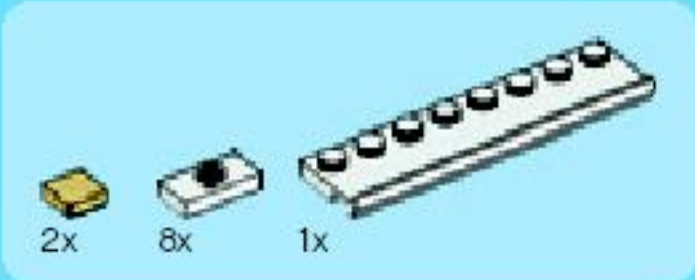

18

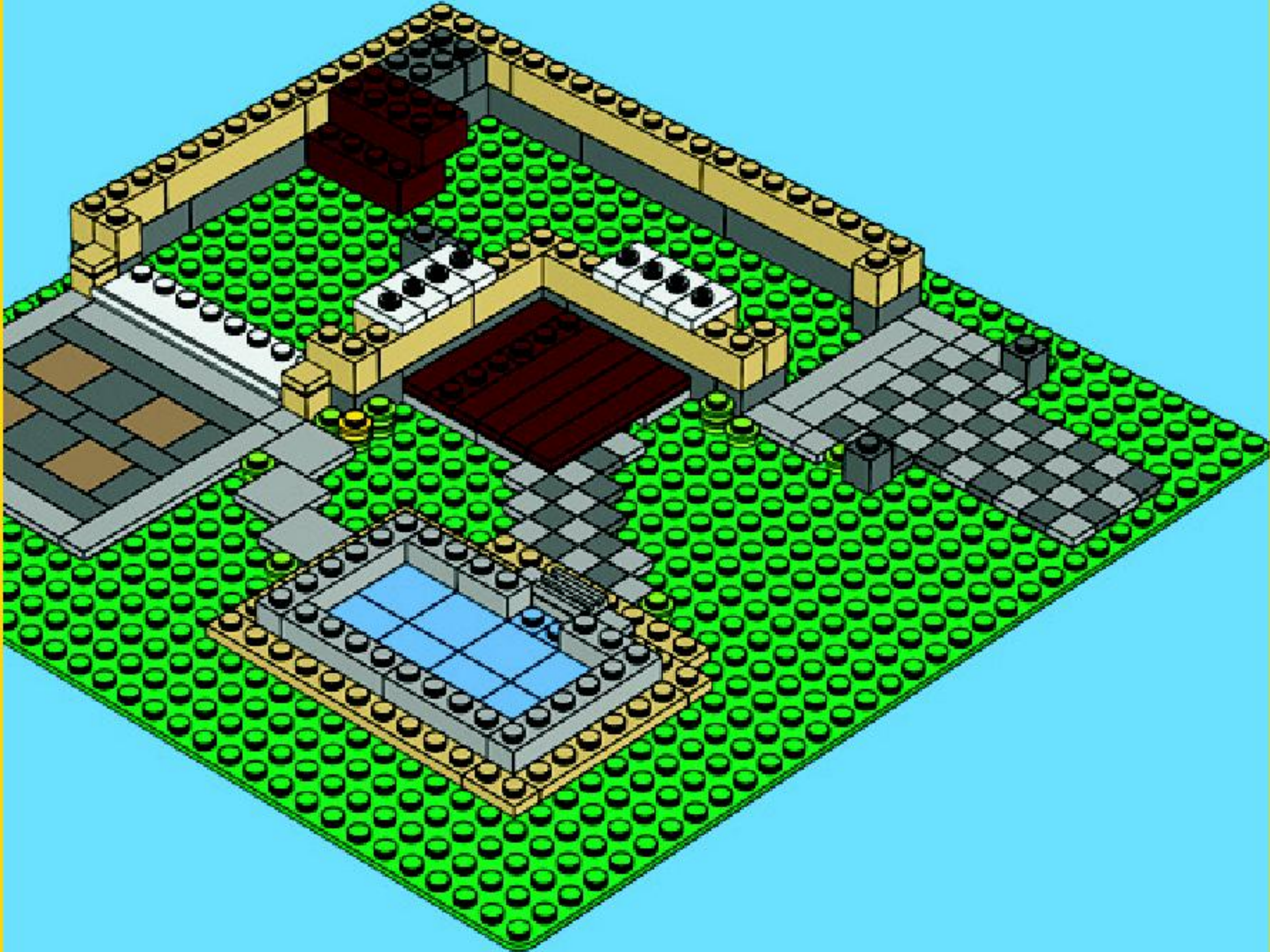

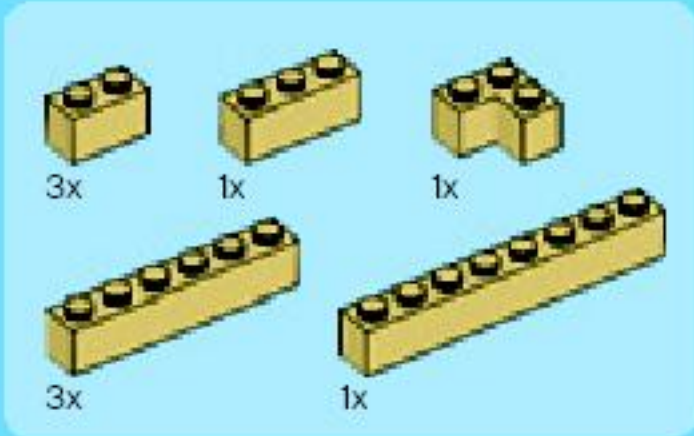

19



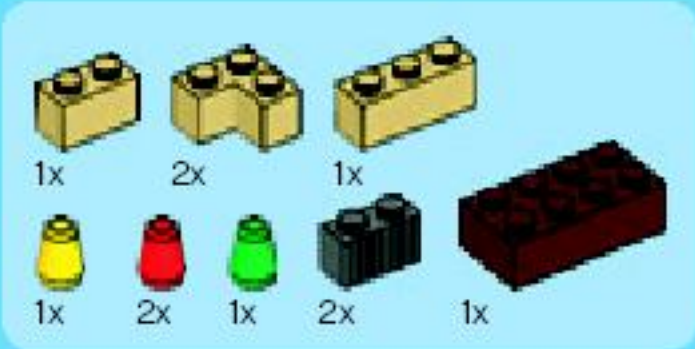

20



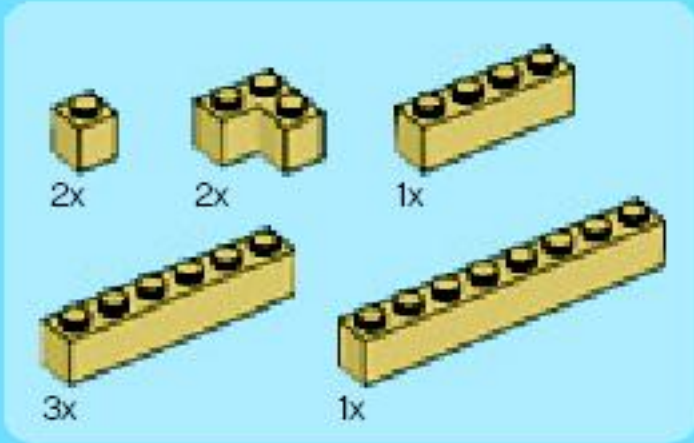

21



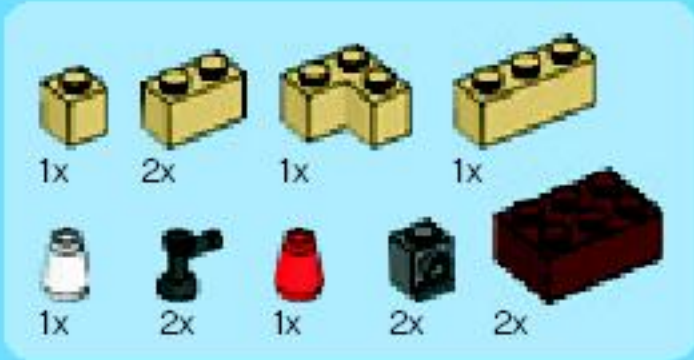

23

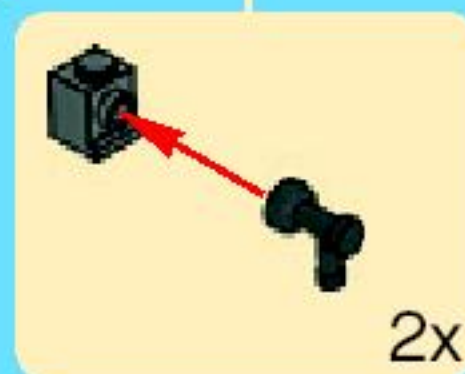

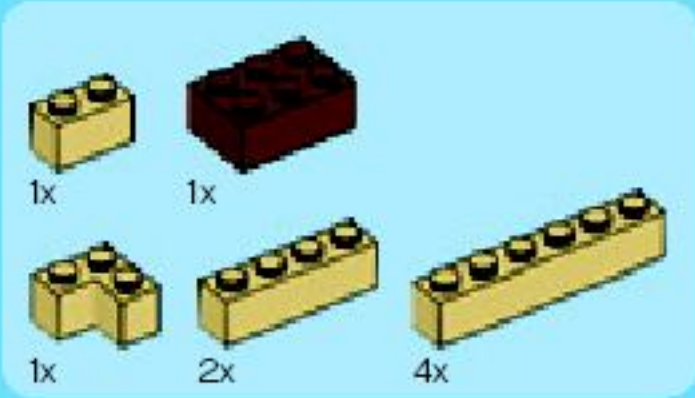

24



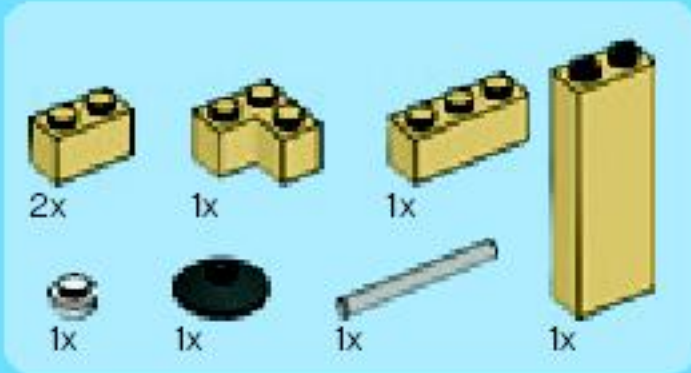

25





1x



2x



4x



2x









2x



1x

26

<p>1</p> 	<p>3</p> 	<p>5</p> 
<p>2</p> 	<p>4</p> 	<p>6</p> 





4x



4x

27

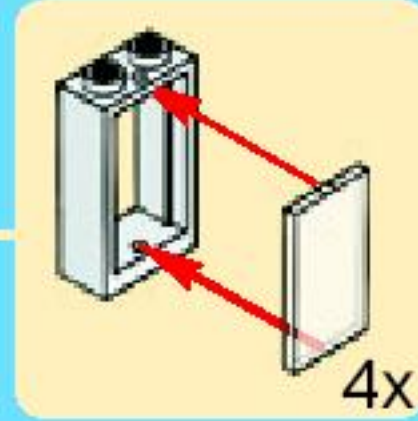

4x



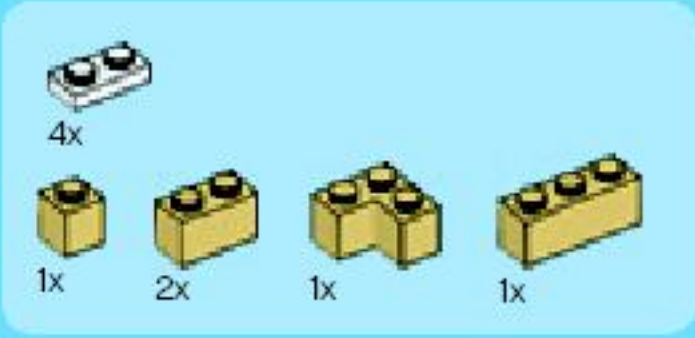

28



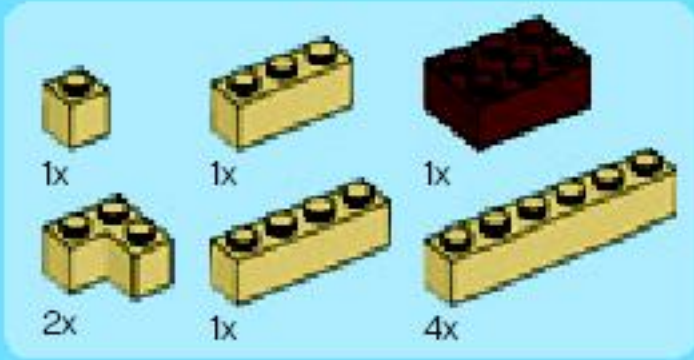

29



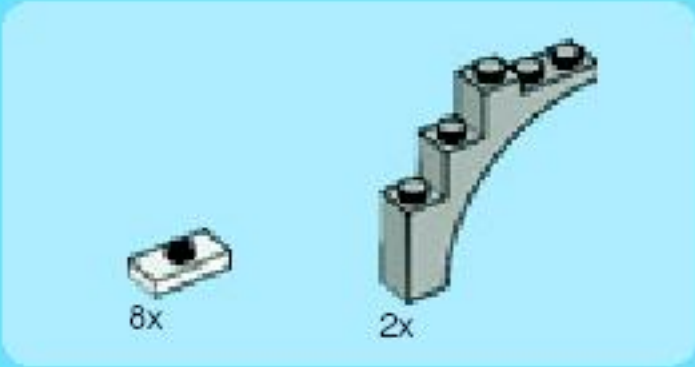

30



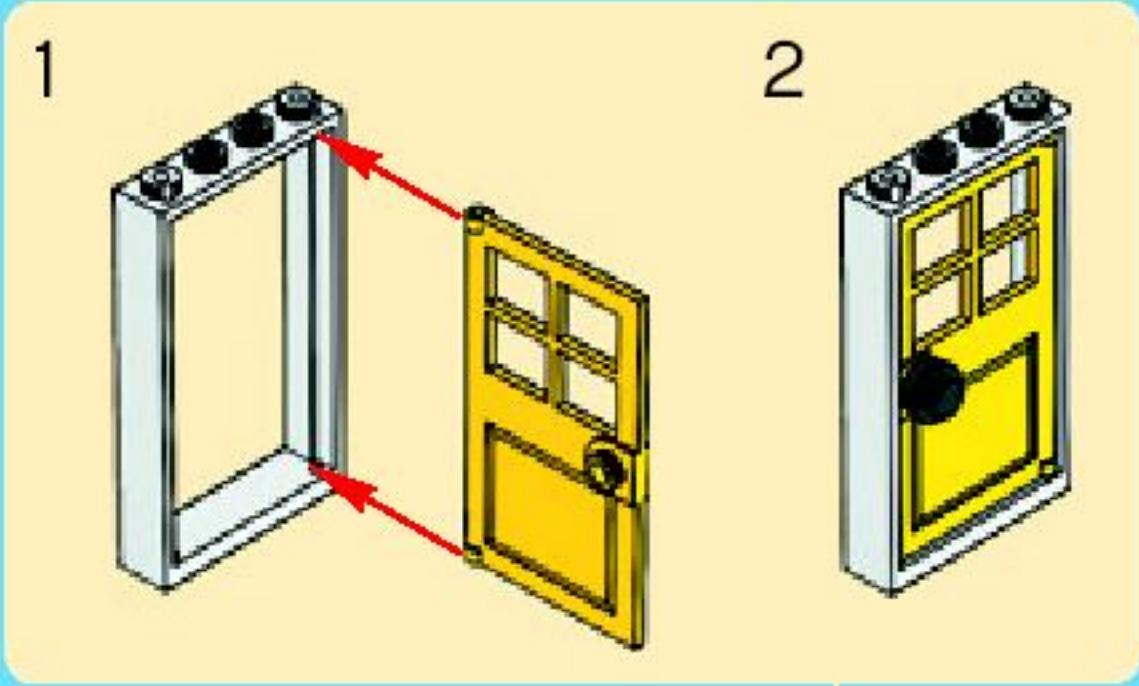
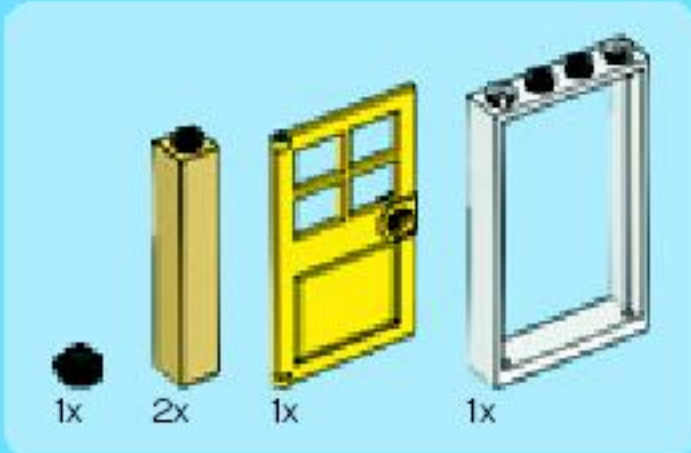

31



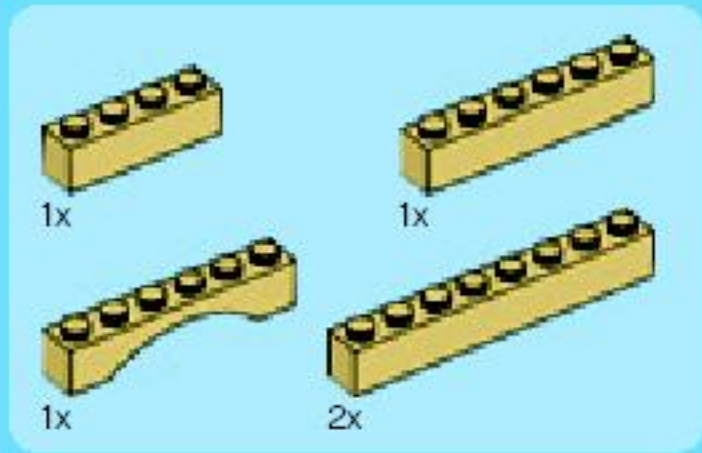

32



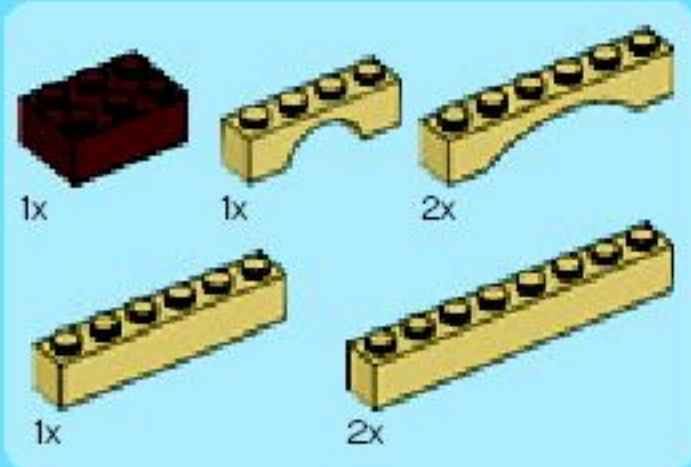

33





2x



2x

34



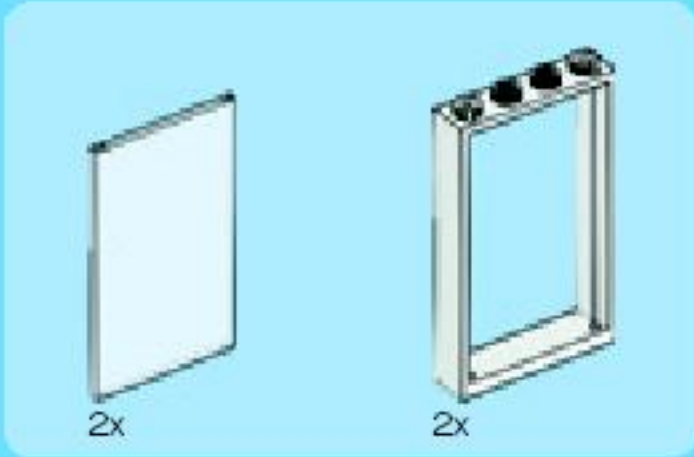

35

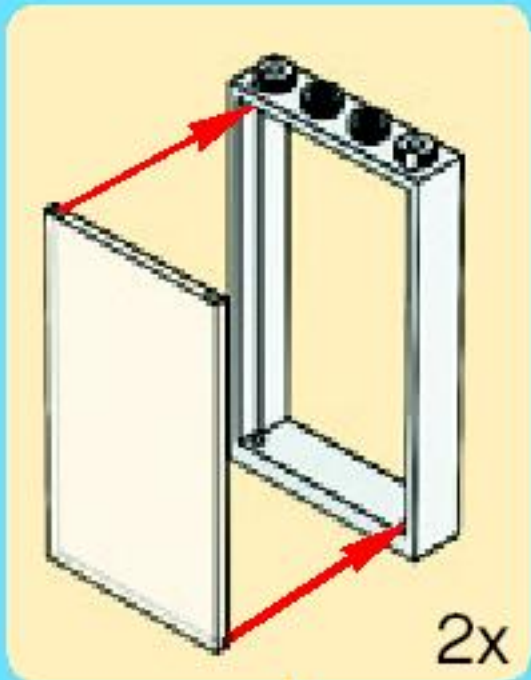



1x

36



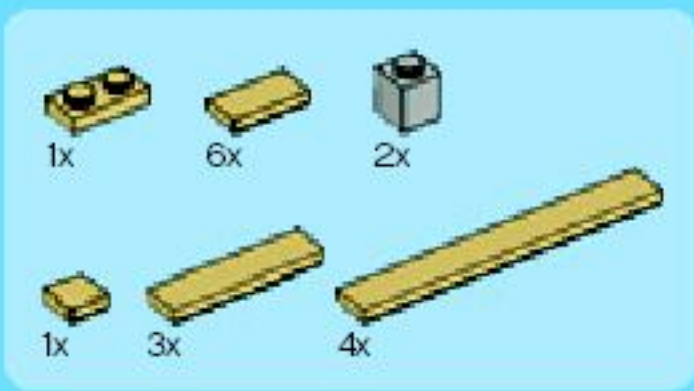

37



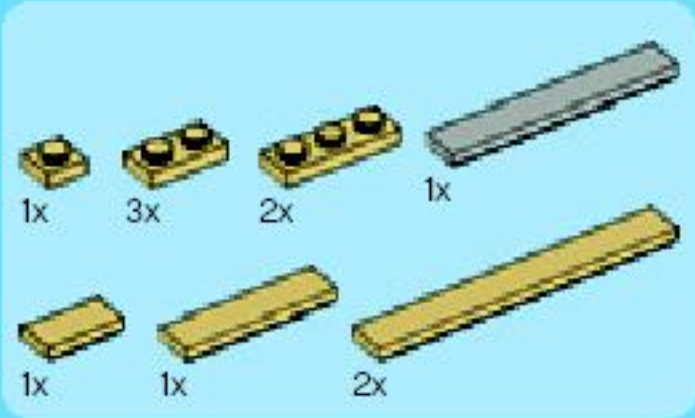

38



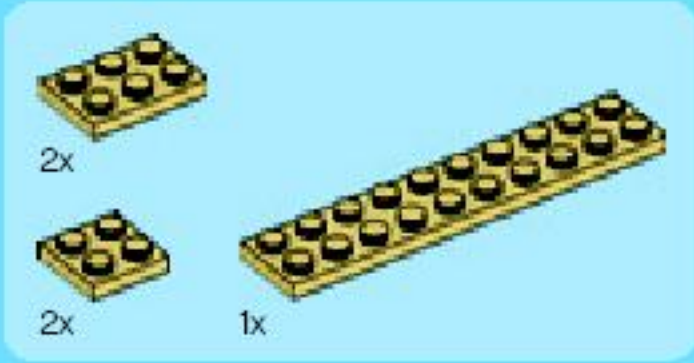

39



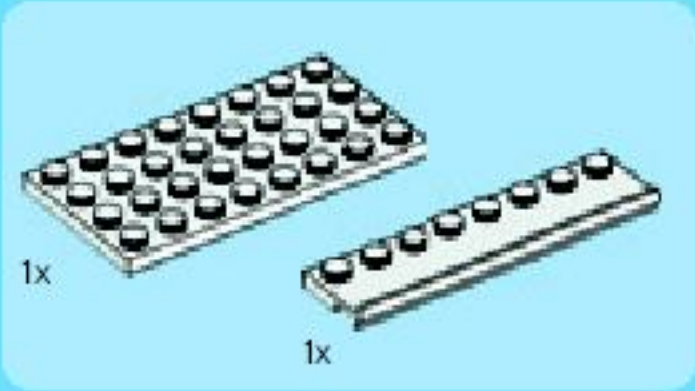

40





2x



4x

41





42



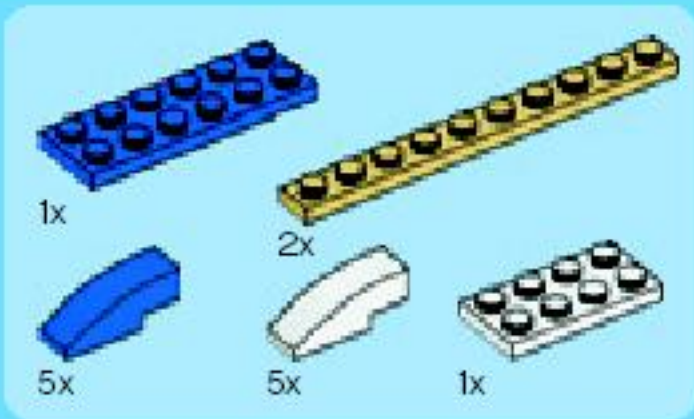

43

1

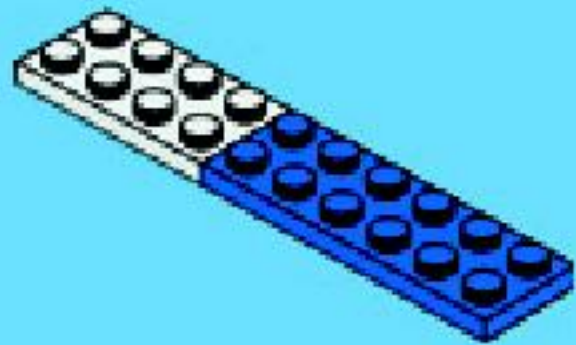

2

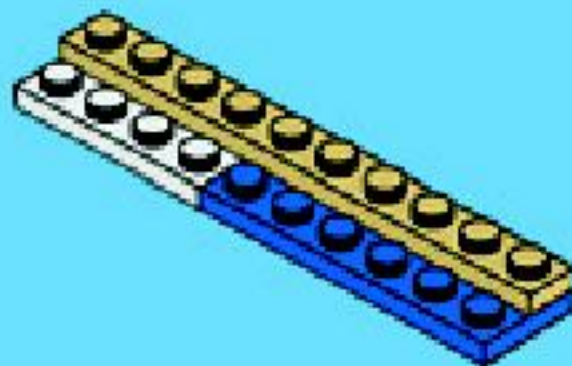

3

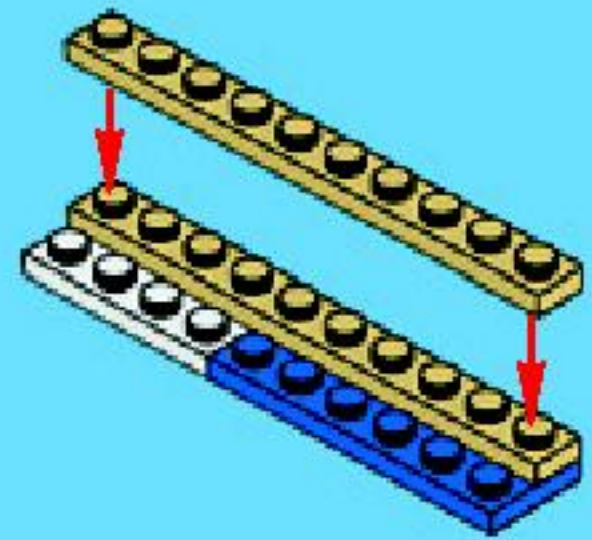

4

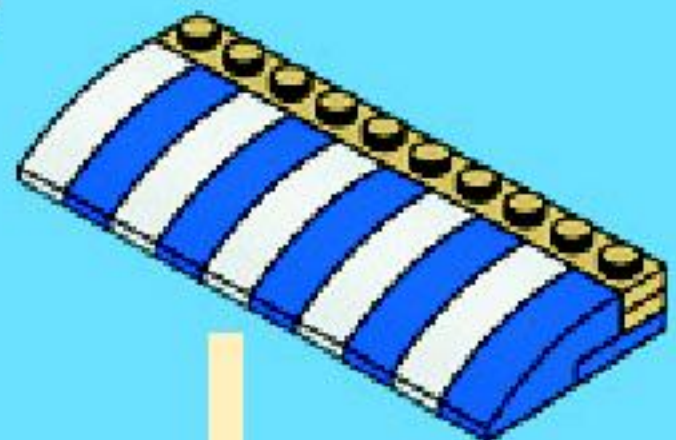

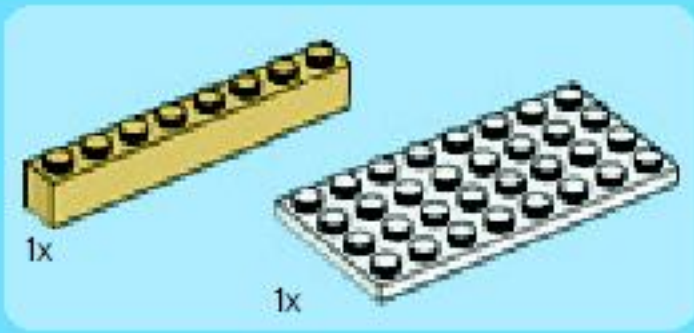

3

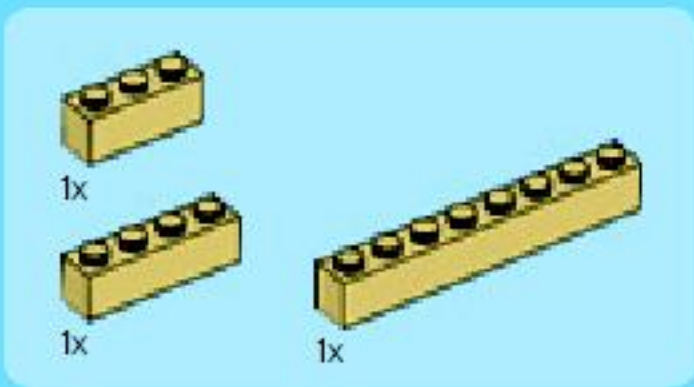
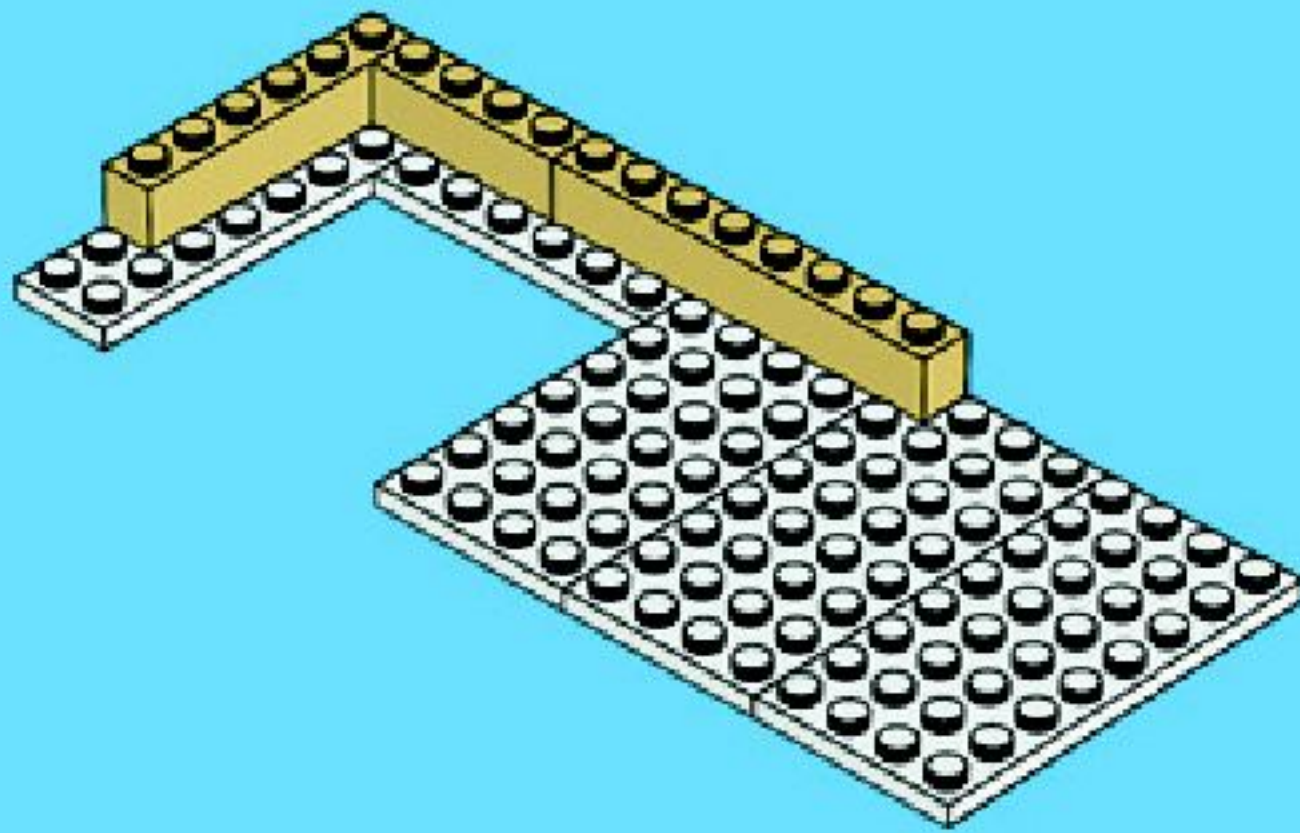

4

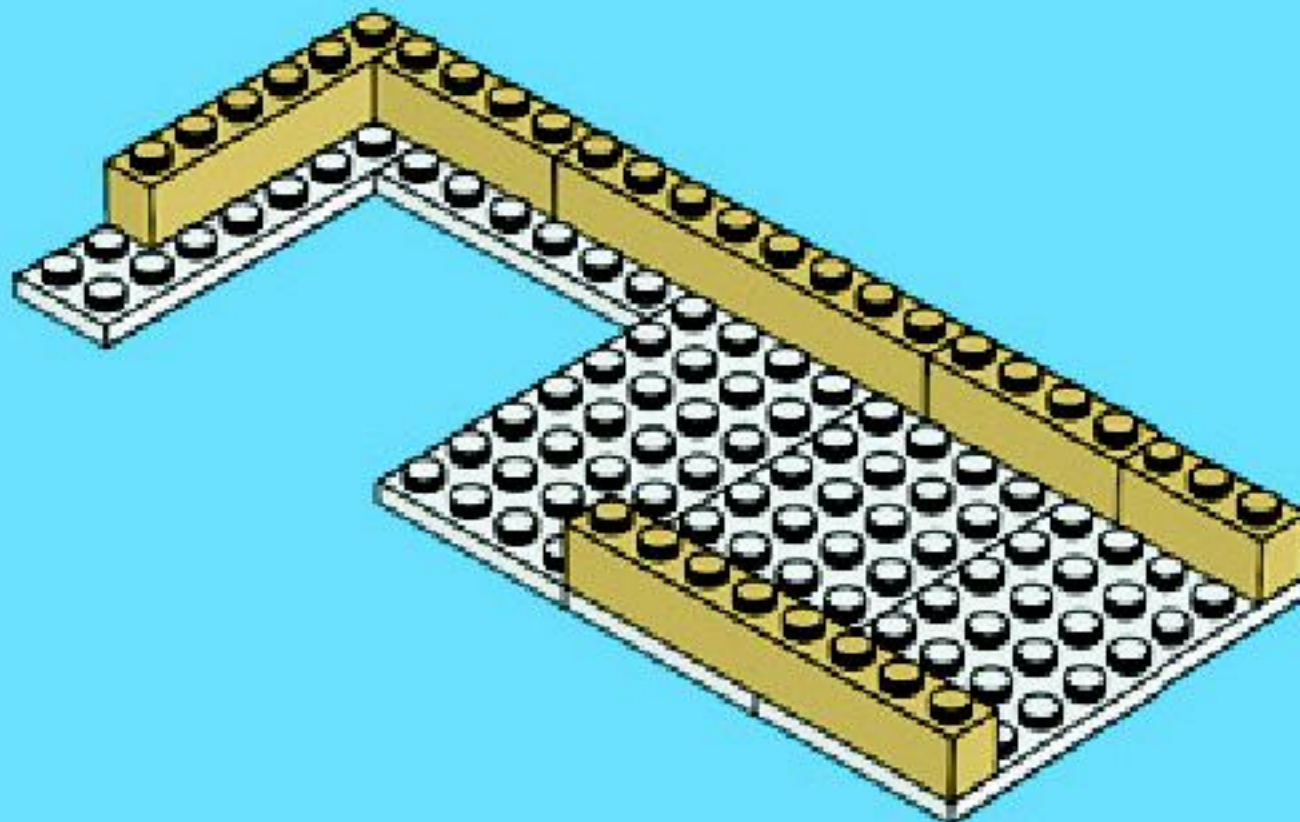



5

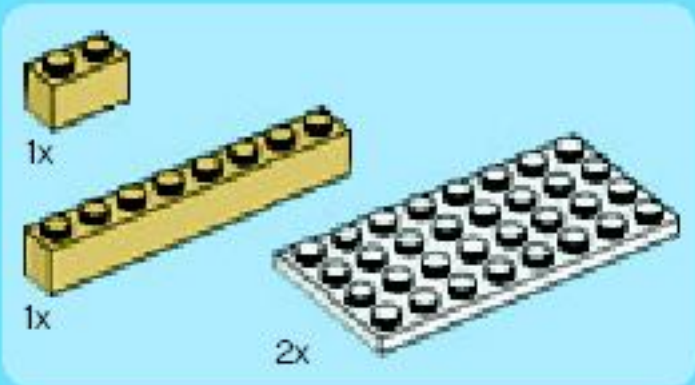
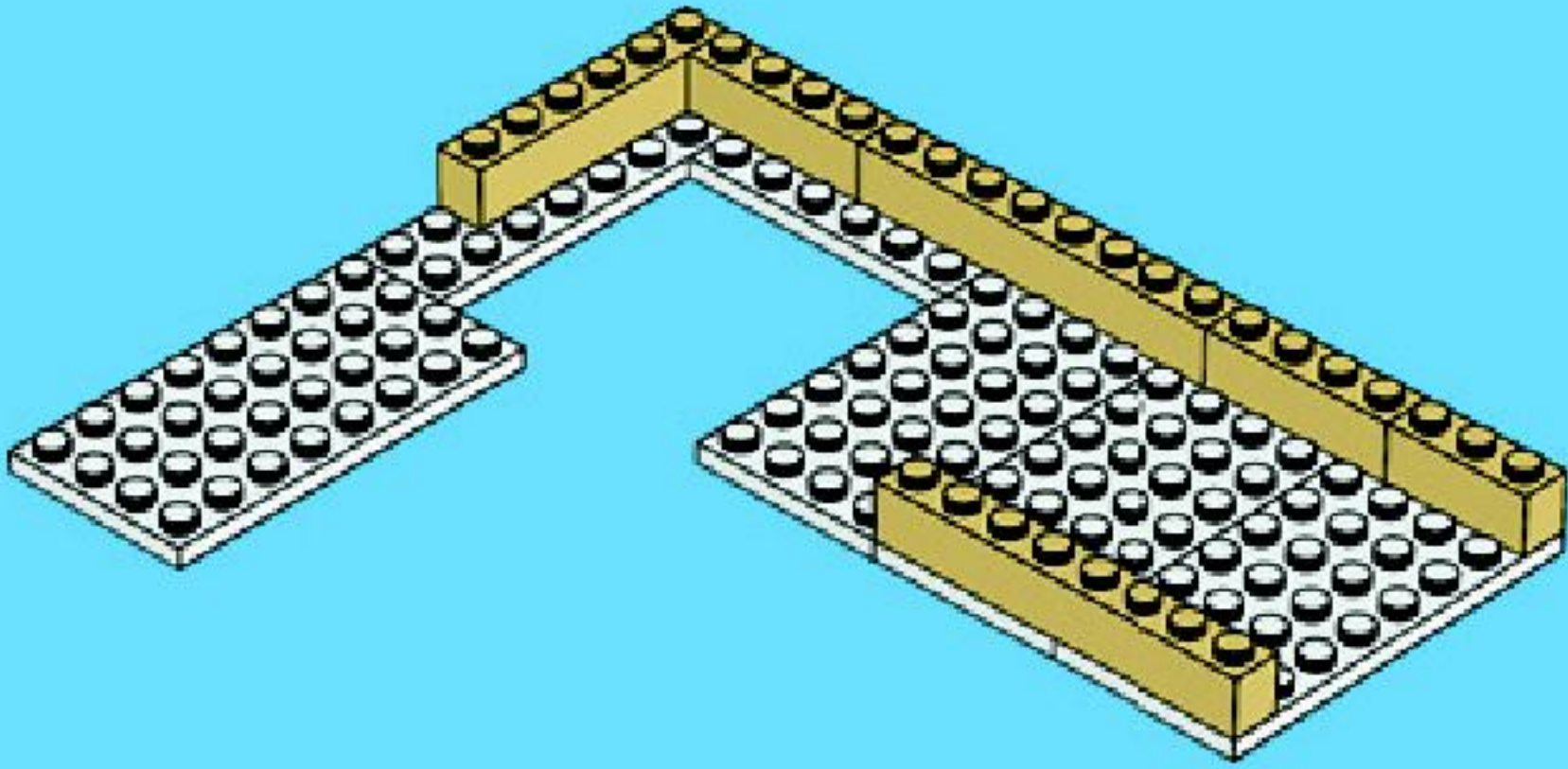

6

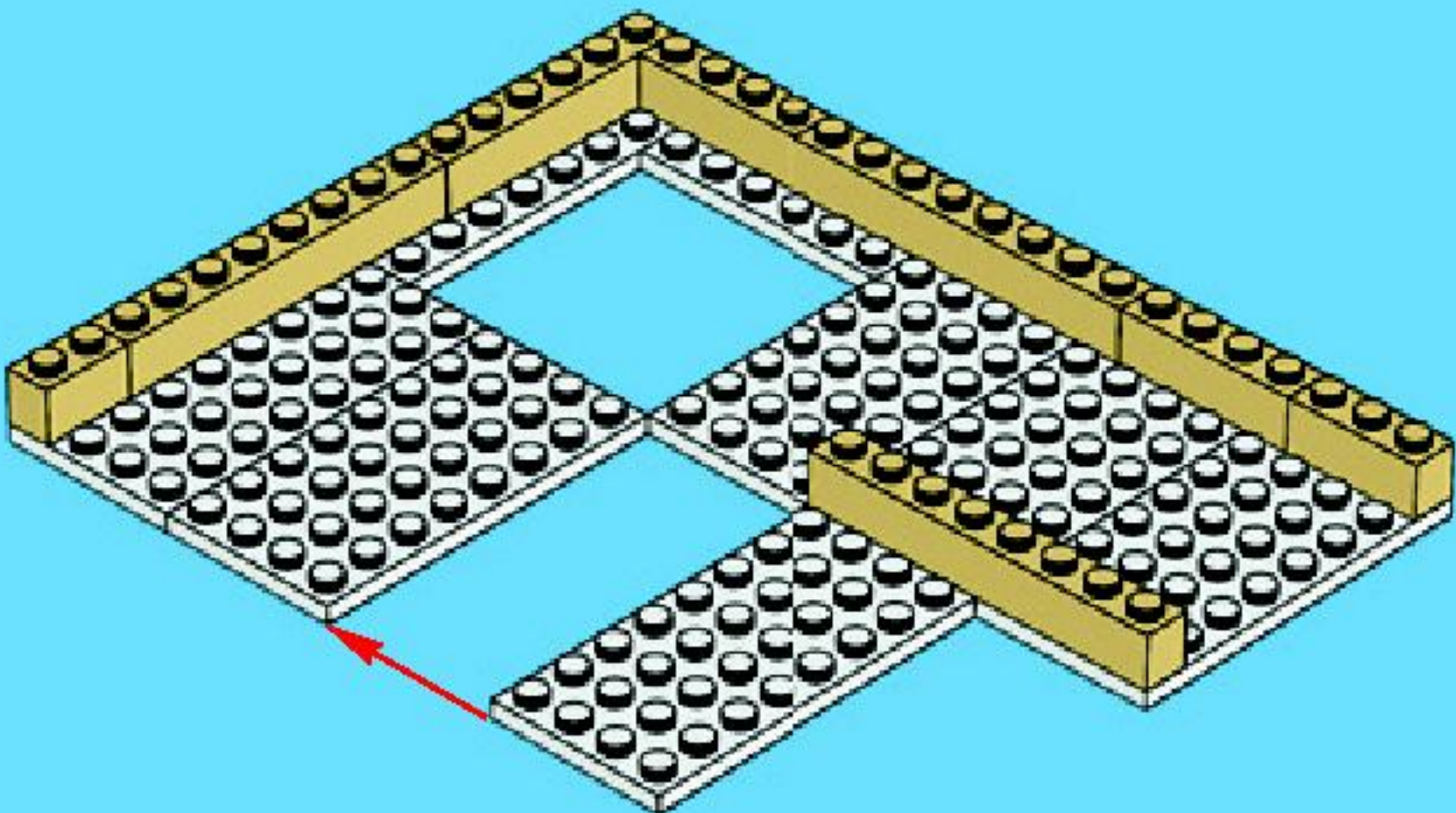

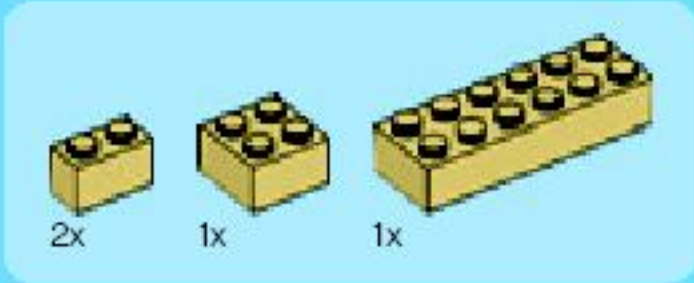

7

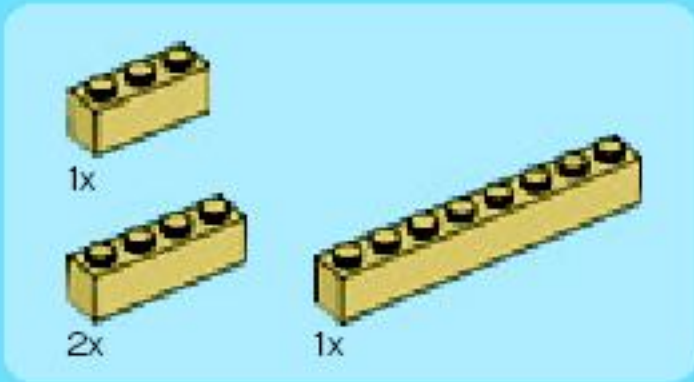
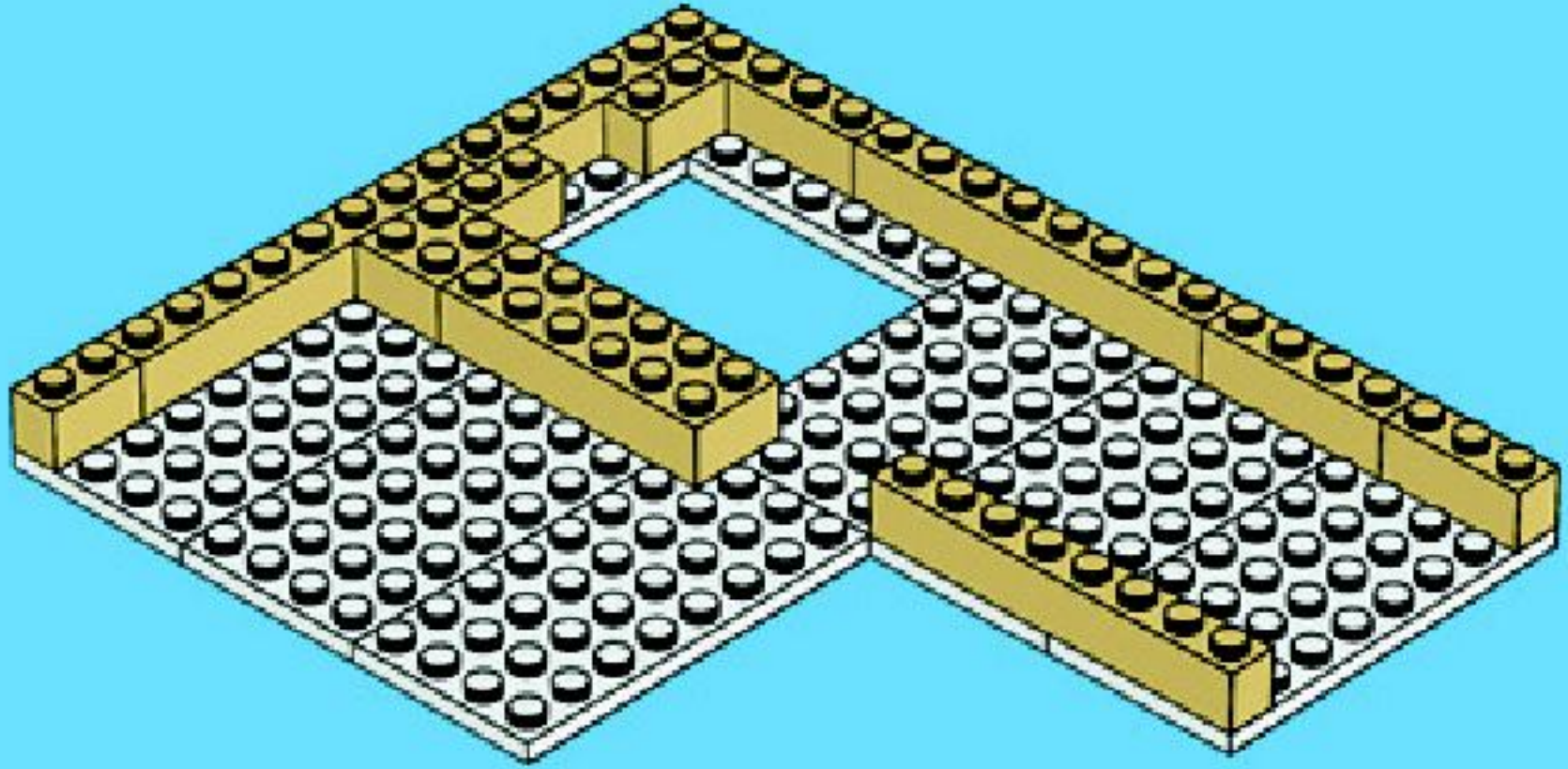

8

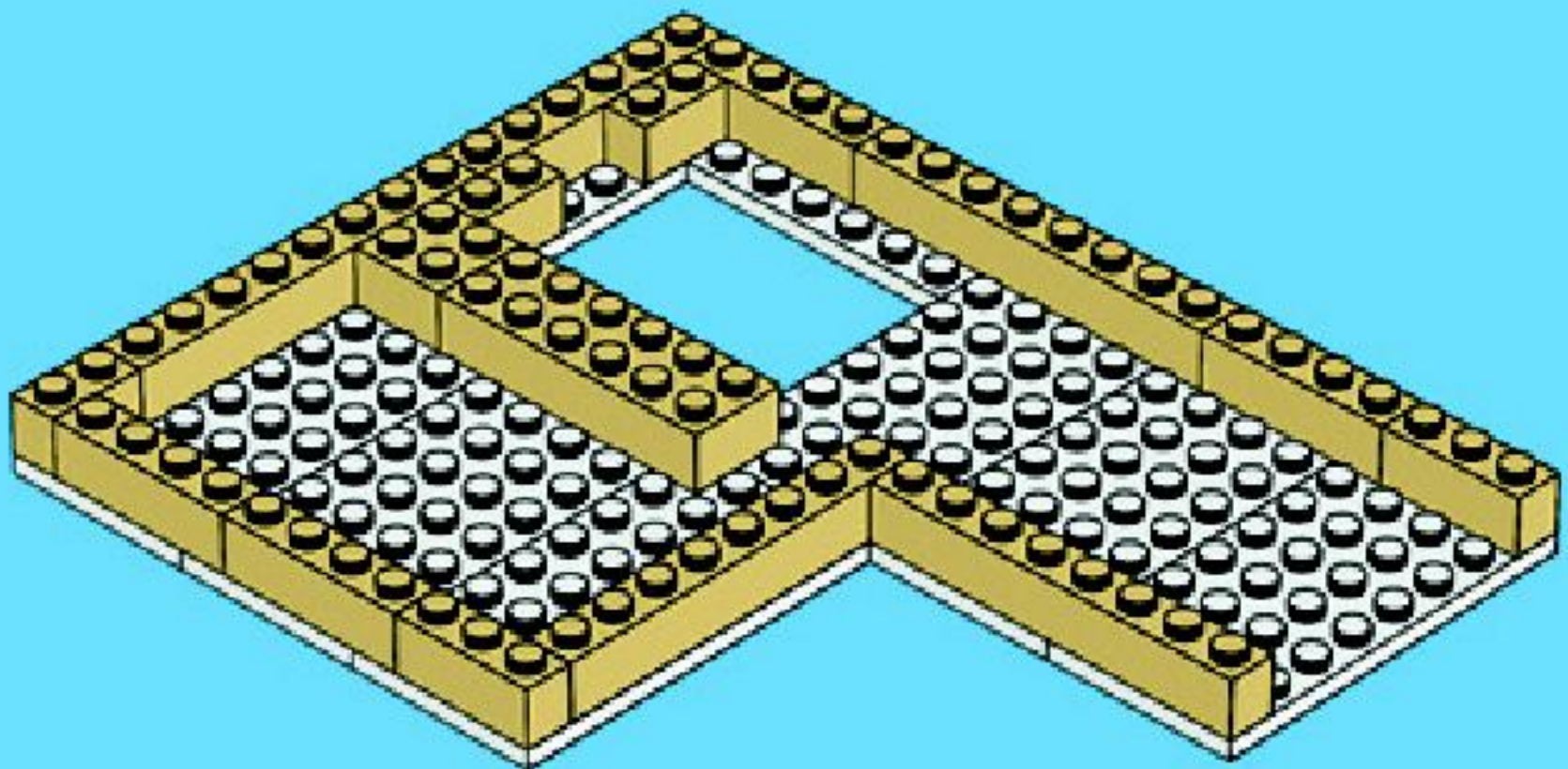

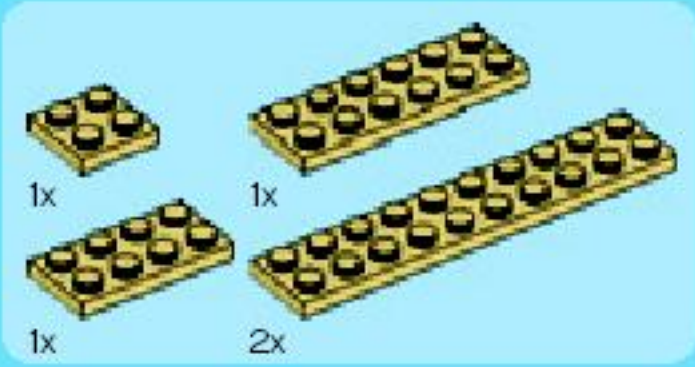

9

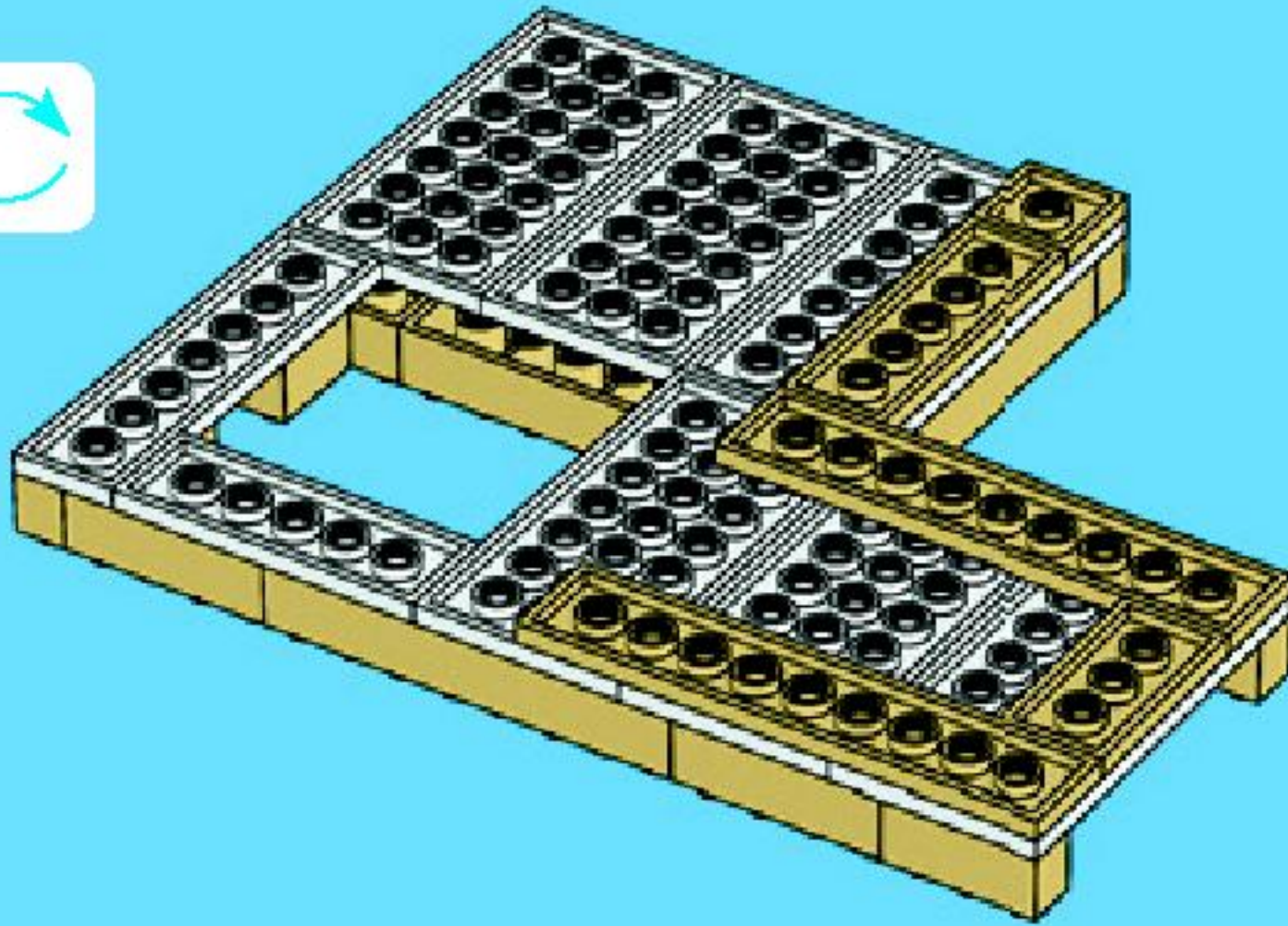

10

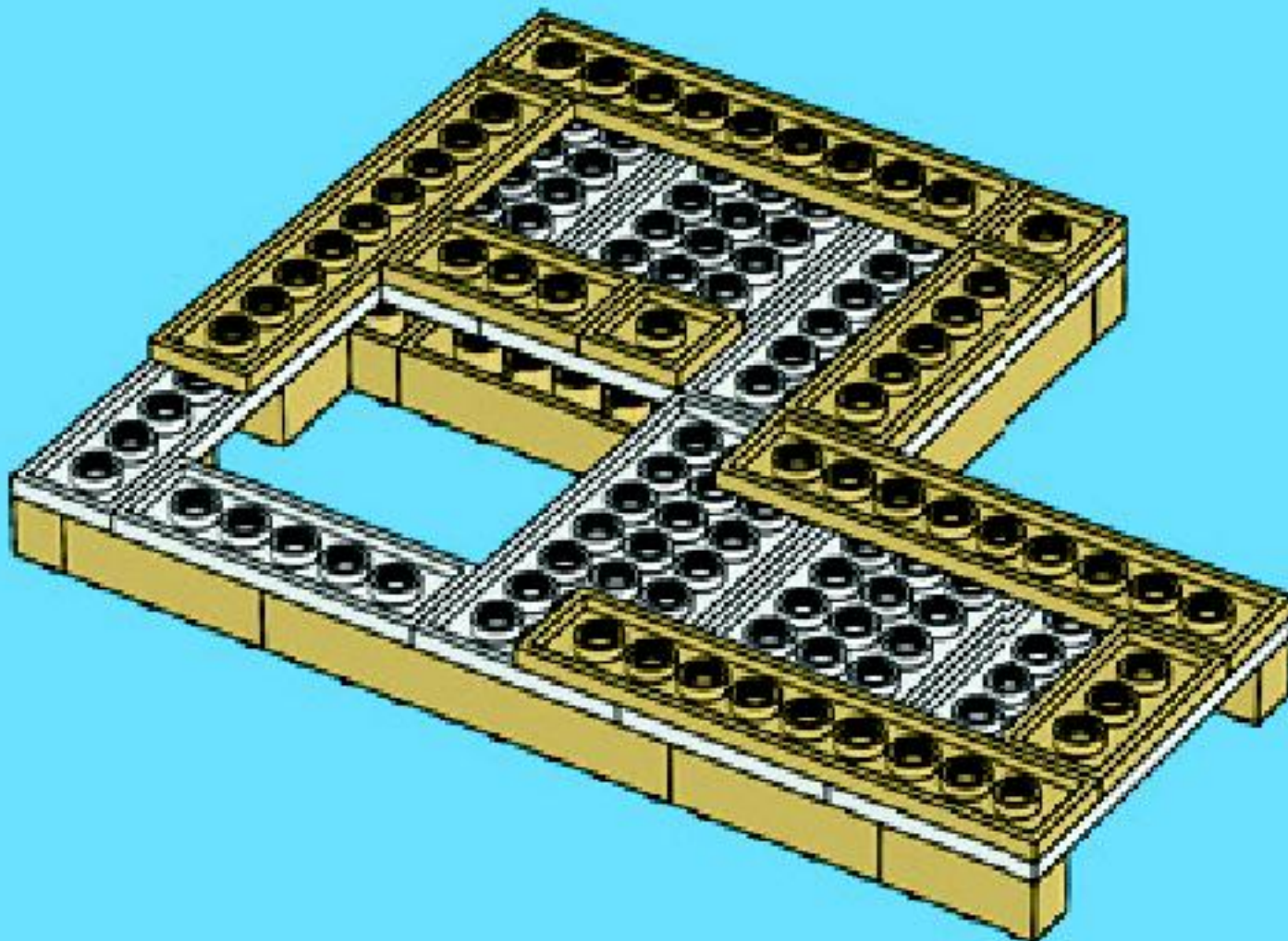



11

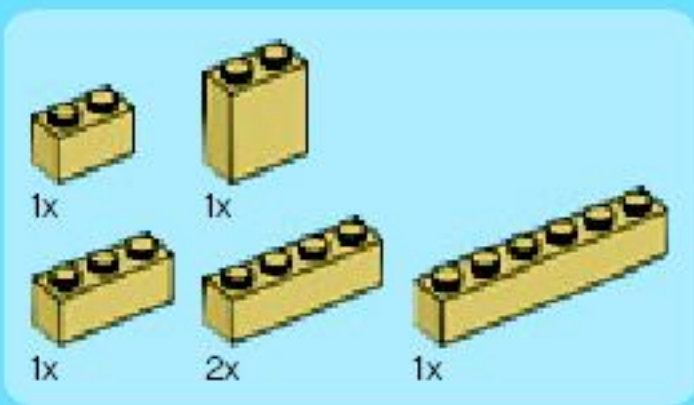
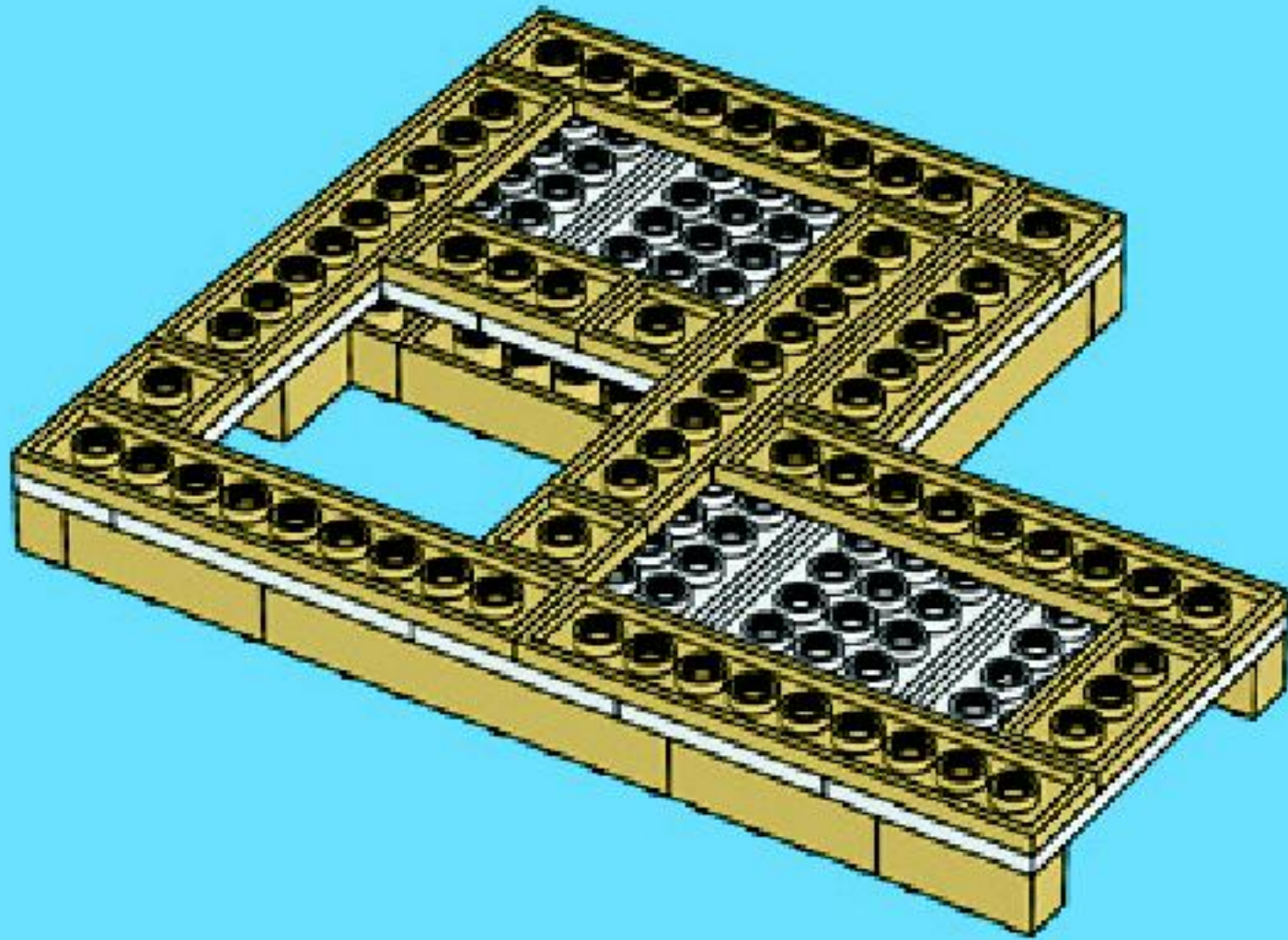

12

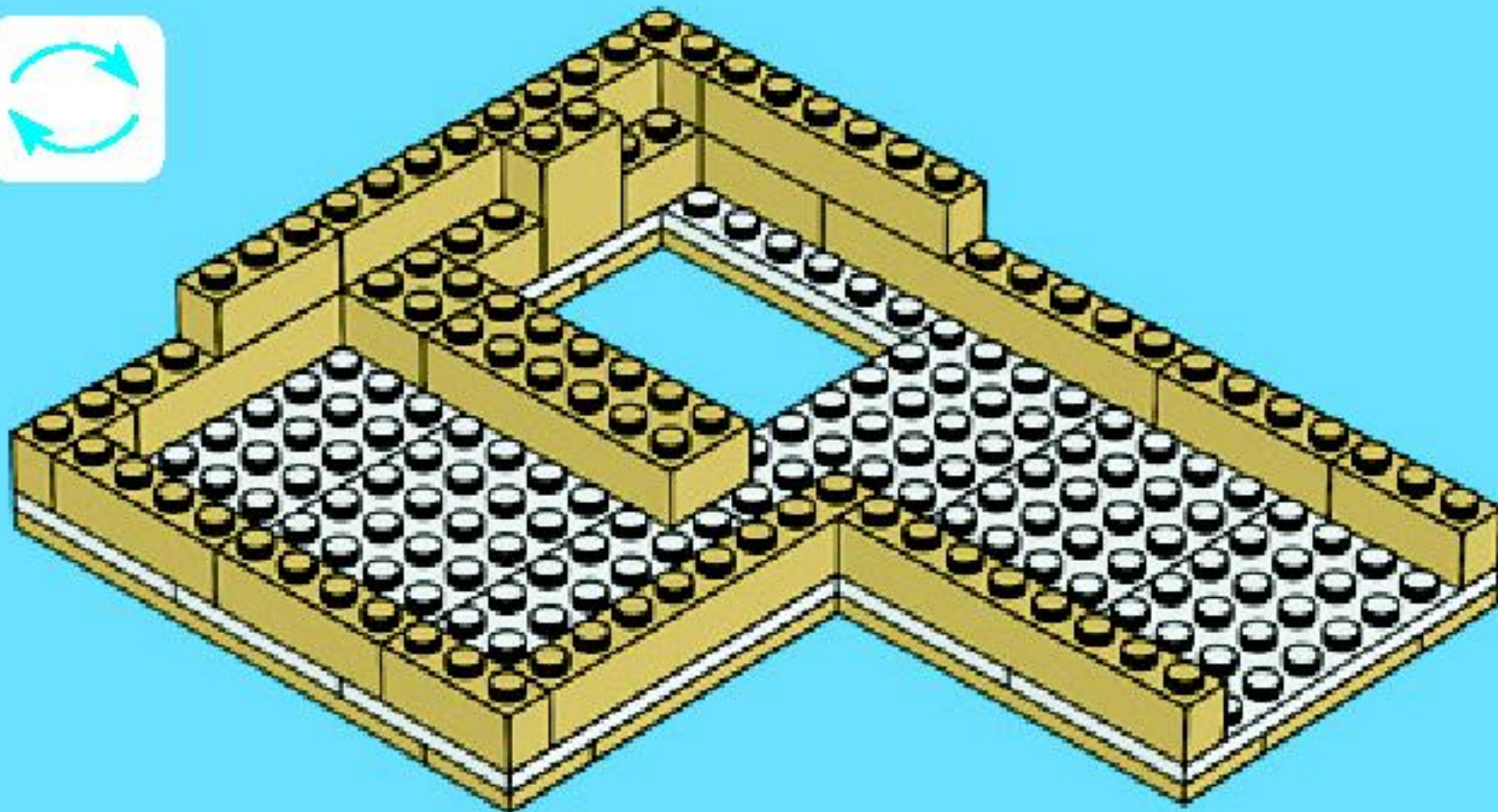



1x



3x

13

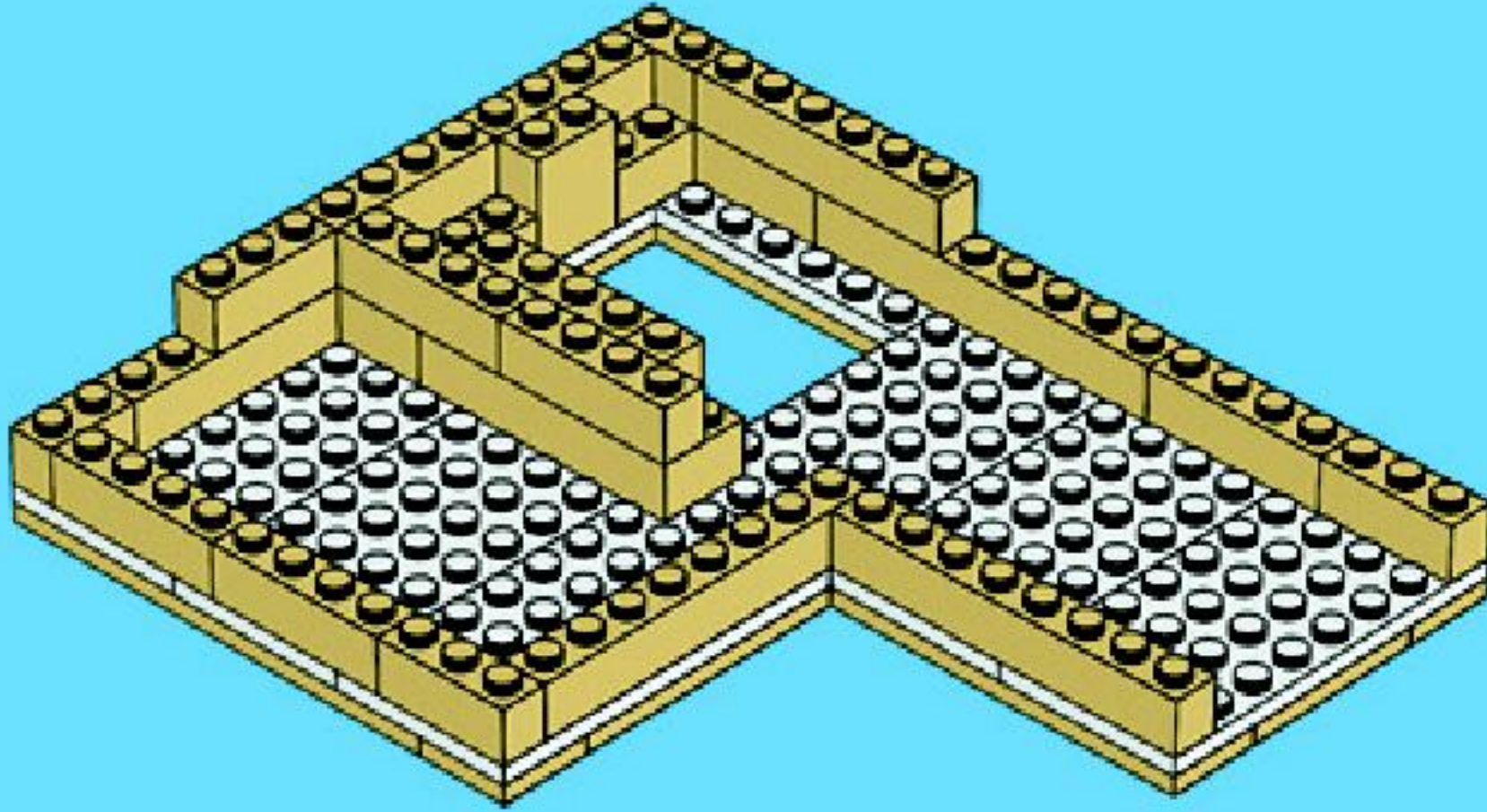

4x

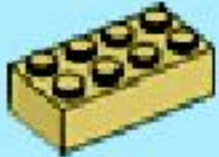

1x



2x



1x



1x

14

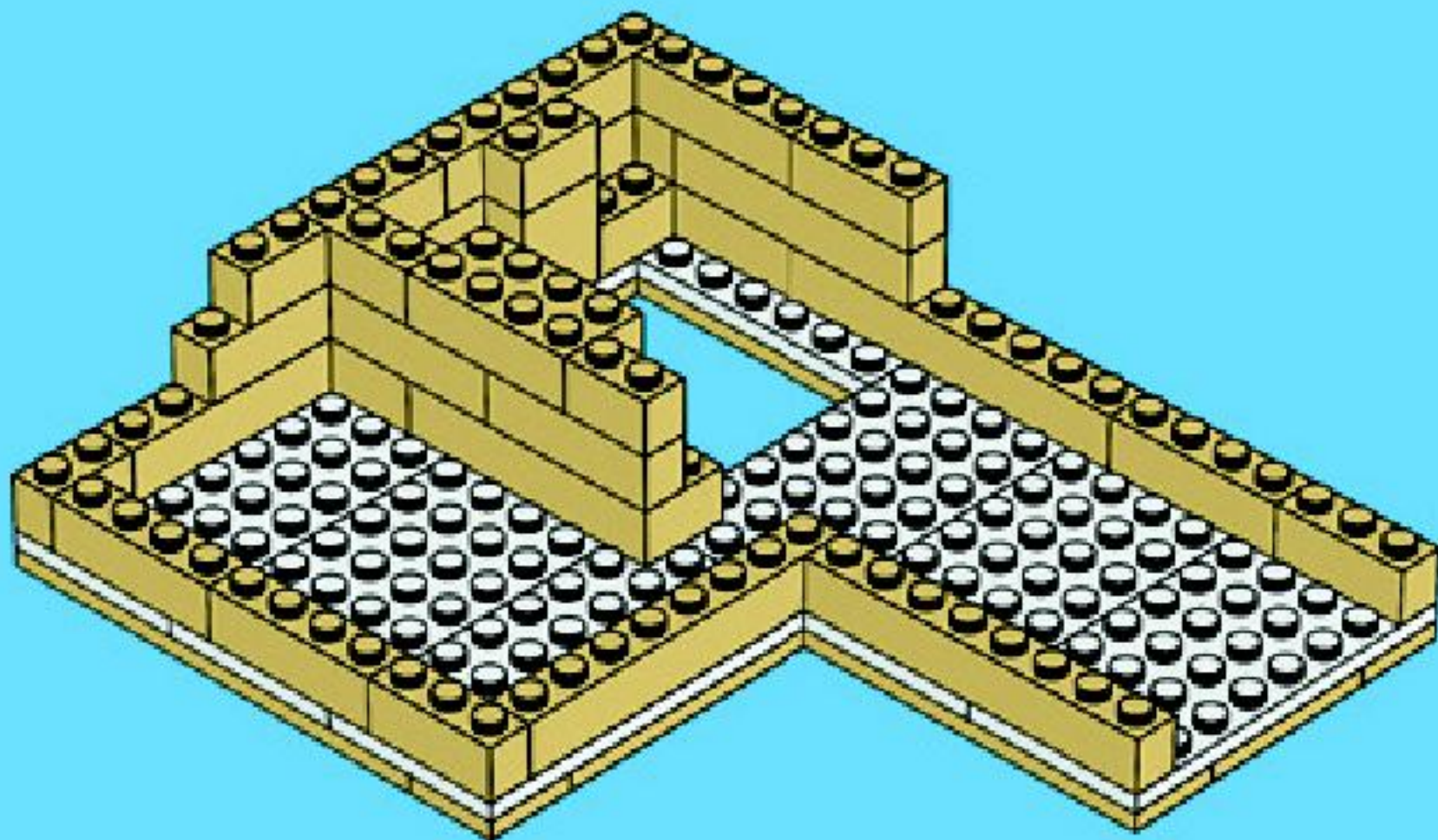

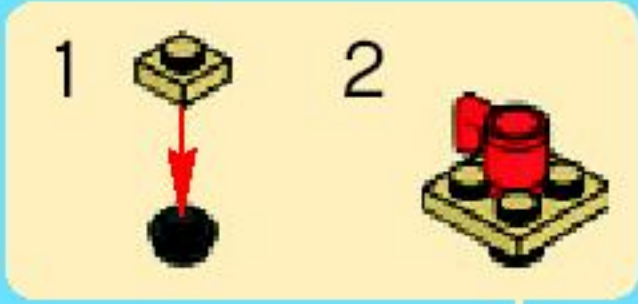

15

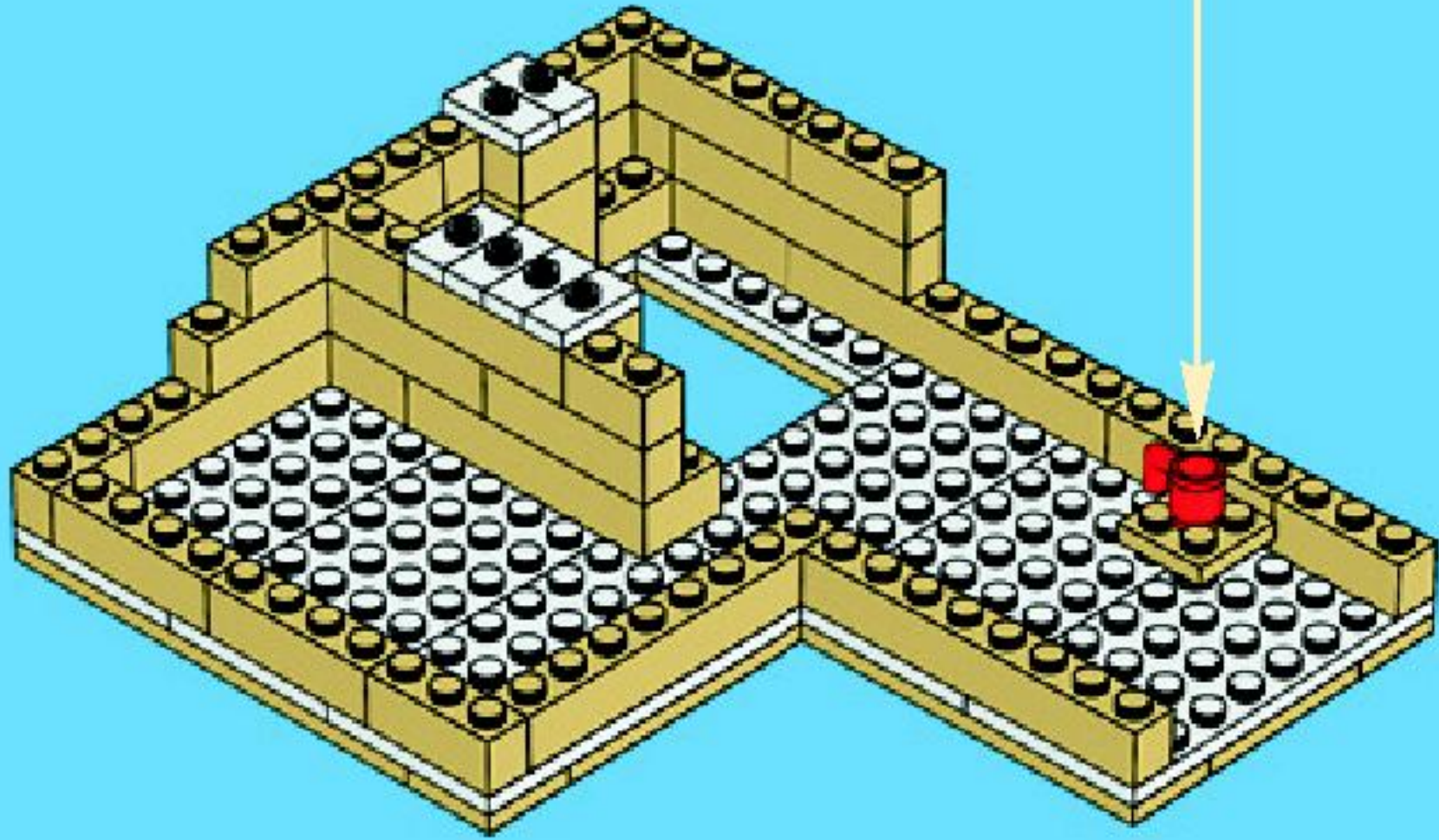

16

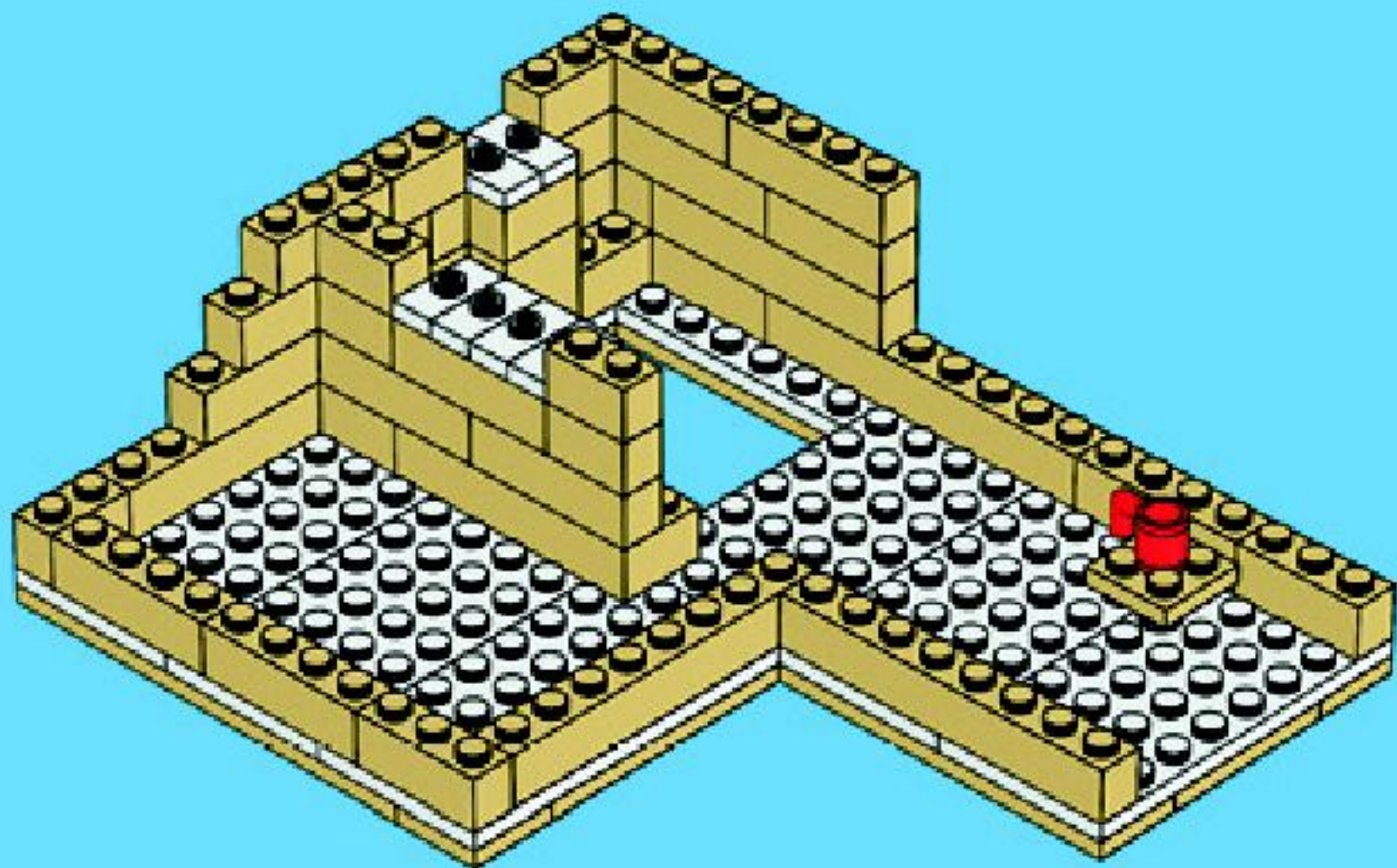



17

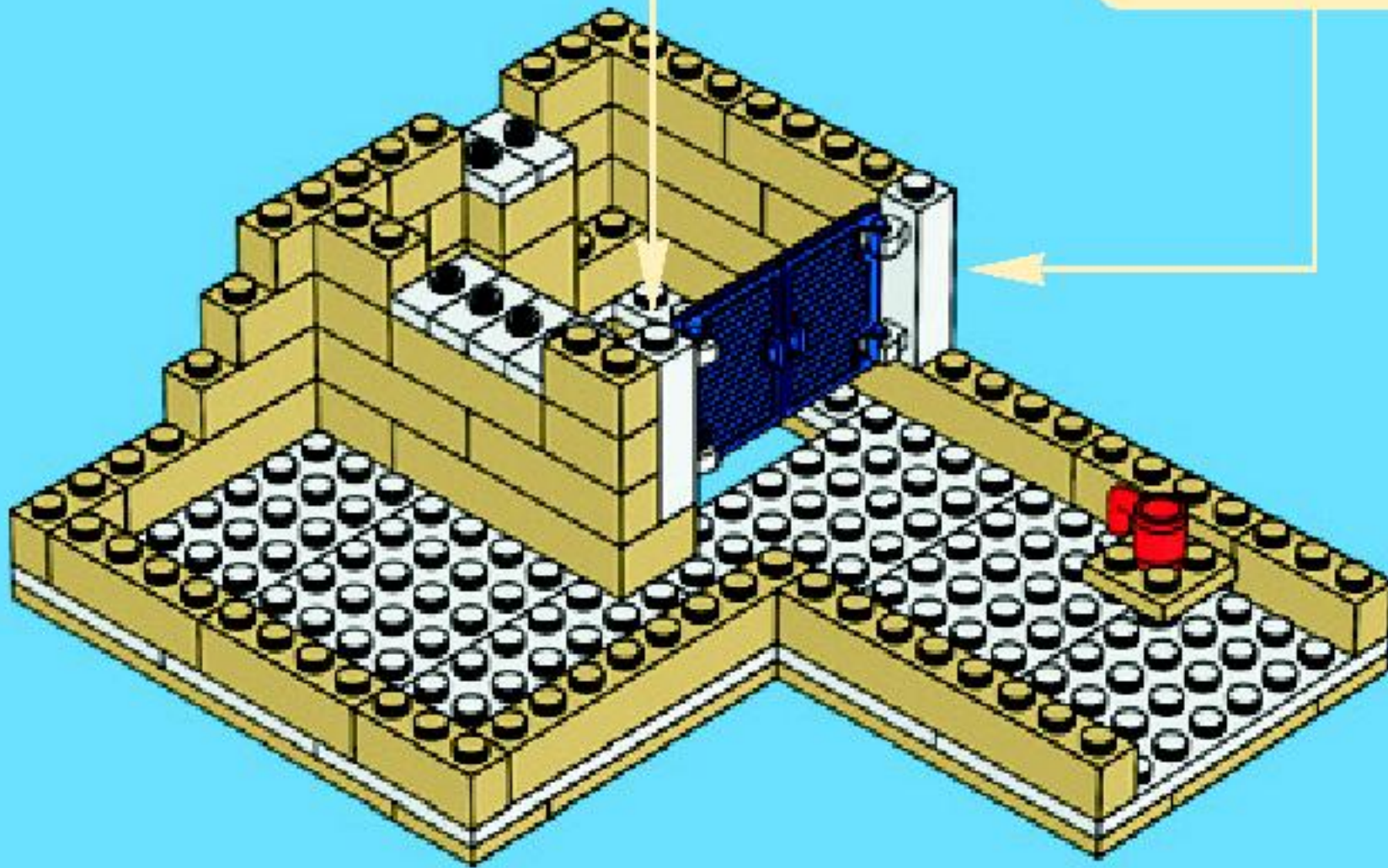
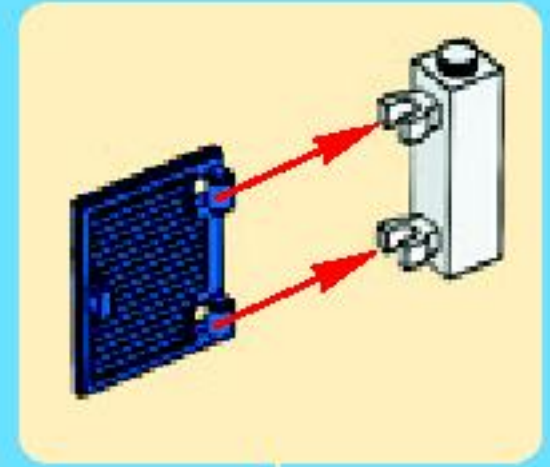
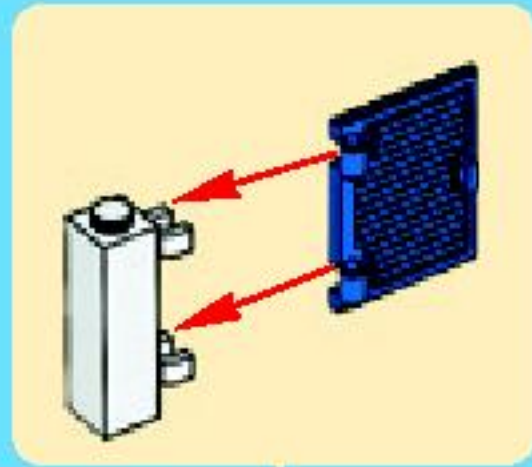

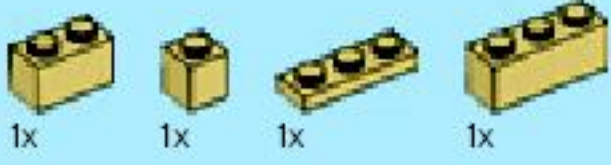

18

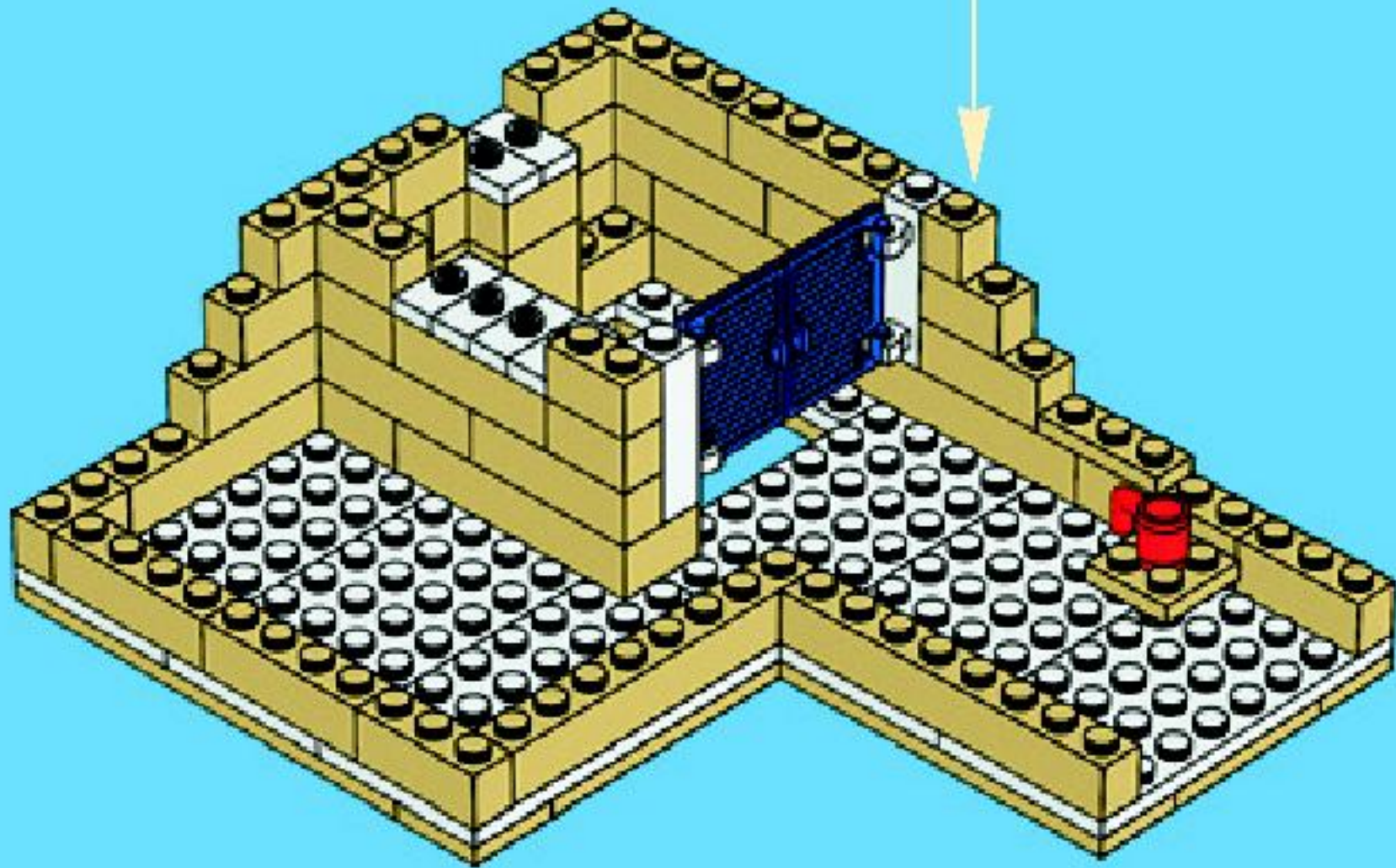
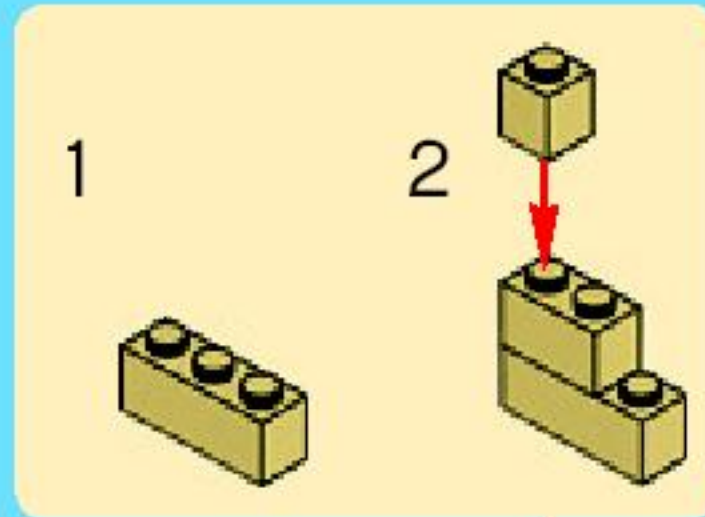

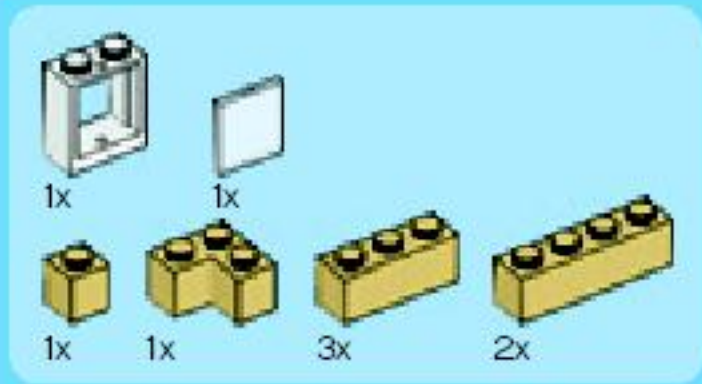

19

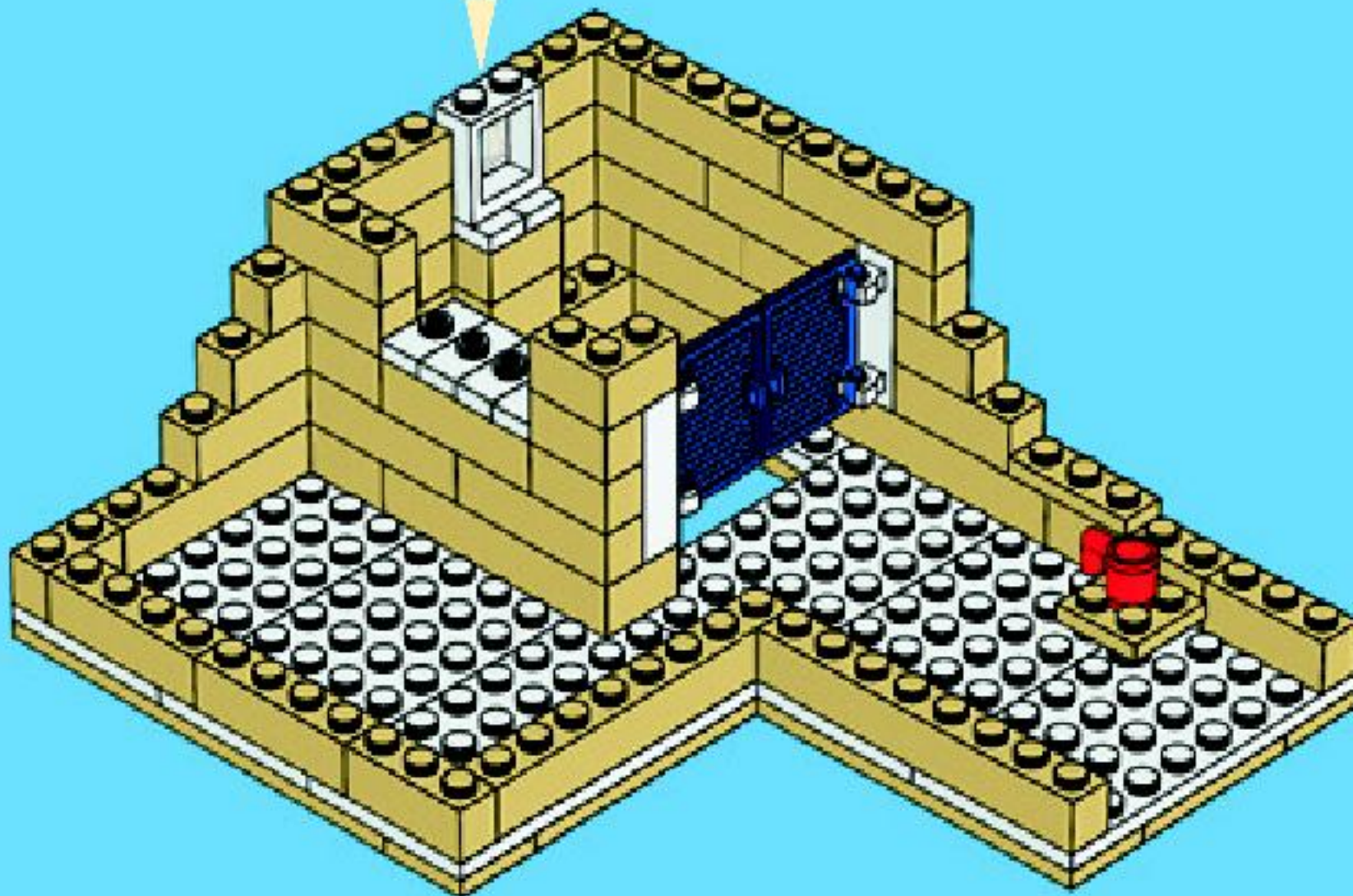
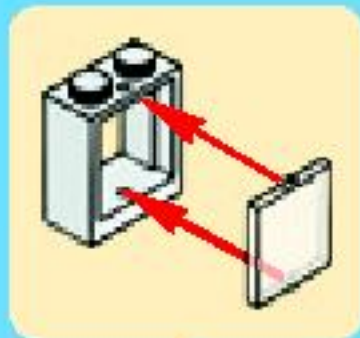

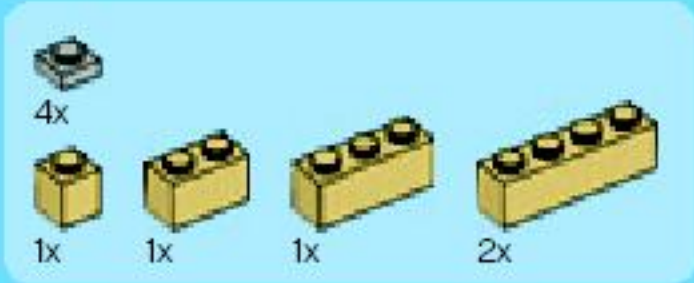

20

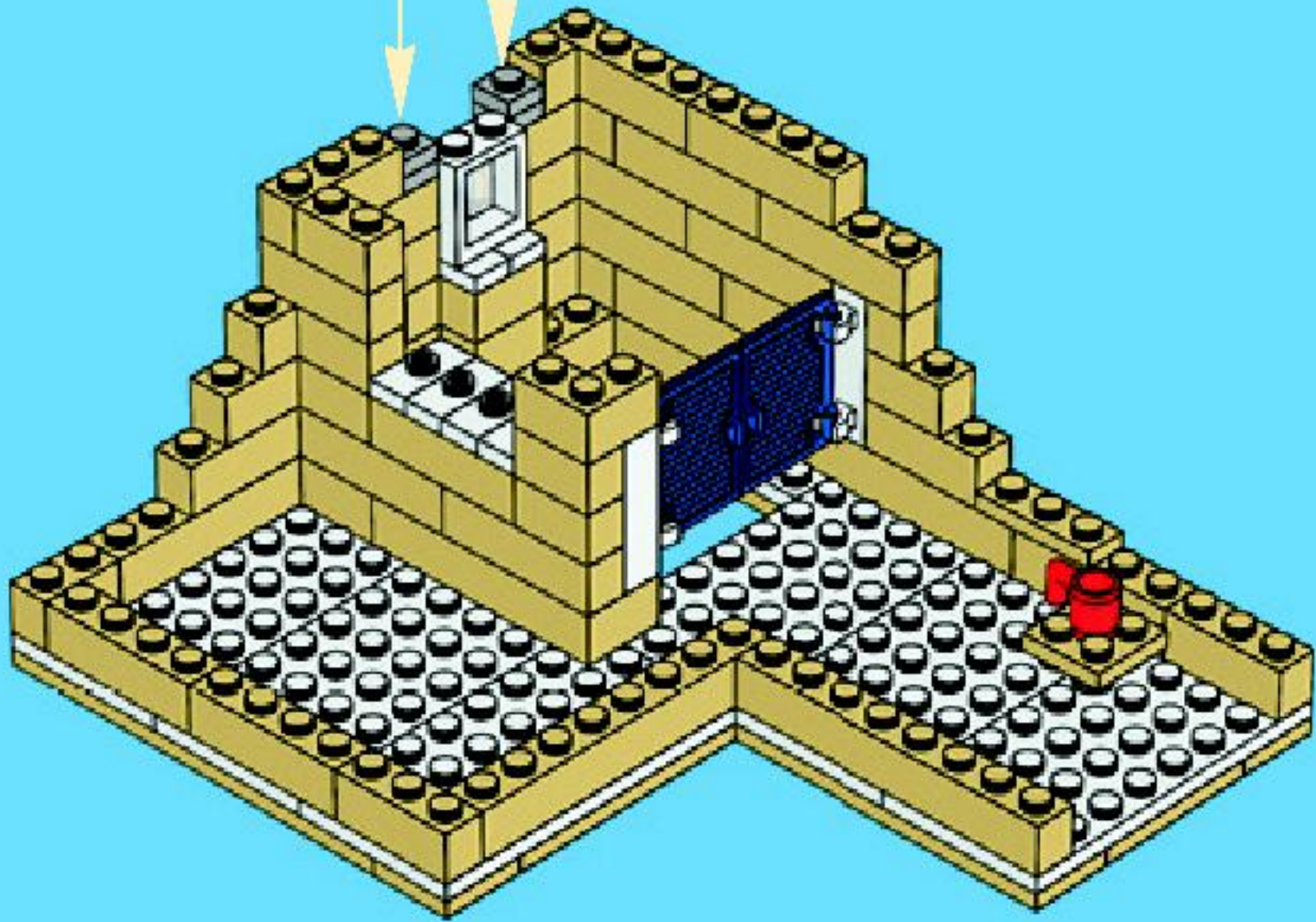
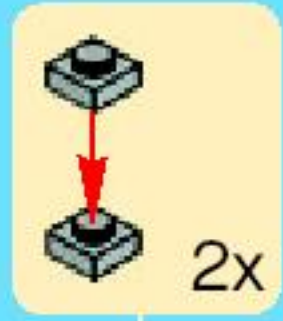

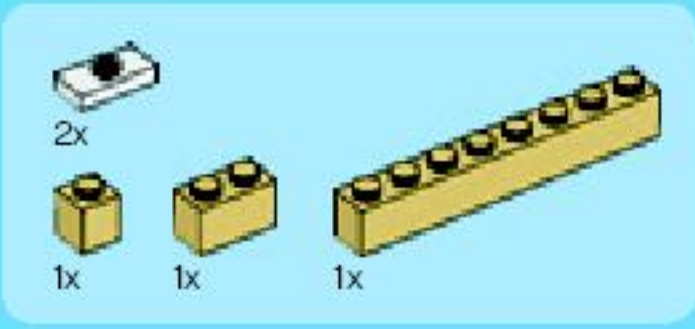

21

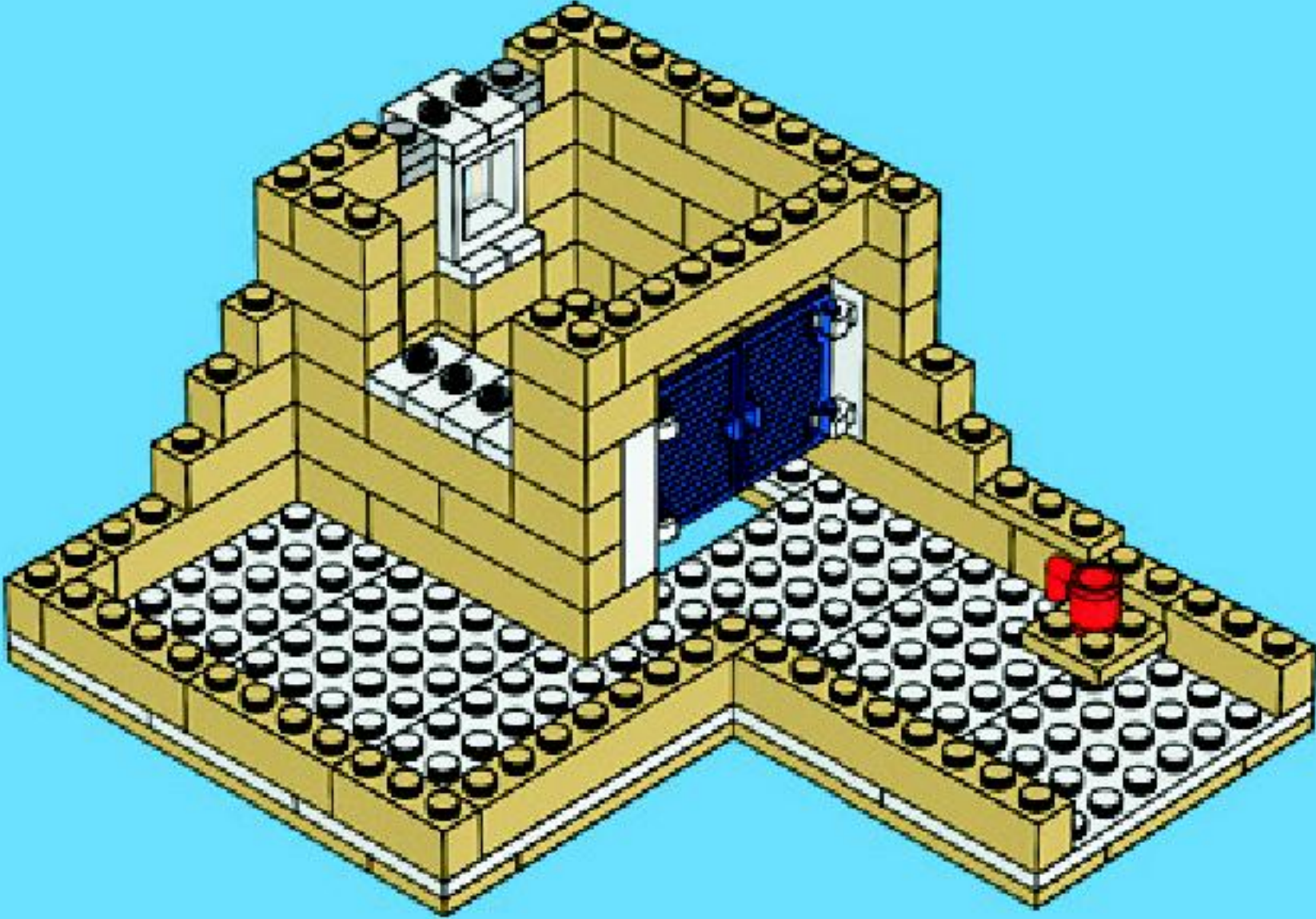

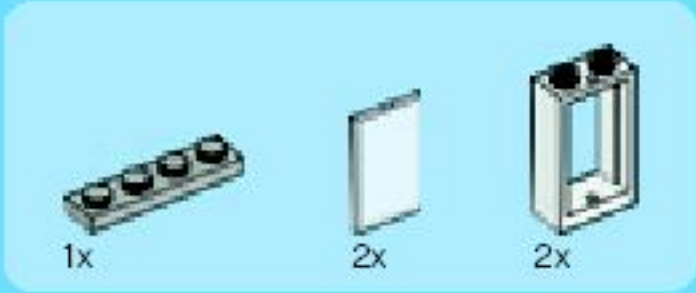

22

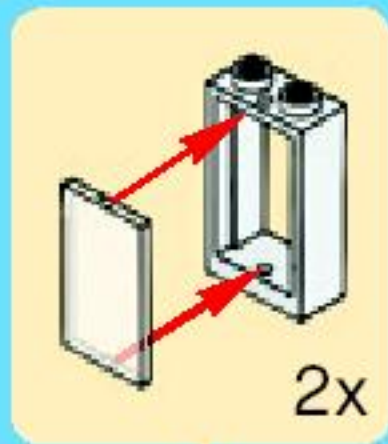



4x



4x

23

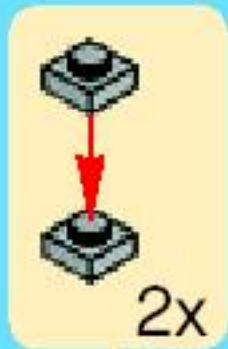

2x



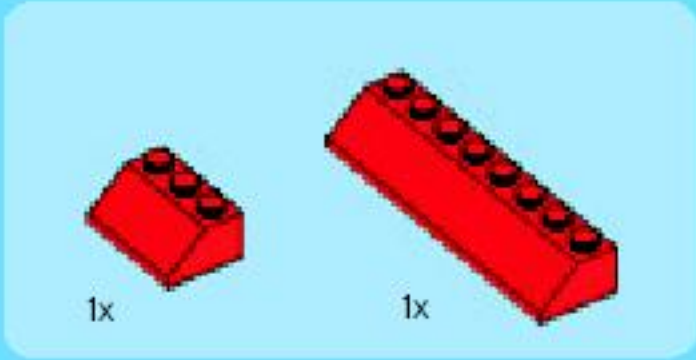

24

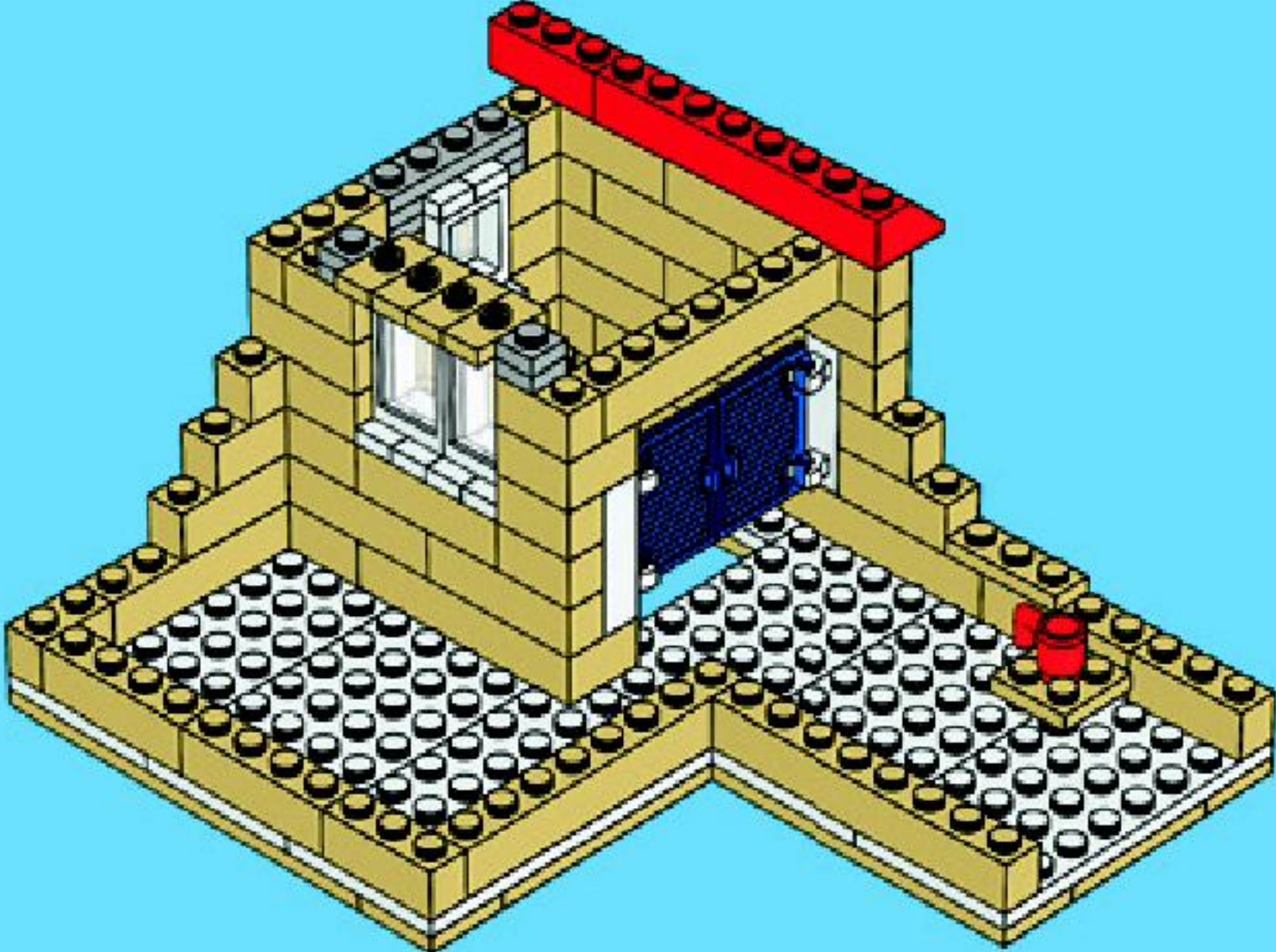

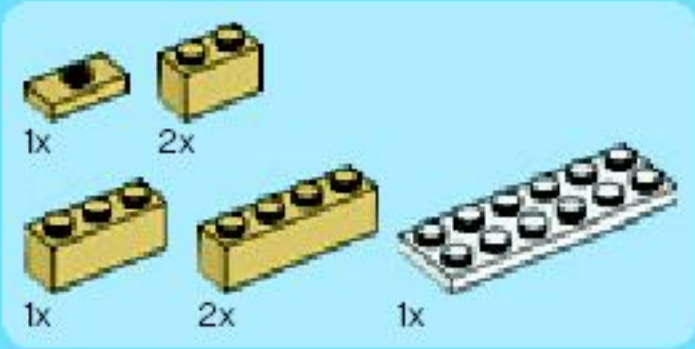

25

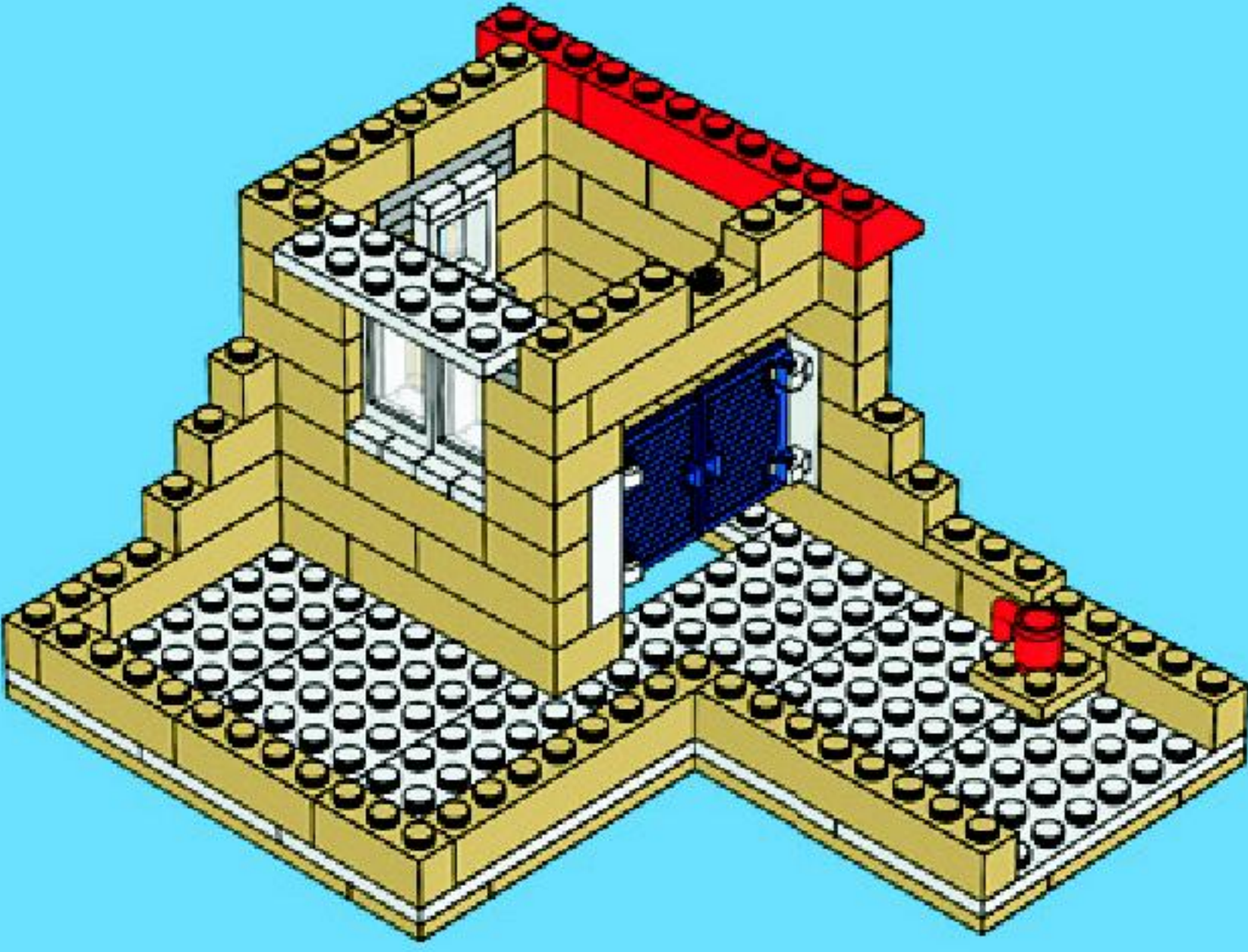

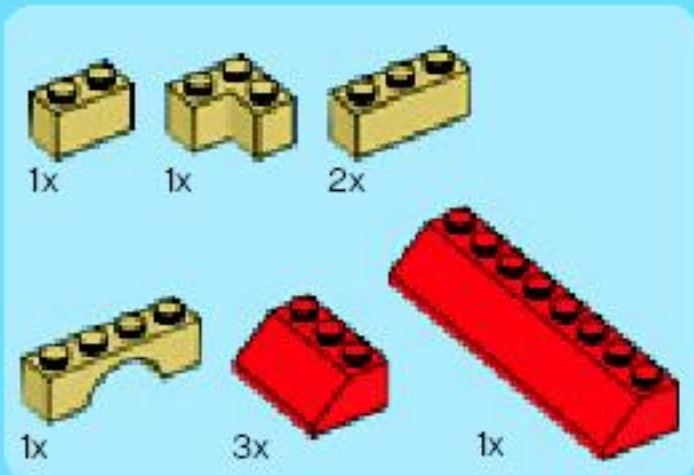

26

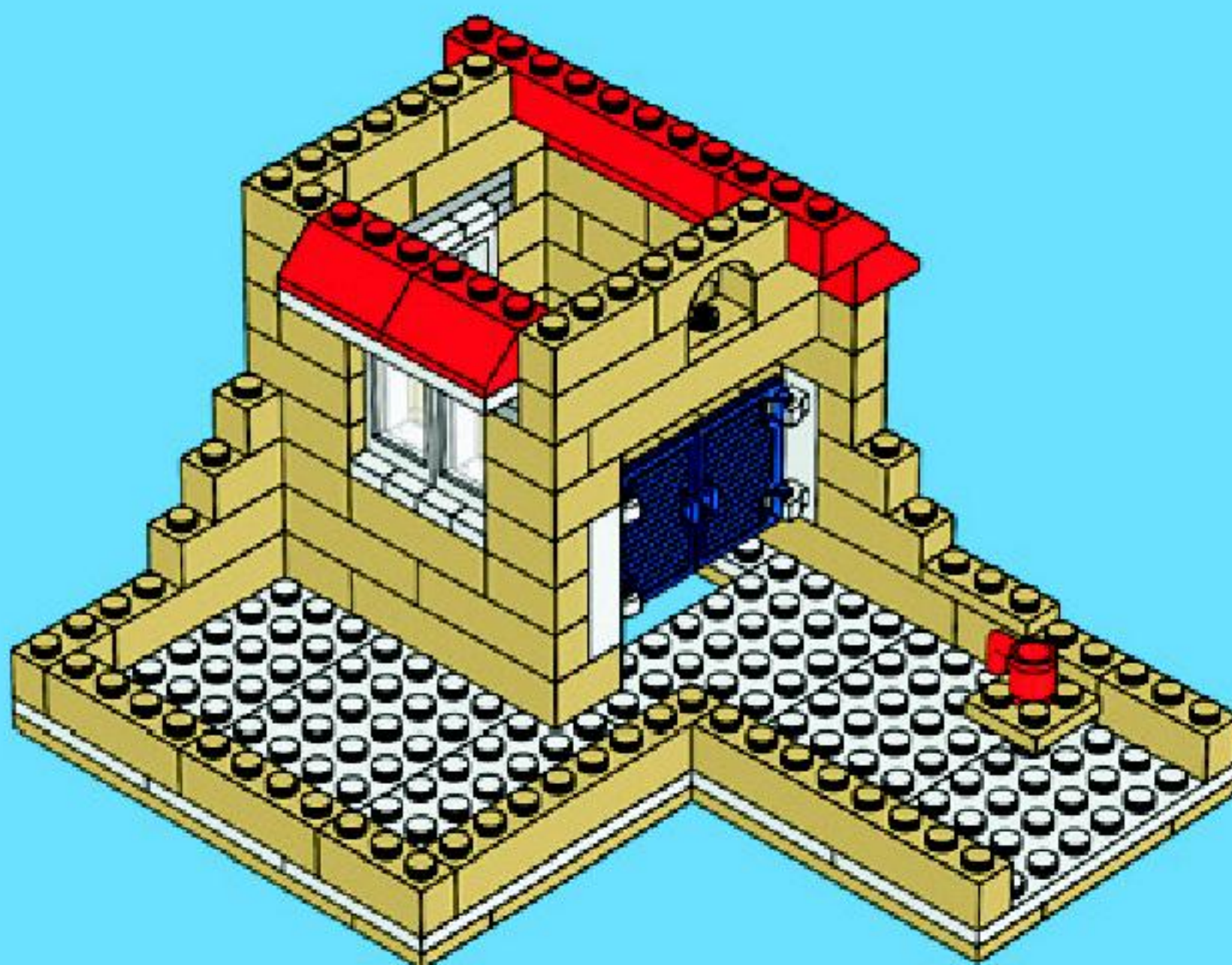

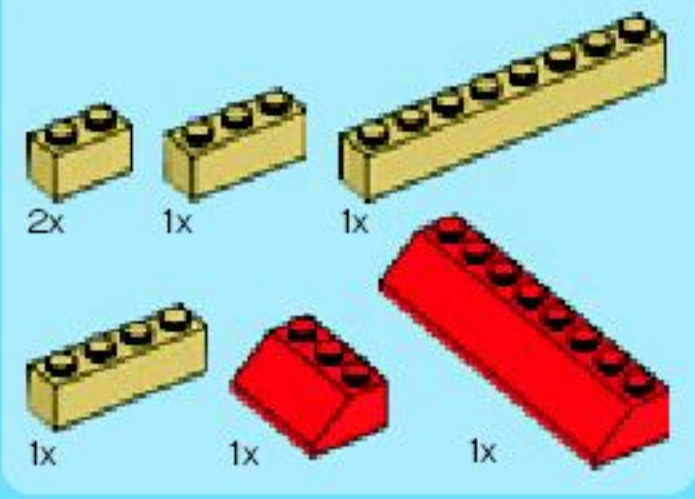

27

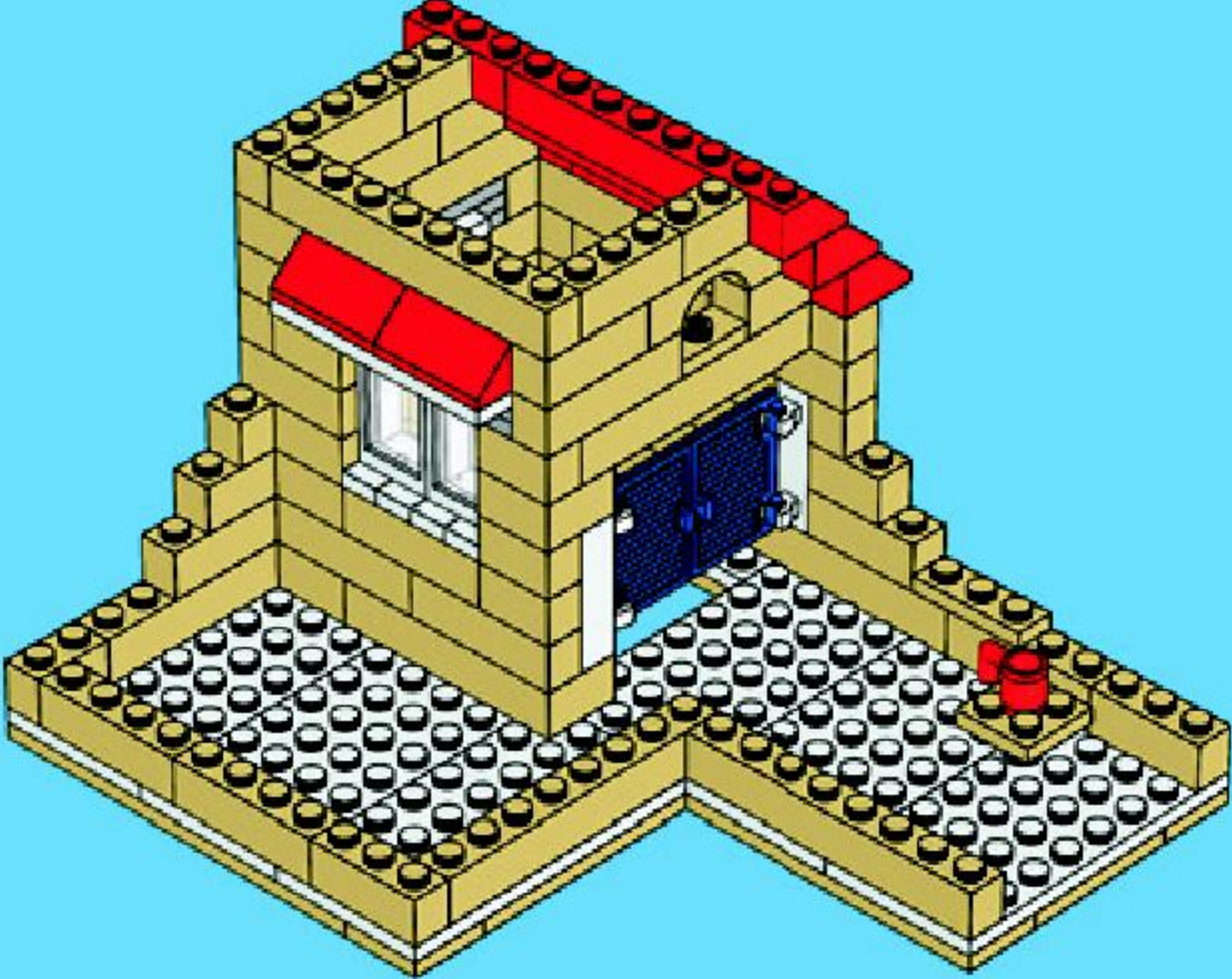

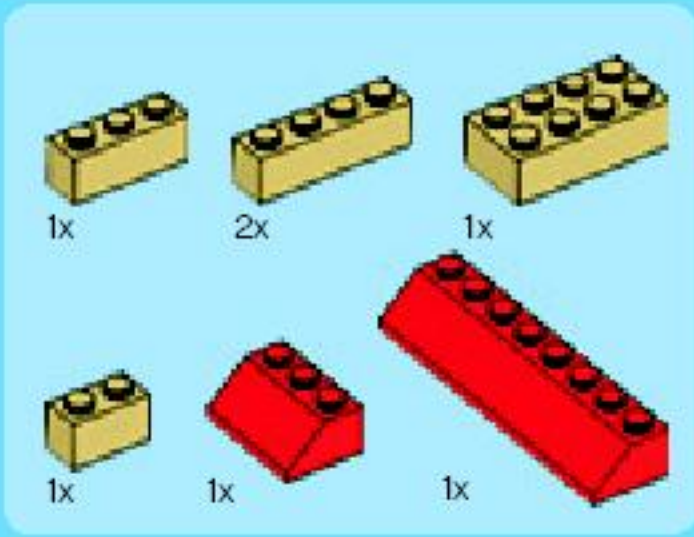

28

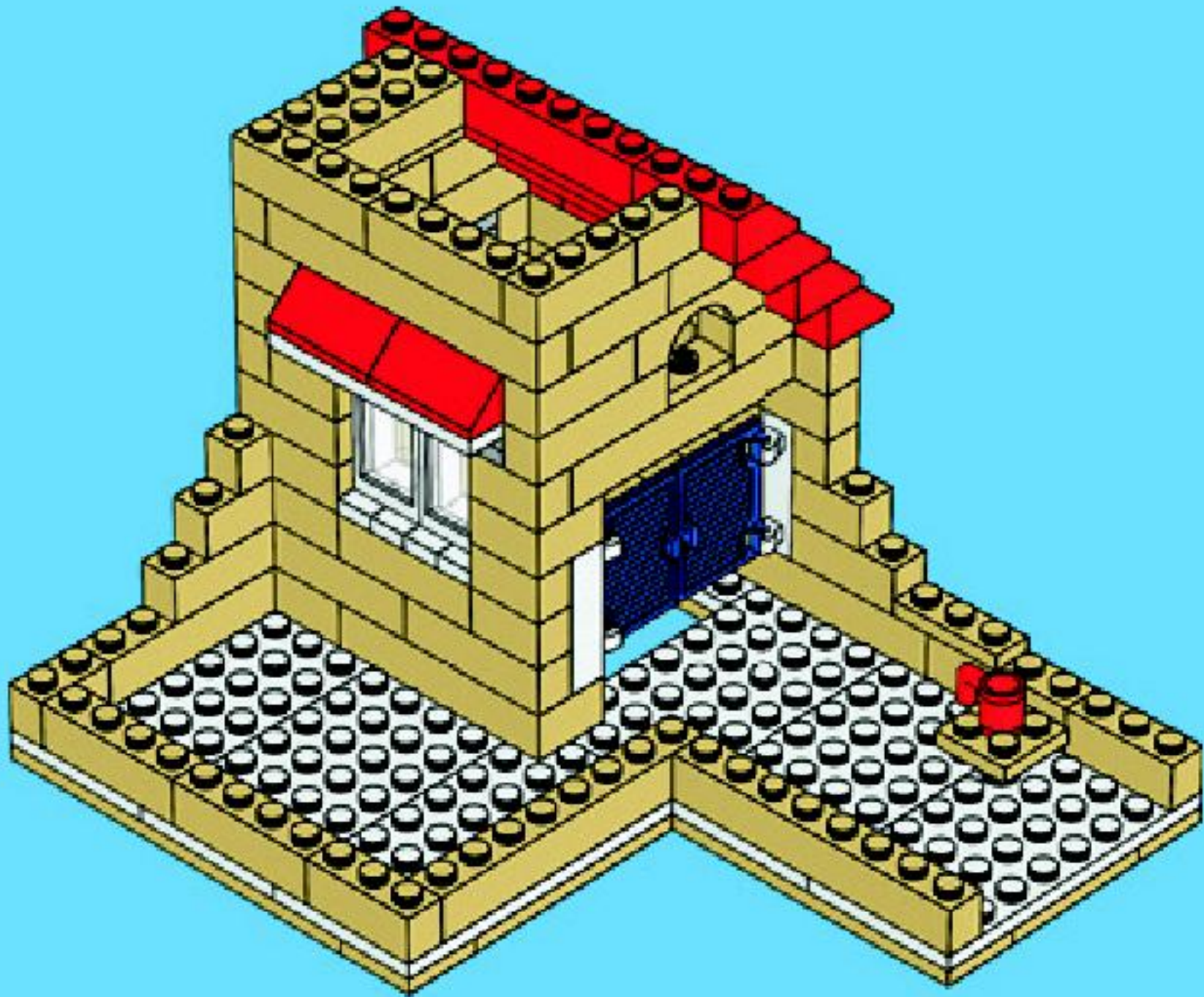

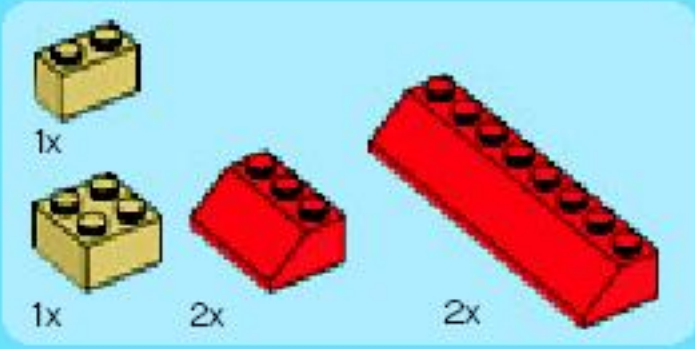

29



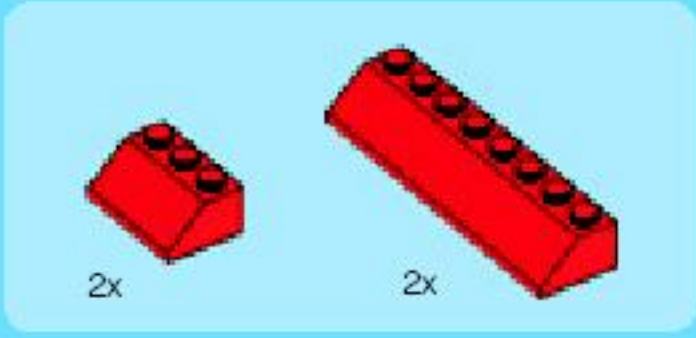

30



- 1x
- 1x
- 1x
- 2x
- 1x
- 1x

31

1

2

3

4



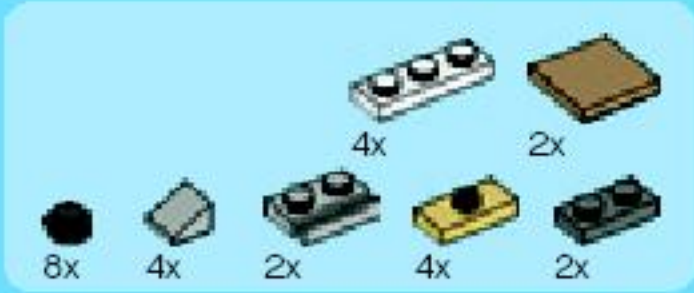



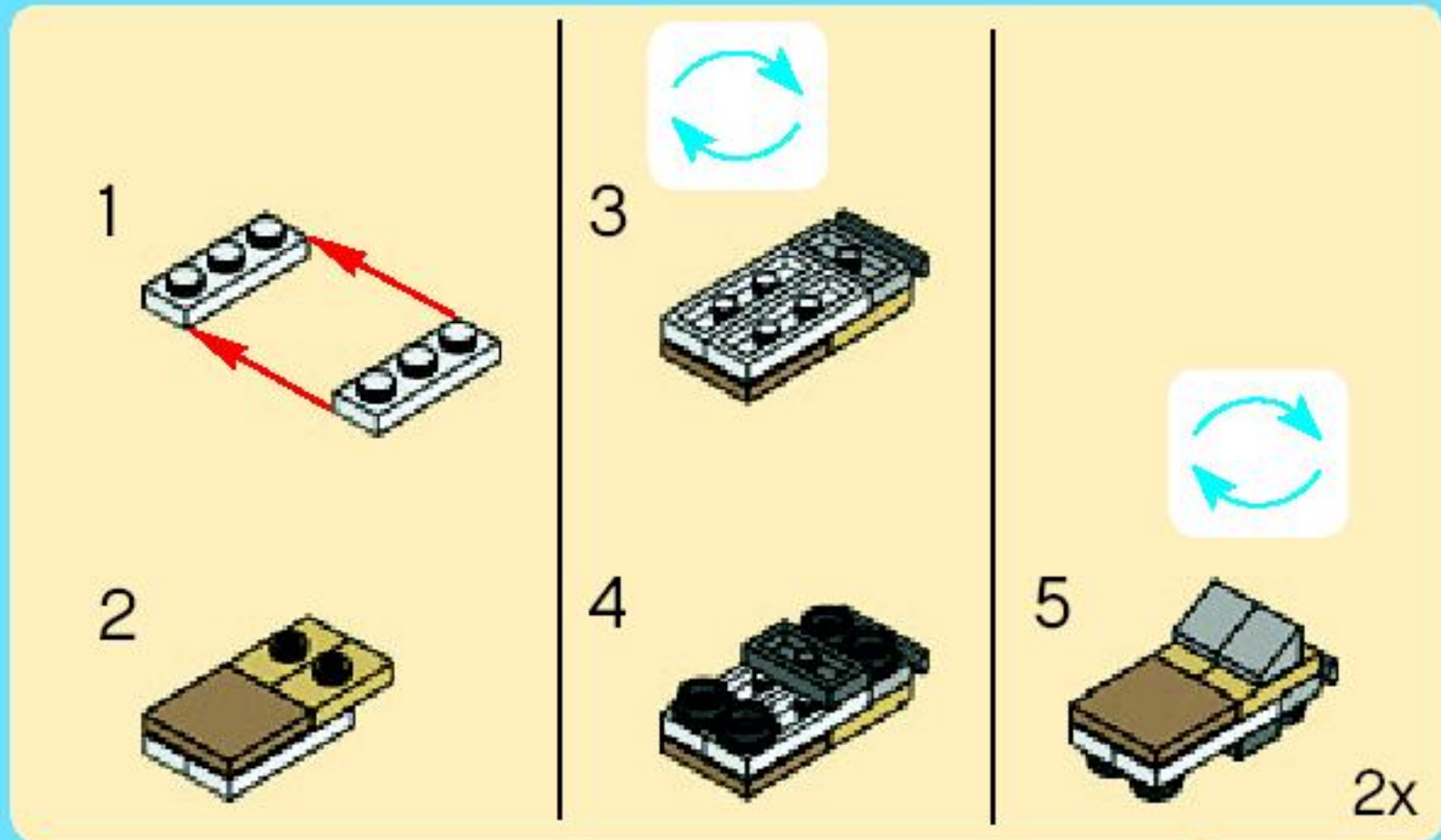

32



- 
1x
- 
5x
- 
4x
- 
1x
- 
2x
- 
1x















33

- 1 
- 2 
- 3 
- 4 



- 1x 4504369
- 3x 306201
- 2x 614101
- 3x 407001
- 1x 4518400
- 2x 4224792
- 4x 302301
- 25x 379401
- 6x 362301
- 5x 4249112
- 4x 4550711
- 5x 4521210
- 6x 4536521
- 1x 4530590
- 3x 4541956
- 1x 302201
- 1x 302101
- 1x 302001
- 2x 379501
- 5x 366601
- 4x 346001
- 1x 303401
- 3x 4500878
- 7x 303501
- 1x 4144012
- 12x 4216581
- 2x 421166
- 3x 421151
- 4x 421180
- 4x 421152
- 7x 4216668
- 3x 421201
- 5x 421204
- 1x 4211211
- 2x 4168345
- 8x 4528357
- 5x 4179826
- 1x 4143005
- 5x 4543998
- 1x 379523
- 4x 4552352
- 1x 389921
- 4x 4529234
- 16x 4218892
- 1x 4121934
- 15x 303921
- 23x 4195081
- 19x 303721
- 23x 4550322
- 1x 4528550
- 3x 4525464
- 4x 614124
- 8x 4507045
- 1x 474026
- 1x 4282860
- 6x 4159553
- 5x 4125253
- 7x 4114026
- 6x 4113917
- 21x 4155708
- 2x 4114077
- 20x 4113915
- 56x 4109995
- 2x 4112980
- 17x 4124455
- 1x 4159279
- 1x 4114064
- 35x 4162465
- 32x 4113916
- 23x 4112982
- 15x 4159774
- 3x 4141533
- 7x 4522675
- 13x 4114306
- 6x 4159739
- 3x 4114319
- 1x 4181134
- 3x 4550323
- 3x 4118744
- 2x 4185177
- 5x 4550324
- 7x 4544139
- 10x 4121921
- 4x 4113233
- 8x 4114084
- 2x 4118790
- 2x 4114309
- 1x 4113993
- 4x 4124067
- 1x 4114324
- 4x 4143409
- 9x 4249019

-  10x
614126
-  2x
459926
-  1x
4526982
-  1x
614126
-  5x
4529239
-  22x
4183133
-  15x
4211412
-  11x
4521921
-  37x
4211415
-  9x
4211399
-  1x
4211398
-  2x
4211451
-  2x
4211804
-  2x
4211568
-  5x
4211414
-  3x
4211350
-  3x
4211413
-  2x
4211679
-  8x
4211389
-  15x
4211388
-  6x
4211428

-  2x
4211394
-  6x
4211387
-  7x
4211386
-  1x
4550325
-  2x
4211437
-  4x
4211410
-  2x
4211628
-  2x
4211356
-  2x
4211549
-  4x
4211481
-  3x
4211397
-  4x
4211396
-  4x
4211445
-  4x
4211498
-  3x
4519930
-  2x
4211393
-  2x
4211044
-  3x
4211098
-  3x
4211060

-  11x
4210636
-  32x
4210848
-  10x
4211052
-  2x
4211055
-  13x
4211063
-  2x
4211043
-  7x
4211088
-  2x
4211104
-  3x
4211103
-  8x
4211100
-  1x
4211002
-  2x
4211008

-  6x
306540
-  1x
3001140
-  1x
4187750
-  5x
4552035
-  6x
4536998
-  1x
4552033
-  2x
4508261
-  4x
4244369
-  2x
4222960
-  1x
4287800

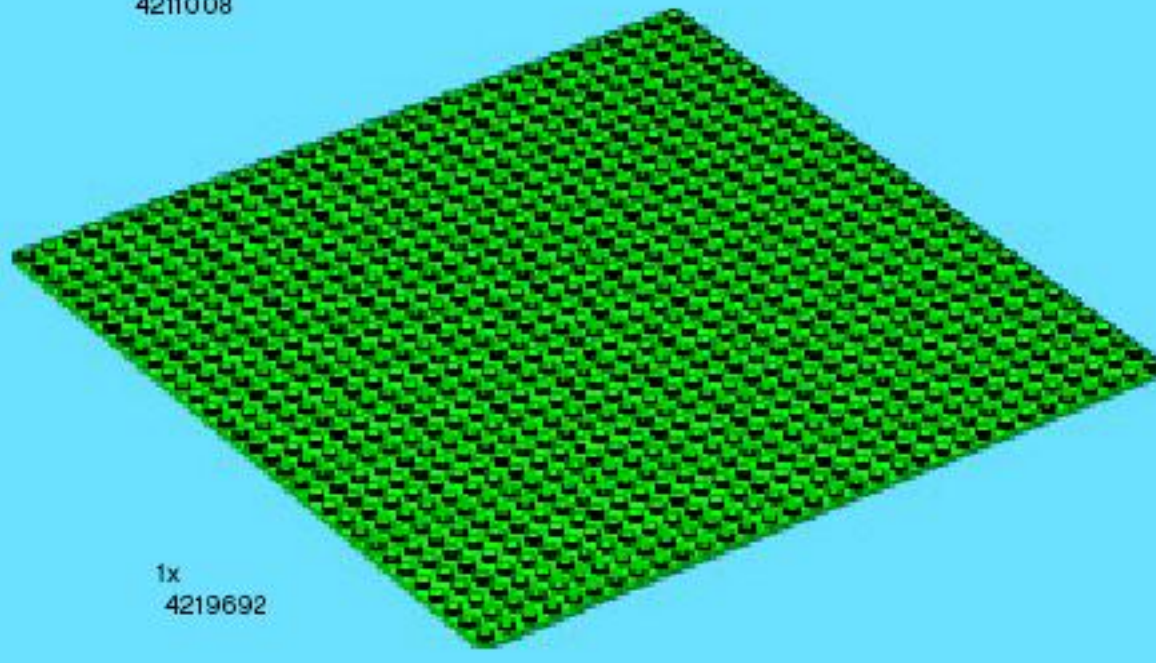

Customer Service
 Kundenservice
 Service Consommateurs
 Servicio Al Consumidor
www.lego.com/service or dial
 : 00800 5346 5555
 : 1-800-422-5346

6751



6752



6754



6753





6741



6745



6747



6742



6743

FREE! GRATIS! GRATUIT!



www.LEGOclub.com



00800 5346 5555

1-866-534-6258 • 1-877-518-5346

US & Canada only

Canada seulement

* Free phone. Mobile charges may apply. * Numéro sans frais. Des frais peuvent s'appliquer avec les téléphones cellulaires. * Gebührenfrei, Kosten für Anrufe aus Mobilfunknetzen können abweichen. * Gratis telefonnummer vanvast lijn. * Het vrot gratis nummer, van du ringer fra PostTelefon. * Ted gratis, når du ringer Primes Fast telefon.



Visit the world's biggest LEGO shop!

www.LEGOshop.com

YES! I want to join the LEGO® Club FREE! OUI! Je veux m'abonner au Club LEGO® GRATUITEMENT! Ja! Ich möchte Mitglied im kostenlosen LEGO® Club werden. Ja! Ik wil graag GRATIS lid worden van de LEGO® Club. Ja! Jeg ønsker å melde meg inn i LEGO® Club gratis! Ja! Jag vill gå med i LEGO® Club GRATIS!

First name - Prénom
Vorname - Voornaam
Fornavn - Fornamn

Last name - Nom de famille
Name - Achternaam
Etternavn - Eftersmann

Date of Birth - Date de naissance
Geburtsdag - Geboortedatum
Fødselsdato - Fødselsdato

Boy - Garçon
Junge - Jongen
Gutt - Pojke

Girl - fille
Mädchen - Meisje
Jente - Piken

Street - Adresse
Strasse, Hausnr.
Straat, huisnr. - Adress

City - Ville
Ort - Woonplaats
Poststad - Postort

State
Prov.
County

Zip/Postcode - Code Postal
PLZ - Postcode - Postnummer

Country
Pays - Land

Please tick below if you would like to receive other communication from the LEGO Group. Si vous souhaitez recevoir d'autres communications de la part de la compagnie LEGO, veuillez cocher ici. Als u graag verdere informatie van de LEGO Groep wilt ontvangen, kruis dan o.v.v. dit vakje aan. Ich möchte über Produkte, Angebote, Aktionen und weitere interessante Themen von der LEGO Gruppe informiert werden* (bitte ankreuzen). Om du vil få annen informasjon fra LEGO Gruppen, slått kryss her. Hvis du ønsker å motta annen informasjon fra LEGO Gruppen, merker du av her.

Post - Poste Email - Courriel
Per Post Per E-Mail
 Ich möchte über Produkte, Angebote, Aktionen und weitere interessante Themen von der LEGO Gruppe informiert werden* (bitte ankreuzen). Per Post Per E-Mail

Mail to: / Poster à:

BG29

LEGO® Club
P.O. Box 1157
Enfield, CT USA
06083-1157

Mail to:

BI09U

LEGO® Club
33 Bath Road
Slough SL1 3UF
United Kingdom

Per Post on:

BI09C

LEGO® Club
Postfach 14 15
D-36243 Niederrhein

Stuur op naar:

BI09N

LEGO® Club
Postbus 40250
3504 AB Utrecht

Send til:

BI09O

LEGO® Club Norge
Postboks 58
1314 Vøyenenga

Skicka till:

BI09S

LEGO® Club Sverige
Ubox 841
202 29 Malmö

EN The English language version of the magazine can only be mailed to addresses in the US, Canada, the UK, and Republic of Ireland. Club membership is valid for two years and includes free copies of the LEGO Club Magazine. In the US and Canada please allow up to 6 weeks for delivery of your first magazine. In the UK and Republic of Ireland please allow six to 14 weeks for delivery of your first magazine. By signing this form you consent the LEGO Club to use your child's data for LEGO mailings. The data will only be used for LEGO mailings and will not be sold, rented or otherwise disclosed to any company outside the LEGO Company except for disclosure to companies acting as our agents to help us provide services requested by the child. This coupon is valid for one free membership per person, group or organisation. Photocopied coupons are accepted. **FR** La version française du magazine peut être postée uniquement au Canada. L'abonnement est valide pour 2 ans et inclut des exemplaires gratuits du Magazine LEGO. Aux E.-U. et au Canada, allouer 6 semaines pour la livraison initiale. En remplissant ce formulaire, vous consentez à ce que LEGO utilise les informations de votre enfant pour des envois postaux de LEGO. L'information sera utilisée uniquement pour des envois postaux par LEGO et ne sera en aucun cas, vendue, louée, échangée ou divulguée à d'autres compagnies autres que la compagnie LEGO, à l'exception des compagnies affiliées qui nous procurent des services auxquels le enfant en a fait la demande. **DE** Das deutschsprachige LEGO Club Magazin kann nur an Adressen in Deutschland, Österreich und der Schweiz verschickt werden. Die kostenlose Mitgliedschaft beinhaltet die Zusendung des LEGO Club Magazins und endet nach zwei Jahren. Mit der Anmeldung gehen Sie keine Verpflichtungen ein. Es kann bis zu drei Monate dauern, bis das erste Magazin zugestellt wird. Mit Ihrer Unterschrift erklären Sie sich damit einverstanden, dass die Daten Ihres Kindes zum Zweck einer LEGO Club Mitgliedschaft von der LEGO Gruppe gespeichert und verarbeitet werden. Die Daten werden vertraulich behandelt, nicht an Dritte weitergegeben und nicht veräußert. Externe Dienstleister erhalten Ihre Daten nur, soweit es für die Abwicklung von LEGO Kommunikation erforderlich ist. Wenn Sie von uns nicht mehr kontaktiert werden möchten, können Sie der Verwendung Ihrer Daten für Werbezwecke widersprechen unter: 00800 5346 5555 (Anruf gebührenfrei, Kosten für Anrufe aus Mobilfunknetzen können abweichen). * Die Einwilligungen kann ich jederzeit (insgesamt oder zum Teil) ohne Einfluss auf die LEGO Club Mitgliedschaft bei der LEGO Gruppe widerrufen. **NL** Het LEGO Club Magazine kan alleen worden gestuurd naar adressen in Nederland. Het lidmaatschap is 2 jaar geldig en geeft recht op toezending van het gratis LEGO Club Magazine. Het eerste magazine zal na 12 tot 14 weken toegestuurd worden. Het lidmaatschap kan op ieder moment opgezegd worden. Door dit formulier te tekenen geeft u de LEGO Club toestemming om bovenstaande gegevens te gebruiken voor het toesturen van LEGO mailings. Uw gegevens worden uitsluitend gebruikt voor mailings van LEGO en zullen niet worden verkocht, verhuurd of op welke wijze dan ook verstrekt aan derden buiten de LEGO Groep, uitzonderd de organisaties die namens ons optreden om de service te verlenen waar uw kind om gevraagd heeft. **NO** Den norske utgaven av magasinet sendes kun til adresser i Norge. Medlemskap i klubben gjelder i 2 år og inkluderer gratisutgaver av LEGO Magazine. Påregnet opp til seks uker leveringstid for første magasin. Ved å undertegne dette skjemaet, gir du ditt samtykke til at LEGO Club kan bruke opplysningene om barnet ditt i LEGO Club forsendelser. Dataene vil utelukkende bli brukt i LEGO forsendelser og vil ikke bli solgt, utleid eller på annen måte gjøres tilgjengelig for selskaper utenfor LEGO gruppen, unntatt selskaper som er våre agenter og som hjelper oss å tilby tjenestene barnet etterspor. Dette skjemaet gjelder for ett gratis medlemskap per person, gruppe eller organisasjon. **SE** Den svenska versionen av tidsningen kan endast skickas till adresser i Sverige. Club-medlemskapet är giltigt i 2 år och innefattar gratis exemplar av LEGO Club Magazine. Vänligen räkna med 6 veckor för leverans av din första tidsning. Genom att skicka in det här formuläret godkänner du att LEGO Club använder barnets uppgifter för LEGO utskick. Uppgifterna kommer bara att användas för LEGO utskick och kommer inte att säljas, hyras ut eller vidarebefordras till något företag som inte tillhör LEGO Gruppen, med undantag av företag som agerar som våra ombud för att tillhandahålla tjänster som barnet har begärt. Den här kupongen gäller för ett gratis medlemskap per person, grupp eller organisation.

Parent's signature - Signature d'un parent - Unterschrift Erziehungsberechtigter/
Handtekening ouders - Foreldres/Paresattes underskrift - Forældres/Förmyndares underskrift

Date
Datum
Dato