

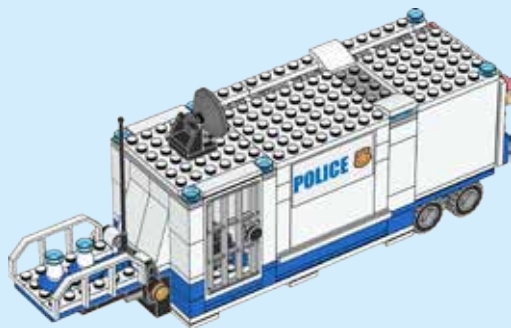

# CITY

60139

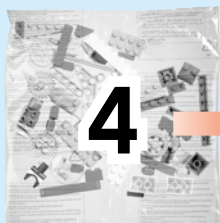

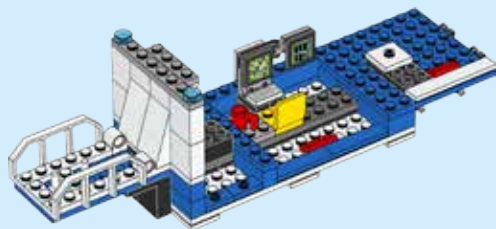
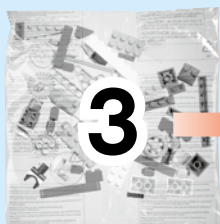

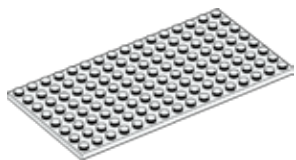

+

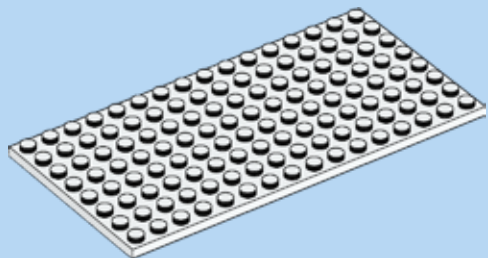
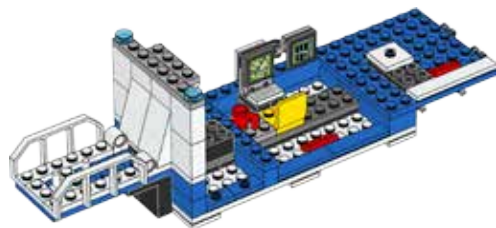

1x

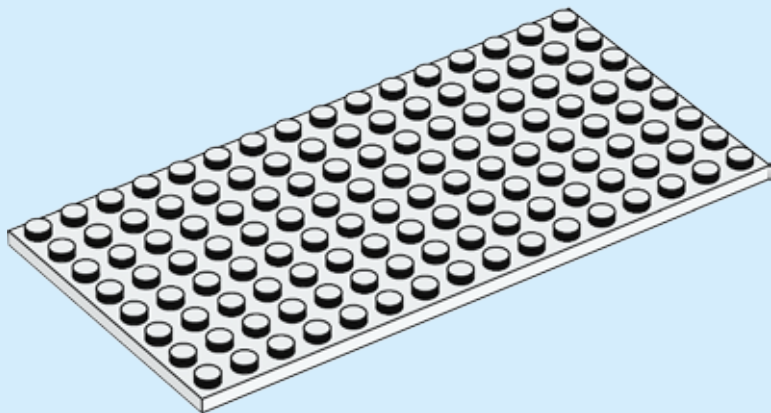

**1**



6x

2

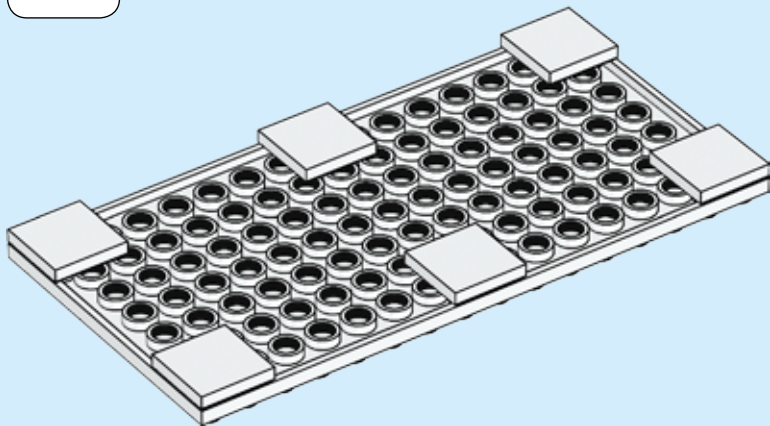
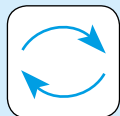

4

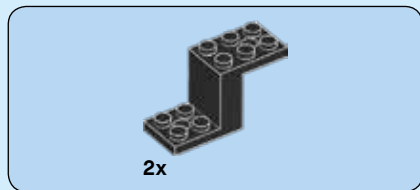

3

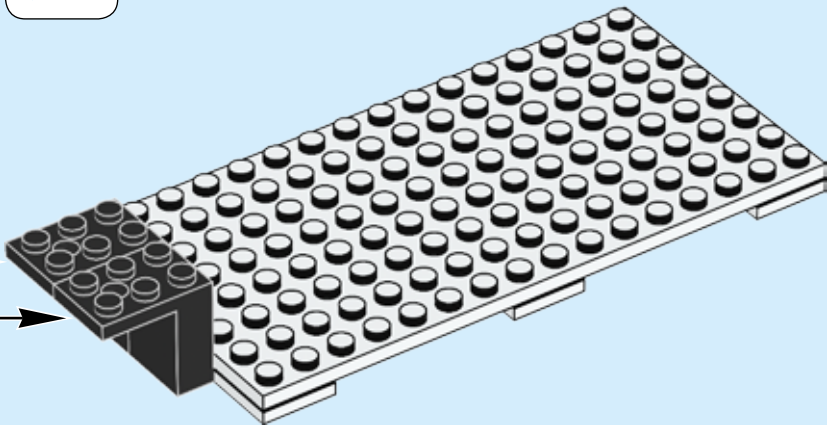
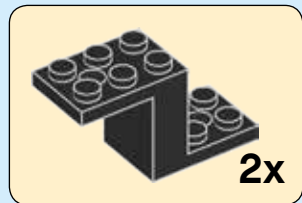
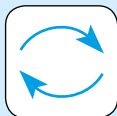

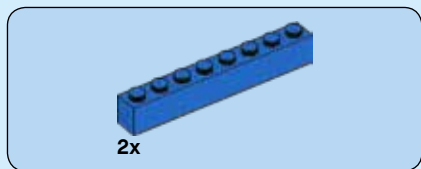

4

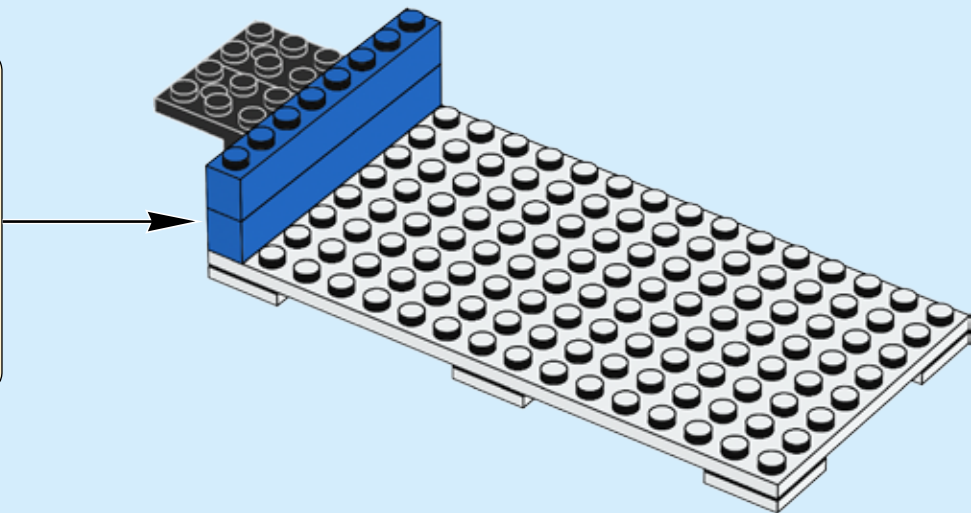
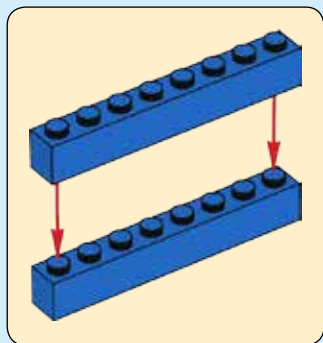



5

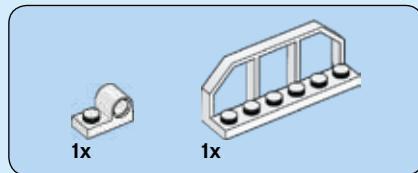
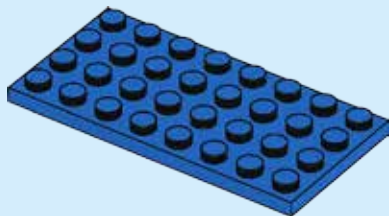

6

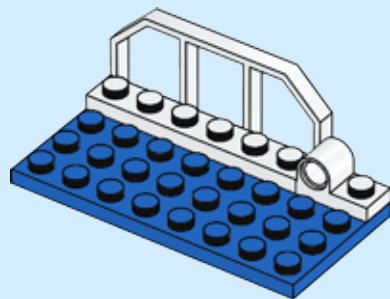



2x

7

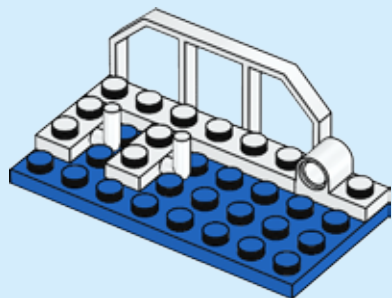

8



1x

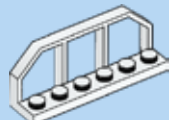

1x

8

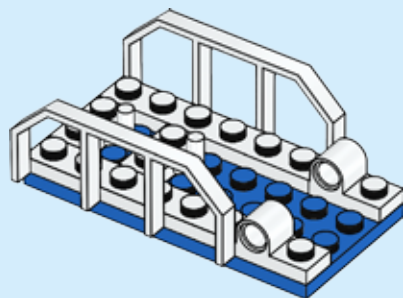



9

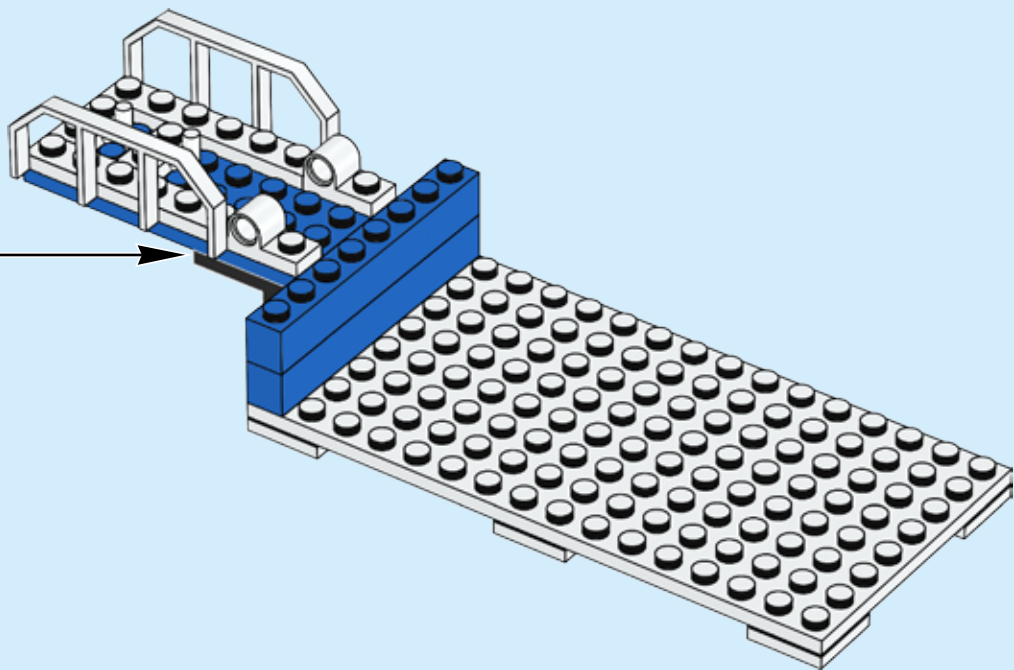

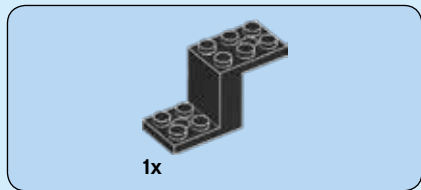

10

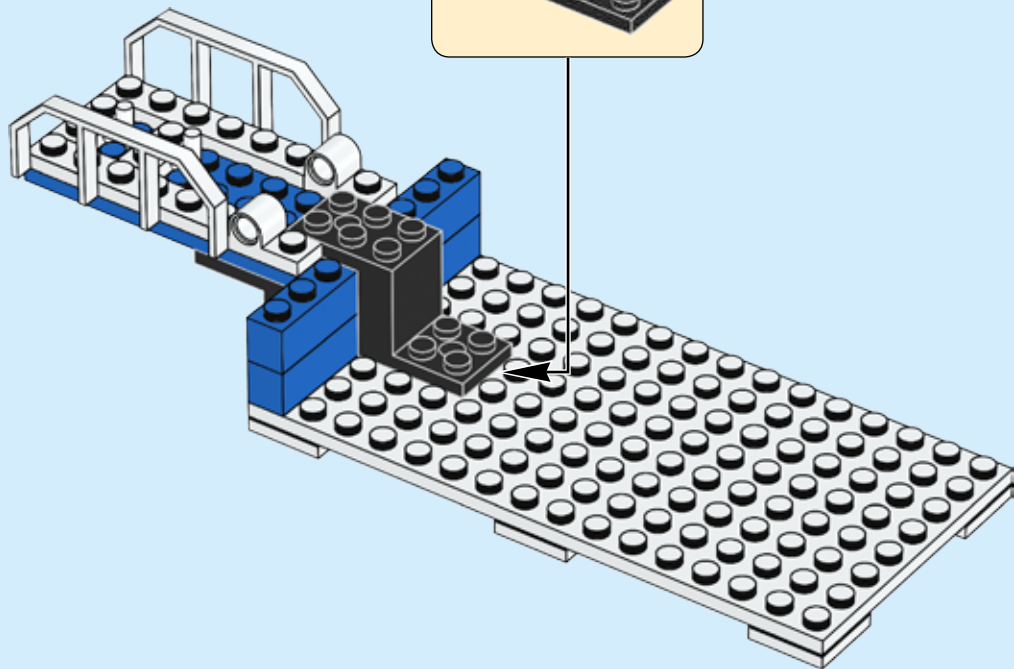
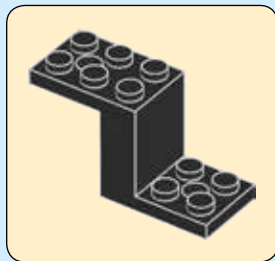



2x

11

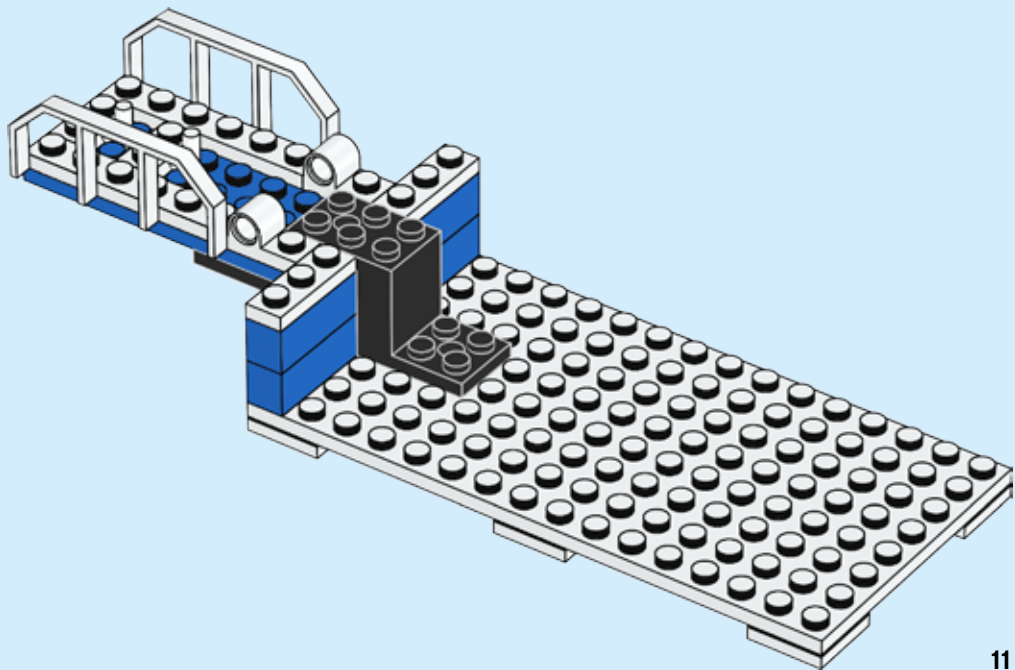

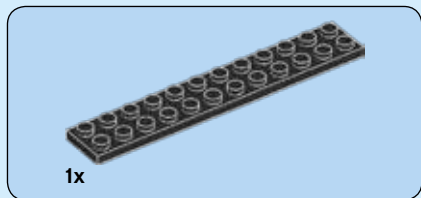

12

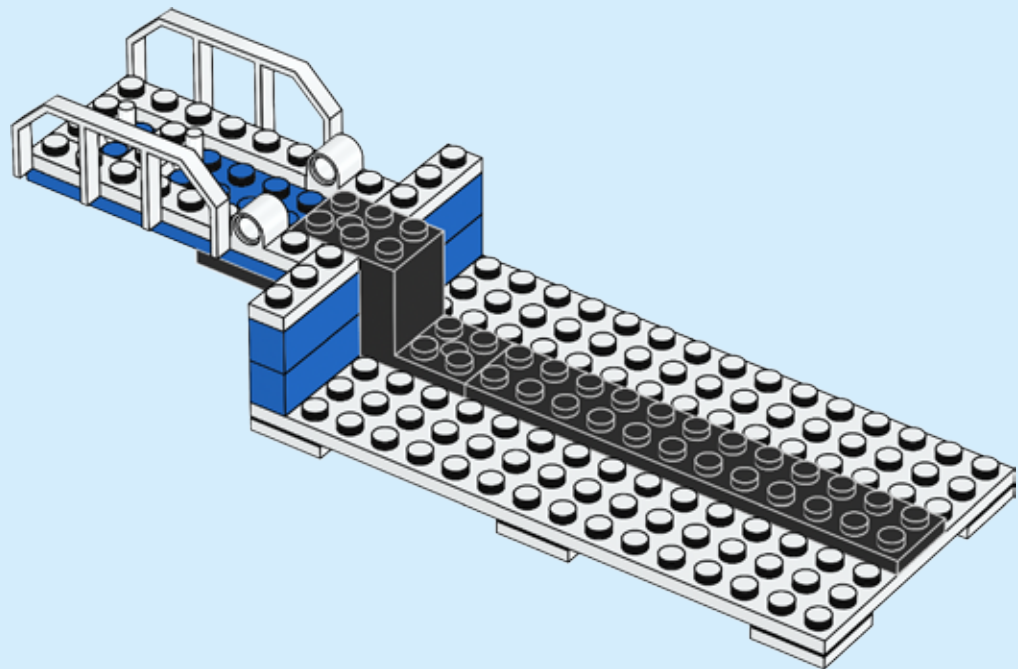

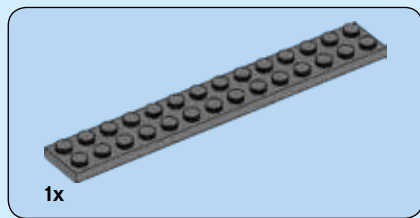

13

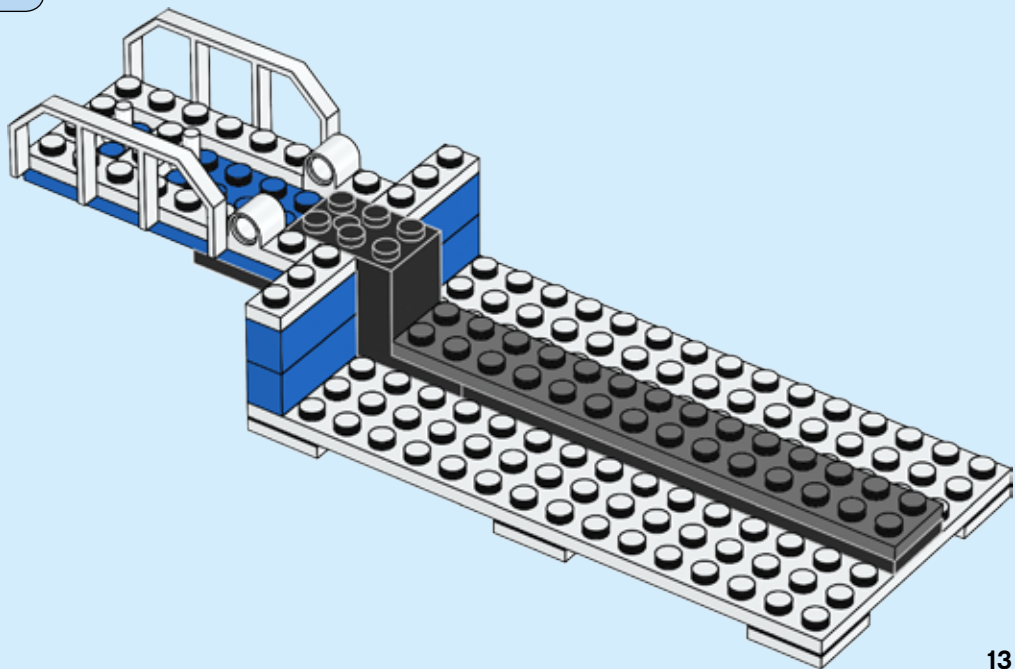



4x

14

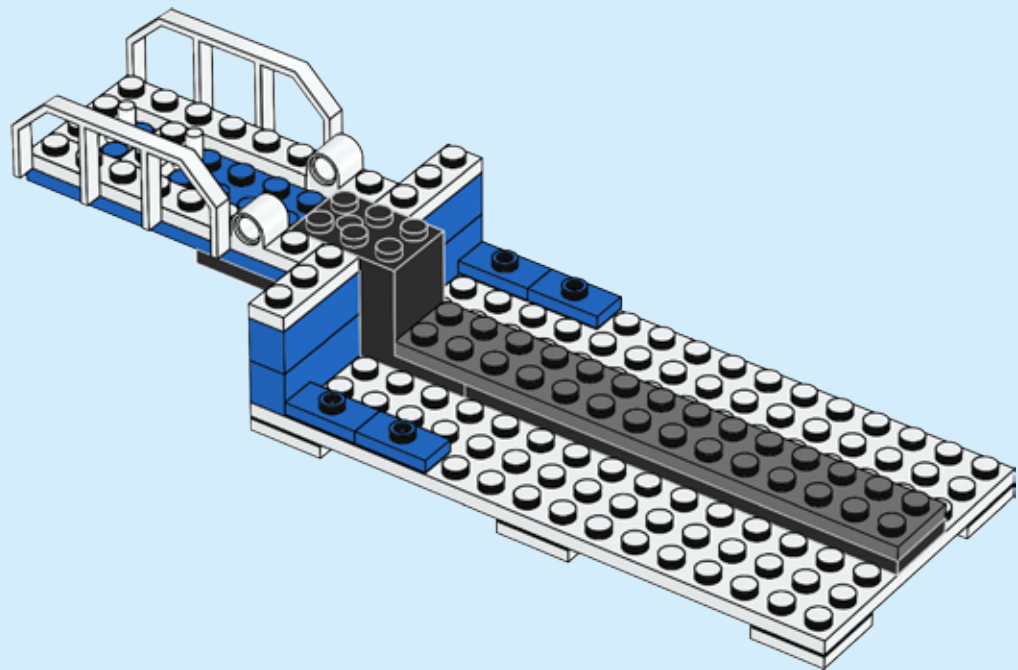

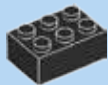

1x



1x

# 15

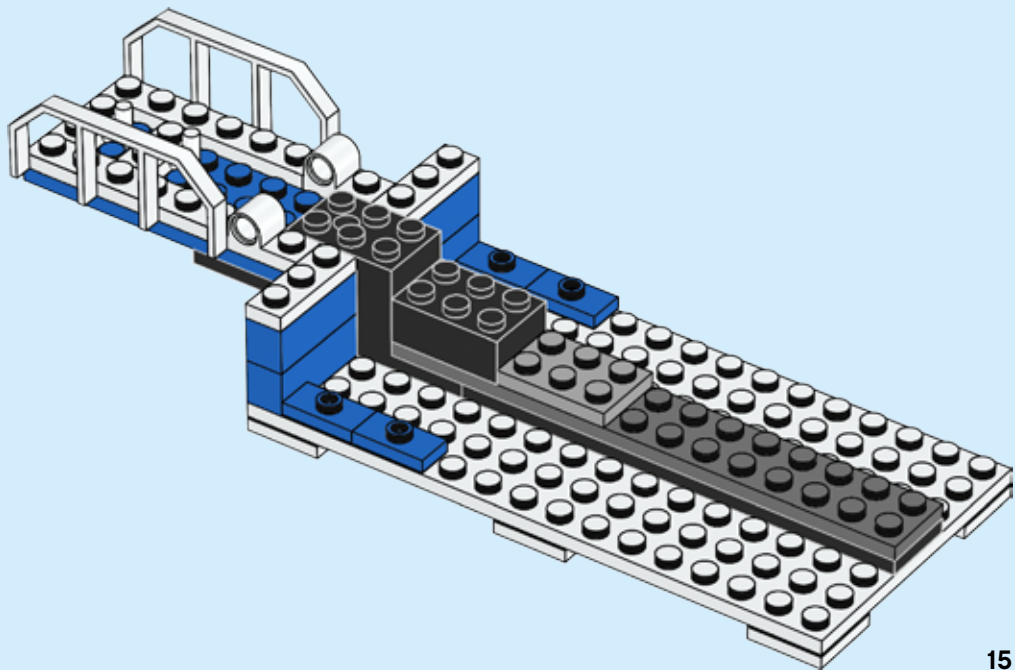



2x

16

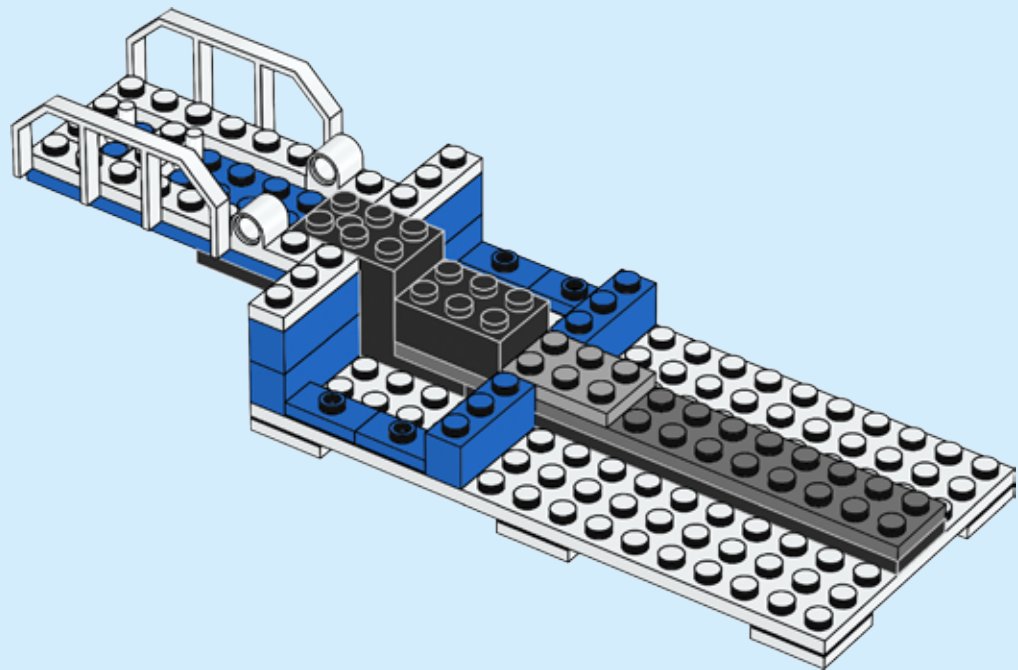



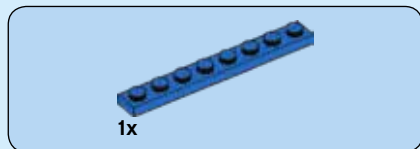

17

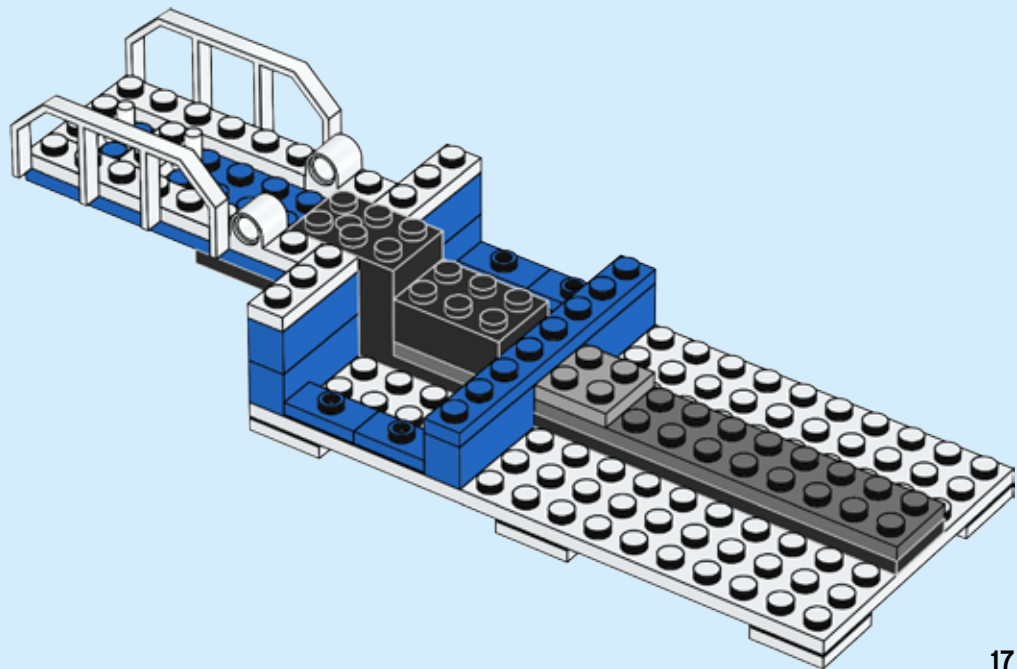

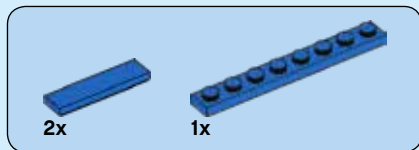

18

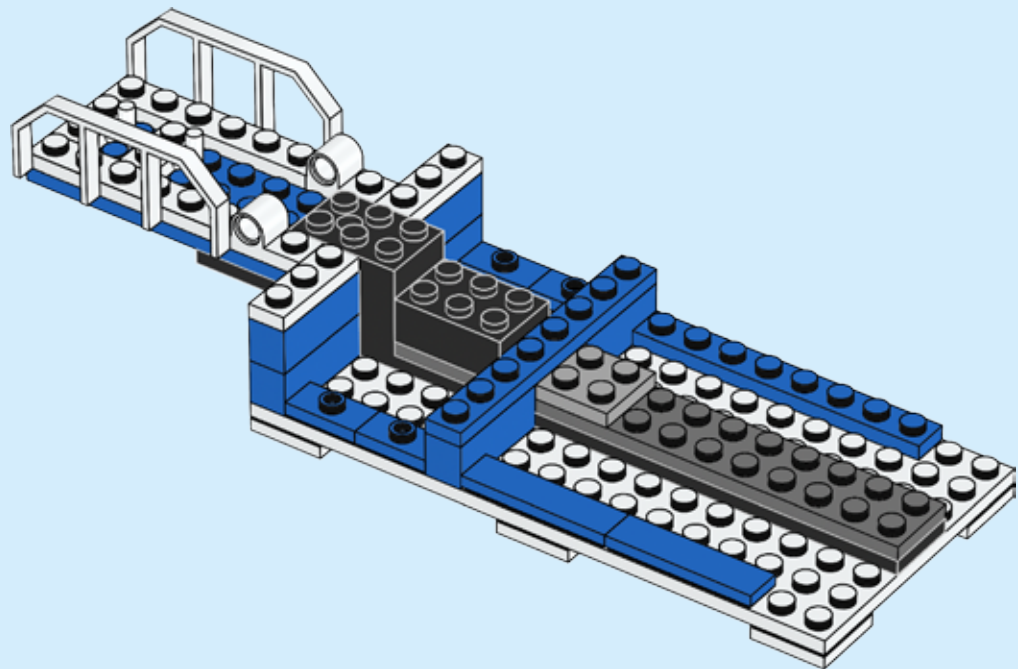

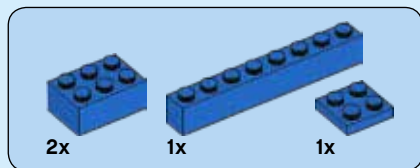

19

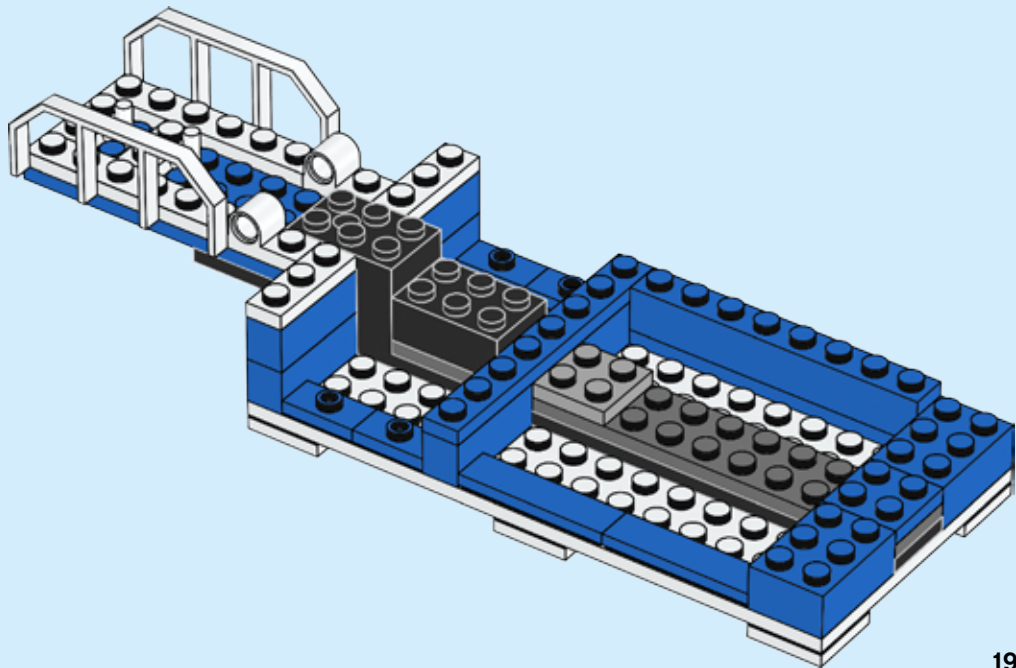

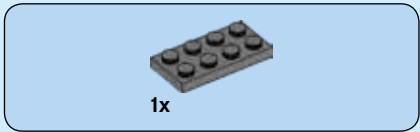

20

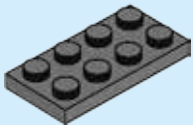

20



21

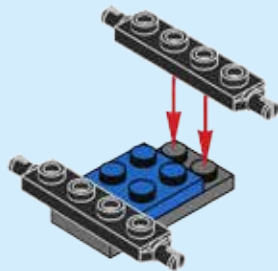

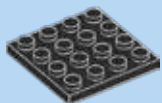

1x

**22**

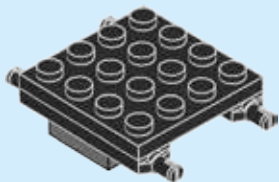

1x

**23**

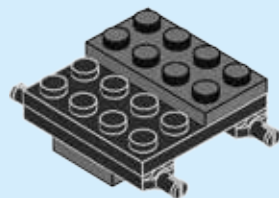

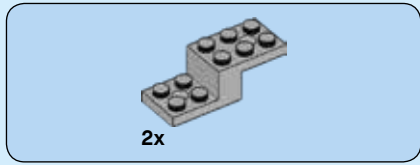

24

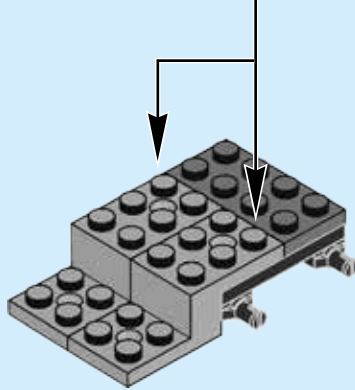
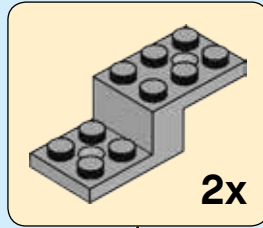



25

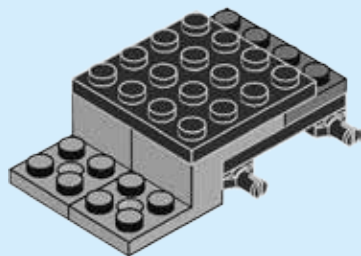

26

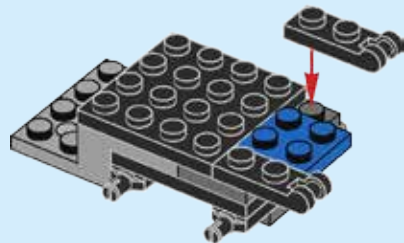

27

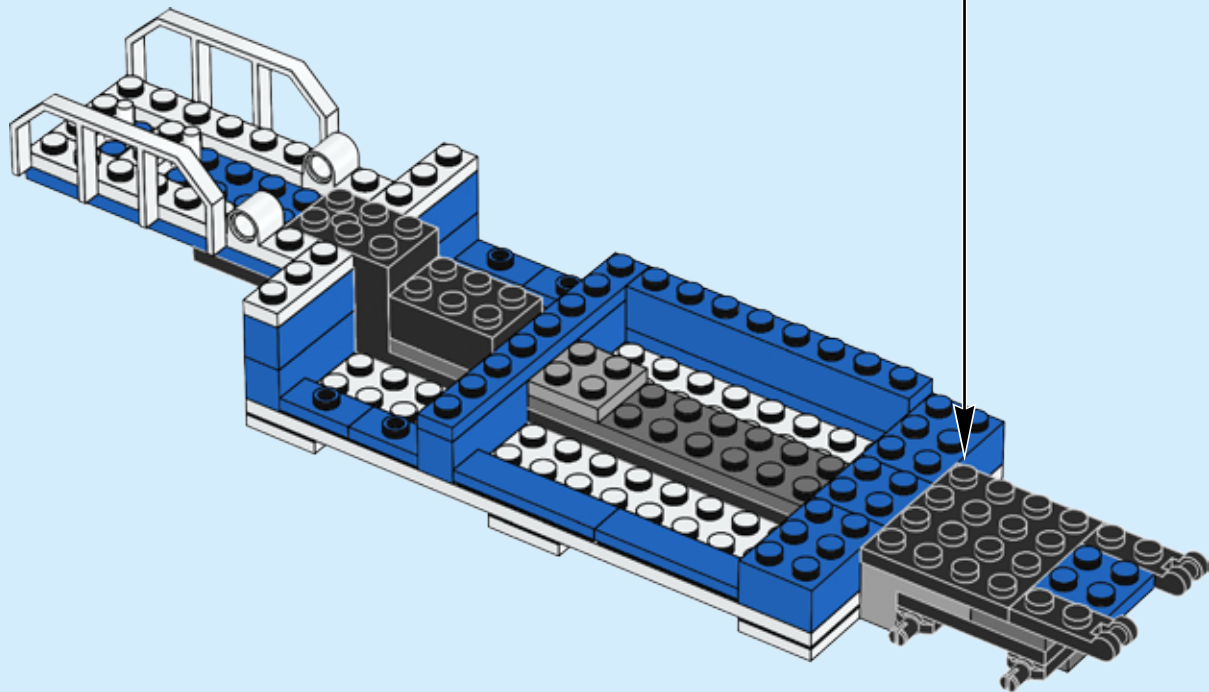





28

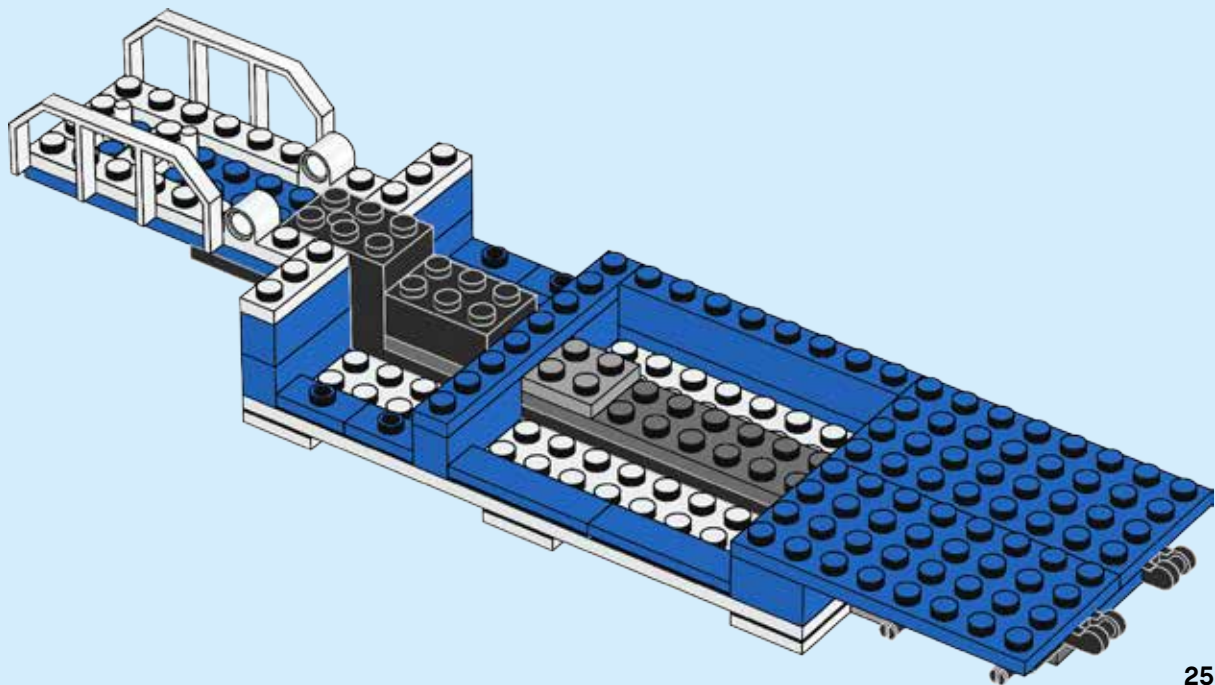



2x

29

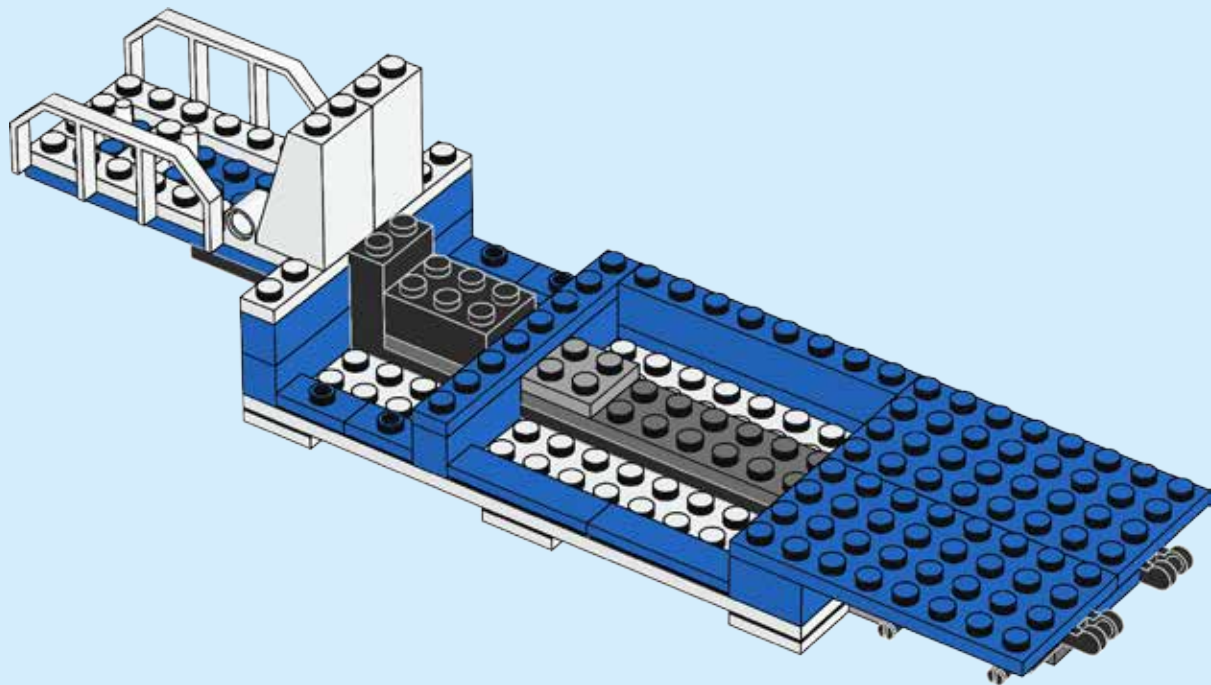

26



2x

30

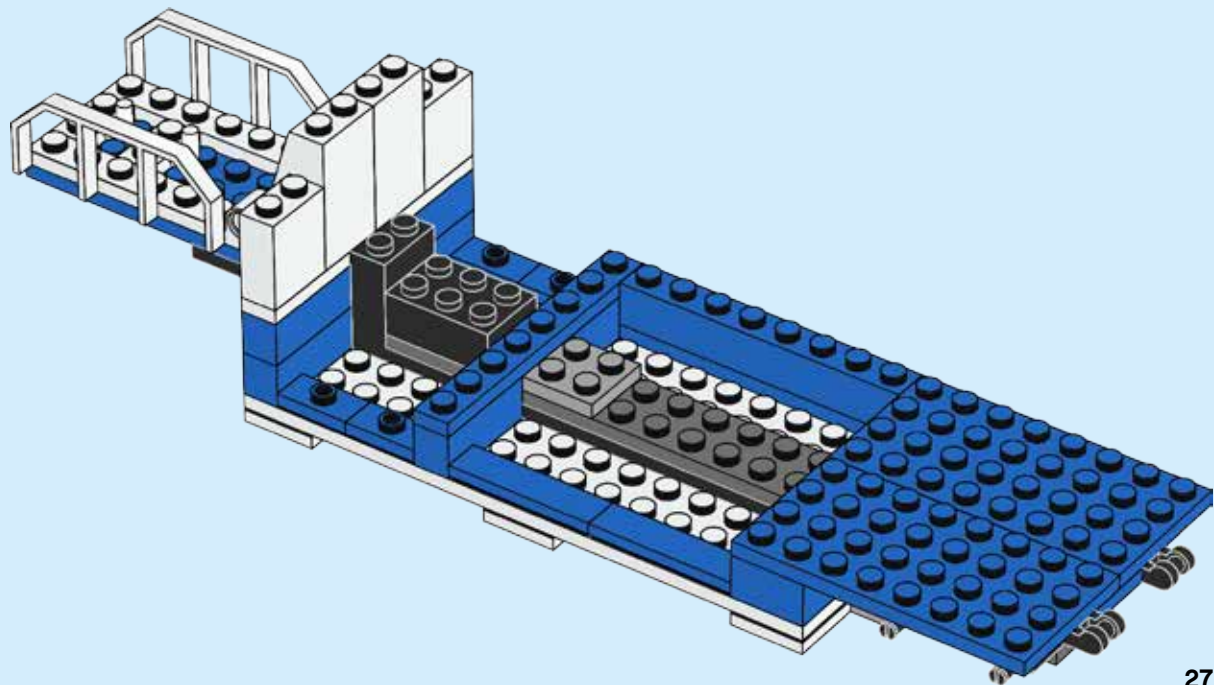



2x



2x

31

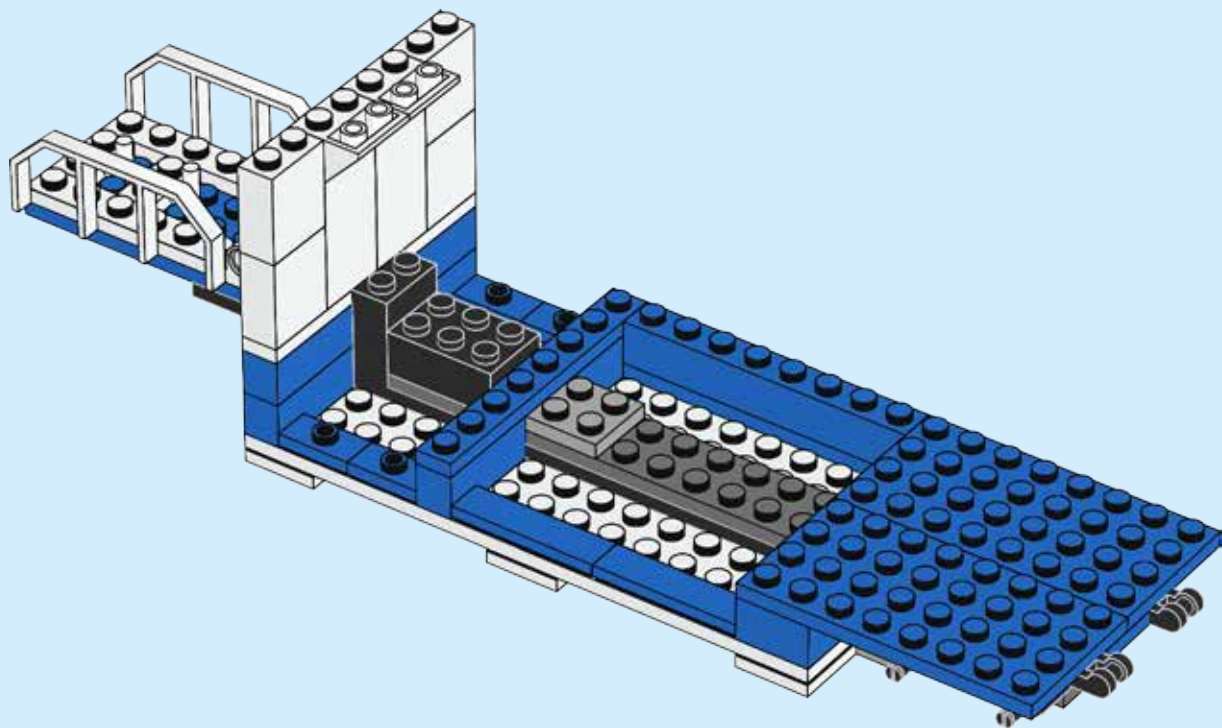

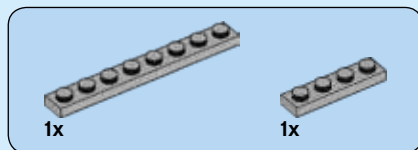

**32**

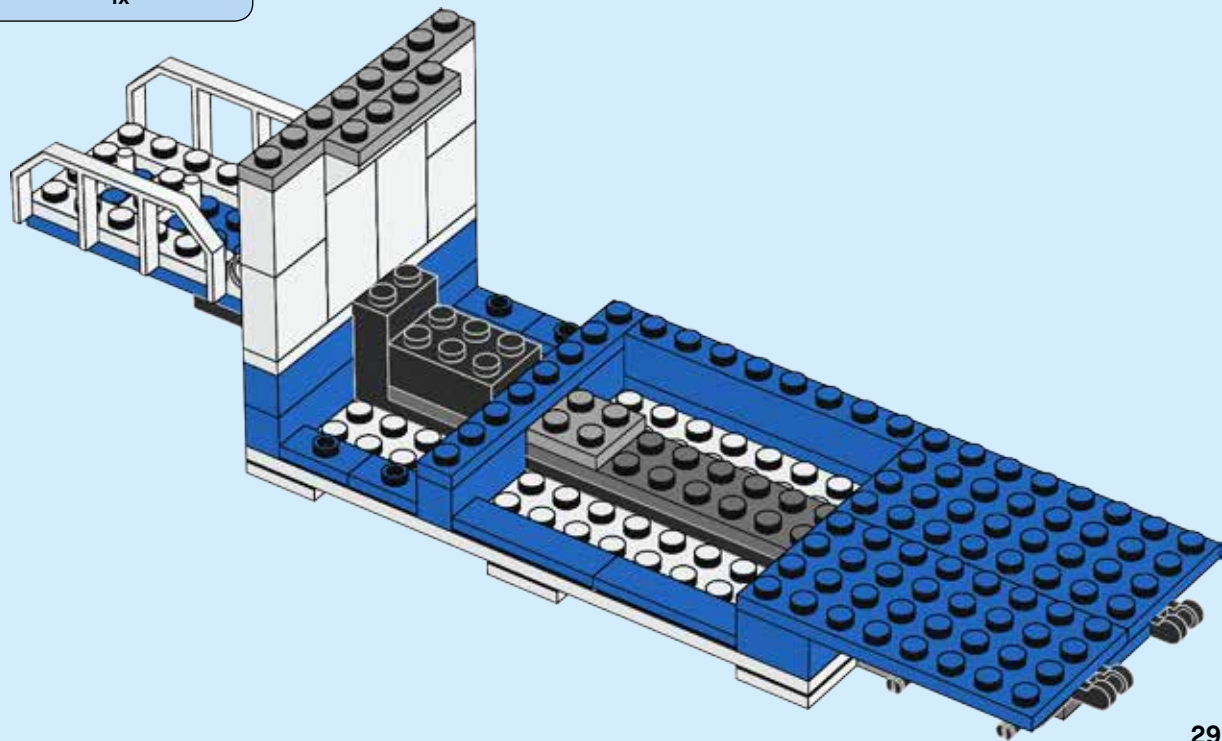



2x

33

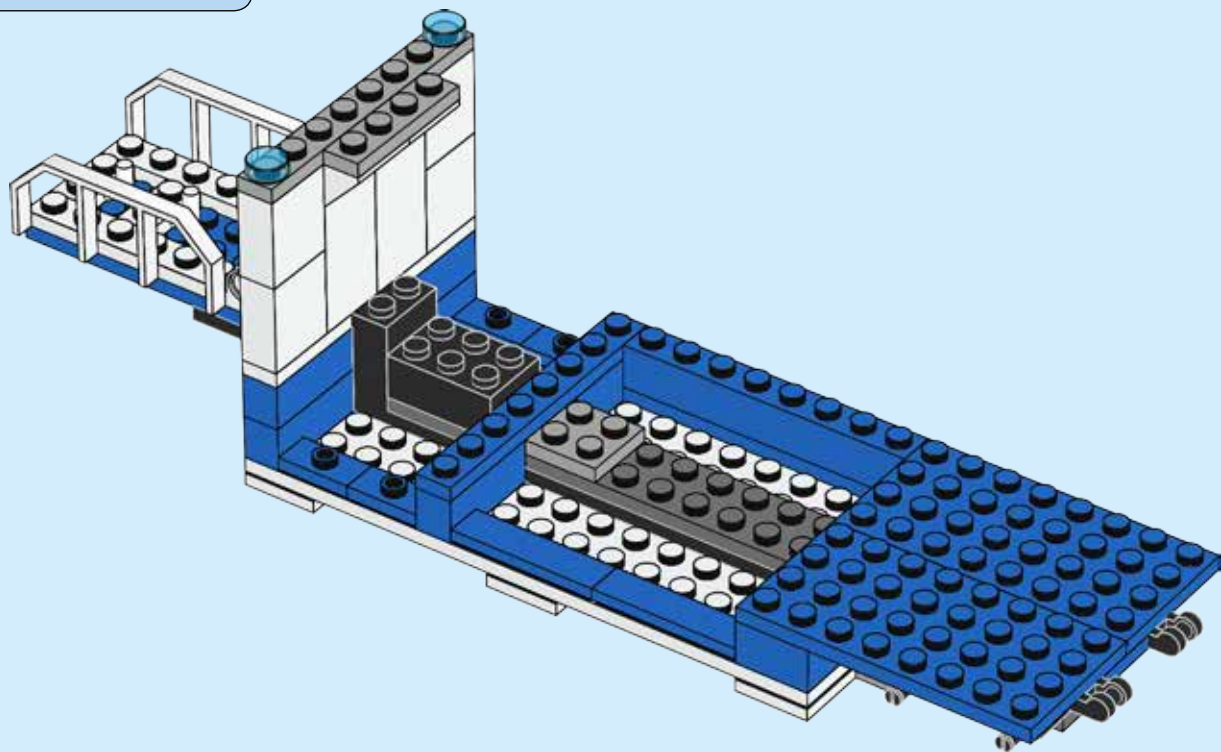

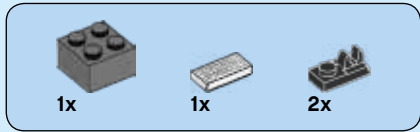

34

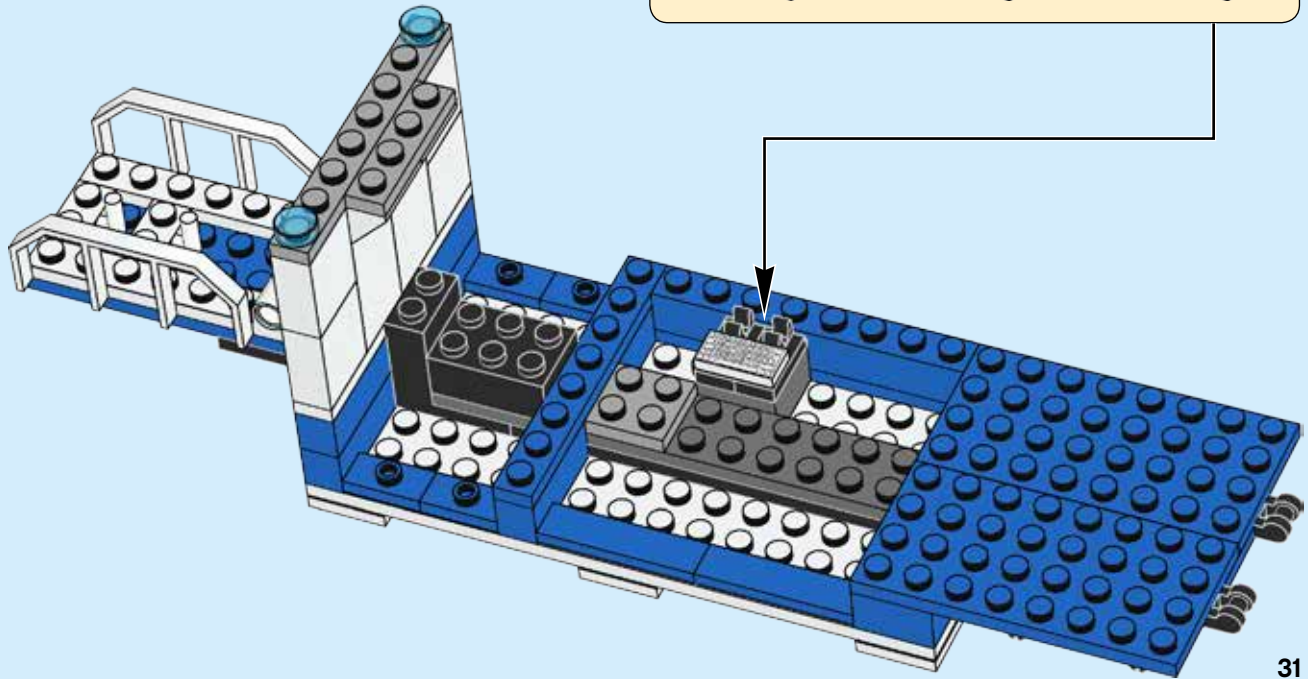
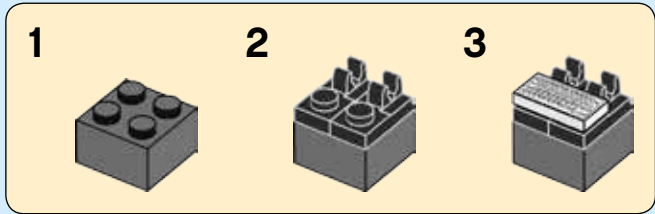

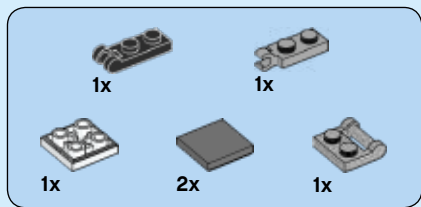

**35**

**1**

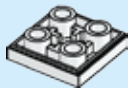

**2**

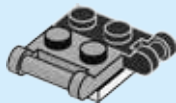

**3**





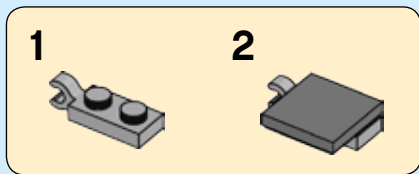

4

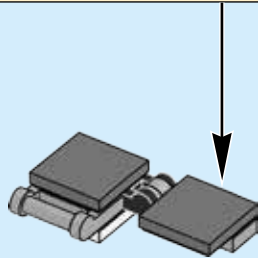

5

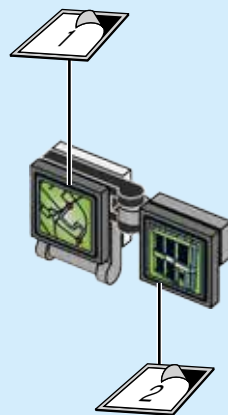

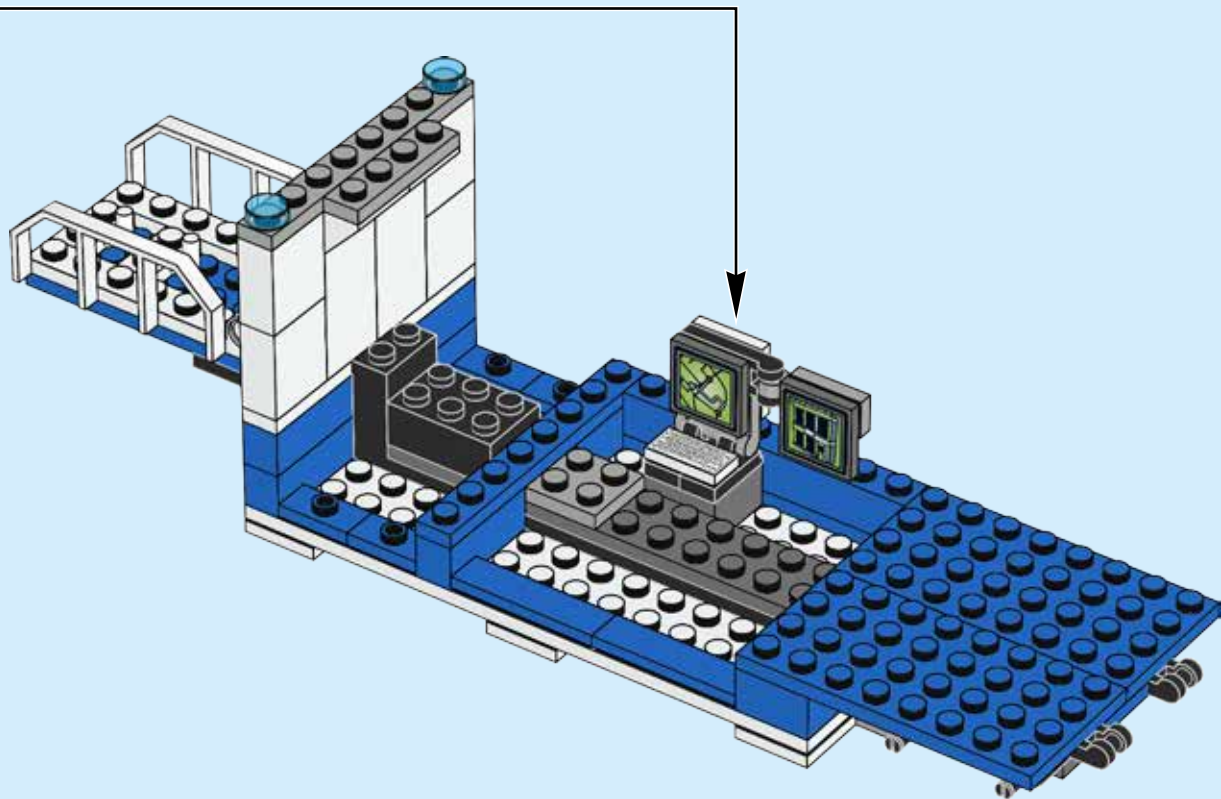

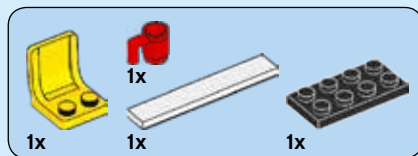

36

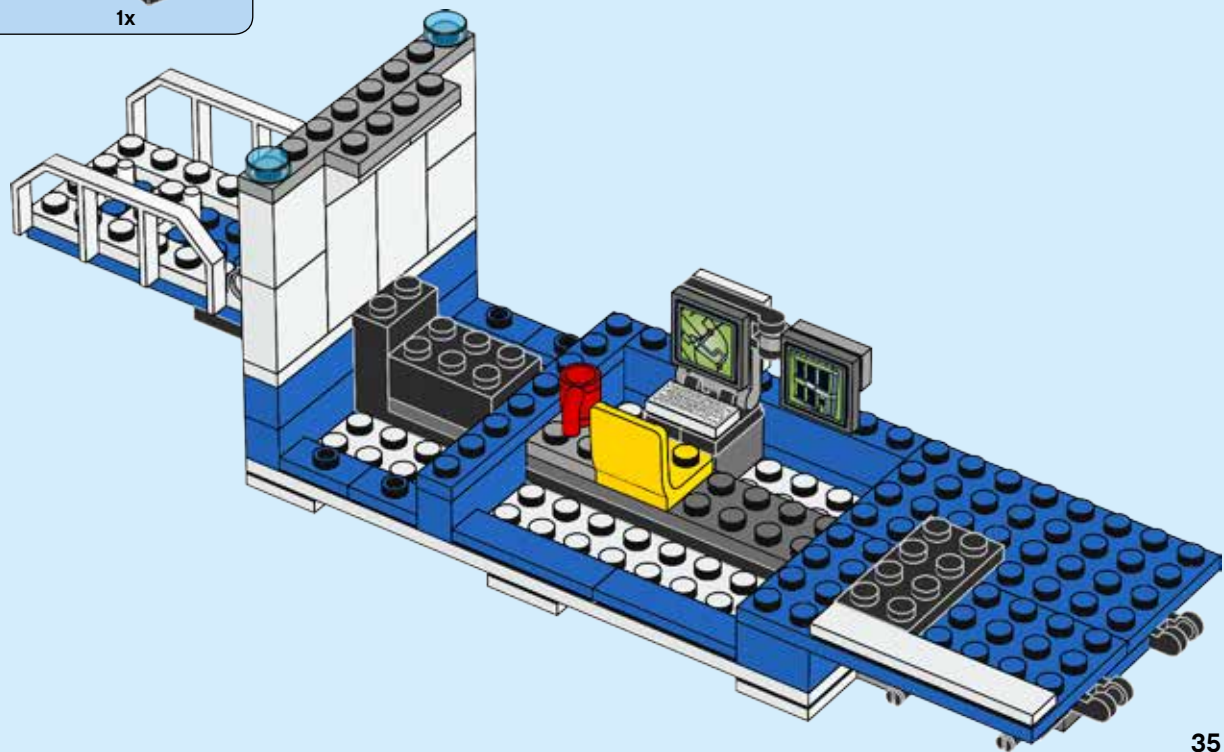



2x



1x

37

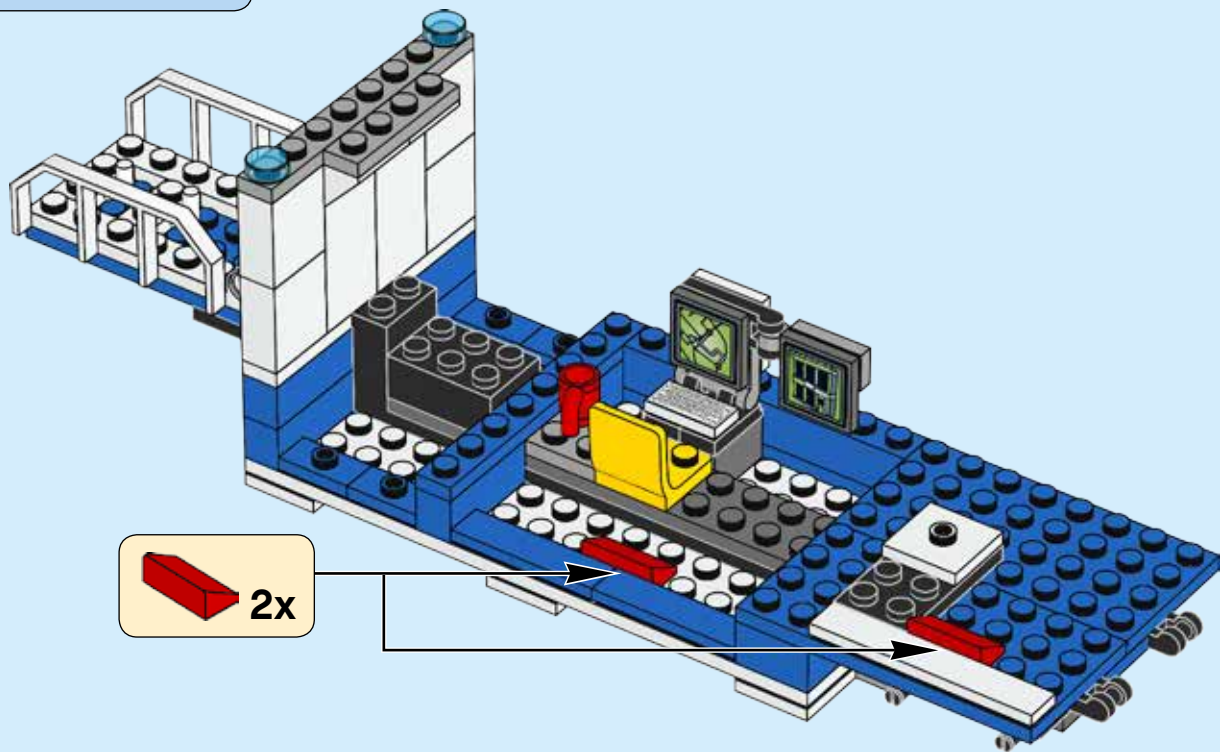

2x

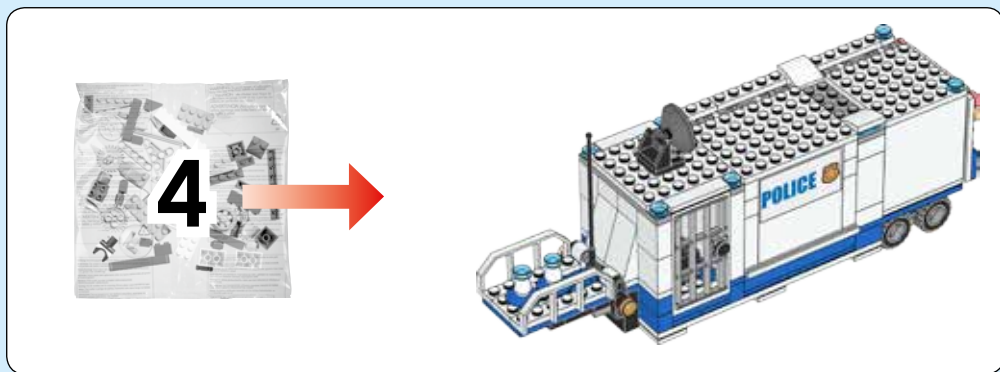

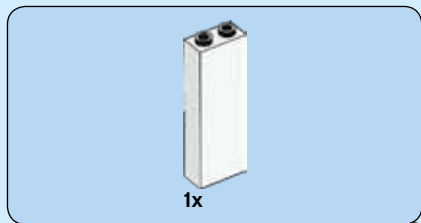

38

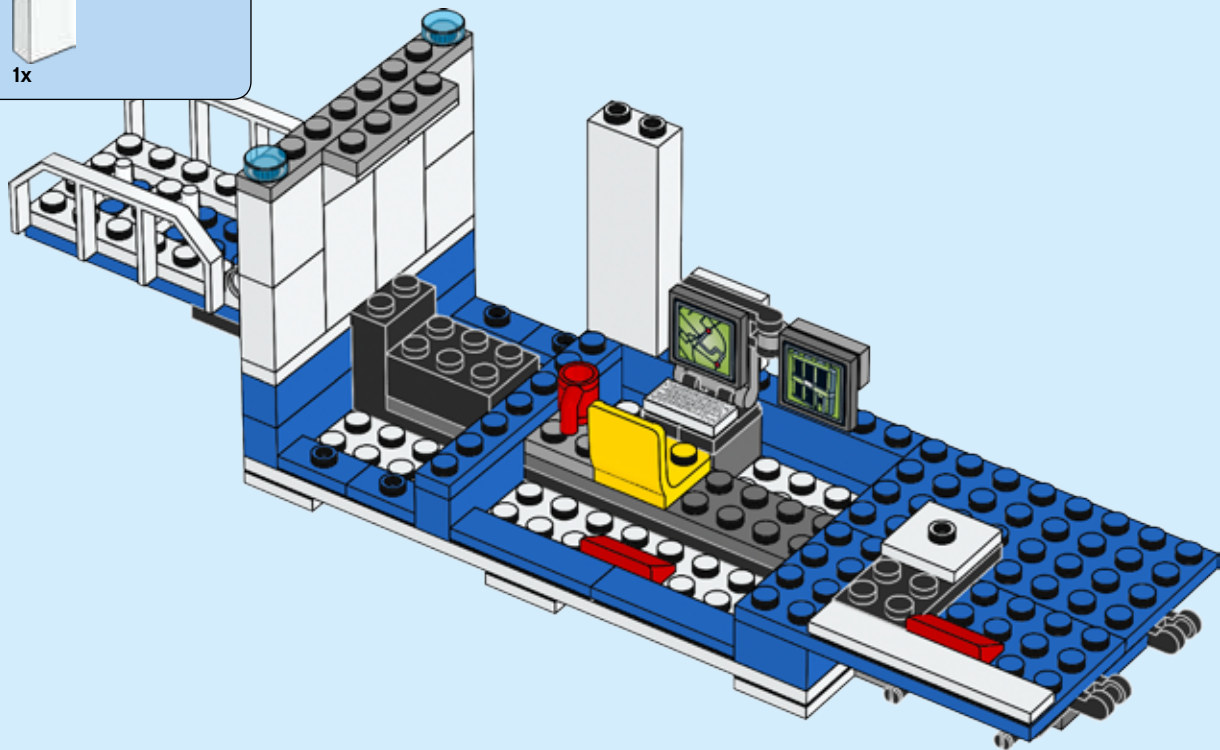

38

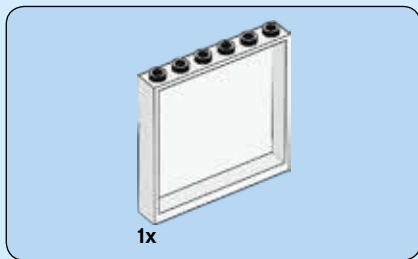

39

1

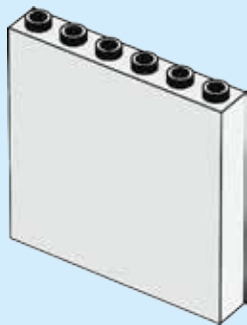

2



3

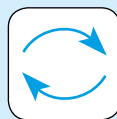
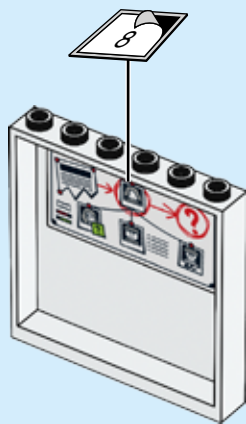

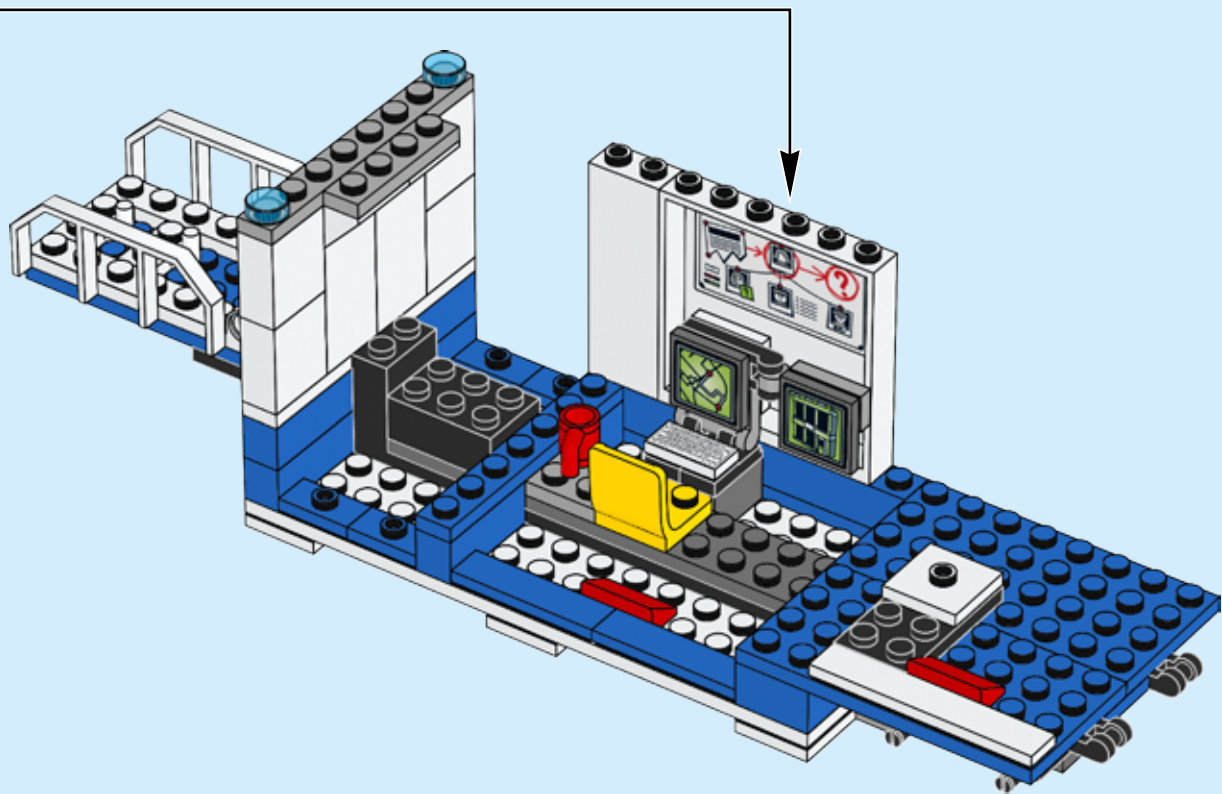



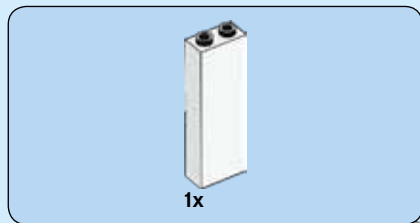

40

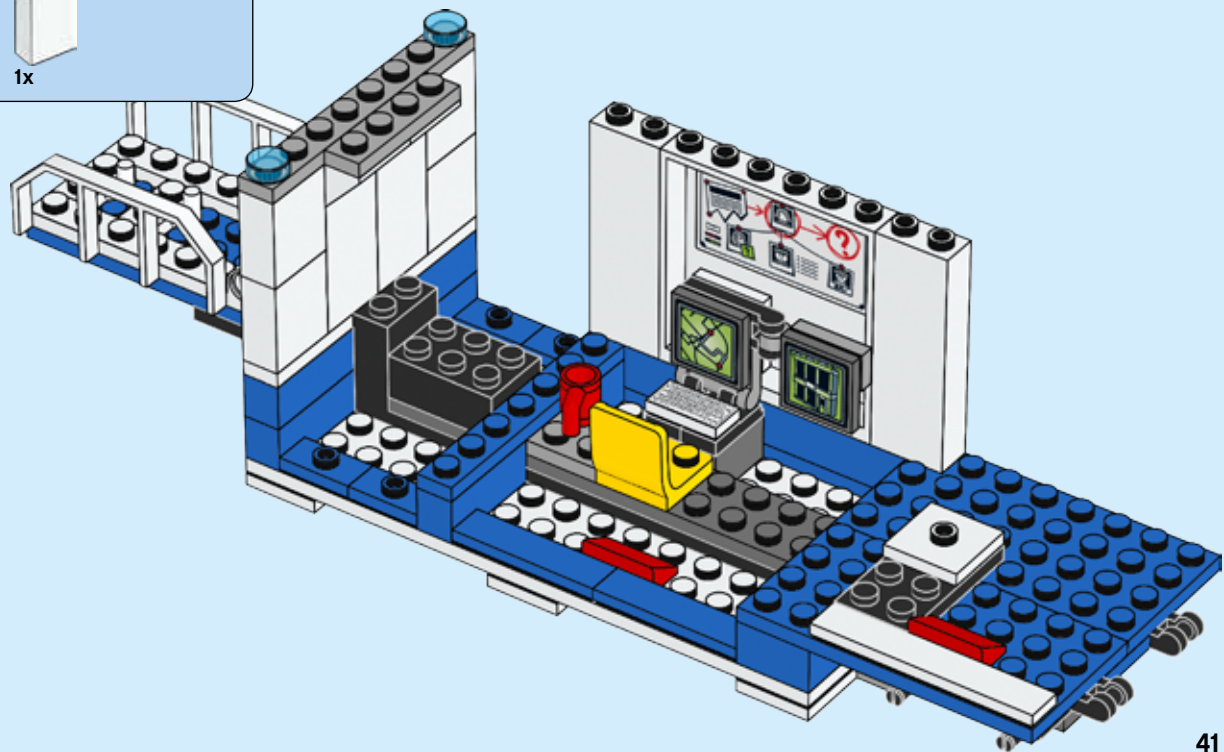

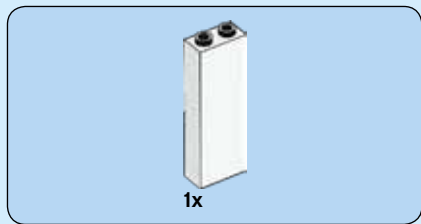

41

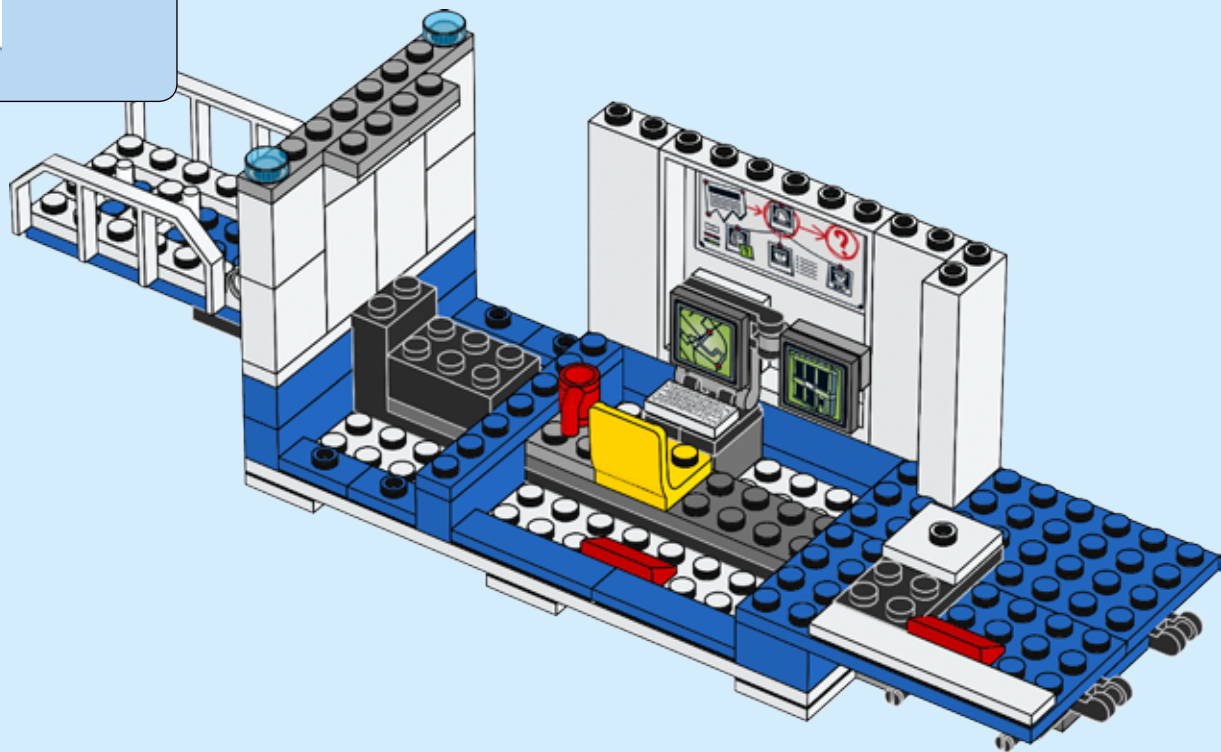

42

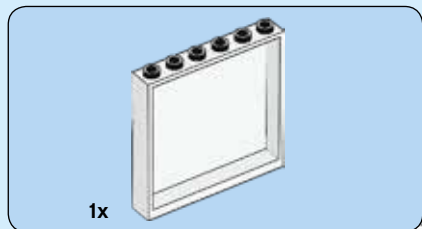

42

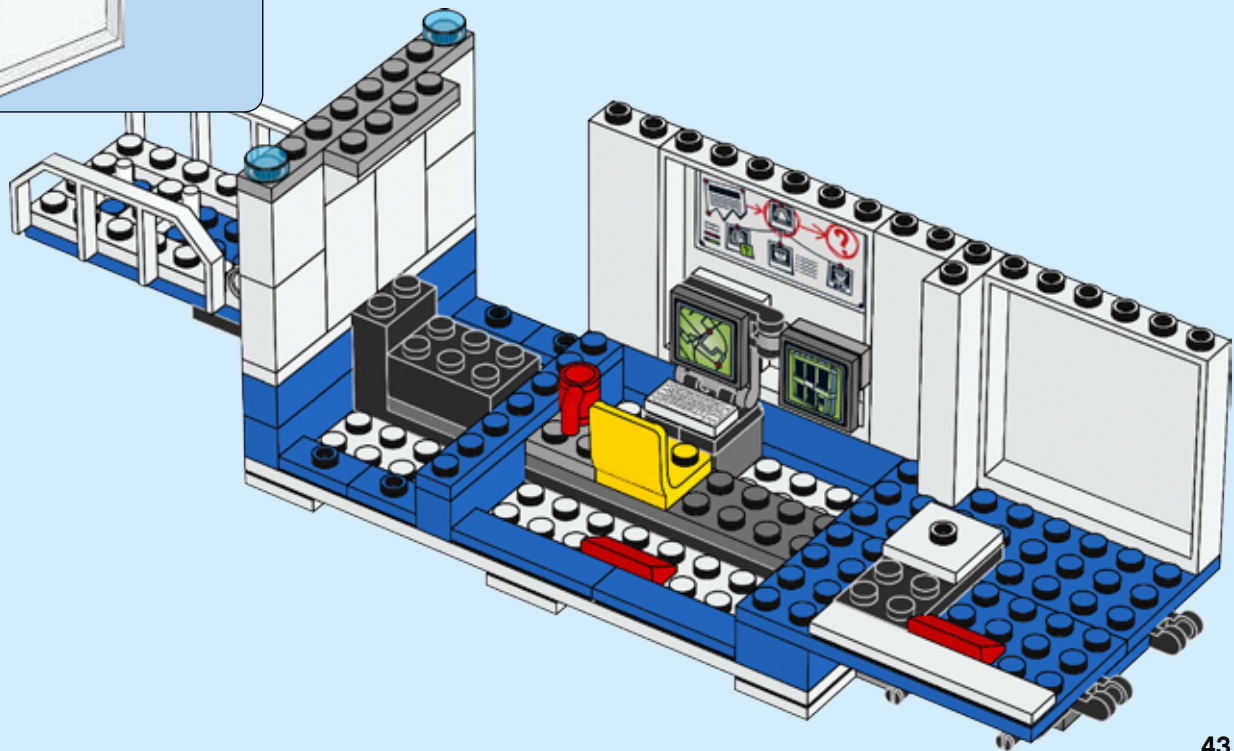

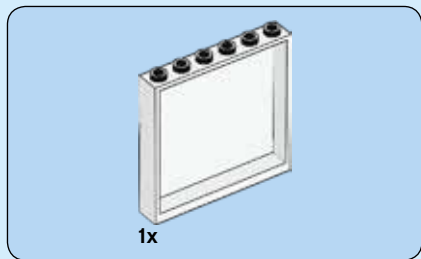

43

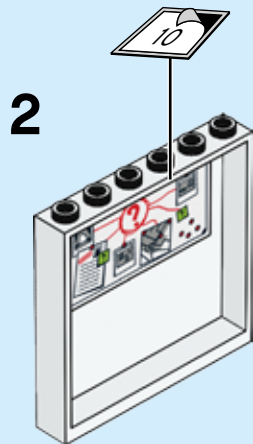
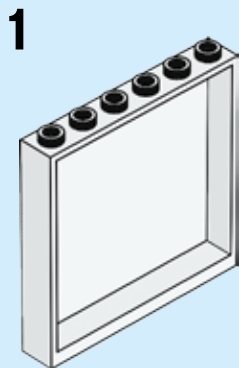

44

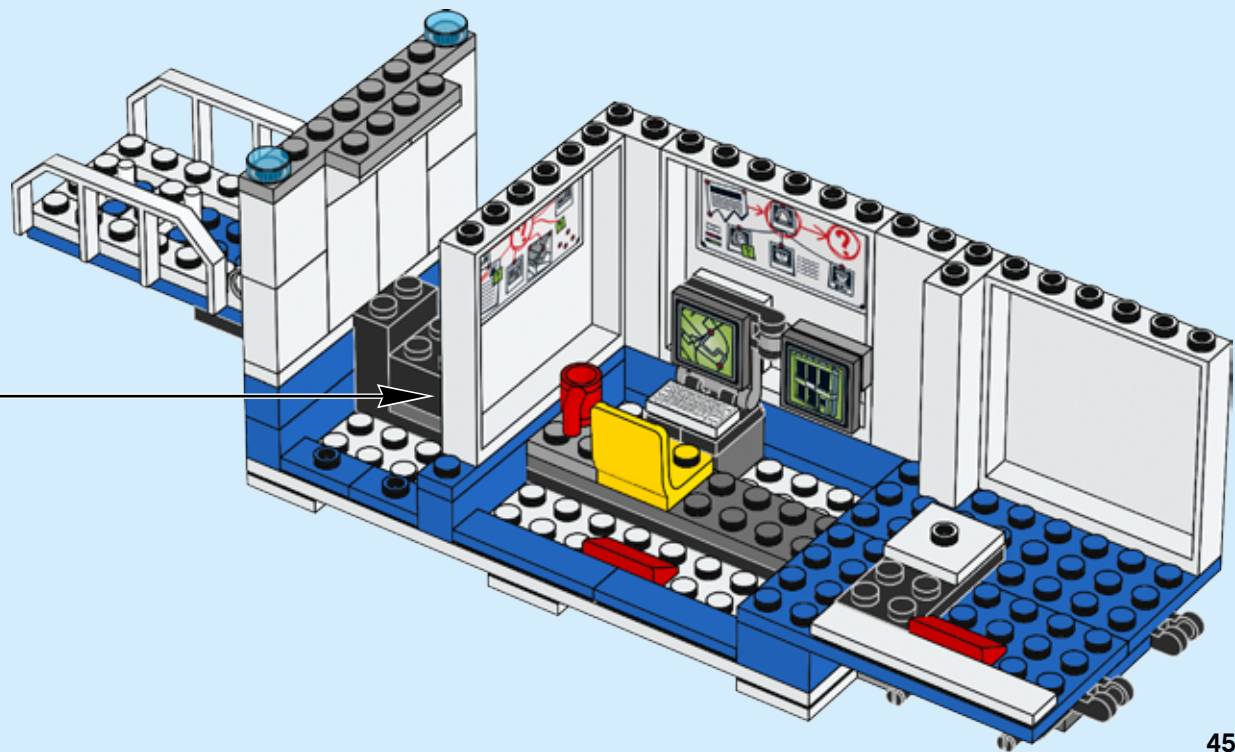



1x

44

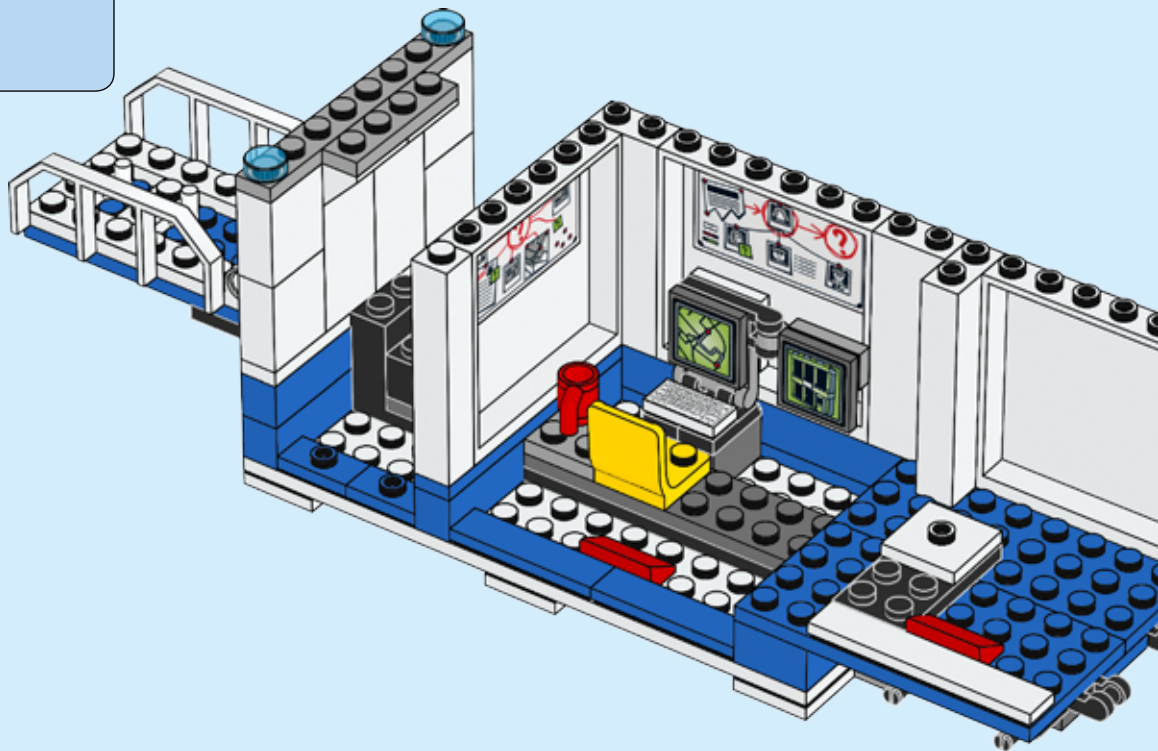

46



1x

45

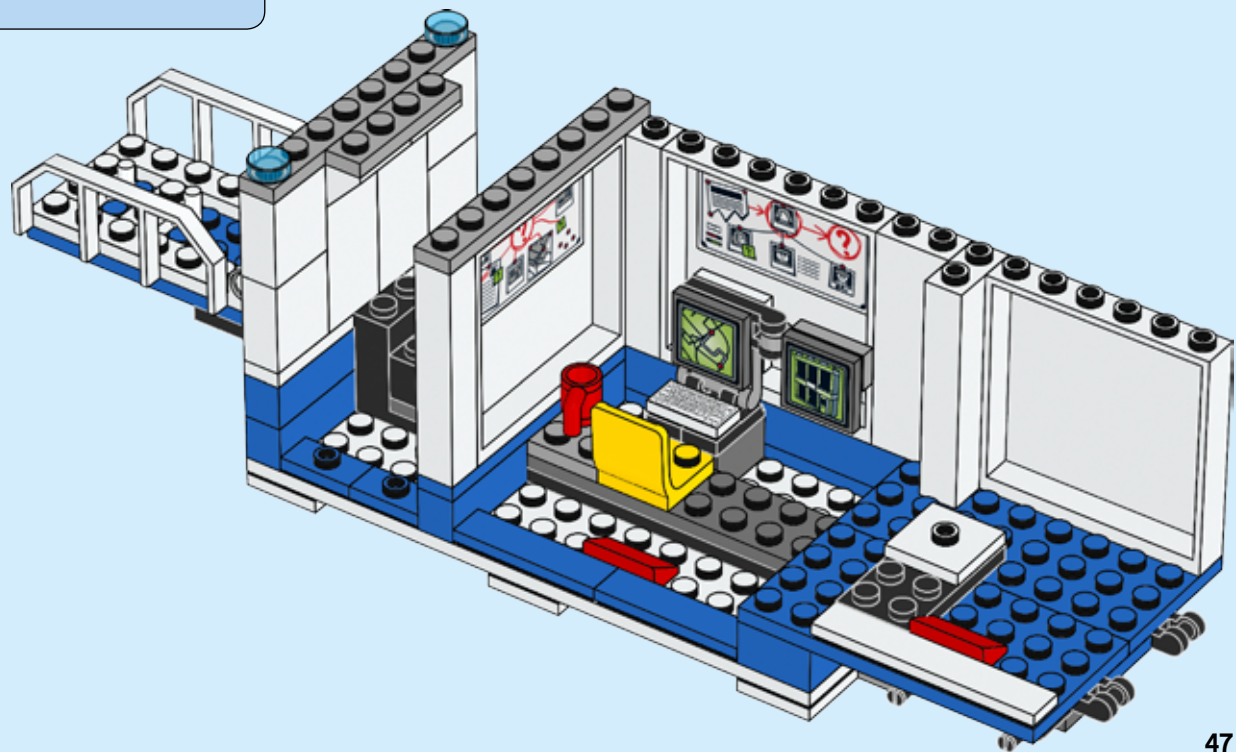

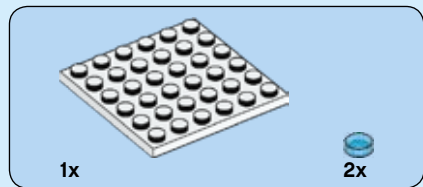

46

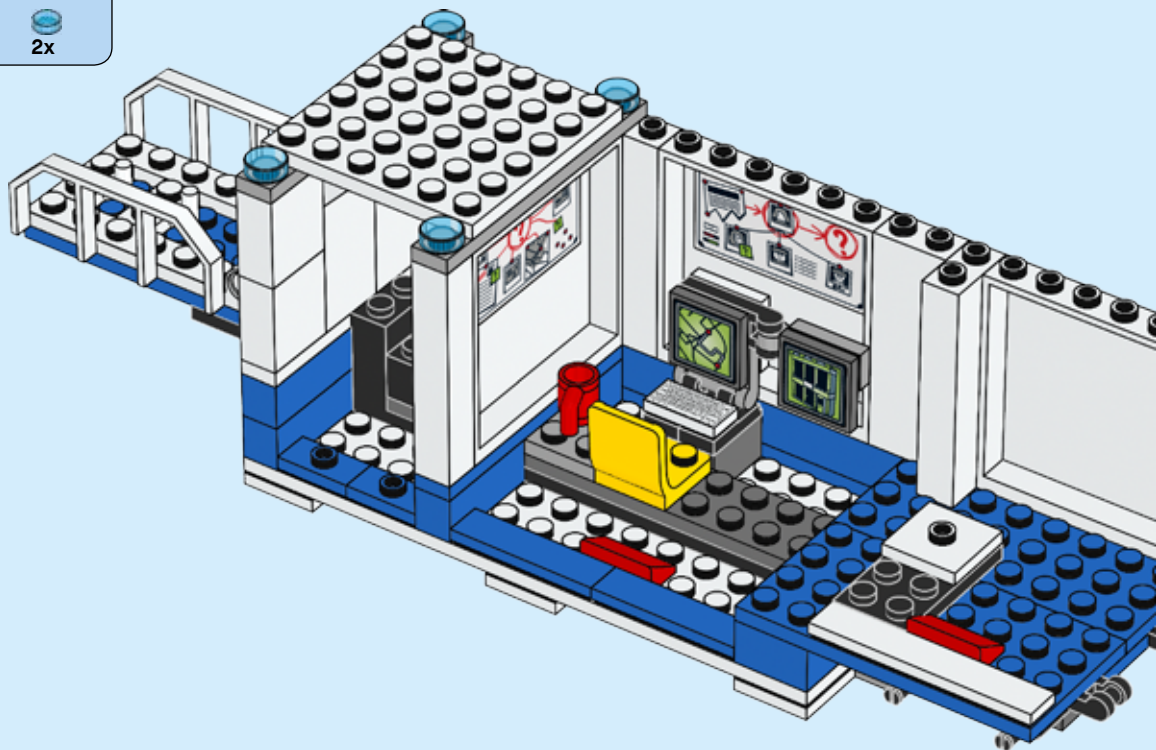

48



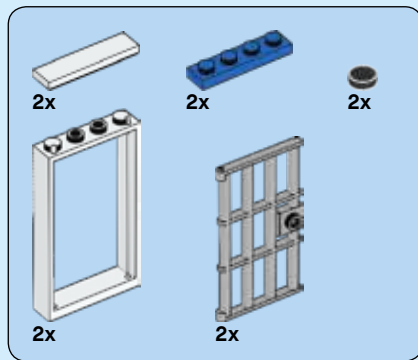
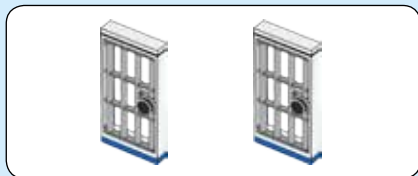

47

1

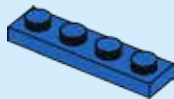

2

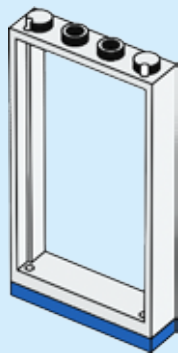

3

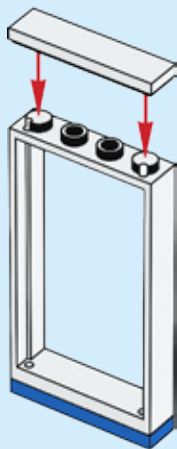

4

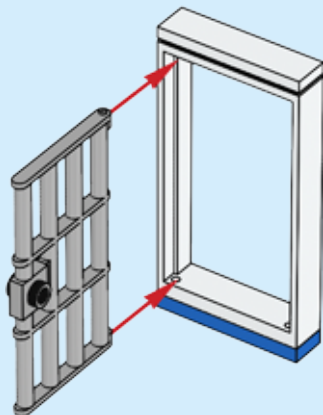

5

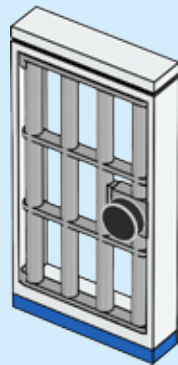

2x

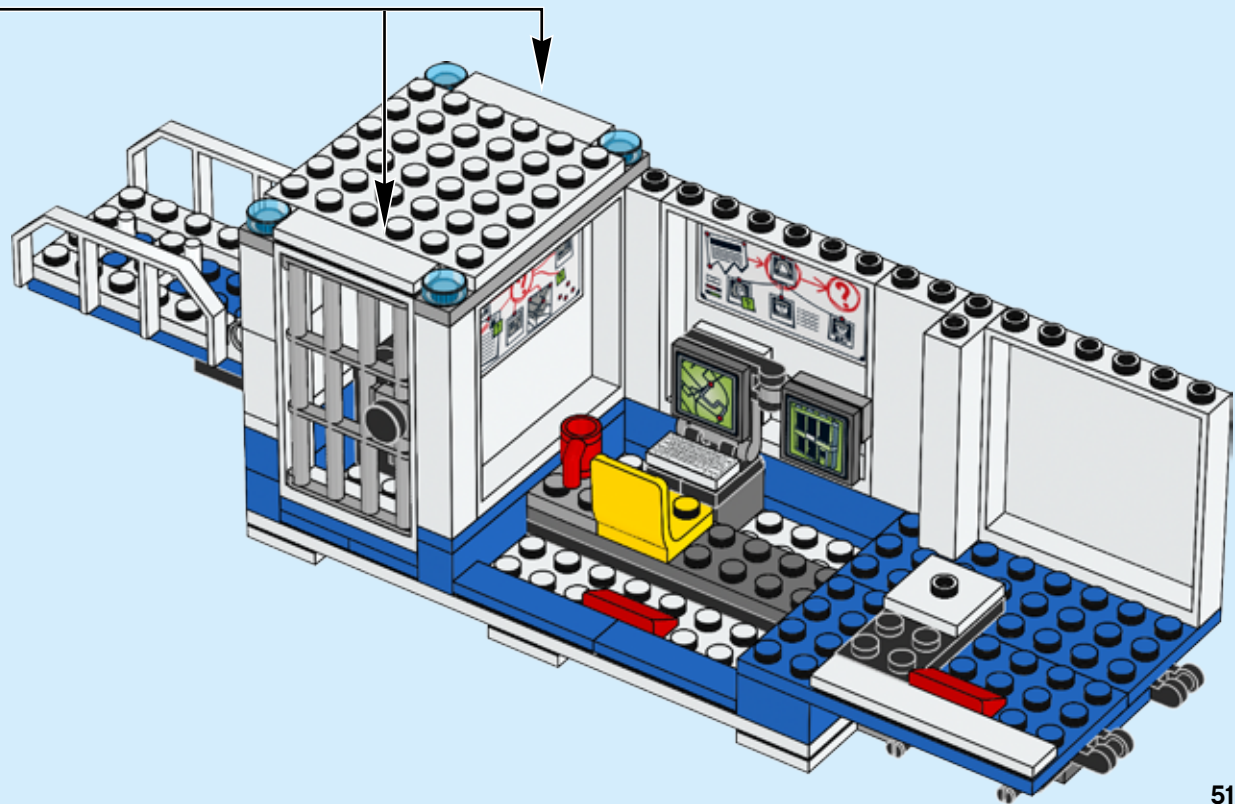

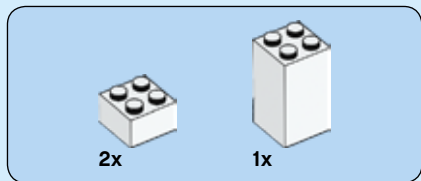

48

1

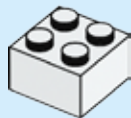

2



3

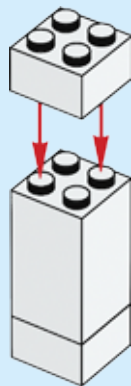

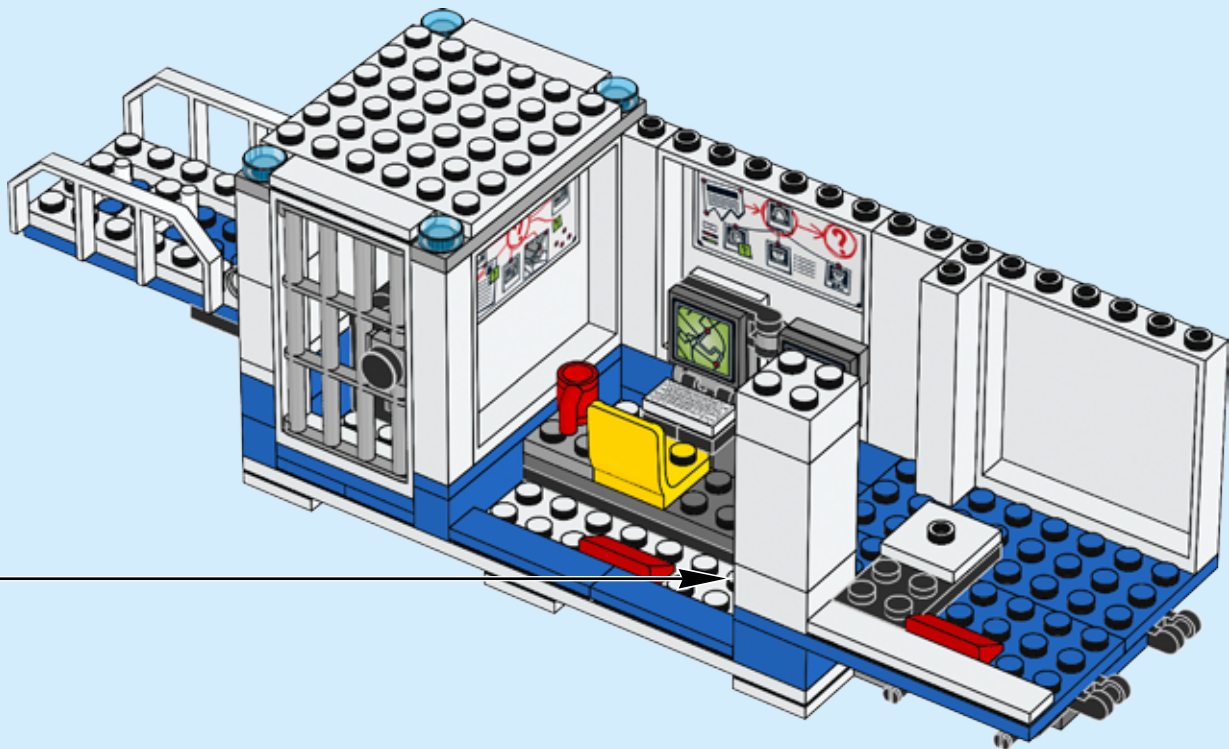



4x

49

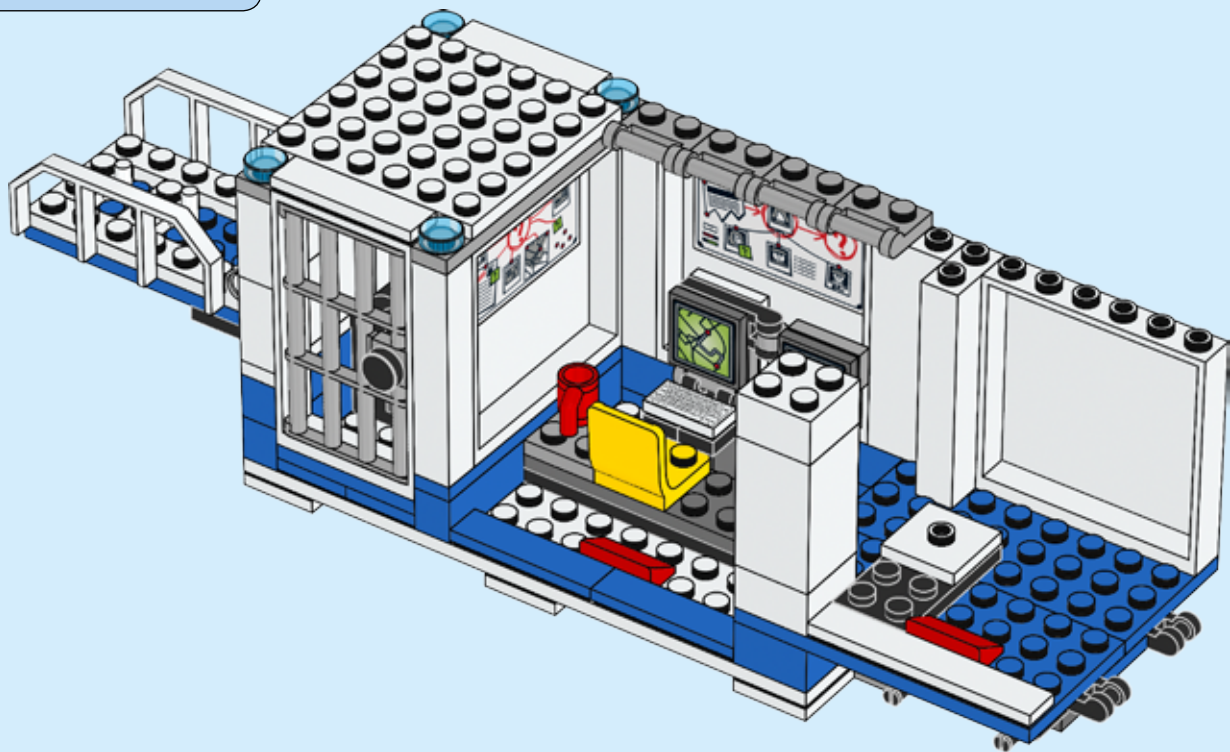

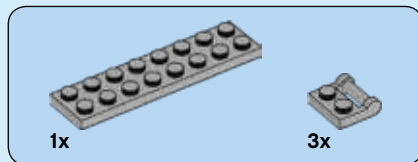

50

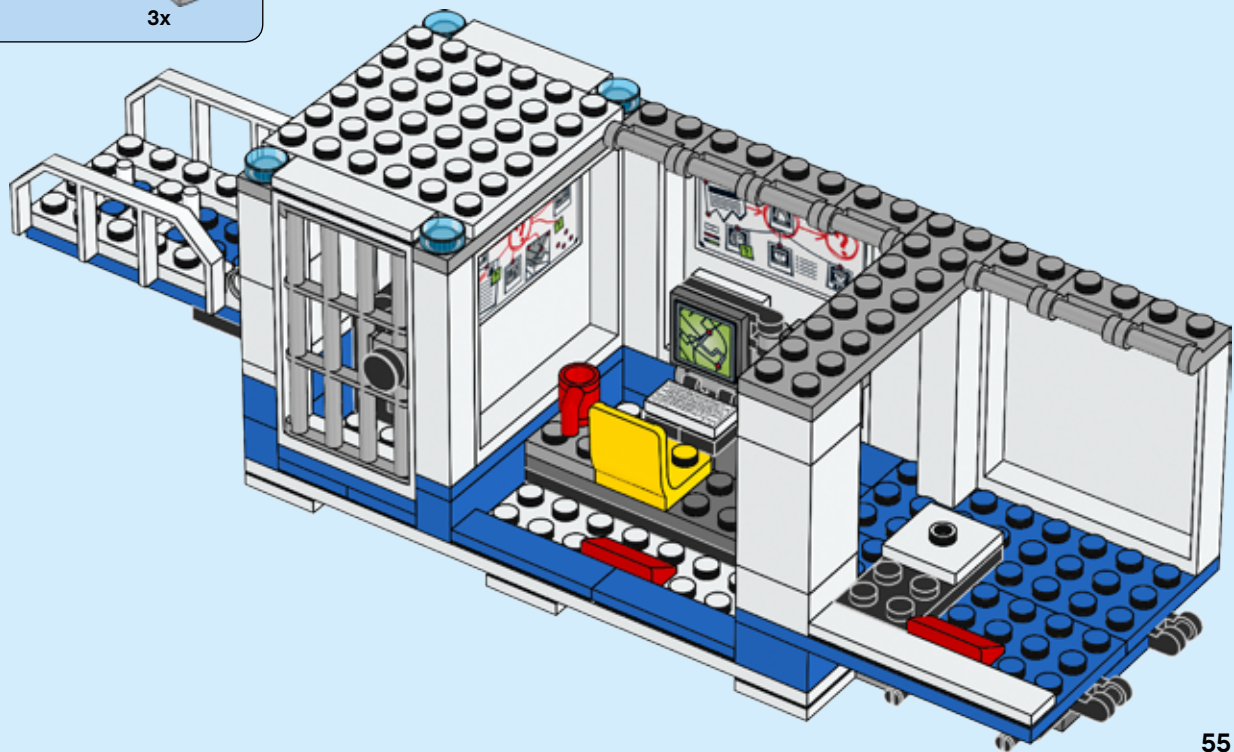

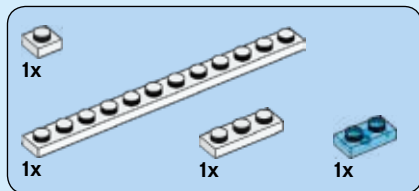

51

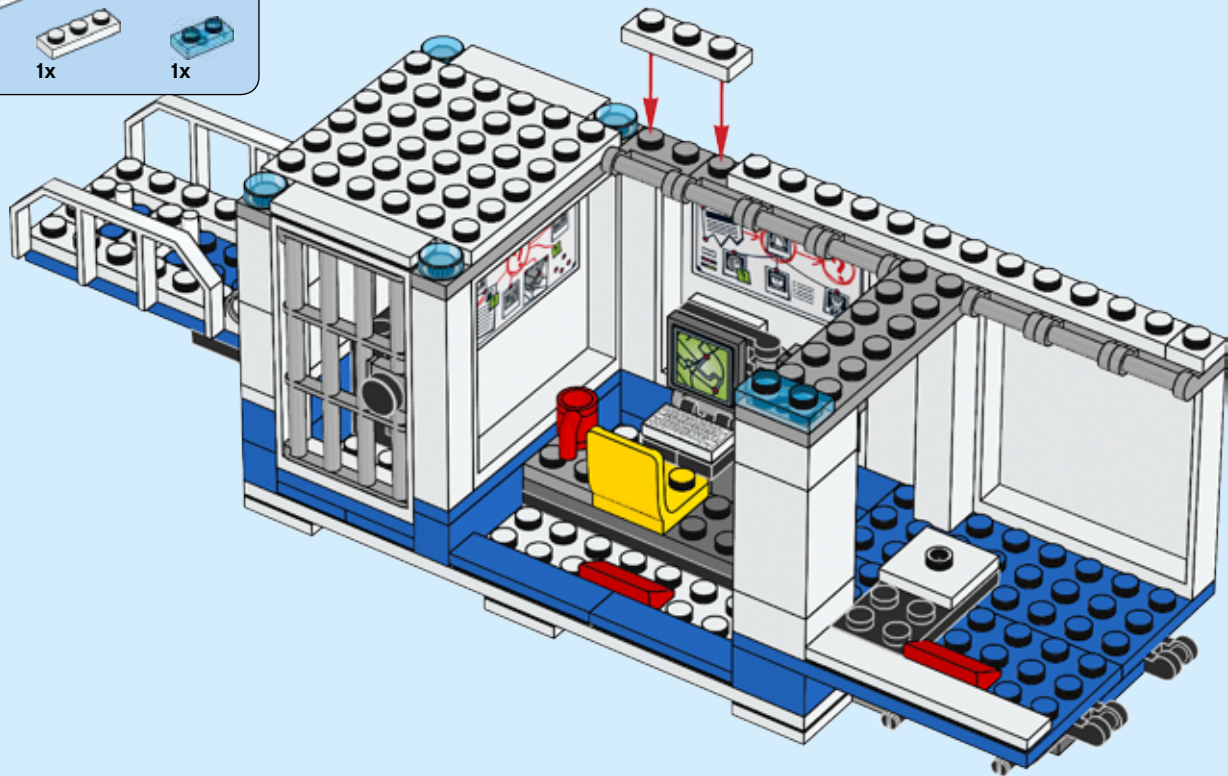

56





2x

52

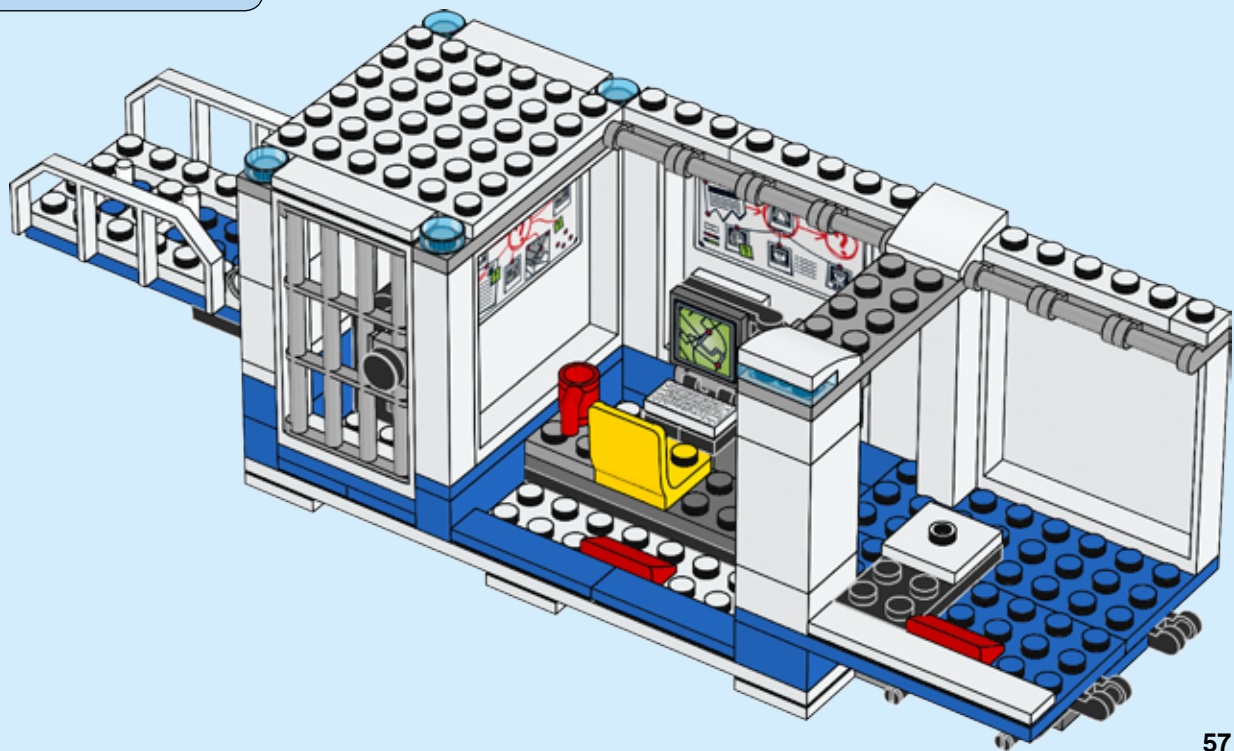

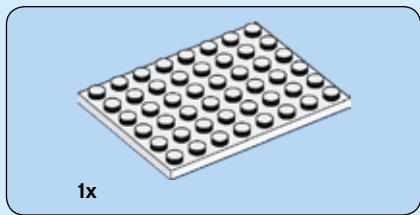

53

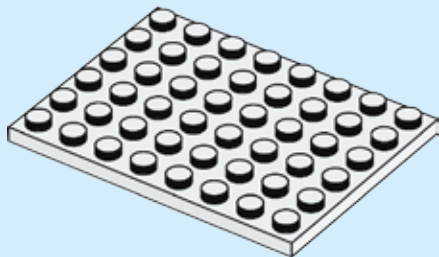

58

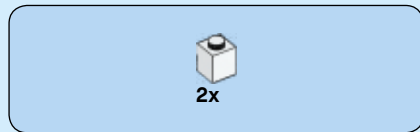

54

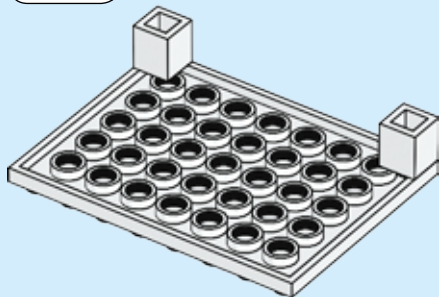
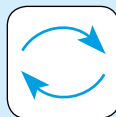

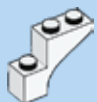

2x

55

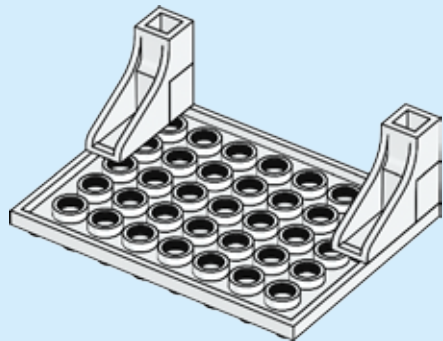

1x

56

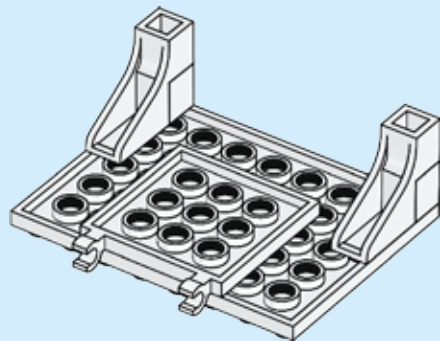



2x

57

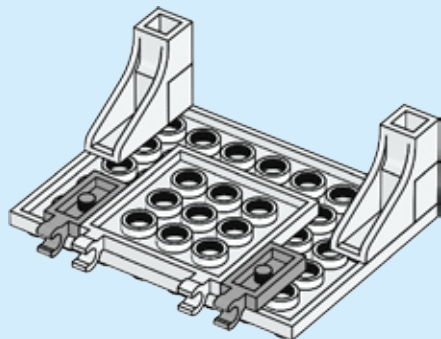

60



2x

58

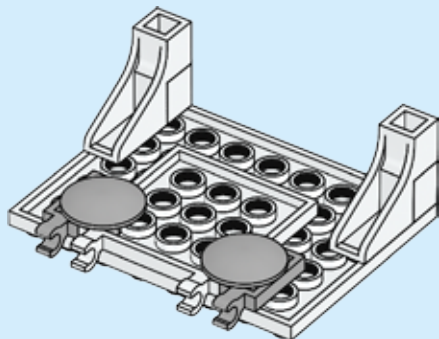

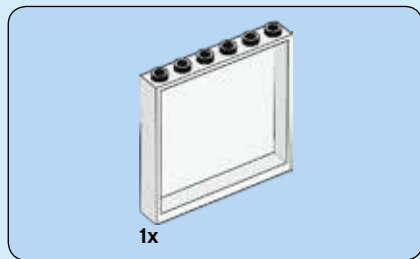

59

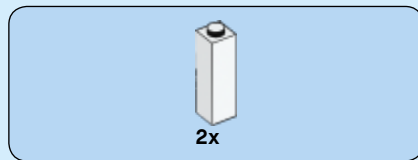
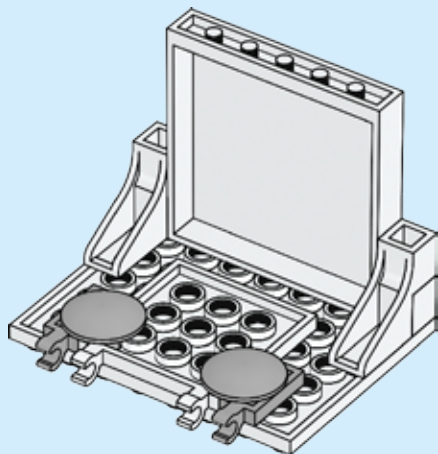

60

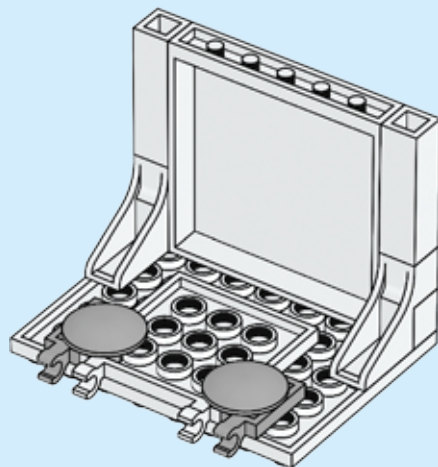

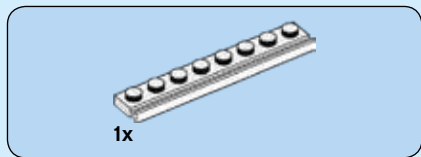

61

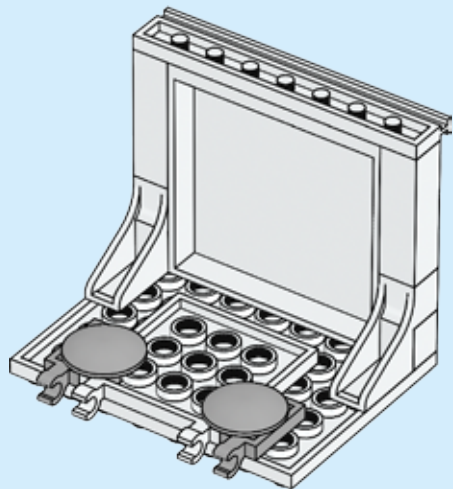

62

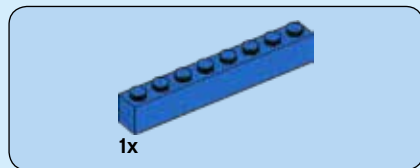

62

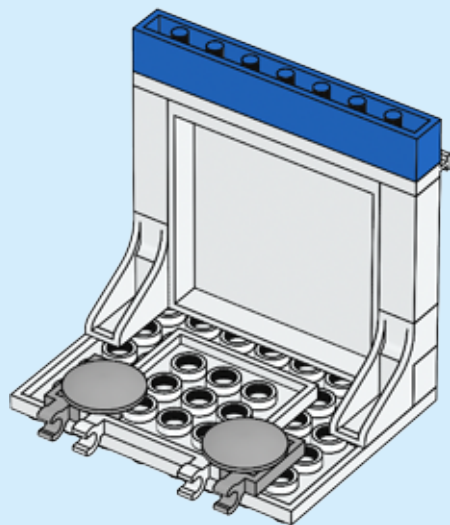

63

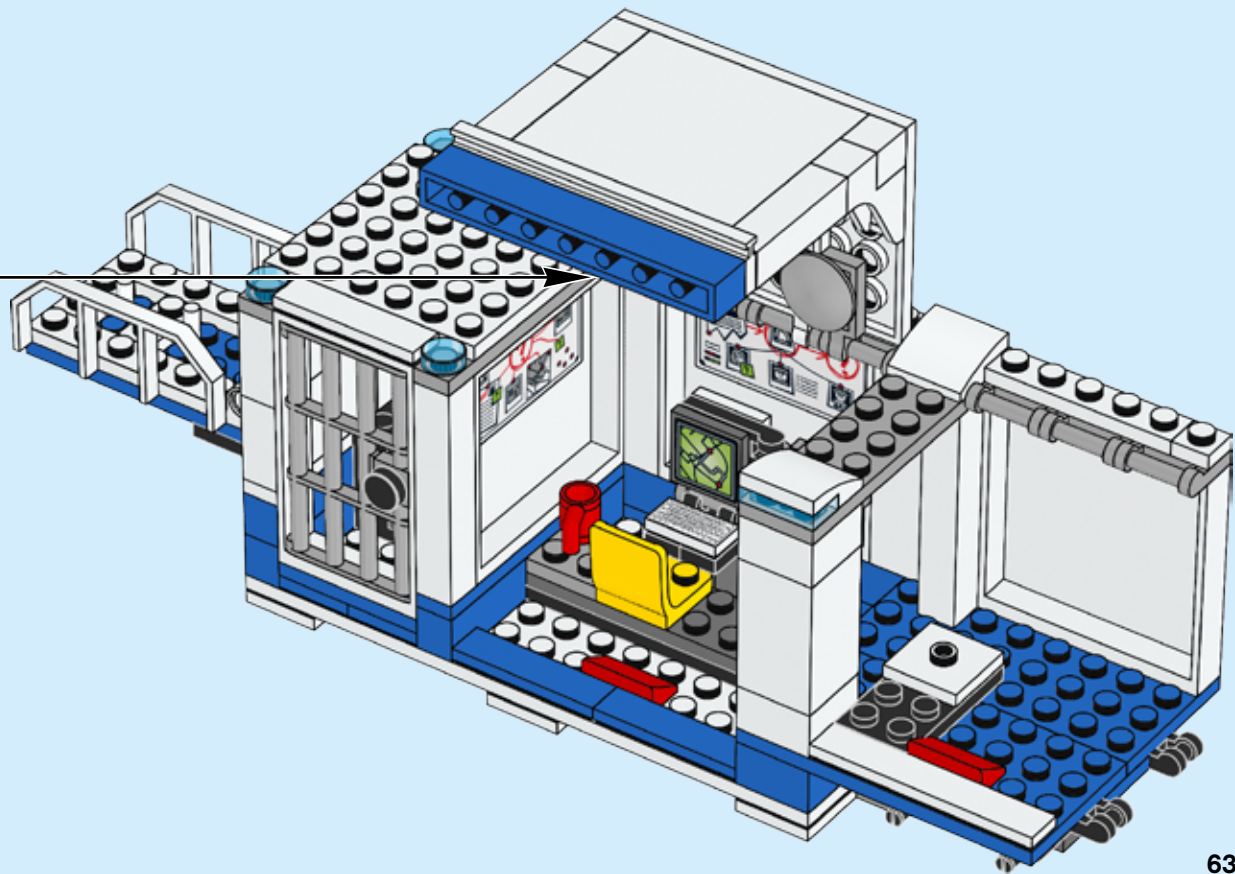

64

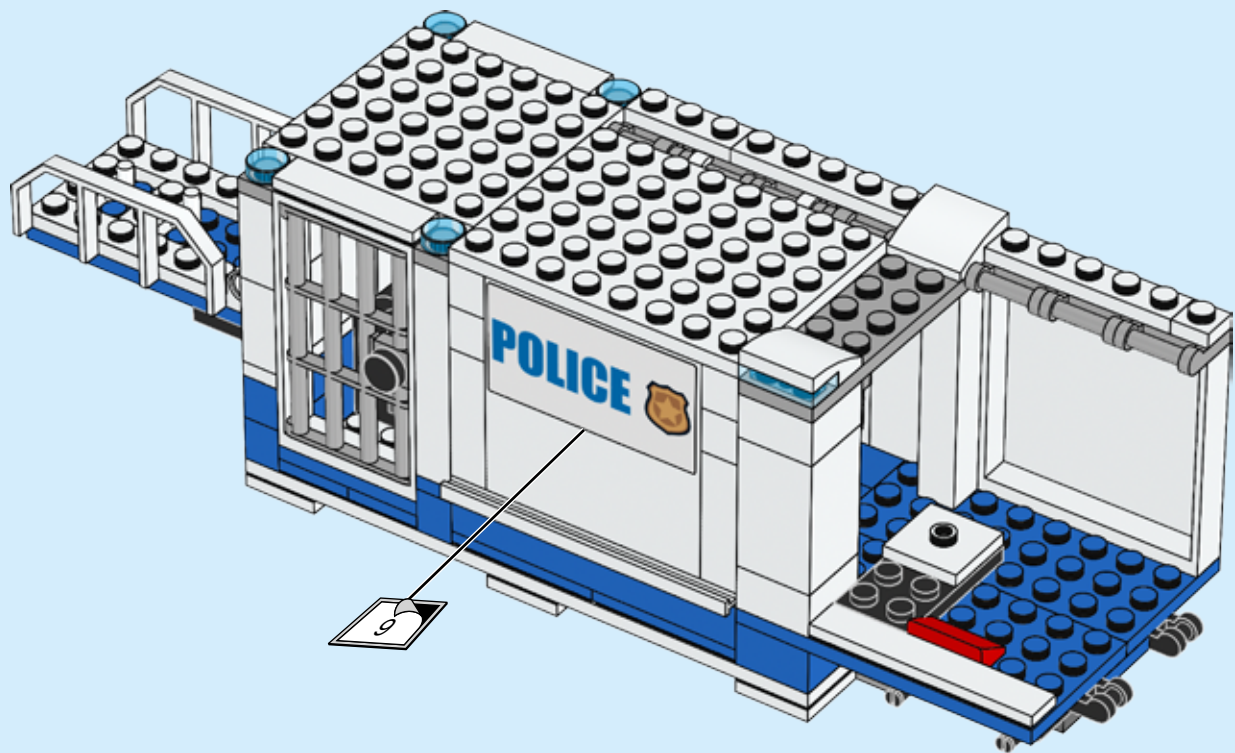



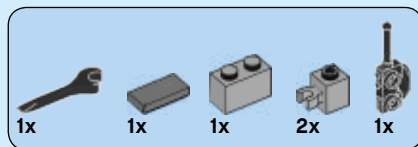

# 65

1

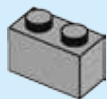

2

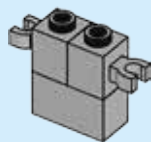

3

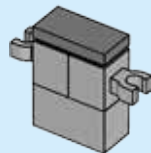

4

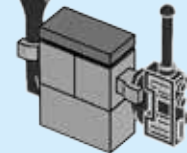

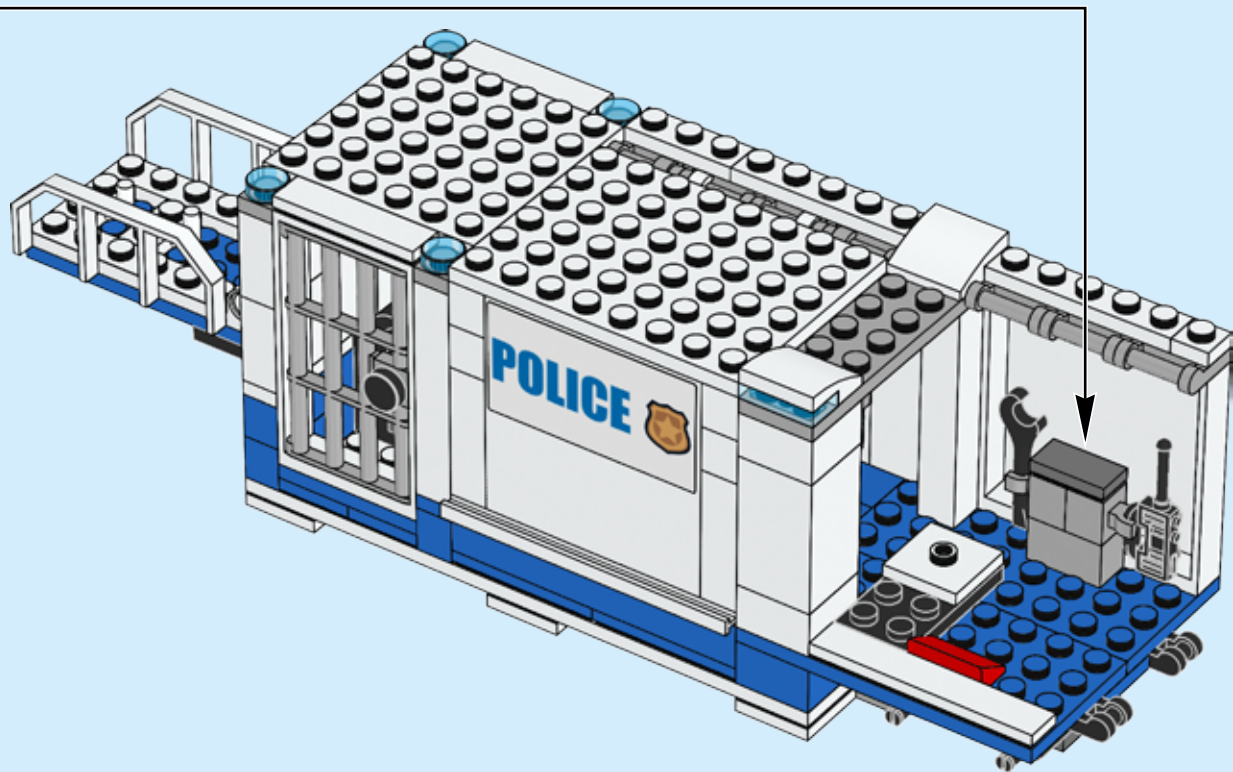

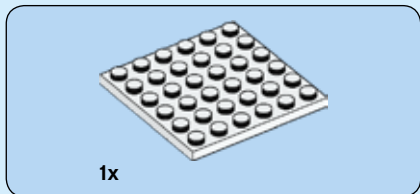
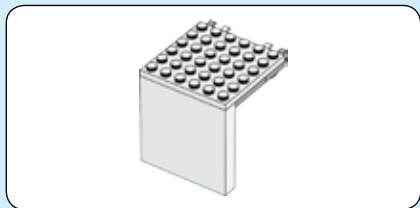

66

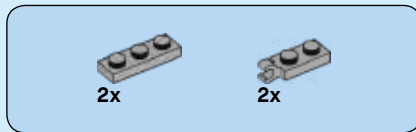
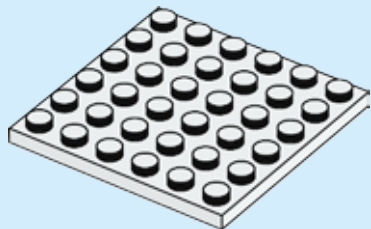

67

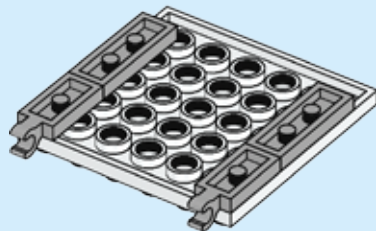
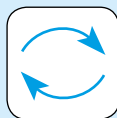



1x

68

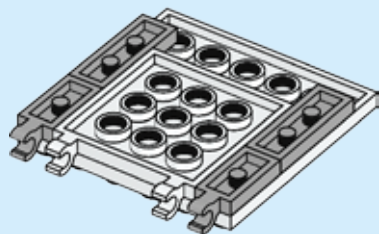

68



2x

69

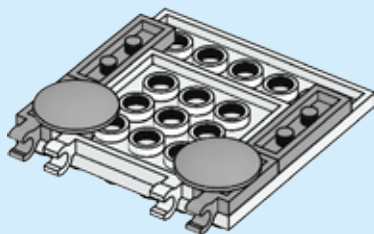

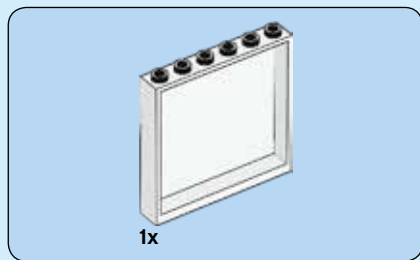

70

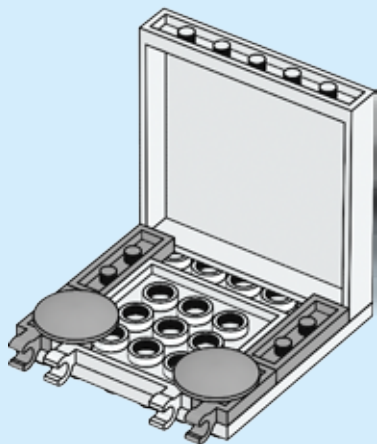

71

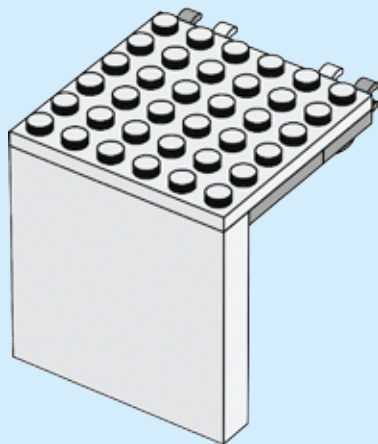
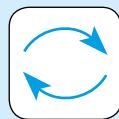

72

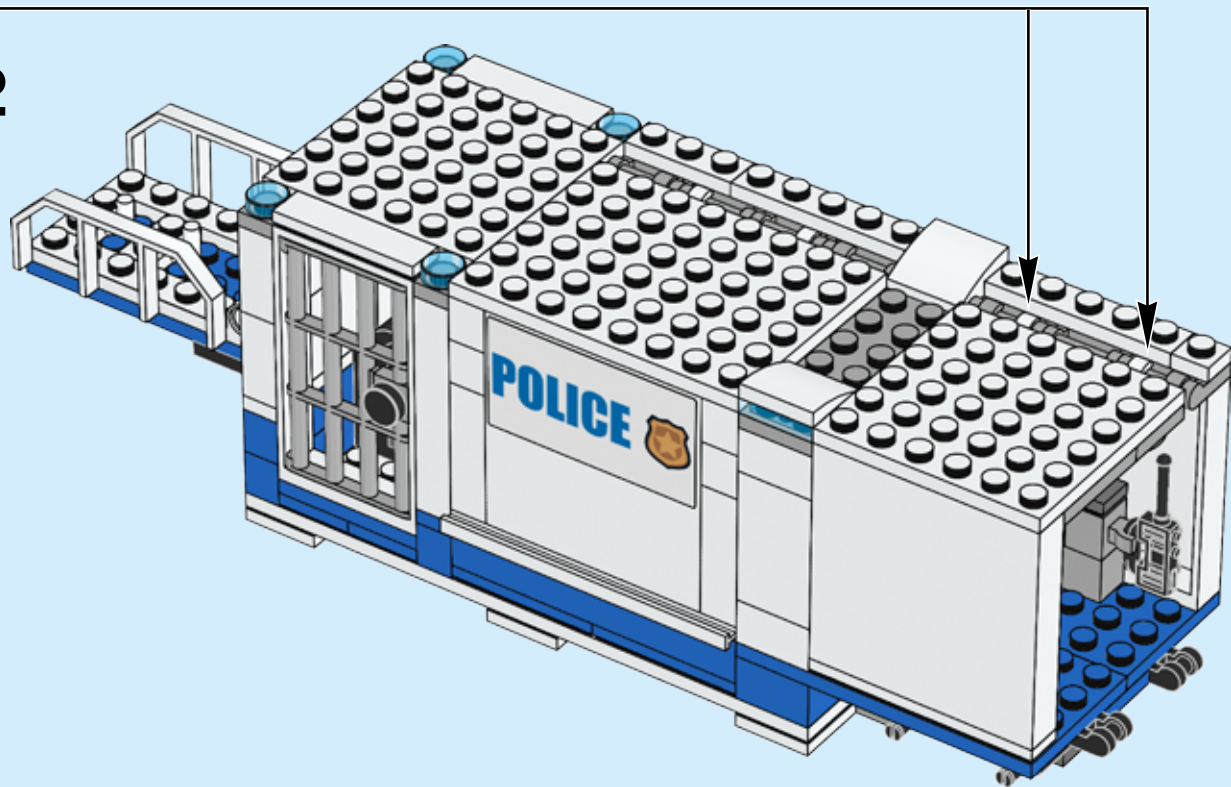

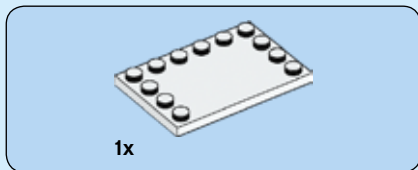
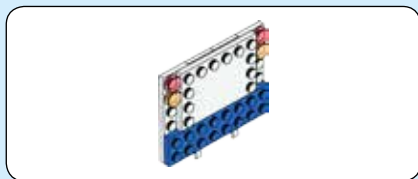

73

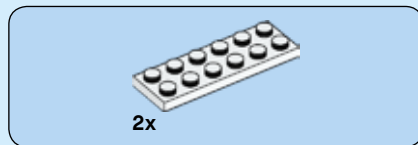
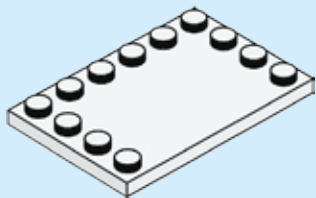

74

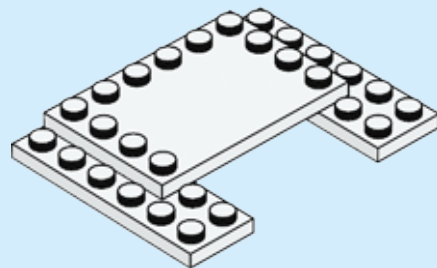



2x



2x

# 75

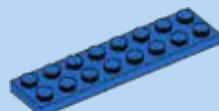
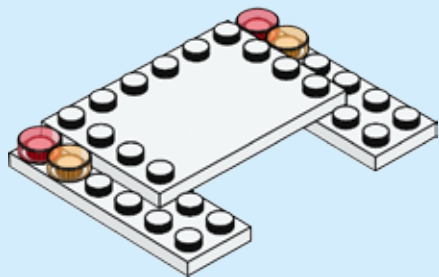

1x

# 76

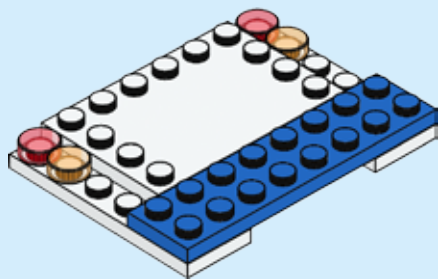





2x

77

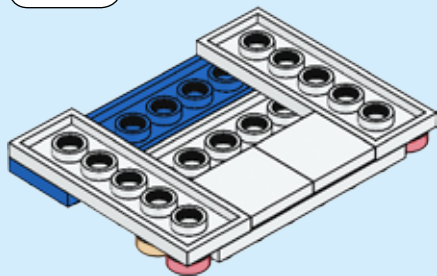
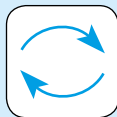

1x

78

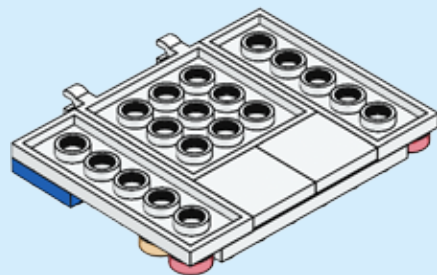

79

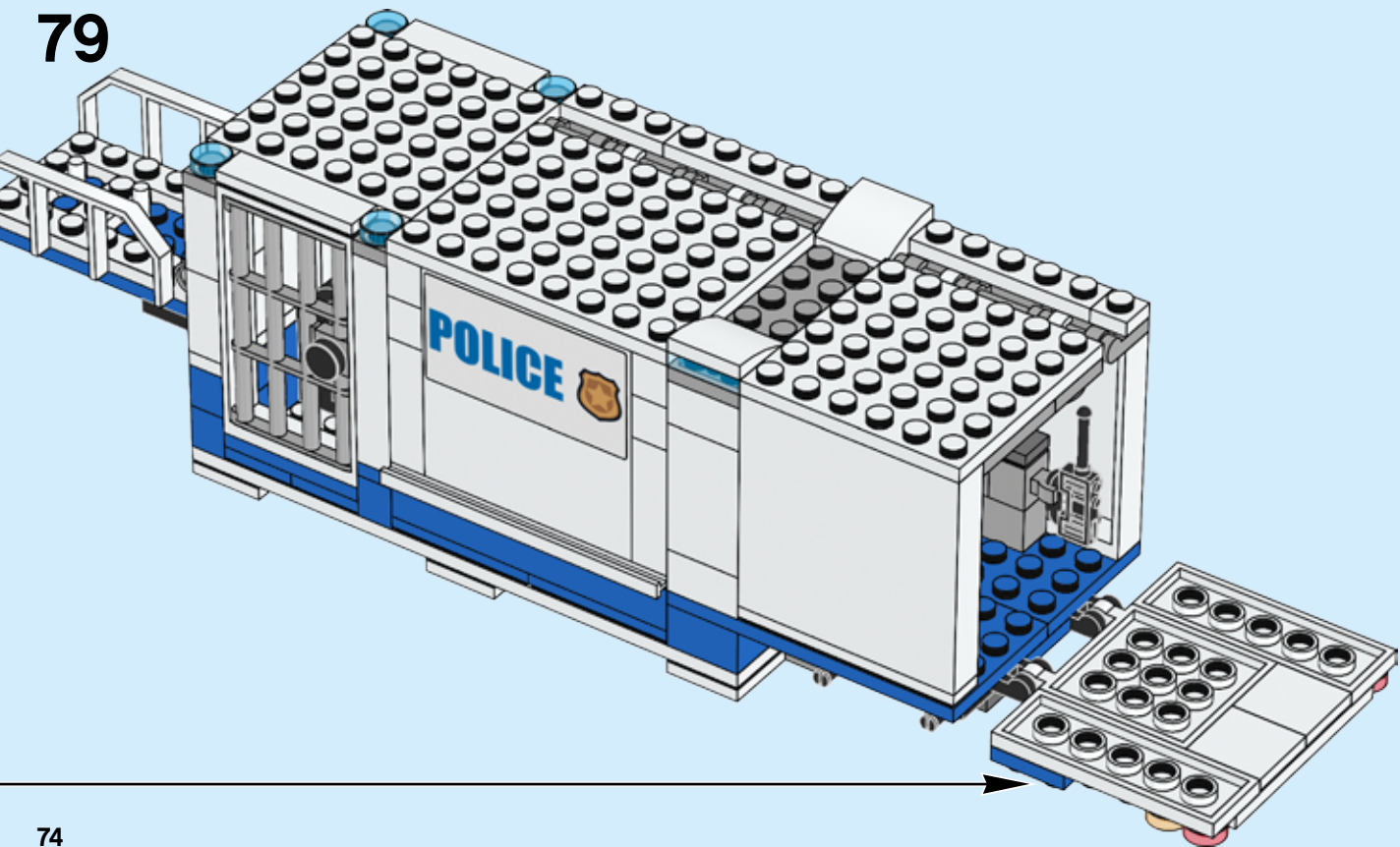

74



80

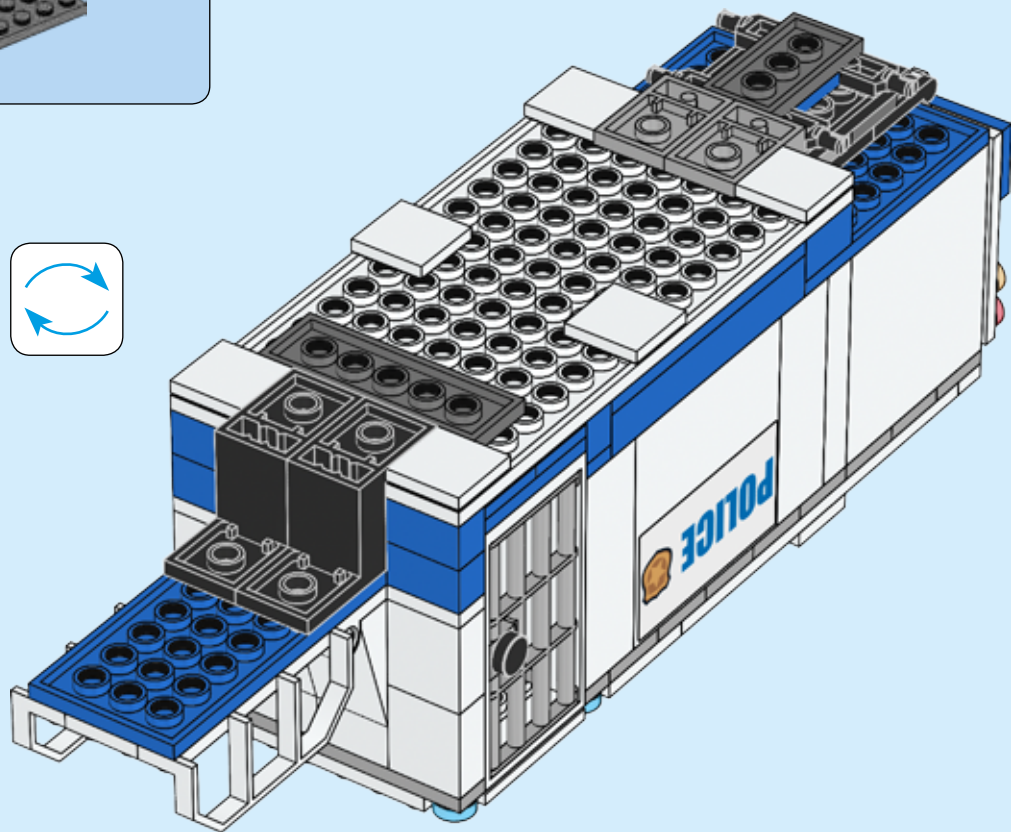
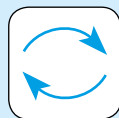



2x

81

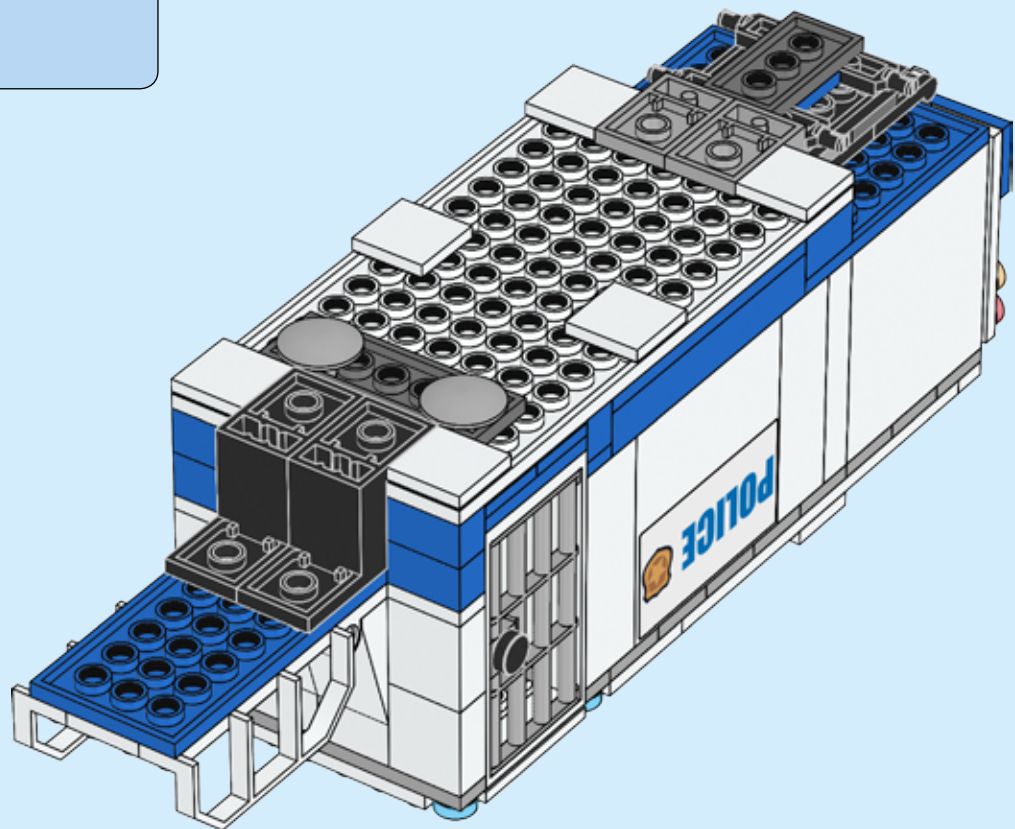

76

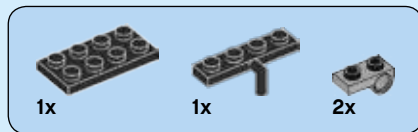

82

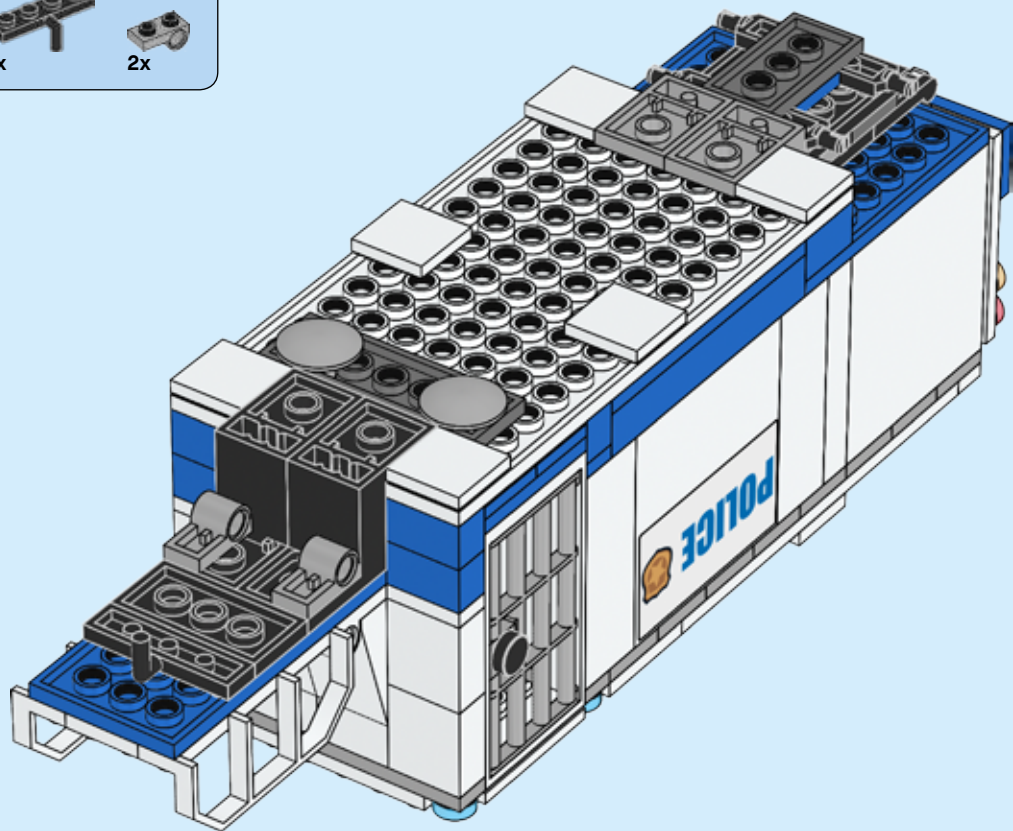



# 83

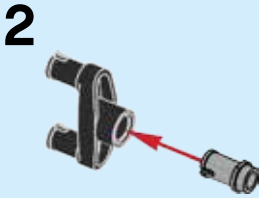

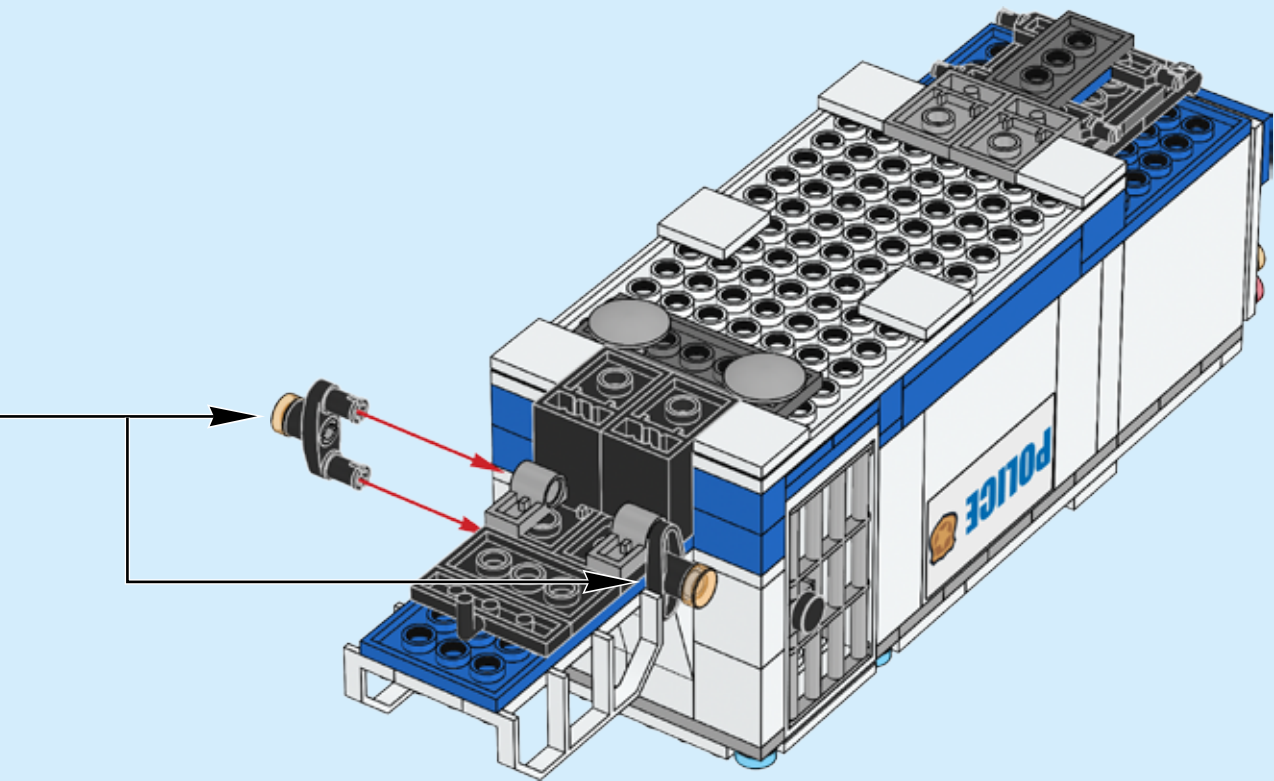

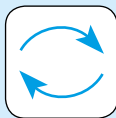

84

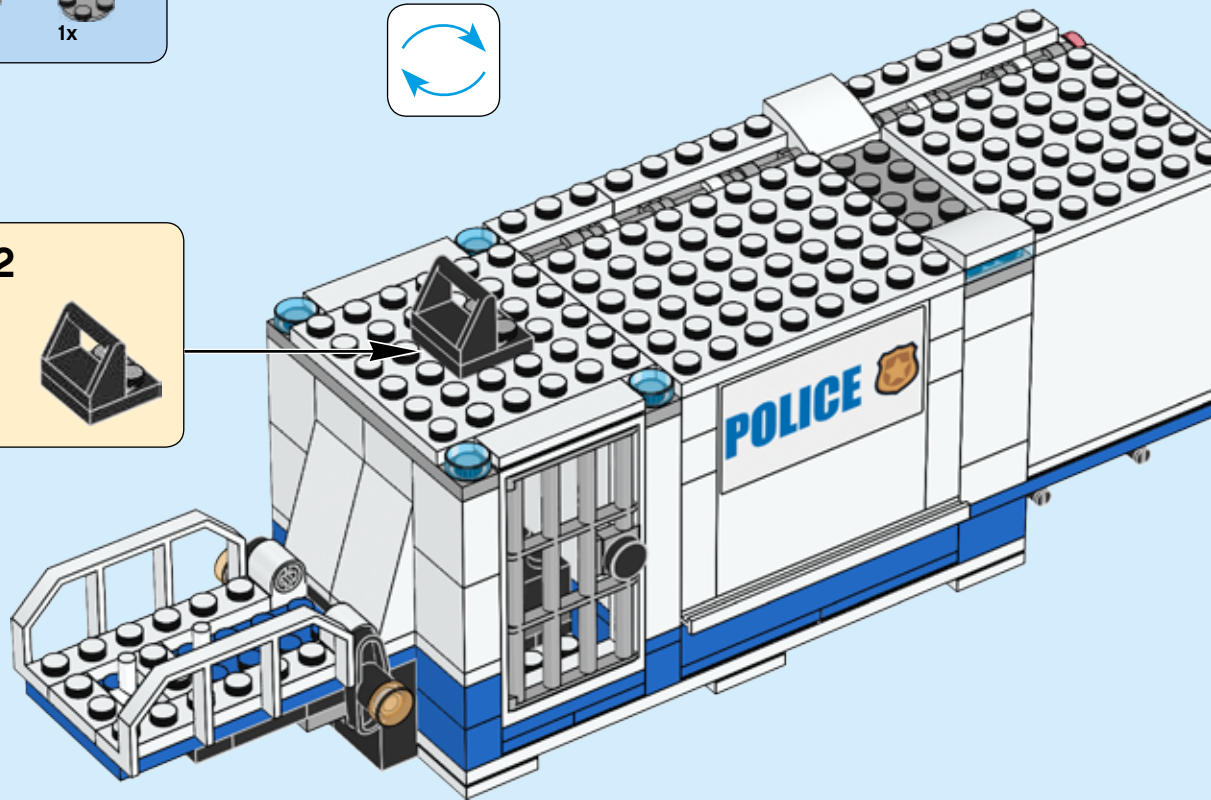
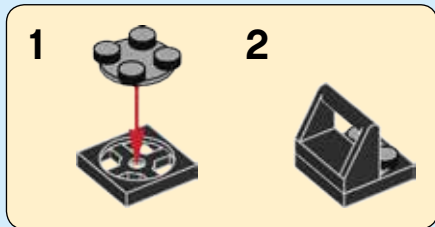





2x



1x



1x

# 85

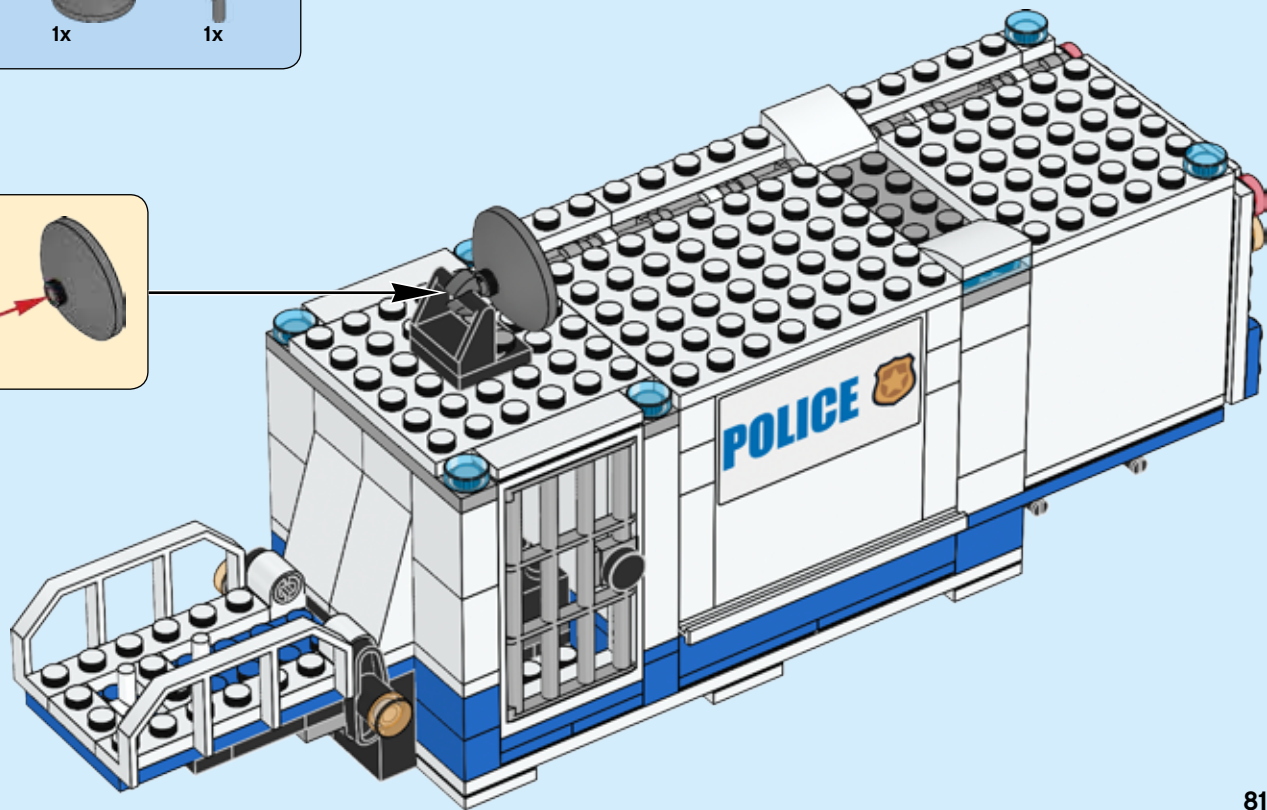
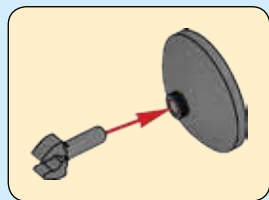

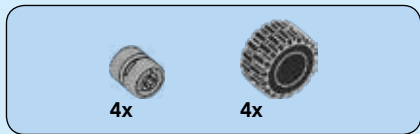

86

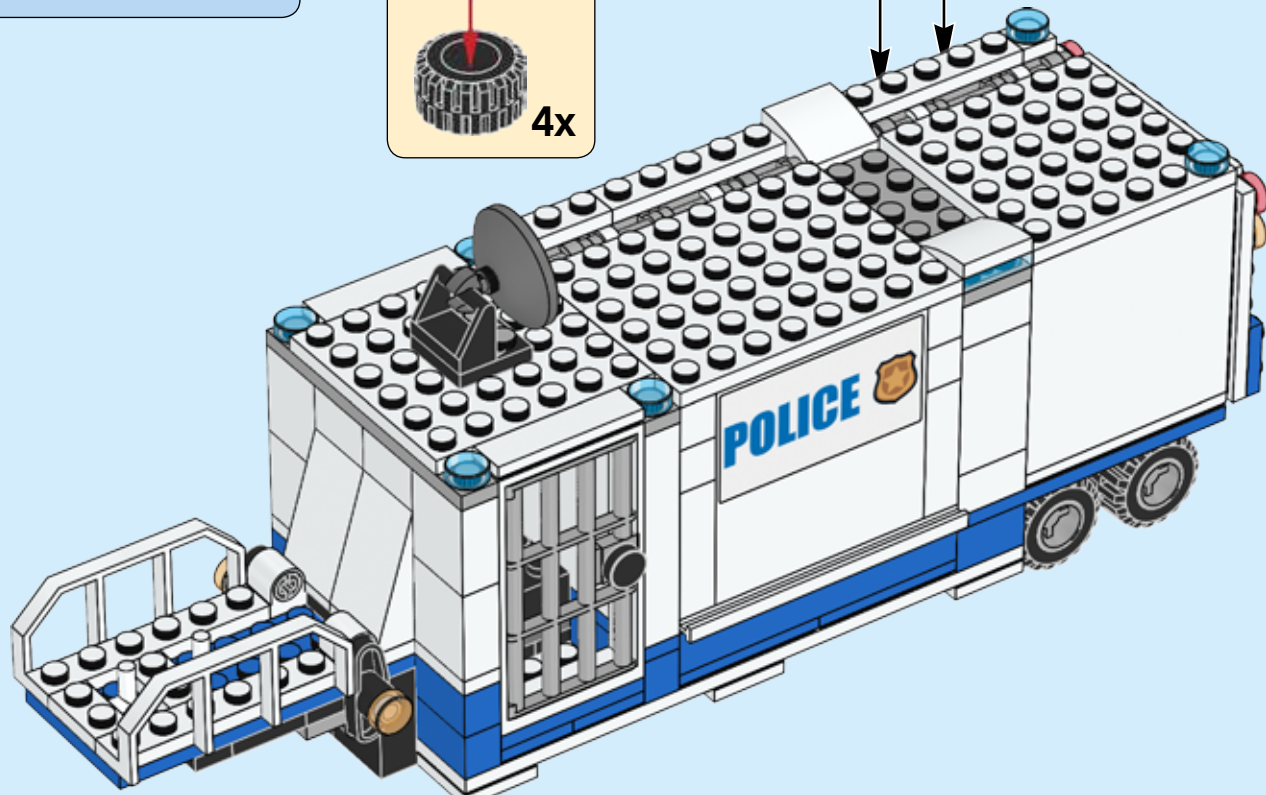
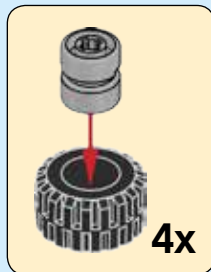



87

