



# CITY

60016



**WARNING:** CHOKING HAZARD.  
Small parts. Not for children under 3 years.



**AVERTISSEMENT : RISQUE D'ÉTOUFFEMENT.**  
Contient des petites pièces. Ne convient pas aux enfants de moins de 3 ans.



**ADVERTENCIA: PELIGRO DE ASFIXIA.**  
No recomendado para niños menores de 3 años. Contiene piezas pequeñas.

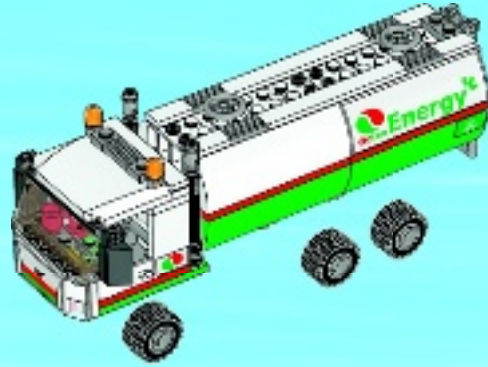
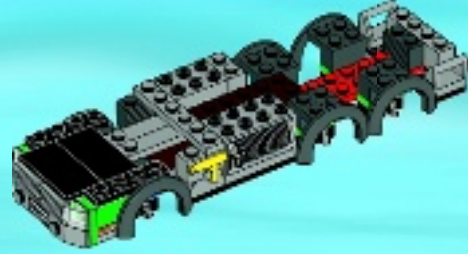
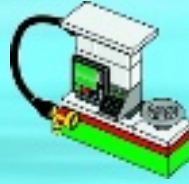

1

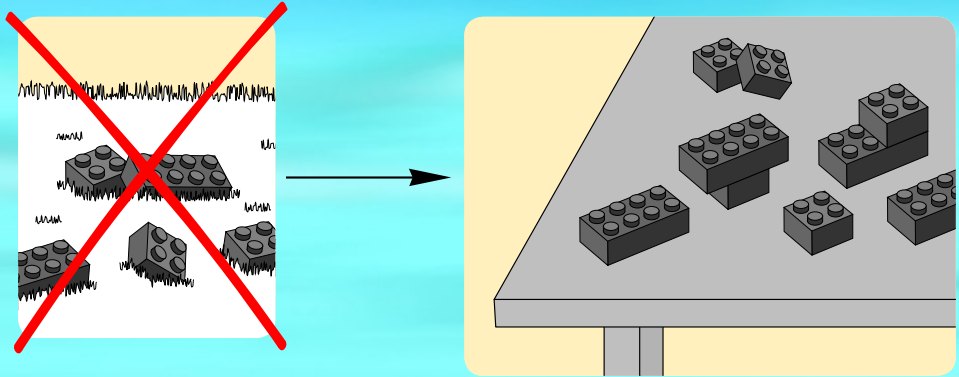

2

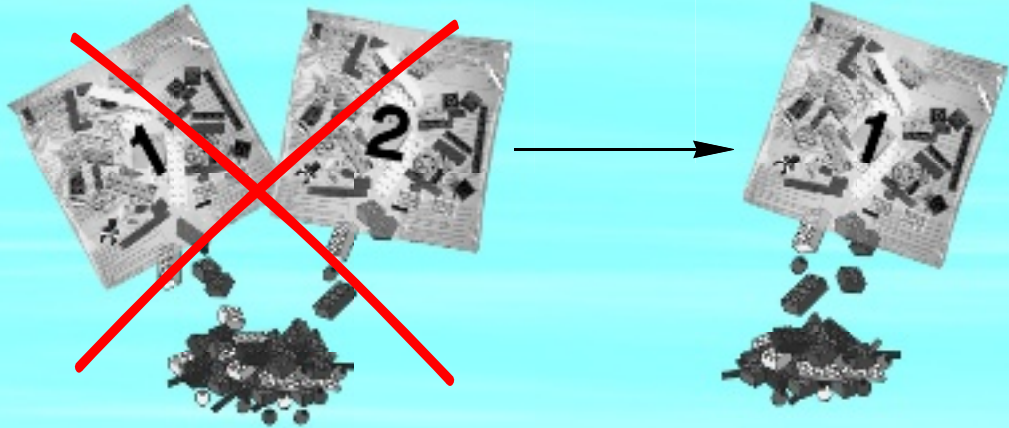

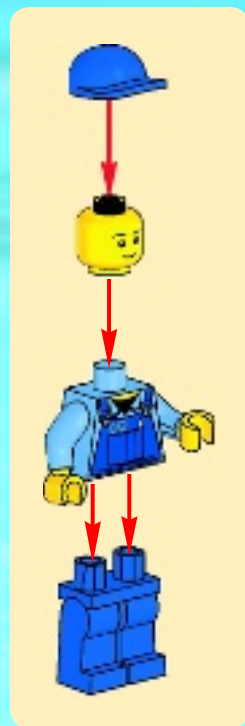
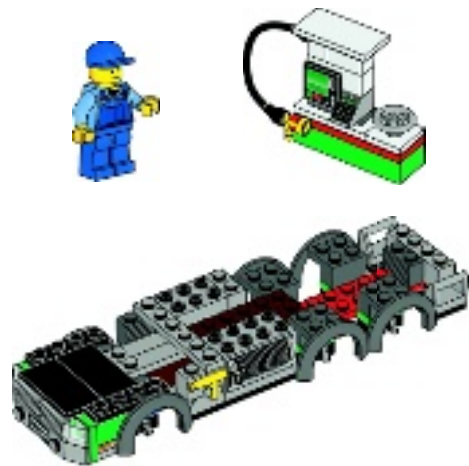

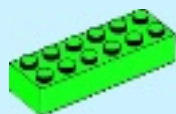

1x

1

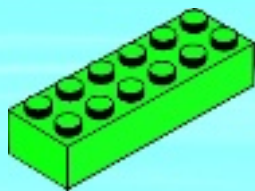

1x



1x



1x

2

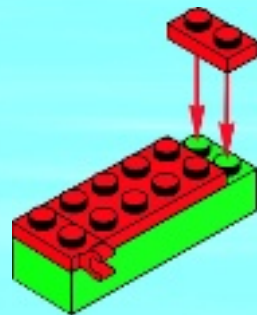



3x

3

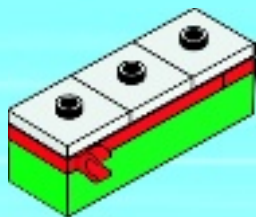

1x



1x

4

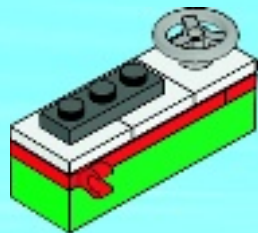



1x



2x

5

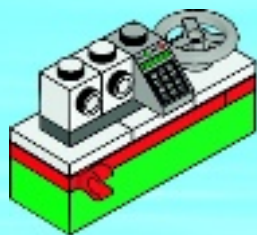

1x

6

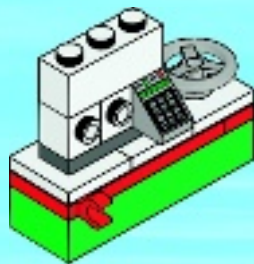



1x



1x

7

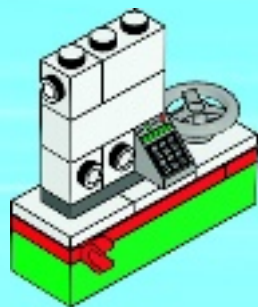

8



1x

8







1x

9

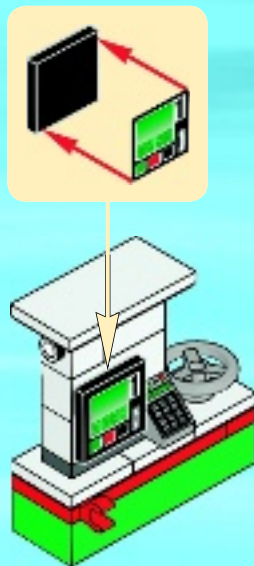



1x



1x

# 10

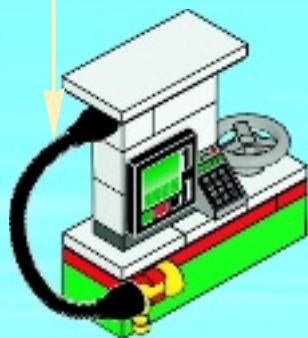
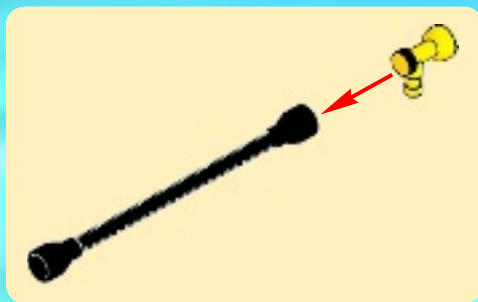

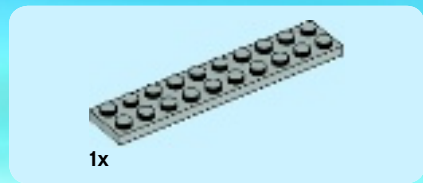

1

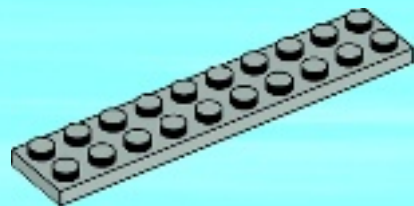



1x



1x

2

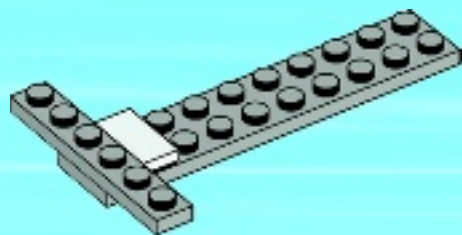

1x



2x

3

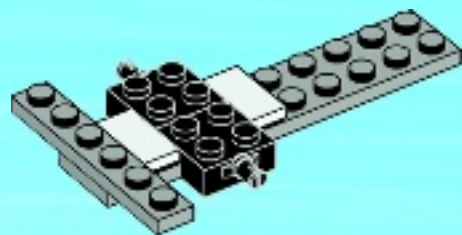

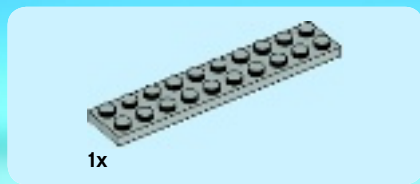

4

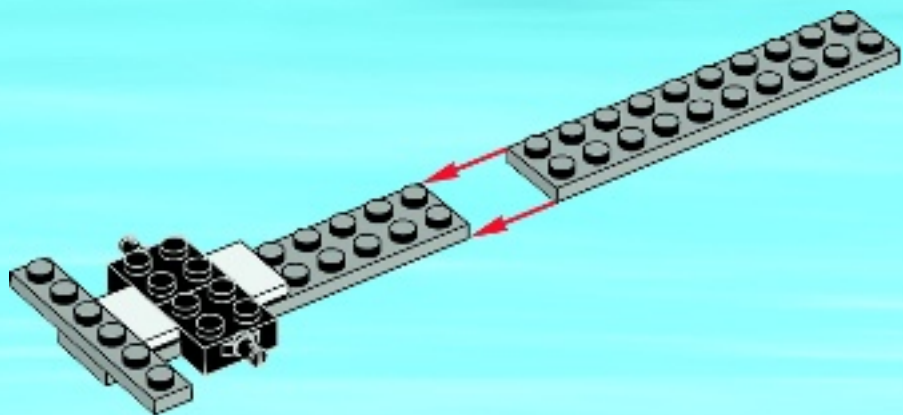



1x

5

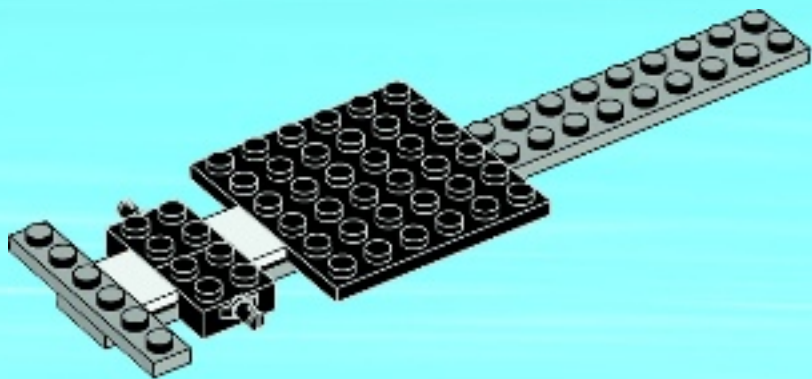



1x



2x



1x

# 6

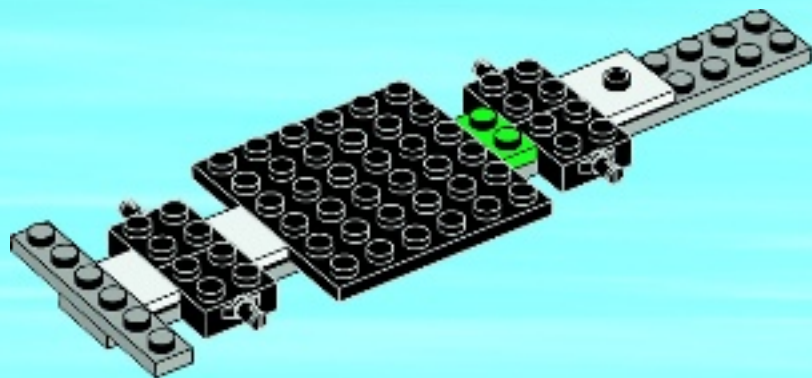



7

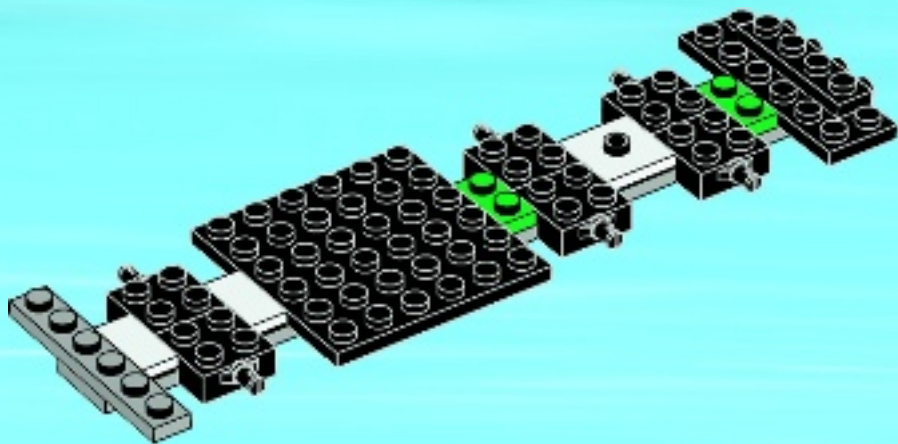





1x



2x

8

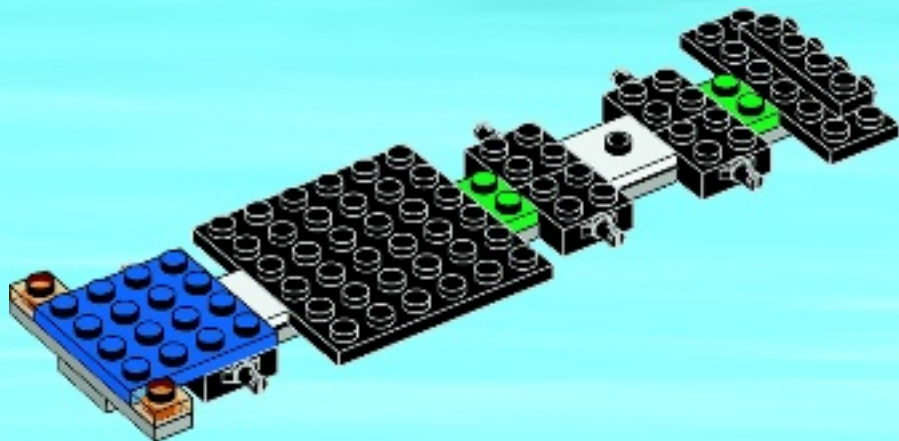

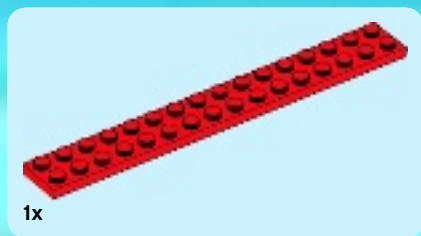

9

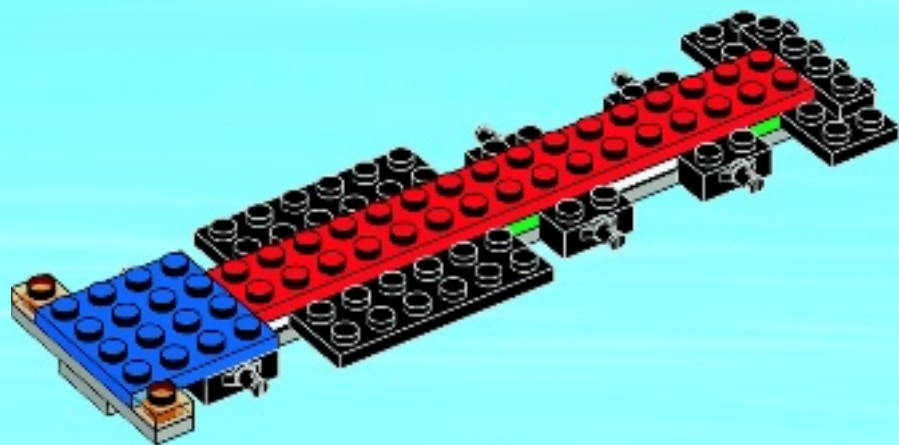



2x



1x

10

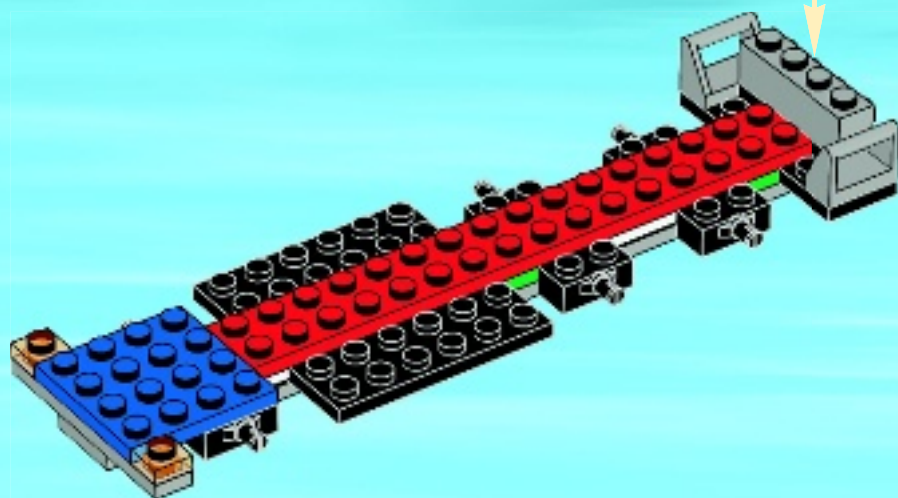
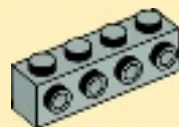



4x

11

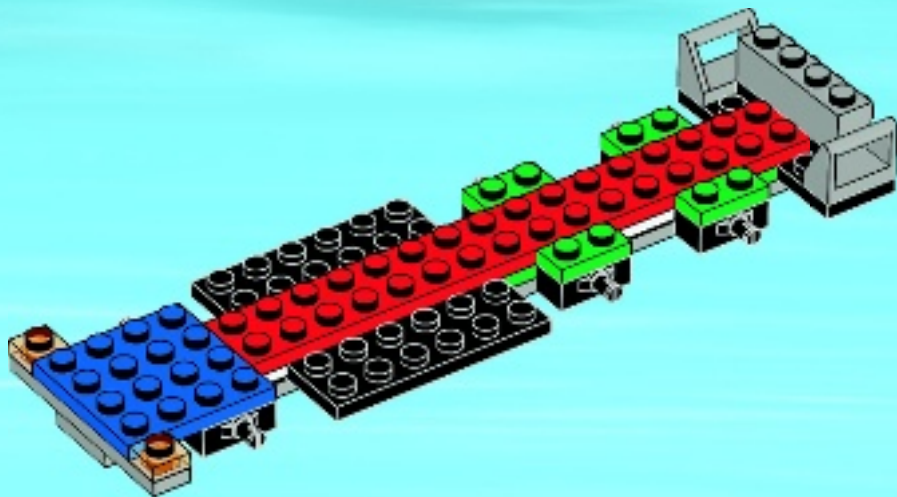



4x



1x

# 12

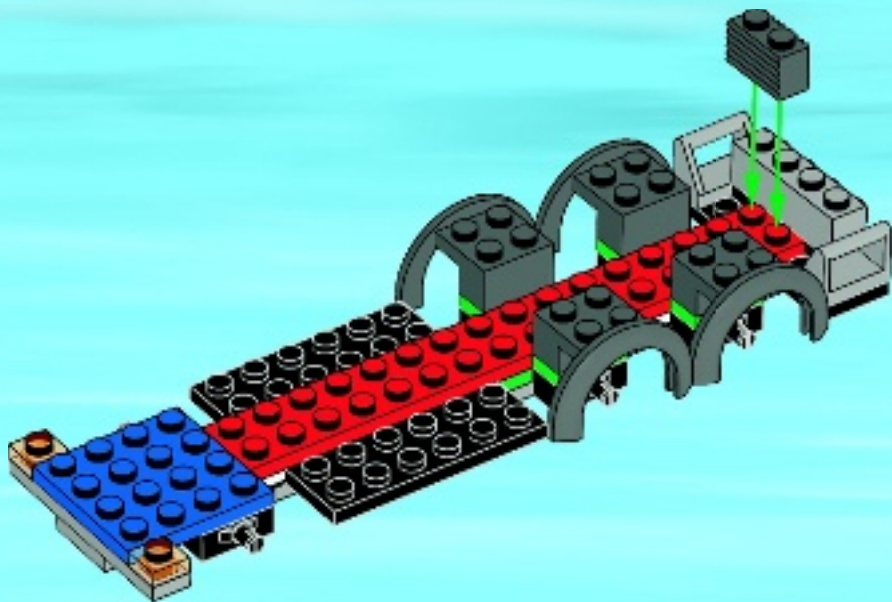



1x

13

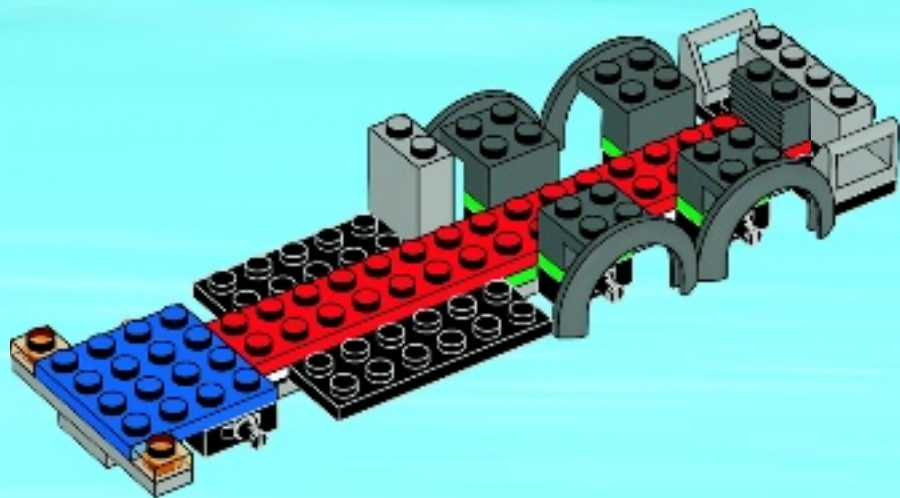



2x

14

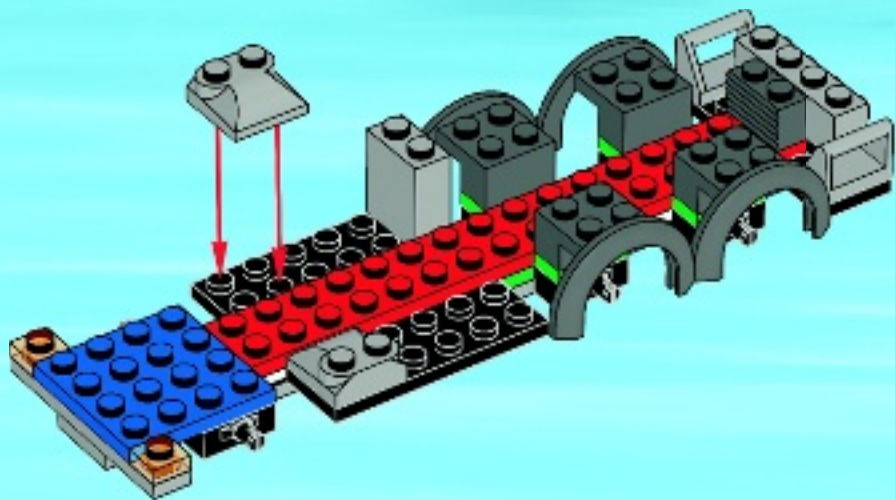



1x



1x



1x



1x

# 15

## 1



## 2



## 3

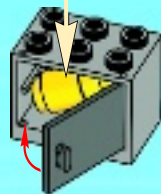



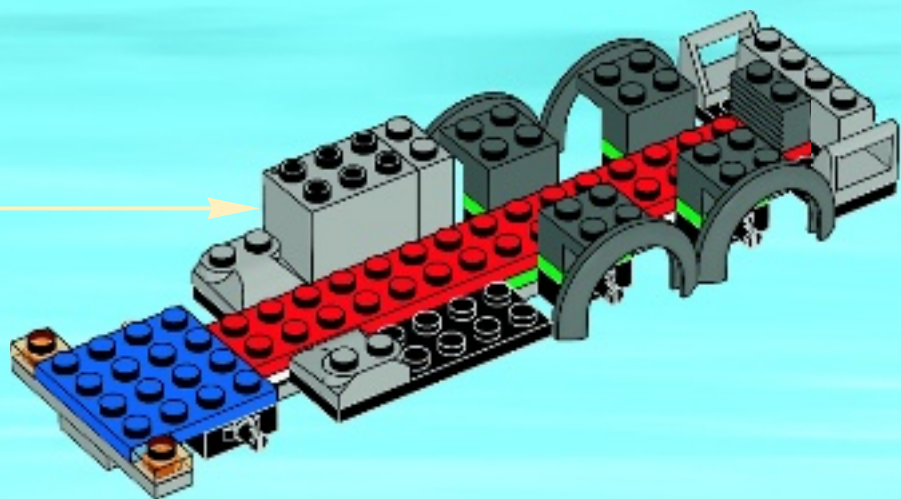



2x



1x

# 16

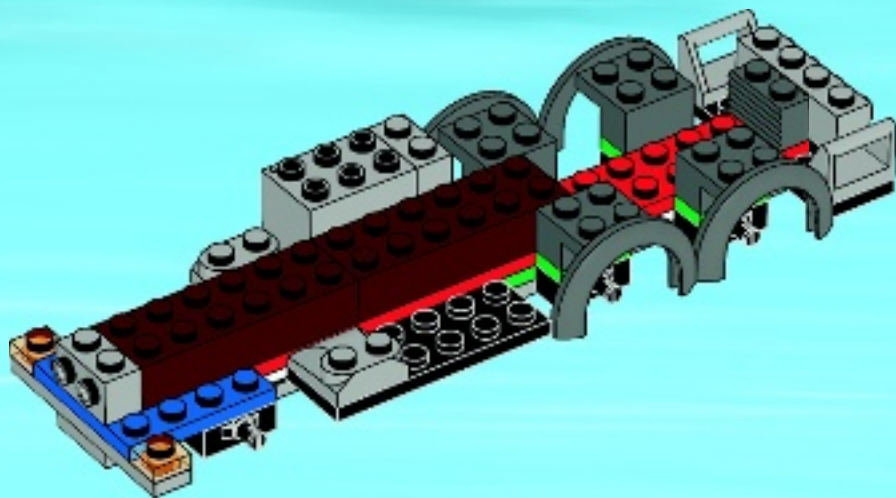



1x



1x

17

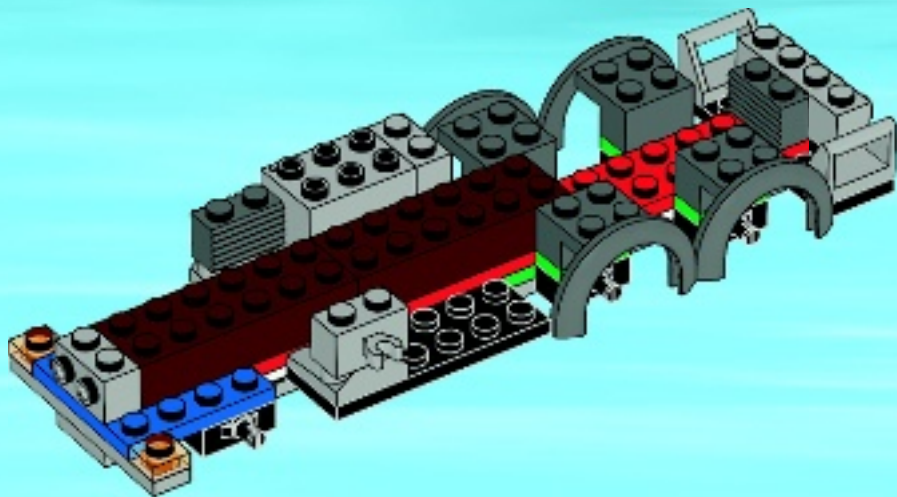

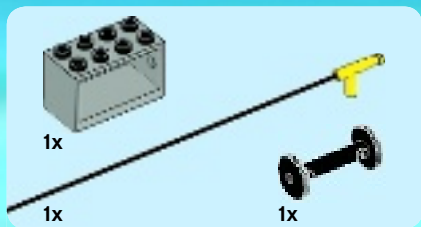

18

1



2

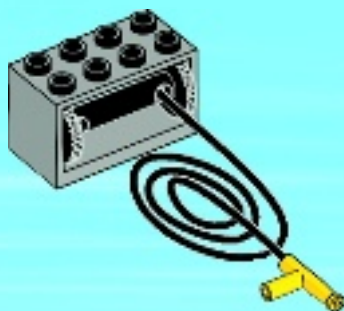

3

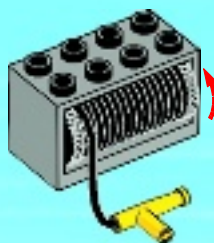

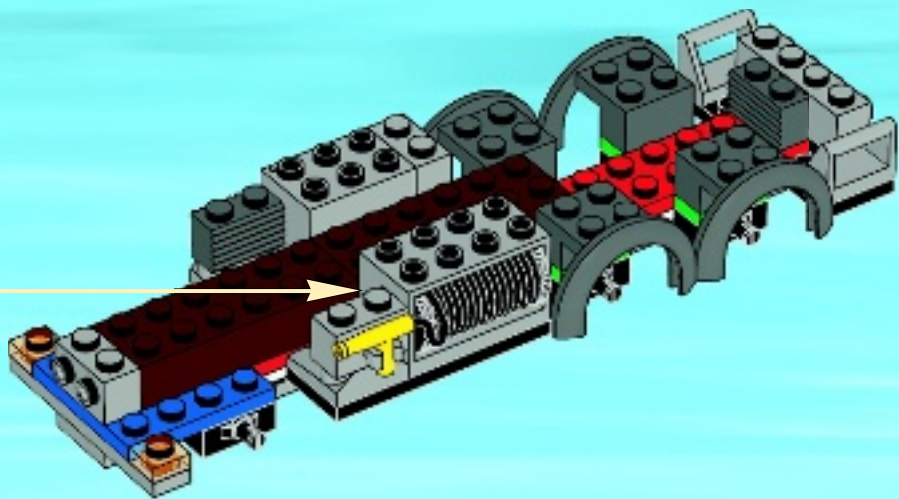



2x

19

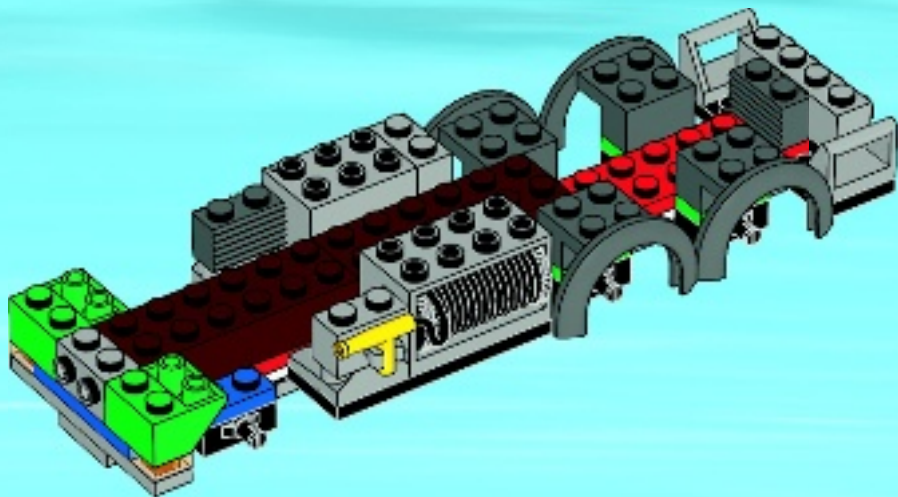



2x

20

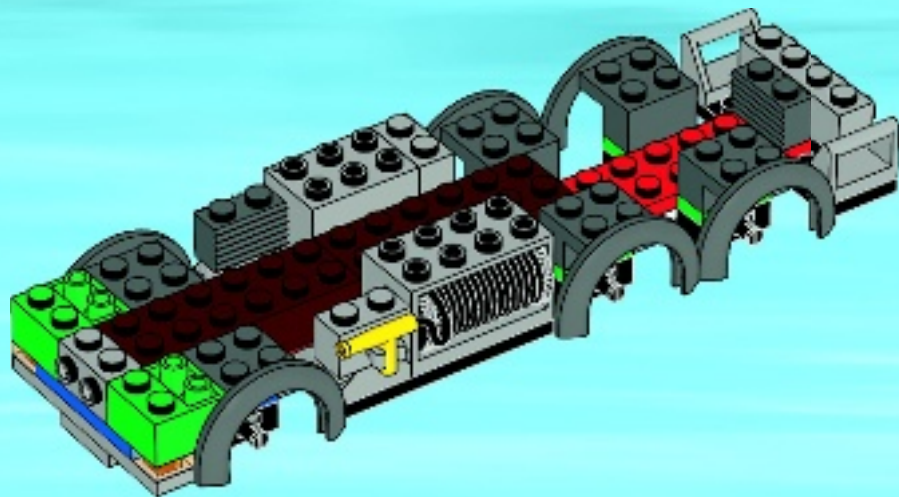



2x

21

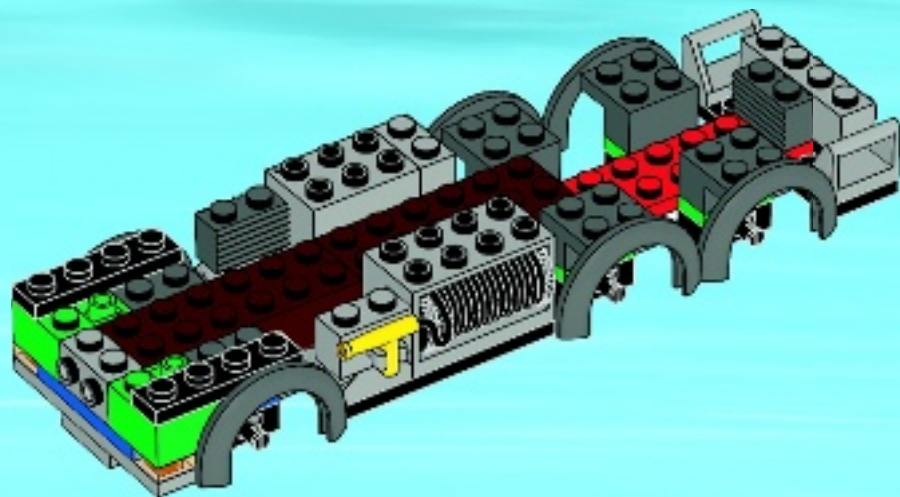



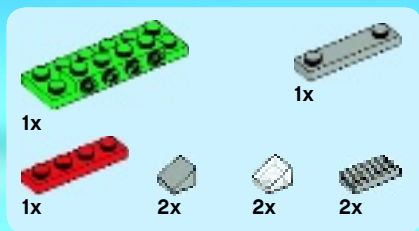

# 22

1

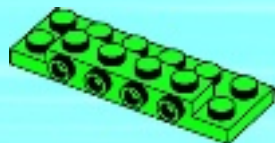

2

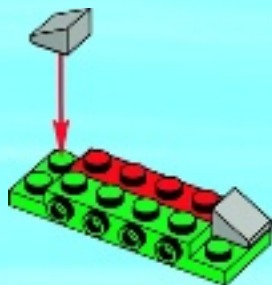

3

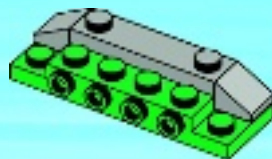

4

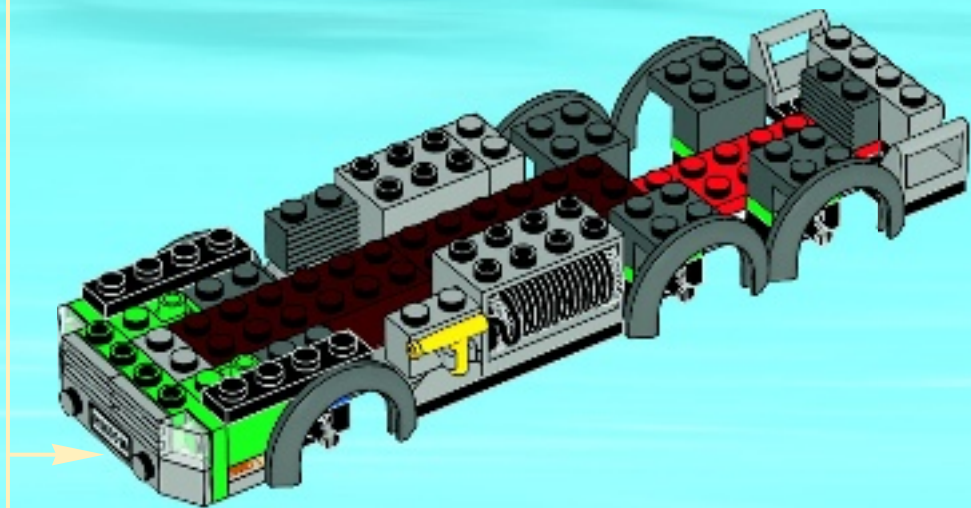
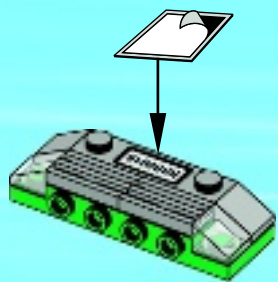



2x



2x

# 23

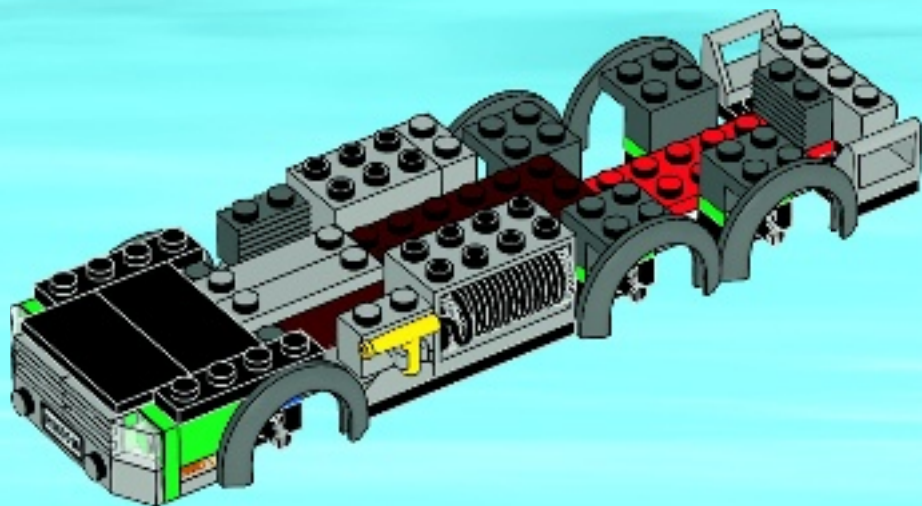



1x

# 24

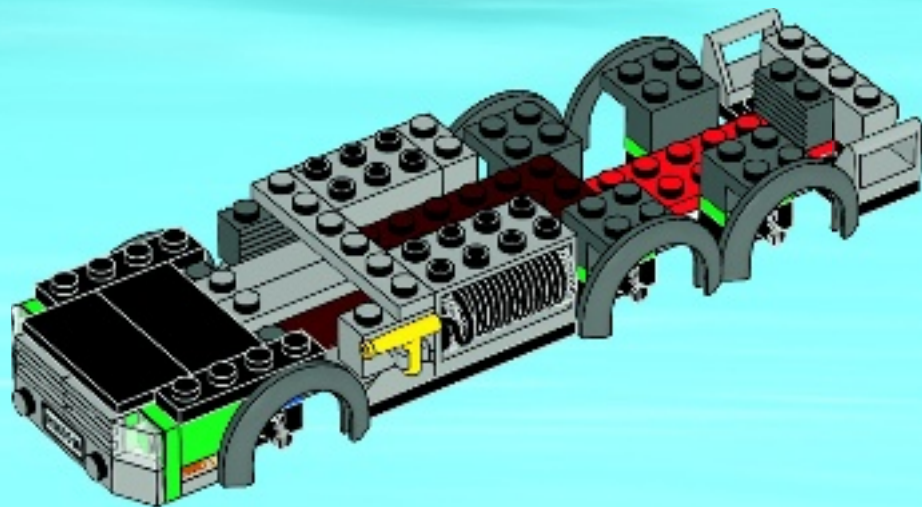



25

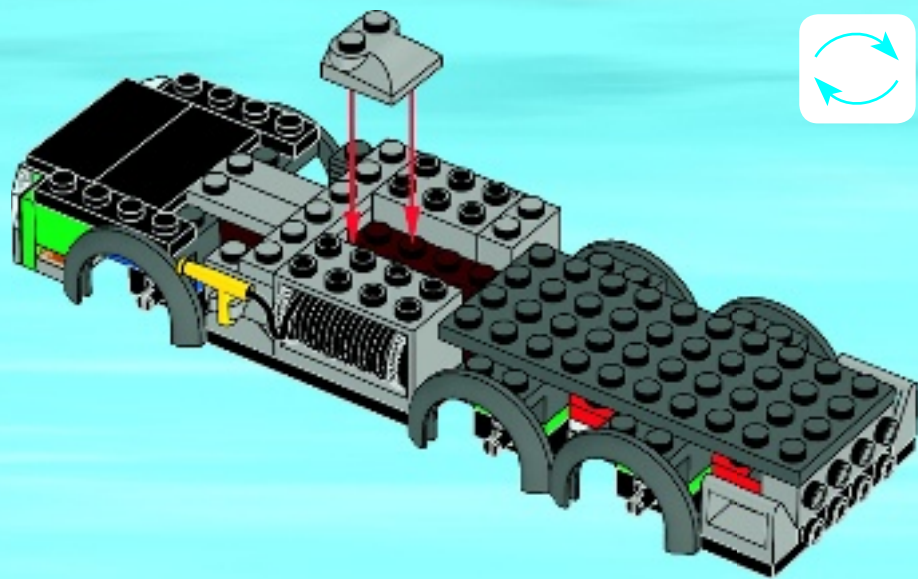

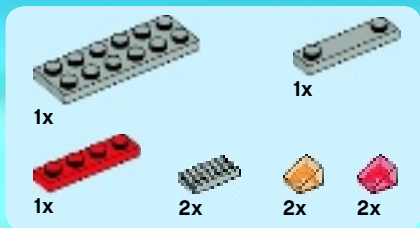

# 26

1

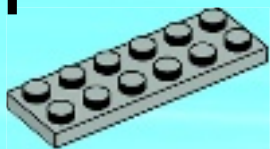

2

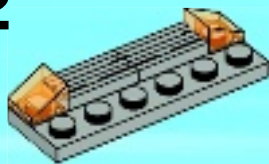

3

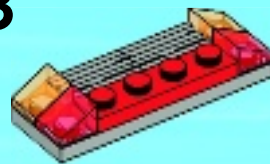

4

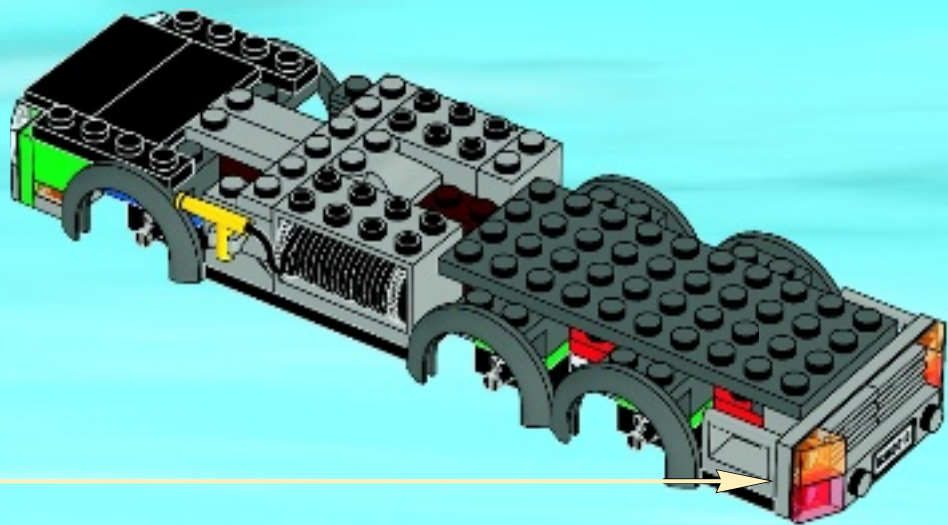
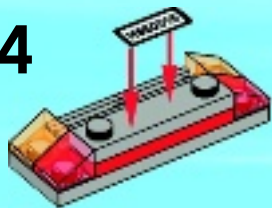



2x



2x

# 27

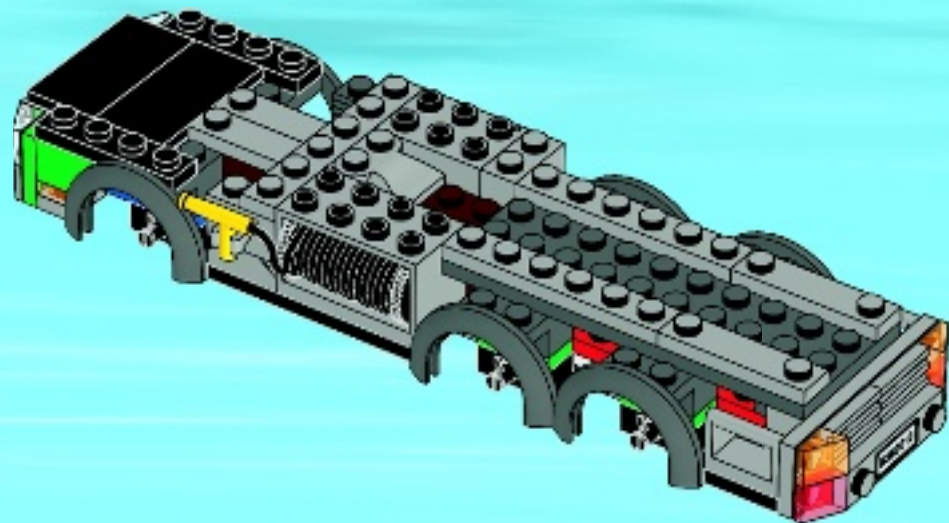



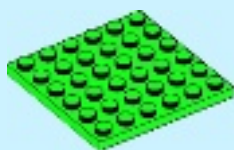
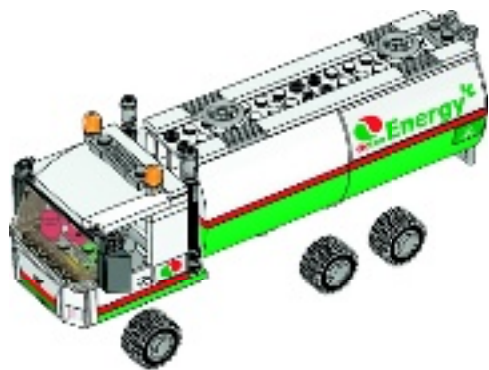

1x

1

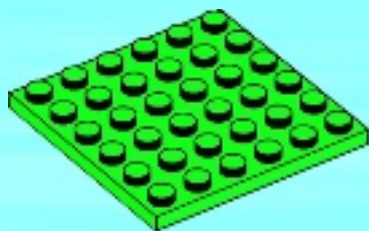



1x



2x

2

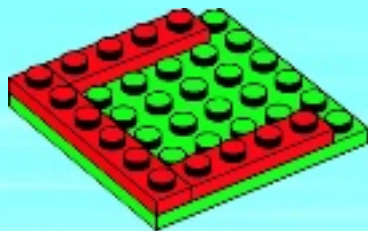



2x

3

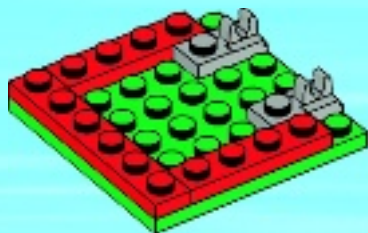

1x

4

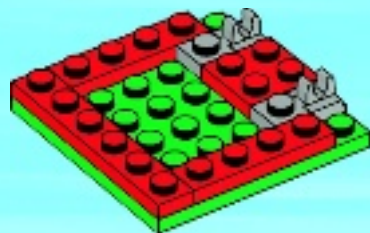



2x



2x

# 5



2x

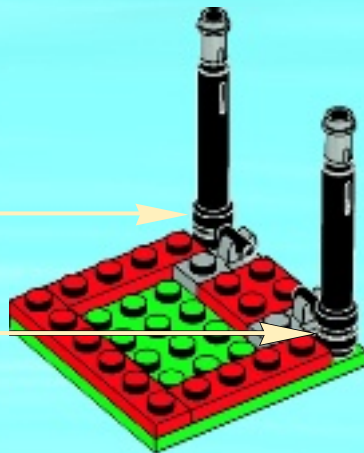



1x

6

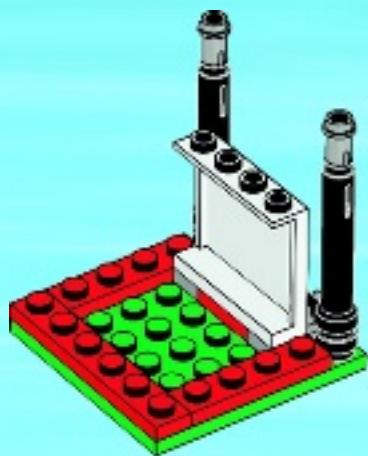

2x

7

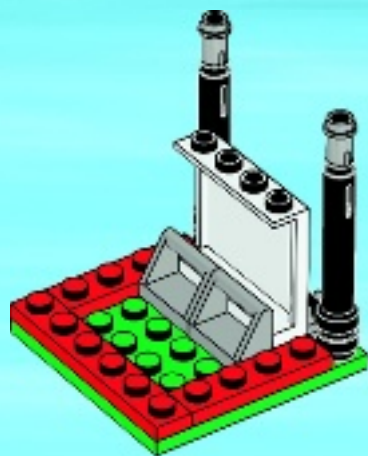



2x

8

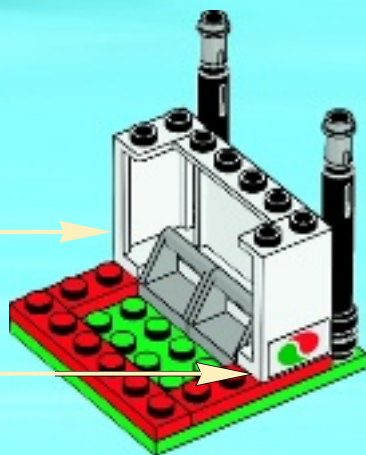
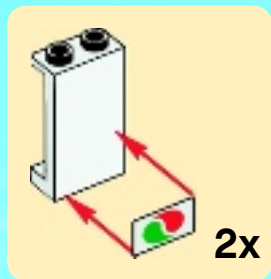



1x



1x

9

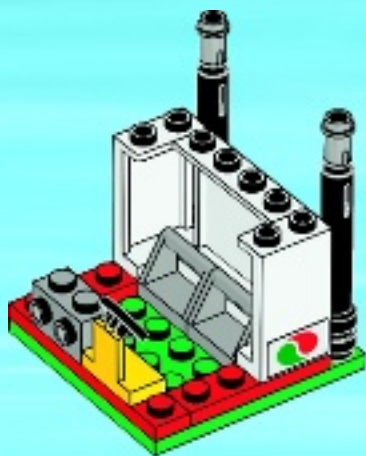

1x



1x



1x

10

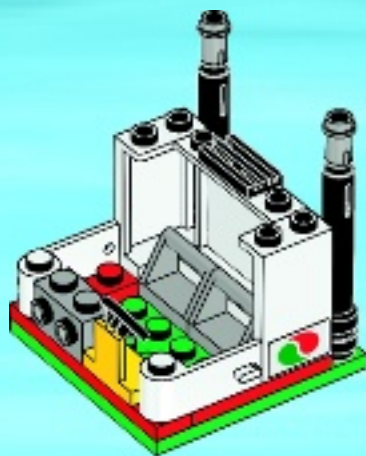

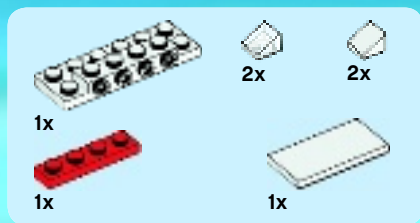

# 11

1

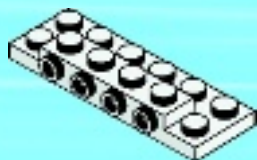

2

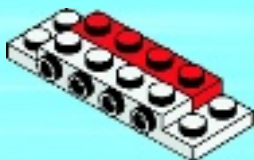

3

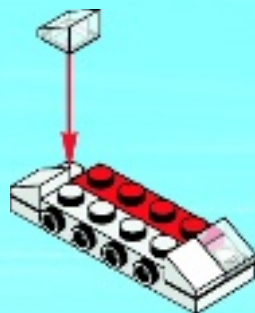



4

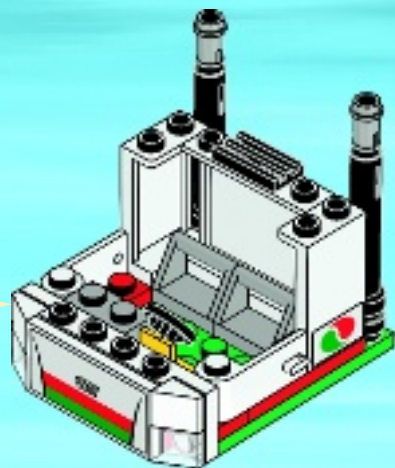
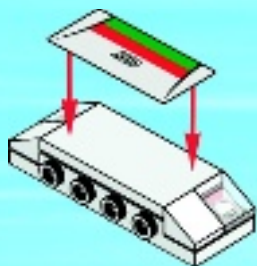



2x



1x

# 12

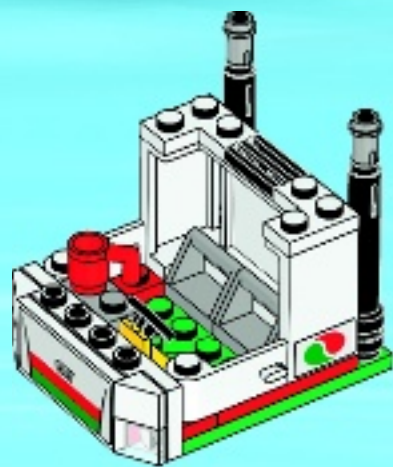

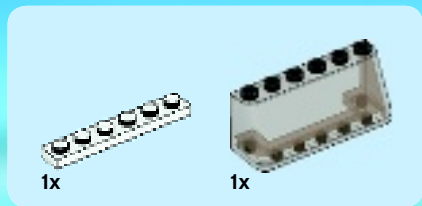

13

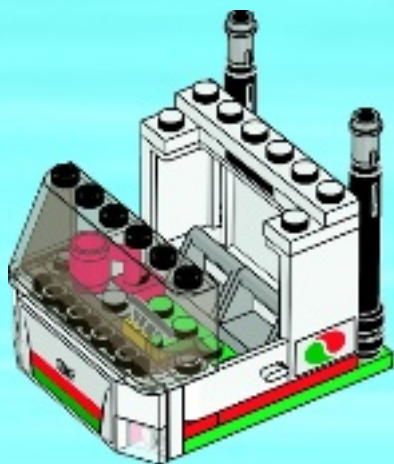

14





1x

15





1x



2x

# 16

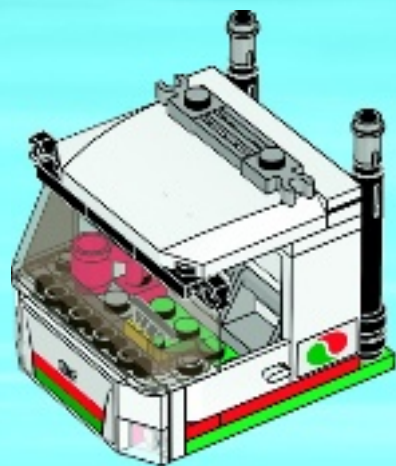

2x

# 17





2x



2x

# 18

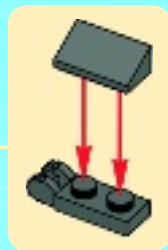
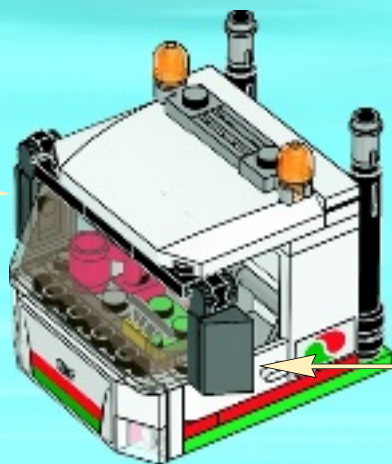
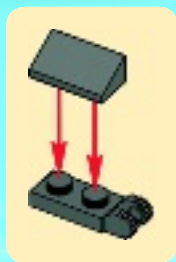

19

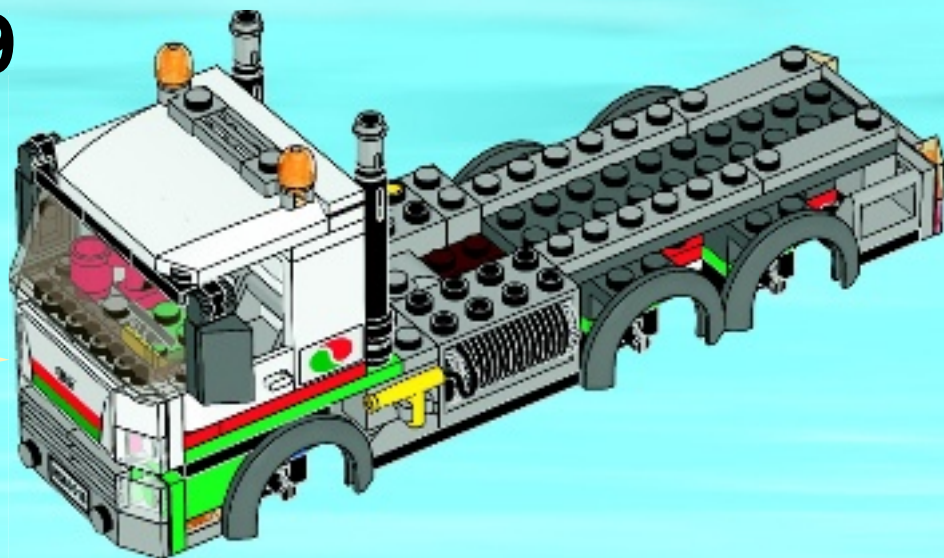

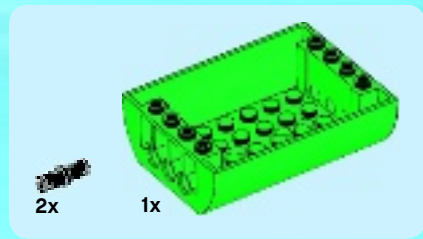

1

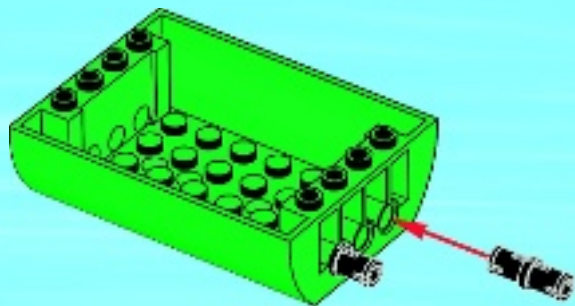



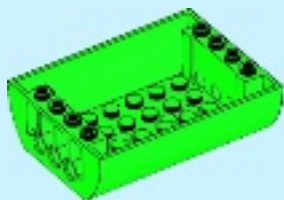

1x

2

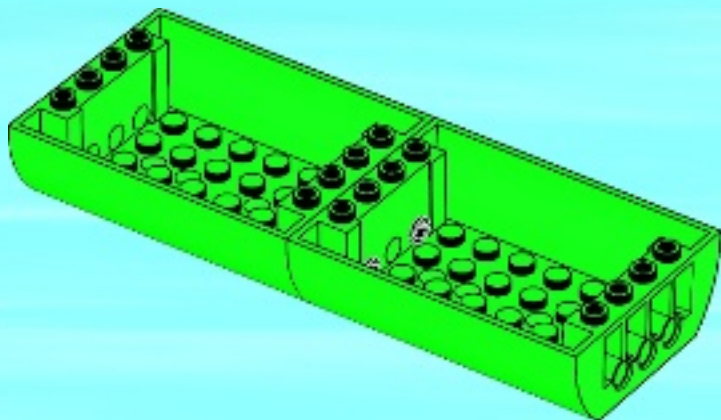



4x



2x

3

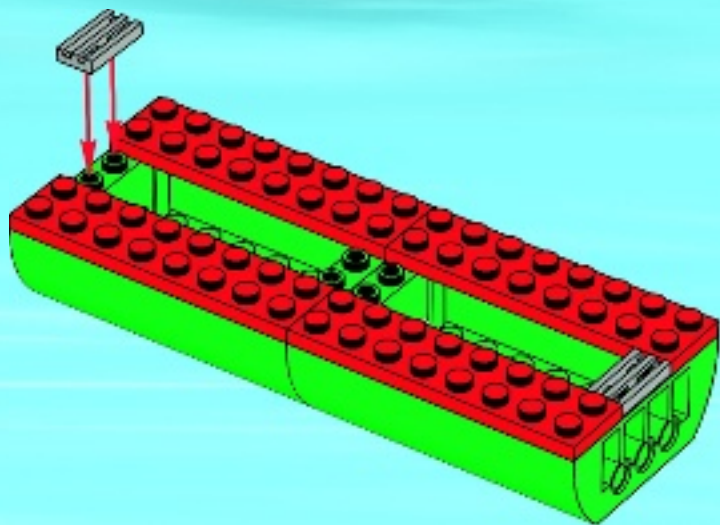



4

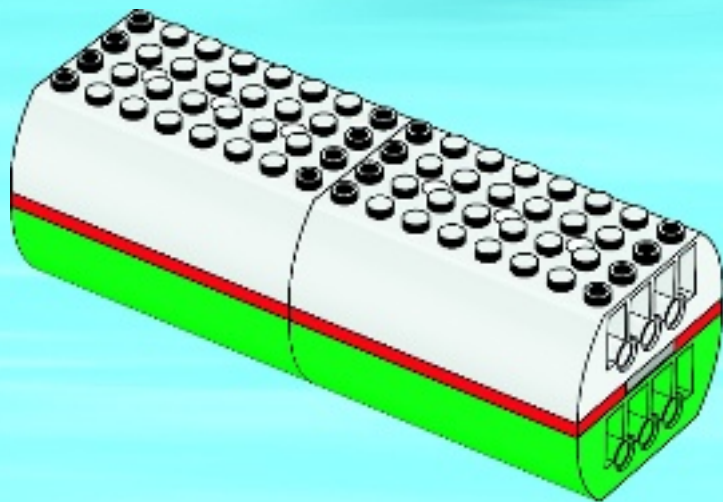



5

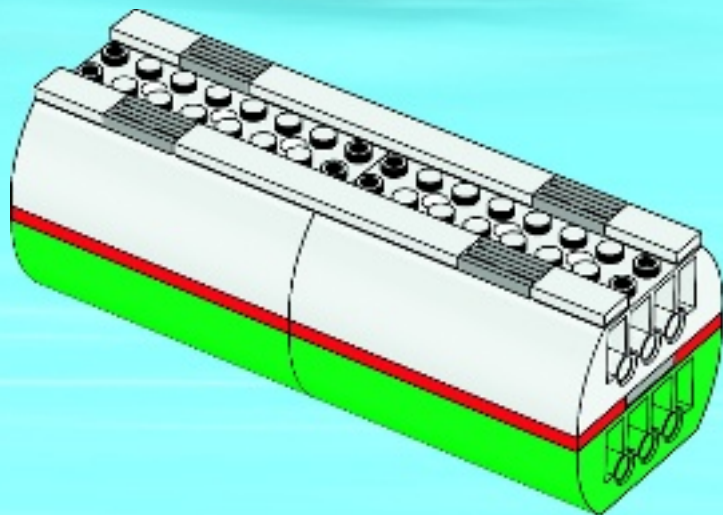



1x



2x

6

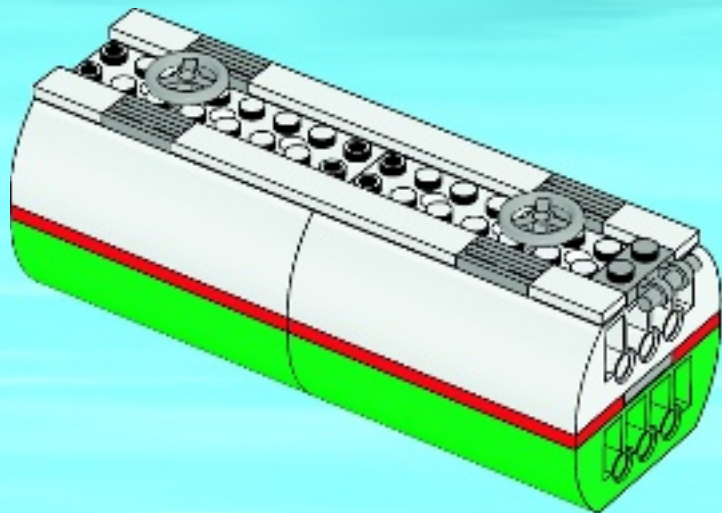

7

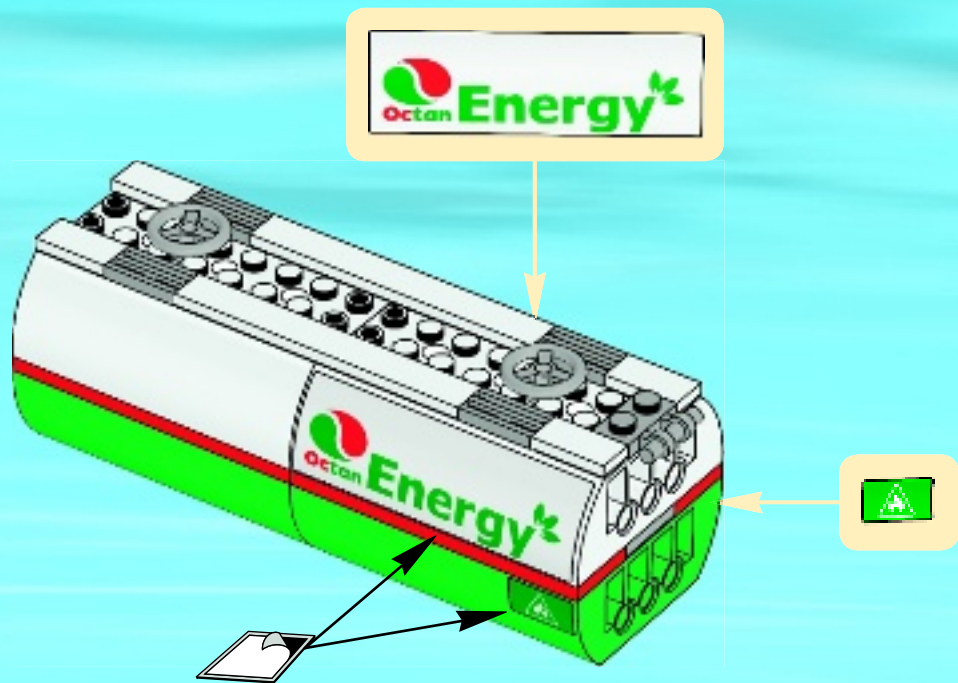

8

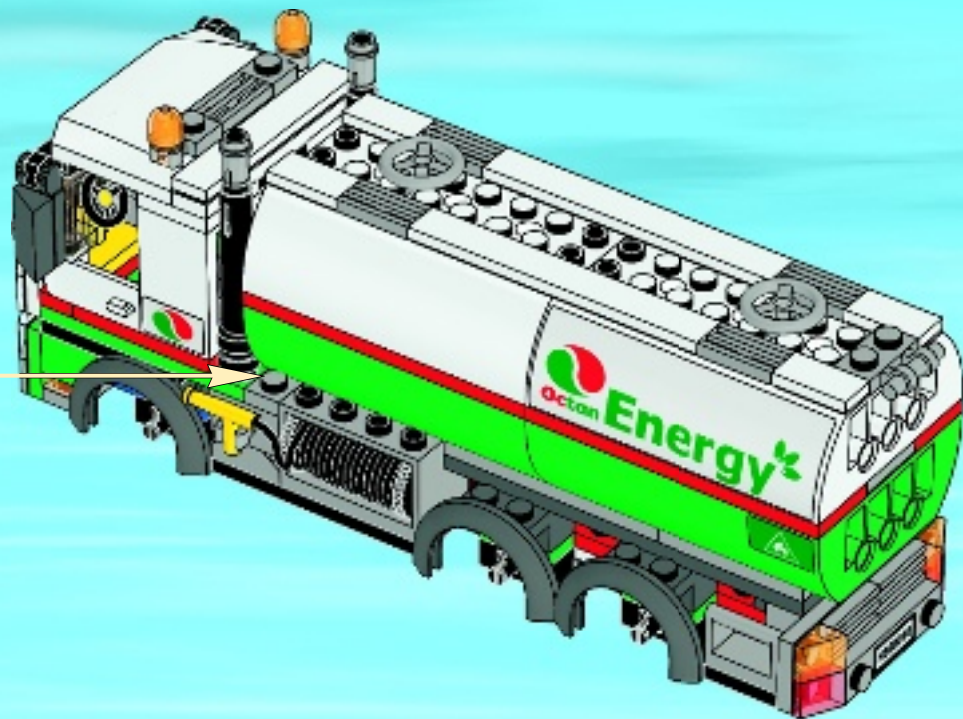

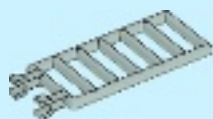

1x

9

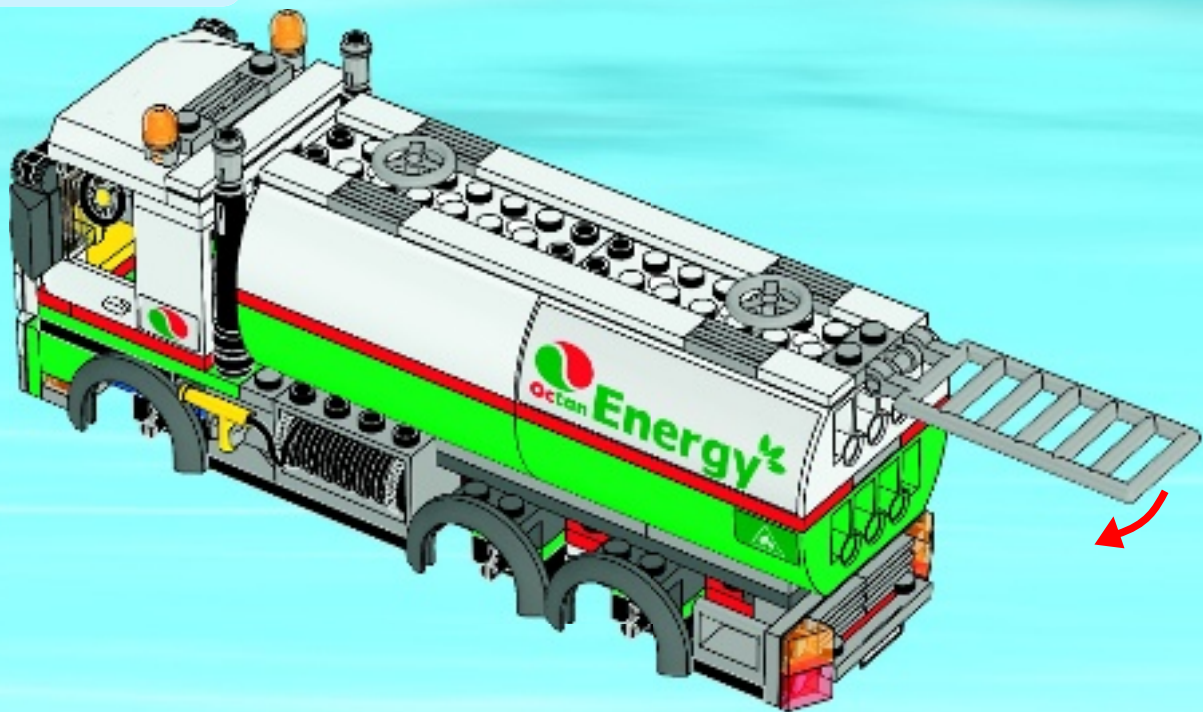





6x



6x

10

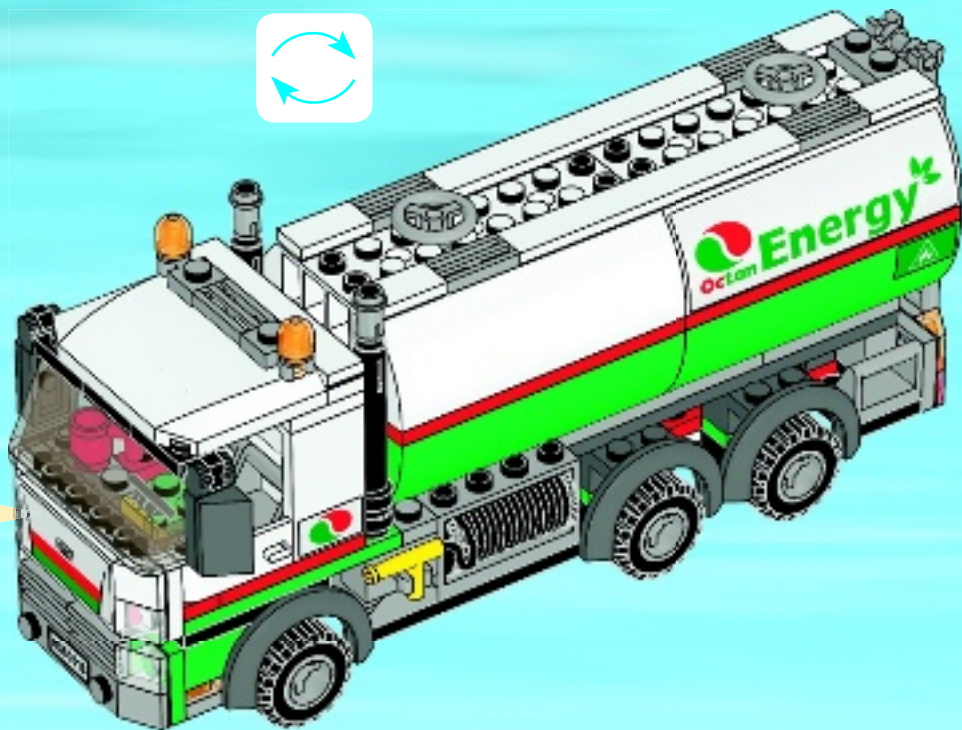
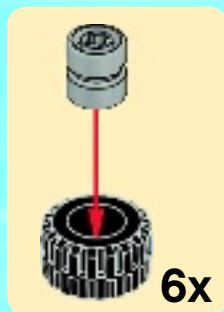



**LEGO** CITY

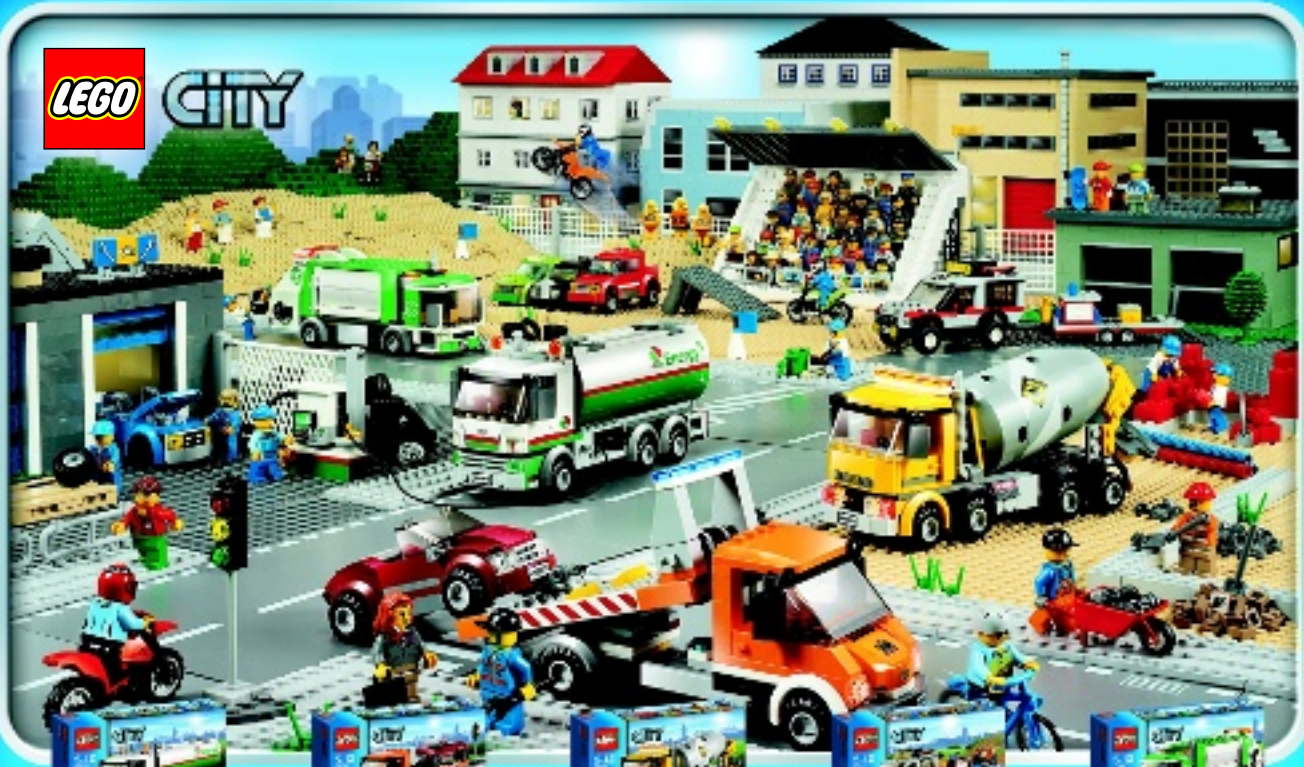

60016



60017



60018



4432



4433



CITY



60004



60003



60002



60001



60000



CITY

LEGO.com/city

**EXPLORE TONS OF GAMES,  
MOVIES AND FUN CHALLENGES  
DÉCOUVRE DE NOMBREUX FILMS,  
JEUX ET DEFIS AMUSANTS**





1x  
300401



1x  
362201



3x  
4558952



2x  
4504369



4x  
4565324



2x  
242001



1x  
366601



6x  
306901



2x  
4560178



1x  
663601



2x  
416201



2x  
4585448



1x  
4558208



2x  
6021716



1x  
4527637



1x  
4261565



1x  
4537987



1x  
4560929



1x  
302321



1x  
302221



5x  
371021



1x  
302021



1x  
366621



4x  
303421



1x  
428221



1x  
4534648



1x  
389921



1x  
4262022



1x  
9553



1x  
306224



2x  
4256320



1x  
4651441



1x  
4243815



1x  
9341



1x  
4567909



2x  
371026



1x  
395826



2x  
241226



2x  
4183043



1x  
306826



2x  
4560182



1x  
4653049



6x  
4568644



6x  
448826



2x  
4569407



1x  
4262023



1x  
4558850



2x  
4121715



1x  
4181135



2x  
4142717

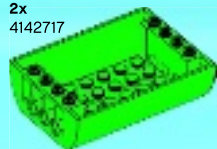

2x  
6021714



6x  
302328



1x  
4626001



1x  
6000070



1x  
4173328



2x  
4244369



2x  
4542673



2x  
4524365



2x  
4216615



1x  
4211564



1x  
4641682



1x  
4610112



1x  
4211636



2x  
4521921



1x  
4228198



6x  
4599498



4x  
4211438



2x  
6015344



2x  
4598526



1x  
4211632



2x  
4594238



1x  
4211452



2x  
4211462

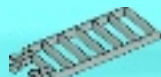

1x  
4275673



11x  
4211350



3x  
4494475



2x  
4520320



1x  
6021710



4x  
4211357



6x  
4211764



3x  
4211701



4x  
4244362



2x  
4244363



1x  
4288003



2x  
4210636



2x  
4567887



1x  
4211133



1x  
4211122



2x  
4210884



1x  
4210811



6x  
4260124



Customer Service

Kundenservice

Service Consommateurs

Servicio Al Consumidor

LEGO.com/service or dial



: 00800 5346 5555

: 1-800-422-5346



# WIN!

Go to [www.LEGOsurvey.com/product](http://www.LEGOsurvey.com/product) to fill out a survey for a chance to win a cool LEGO® Product.

No purchase necessary.

Open to all residents where not prohibited.



## [www.LEGOsurvey.com/product](http://www.LEGOsurvey.com/product)

### GEWINNE!

Nimm an der Umfrage auf [www.LEGOsurvey.com/product](http://www.LEGOsurvey.com/product) teil und hab die Chance ein cooles LEGO® Produkt zu gewinnen!

Die Teilnahme am Gewinnspiel führt zu keinerlei Kaufverpflichtungen. Teilnahme in allen nicht ausgeschlossenen Ländern möglich.

### WIN!

Ga naar [www.LEGOsurvey.com/product](http://www.LEGOsurvey.com/product), vul een enquêteformulier in en maak kans op een cool LEGO® product.

Geen aankoopverplichting. Iedereen mag deelnemen, uitgezonderd ingezetenden van landen waar een enquêteverbod geldt.

### GAGNE!

Visite [www.LEGOsurvey.com/product](http://www.LEGOsurvey.com/product) pour répondre à un questionnaire et avoir une chance de gagner un produit LEGO® très cool!

Aucune obligation d'achat. Ouvert à tous les résidents des pays autorisés.

### 当てよう!

[www.LEGOsurvey.com/product](http://www.LEGOsurvey.com/product) にアクセスして、アンケートにご記入ください。当選者にはレゴ®製品を差し上げます。

お買い上げの必要はありません。禁止されていない限り、すべての皆様にご利用いただけます。



LEGO.com

6033601

LEGO and the LEGO logo are trademarks of the/son des marques de commerce de/son marcas registradas de LEGO Group. ©2013 The LEGO Group.