

CITY

60014







+

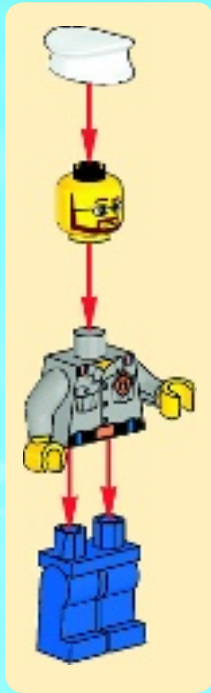
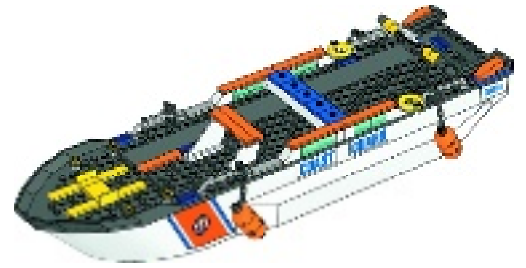

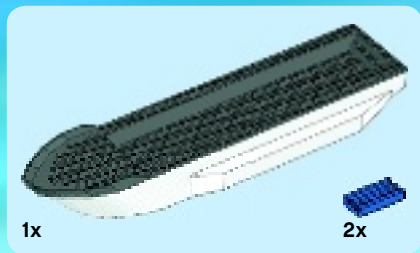

1

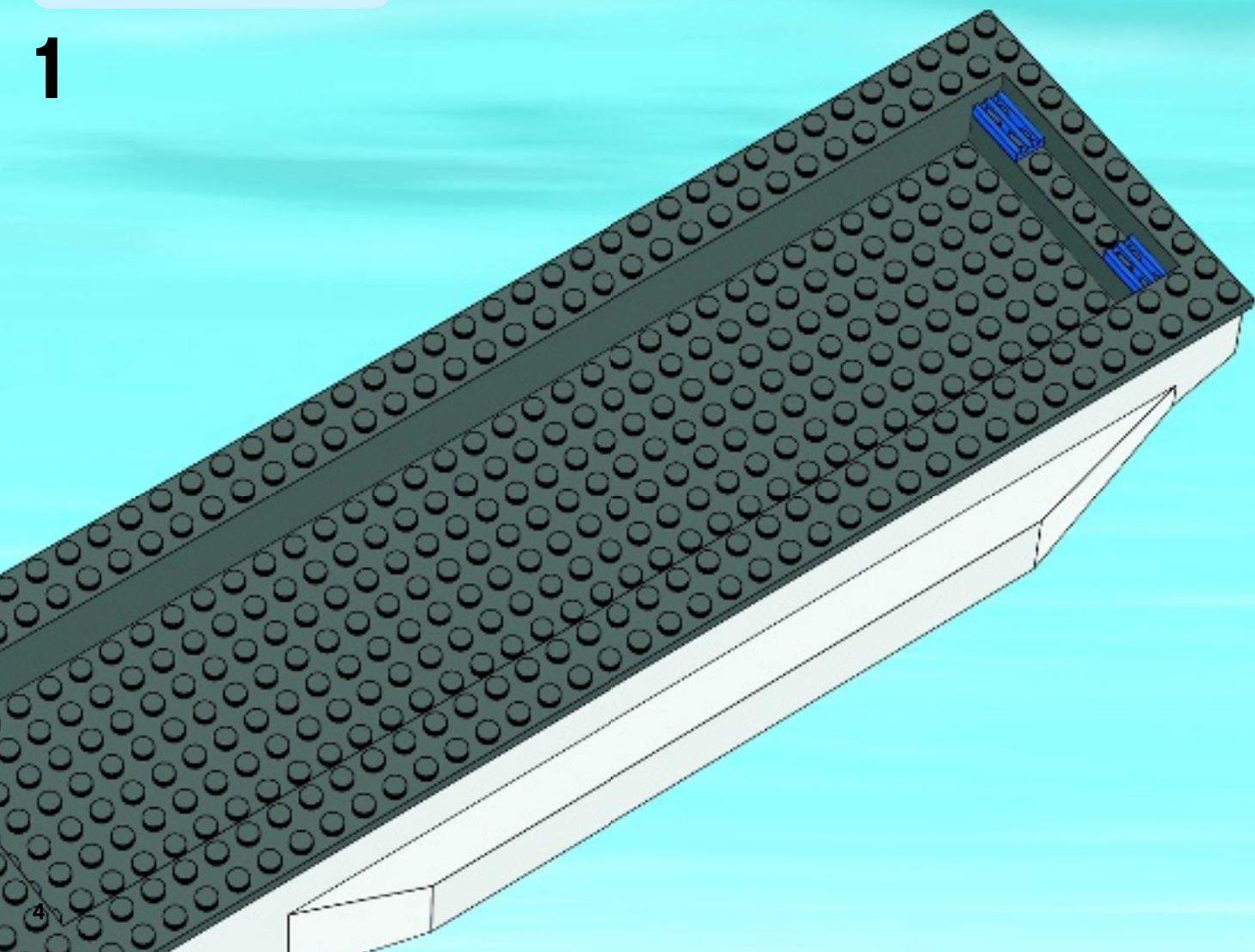



2x

2

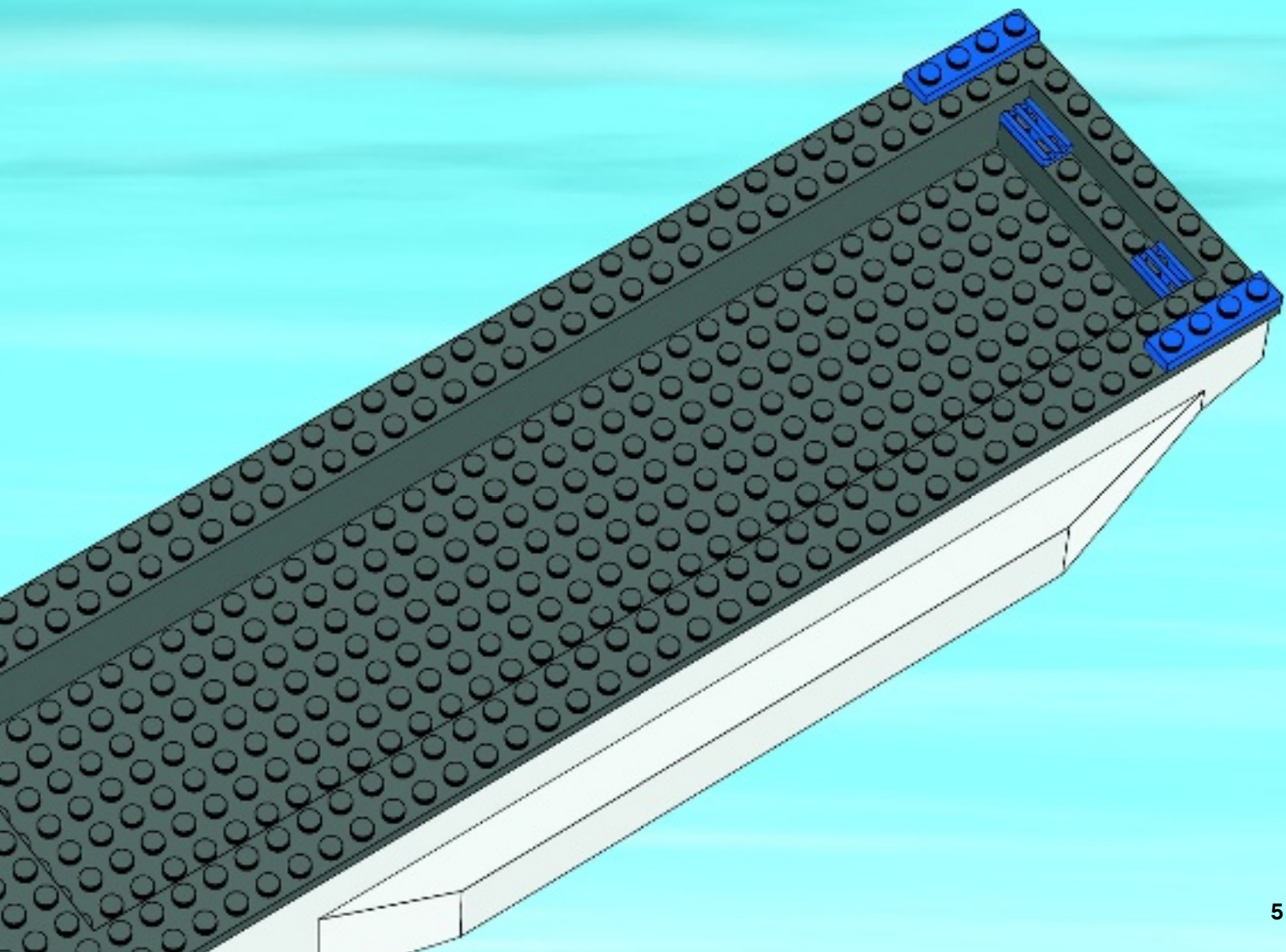



2x

3

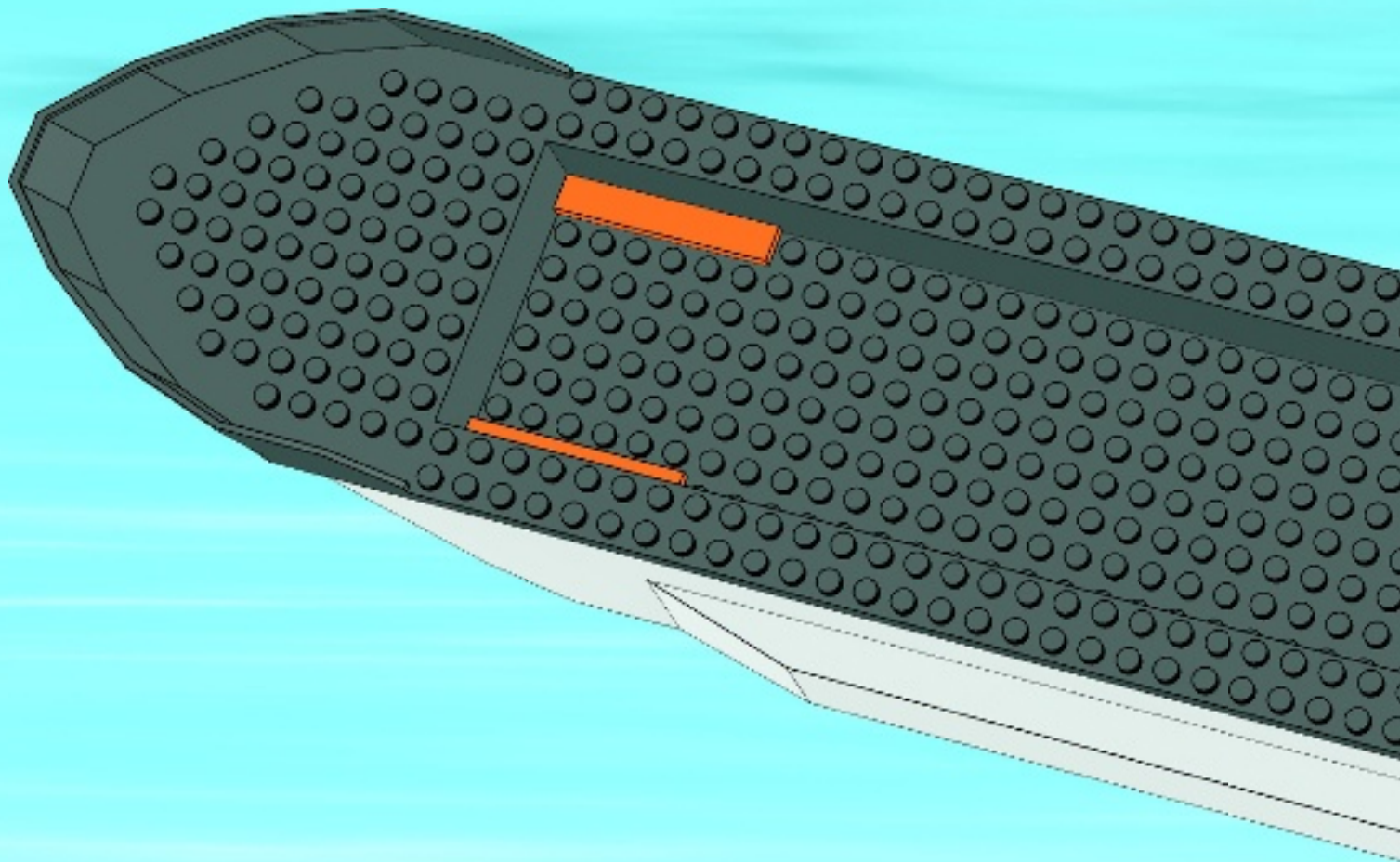



2x

4

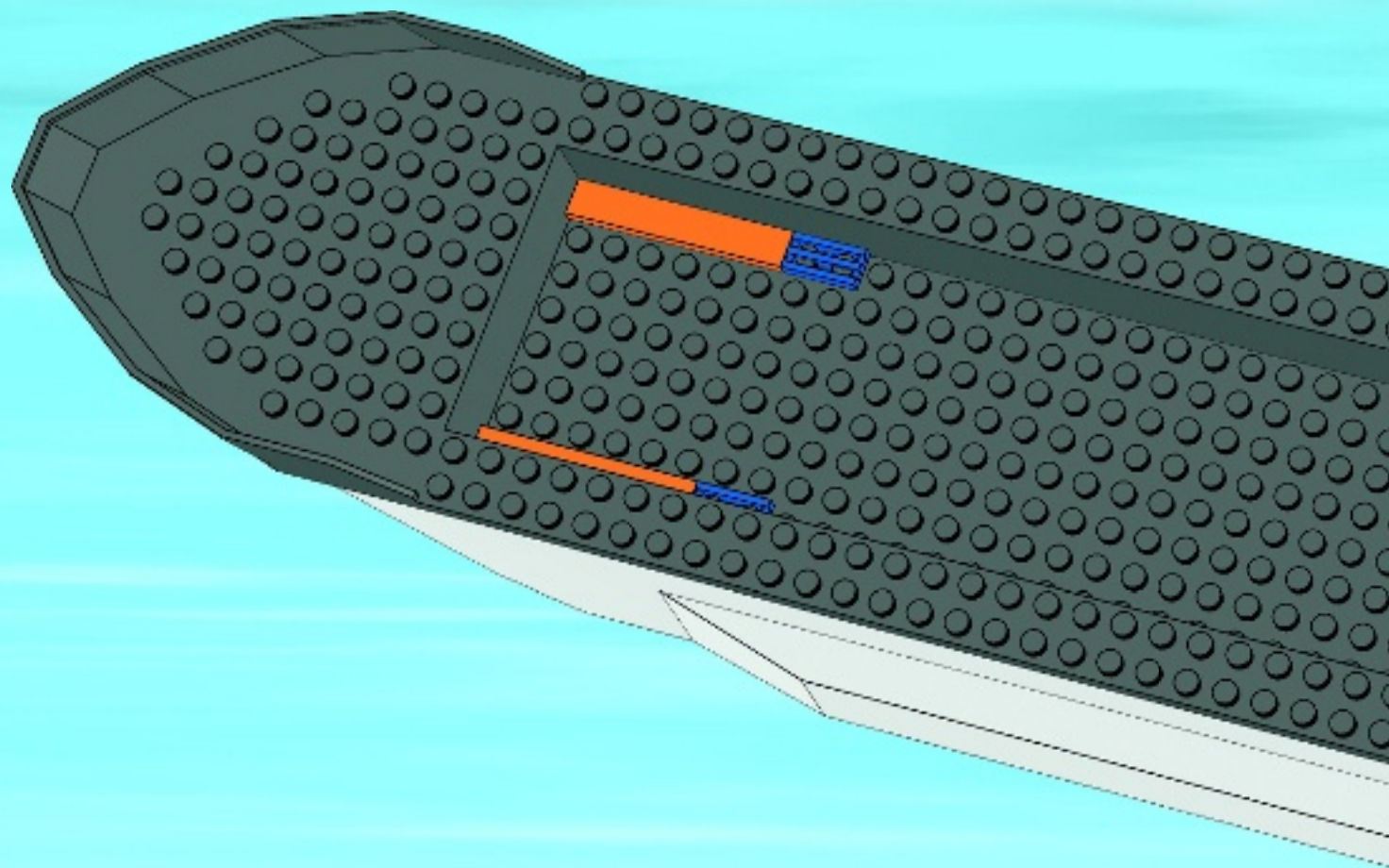

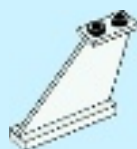

2x

5

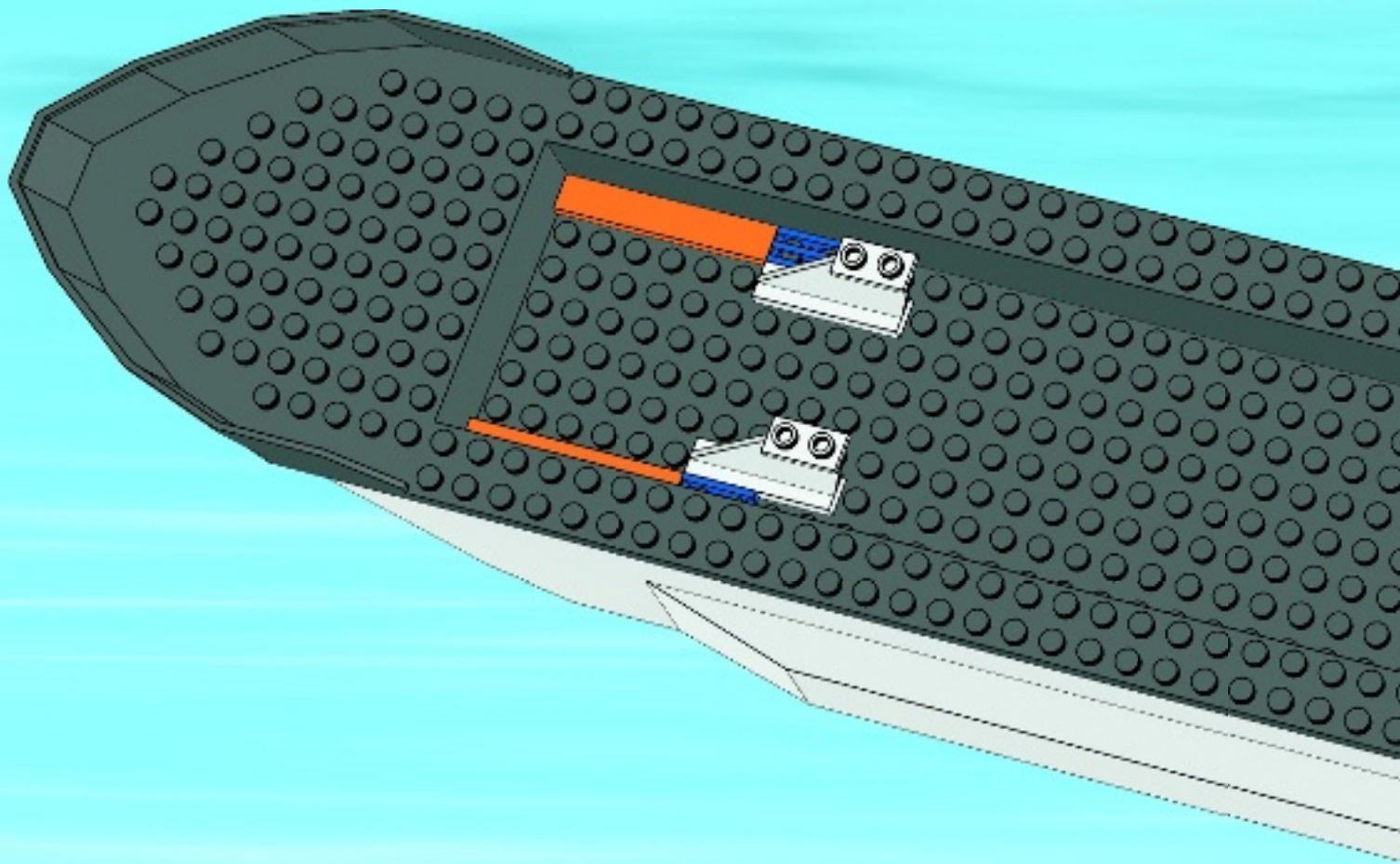



2x

6

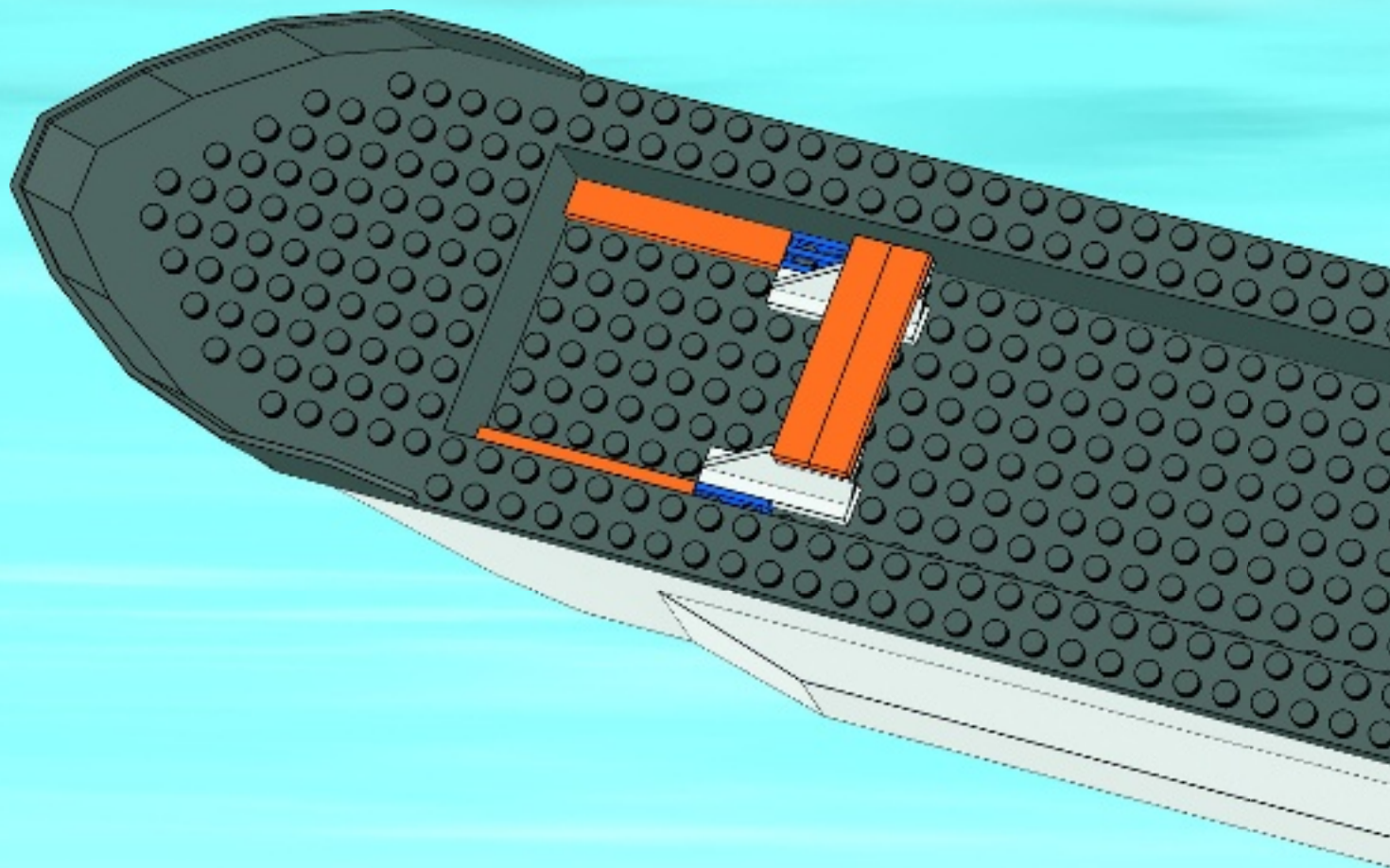



2x



2x

7

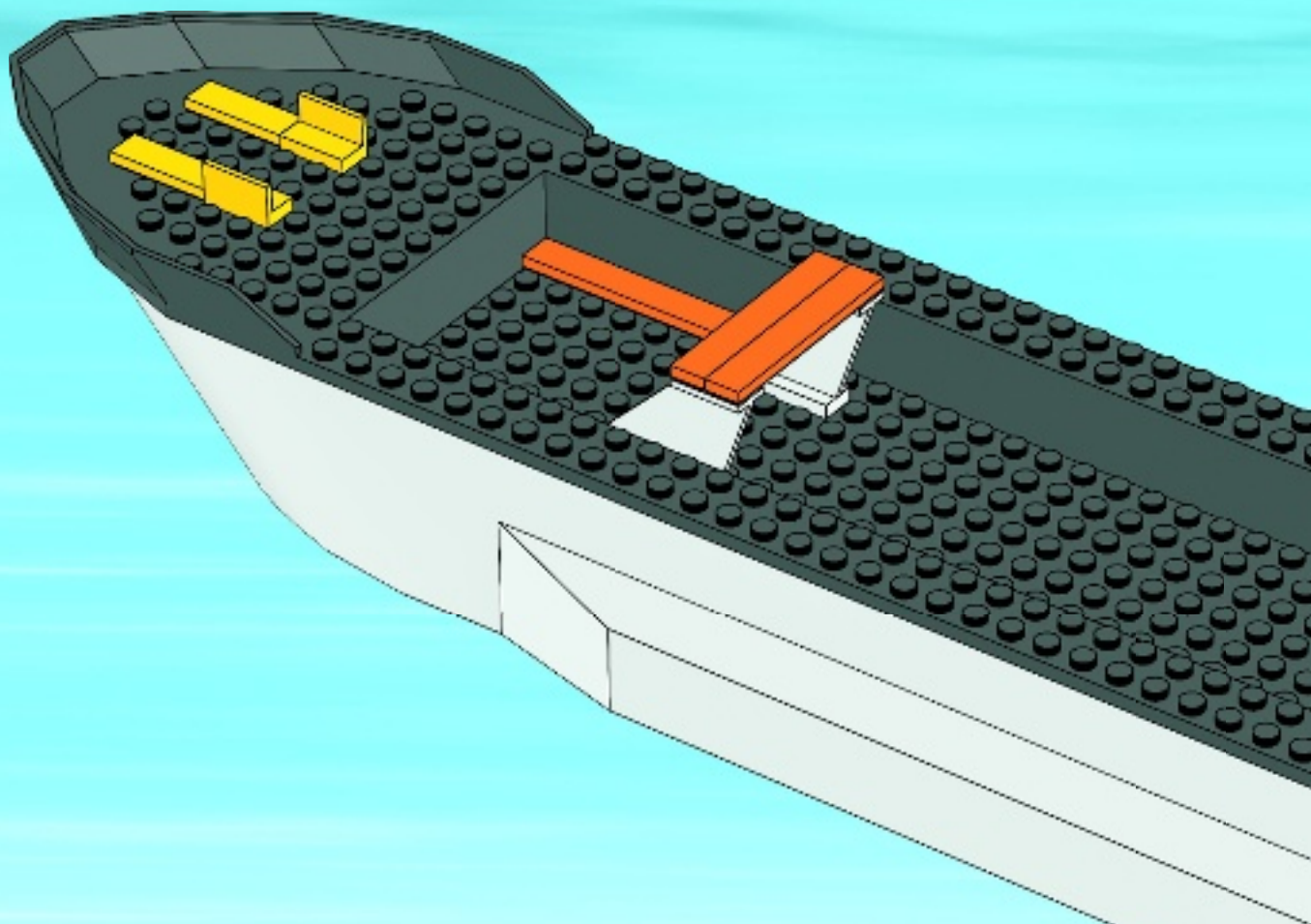



1x



2x

8

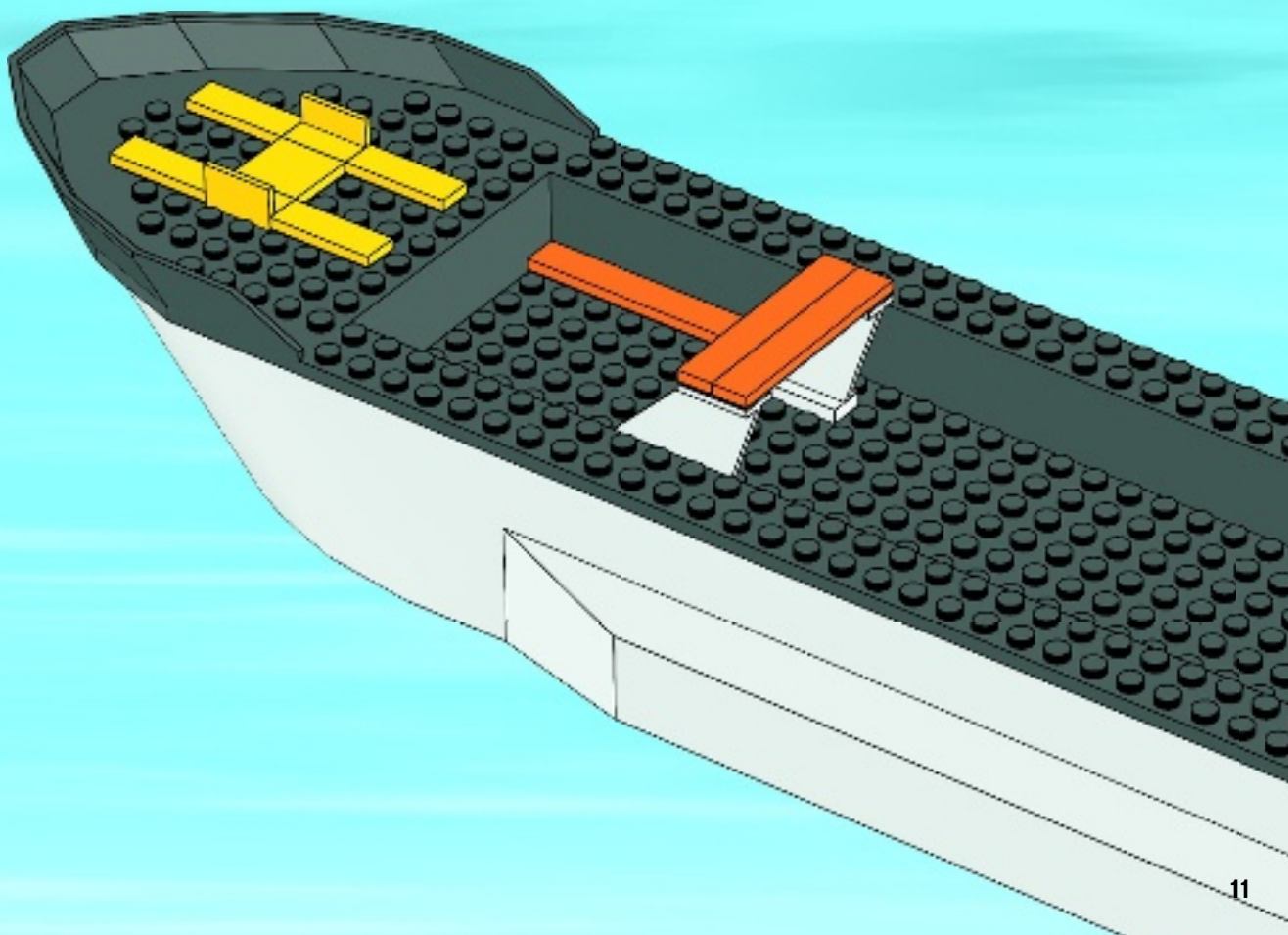



4x



4x

9



4x





2x

10

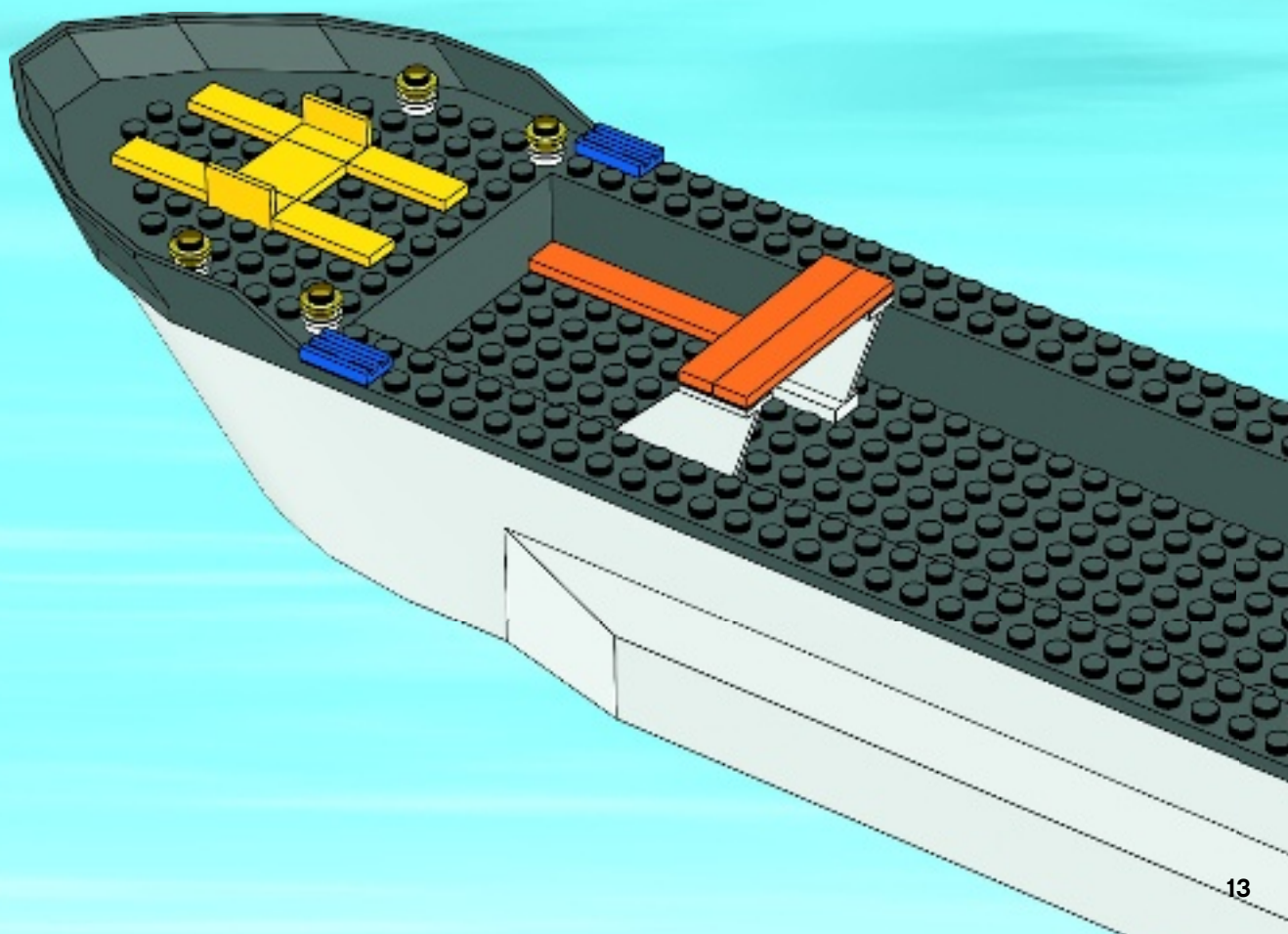



2x



2x

11

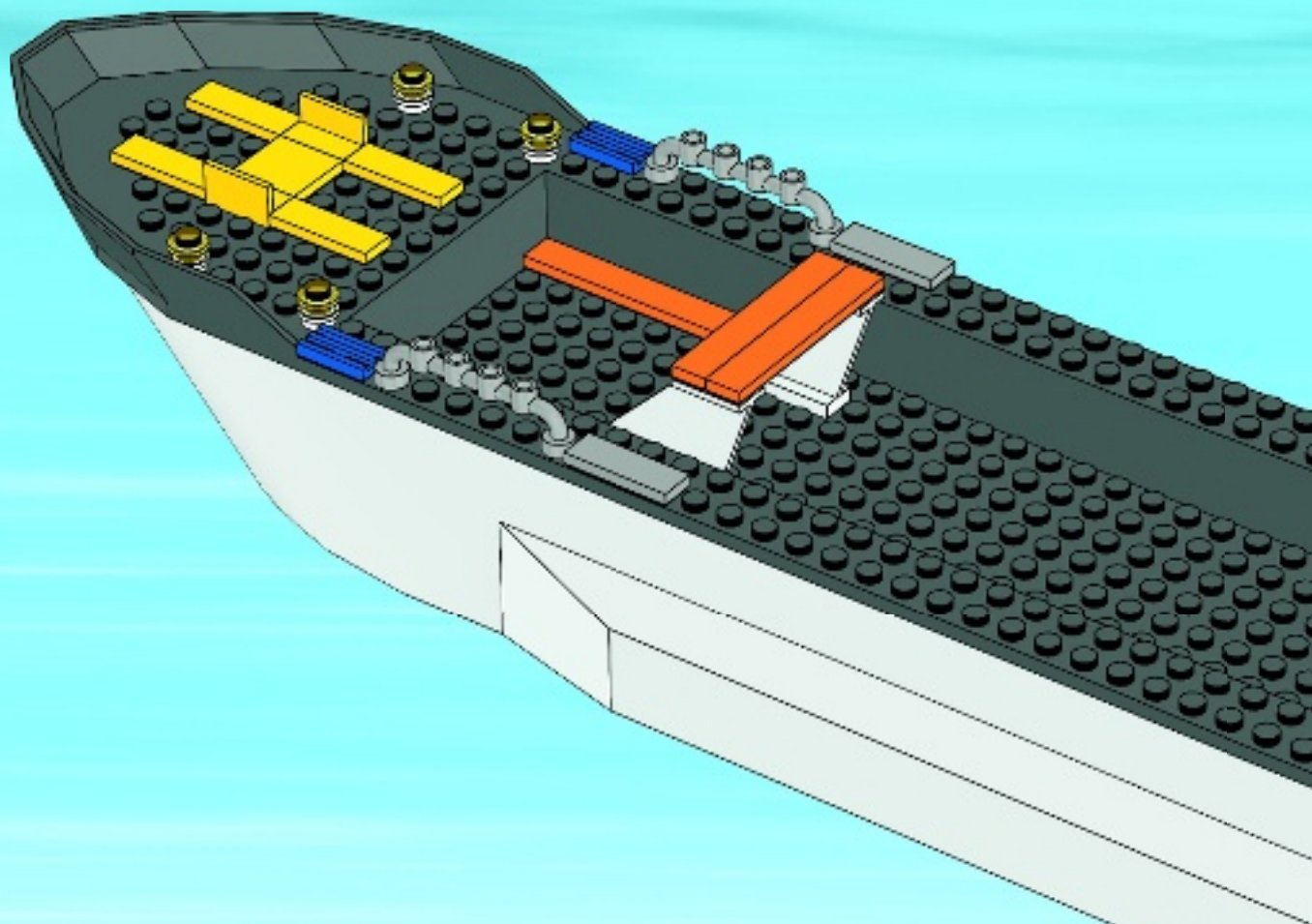



2x



4x

12

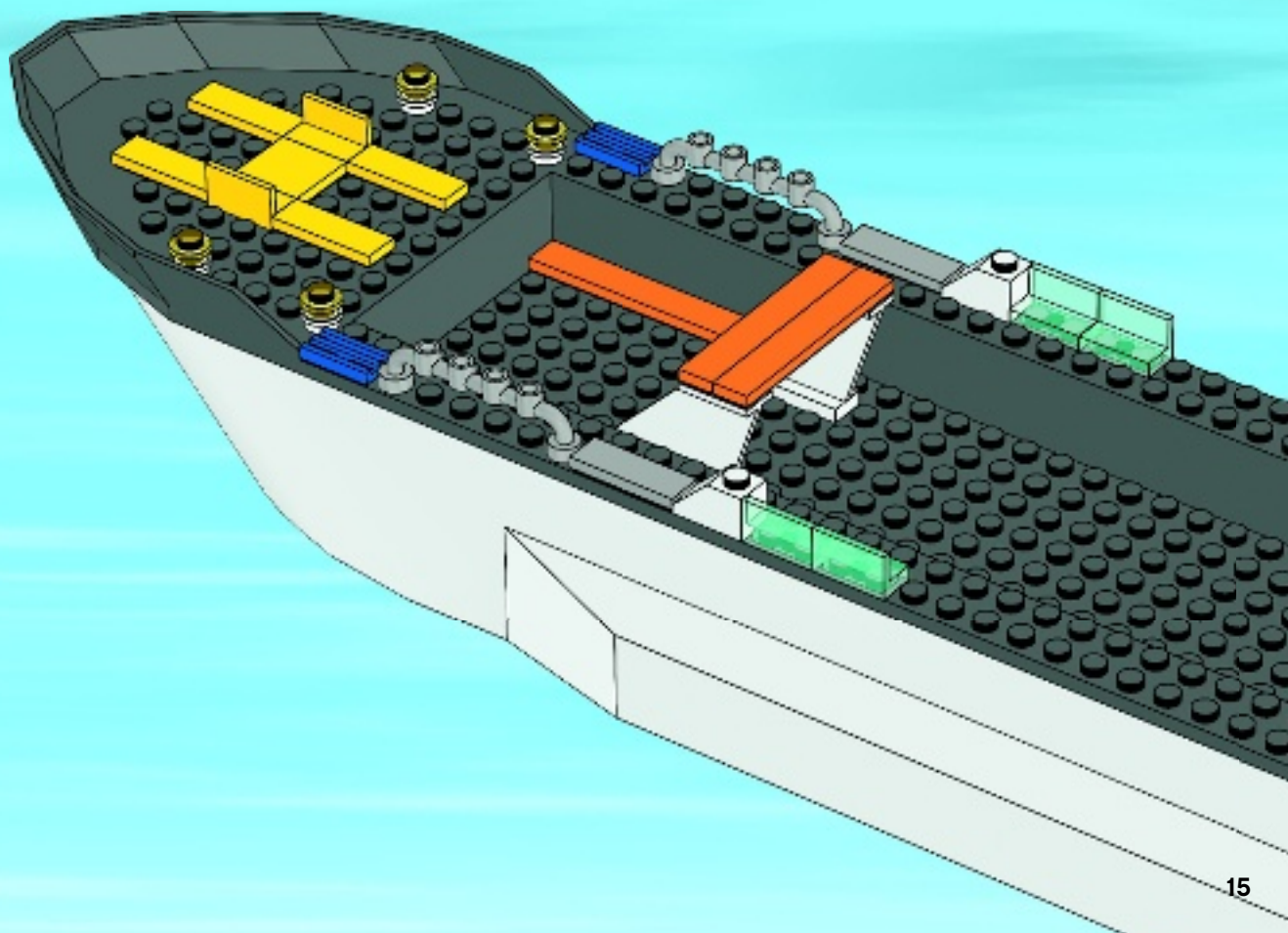

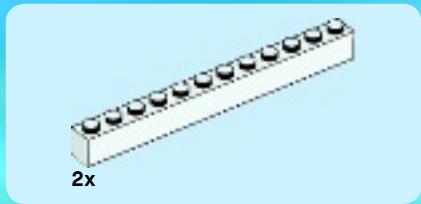

13

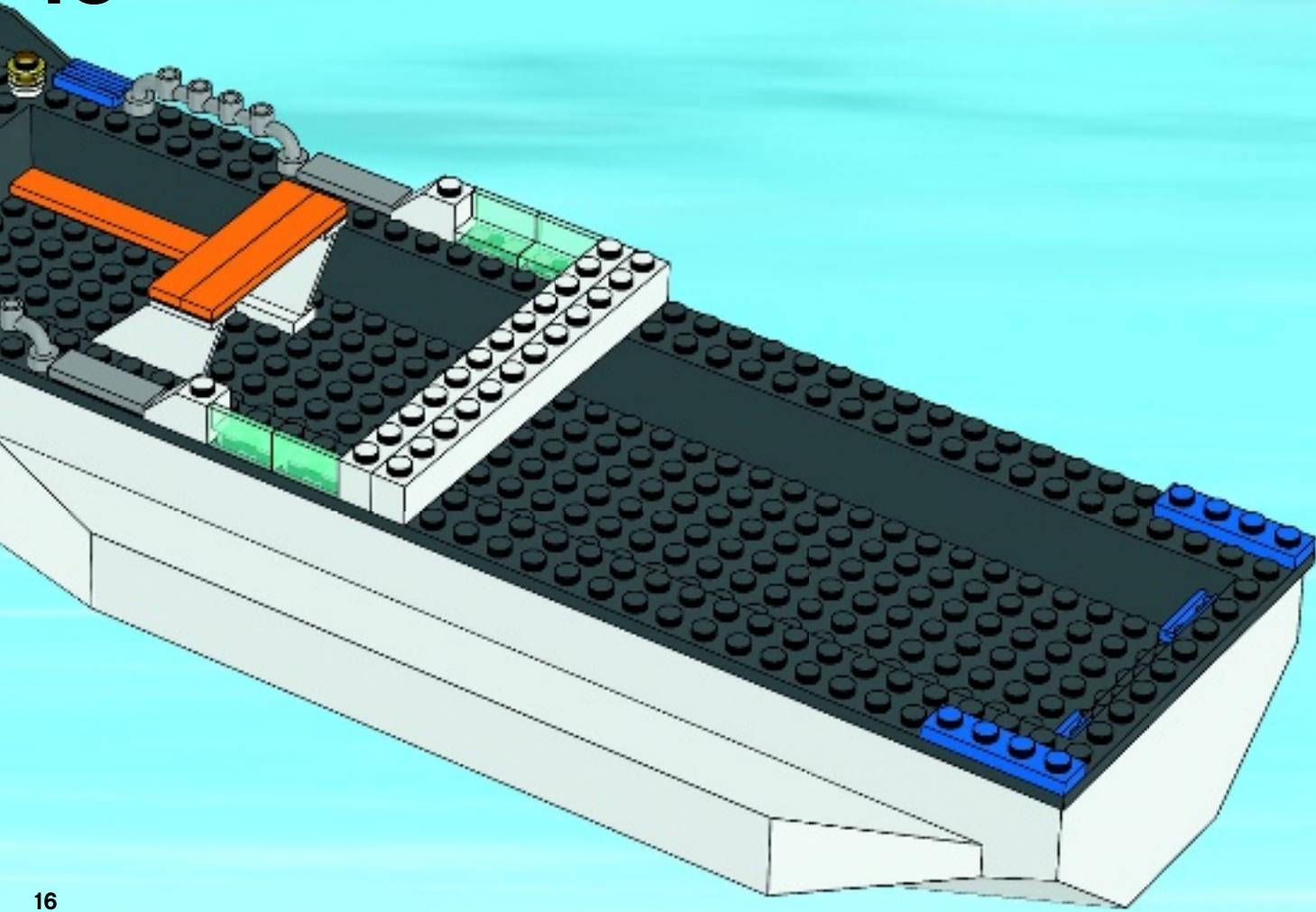



2x



4x

14

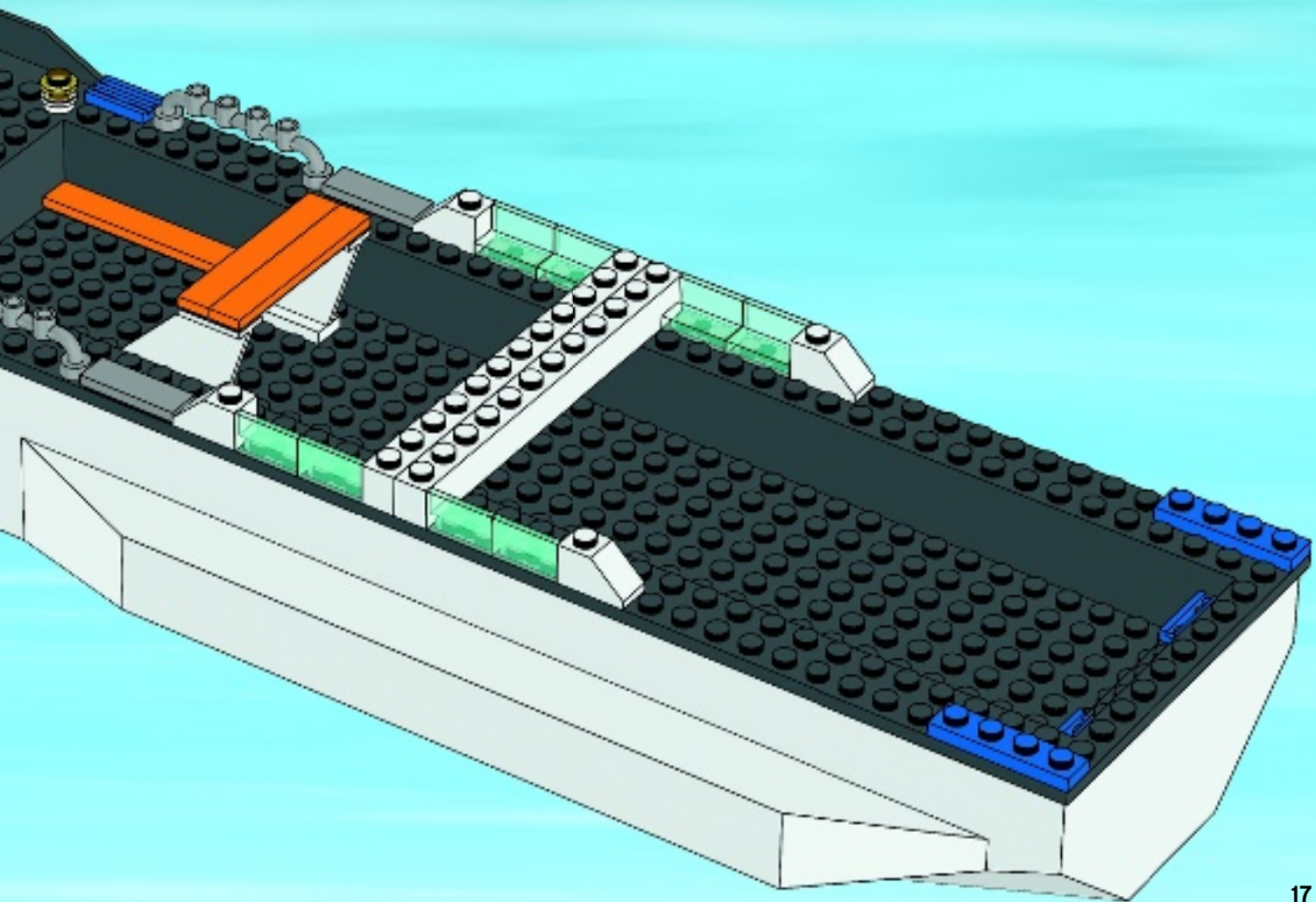



4x

15

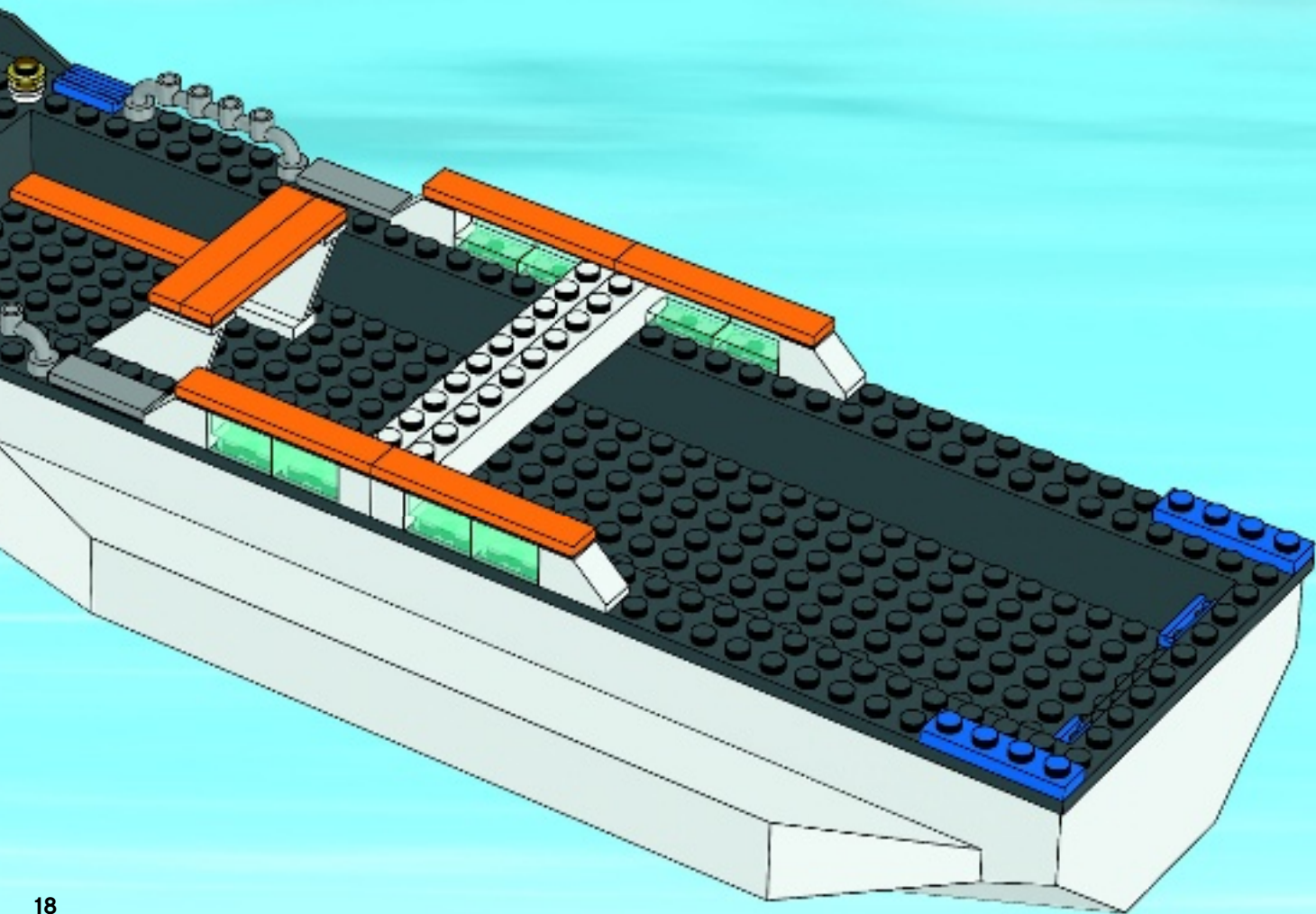



5x

16

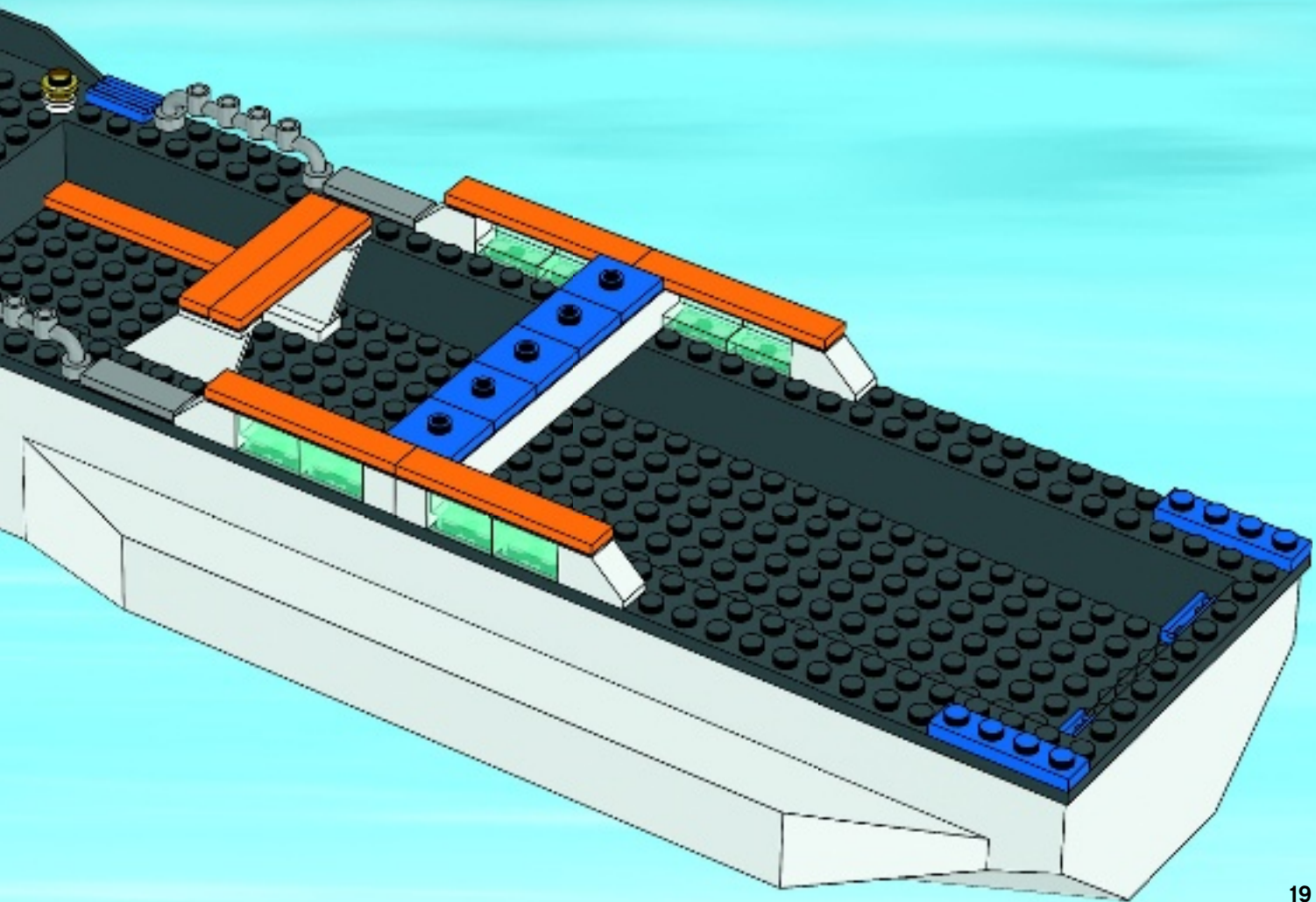



2x



2x

17

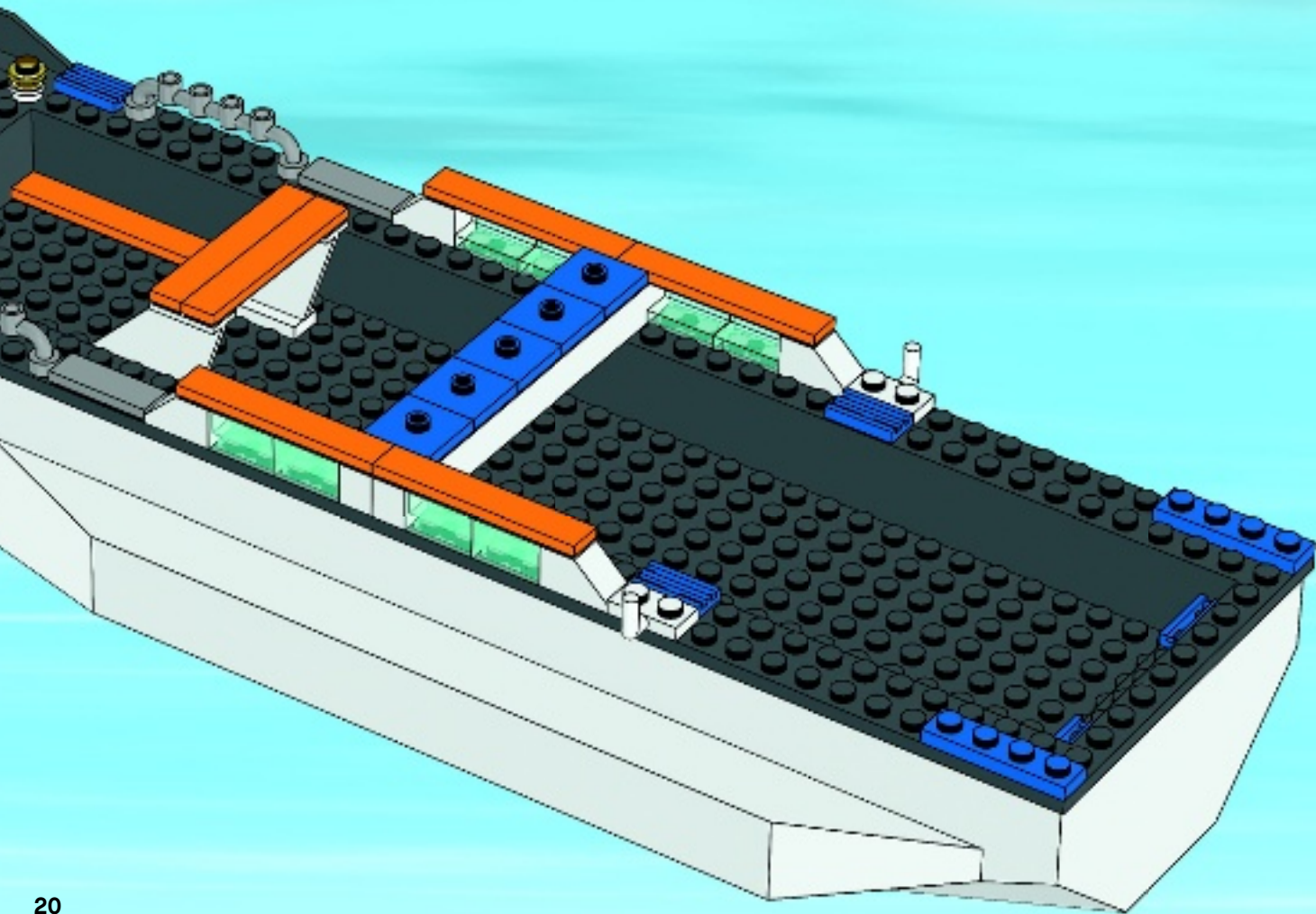



2x

18

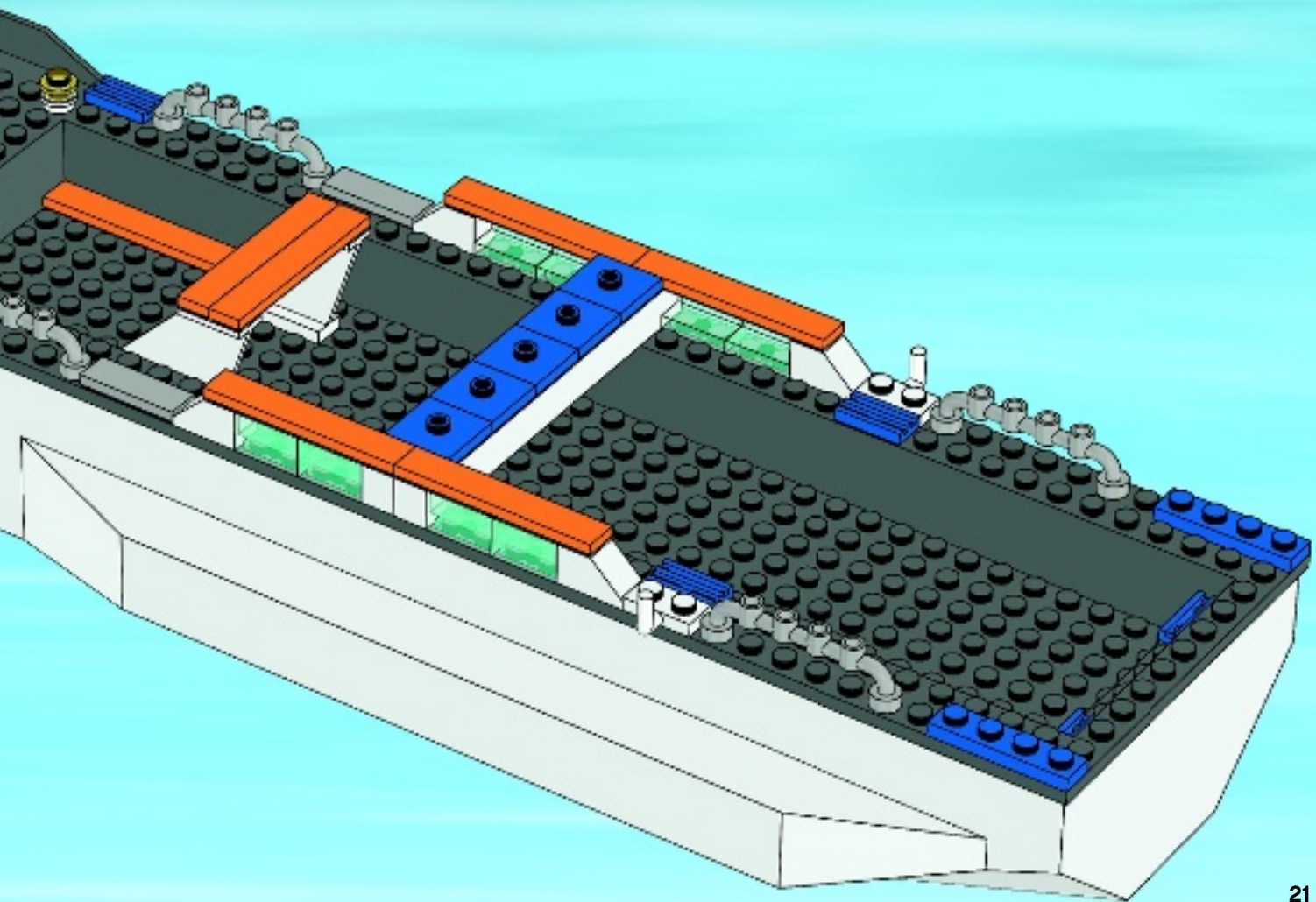



2x

19

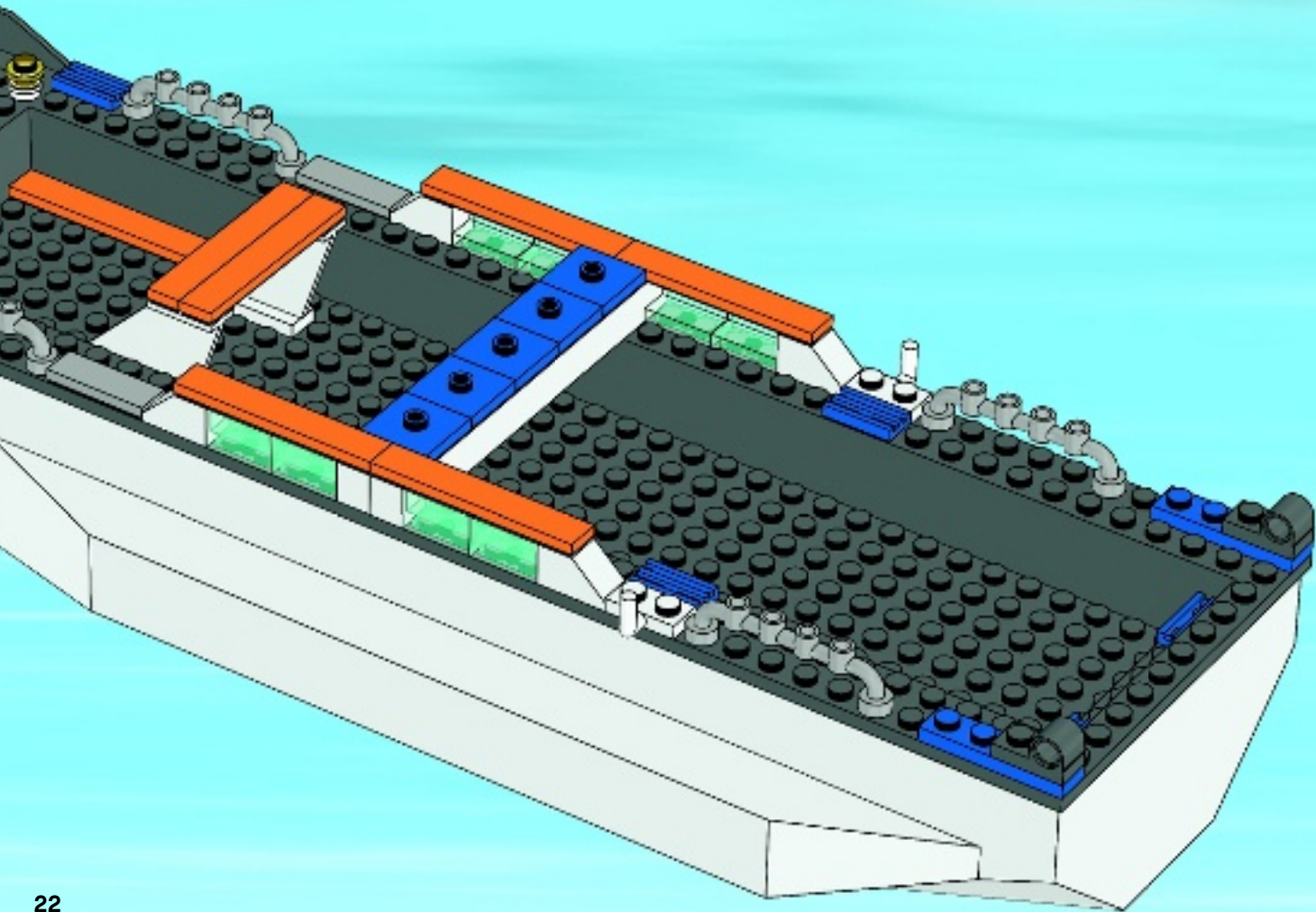



2x



2x

20

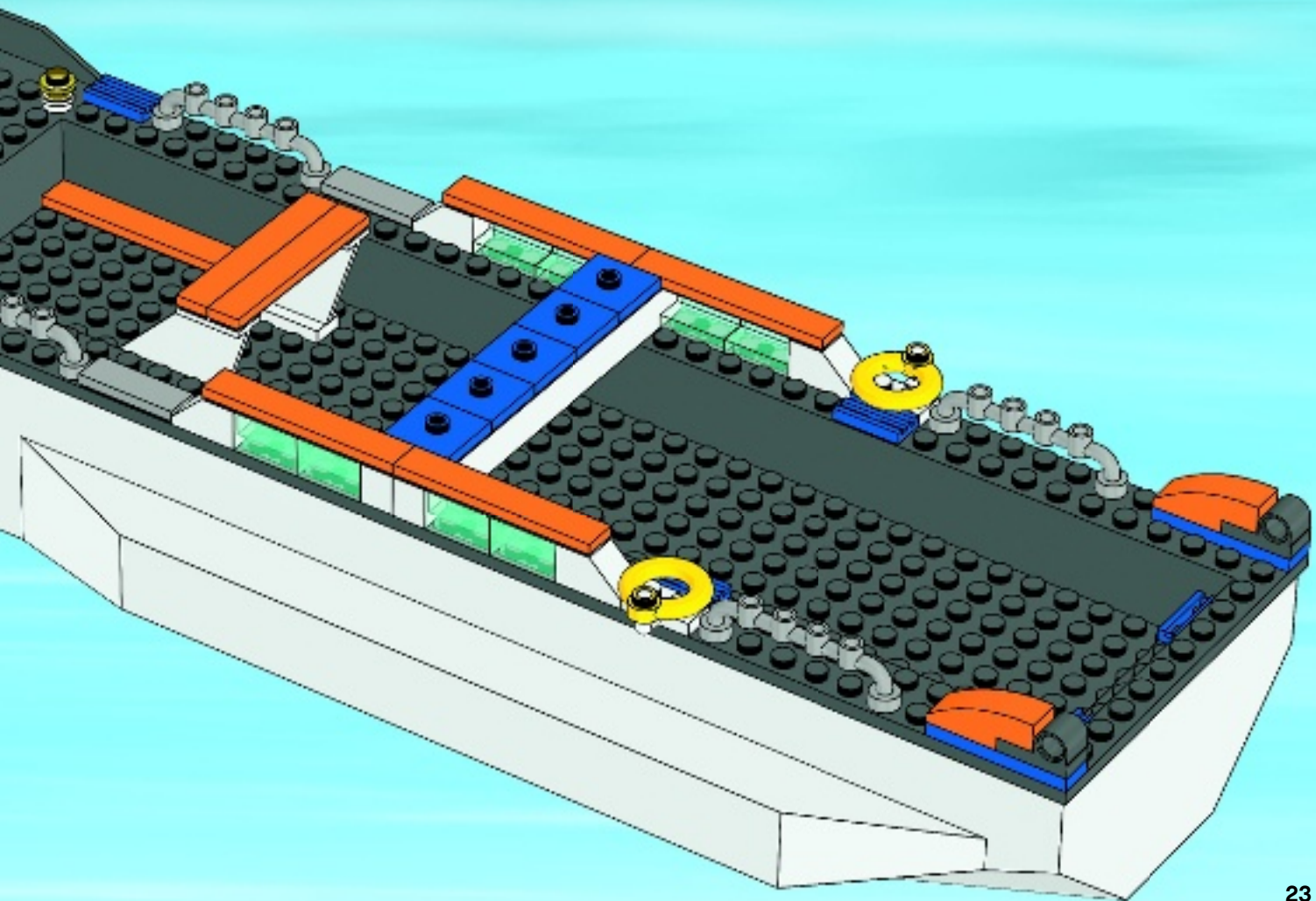

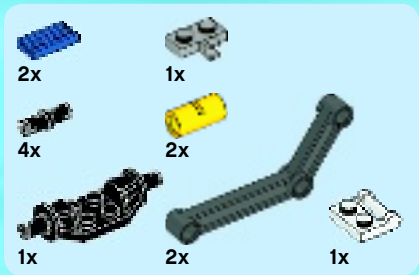

21

1



2



3



4



5

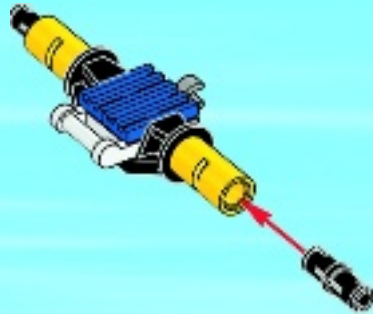

6

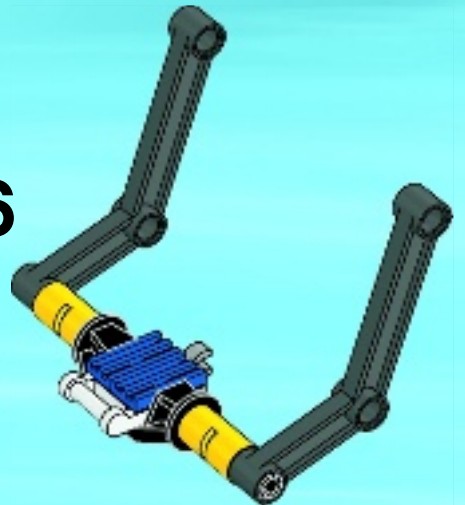

7

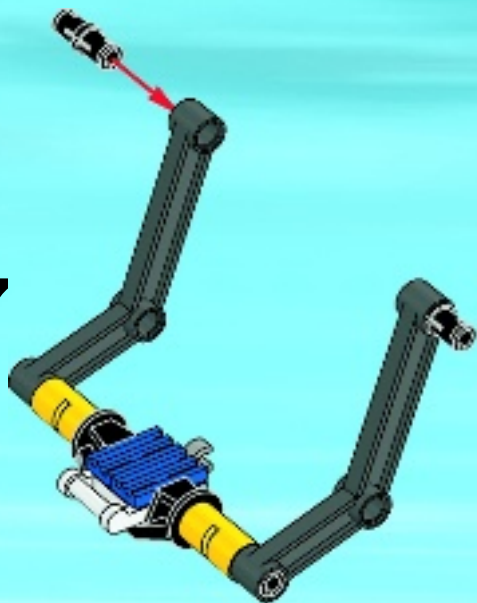

8

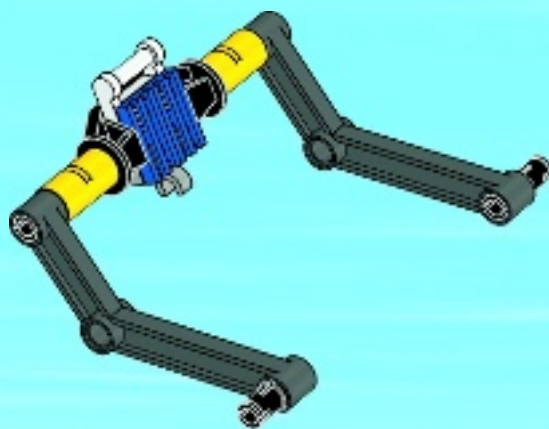

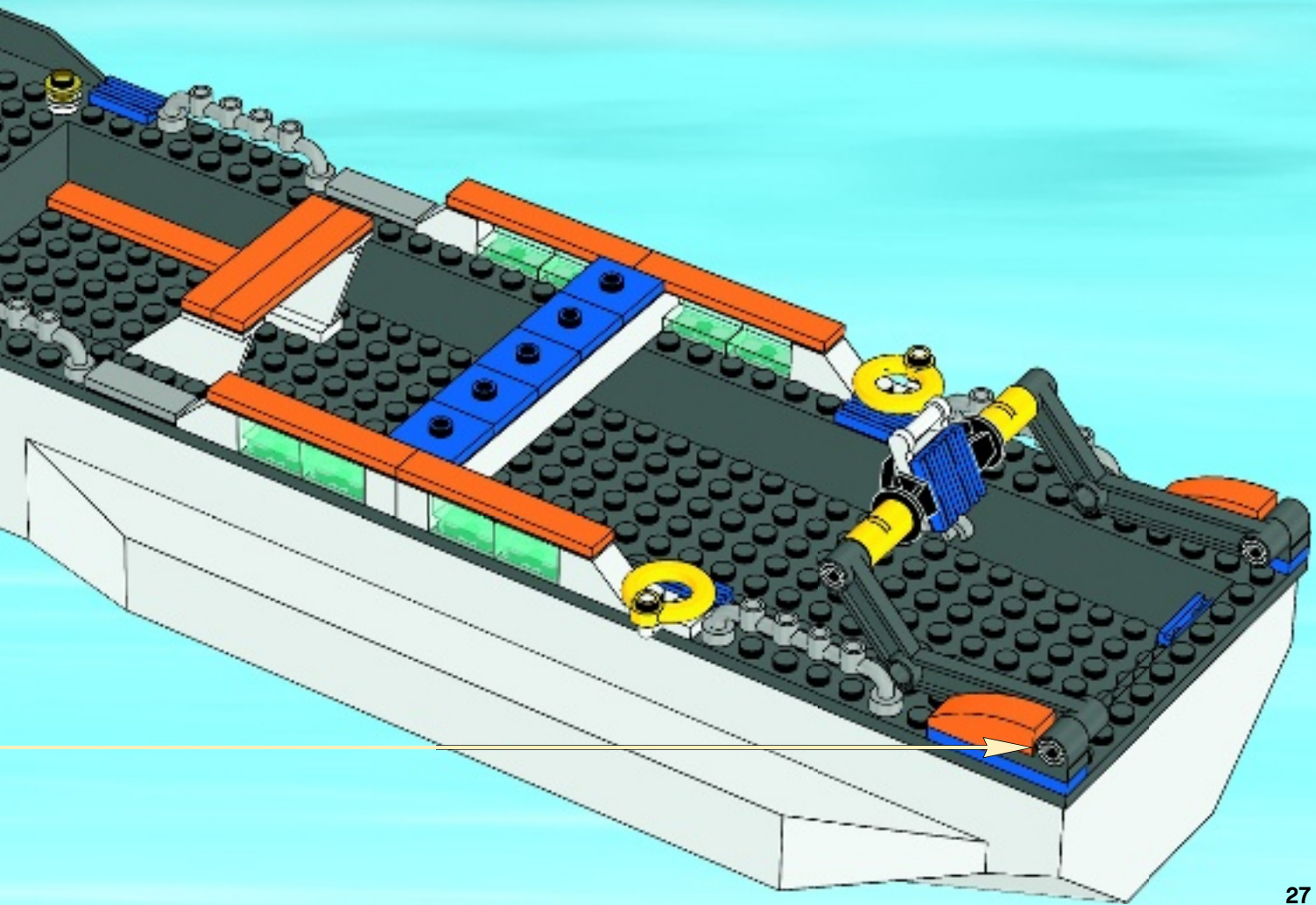

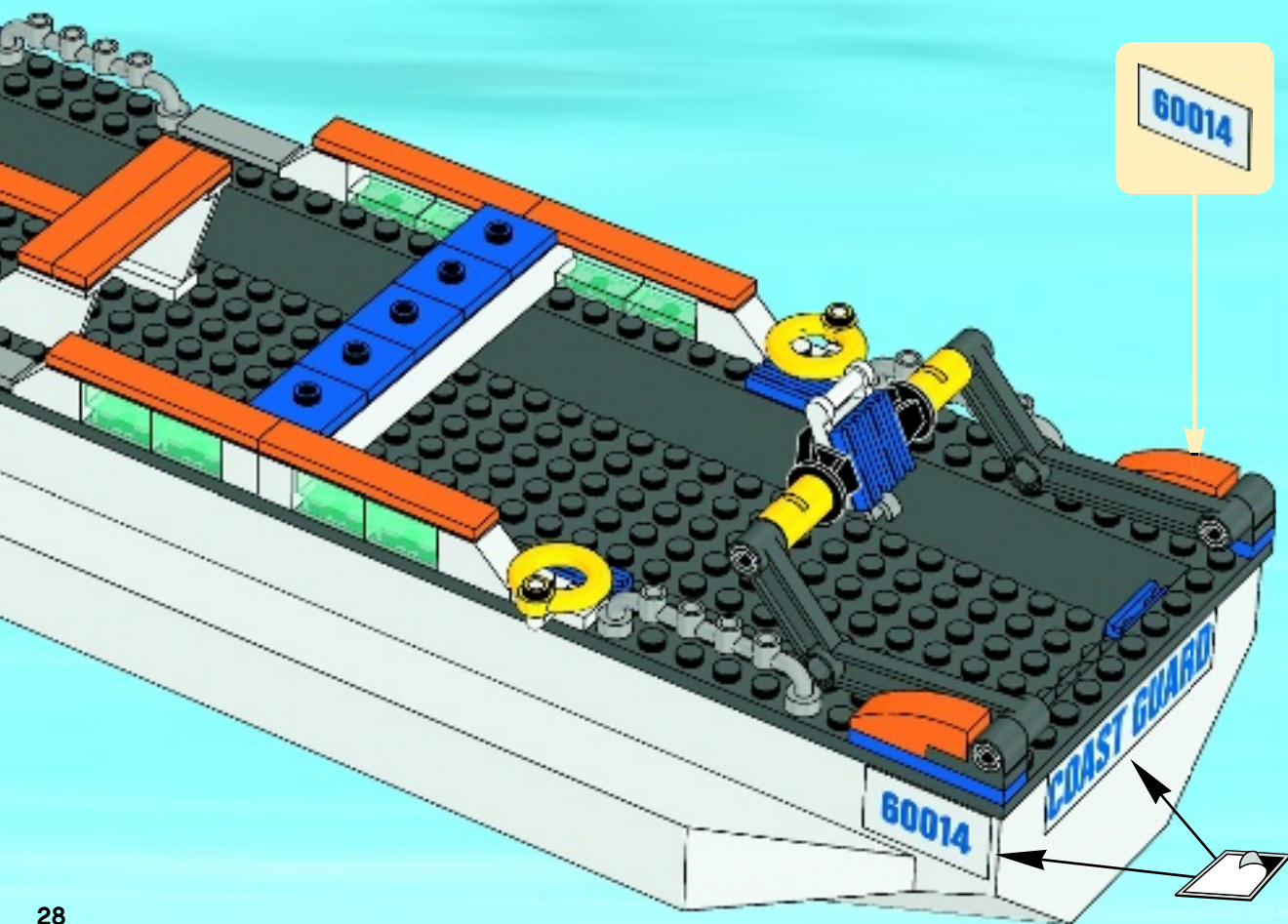

23

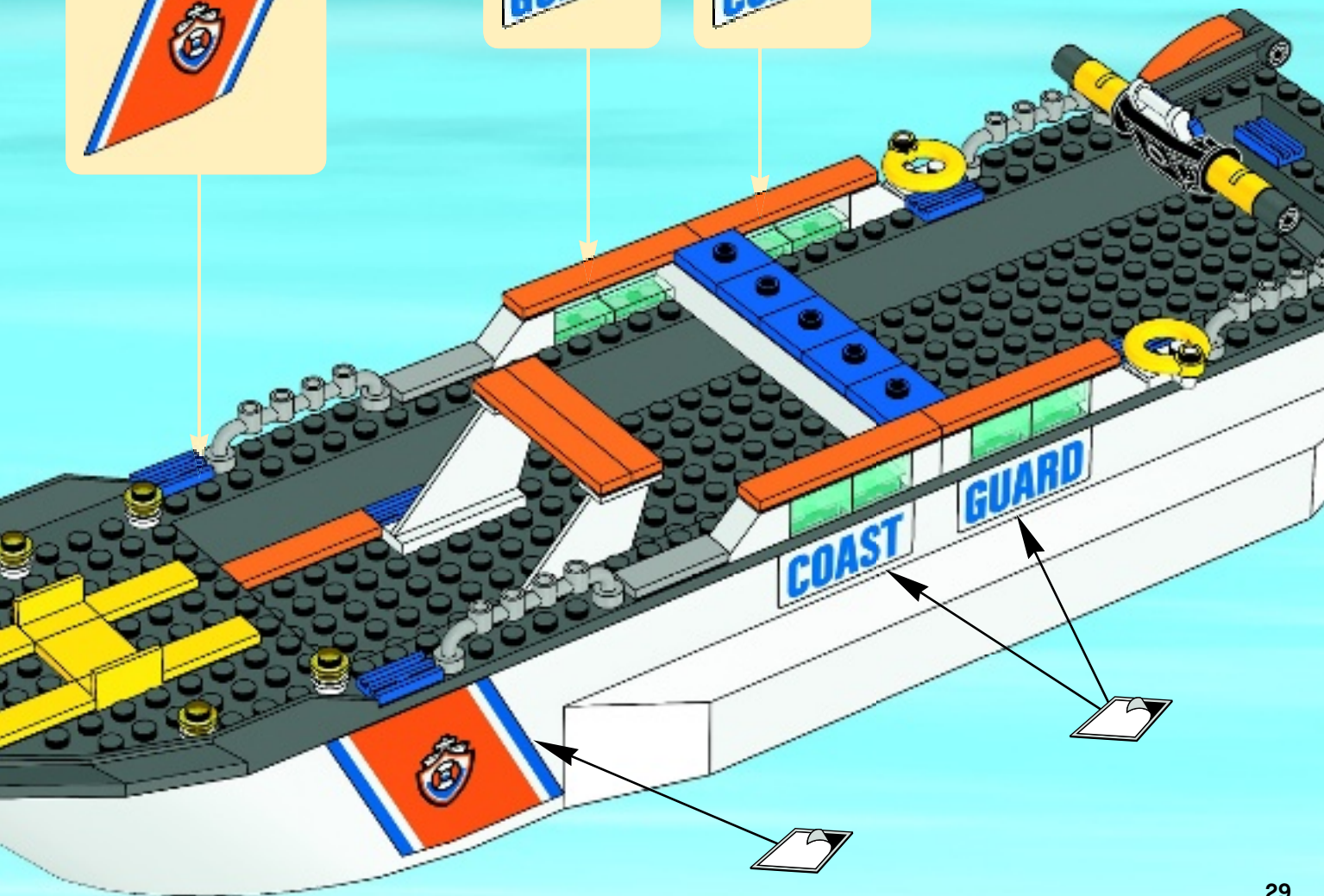



24

1



2



3



4



4x

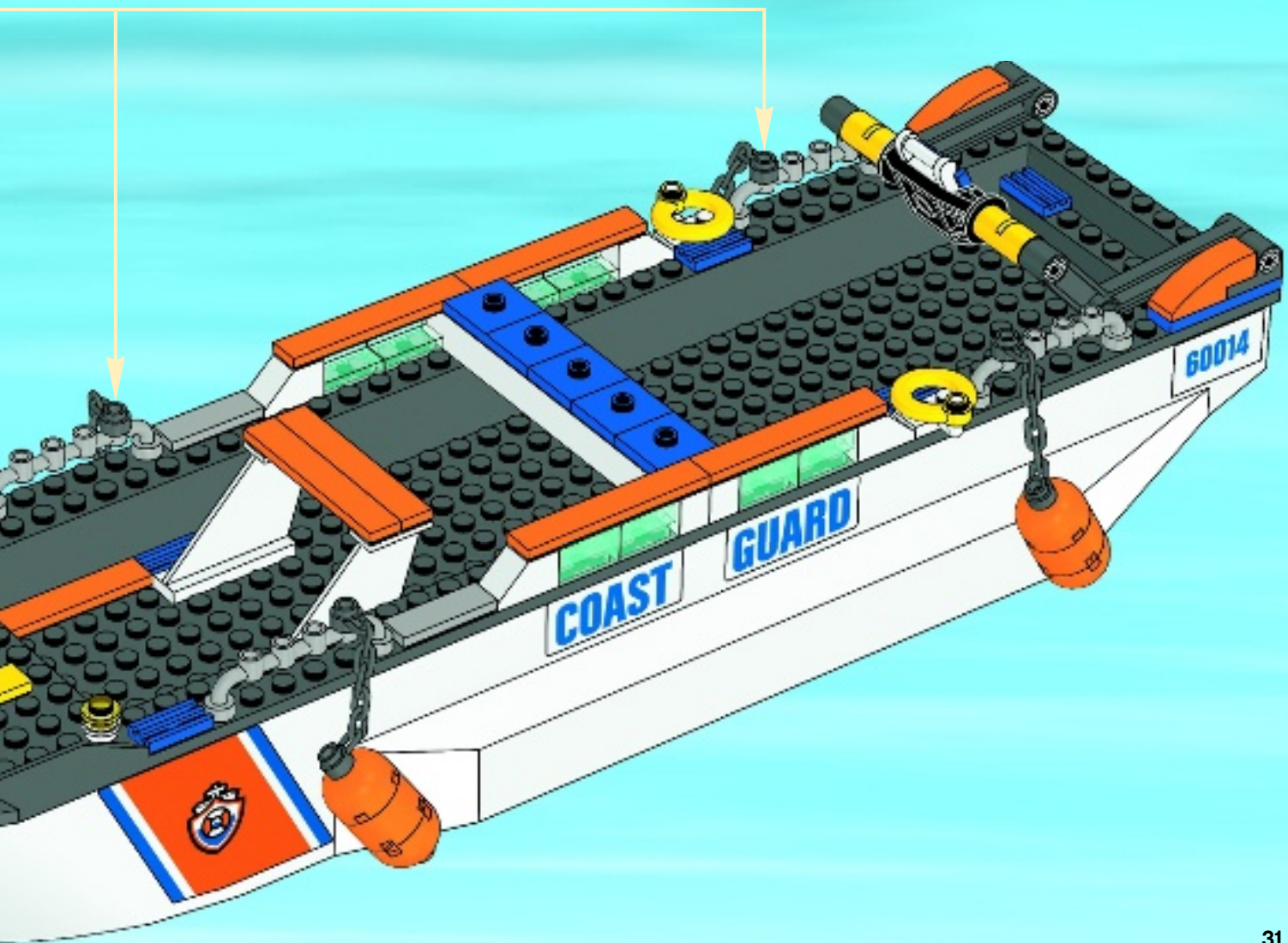



4

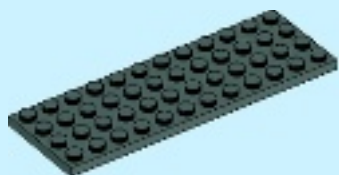

1x

1

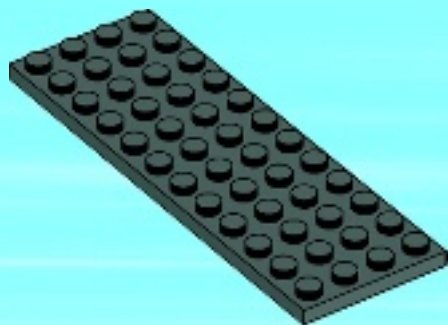

2x

2

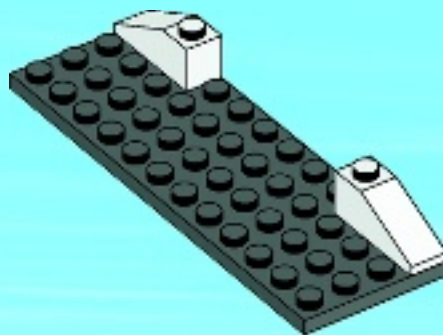

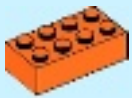

1x



2x

3

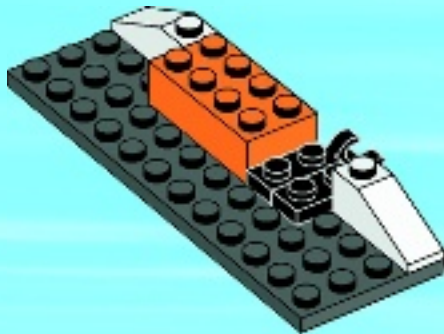

2x

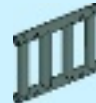

1x

4

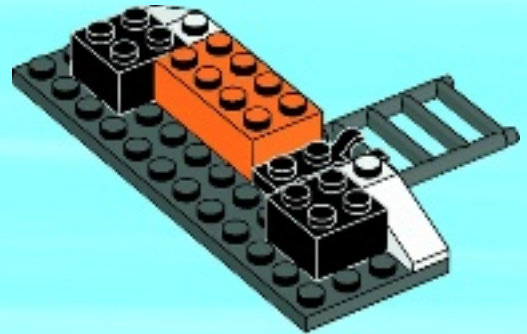



2x



1x

5

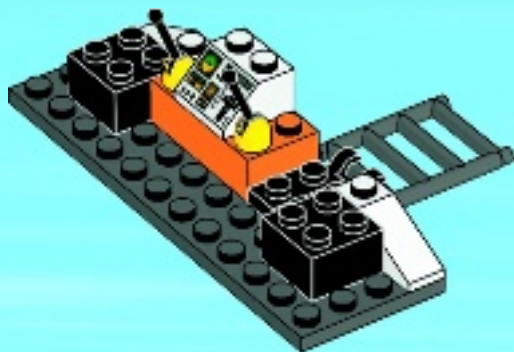



2x



2x

6

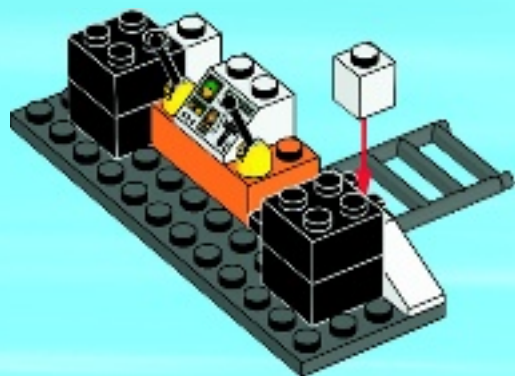

2x

7

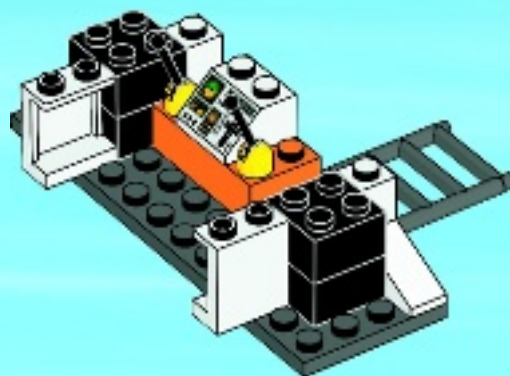

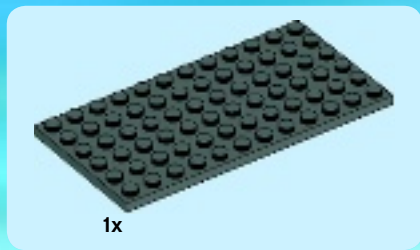

8

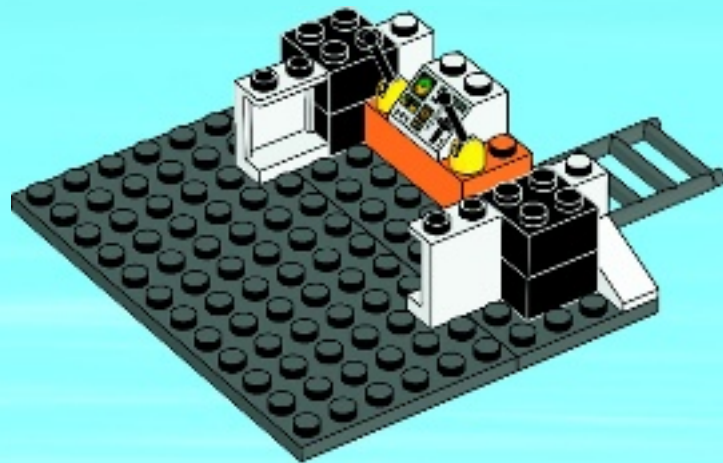



2x

9

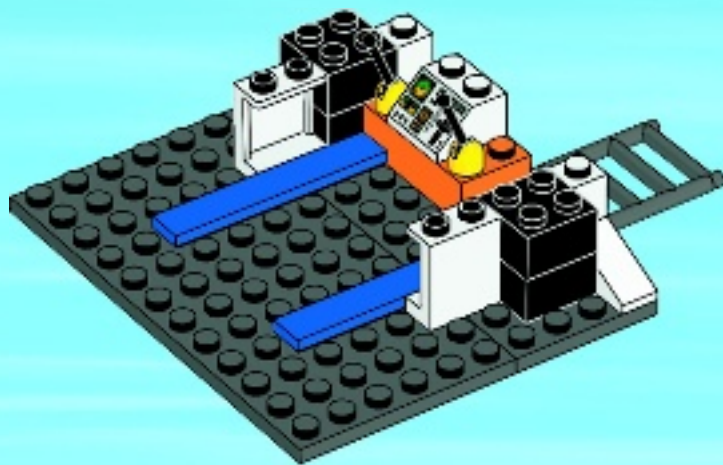



2x



2x

10

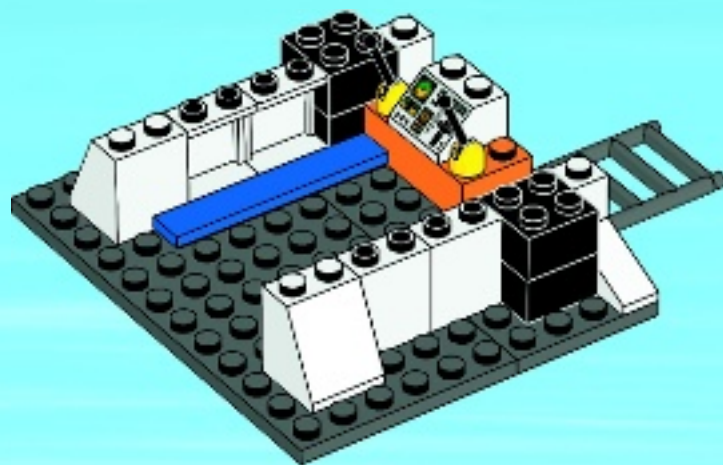



2x

11

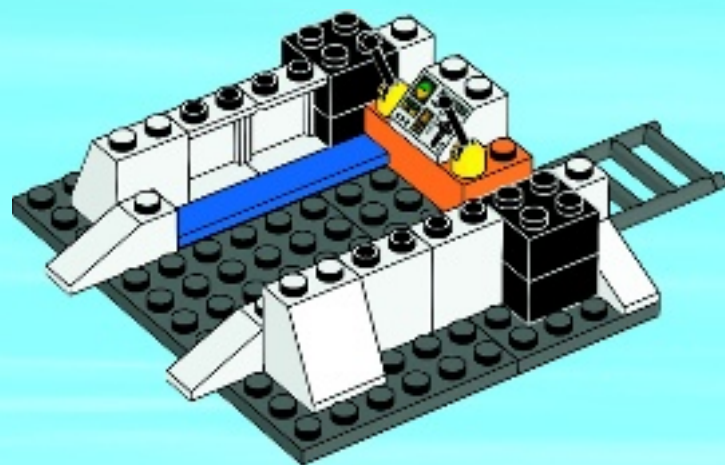



2x

12

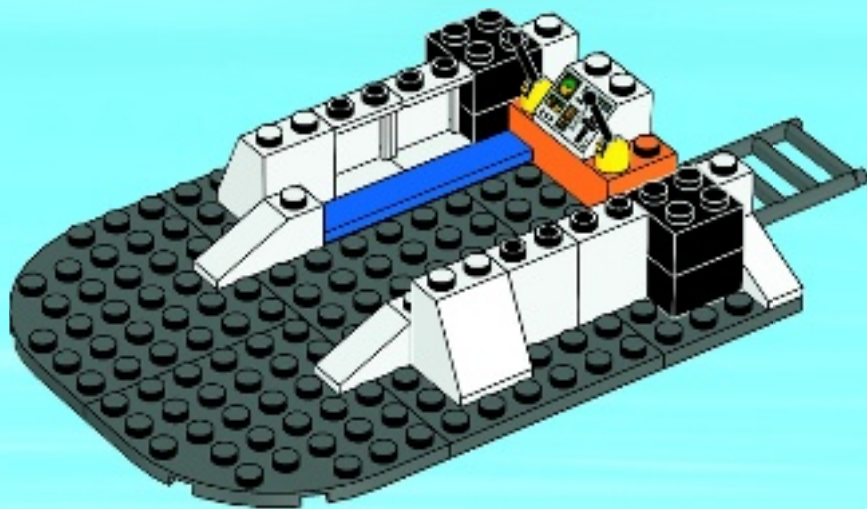

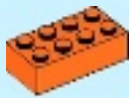

1x

13

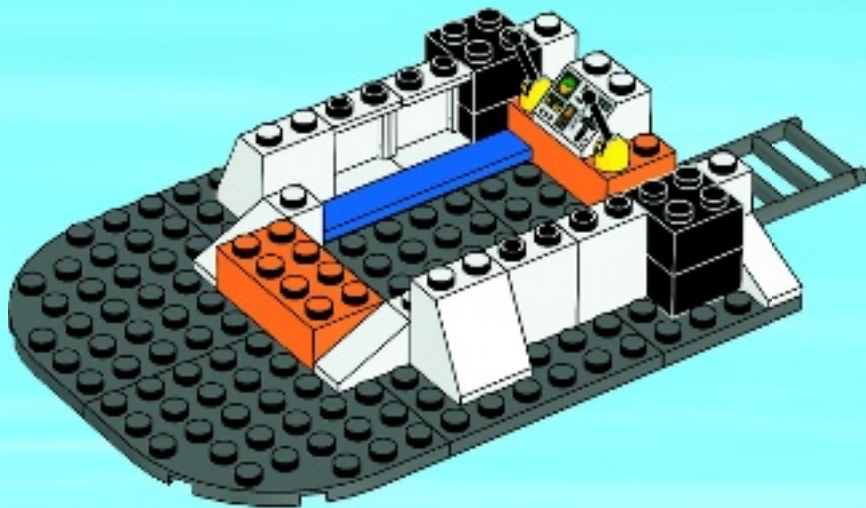



1x



1x

14

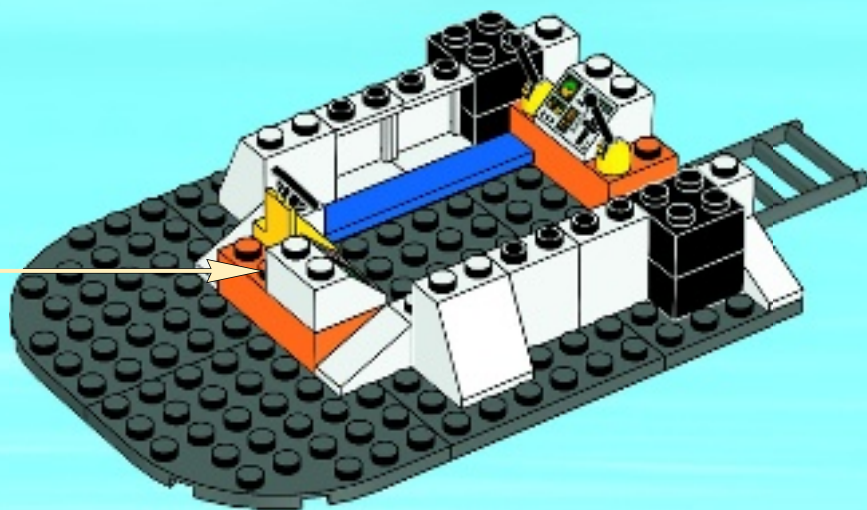



1x



2x

15

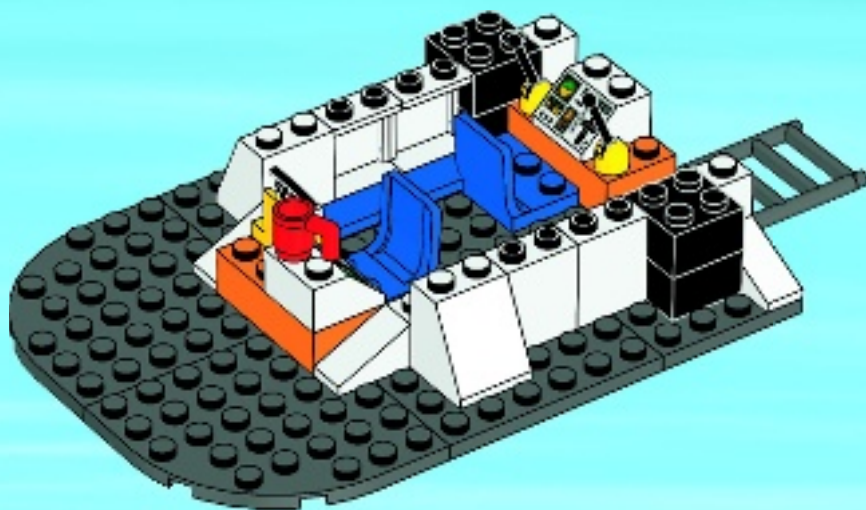

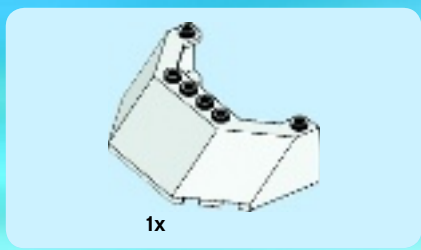

16

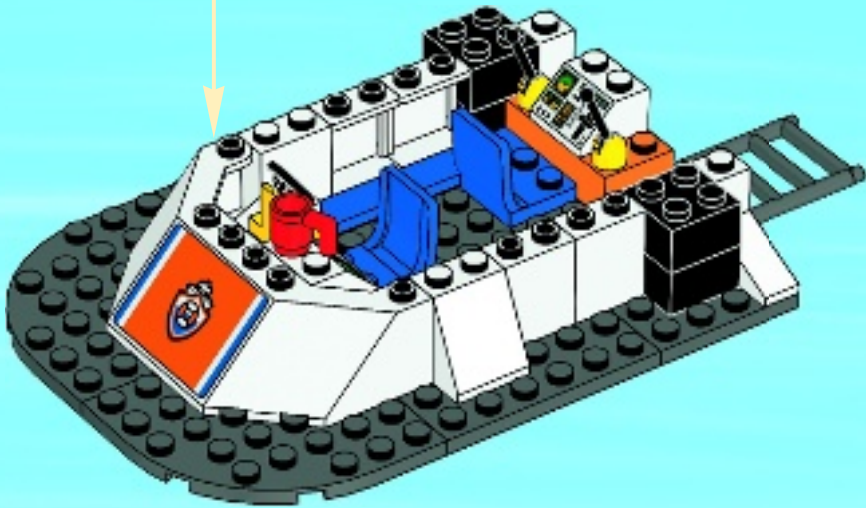
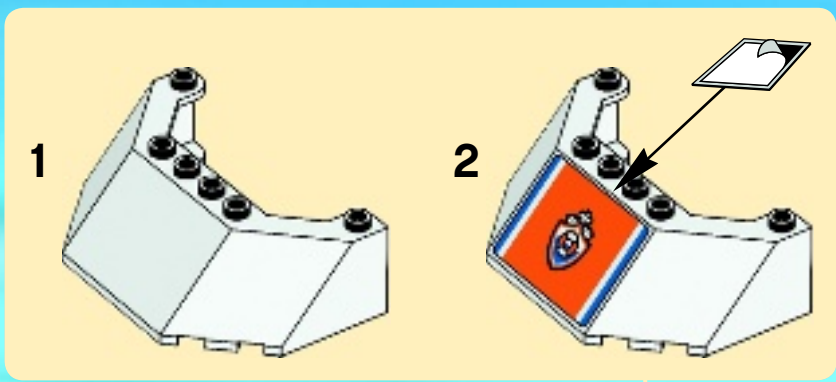



2x



2x

17

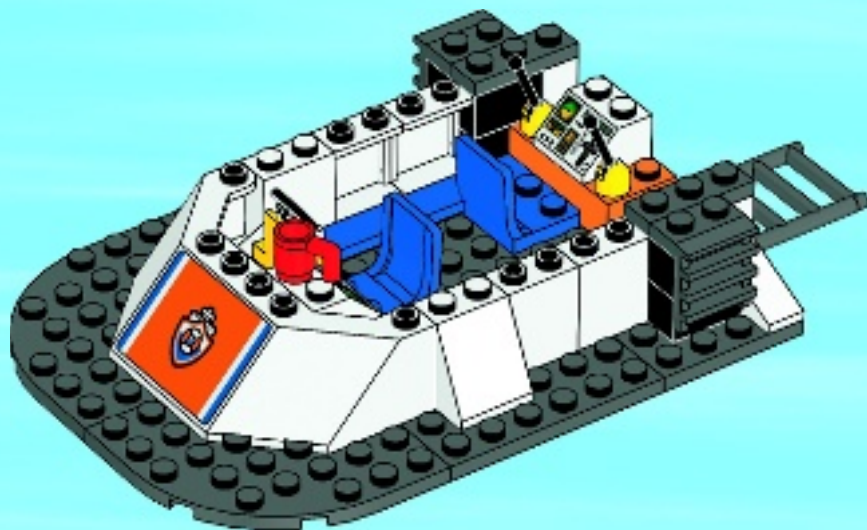

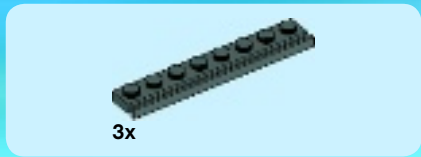

18

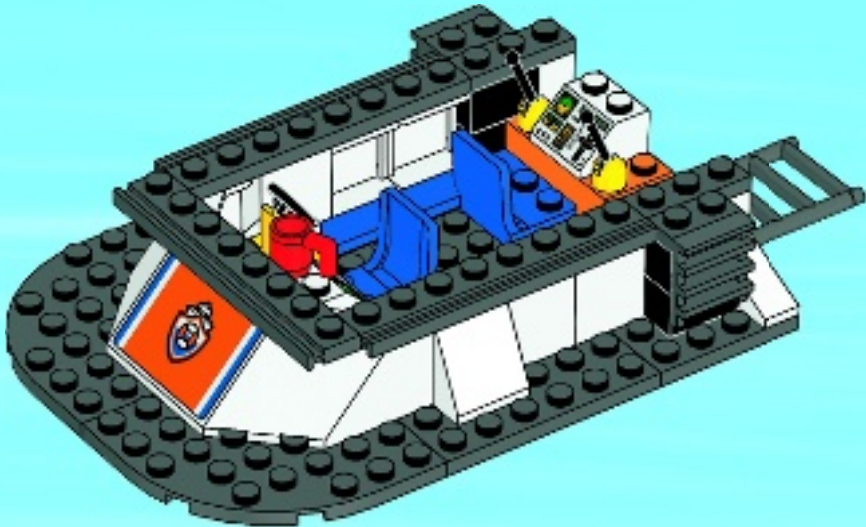



2x

19

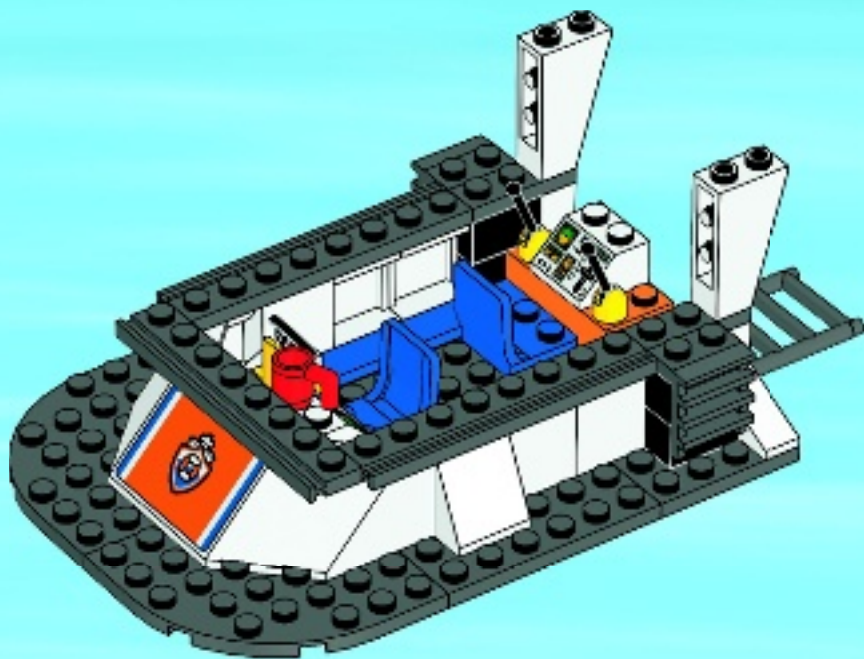

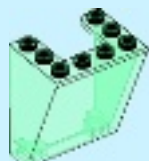

1x

20

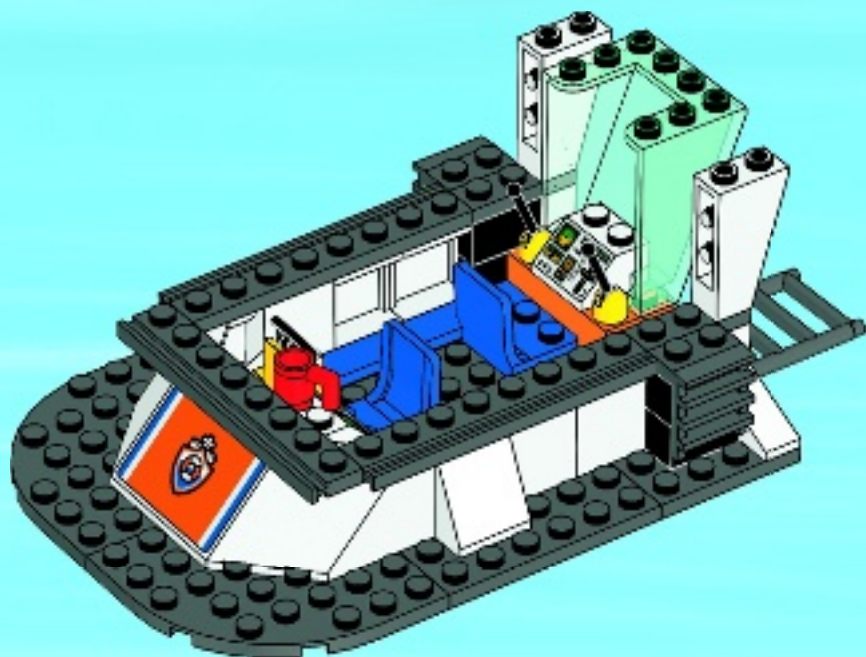



4x

21

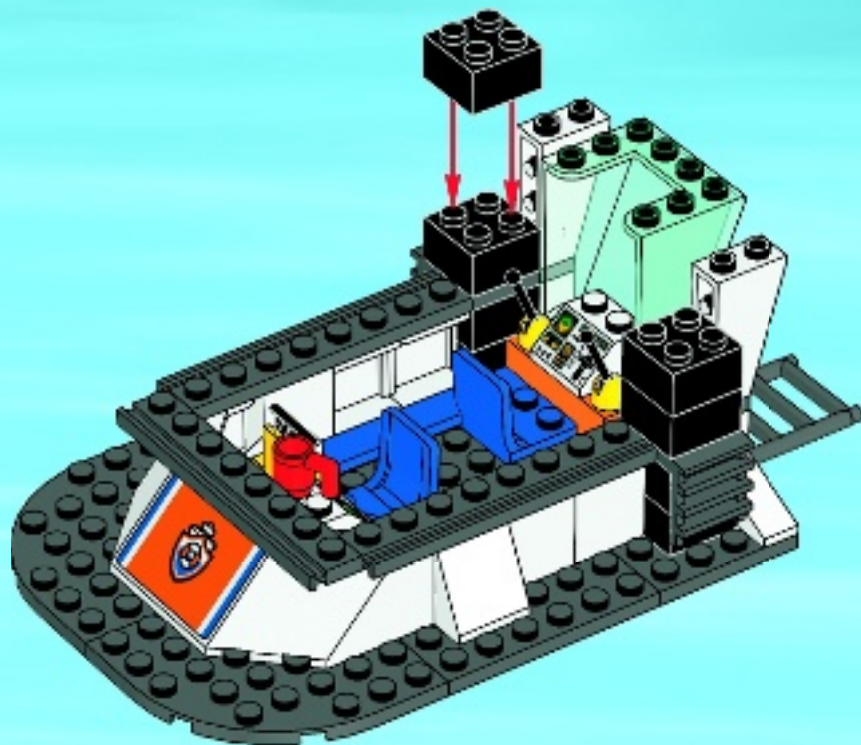

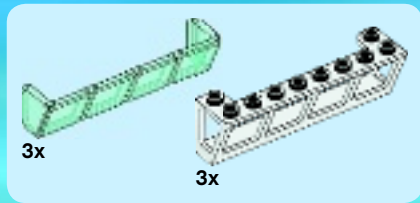

22

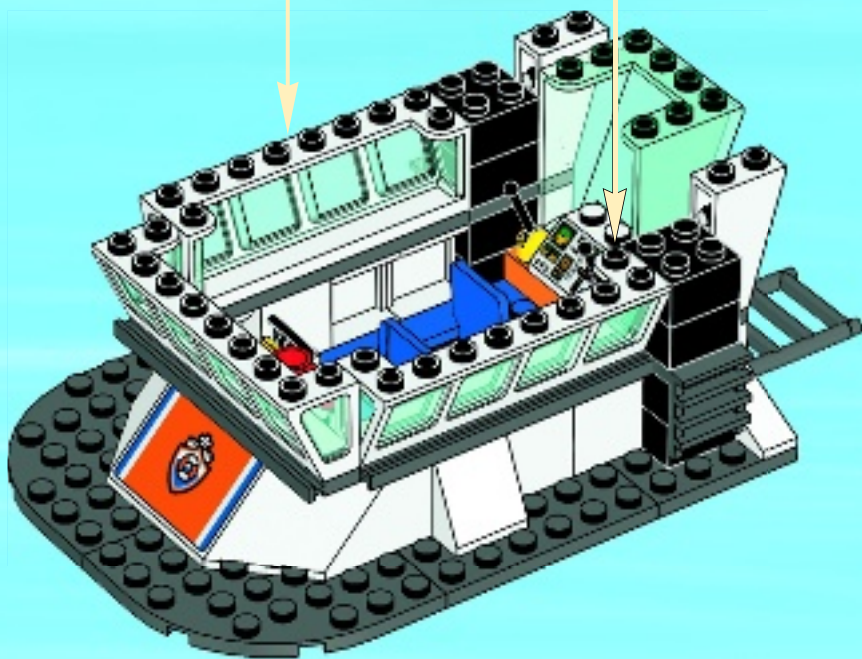
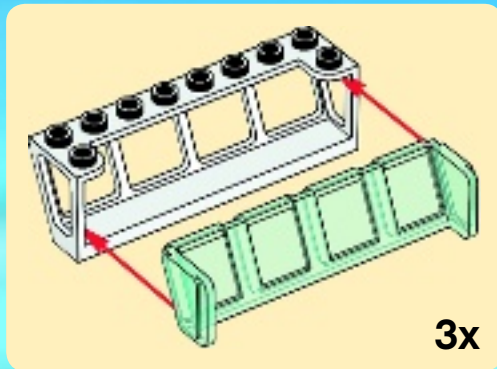

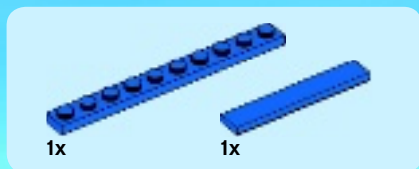

23

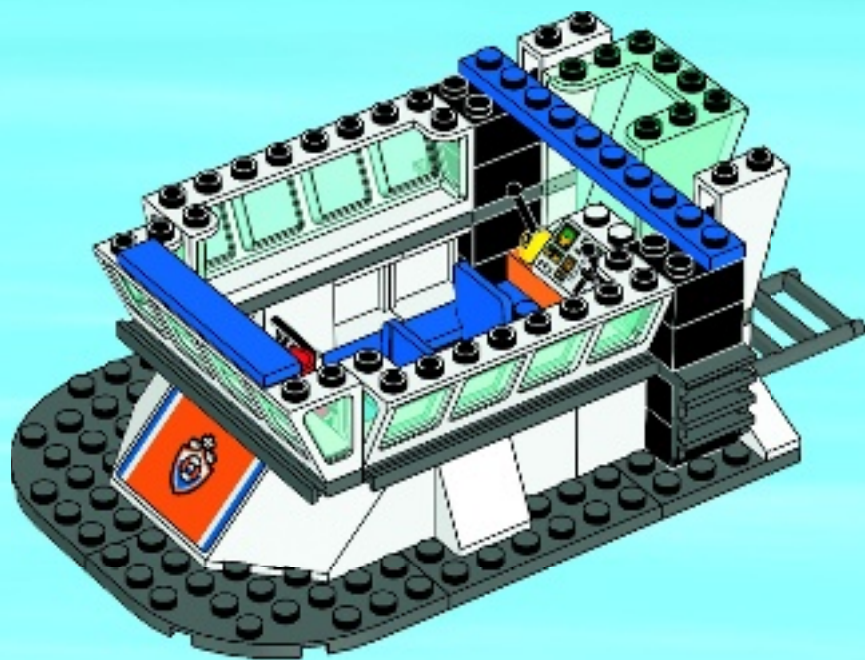

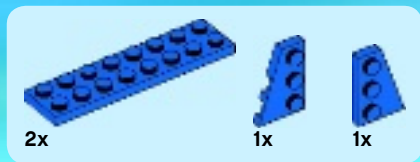

24

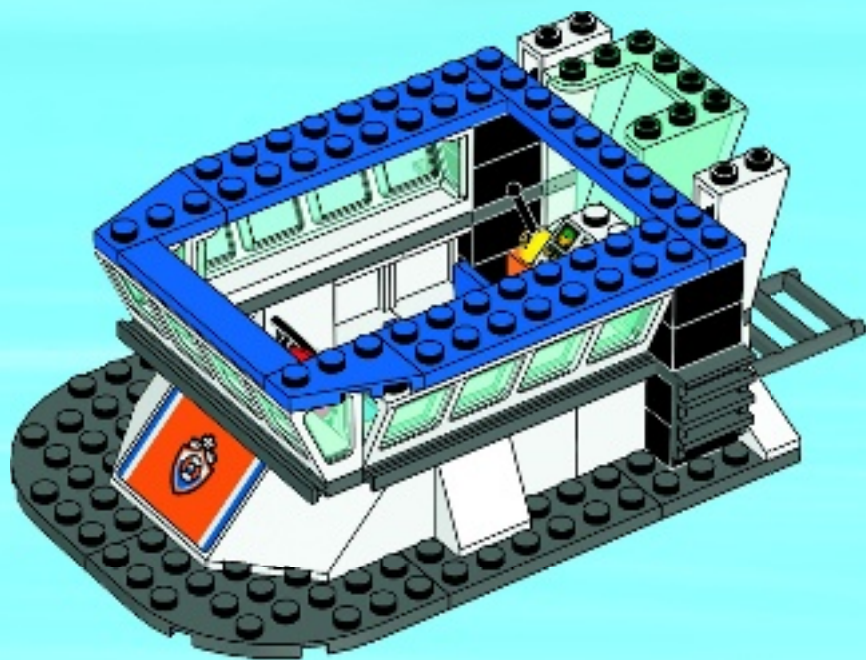



2x



1x

25

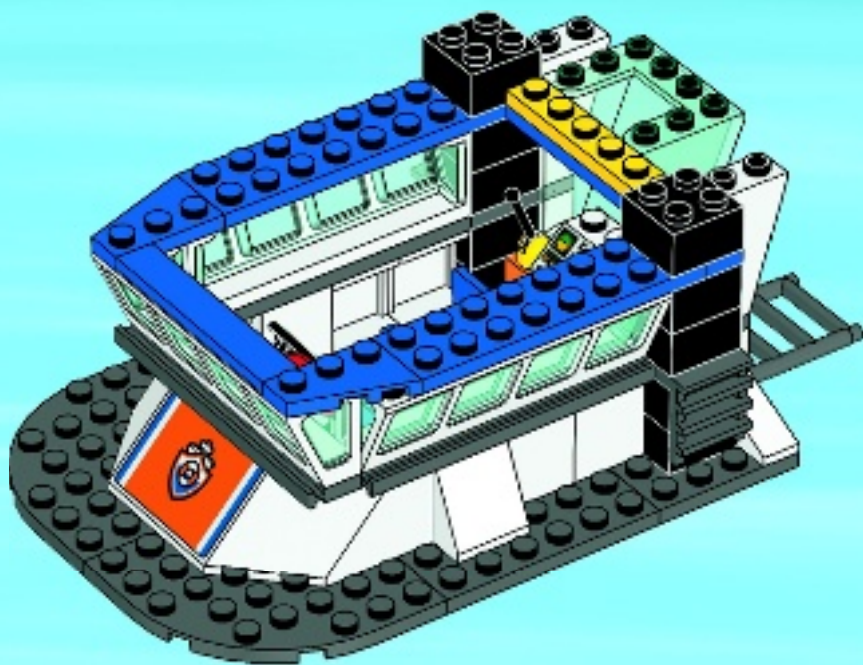



1x



2x

26

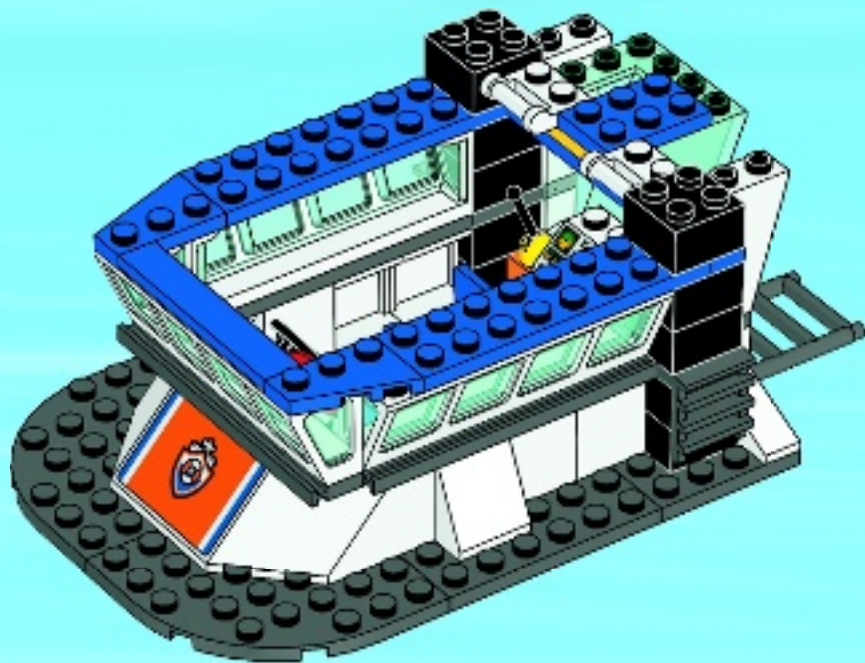



1x



1x

27

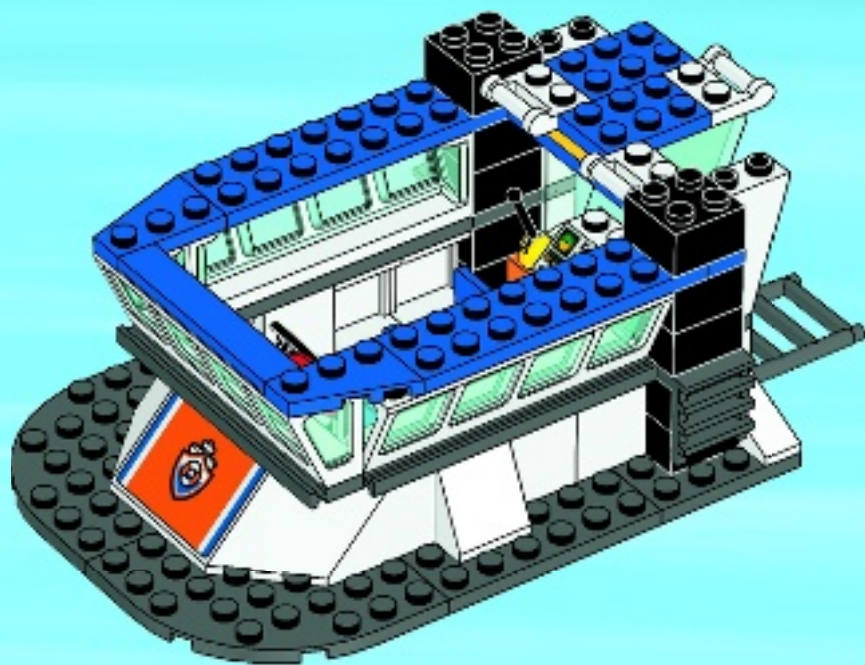



1x

1x

28

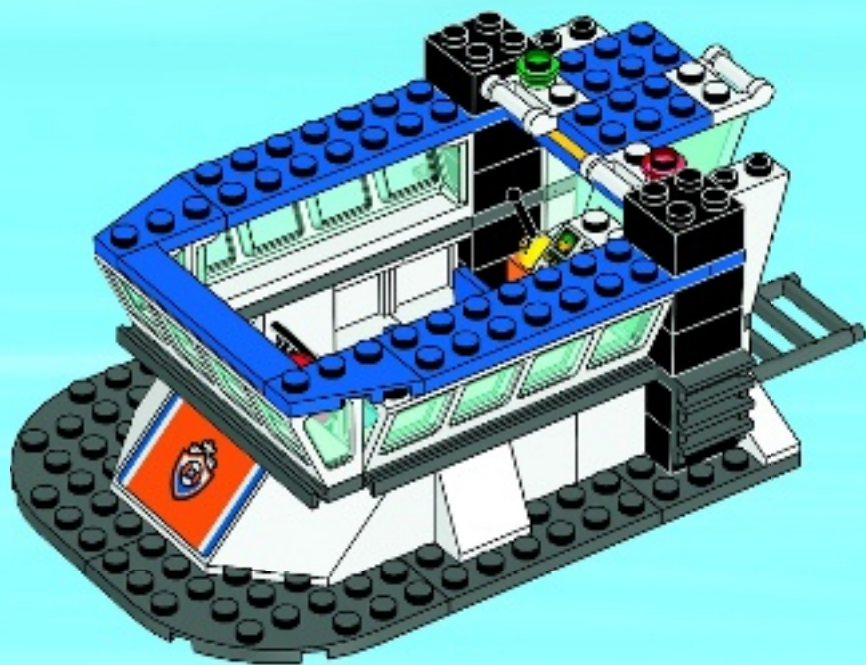



2x



1x

29

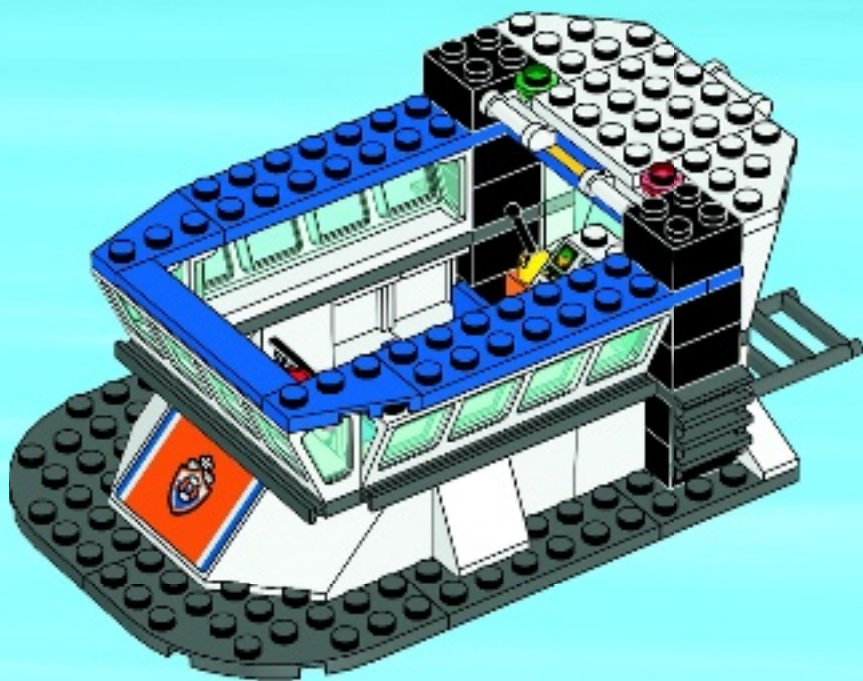



2x

30

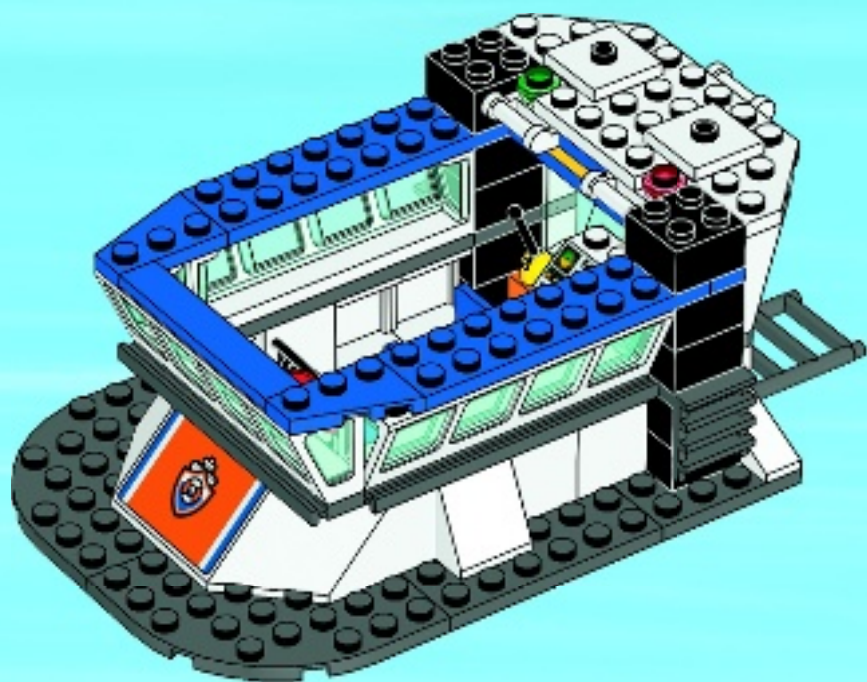



6x

31

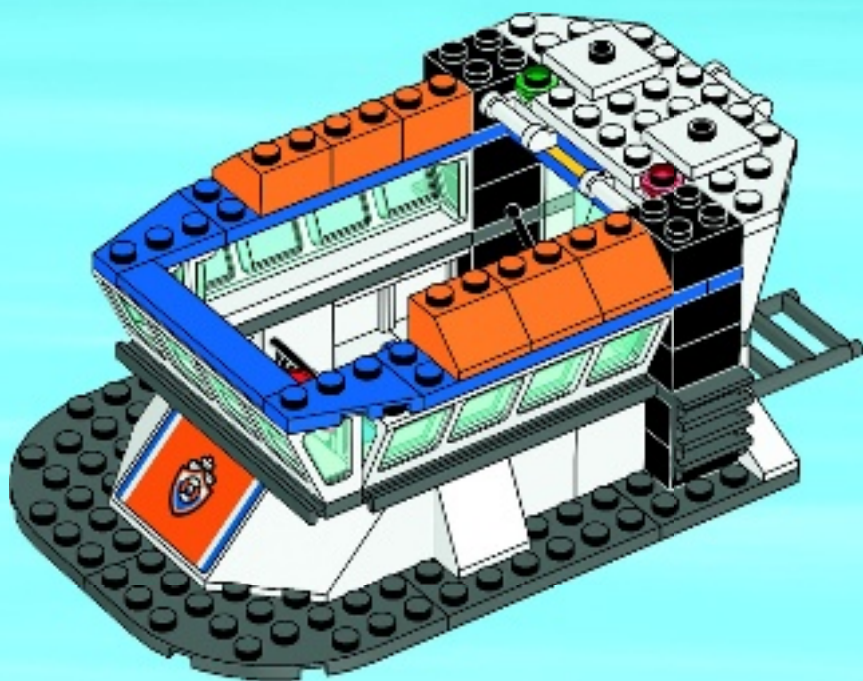



1x



1x

32

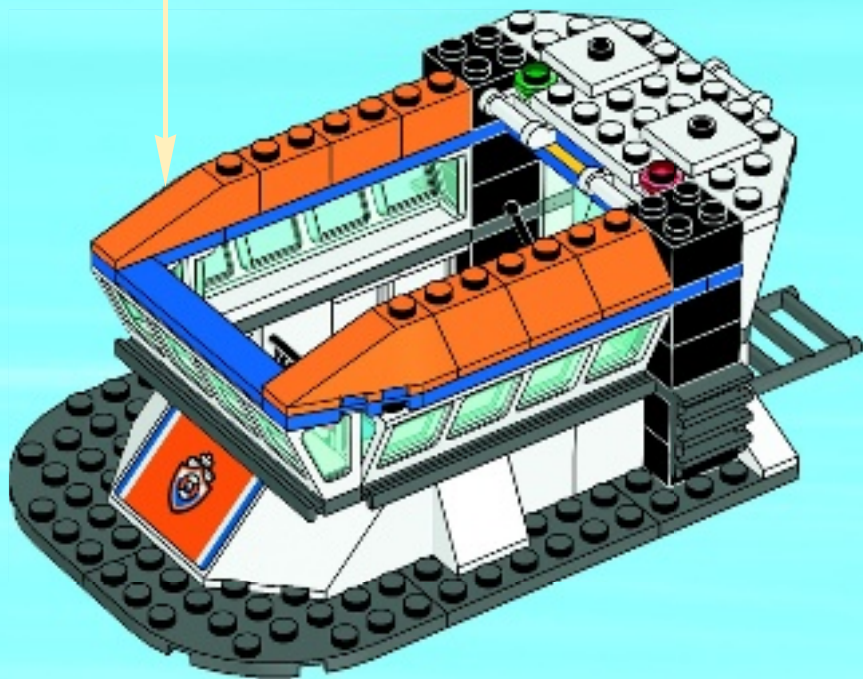



2x



2x

33

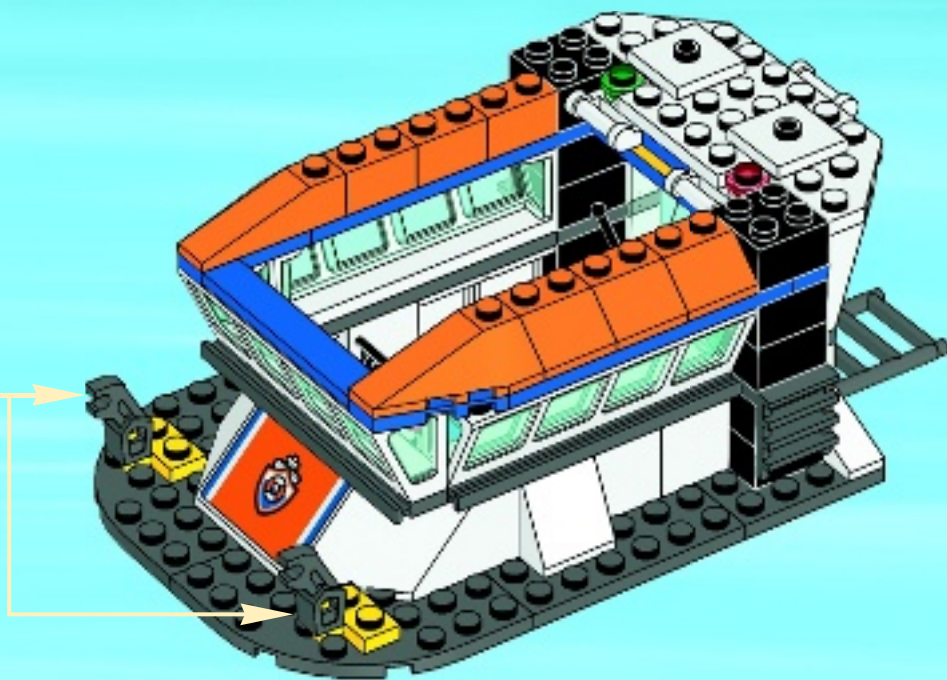
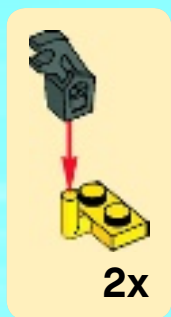



2x



2x

34

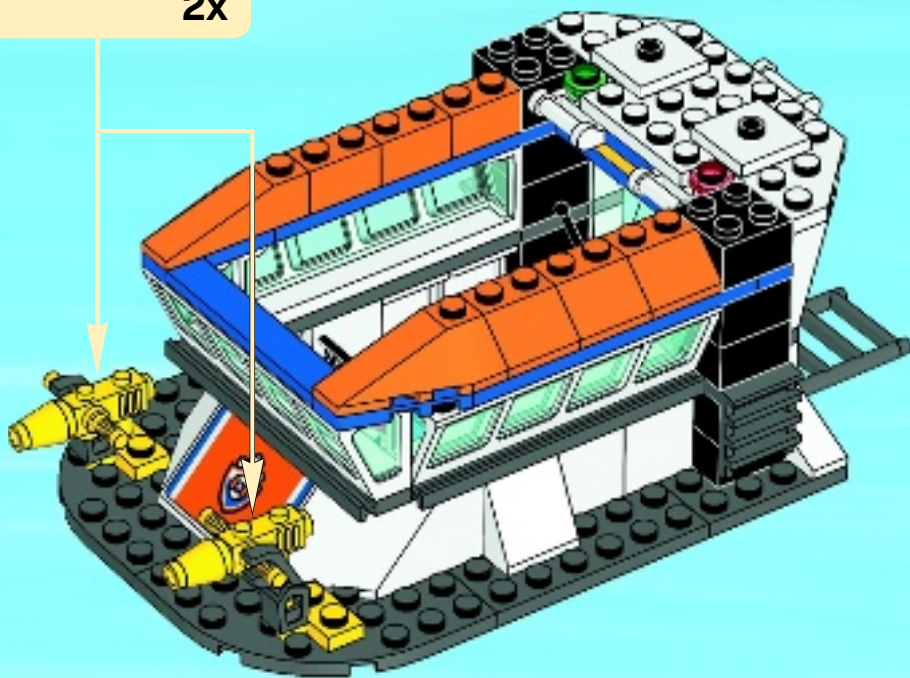
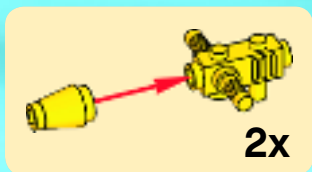

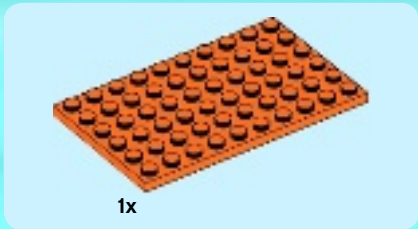

1x

1

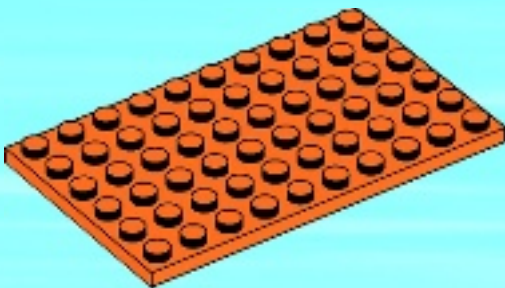

4x

2





2x

3

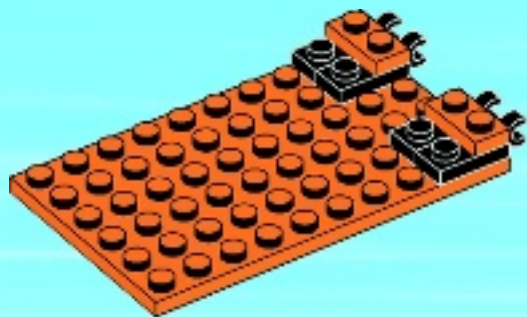

2x

4





1x



1x

5



1x



1x



1x

6





1x

7

1

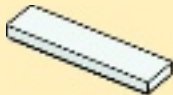

2

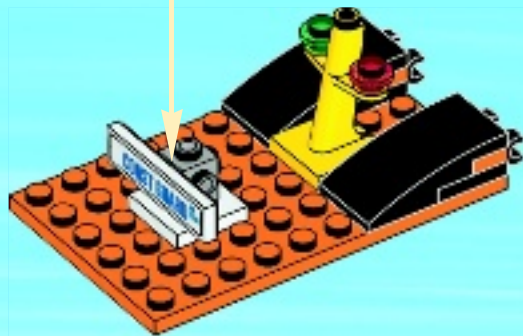
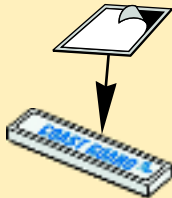



1x



2x

8

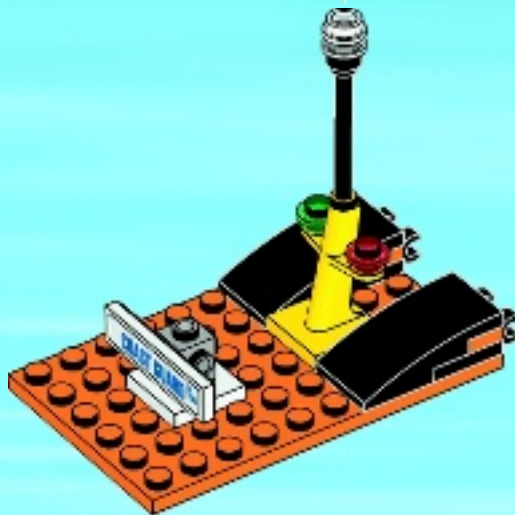

35

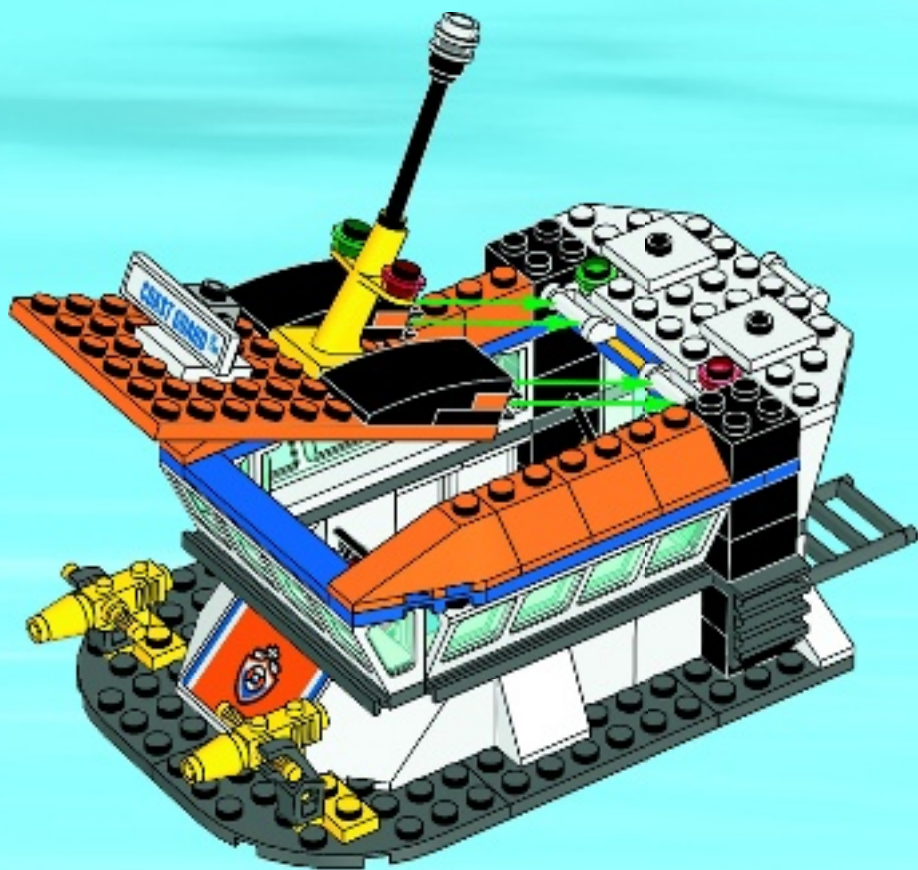



2x

36

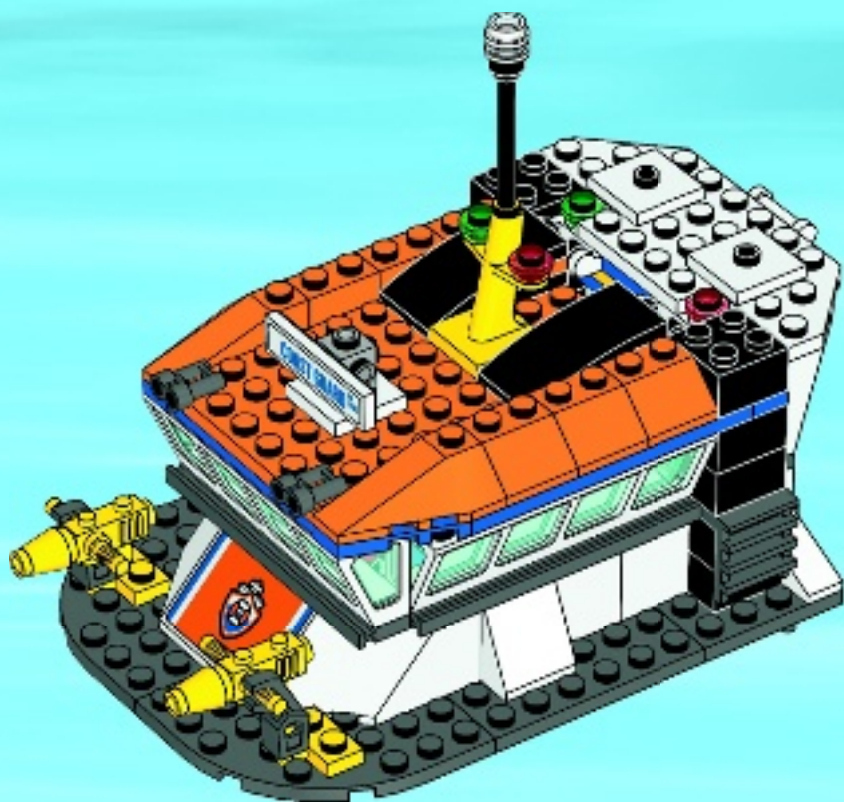



1x



1x



1x



1x

37

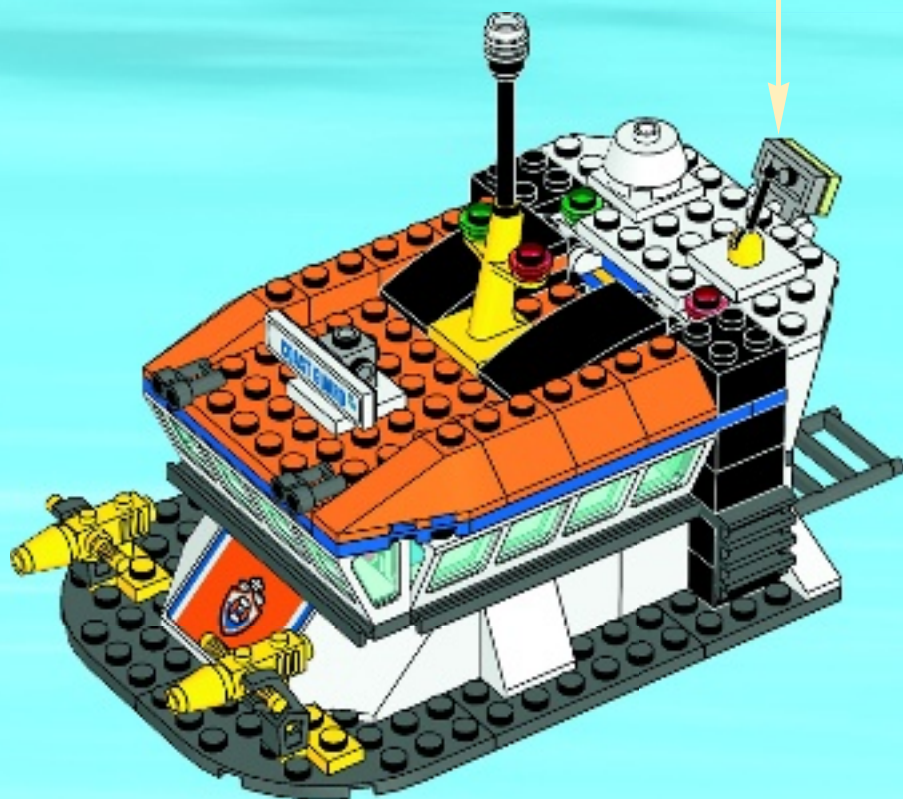
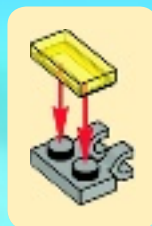



2x

38

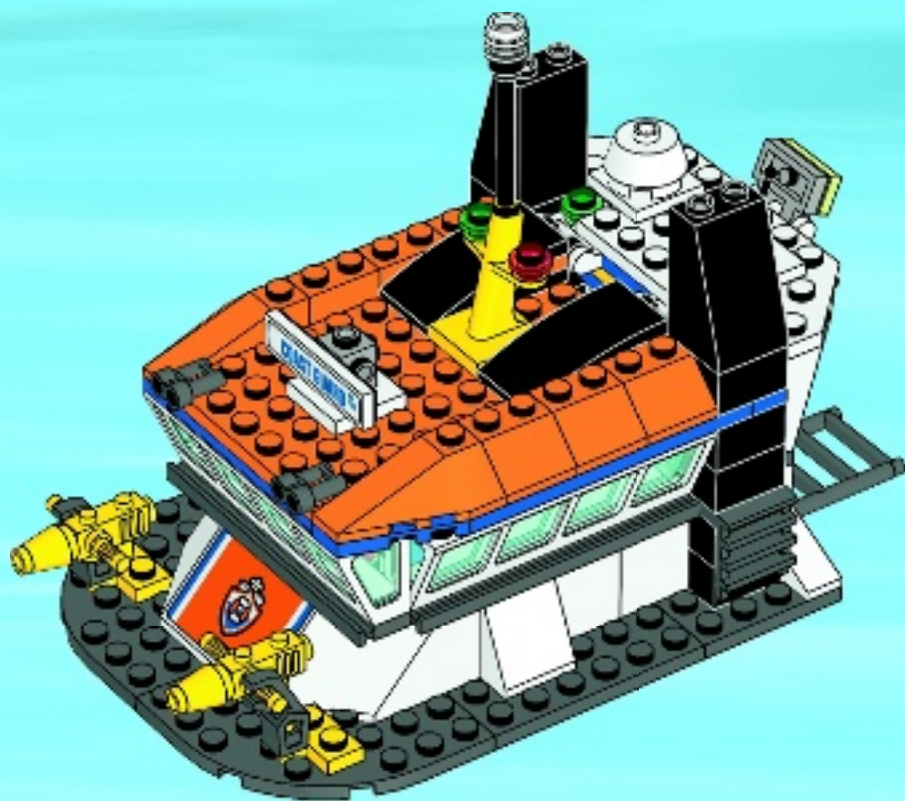

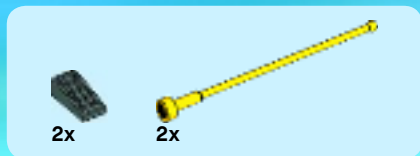

39

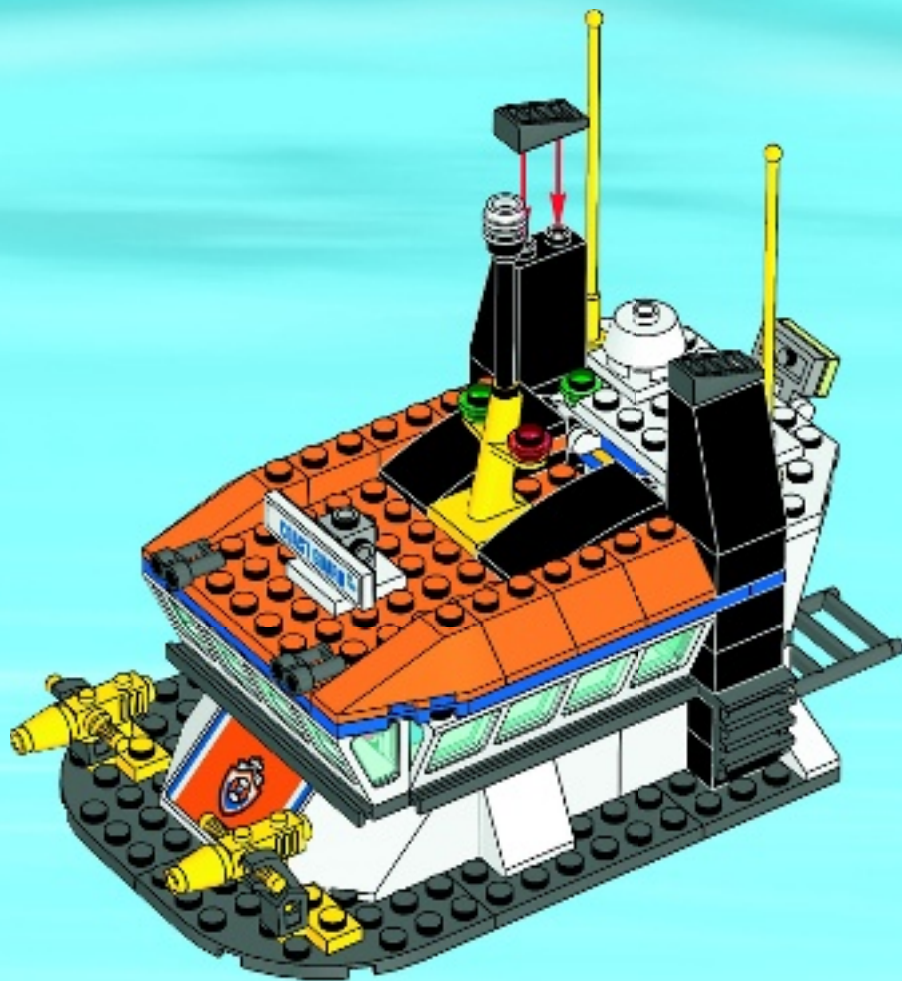

40

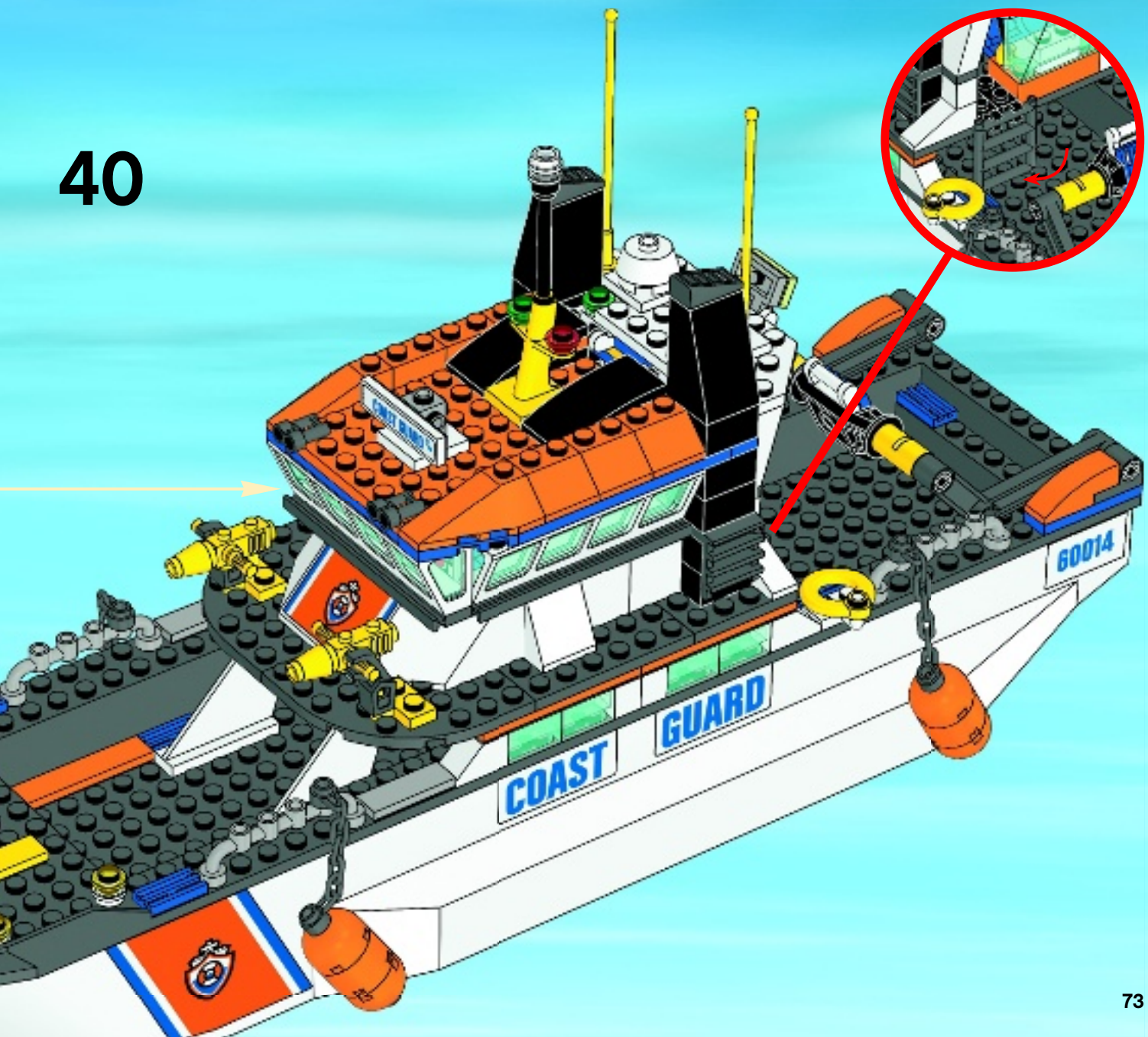

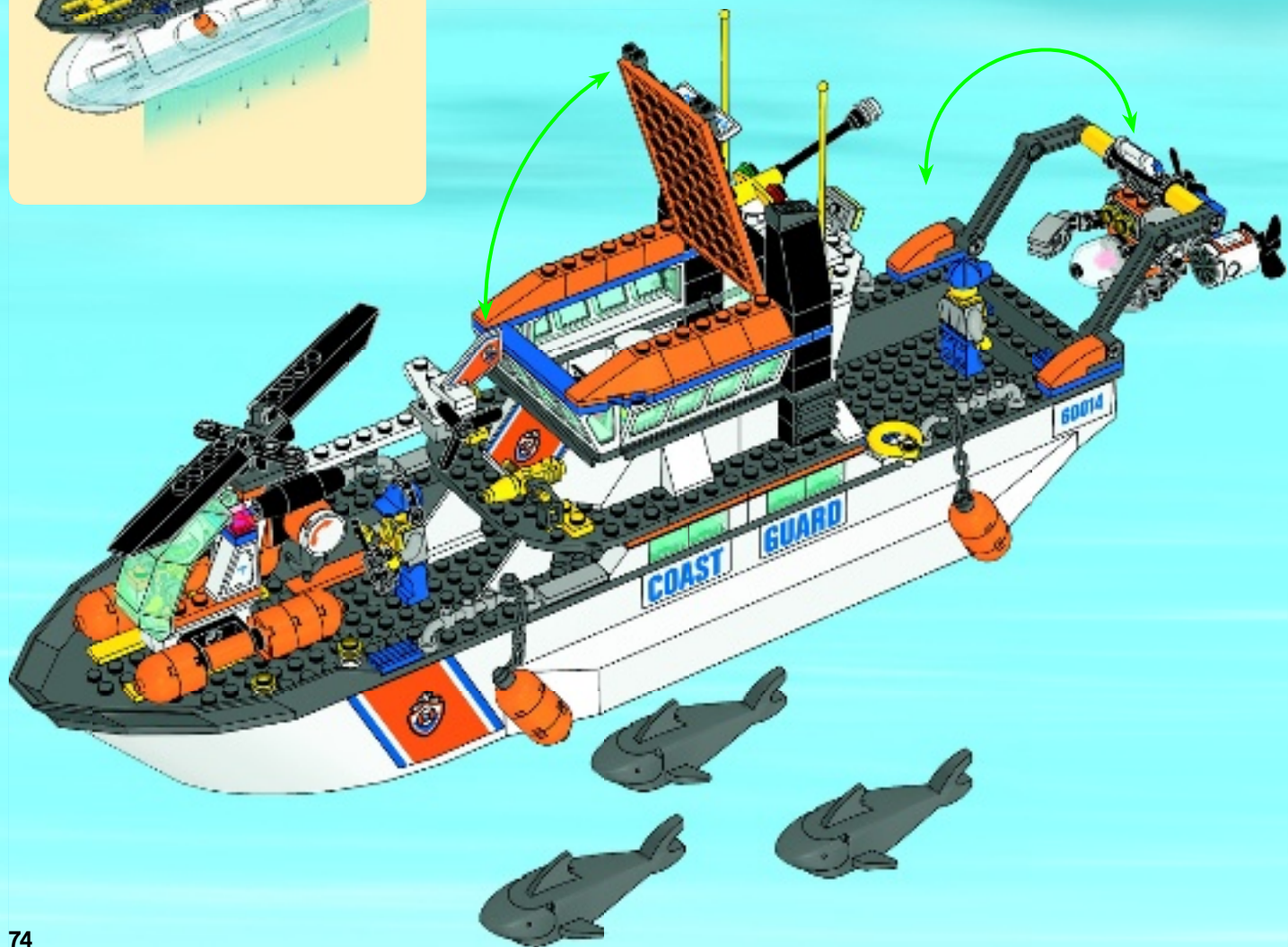



Nintendo



CITY

UNDERCOVER





CITY

LEGO.com

LEGO and the LEGO logo are trademarks of the LEGO Group. ©2013 The LEGO Group. 6075297



60004



60003



60002



60001



60000