



CITY

60013









+

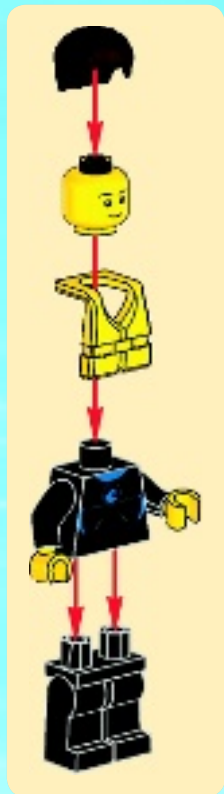

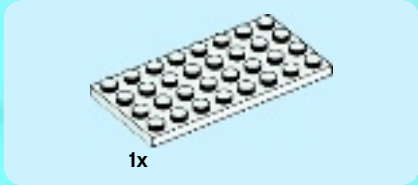

1

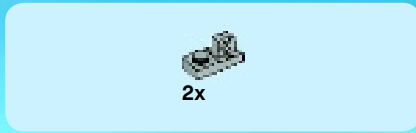

2



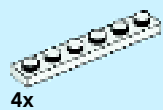

4x

3

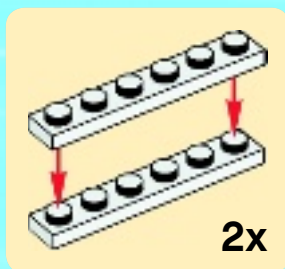
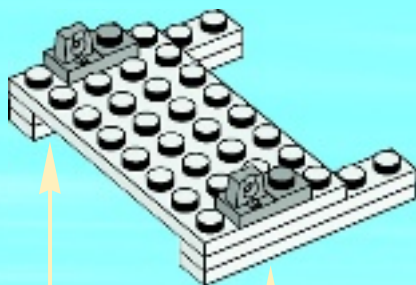

2x

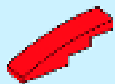

2x



1x

4

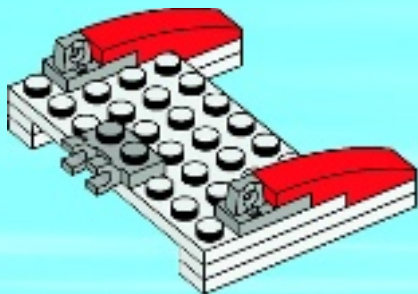

1x



1x

5

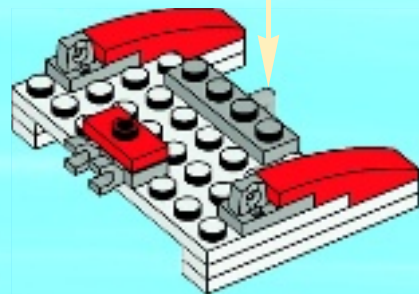
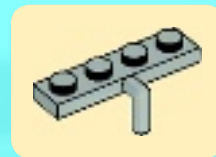



1x



1x

6

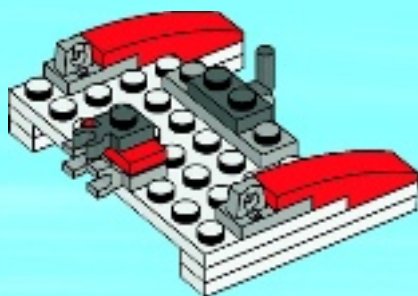



1x



1x

7

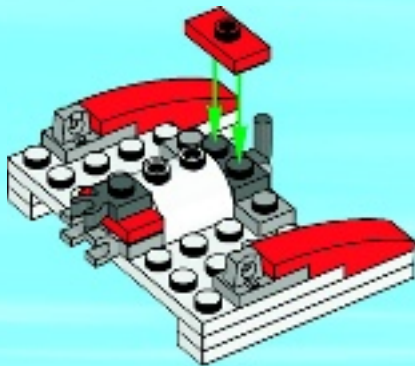

1x



1x

8

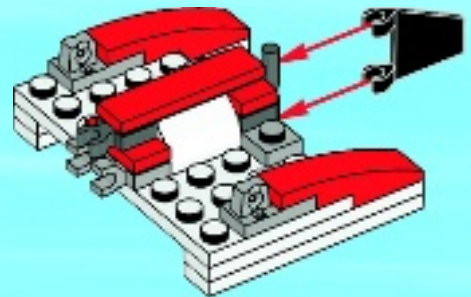

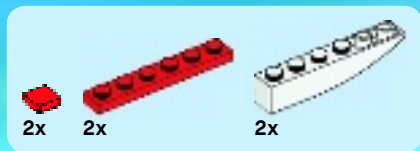

9

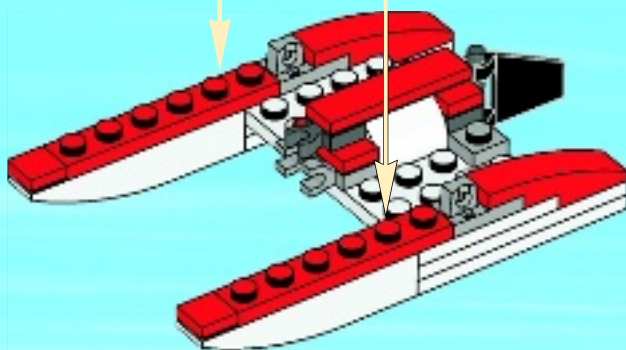
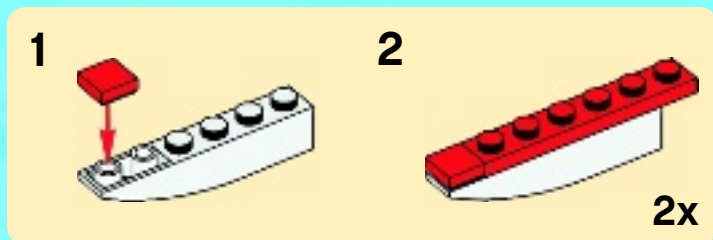



2x

10

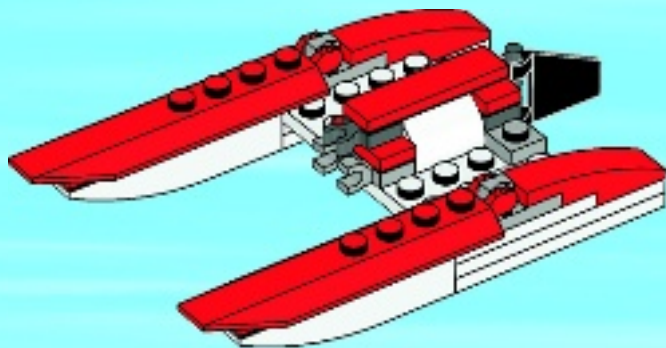

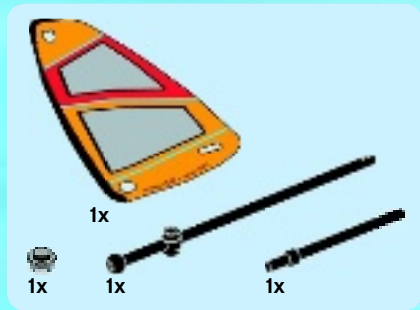

11

1



2



3



4



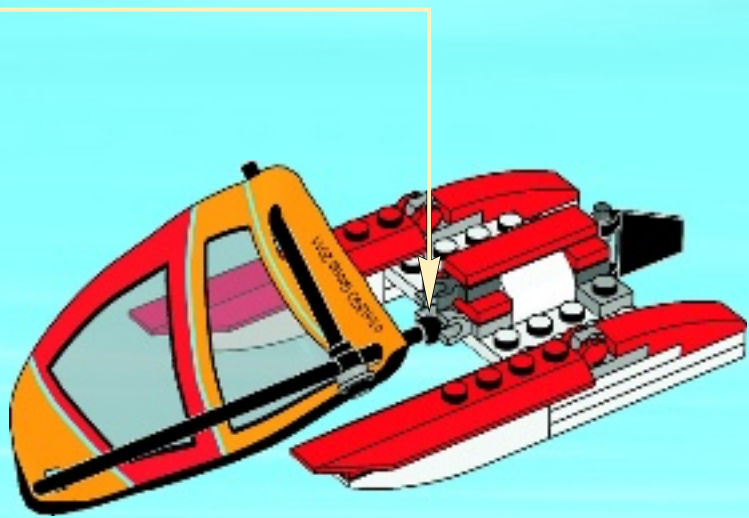

12

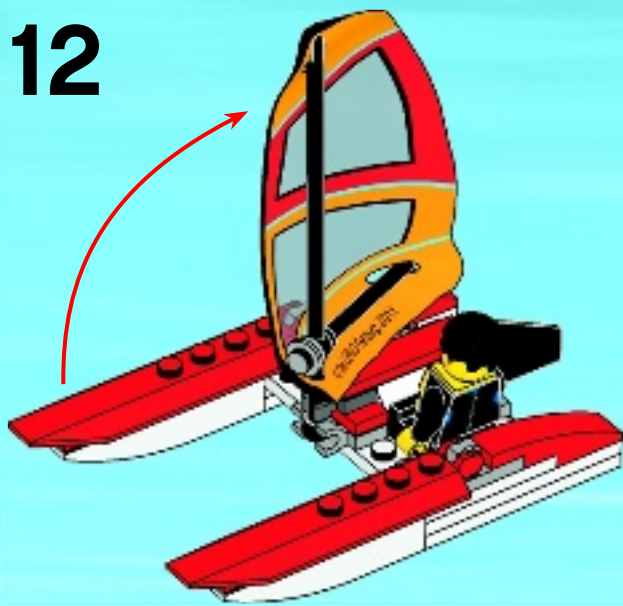

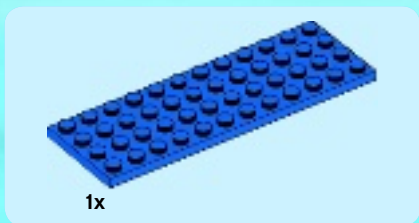

1



2

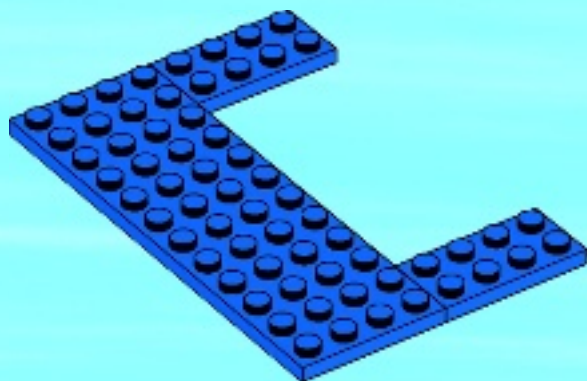



2x

3

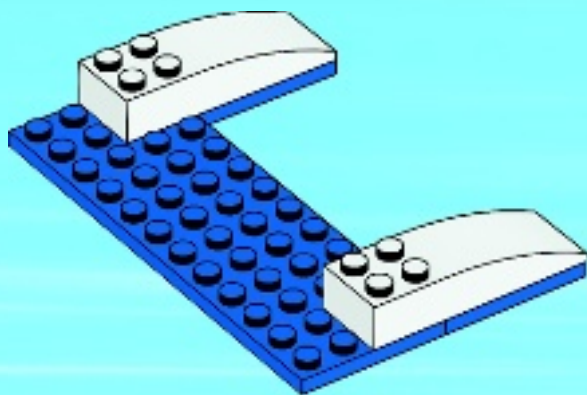

4x

4

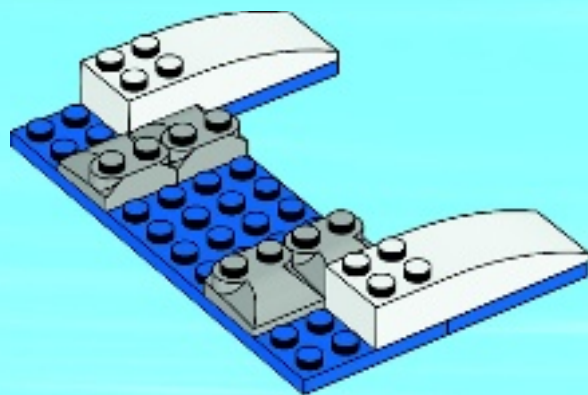

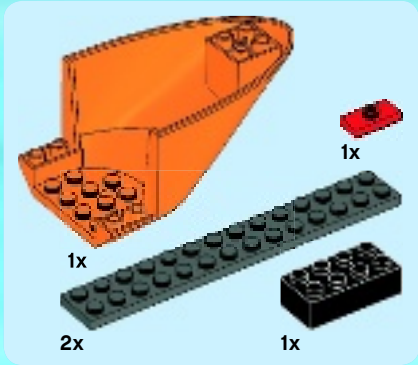
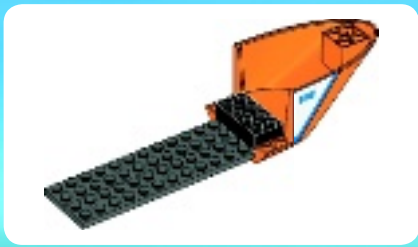

5

1

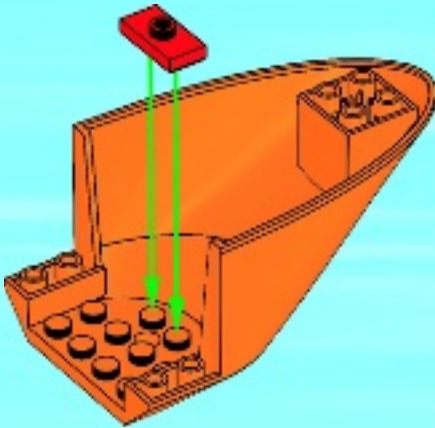

2

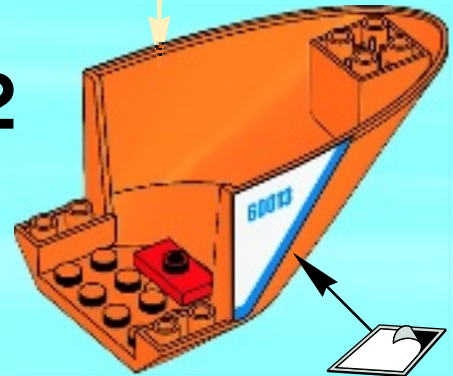

3

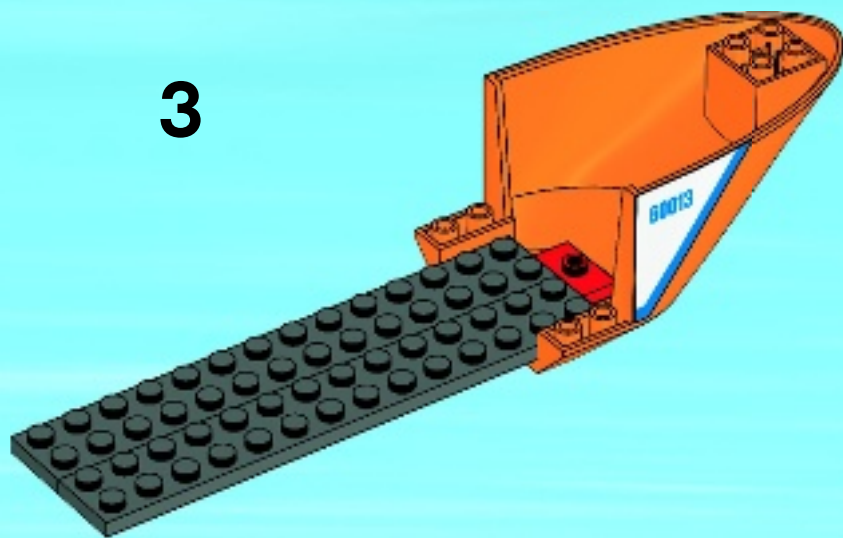

4

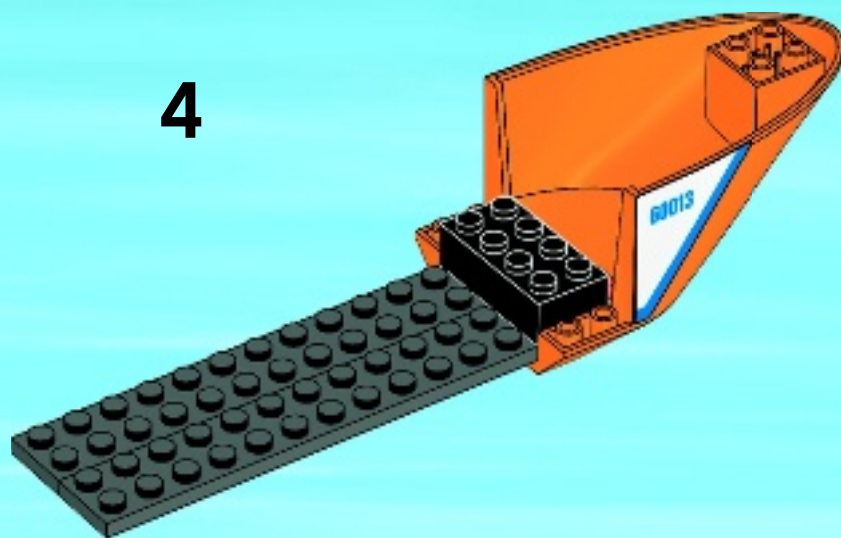





6

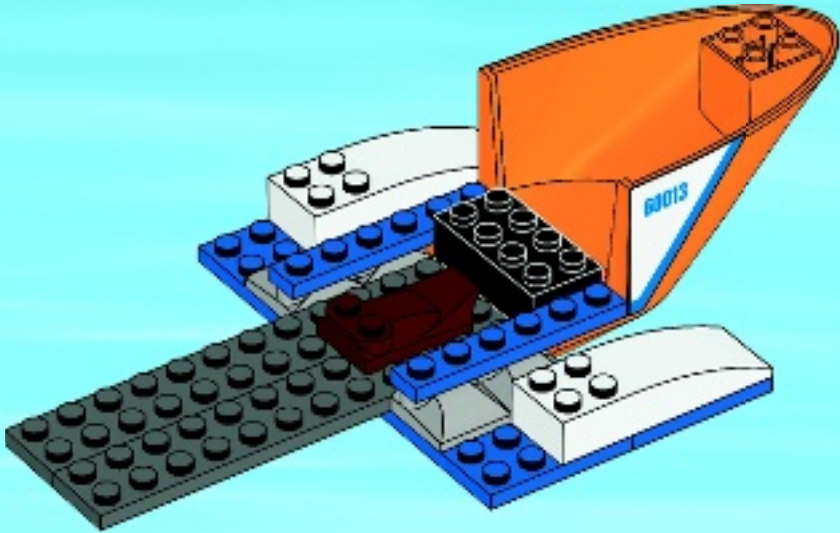

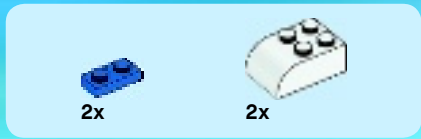

7

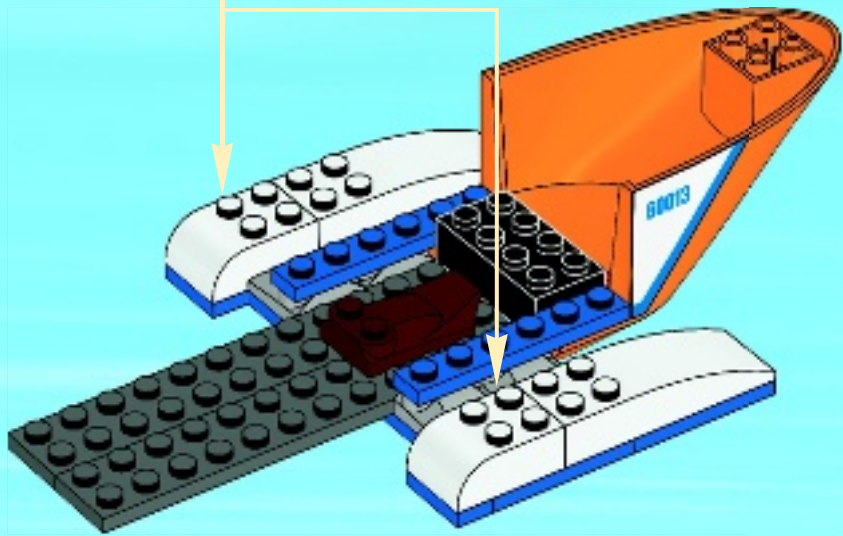
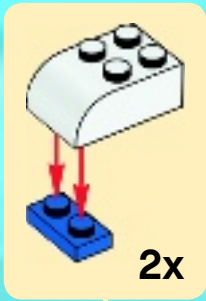



2x

8

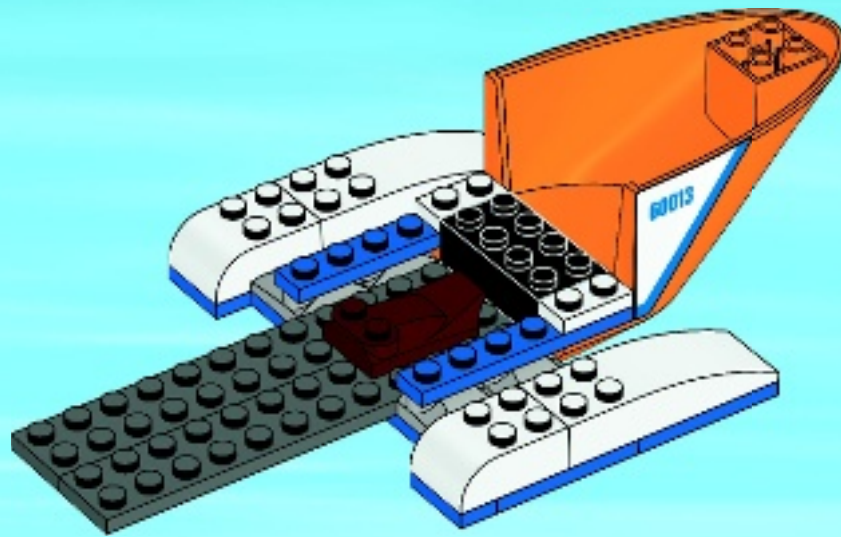



1x

9

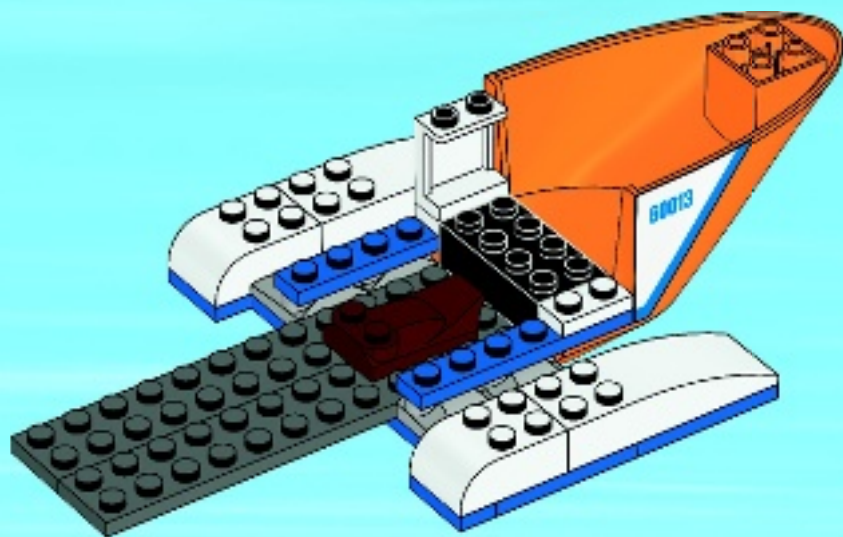



1x

10

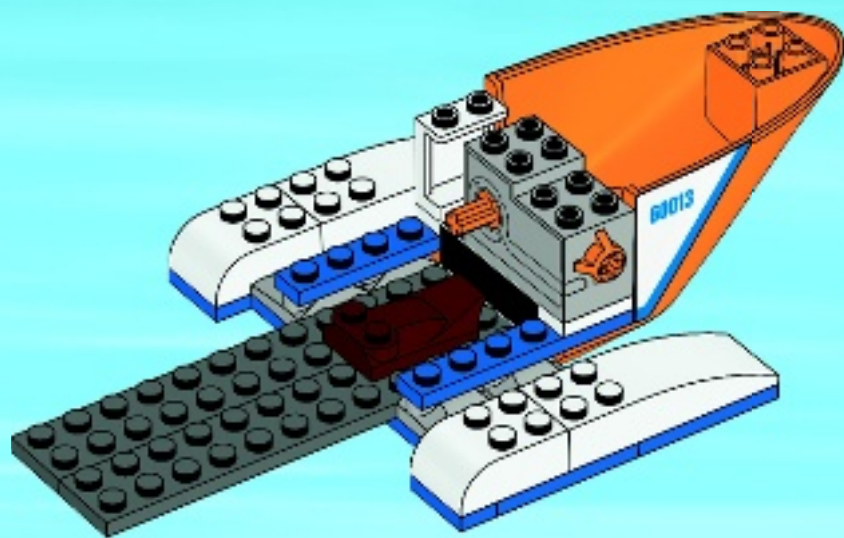



1x

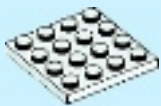

2x

11

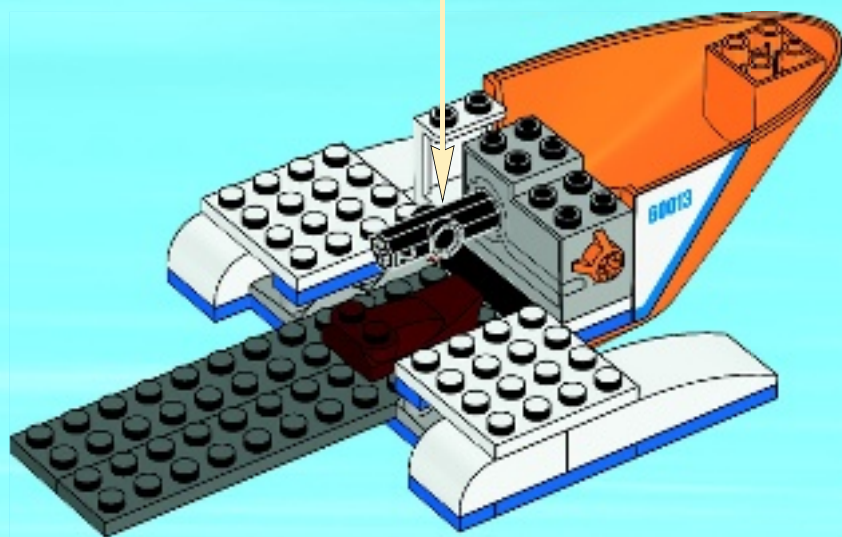

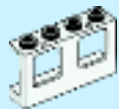

2x



4x

12

1

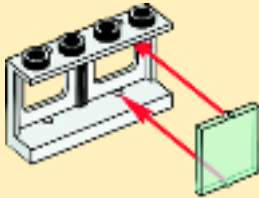

2



2x

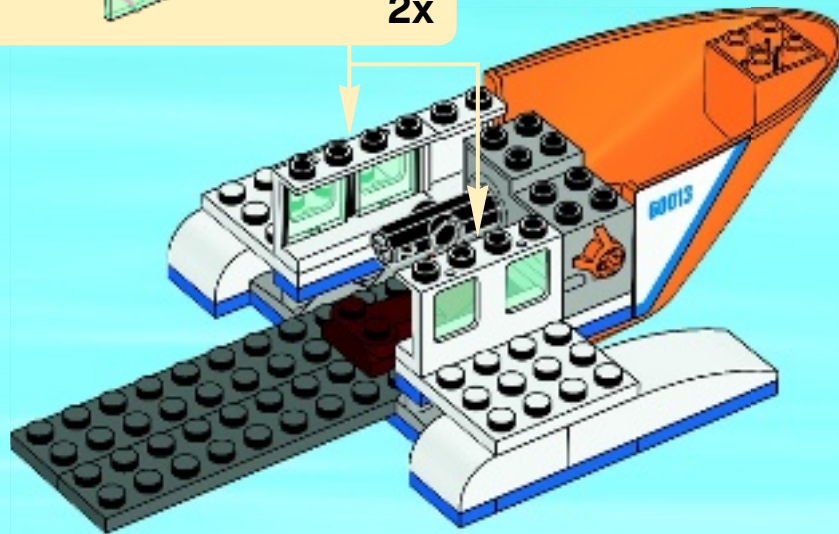



2x

13

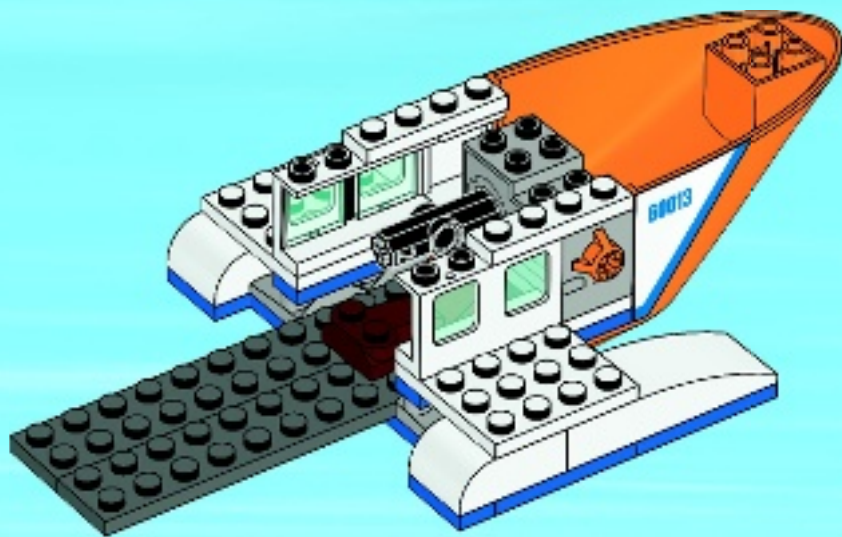



1x



1x



1x



1x

14

1

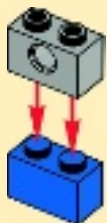

2



3

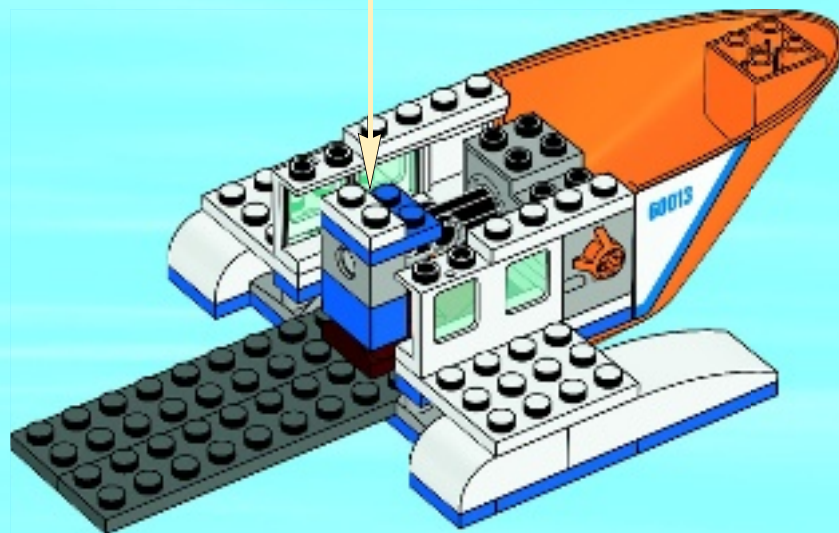



1x

15

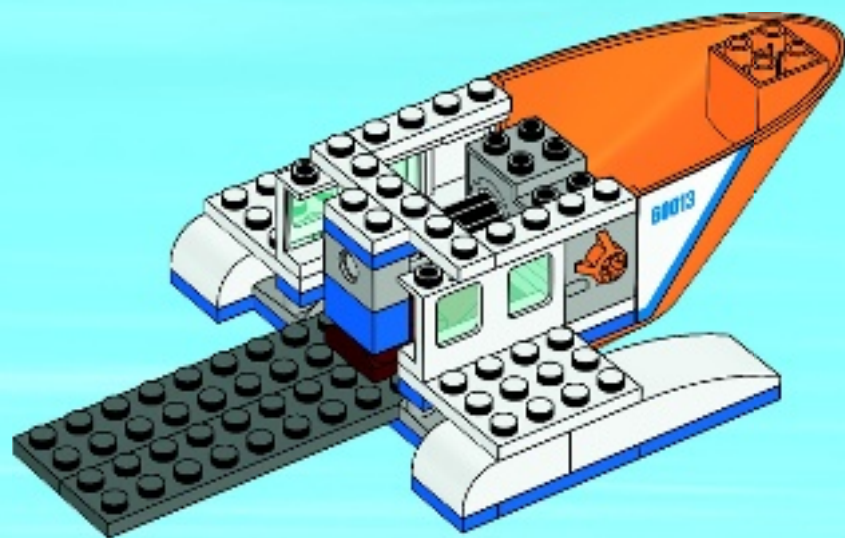

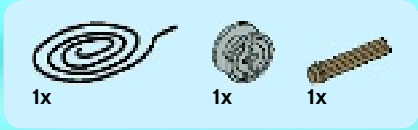

16

1

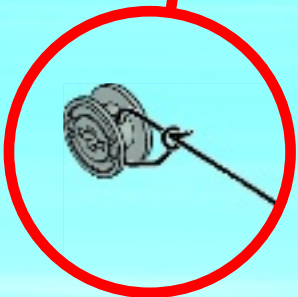

2

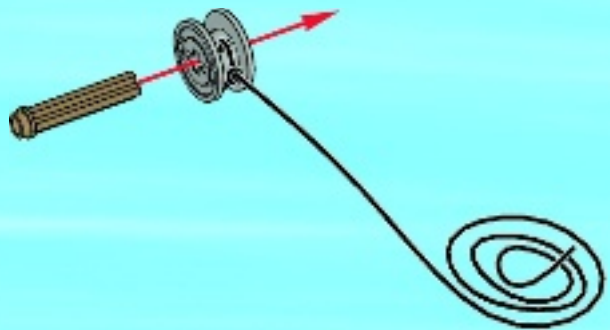

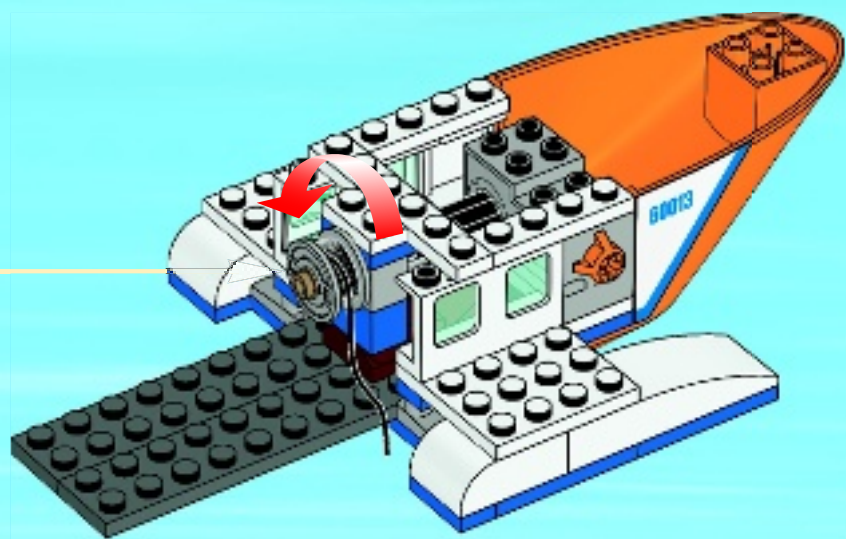

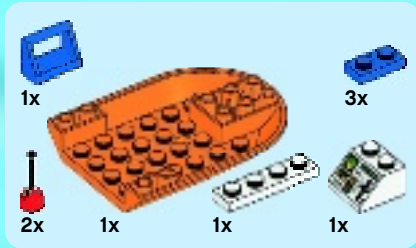

17

1

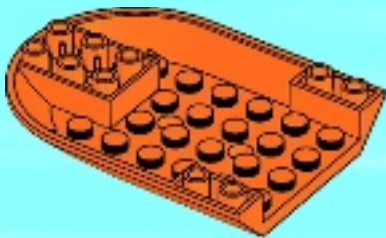

2



3



4



5

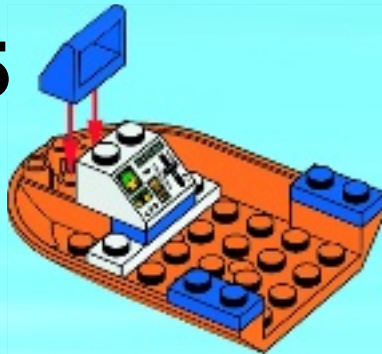

6



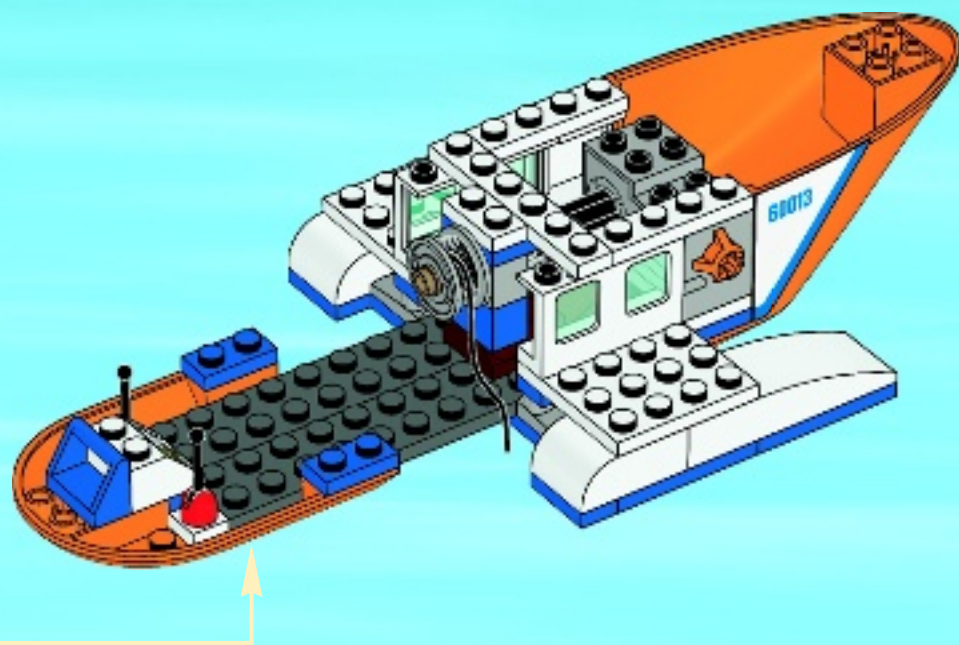



4x

18

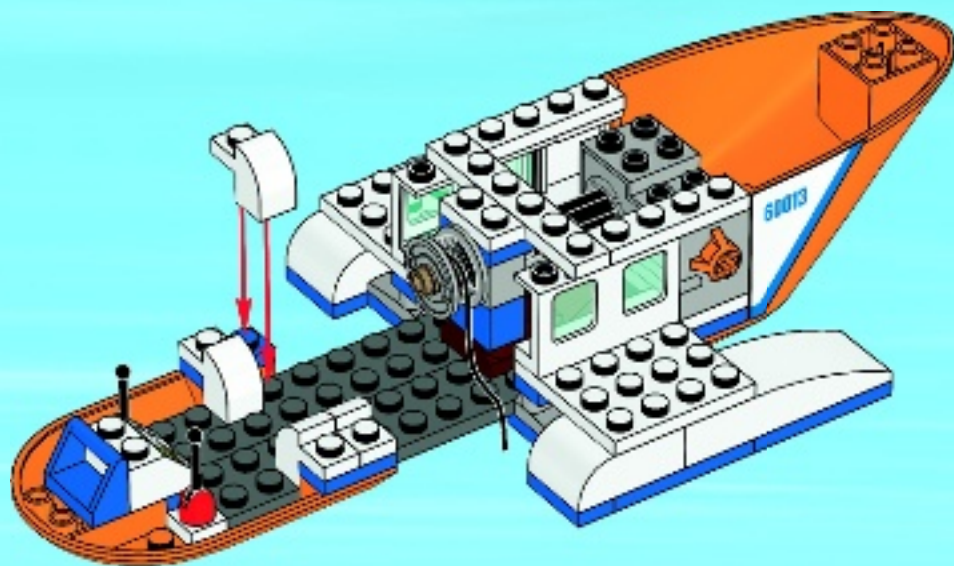



2x

19

1

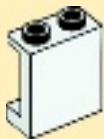

2

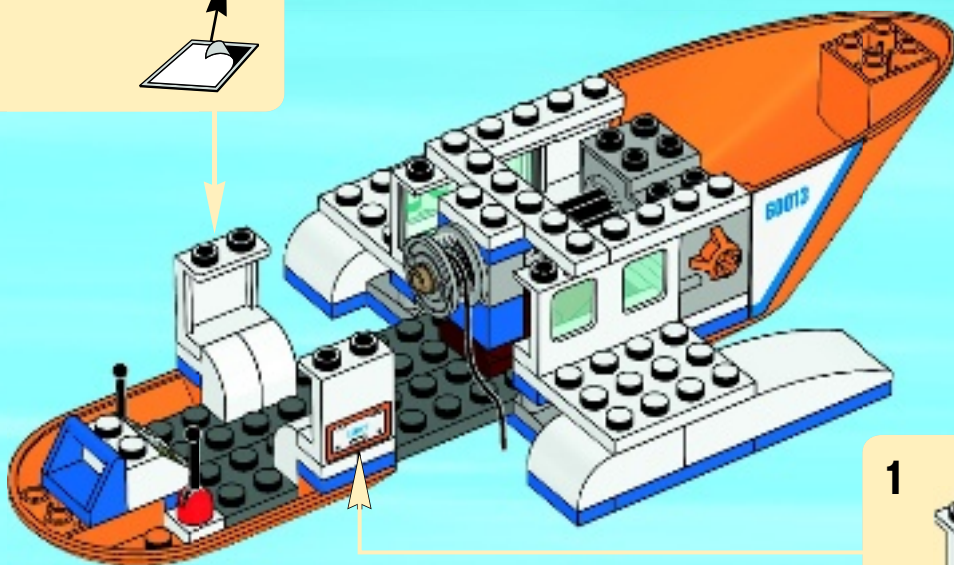

1

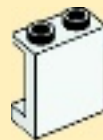

2

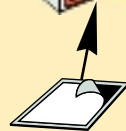



2x



1x

20

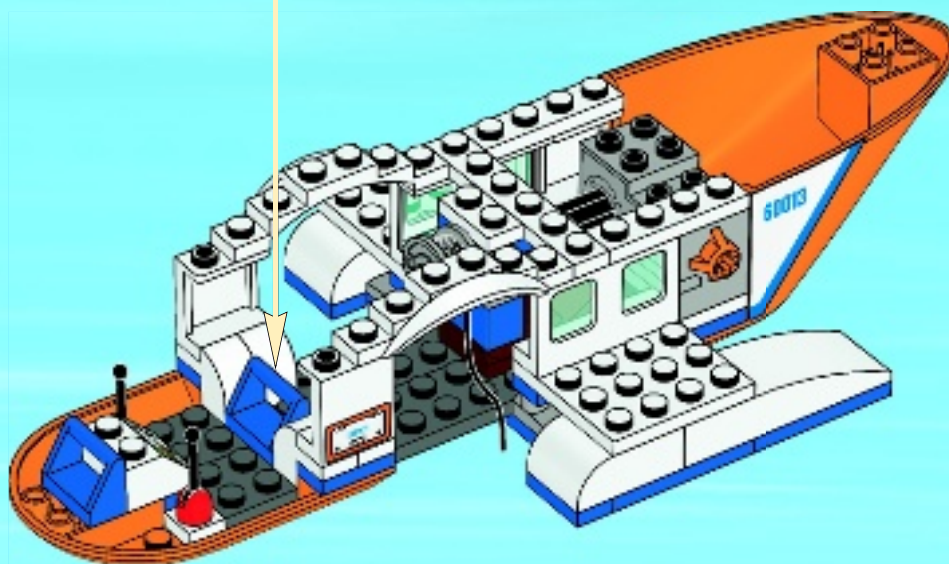



1x



1x



1x

21

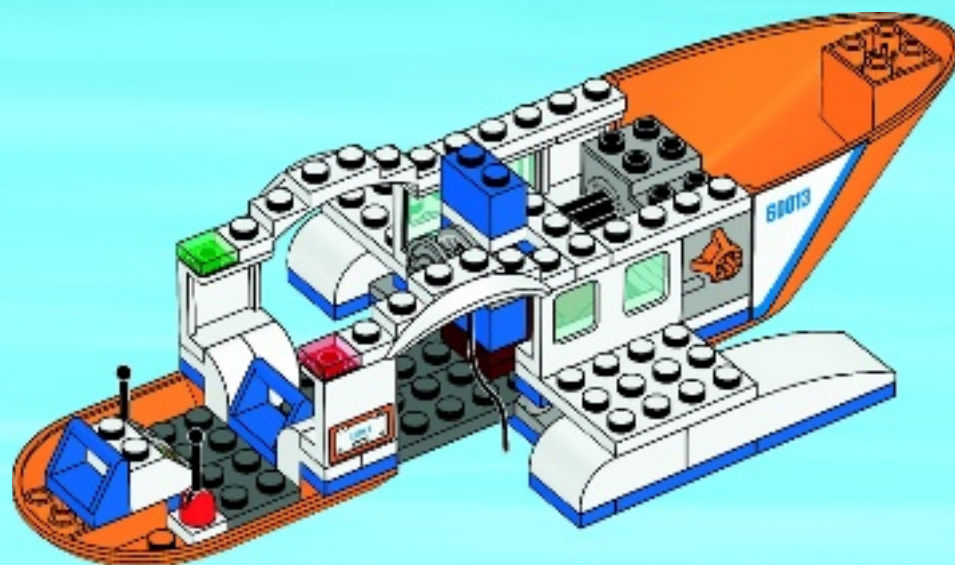

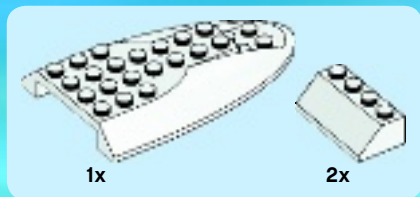

22

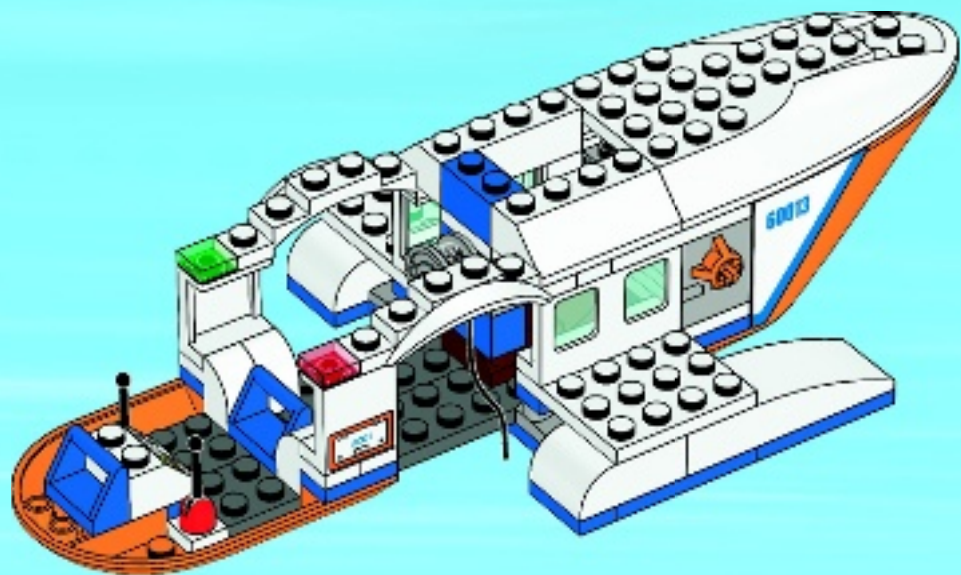

23

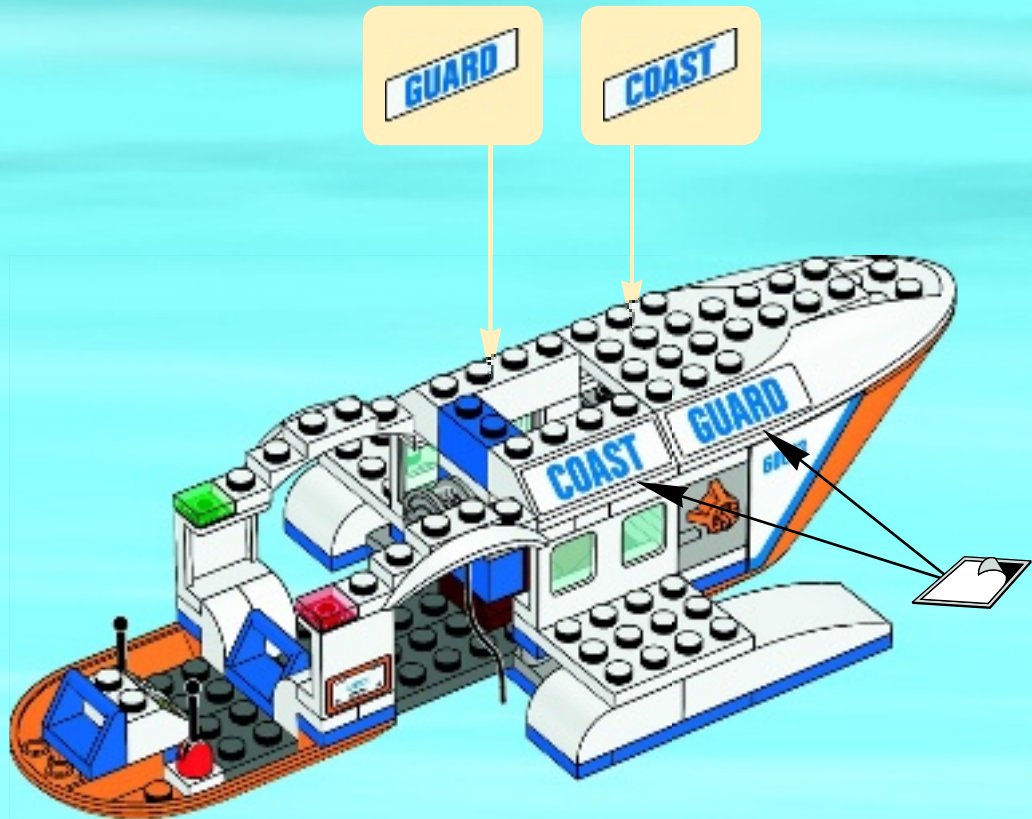

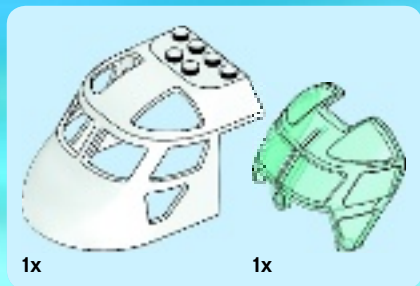

24

1

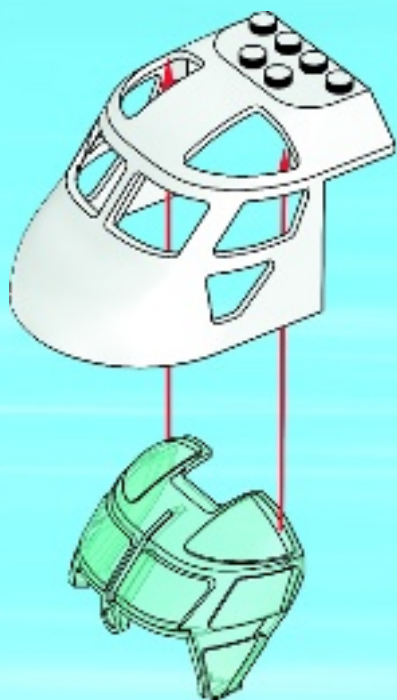

2

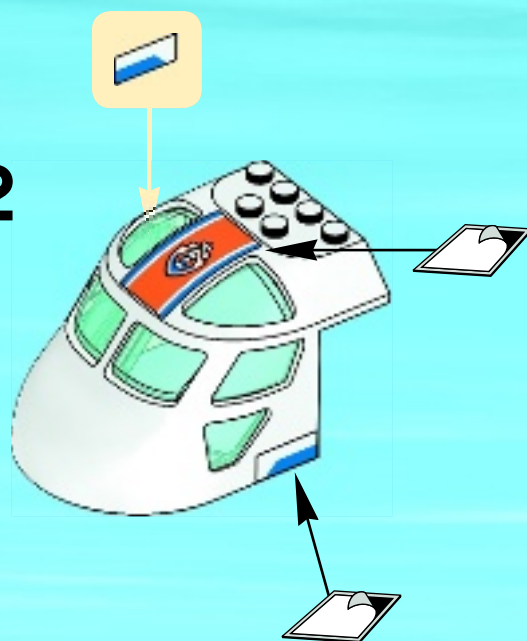

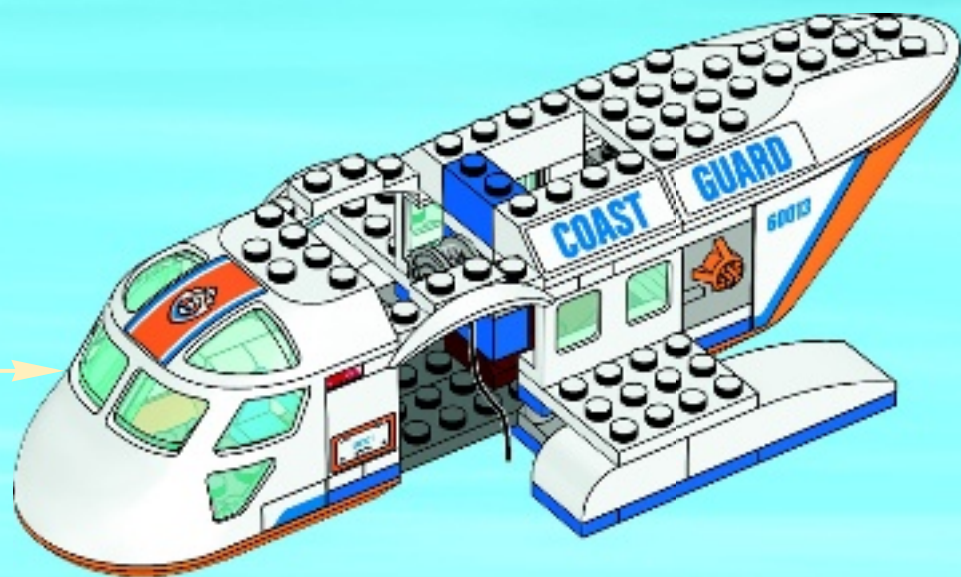

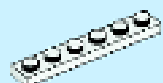

2x

25

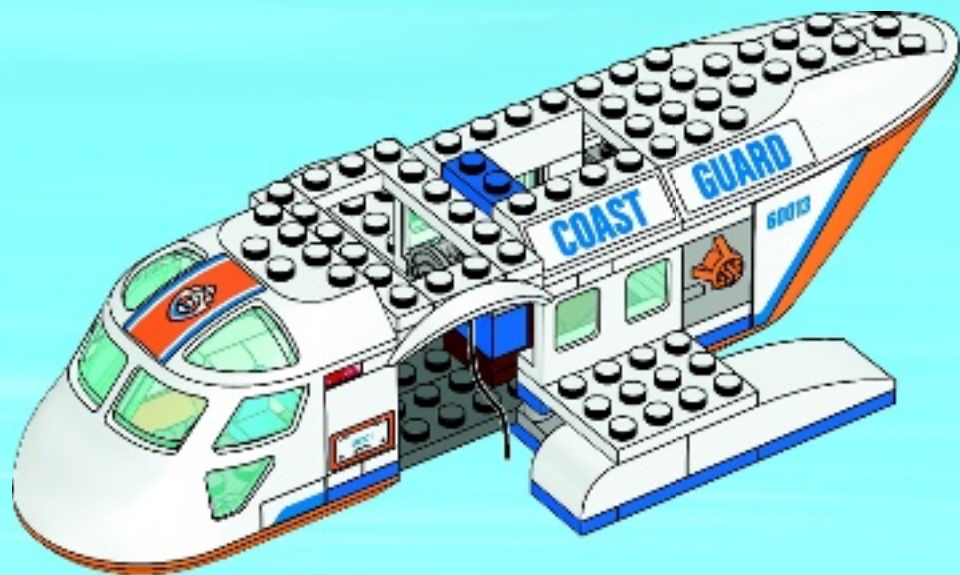



1x

26

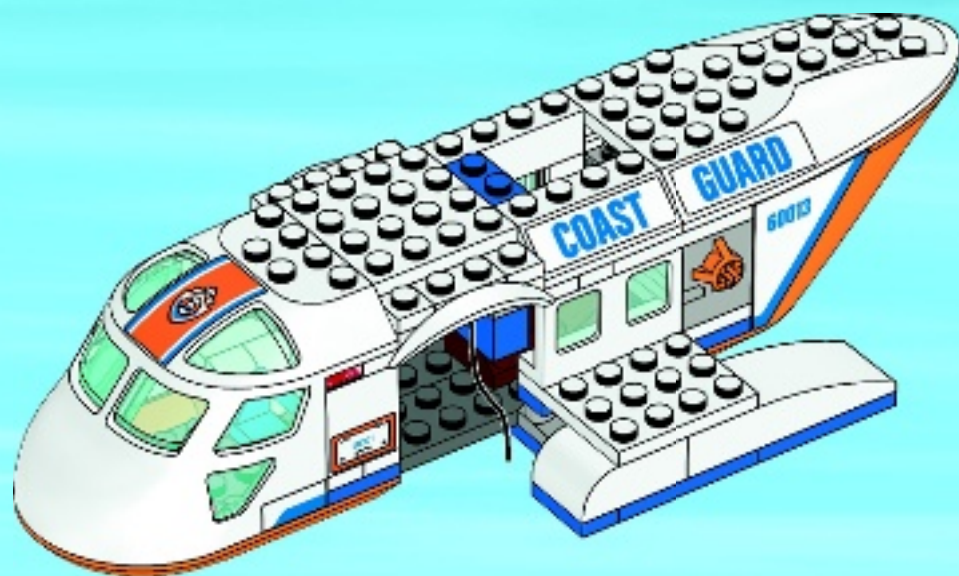



1x

27





1x



2x

28





2x

29

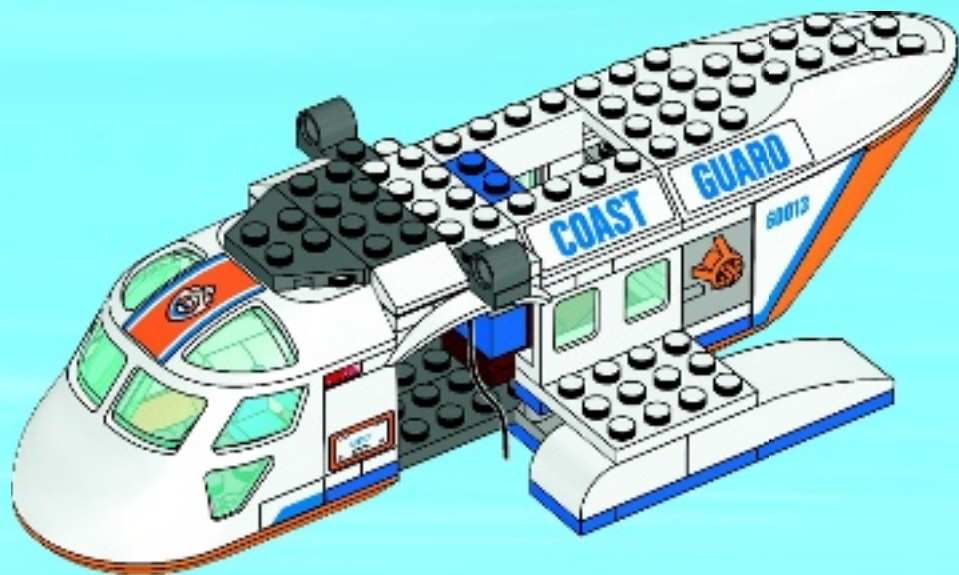



1x



2x

30





2x

31



2x

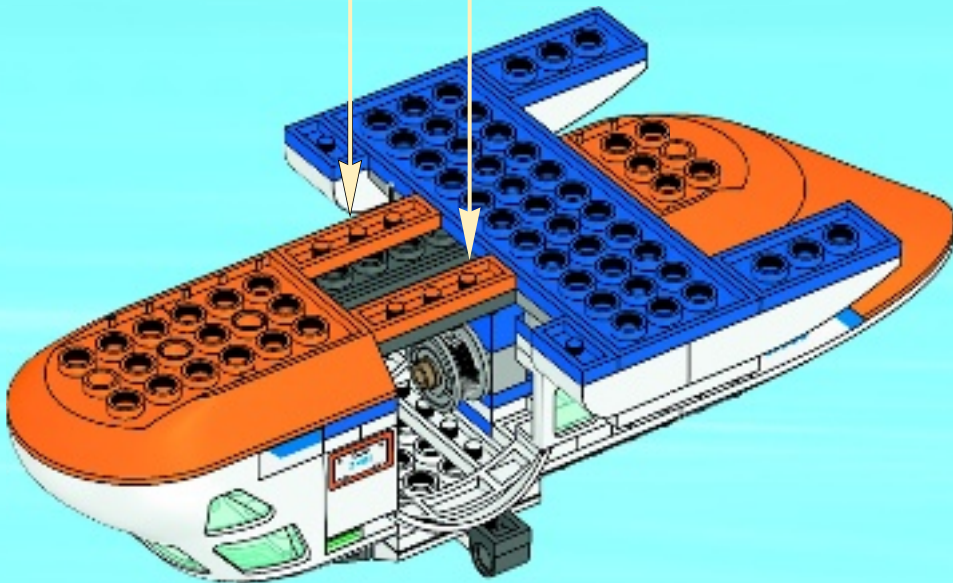

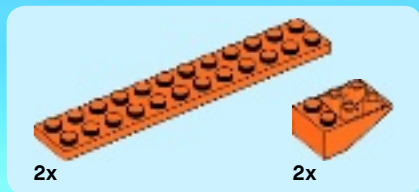

32

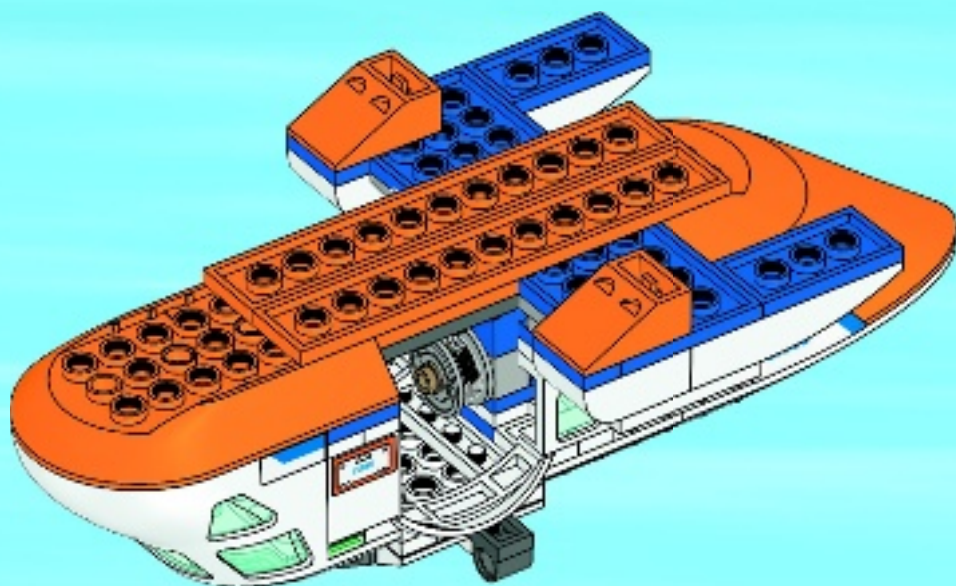



2x



2x

33

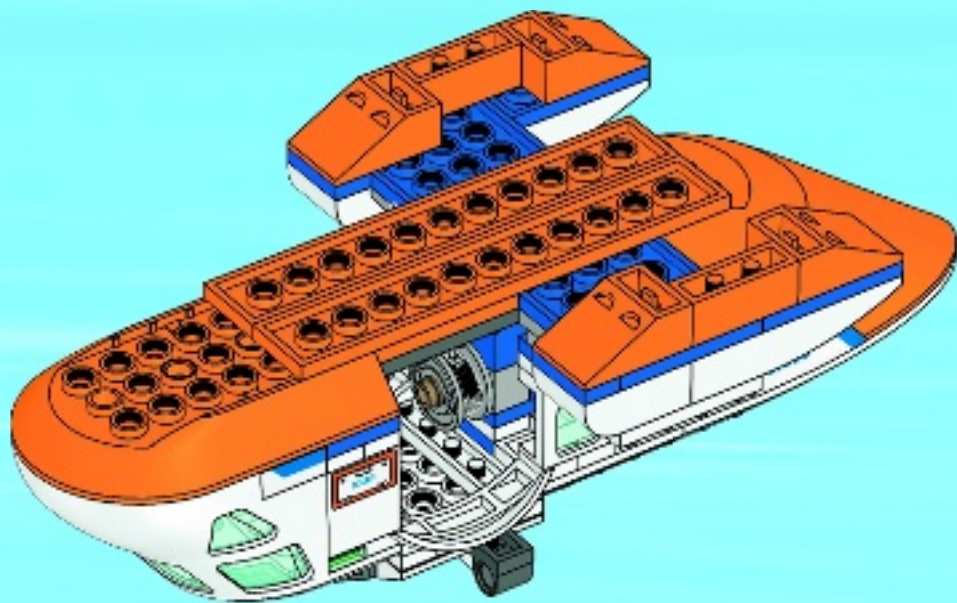



34

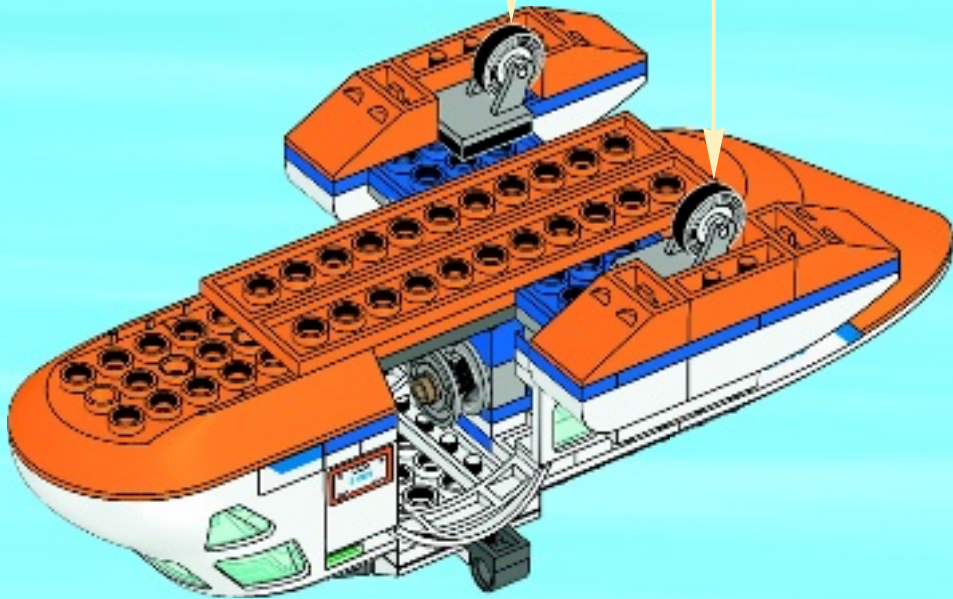
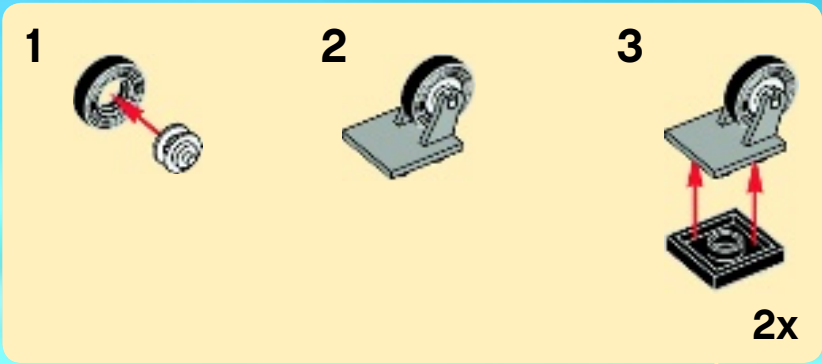



2x



1x



2x



1x

35

1



2



3



4

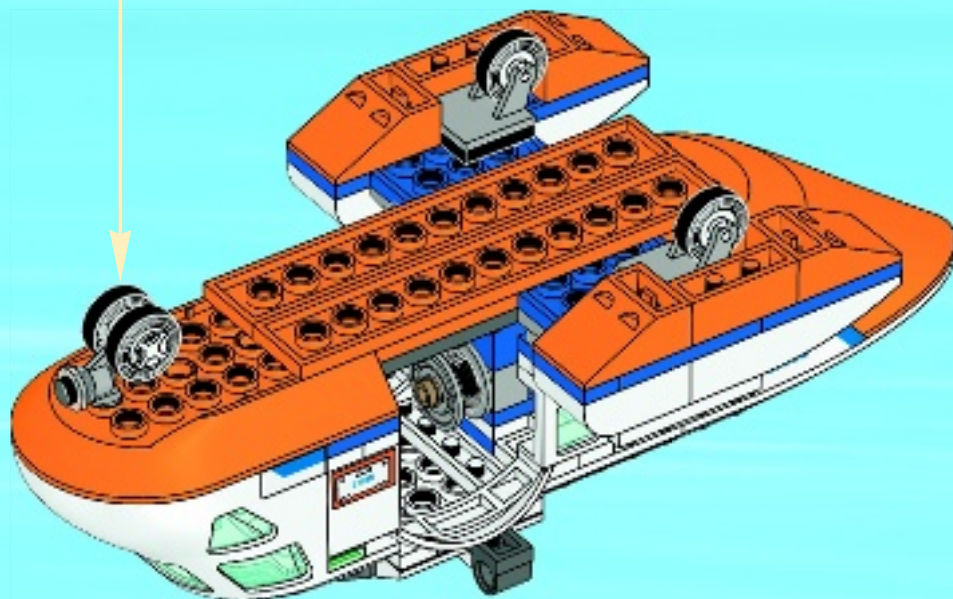



1x

36





2x

37





3x

38





1x



1x

39



1x



1x



40

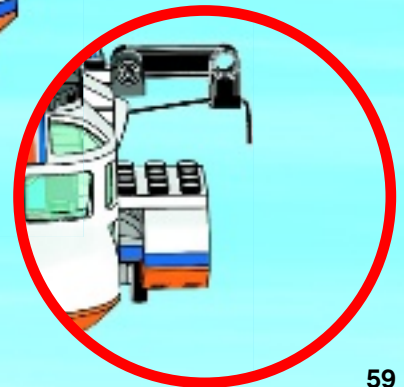
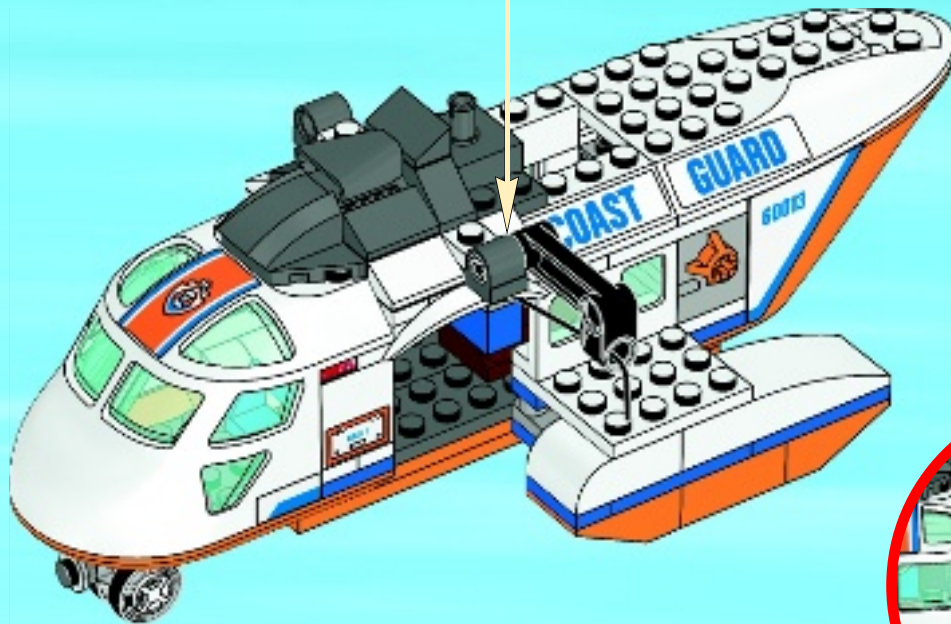
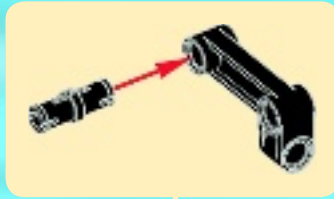



1x

41

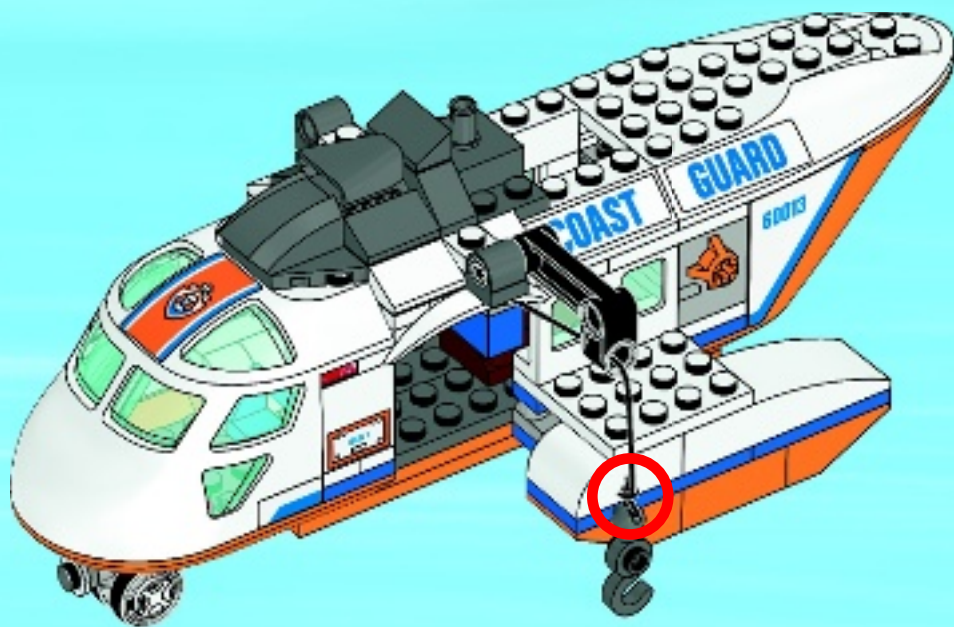

1

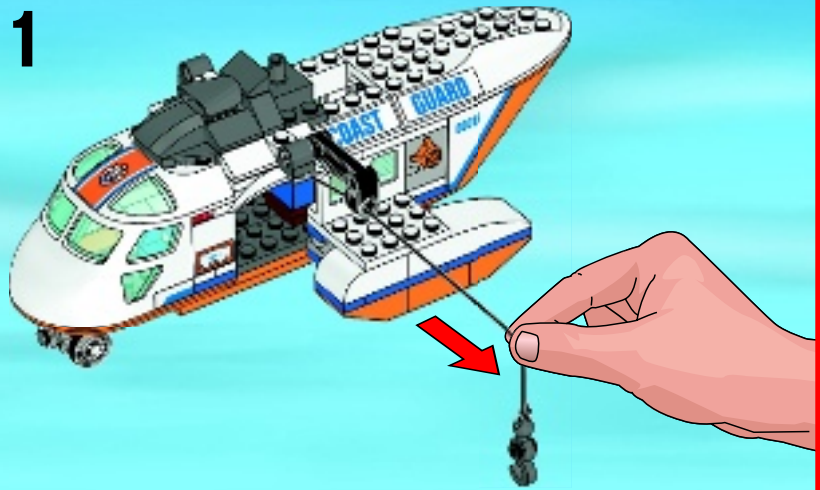

2

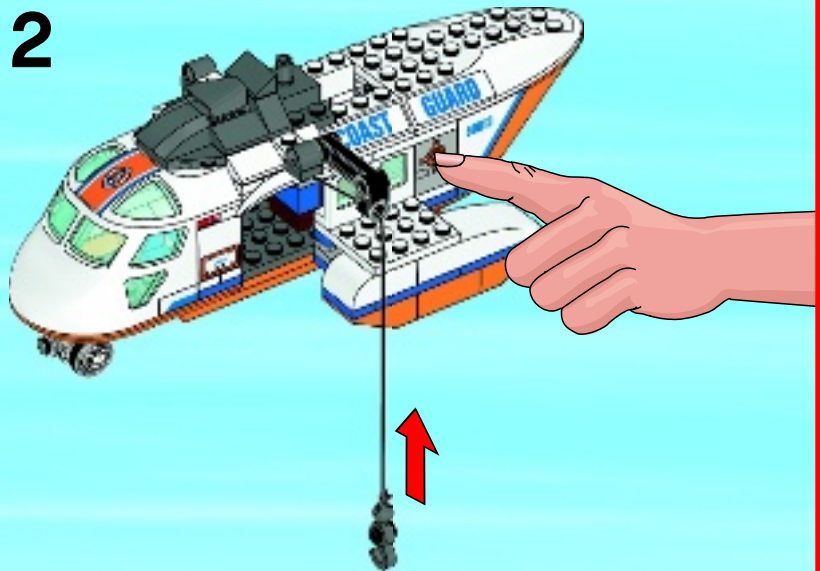



1x



1x

42

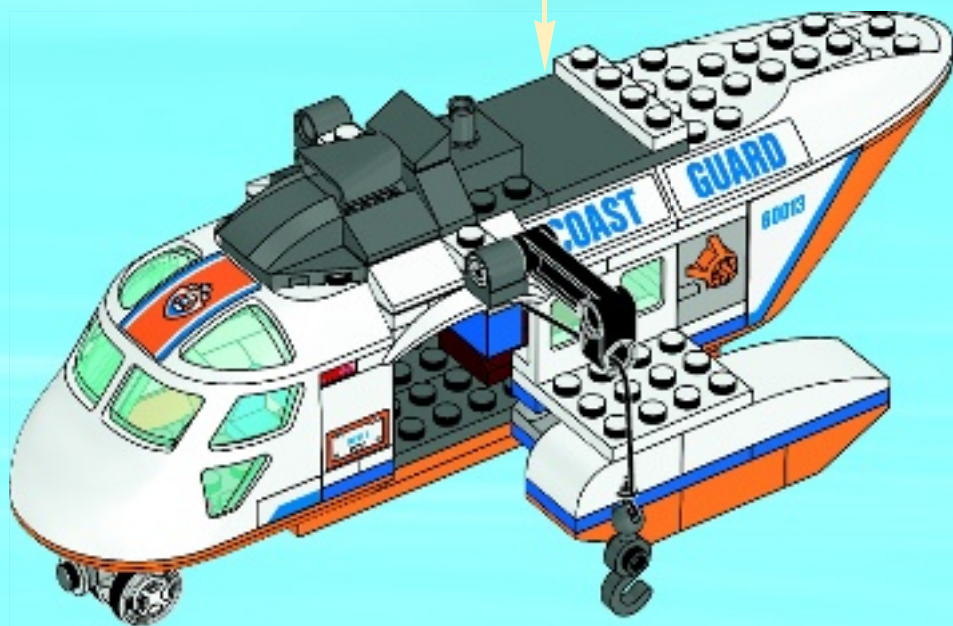



2x



2x



2x



2x



2x



1x



4x

43

1



2



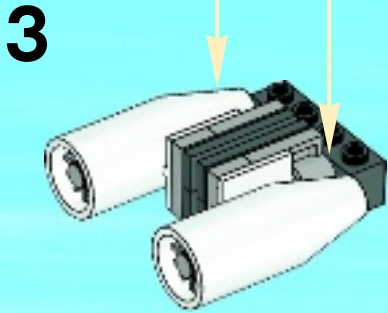
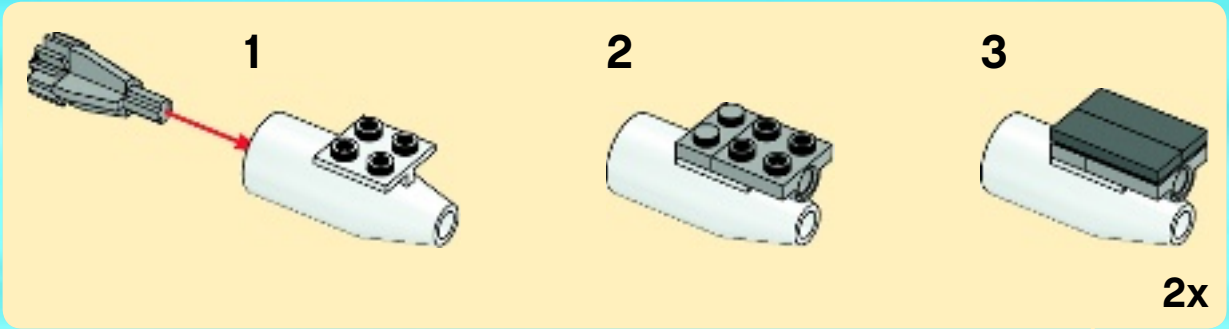

4

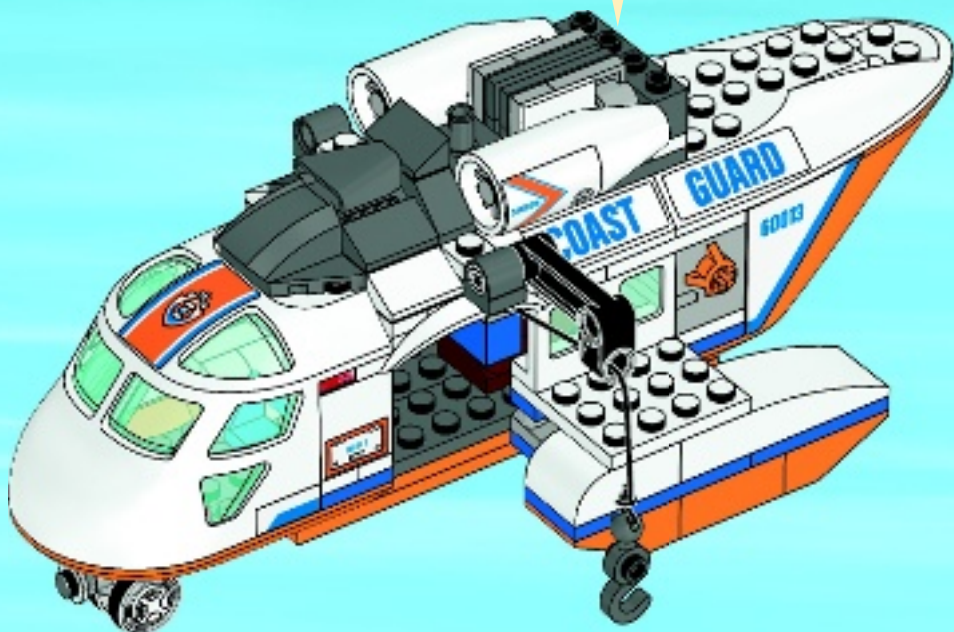
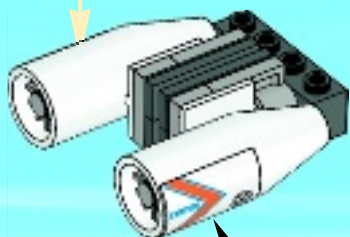



44



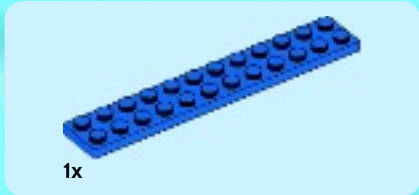

1

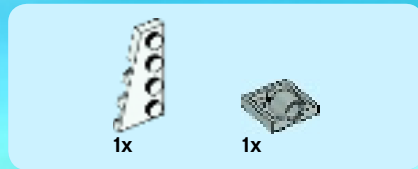
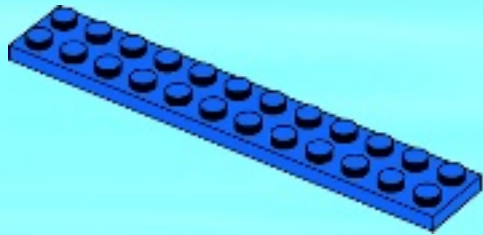

2

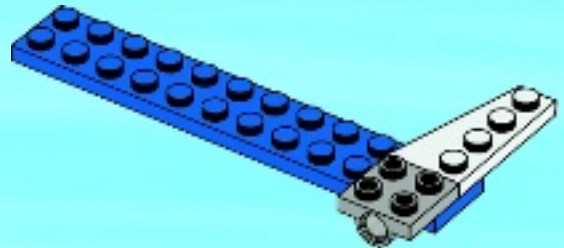

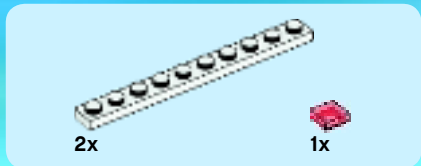

3

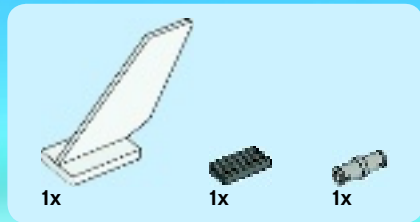
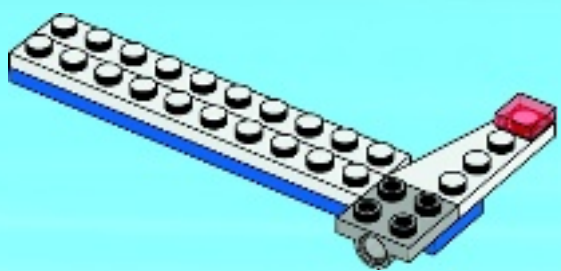

4

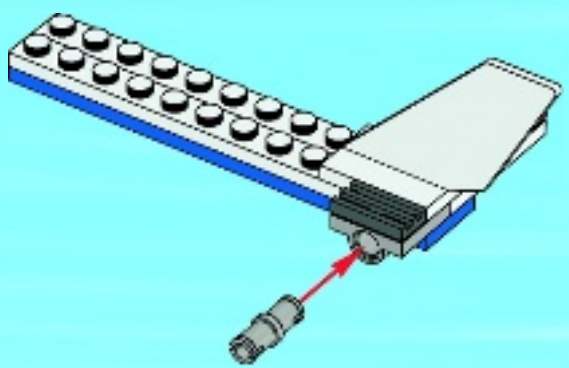

5

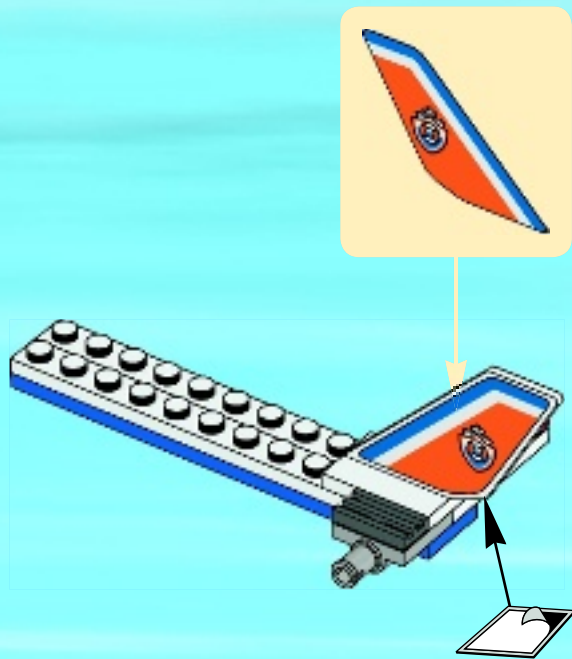

6

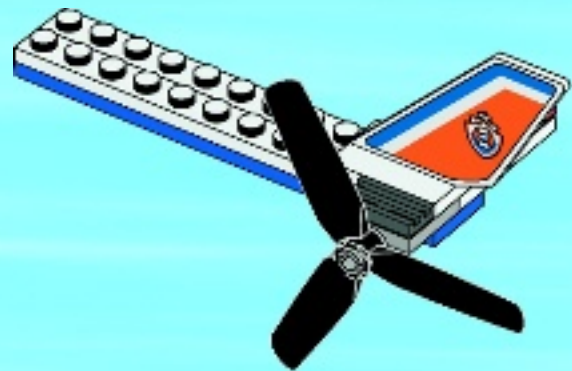

45

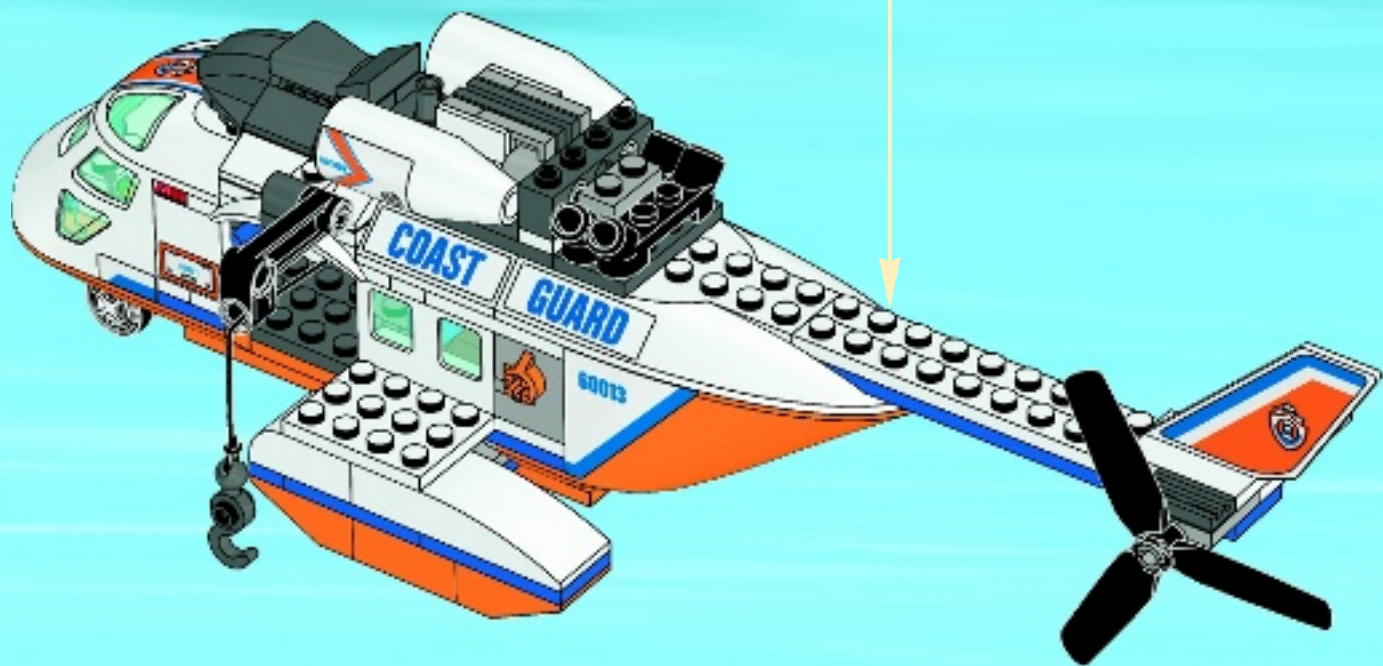



1x

46

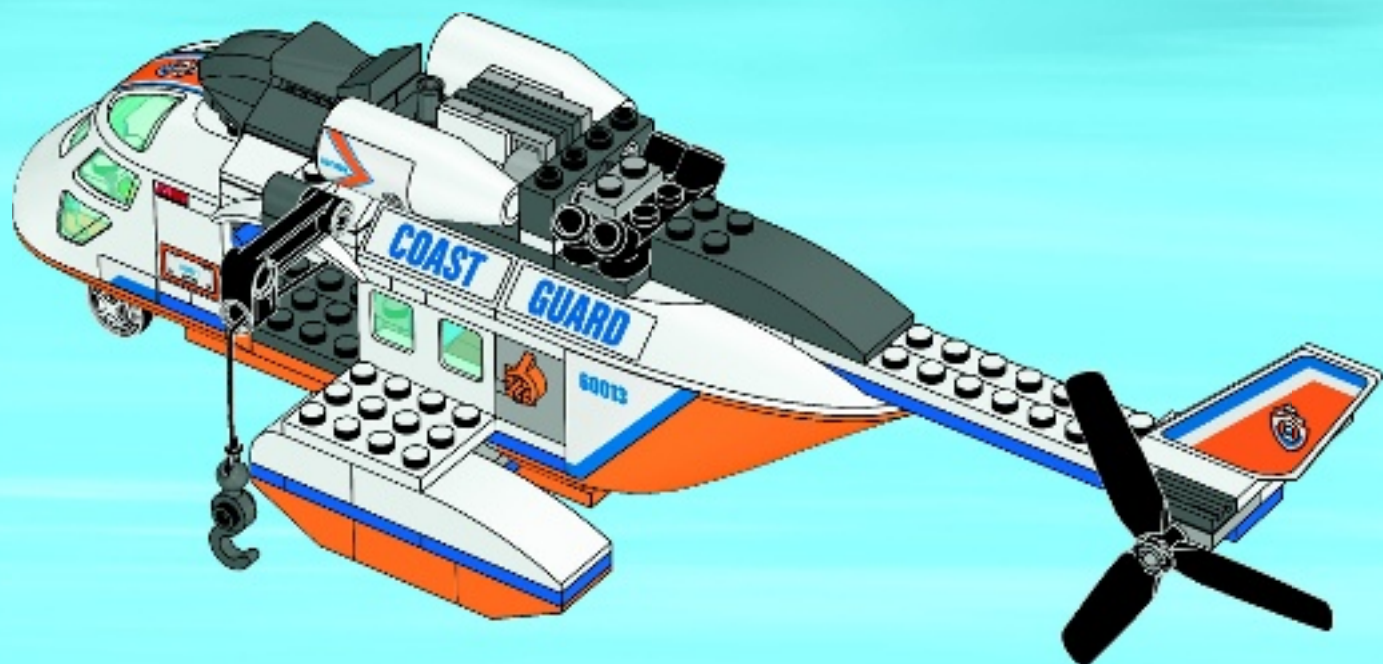



1x



1x

47

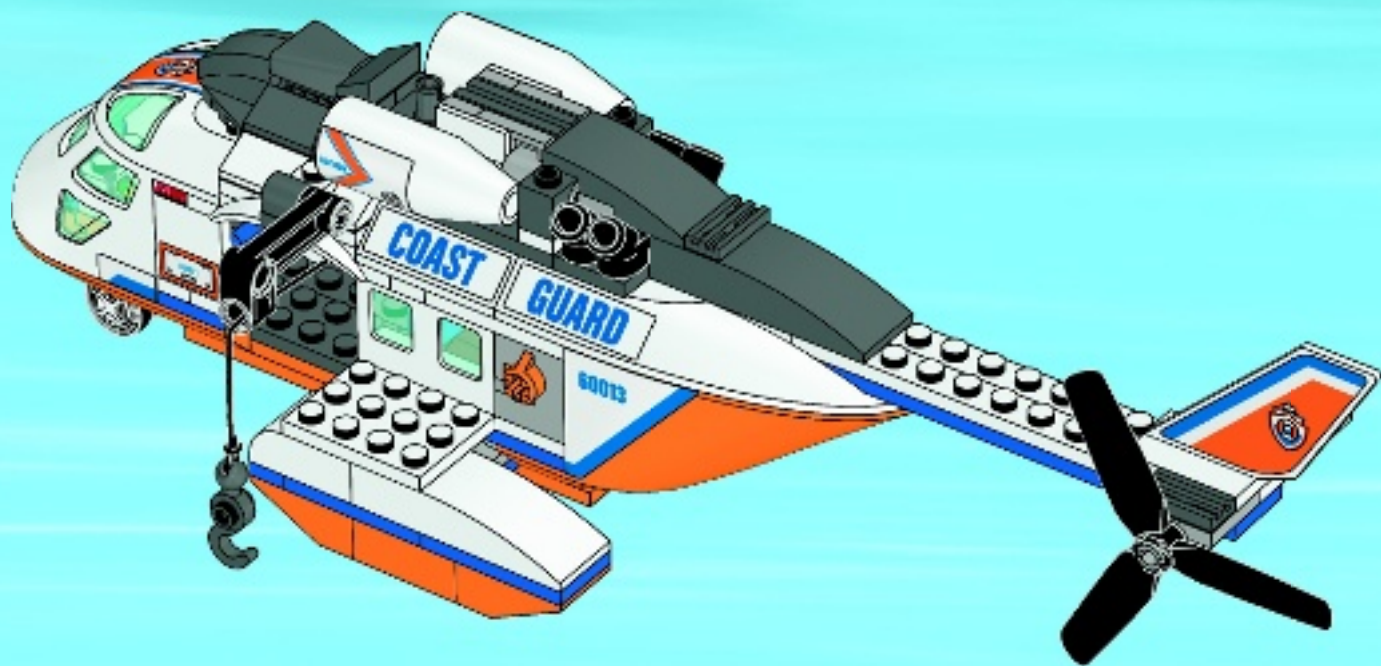



1x



1x

48

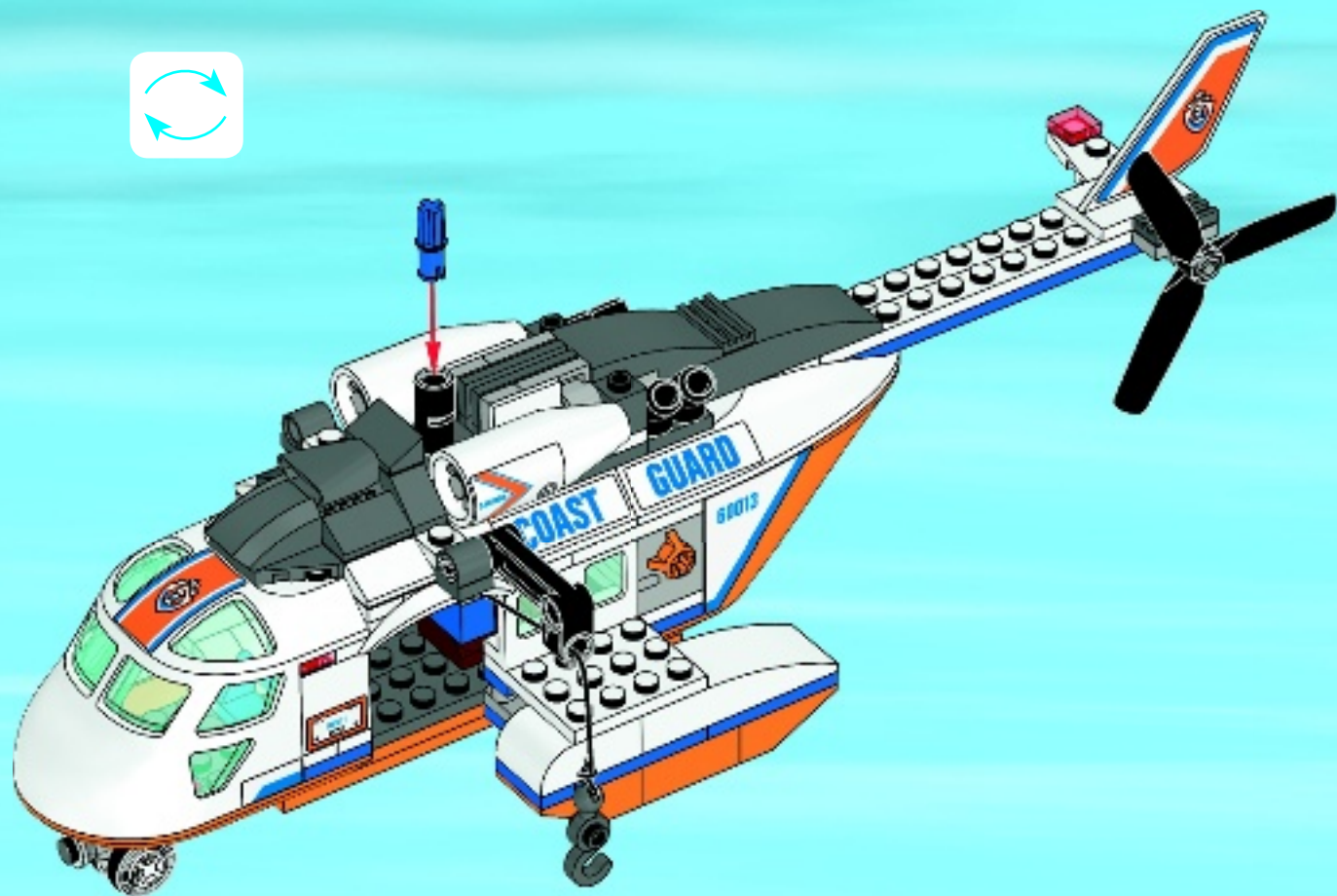

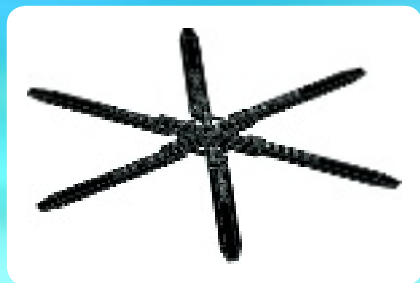

1



2





3

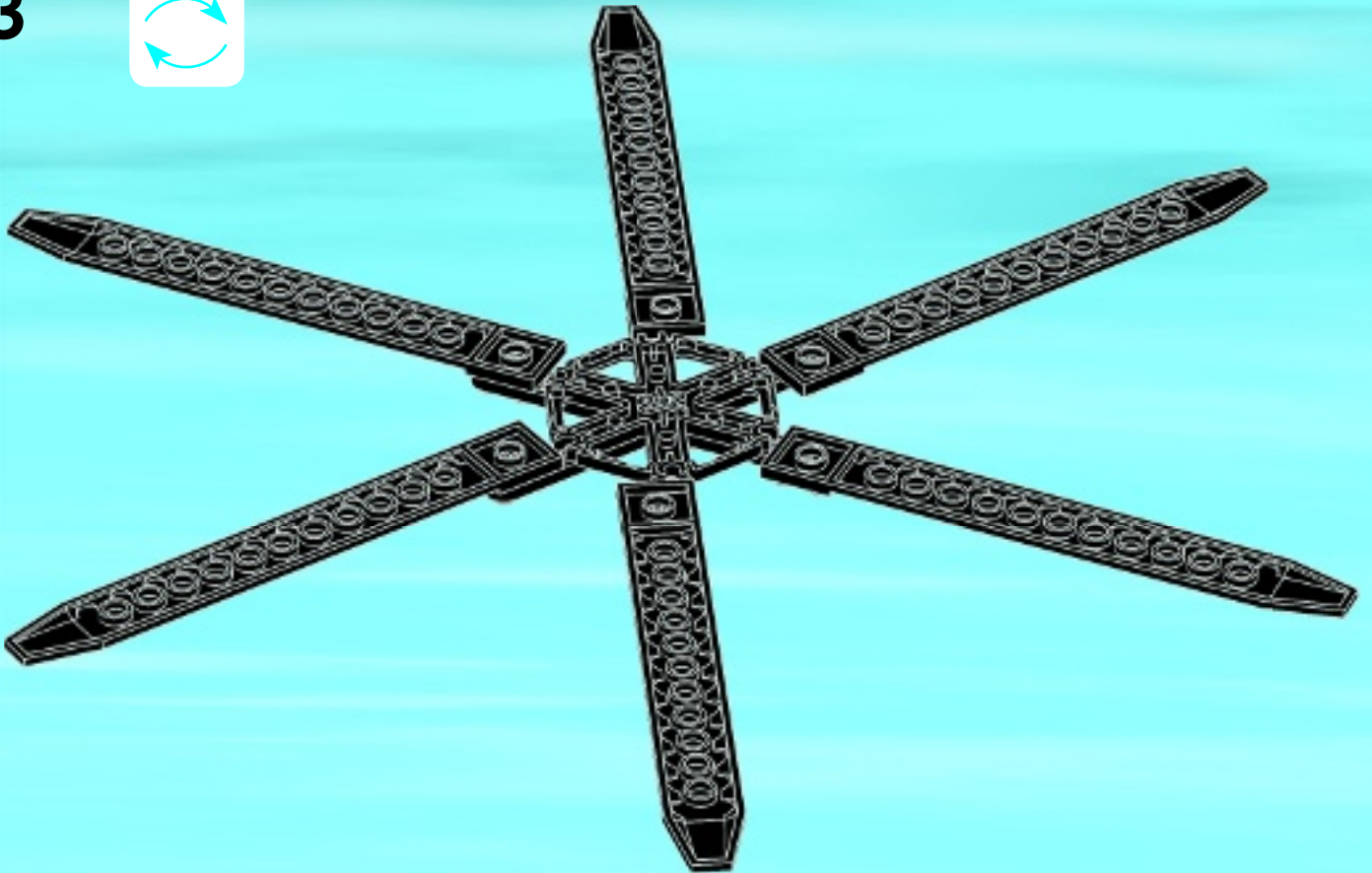



6x

4

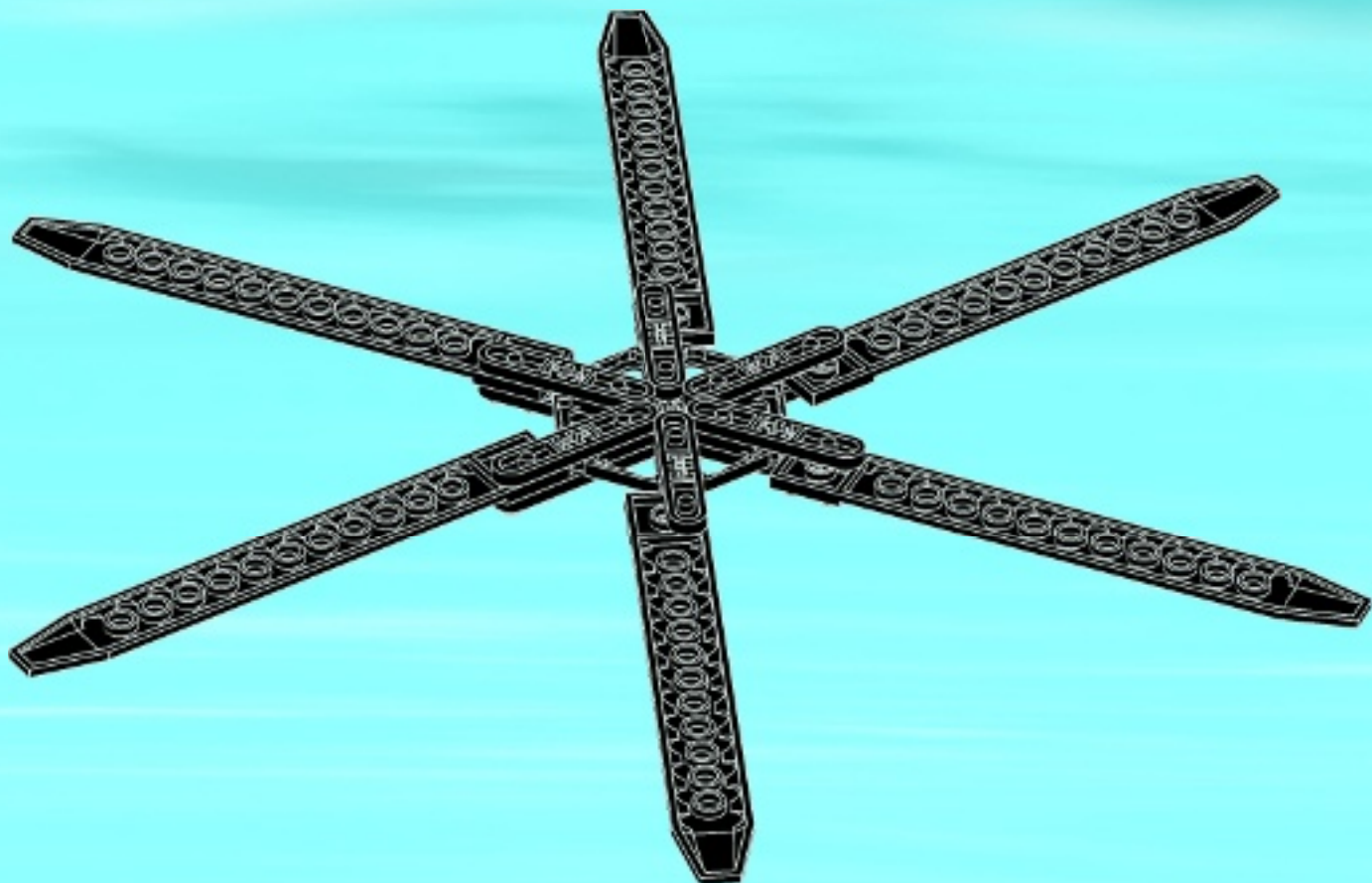

49







CITY



60014



60013



60012



60011

LEGO CITY



60004



60003



60002



60001



60000



Nintendo



CITY

UNDERCOVER





3x
4243812



2x
447701

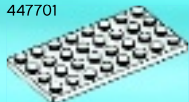

1x
303501



1x
6034346



1x
6034343



2x
4523556



2x
4654622



1x
623901



1x
6031892



1x
4560934

82



2x
462401



2x
4296997



2x
4504369



2x
4547489



1x
6032098



2x
303701



4x
609101



1x
4624989



2x
621501



2x
4160403



2x
4179870



3x
302301



4x
371001



8x
366601



1x
4161326



3x
4585458



2x
4521846



2x
4298609



2x
4520782



3x
379421



2x
366621



2x
307021



1x
243121



2x
74335



2x
6040342



1x
6031821



1x
4507833



1x
4609907



1x
4535553



2x
243223



1x
9341



1x
6032176



1x
4206482



2x
300423



5x
302323



1x
302223



2x
302023

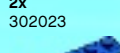

2x
366623



1x
244523



1x
4528850



1x
4528850



1x
4528850



1x
6036006



1x
9339



1x
6032681



1x
4184617



1x
4142731



1x
300126



2x
302226



12x
4114689



1x
4539442

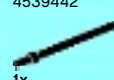

1x
4538722

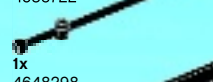

1x
4648298



6x
4527604

1x
396226

4x
4516843

2x
4516196

1x
4297719

1x
6019986

1x
4107783

3x
4121715

1x
4526982

2x
4214921

2x
6035126

1x
6031895

1x
6033418

1x
4587212

2x
6019987

3x
4567887

2x
4211135

1x
6005668

1x
4210873

2x
4211065

1x
4509911

2x
6000970

2x
6056707

2x
6024792

2x
4118787

4x
4121737

2x
4118782

2x
4210631

1x
4611703

4x
4568734

1x
4527082

1x
4500608

1x
4502068

1x
4212529

1x
4210931

1x
4239373

1x
4213607

1x
6031893

4x
6023948

1x
4499885

1x
4211807

3x
4211359

1x
4261605

1x
4211525

1x
4211440

1x
6031891

2x
4211351

2x
4211825

1x
4519013

4x
4494475

1x
4521532

1x
6030500

3x
4211398

2x
4219913

1x
4556157

1x
4651442

1x
4651441

1x
6021844

1x
4215503

2x
4648281

1x
4163306

1x
4216384

2x
3003941

1x
3005740

Customer Service
Kundenservice
Service Consommateurs
Servicio Al Consumidor

LEGO.com/service or dial

🇪🇸 🇩🇪 🇫🇷 🇮🇹 🇯🇵 🇰🇷 🇸🇪 🇸🇯 🇺🇰 🇻🇪
: 00800 5346 5555
: 1-800-422-5346

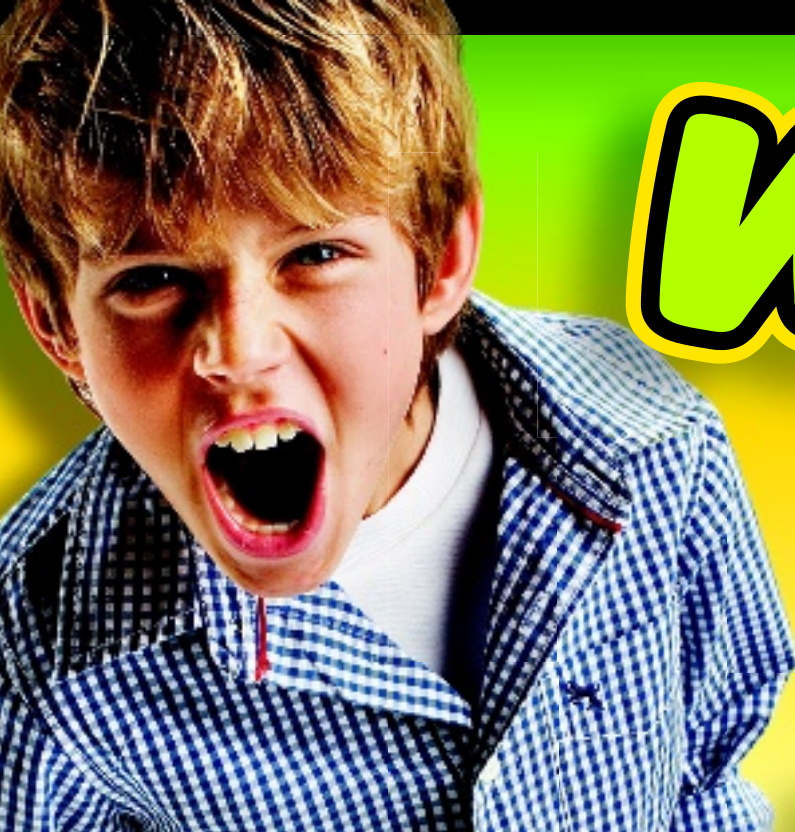

WIN!

Go to www.LEGOsurvey.com/product
to fill out a survey for a chance
to win a cool LEGO® Product.

No purchase necessary.

Open to all residents where not prohibited.



LEGO.com



www.LEGOsurvey.com/product

GEWINNE! WIN!

Nimm an der Umfrage auf
www.LEGOsurvey.com/product
teil und hab die Chance ein cooles
LEGO® Produkt zu gewinnen!

Die Teilnahme am Gewinnspiel führt zu keinerlei
Kaufverpflichtungen. Teilnahme in allen nicht
ausgeschlossenen Ländern möglich.

Ga naar www.LEGOsurvey.com/product,
vul een
enquêteformulier in en maak
kans op een cool LEGO® product.

Geen aankoopverplichting.
Iedereen mag deelnemen, uitgezonderd
ingezetenden van landen waar een
enquêteverbod geldt.

GAGNE! 当てよう!

Visite www.LEGOsurvey.com/product
pour répondre à un
questionnaire et avoir une chance de
gagner un produit LEGO® très cool!

Aucune obligation d'achat.
Ouvert à tous les résidents des pays
autorisés.

www.LEGOsurvey.com/product にアクセスして、
アンケートにご記入ください。当選者にはレゴ
製品を差し上げます。

お買い上げの必要はありません

禁止されていない限り、すべての皆様にご利用いただけます。