

LEGO[®]

TECHNIC

42002



1



2



3



4



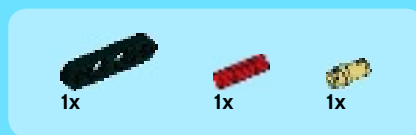
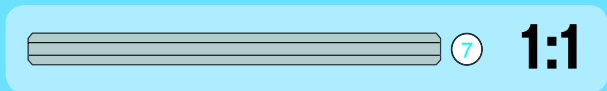
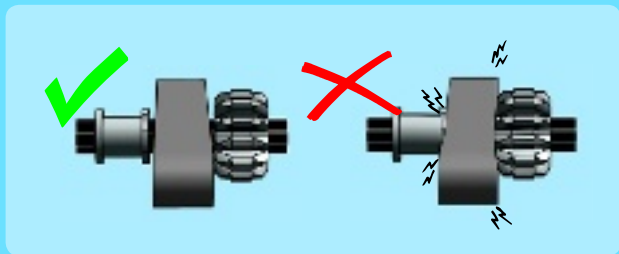

1

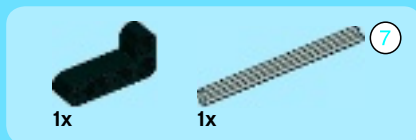

2

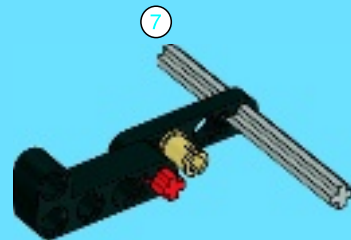



1x



1x

3



4

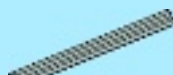

1x

7



2x

4



7

1:1



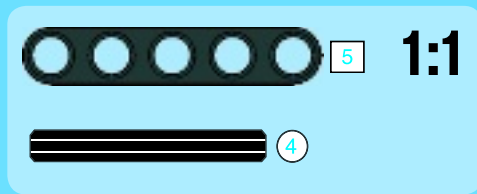
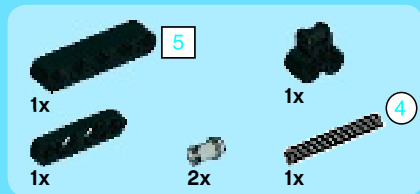

5

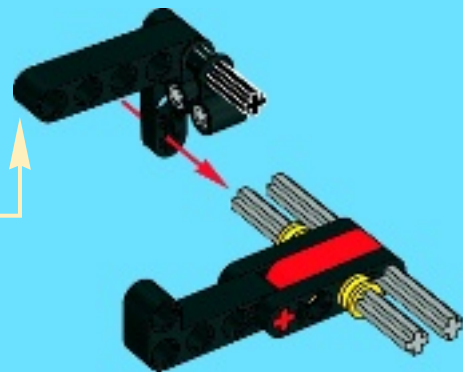
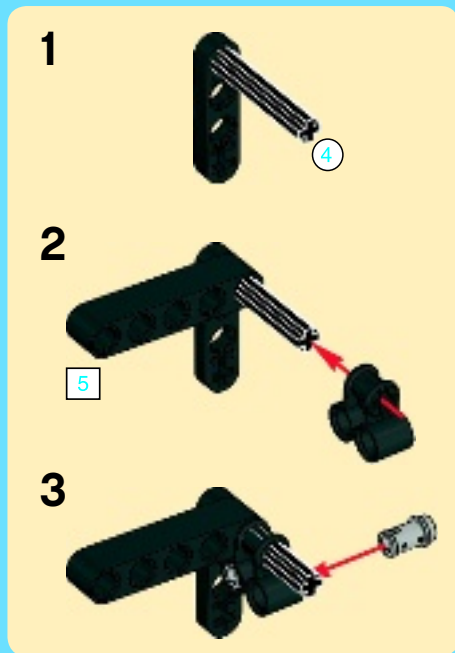



2x

6

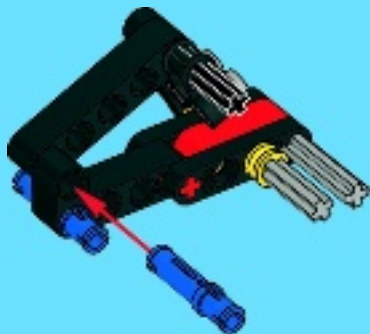

6



1x

5



1x

7

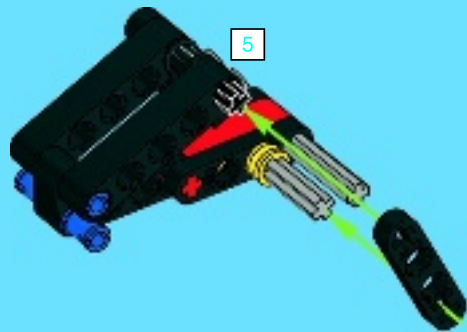

5

1:1



2x

8

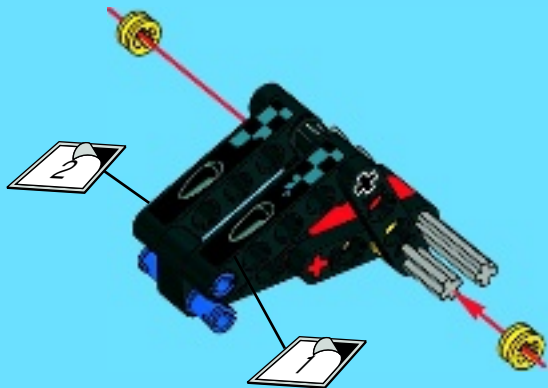

1x

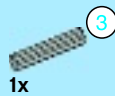

1x



1x

9

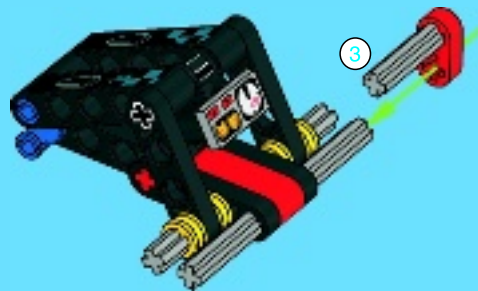

3

1:1



1x

10



8



1x



2x



1x

11

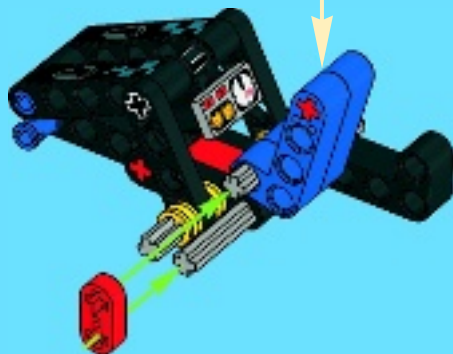
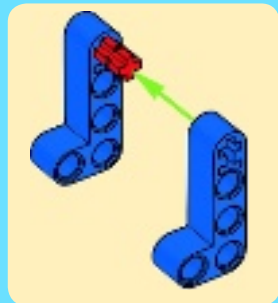



12

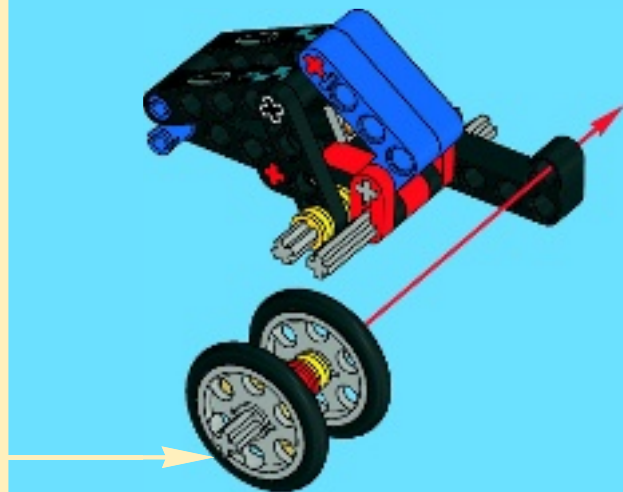
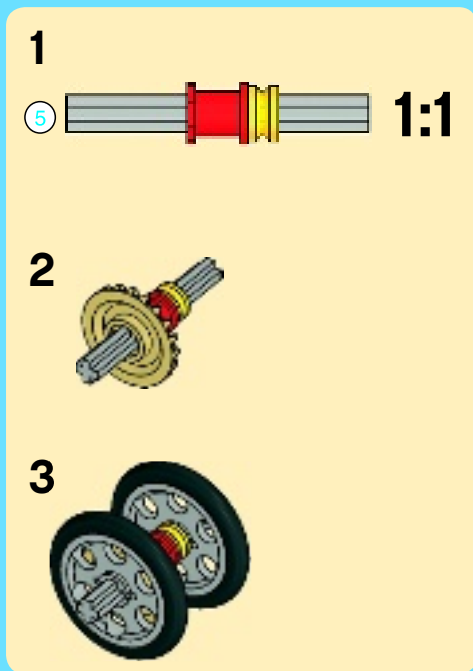



1x

13





1

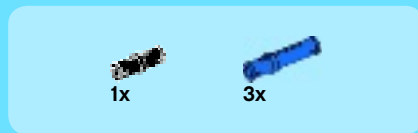
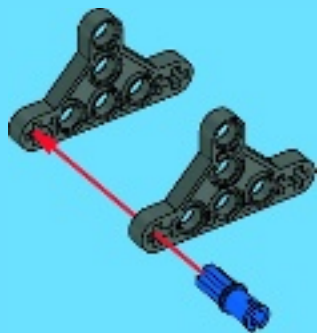

2





2x

3

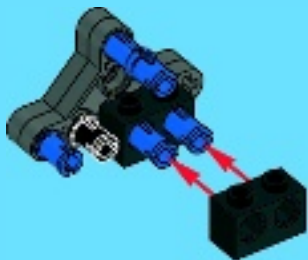

1x



1x

3

4

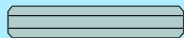
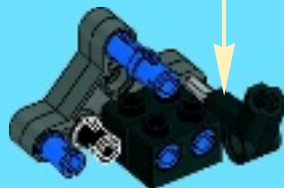
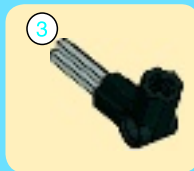

3

1:1

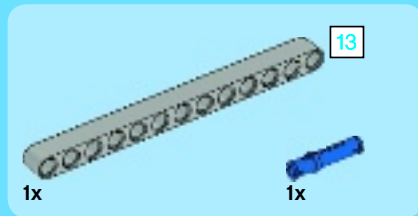

5

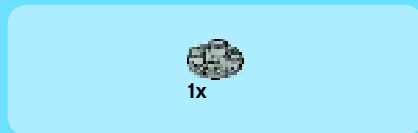
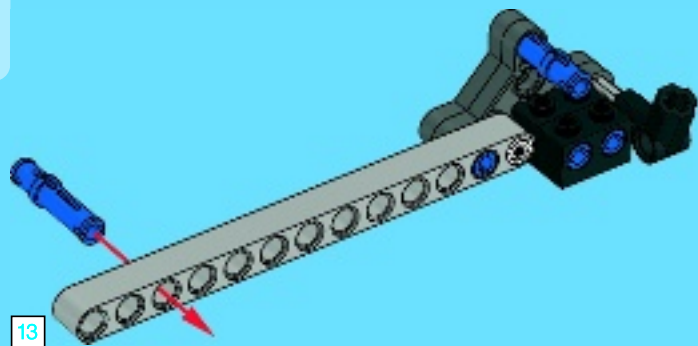

6

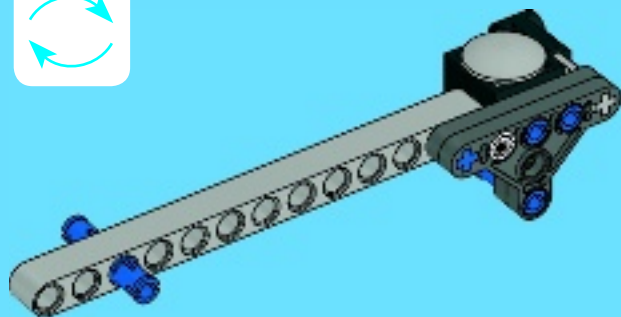



7

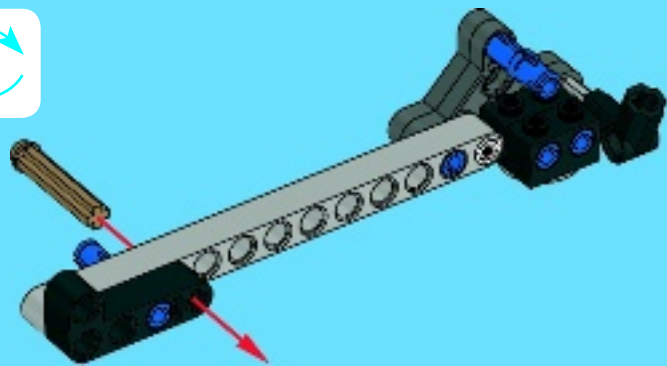

14

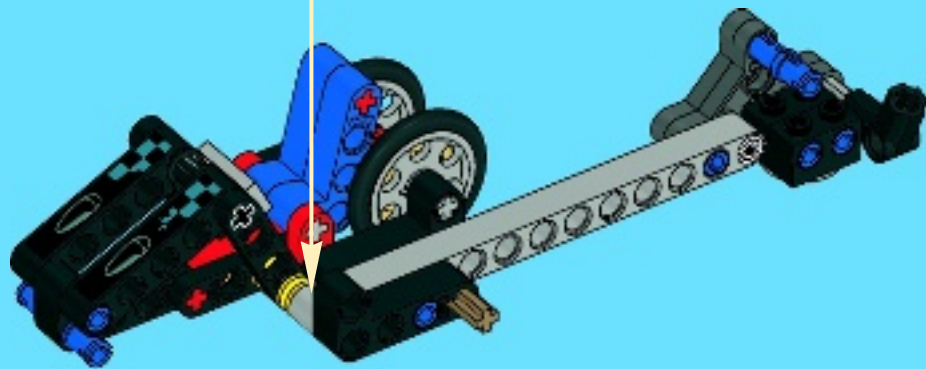



1

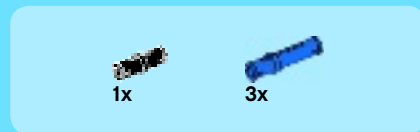
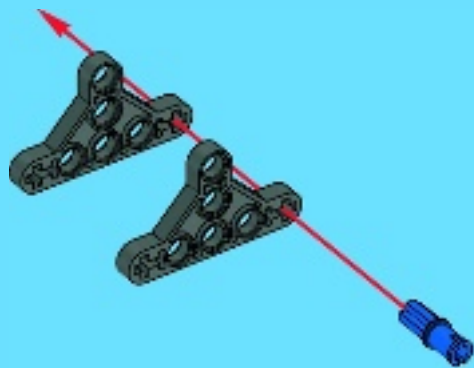

2





2x

3



1x



1x

3

4

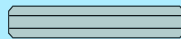
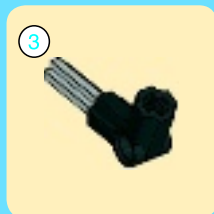

3

1:1

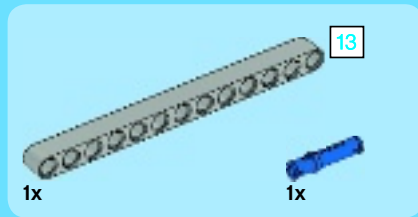

5

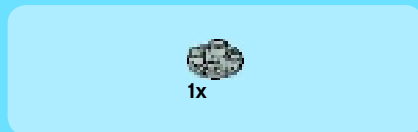
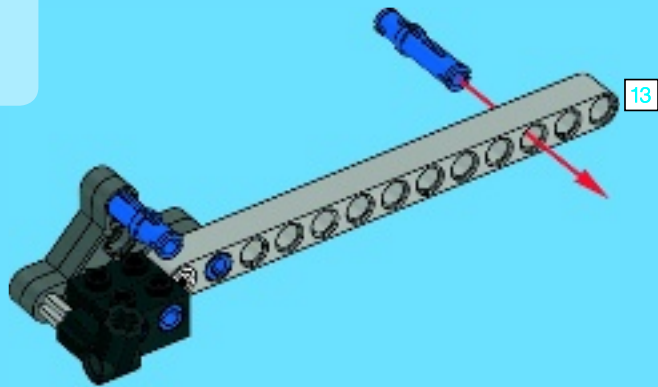

6

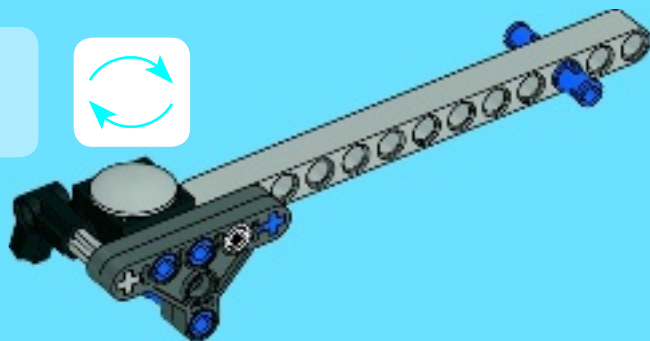



7

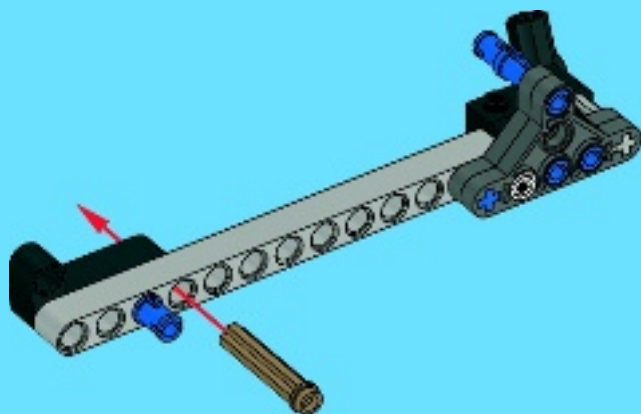

15



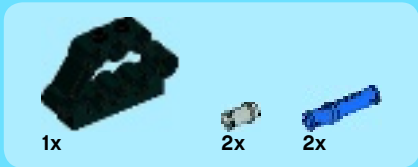

1



2

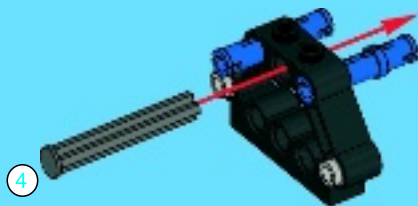



1x

3

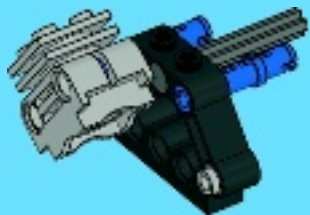

2x



2x



2x

4



1

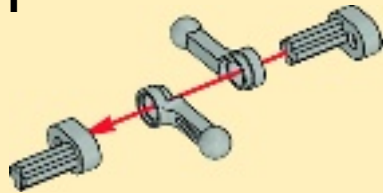

2

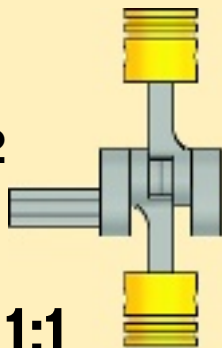

1:1

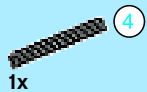

5

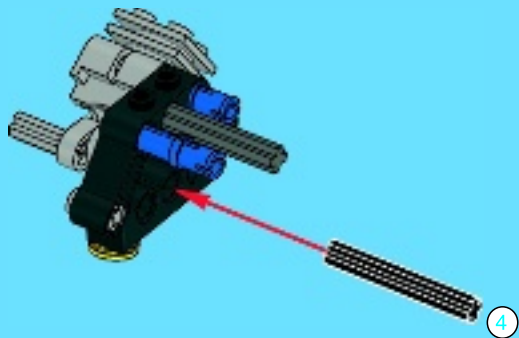

1:1



6

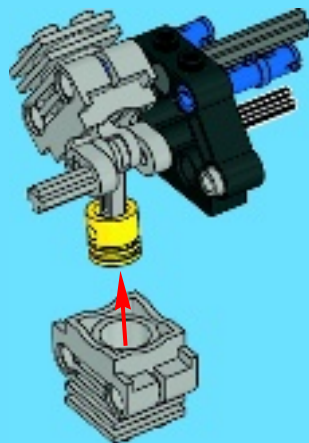



2x

7

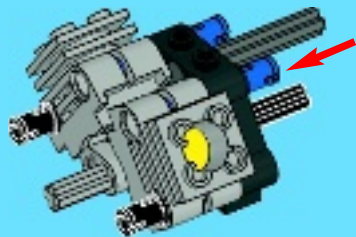

1x

8





1x



2x

9

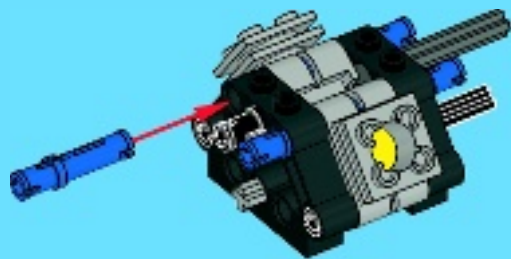

2x



1x

10

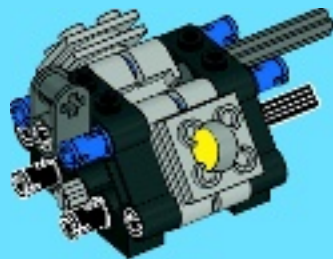

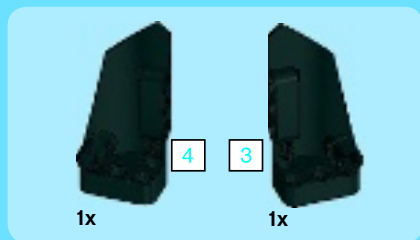

11





1x



1x

12

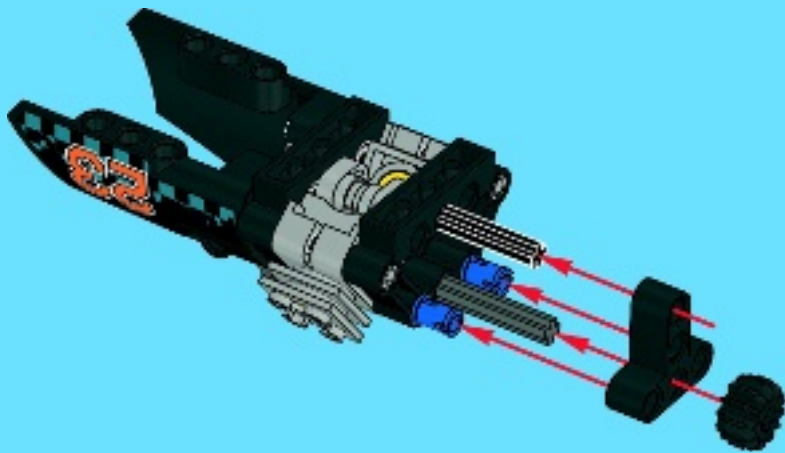



2x

13

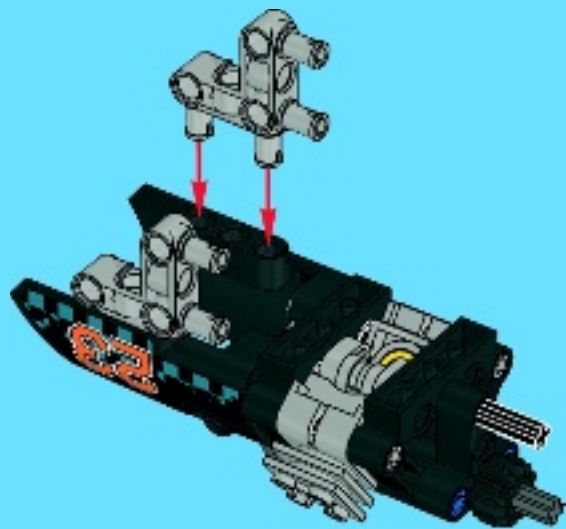

4x

14

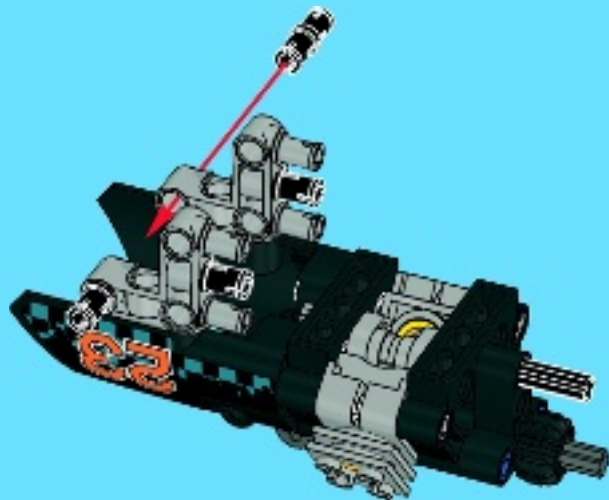

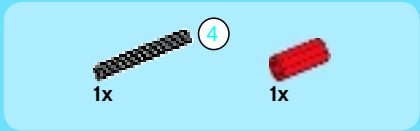

1

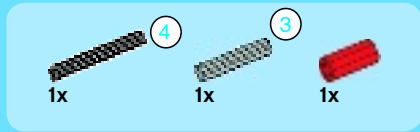
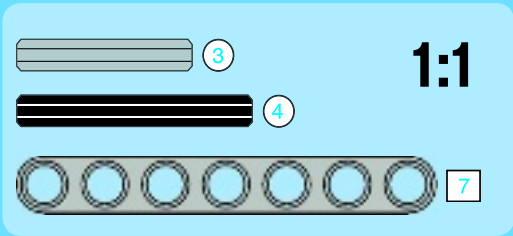
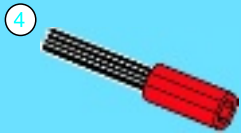

2

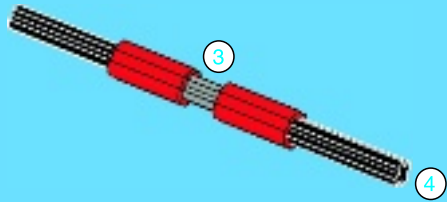

3

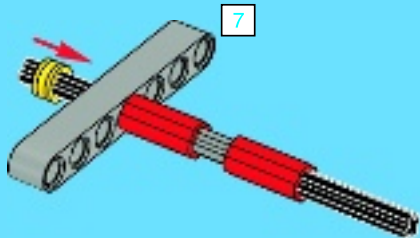



1x

4

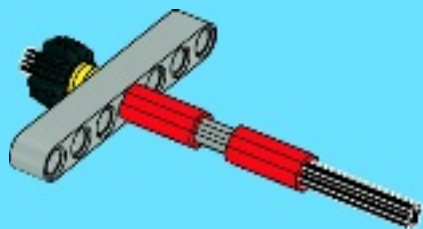

15

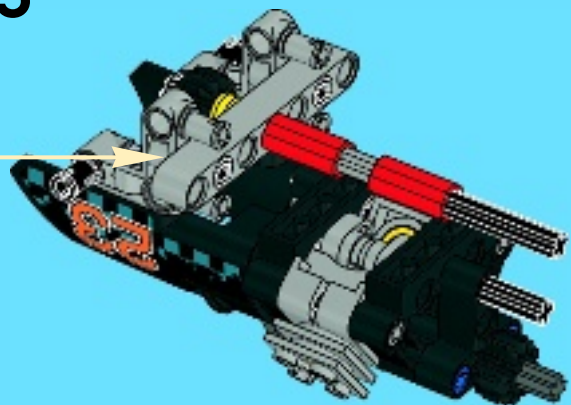

1x



1x



2x



1x



16

1

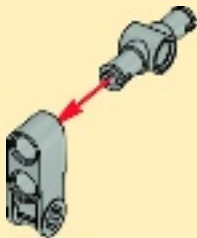

2



3

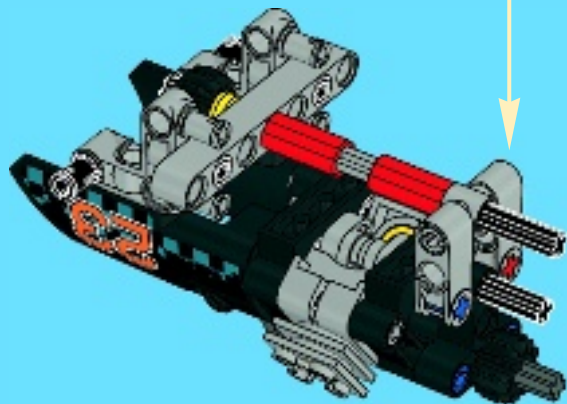
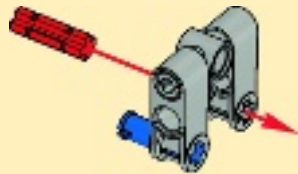



17

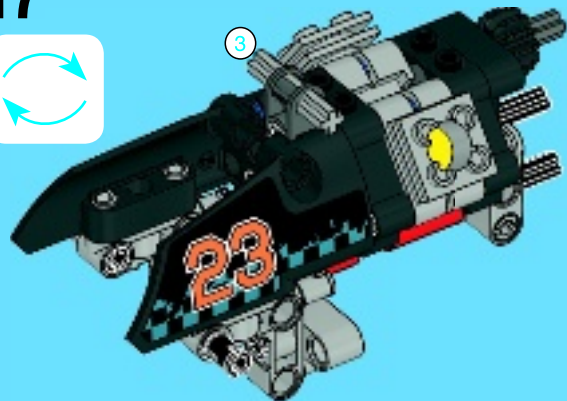

16

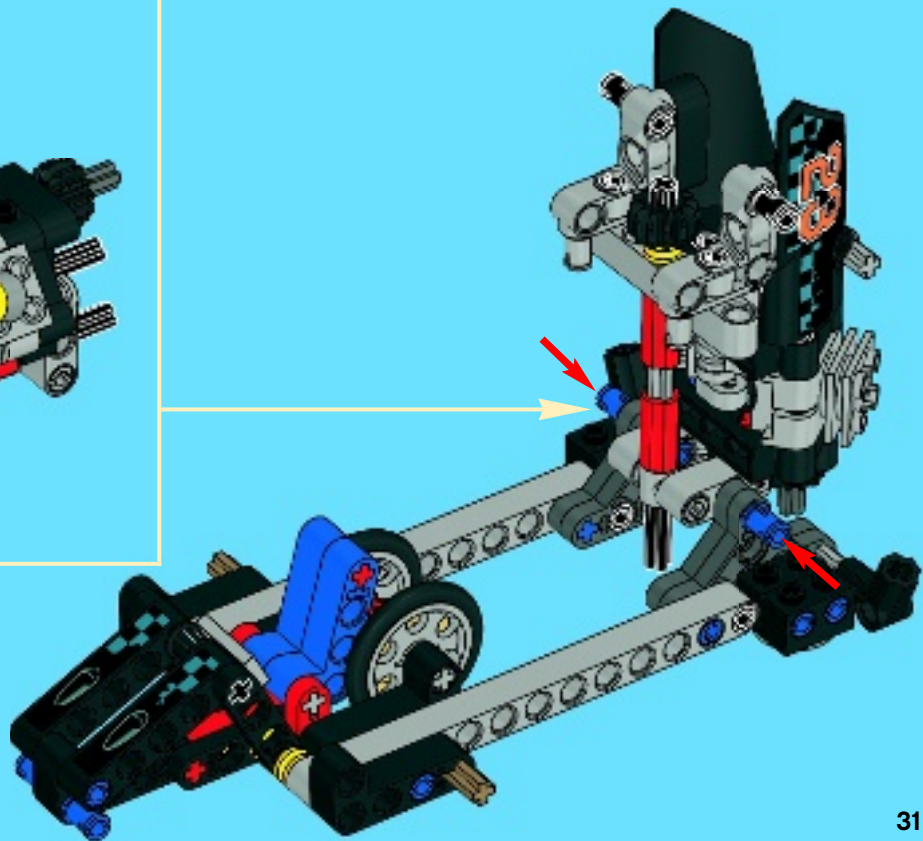
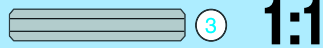



2x

17

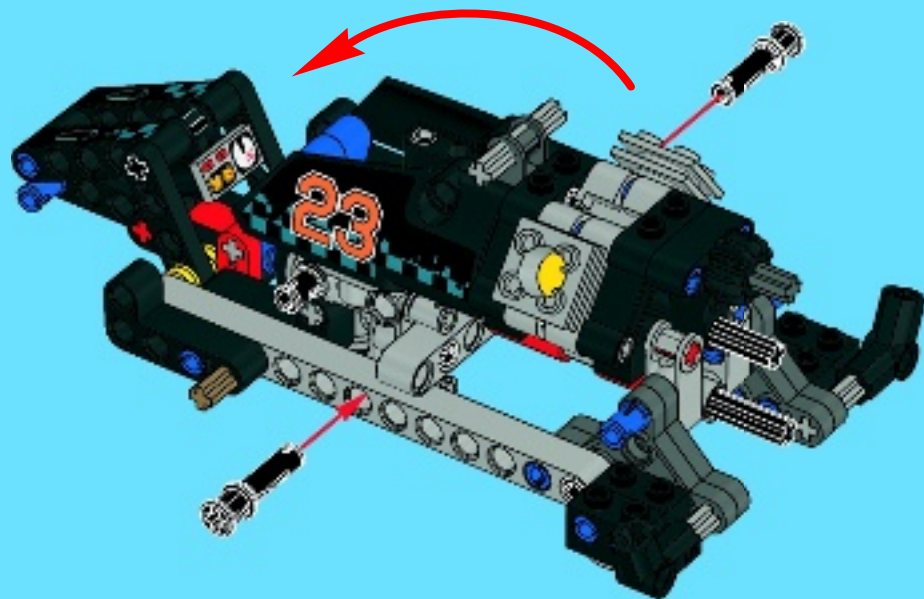



1x



1x



1x

18

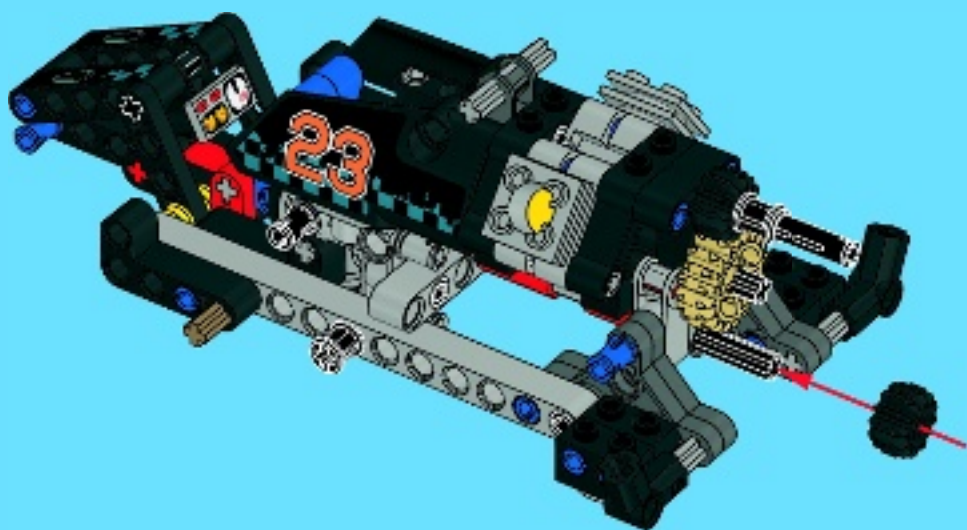



2x



1x



1x

19

1

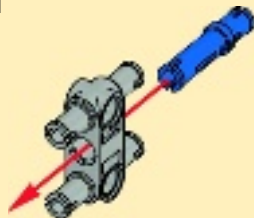

2

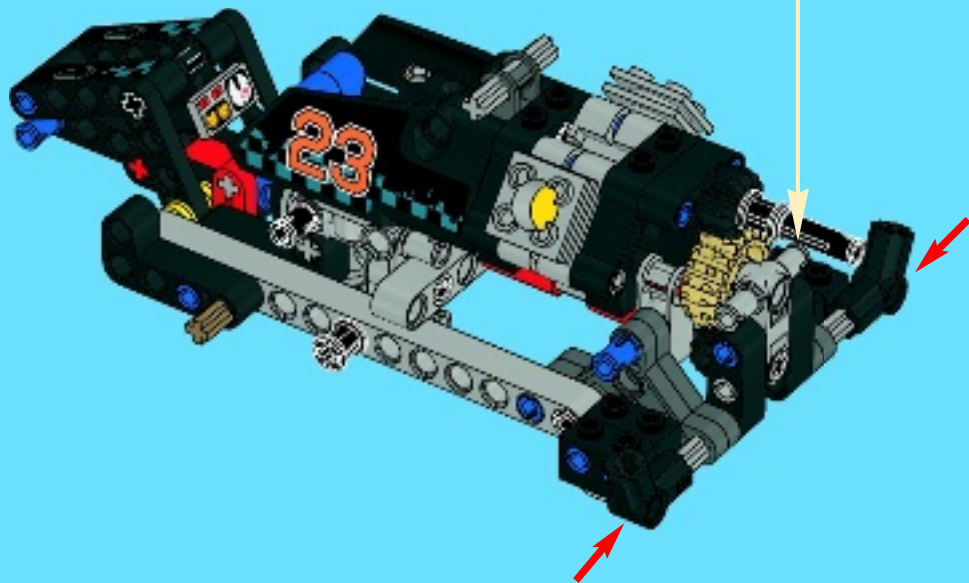



2x



4x



2x

20

1



2



1



2

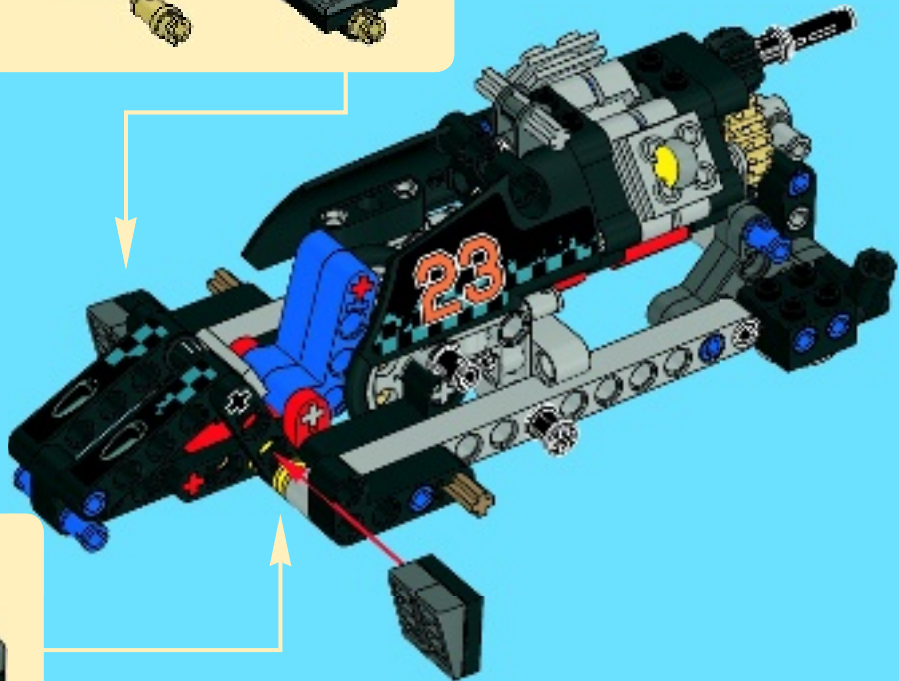

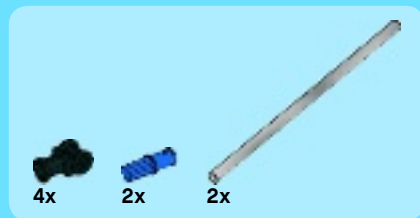

21

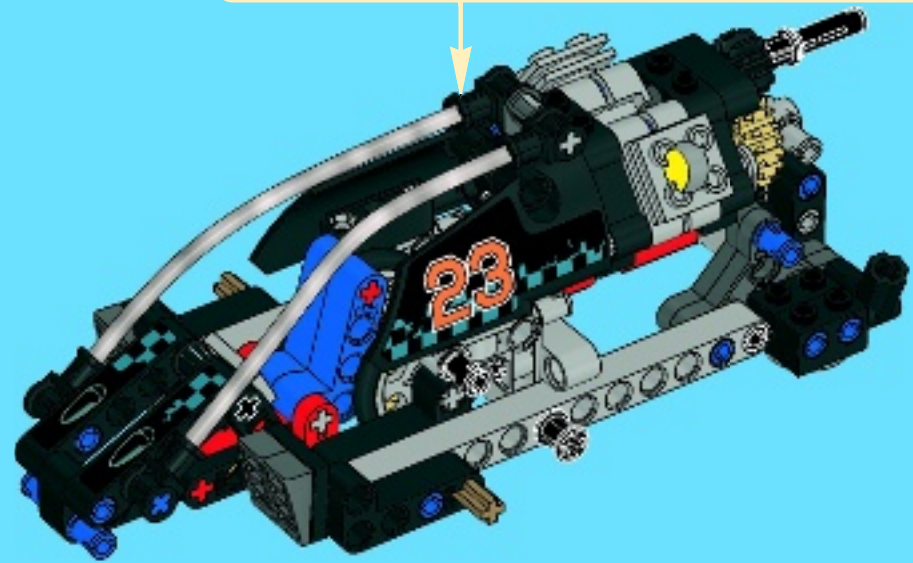



22

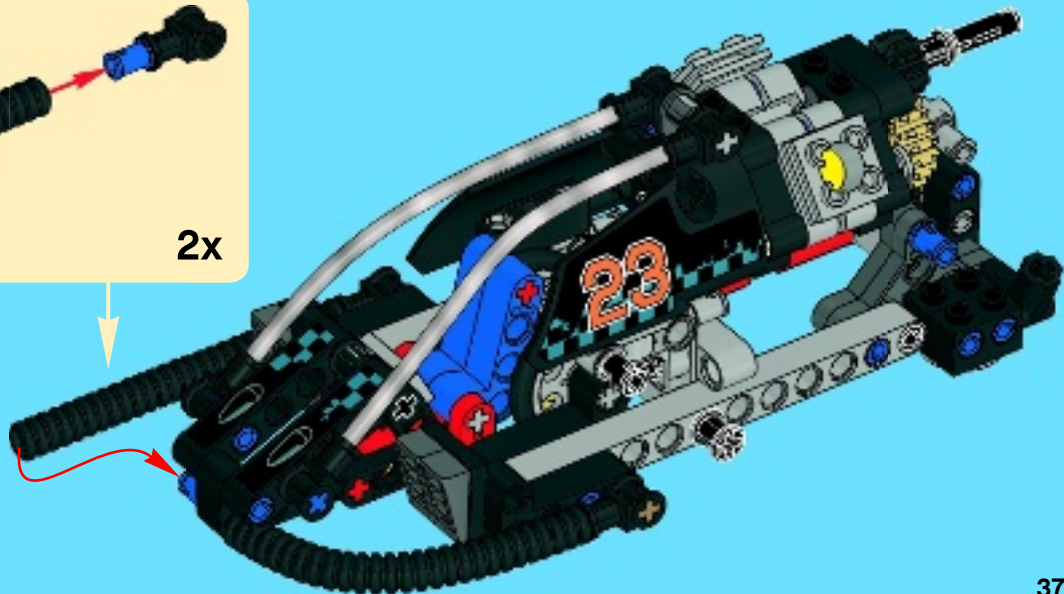
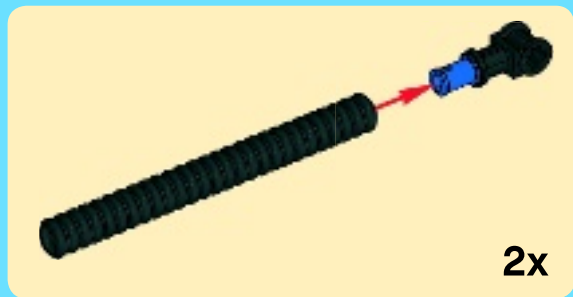



1

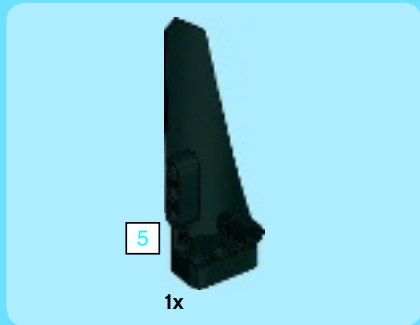
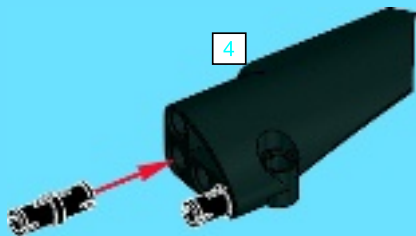

2



3

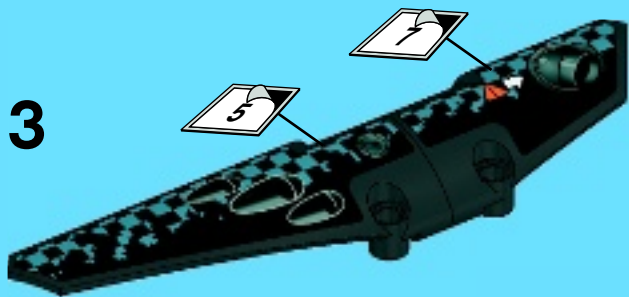

23

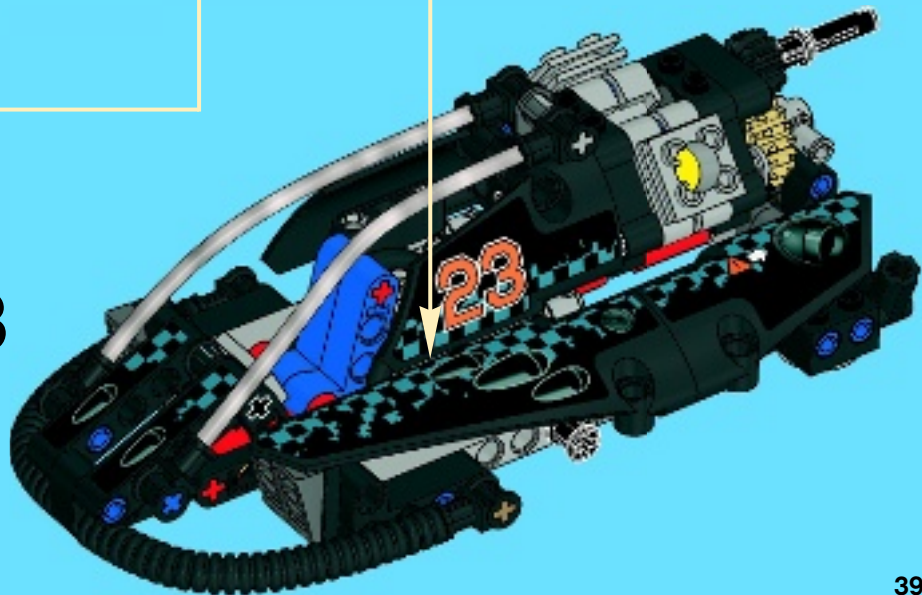

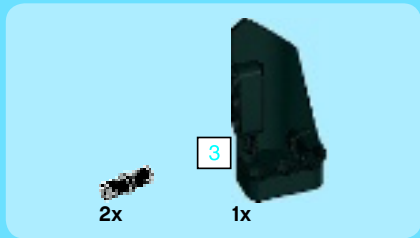

1

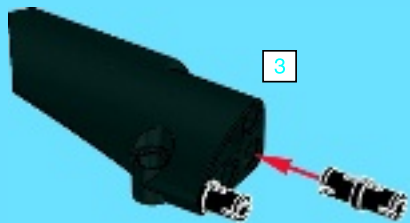

2



3

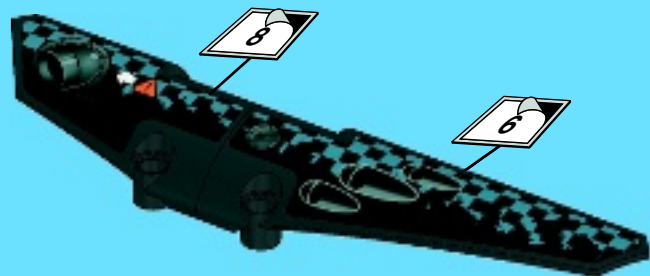

24

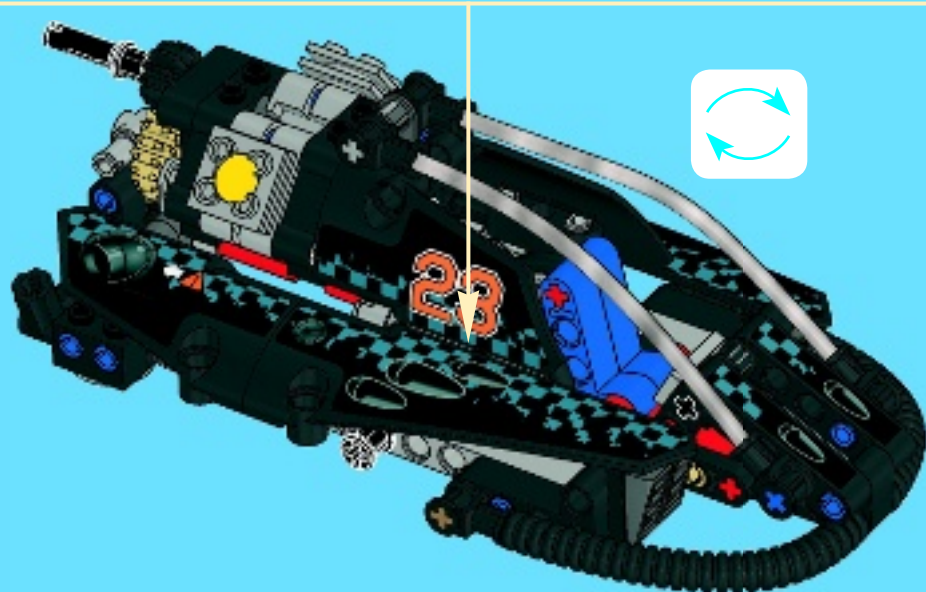



25

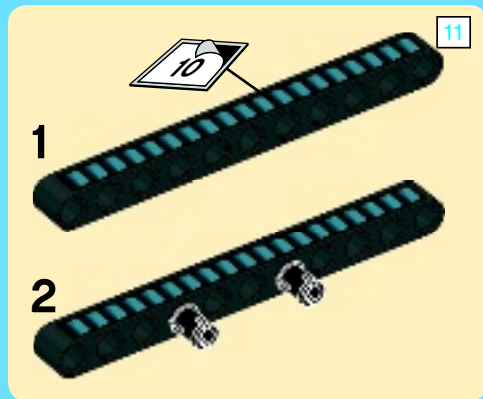
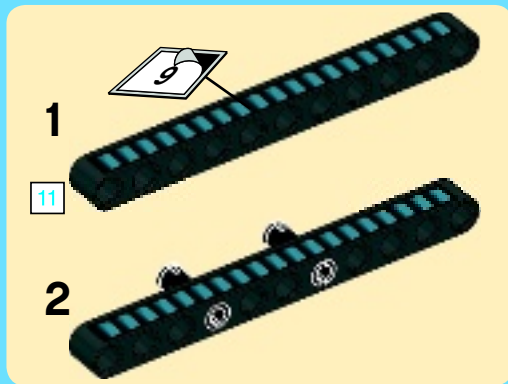
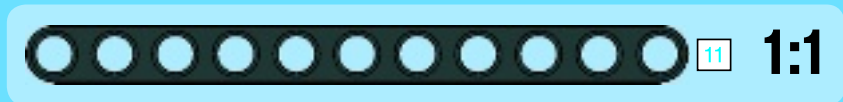

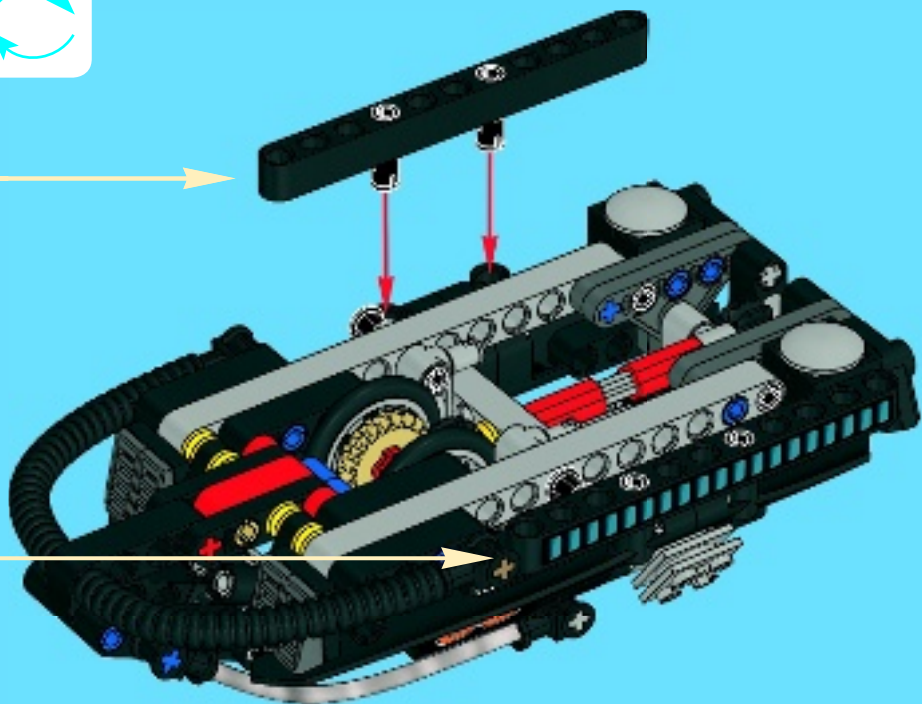

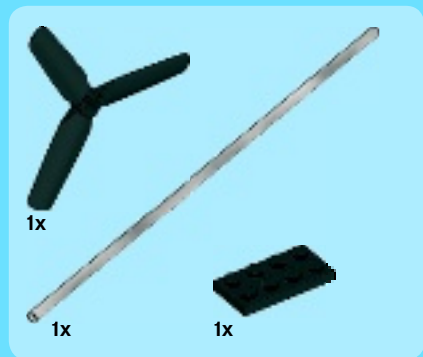

26

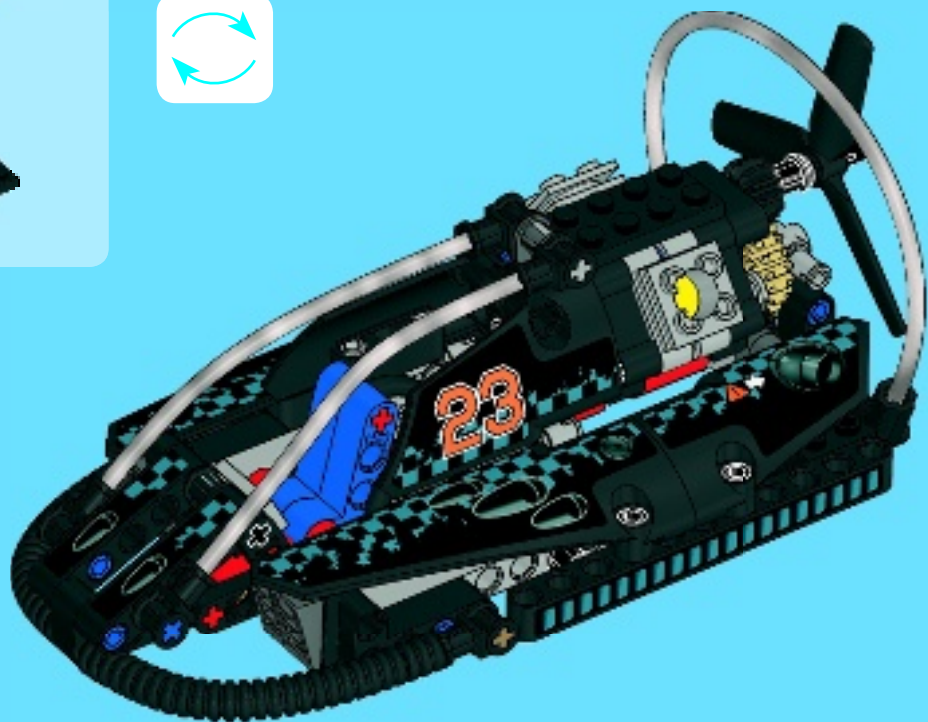

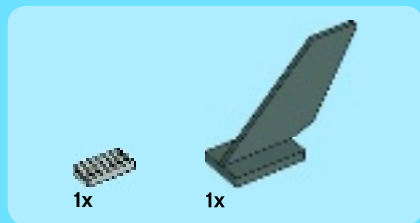

27

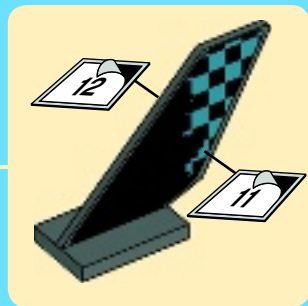
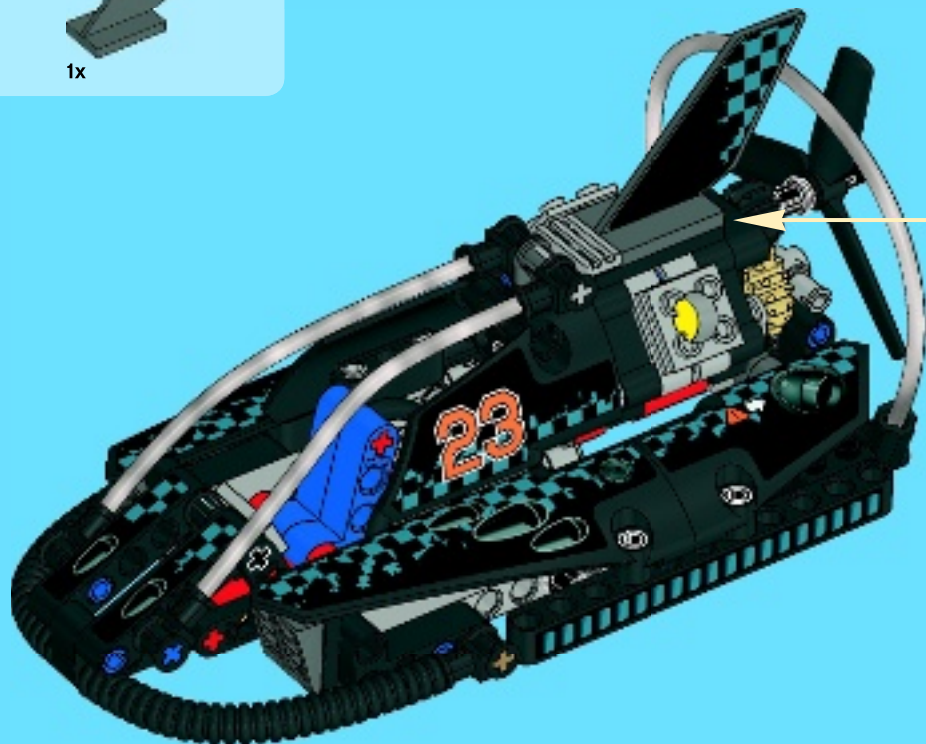

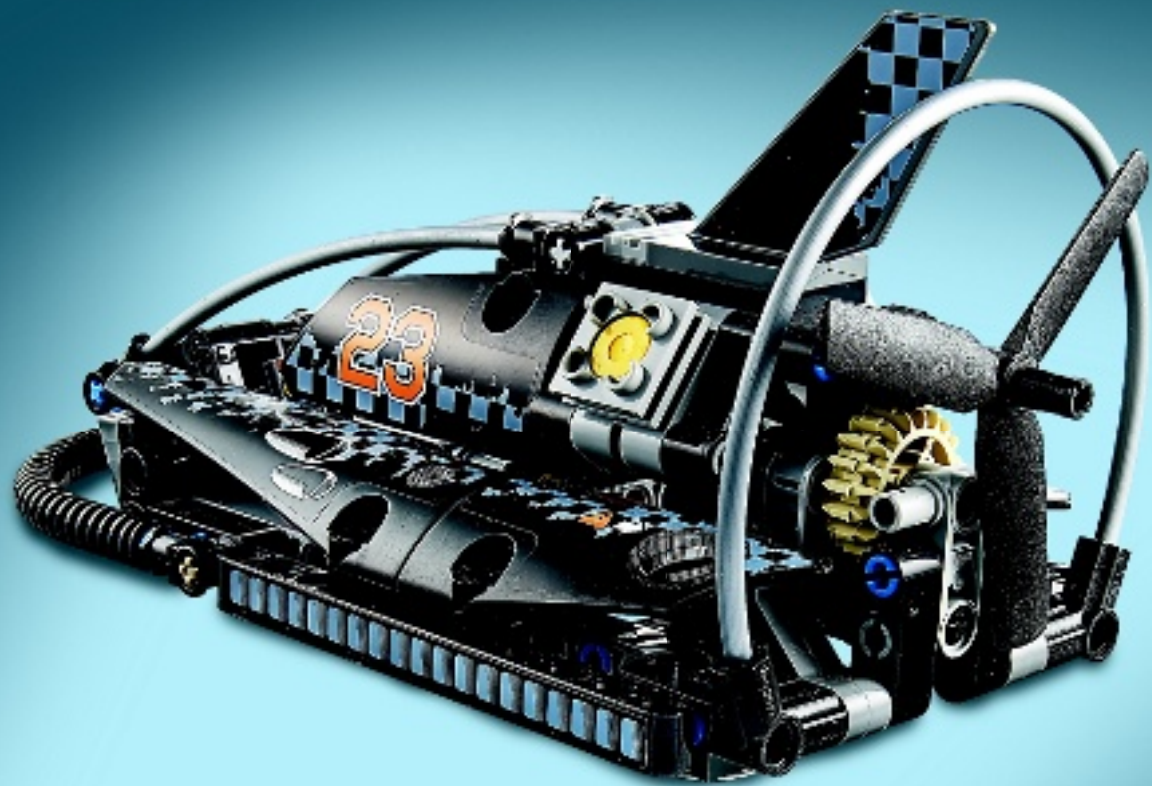





TECHNIC

42010



**PULL
BACK**

**RÉTRO-
FRICTION**

42011





TECHNIC



LEGO.com/technic



TECHNIC



42011



42010



42002



42004



42007



42006



42000



CREATOR

31002



31003



31004



31005



31006



LEGO.com/creator

3 IN **1**

LEGO

HYDRO LAUNCHERY



44005



44001



2x
4566927



2x
4112203



6x
4239601



4x
3200026



2x
4141810



1x
302026



2x
244426



1x
4142731

6



1x
4558731

4



2x
4541325

3



2x
4541924

5



1x
4558774



1x
4552347



2x
4142822



5x
4120017



2x
4142135

5



2x
6029578



1x
4140430

11



4x
4142236



2x
6028041



19x
4121715



2x
4107084



6x
4107081



3x
4140801



4x
370526



3x
4177431



2x
4275296

4



1x
4500562



4x
4540386



1x
4210851



4x
6010862



4

1x
4560177



3x
6013938



1x
6031962



1x
4514555



1x
4153718



2x
4186678



1x
4227155



3x
4142865



2x
4513174



2x
4168114



7x
4206482



15x
4514553



3

5x
4211815

5

1x
4211639



7

2x
4211805



1x
4225033



2x
4296059



2x
4494222



2x
4211609



2x
6000018



2x
4234251



4x
4211483



1x
4227776



1x
4211350



2x
4278273



1x
4560175



2x
4211779



1x
4495930

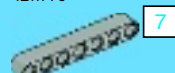

7

1x
4495930

2x
4522934

2x
4522934



2x
6024370



1x
6024376



Customer Service

Kundenservice

Service Consommateurs

Servicio Al Consumidor

LEGO.com/service or dial



: 00800 5346 5555

: 1-800-422-5346



2



3



www.LEGOclub.com/Max

LEGO club™

FREE*! GRATIS! GRATUIT!

*Paid subscription in Australia and New Zealand.
*Abonnement payant en Australie et Nouvelle-Zélande.

 LEGO.com

LEGO and the LEGO logo are trademarks of the/sont des marques de commerce de/son marcas registradas de LEGO Group. ©2013 The LEGO Group.

6033708 / 6033732

