



# CREATOR

31008





1x

1



2

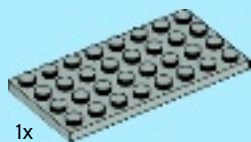

1x

2





2x



2x

3



2x

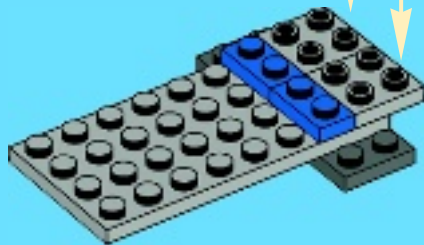



1x



2x



1x

4

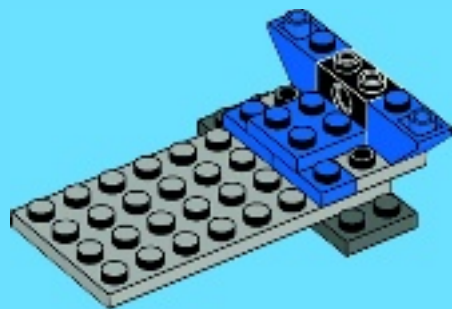



2x



2x

5

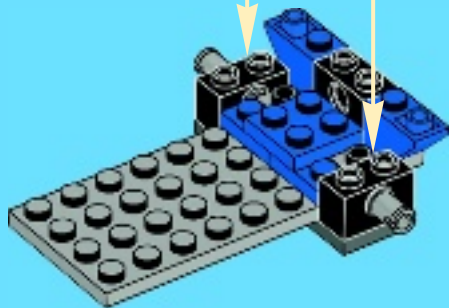
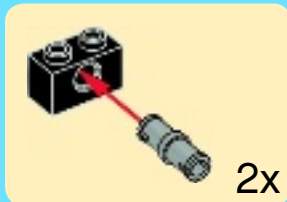



1x

6

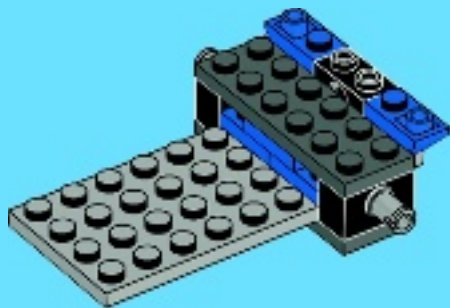



1x



1x



1x

7

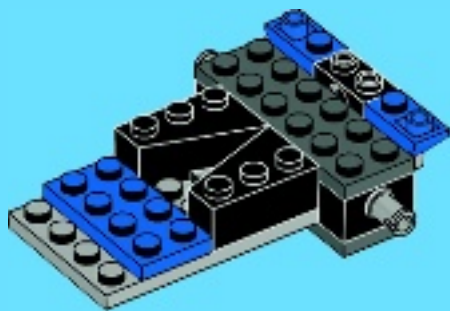



2x



2x

8

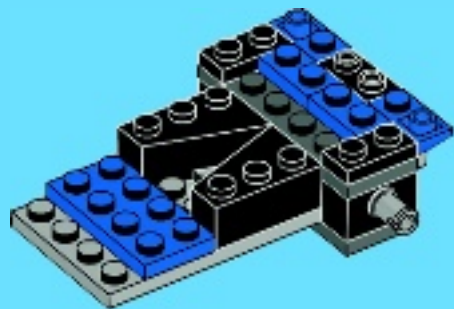



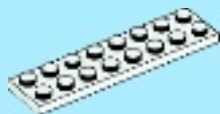

2x

1

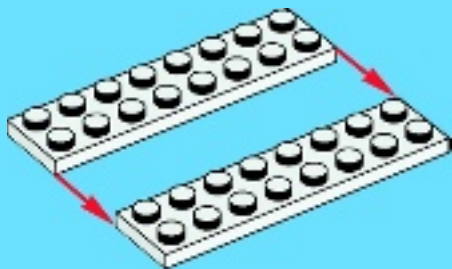

1x

2





1x



1x

3

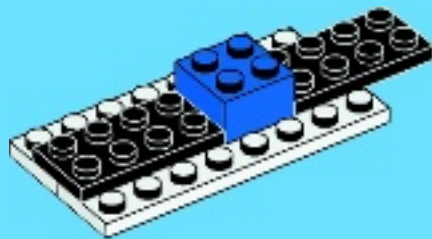



2x



2x

4

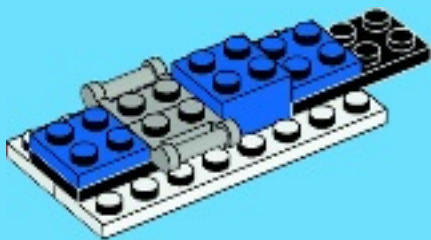



1x



1x

5

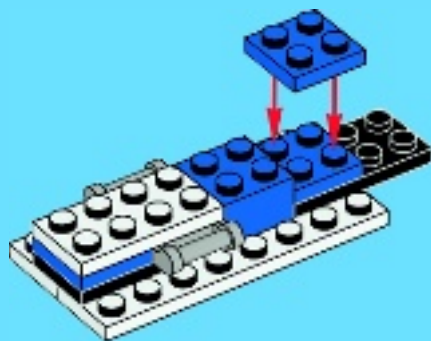

9

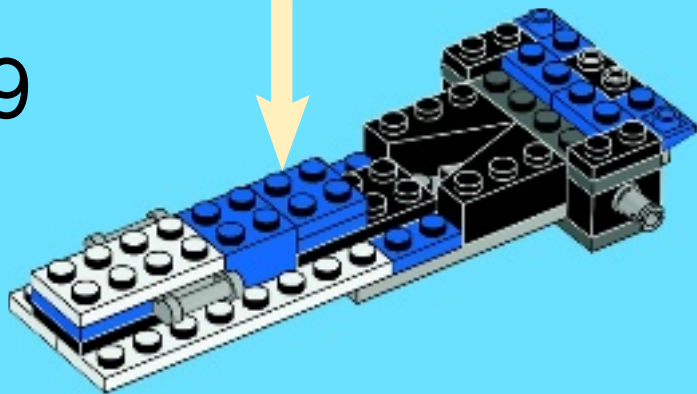



2x

10

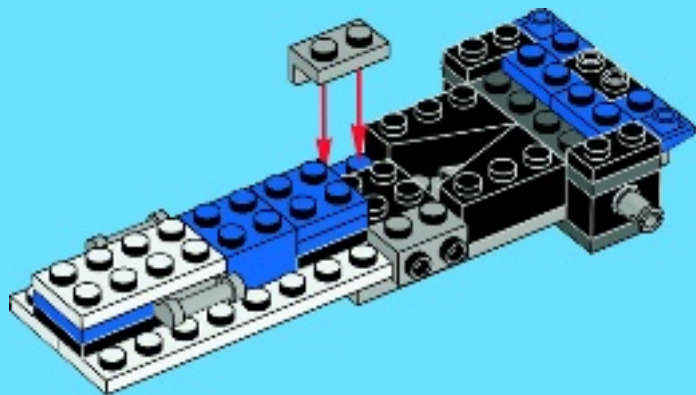



1x

11

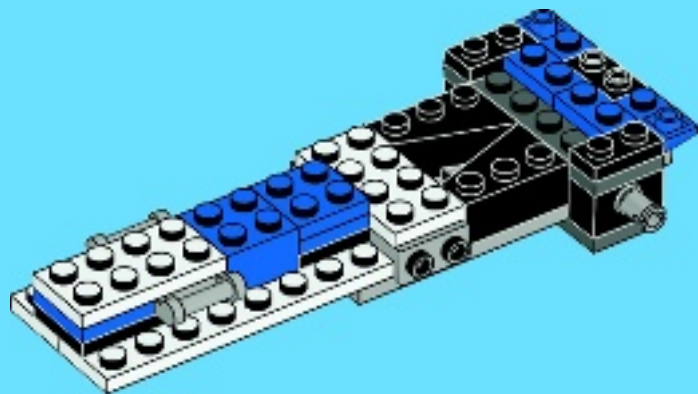



1x

12

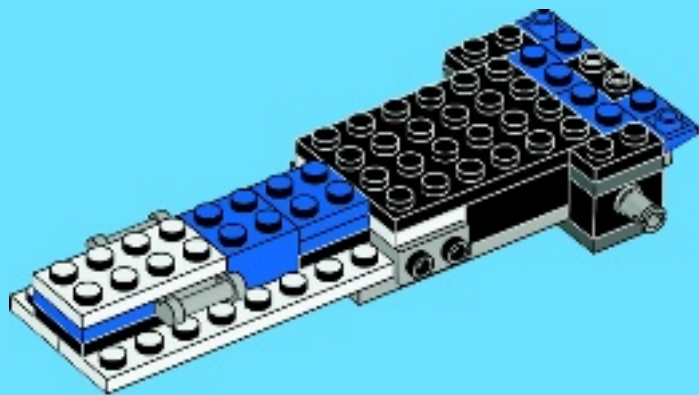





2x



1x

# 13

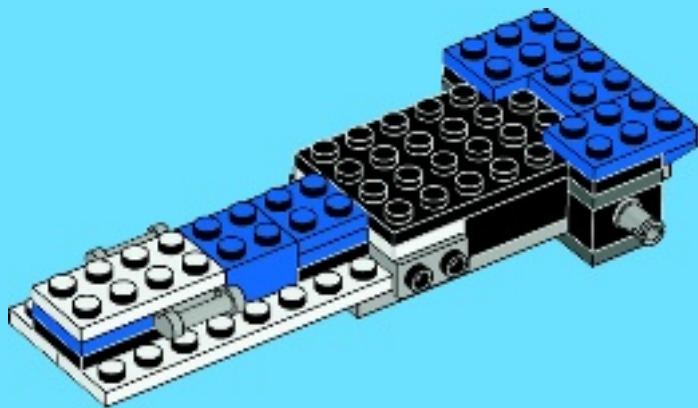



1x



1x

14

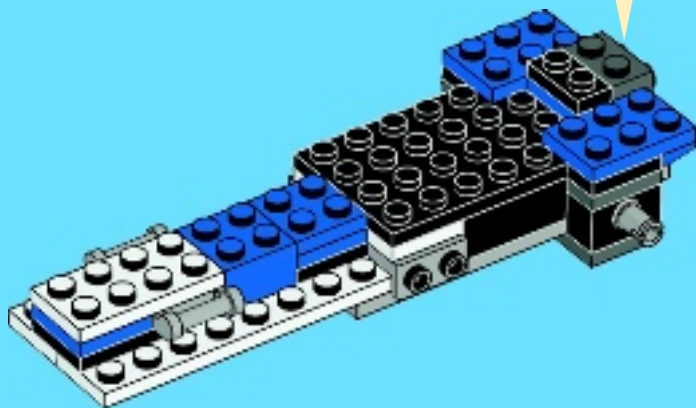

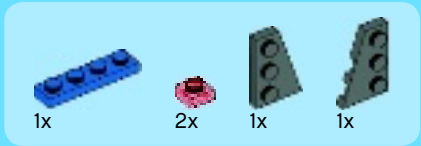

15

1

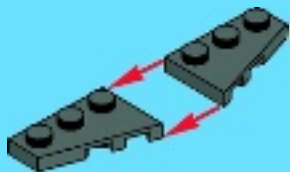

2

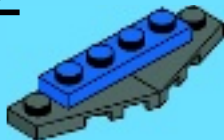

3

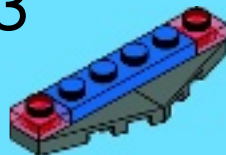

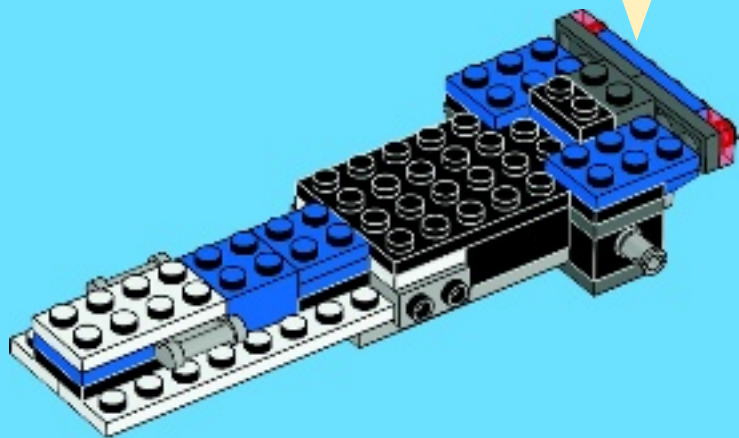



1x



2x



1x

# 16

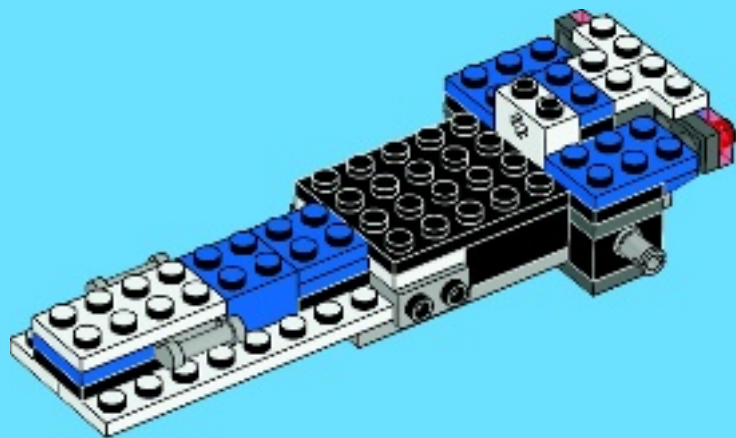



2x



2x



1x

17

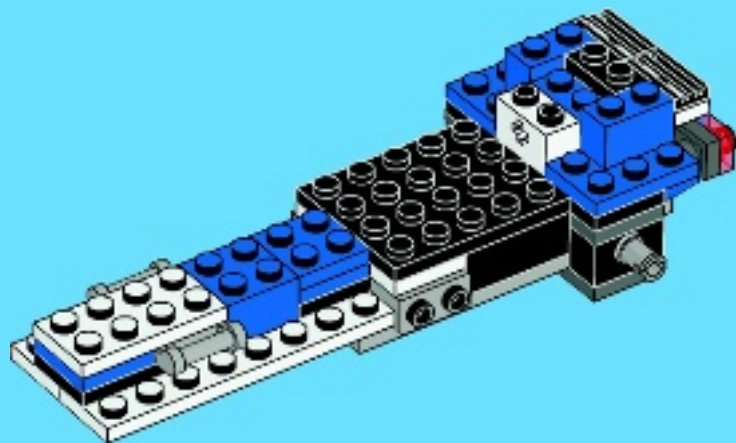

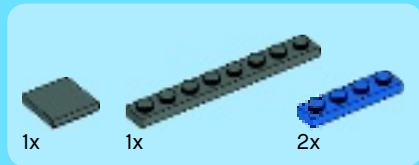

18

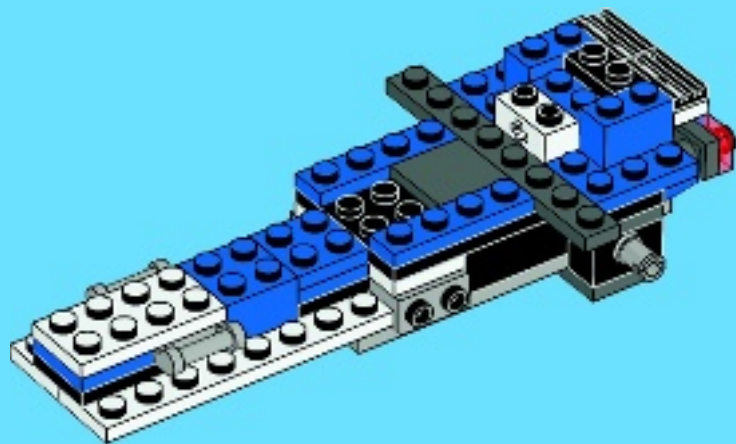



1x



1x

# 19

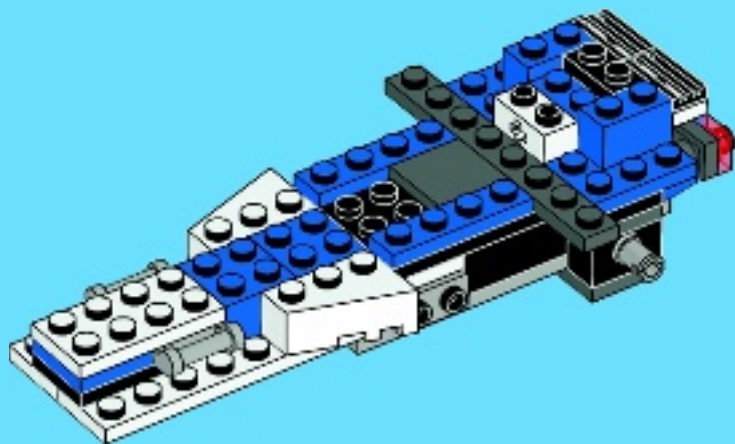





2x



2x

# 20

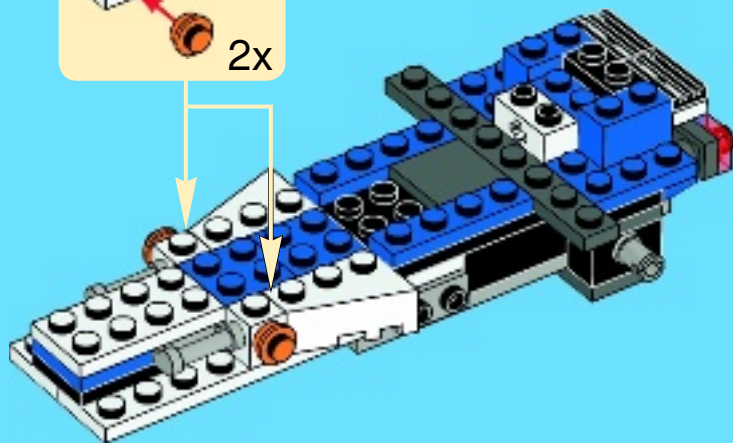
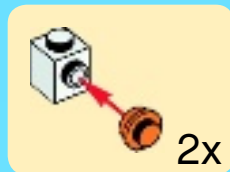



2x

21

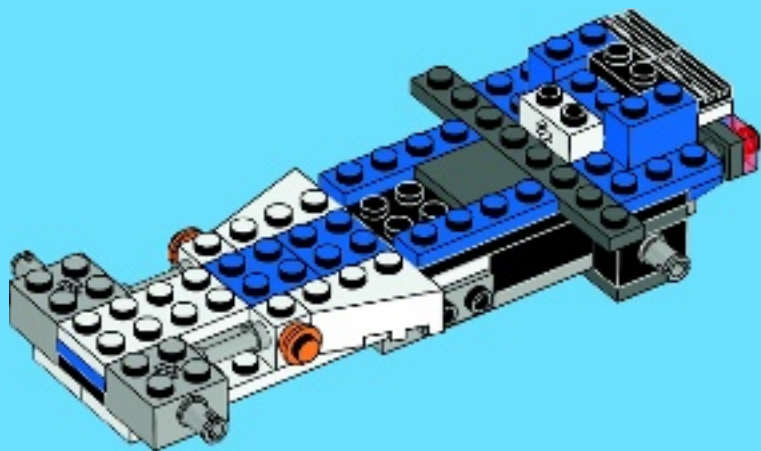

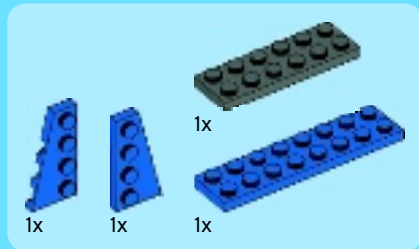

22

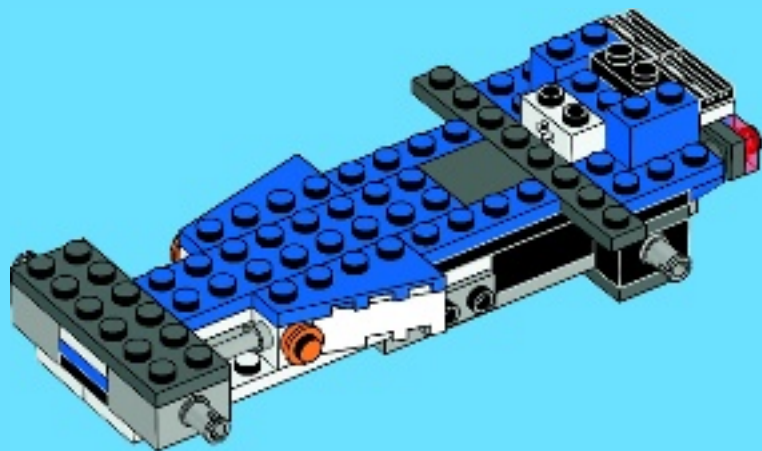



2x



1x



1x

# 23

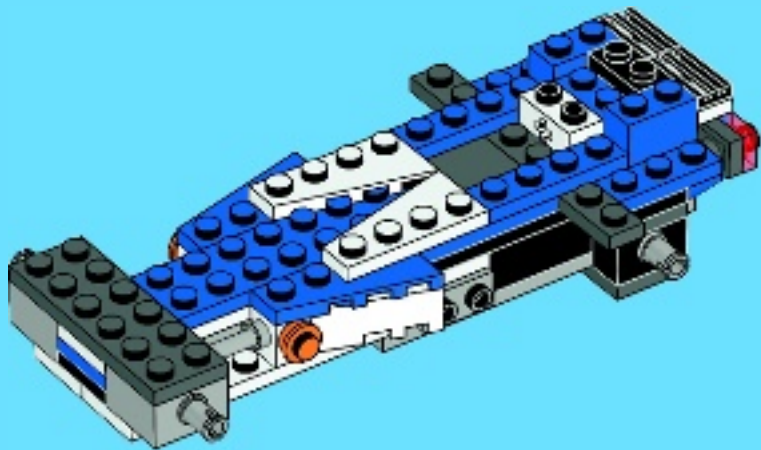



4x

# 24

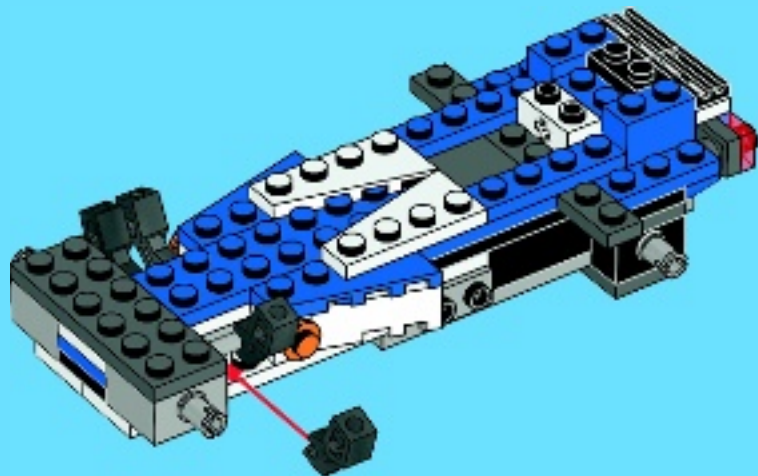



1x



1x



1x

# 25

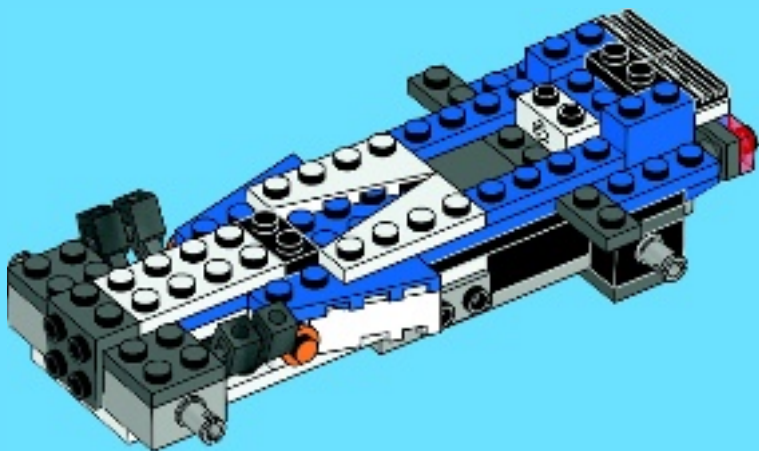



4x

26

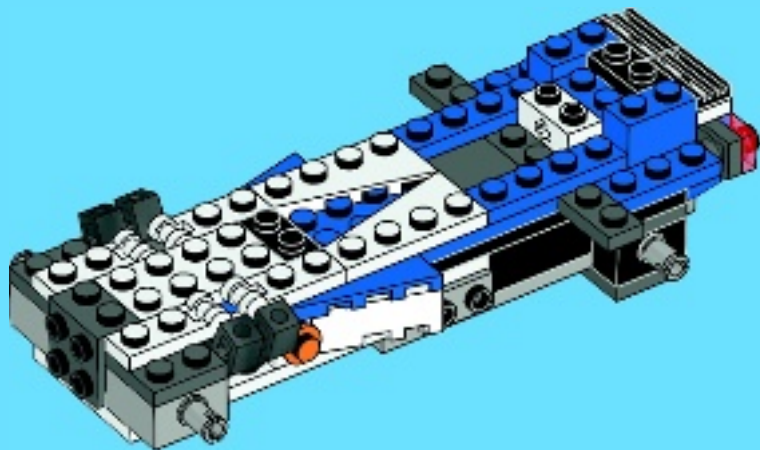



27

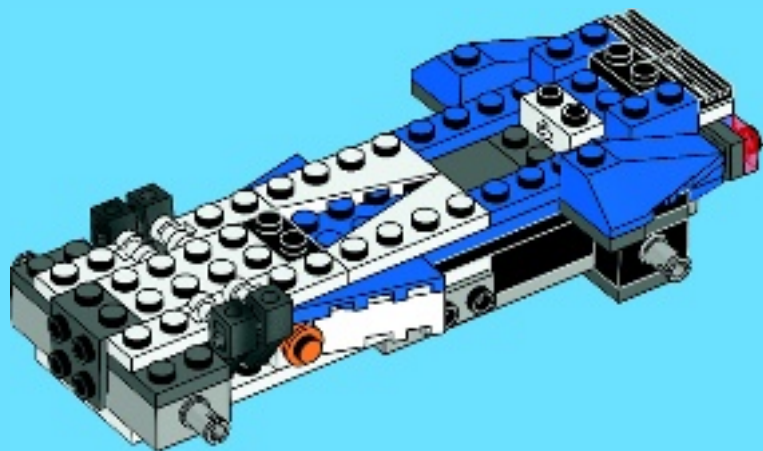





2x



2x

# 28

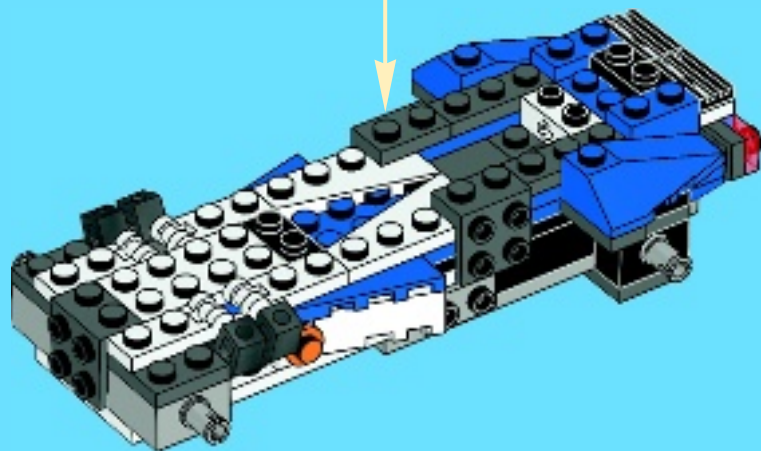



1x



1x

# 29

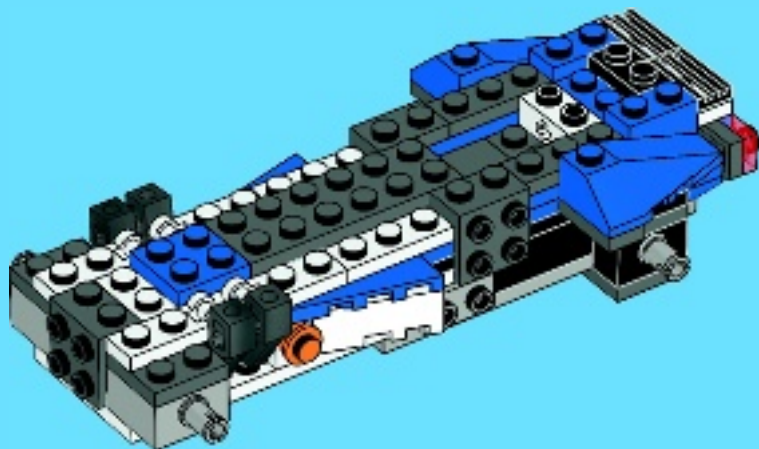



2x



2x



2x



2x

# 30

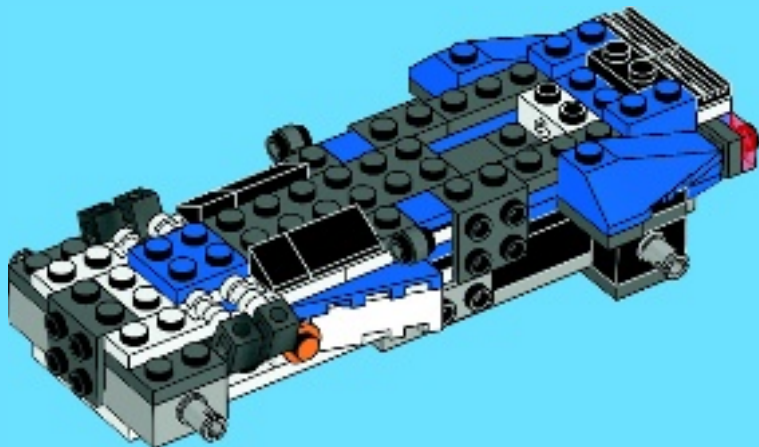



1x



1x



1x



1x



1x



1x

# 31

## 1



## 2



## 3



## 4

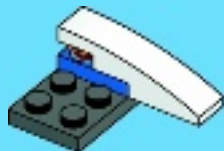

5

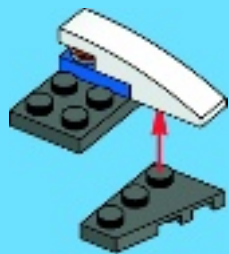

6

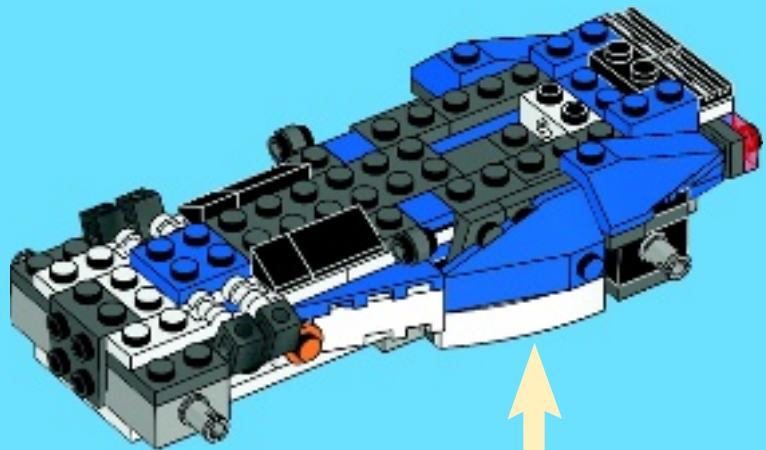



1x



1x



1x



1x



1x



1x

# 32

## 1



## 2



## 3



## 4

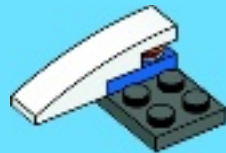

5

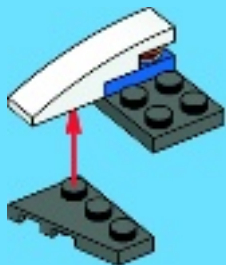

6

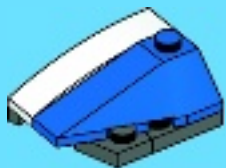



1x



1x



1x



1x

# 33

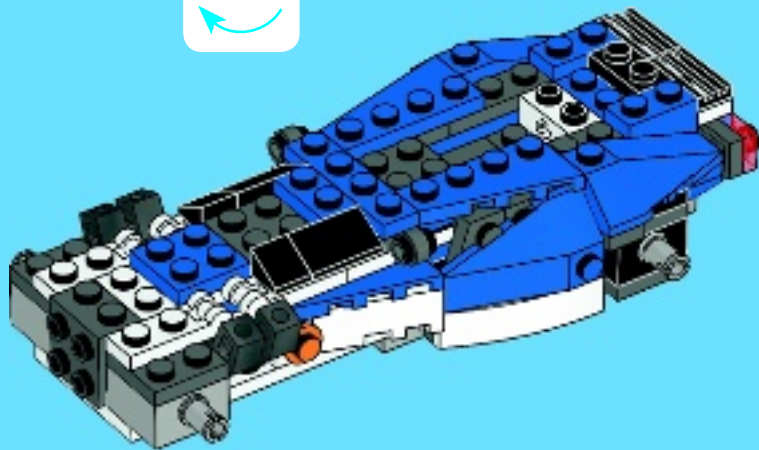





2x



2x



1x



1x

# 34

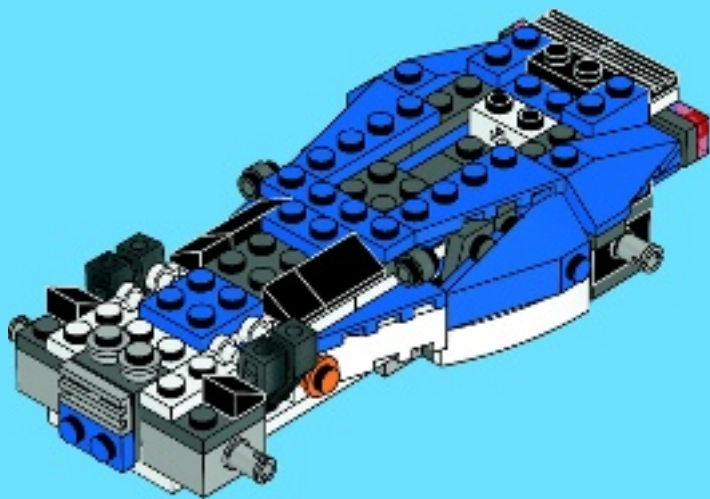



2x



1x



1x

# 35

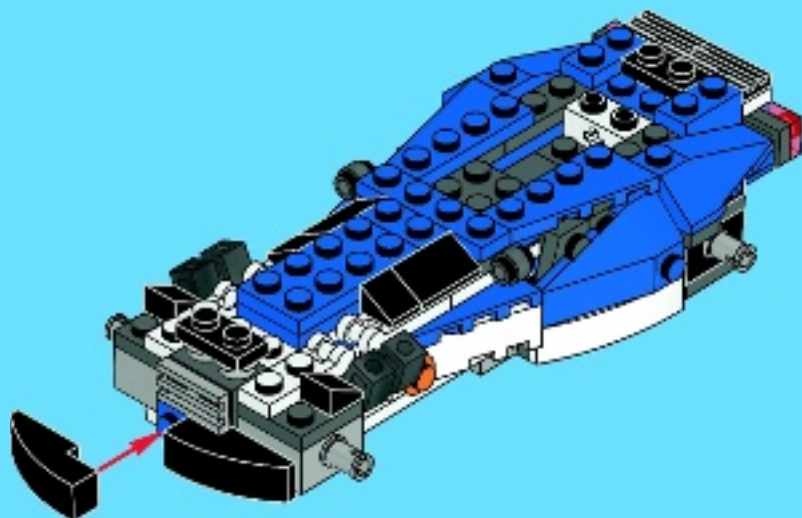



1x



1x

# 36

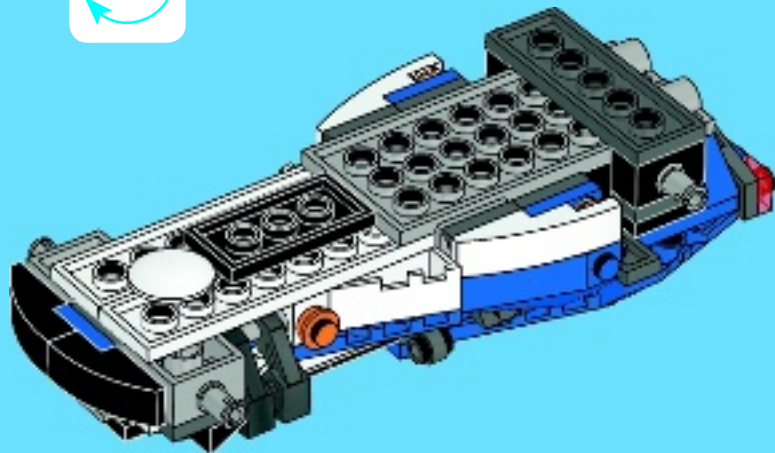



2x



2x



2x

# 37

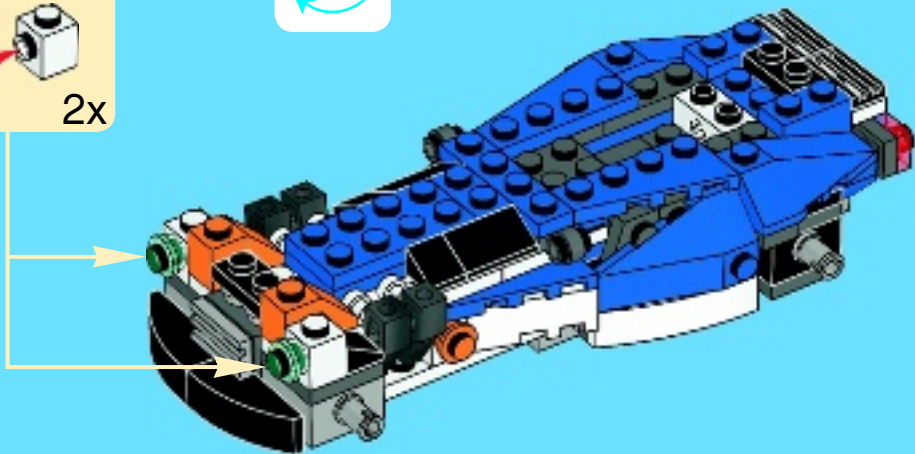
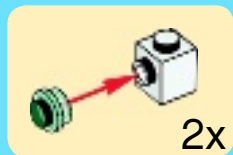



4x



1x

# 38

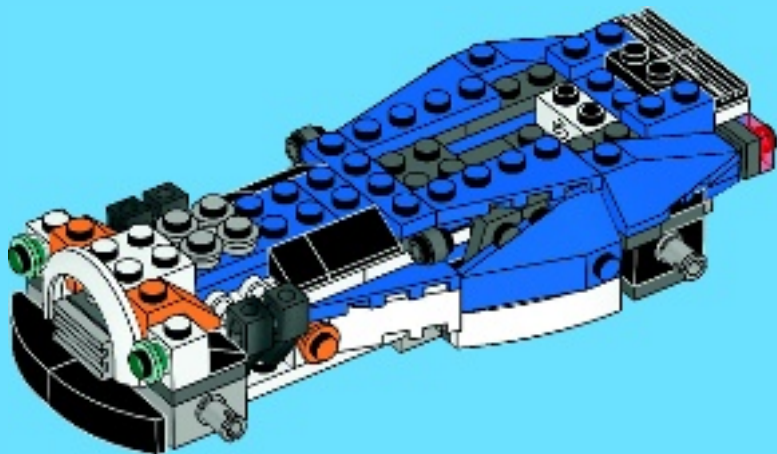



2x



1x



1x

# 39

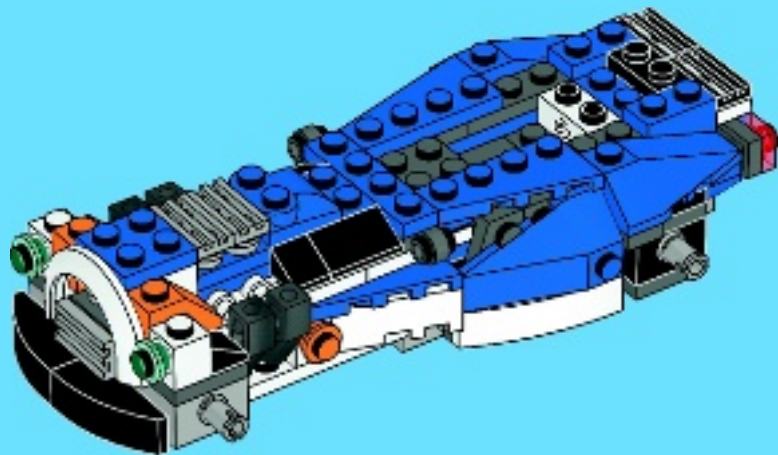



1x



1x

# 40

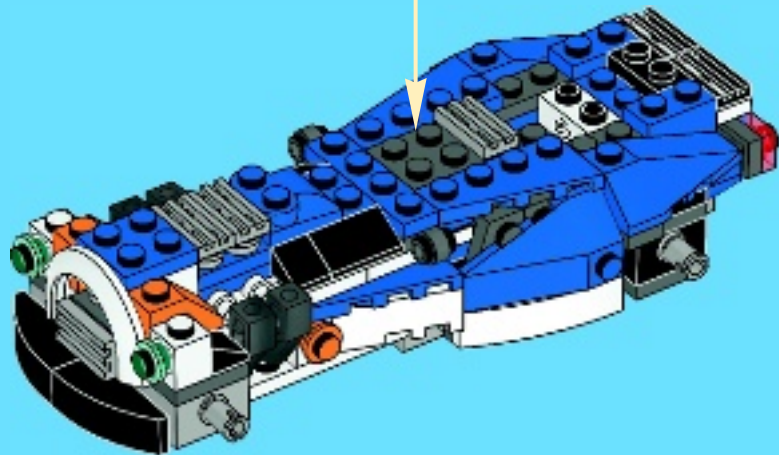
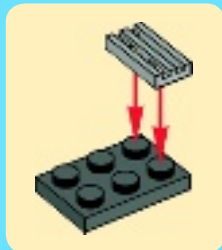



1x



1x



1x



1x

# 41

1



2



3





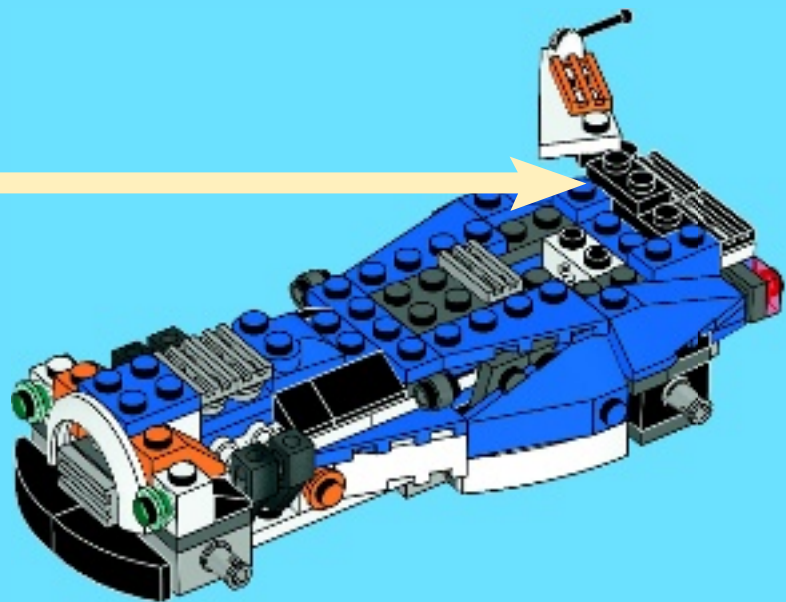



1x



1x



1x



1x

# 42

1



2

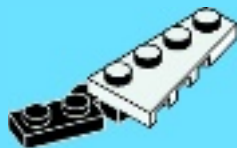

3



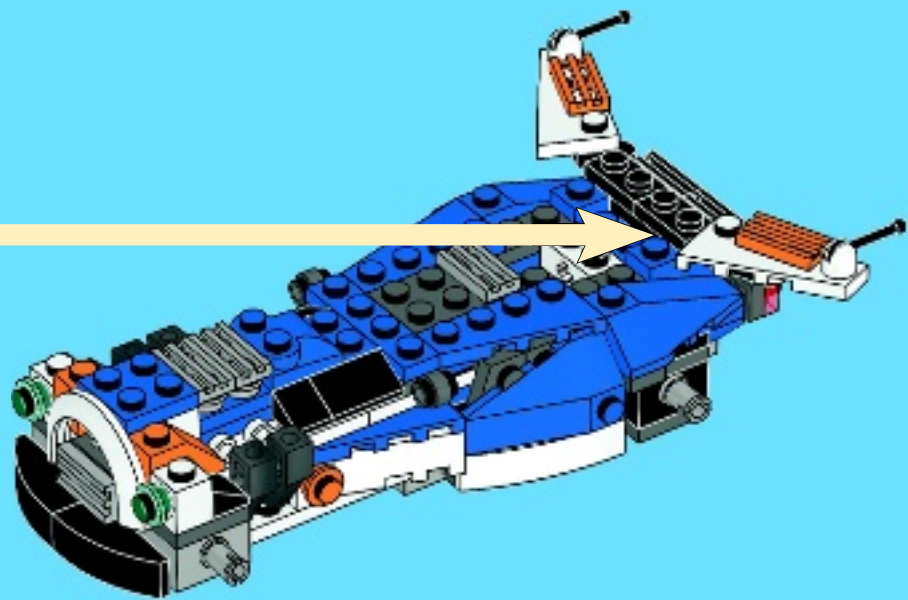



2x



2x

# 43

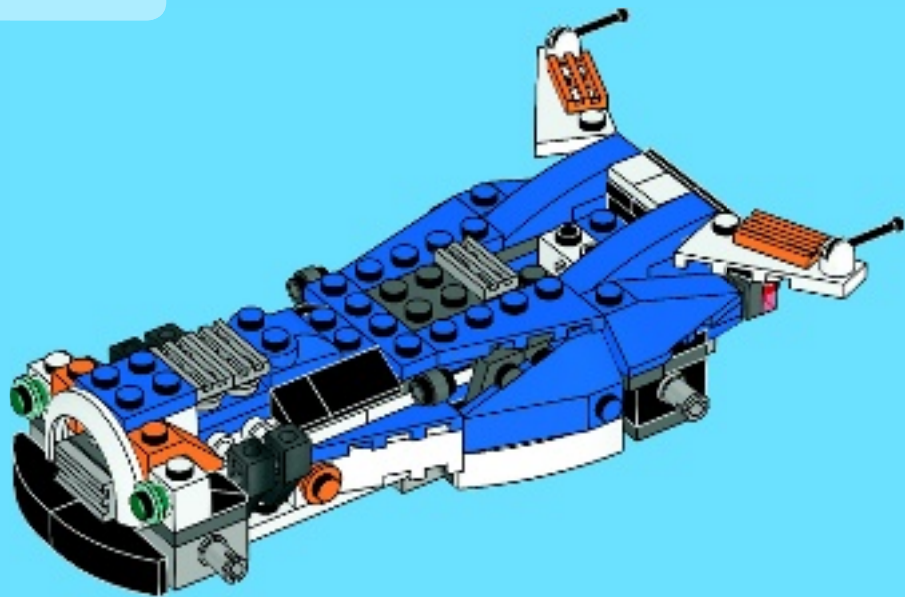



2x

44

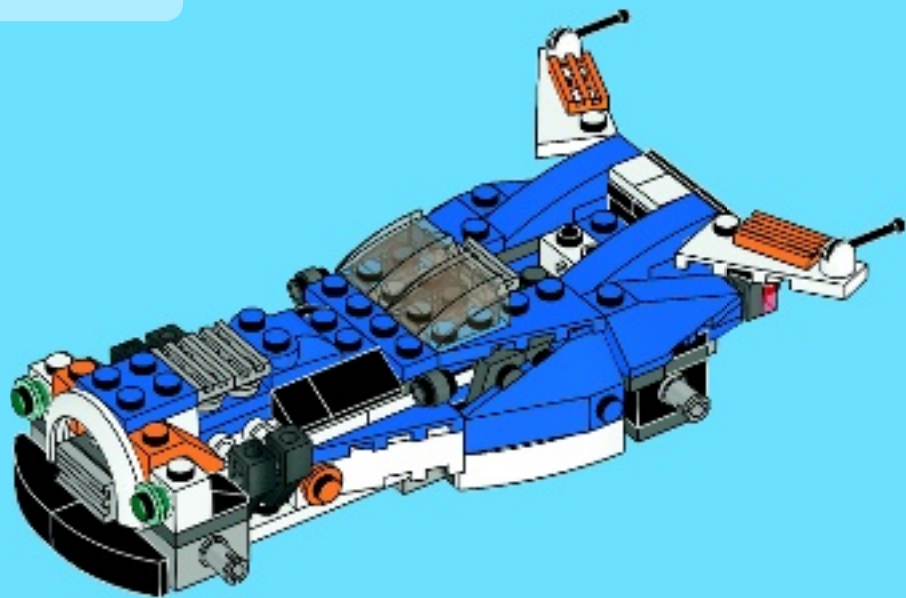



1x



2x



2x

# 45

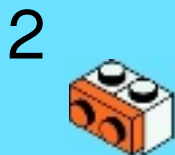
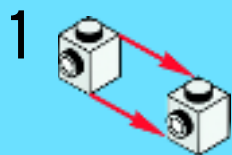

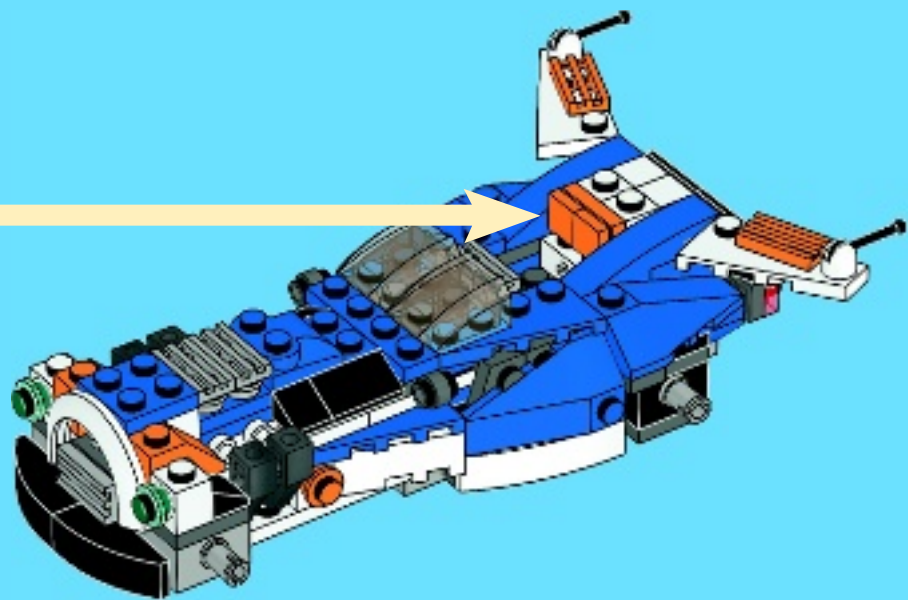



2x



2x



2x



2x

# 46

