



building
bigger
thinking™

10404

LEGO

building
bigge
thinking™



Did you know your imagination is **bigger** than a grown-up?

Wusstest du, dass deine Fantasie größer ist, als die der Erwachsenen?

Savais-tu que ton imagination est encore plus grande que les adultes ?

Lo sapevi che la tua immaginazione è più grande di quella degli adulti?

¿Sabías que tienes más imaginación que los mayores?

Sabes que a tua imaginação é maior do que a dos adultos?

Tudtat, hogy a képzeleted gazdagabb, mint a felnőtteké?

你知道吗？
你的想像力比大人还丰富呢？

it's true! you can
think of anything...
all you need to do is **build it**

das stimmt!
du kannst dir alles ausdenken ...
dann musst du es nur noch bauen

c'est vrai !
tu peux inventer tout ce que tu veux...
tu n'as qu'à le construire

è vero!
puoi immaginare qualsiasi cosa...
devi solo costruirla

¡es cierto!
puedes imaginar cualquier cosa...
lo único que tienes que hacer es construirla

é verdade!
tu consegues pensar em tudo ...
tudo o que precisas de fazer é construir

ez így van!
bármit elképzelhetsz...
csak annyit kell tenned, hogy megépíted

千真万确!
各种奇思妙想,
尽在一拼一搭间, 得以实现.....



For **60 years** LEGO® bricks have inspired **creativity**

Seit 60 Jahren
fördern LEGO®
Steine Kreativität



Les briques LEGO®
stimulent la créativité
depuis 60 ans

Per 60 anni, i
mattoncini LEGO®
hanno ispirato
creatività

Los ladrillos LEGO®
llevan más de 60 años
fomentando la creatividad

Durante 60
anos as peças
LEGO® inspiraram
criatividade

A LEGO® kockák
már 60 éve ösztönzik
a kreativitást

60年来, 乐高®
积木激发了孩子们无限的创造力

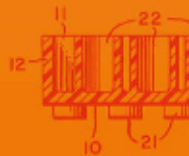



Diese Box wurde entwickelt, um größeres Denken in zukünftigen Generationen zu fördern

Cette boîte est conçue pour encourager les générations futures à voir plus grand

Questa scatola è progettata per incoraggiare le generazioni future a pensare in grande

Esta caja está diseñada para hacer pensar en grande a las generaciones venideras

Esta caixa é concebida para inspirar pensar em grande em gerações futuras

Ezzel a dobozzal azt üzenjük a jövő generációinak, hogy gondolj egy nagyot!

该盒子旨在激发孩子们的创造力，拓展他们的思维空间

This box is
designed to inspire
bigger thinking in
generations to come

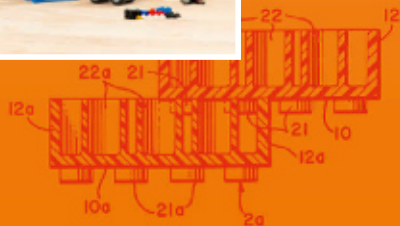

 Easy building
Einfach zu bauen
Construction facile
Costruzione facile
Construcción fácil
Construção fácil
Kezdő építőknek
简单拼砌

 Medium building
Mittelschwer
Construction intermédiaire
Costruzione media
Construcción intermedia
Construção intermédia
Gyakorló építőknek
中级拼砌

 Advanced building
Fortgeschritten
Construction avancée
Costruzione avanzata
Construcción avanzada
Construção avançada
Tapasztalt építőknek
高级拼砌

Page
Seite
Pagina
Página
oldalszám
页码

 Page **16**



what is at
the **bottom** of the



was ist auf dem **Grund**
des ?

que trouve-t-on au **fond**
de ?

cosa c'è in **fondo** a ?

¿qué hay en el **fondo** de ?

o que está no **fundo** do ?

mi van a **mélyén**?

想一想，..... 的底部有些什么？

 Page **28**



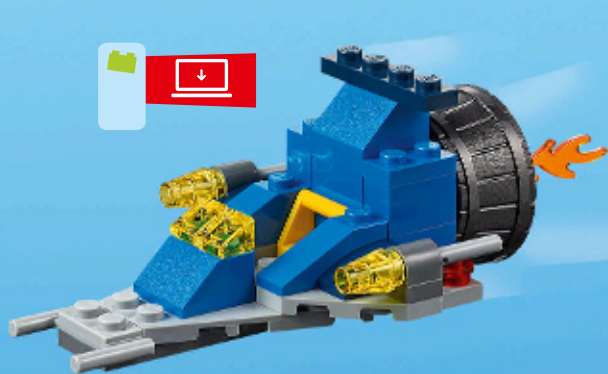

Page 8



Page 44



LEGO.com/biggerthinking

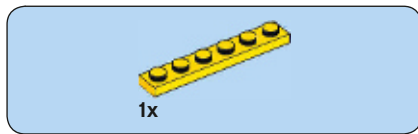

1

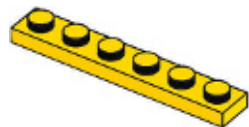



1x

2

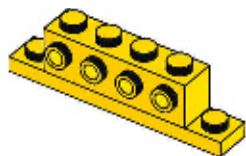

2x



1x

3

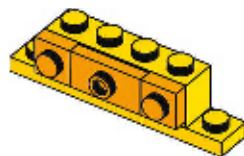



3x

4

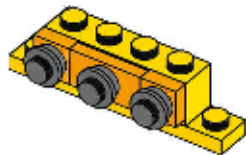



3x

5

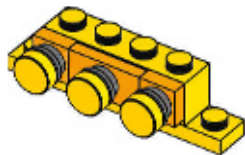

2x

6

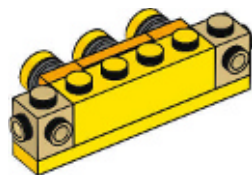
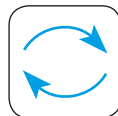

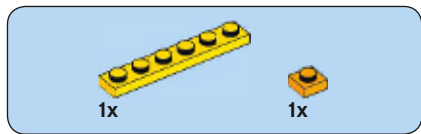

7

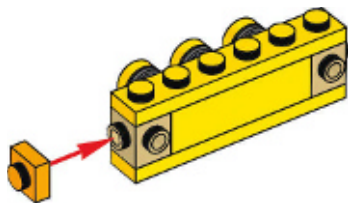

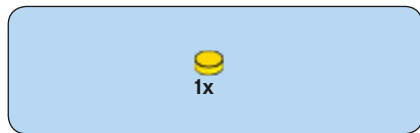

8

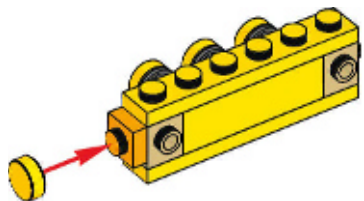

9

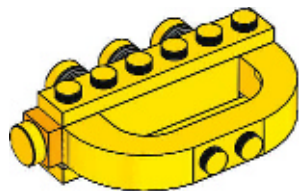



10

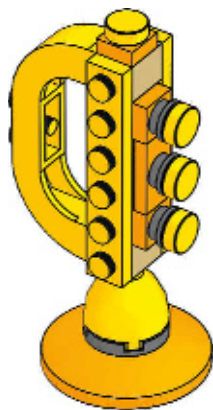
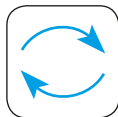

which



is playing the trumpet?

welcher spielt die
Trompete?

quels jouent de la
trompette ?

quale sta suonando la
tromba?

¿qué está tocando la
trompeta?

que está a tocar o
trompete?

melyik játszik **trombitán?**

哪个 正在吹喇叭?



Upload your build at / Lade deine Kreation hoch in / Télécharge ta construction sur /
Carica il tuo modello su / Carga tu modelo en / Faz o upload do teu modelo em /
Töltsd fel az építményedet ide: / 在此处上传您的拼搭作品





1x



1x

1

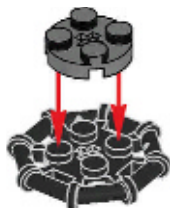

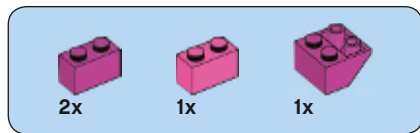

2

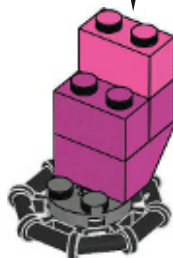
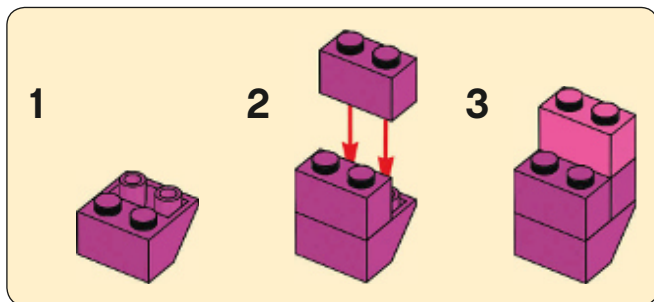



1x

3





4x

4

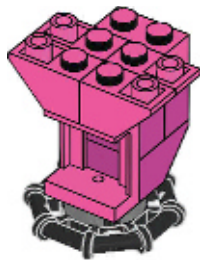

1x

5

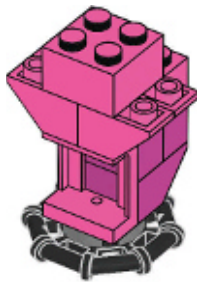



2x

6

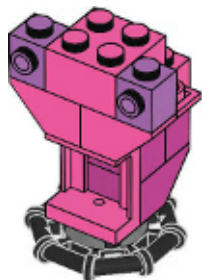



2x

7

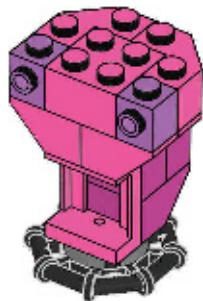

1x



1x

8

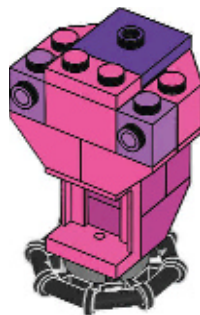



2x



1x

9

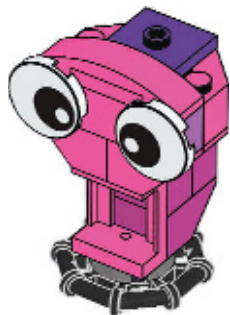

1x

10

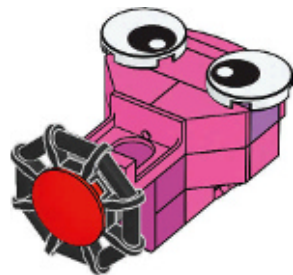
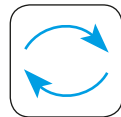

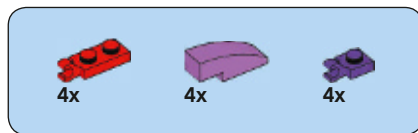

11

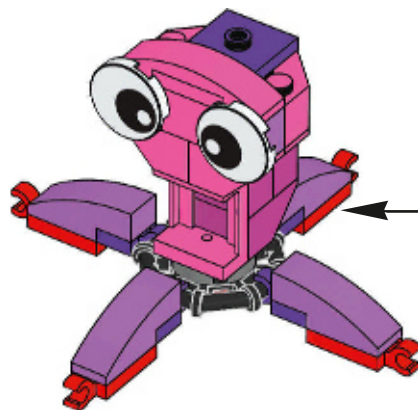
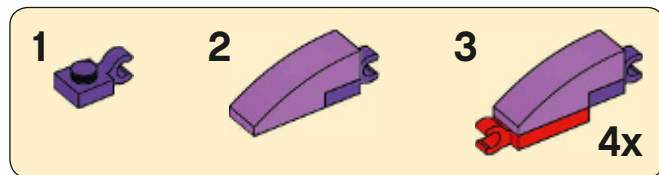
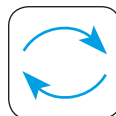

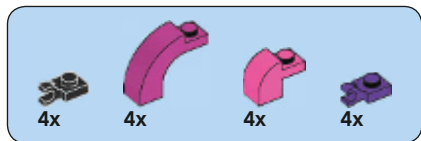

12

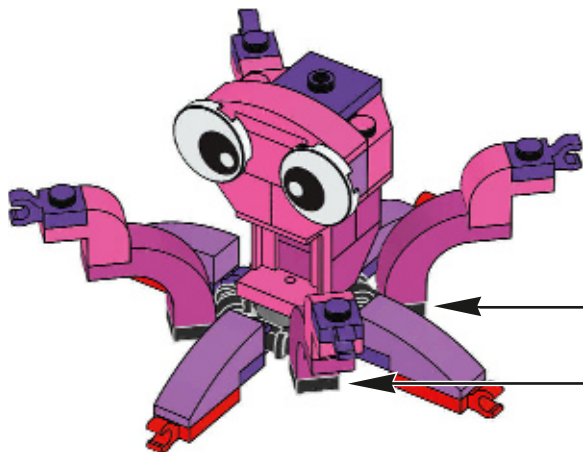
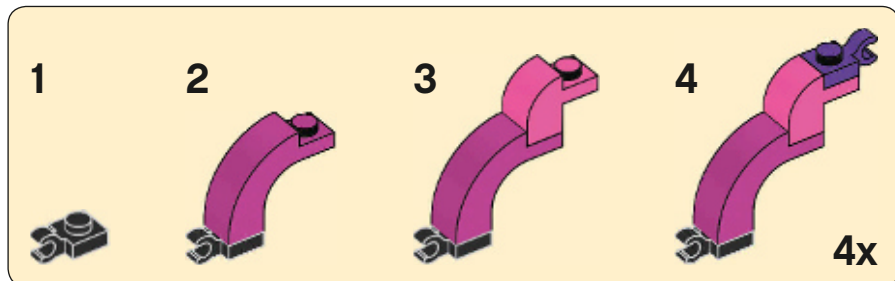



1x



1x

13

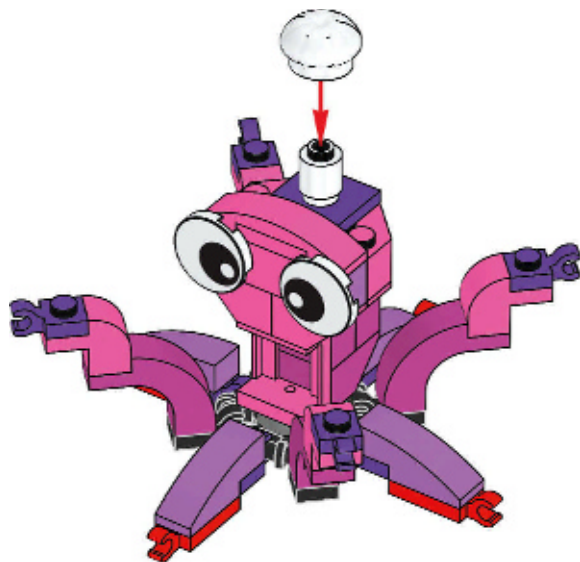

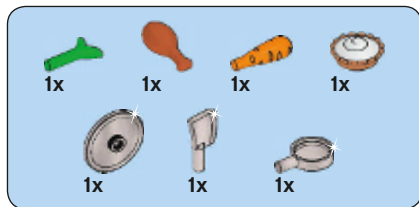

14

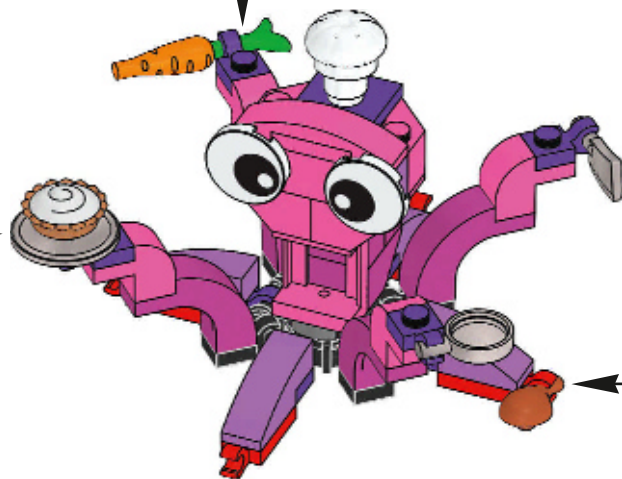
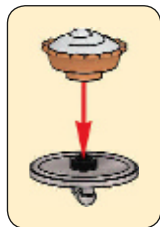
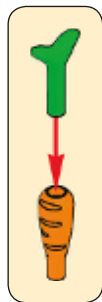

who is the



running away from?

vor wem läuft der davon ?

à qui tente d'échapper ?

da chi sta scappando il ?

¿de qué está huyendo ?

de quem está o a fugir?

ki elől menekül ?

..... 在逃离谁?



Upload your build at / Lade deine Kreation hoch in / Télécharge ta construction sur /
Carica il tuo modello su / Carga tu modelo en / Faz o upload do teu modelo em /
Töltsd fel az építményedet ide: / 在此处上传您的拼搭作品



 [LEGO.com/biggerthinking](https://www.lego.com/biggerthinking)



1



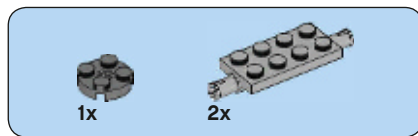

2

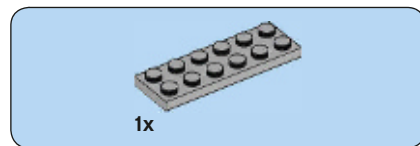
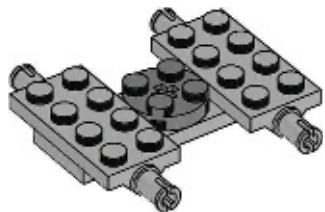

3

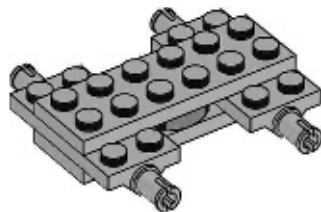



4

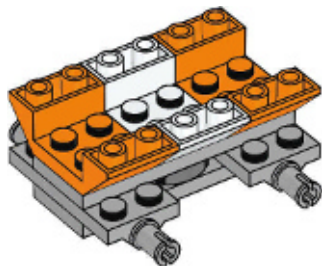

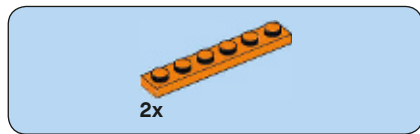

5

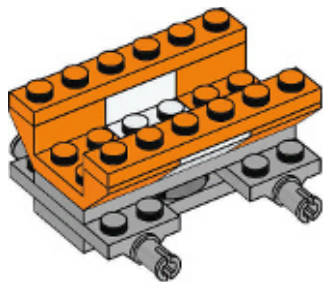

6

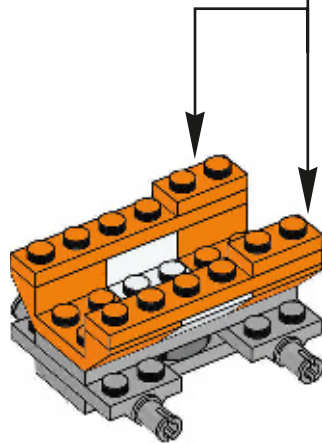
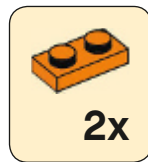



7

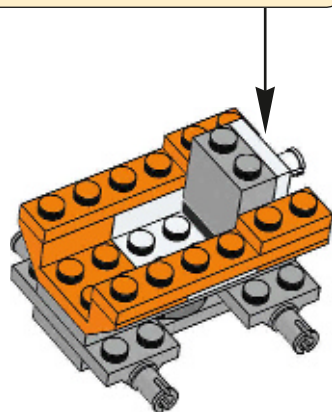
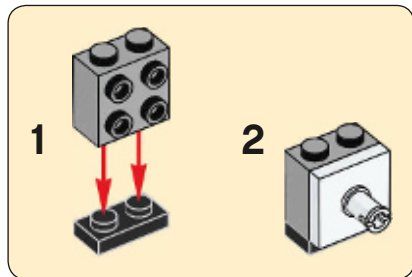



4x

8

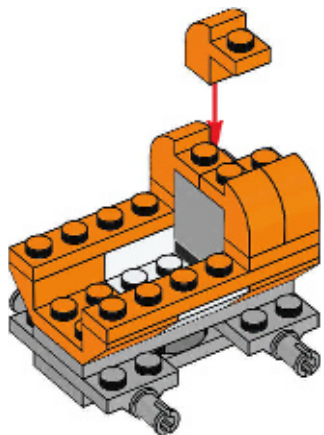

1x

9

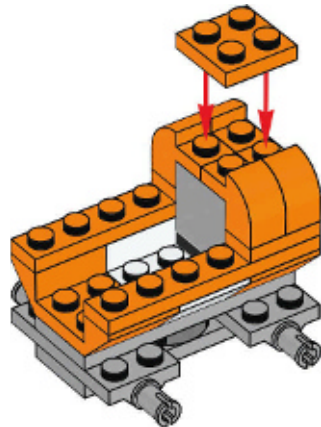



2x



1x

10

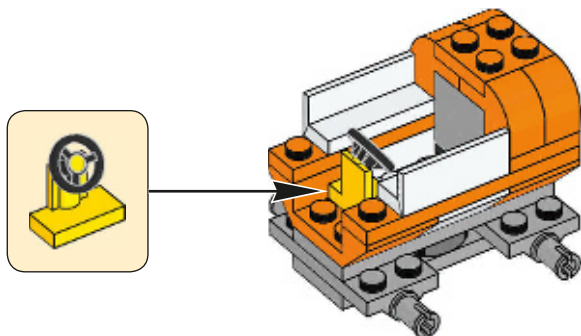



1x

11

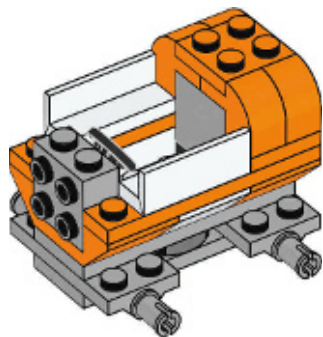

2x

12

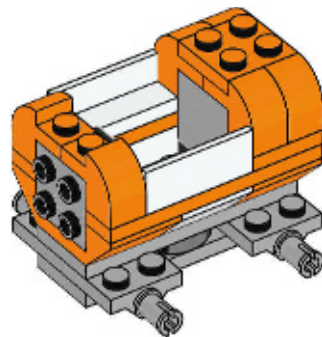



2x

13

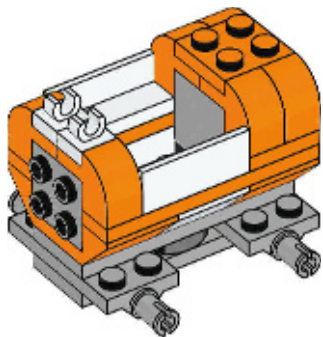

1x

14

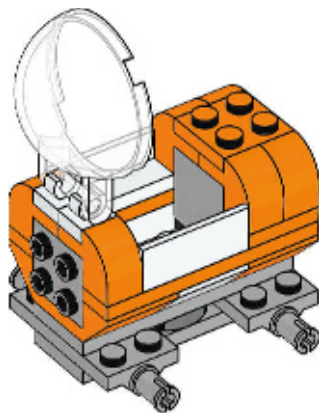



15

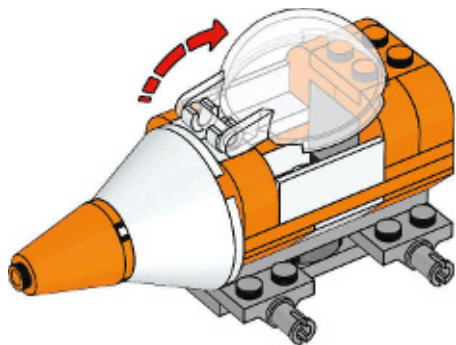
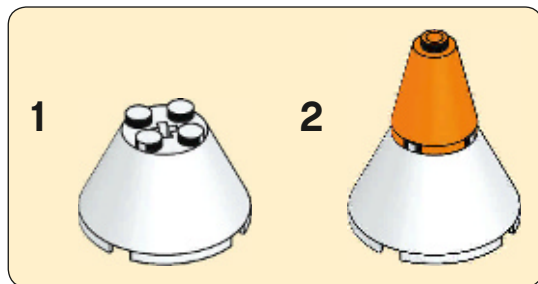



1x

16





1x

17



4x

18





4x

19



40



1x



1x

20

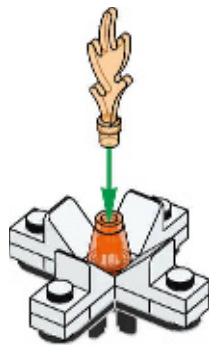



4x



4x

21

1



2



4x

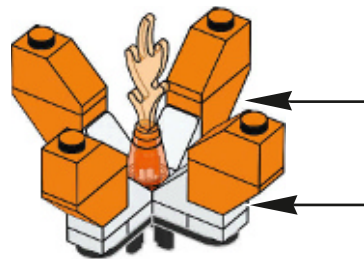

22

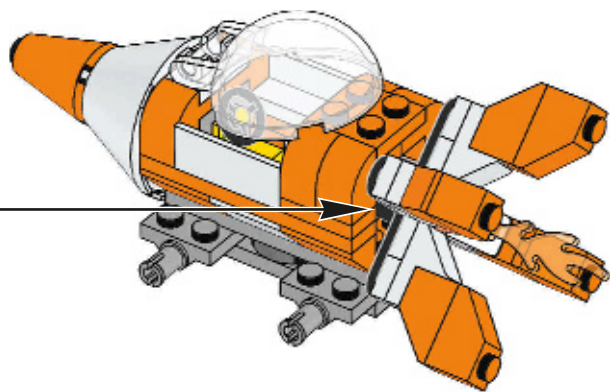



23

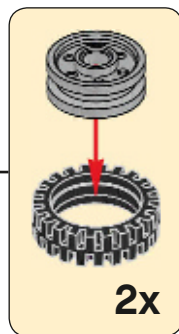
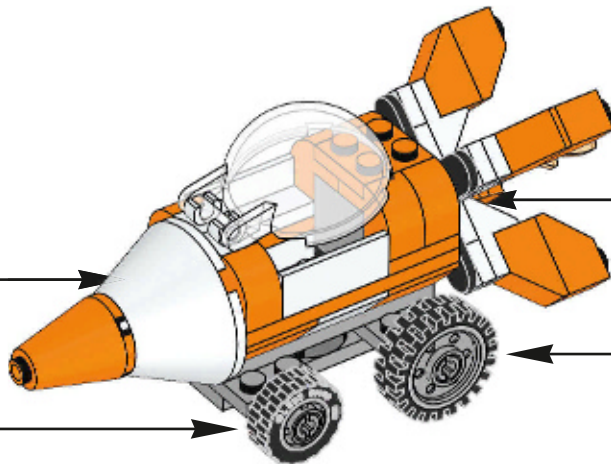
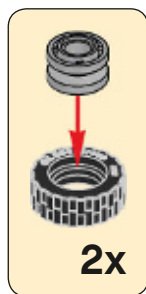



1x

1





1x

2



1x

3





4



5



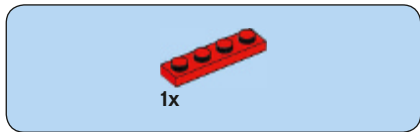

6



1x

1x

7

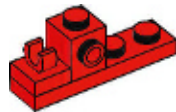



2x

8

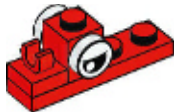

1x

9



10



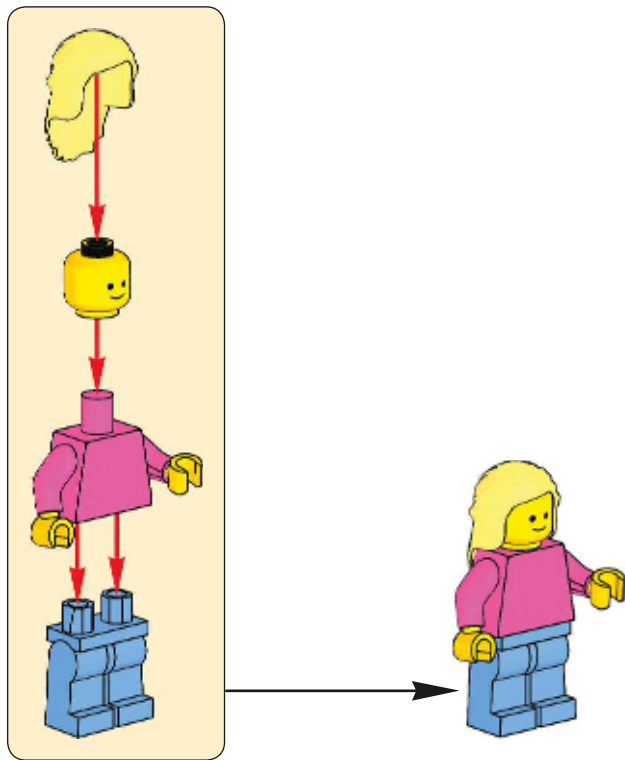

what is the

.....



protecting?

was schützt der

que protège

cosa sta proteggendo il

¿qué protege

o que está o a proteger?

mit védelmez

..... 在保护什么？



Upload your build at / Lade deine Kreation hoch in / Télécharge ta construction sur /
Carica il tuo modello su / Carga tu modelo en / Faz o upload do teu modelo em /
Töltsd fel az építményedet ide. / 在此处上传您的拼搭作品



LEGO.com/biggerthinking

LEGO Friends











































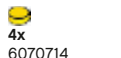







































LEGO CLASSIC



LEGO CITY



 4x 306201	 2x 6099412	 2x 4162465	 2x 4278275		 4x 300123	 4x 302324	 2x 6234162	 1x 452226
 2x 6097402	 1x 6108662	 2x 4598467	 1x 9342	 1x 303221	 2x 366623	 4x 300324	 2x 4181143	 1x 400626
 4x 6099548	 1x 6218943	 2x 4113233	 4x 300421	 4x 300523	 1x 4275815	 2x 4247771	 1x 6231761	 1x 6018805
 4x 302401	 2x 4173943	 2x 6101617	 4x 4534648	 4x 614323	 2x 9336	 4x 6070714	 6x 4517925	 1x 247926
 4x 6054551	 2x 6173943	 2x 6101617	 2x 6160161	 8x 300423	 4x 300524	 2x 366624	 2x 302326	 1x 6127159
 1x 6174310	 2x 6057517	 2x 6072998	 2x 449521	 1x 6141932	 1x 389924	 4x 301024	 4x 4617848	 6x 4107736
 2x 6060734	 4x 6175968	 2x 407021	 1x 389921	 2x 303923	 2x 6145704	 2x 4164073	 1x 6170814	 4x 300328
 4x 6069002	 4x 6029889	 2x 6030266	 2x 371021	 4x 428623	 1x 9553	 2x 300124	 4x 4541455	 4x 303928
 1x 246001	 8x 6148265	 1x 4298617	 4x 300121	 2x 302023	 1x 243224			 4x 4106356

 4x 6109752	 1x 4613756	 1x 4499885	 1x 6047056	 2x 4159007	 2x 6094069	 4x 4245570	 4x 6102975	 2x 6206249
 2x 6070756	 4x 6125776	 1x 4228126	 4x 4504371	 4x 4153826	 2x 6172932	 2x 6055241	 2x 6055086	 2x 6000066
 4x 6036238	 8x 4623598	 4x 4567332	 2x 6062601	 4x 4118827	 4x 4502089	 4x 4609925	 4x 4211190	 4x 4642934
 4x 6154879	 4x 4619514	 4x 4260942	 6x 6112356	 2x 6186381	 4x 4504374	 2x 4539060	 4x 4211225	 2x 4520320
 4x 6206150	 1x 4119479	 2x 6124858	 4x 6136553	 2x 4173332	 4x 4264569	 2x 4539071	 2x 4538252	 2x 4211429
 1x 4626724	 1x 4529755	 2x 4540865	 4x 4616279	 4x 6073026	 2x 6094143	 4x 4262655	 1x 4597642	 4x 4651063
 1x 6106160	 1x 4278013	 4x 3005748	 4x 4177932	 2x 4279734	 2x 6153589	 4x 4261397	 2x 6044706	 4x 6123809
54		 2x 3005748	 4x 4121967	 8x 4164022	 2x 6175295	 4x 4211150	 2x 4211452	 1x 4211748



1x
4258273



1x
4258275



4x
4211387



4x
6044729



4x
4211436



2x
4211363



4x
4211572



2x
4529241



2x
4558953



4x
4211758



2x
4533772



2x
4211357



1x
4599496



2x
4211718



2x
4211464



2x
4211394



2x
4515351



2x
4211361



2x
6209682



6x
4519195



2x
6172860



4x
6030472



1x
4243668



2x
6122504



4x
6073040



4x
6133823



1x
6003002



2x
6019987



3x
4210633



4x
4211042



2x
6055313



2x
4632574



2x
4211088



2x
4211104



1x
4535833



4x
6057387



4x
4622743



2x
6160819



4x
4621545



4x
6056413



2x
6231517



2x
6212978



2x
4517992



4x
6052345



2x
4520632



4x
6022083



1x
4550924



2x
6126086



4x
4653960



2x
6133818



4x
6185995



8x
6173790



3x
3005741



1x
6160341



2x
4538950



1x
6019608



1x
6197966



1x
6153590



1x
4624615



1x
6037507



1x
6076677



1x
6076604



1x
4611885



2x
4632100



2x
6064049

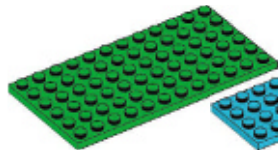

1x
4541414

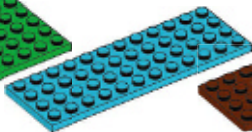

1x
6056270



1x
4271874



2x
303428

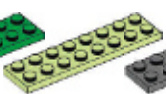

2x
6216968



2x
4210997

Customer Service

Kundenservice

Service Consommateurs

Servicio Al Consumidor

LEGO.com/service or dial



: 00800 5346 5555

: 1-800-422-5346

WIN

GO TO WWW.LEGO.COM/PRODUCTFEEDBACK AND
GIVE US YOUR SHORT **FEEDBACK** ABOUT THIS
LEGO® SET FOR A CHANCE TO WIN
A COOL LEGO PRIZE.

Terms & Conditions apply

LEGO.com/productfeedback



GEWINNE

Erzähle uns auf
www.LEGO.com/productfeedback

etwas über die Erfahrungen, die du mit
diesem LEGO® Set gemacht hast, und
sichere dir die Chance auf einen coolen
LEGO Preis!

Es gelten die Teilnahmebedingungen

GAGNE

Rends-toi sur
www.LEGO.com/productfeedback

et donne-nous quelques commentaires sur
ce produit LEGO® pour avoir une chance
de gagner un prix LEGO !

Voir Conditions Générales

GANAN

Visita
www.LEGO.com/productfeedback

y envíanos tu opinión acerca de este set
LEGO®. ¡Participarás en el sorteo de un
premio LEGO!

Términos y Condiciones aplicables

获取奖品

登录
www.LEGO.com/productfeedback

给出关于此乐高®套装的简短反馈，
就有机会获得炫酷乐高奖品

《条款及条件》适用