





STILLE GLISTO CLASSE

"Anche se non sei pronto per vivere a tutto volume, alzalo a metà e arriva alla tua meta".

- Bobby Berk

QUEER EYE

PIÙ DI UN MAKEOVER

Mentre tanti reality show si occupano di criticare le persone, *Queer Eye* preferisce migliorare le persone. I Fab Five usano le proprie esperienze personali – sia positive sia negative – per avere un impatto costruttivo e duraturo su ogni singola persona, o "eroi", come vengono chiamati dai Fab Five.

Unisciti alle minifigure dei Fab Five nella versione LEGO® del loro loft originale ad Atlanta. Sono tutti qui: lo stilista Tan France, l'esperto di cultura Karamo Brown, lo specialista di enogastronomia Antoni Porowski, l'interior designer Bobby Berk e il consulente di toelettatura Jonathan Van Ness, e hanno bisogno del tuo aiuto per portare a termine la loro ultima trasformazione. Buon divertimento!





"Come stilista, il mio obiettivo è aiutare le persone a essere la versione migliore di se stesse".

- Tan France



TAN FRANCE

MODA



Nato a Doncaster, South Yorkshire, Inghilterra, da genitori pakistani, Tan France ha iniziato a lavorare negli Stati Uniti nel 2008 e ora vive a Salt Lake City, Utah. In qualità di stilista ed esperto di moda, Tan si occupa del makeover del guardaroba della persona prescelta. Il più delle volte, completa ogni magico restyling con il suo famoso French Tuck!



"Il cibo può offrire un momento di puro piacere emotivo in un mondo altrimenti duro e difficile".

- Antoni Porowski

ANTONI POROWSKI

ENOGASTRONOMIA



Figlio di immigrati polacchi, Antoni è cresciuto a Montreal, in Canada, parlando polacco, inglese e francese. Dopo essersi trasferito negli Stati Uniti, ha studiato psicologia e teatro prima di dedicare il suo talento alla cucina. Prima di entrare a far parte dei Fab Five, incoraggiando le persone a cucinare indipendentemente, ha lavorato per Ted Allen, l'esperto di gastronomia dell'originale "Queer Eye" dei primi anni 2000.



KARAMO BROWN

CULTURA

Karamo Brown è il life coach e terapeuta del gruppo. Aiuta gli "eroi" dello show a capire se stessi, incoraggiandoli a superare le avversità che hanno dovuto affrontare e che hanno radicalmente cambiato la loro vita. Nato a Houston, nel Texas, e di origini giamaicane e cubane, Karamo ora vive a Los Angeles con i suoi due figli ed è un attivista della comunità LGBT nera.



"La vita non succede. La vita risponde a quello che fai".

- Karamo Brown





"Quando sei contento a casa, questa felicità invade ogni altra area della tua vita".

- Bobby Berk



BOBBY BERK

DESIGN

Bobby è cresciuto in una piccola città del Missouri. Nel 2003 si è trasferito a New York con soli 100 dollari in tasca. Si è fatto strada fino a diventare direttore creativo di un'azienda di arredamenti per la casa prima di lanciare il suo negozio online. Nella serie di Netflix *"Queer Eye"*, Bobby rinnova gli spazi abitativi degli eroi per aiutarli a trasformare le loro vite.

*"Il modo in cui ti prendi
cura di te stesso è il modo
in cui il mondo ti vede".*

- Jonathan Van Ness



JONATHAN VAN NESS

TOELETTATURA

In qualità di entusiasta "cheerleader" del team dei Fab Five, Jonathan incoraggia gli eroi dello spettacolo a dedicare del tempo esclusivamente alla propria persona attraverso momenti di toelettatura e cura di sé personalizzati. Quando non si occupa delle acconciature delle persone su "Queer Eye", Jonathan è l'ospite di una serie di podcast pluripremiati e un grande fan della ginnastica e del pattinaggio artistico – si dice persino che Jonathan sia in grado di eseguire il toe-loop e il salto Axel sul ghiaccio!





Bruley era l'adorabile bulldog francese delle stagioni 3-4. È purtroppo scomparso nel 2019, ma è ora immortalato sotto forma di mattoncini LEGO®.



OGNI OSPITE È UN EROE

Ogni eroe di *Queer Eye* ha una storia speciale da raccontare. Alcuni hanno dovuto affrontare traumi come la perdita di una persona cara, oppure un grave problema medico o l'ostracismo da parte della famiglia. Altri hanno dato tantissimo ad altre persone e alle loro comunità locali, e hanno avuto poco tempo da dedicare a se stessi. Sono tutti eroi dei Fab Five e tutti meritano una trasformazione che renderà le loro vite più facili, più sane e più felici.



L'OSPITE DI QUESTA SETTIMANA

Non sarebbe un vero e proprio set LEGO® *Queer Eye* se qualcuno non venisse sottoposto a un magico restyling! Incontriamo Kathi Dooley, un'insegnante che ha svolto

un ruolo speciale nei primi anni di vita di Jonathan, sostenendolo con comprensione e gentilezza. Ora è giunto il momento per Jonathan e gli amici di ripagarla...

Makeover LEGO di Kathi Dooley



Prima

Dopo



Le fantastiche abilità nel design di Bobby sono cominciate ad affiorare quando era bambino... con un set LEGO!

PIÙ DI UN MAKEOVER

UNA VERA COLLABORAZIONE!

Questo set LEGO® *Queer Eye* è il risultato di una vera collaborazione in stile Fab Five tra il team di design LEGO e il guru del design dello show, Bobby Berk. Per Bobby il progetto è diventato rapidamente una passione: "Le costruzioni LEGO hanno avuto un ruolo così importante nella mia infanzia. Collegare i mattoncini ha davvero acceso la mia immaginazione e creatività". Matthew Ashton, Vice President of Design di LEGO, considera la collaborazione una partnership perfetta: "Condividiamo così tanti valori, come prendersi cura delle persone, l'apprendimento, la creatività e il divertimento. Mentre i Fab Five ricostruiscono la vita delle persone, la nostra missione è ispirare bambini e adulti a diventare creativi e partecipare alla ricostruzione di un mondo più positivo".



Il primo compito è stato decidere che tipo di set sarebbe dovuto essere. Il team si è rapidamente concentrato sull'ambientazione nel loft originale della prima stagione, determinando la planimetria e il layout del modello. Per Matthew è stato fondamentale catturare quanti più dettagli possibili: "Volevamo replicare i mobili, includendo dettagli famosi come l'insegna 'STYLE, TASTE, CLASS'. Abbiamo anche voluto includere una zona distinta per ciascuno dei ragazzi, utilizzando le competenze e i contributi dei Fab Five alla squadra".

*"Collaborare con il team
LEGO è stato un mio
vecchio sogno che si è
avverato! Sarebbe il sogno
di qualsiasi bambino e per
me è diventato realtà".*

- Bobby Berk



Bobby e Matthew nelle fasi iniziali del processo di design.



I PEZZI DEL PUZZLE

Proprio come per i Fab Five, il lavoro di squadra è una parte essenziale dello sviluppo di un fantastico set LEGO®. Gli altri membri del Dream Team LEGO di Matthew sono stati il Senior Graphic Designer, Diego Sancho, e il Senior Element Designer, Ruth Kelly.

Diego ha avuto l'importante compito di catturare la somiglianza dei Fab 5 sotto forma di minifigure LEGO, oltre a progettare tutte le decorazioni e gli adesivi per dare vita al loft: "Ho avuto l'opportunità di sviluppare la mia versione personale dell'artwork del loft, aggiungendo qualche sorpresa qui e lì per i fan! Ho creato una stampa 'Yaaas Queen' per la cucina per celebrare il divertente motto LGBTQ+, e se osservate da vicino la grafica delle pennellate, vi accorgete che recita FAB 5!"

Per Ruth, la sfida è stata molto diversa: "Non avevamo capelli con una acconciatura così voluminosa come quella di Tan e quindi ho dovuto crearne una completamente nuova. Abbiamo deciso di modellare i capelli in plastica argentata scintillante per 'elevare' davvero il look di Tan!"

Matthew è orgoglioso del set finito e di ciò che la partnership ha rappresentato: "I Fab Five hanno avuto un impatto così positivo sulla vita di tante persone. È importante dedicare del tempo a essere gentili con gli altri e questa collaborazione è stata il modo perfetto per dimostrare questa filosofia".



Da sinistra a destra:
Ruth Kelly, Senior Element Designer
Matthew Ashton, Vice President of Design
Diego Sancho, Senior Graphic Designer



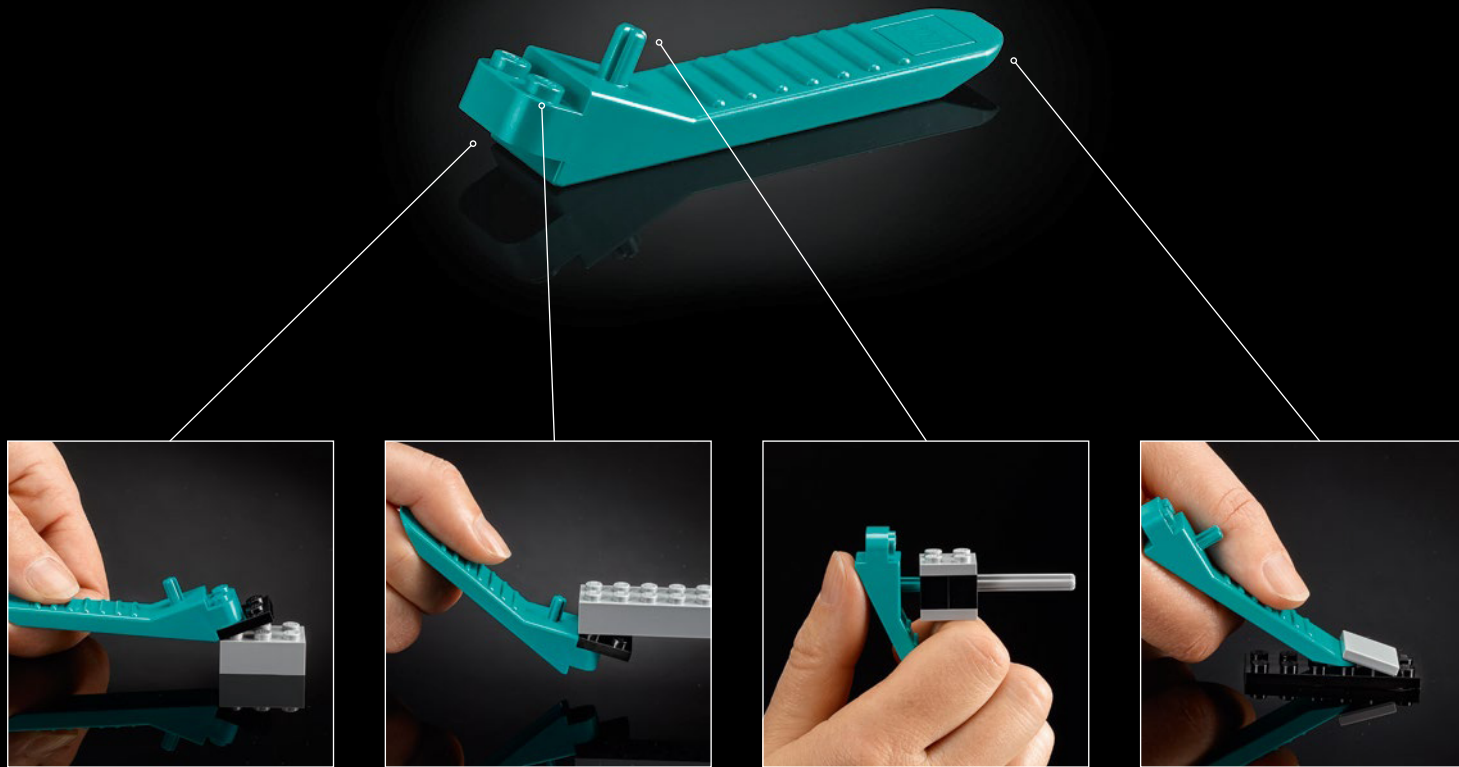

[LEGO.com/brickseparator](https://www.lego.com/brickseparator)

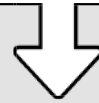
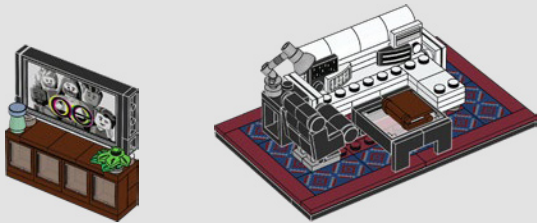
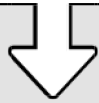

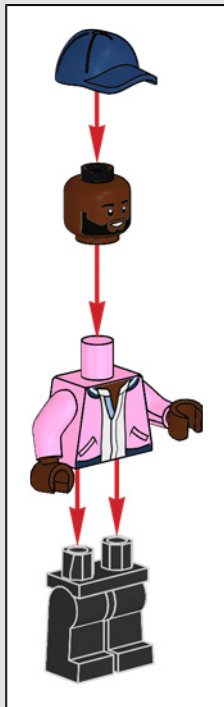
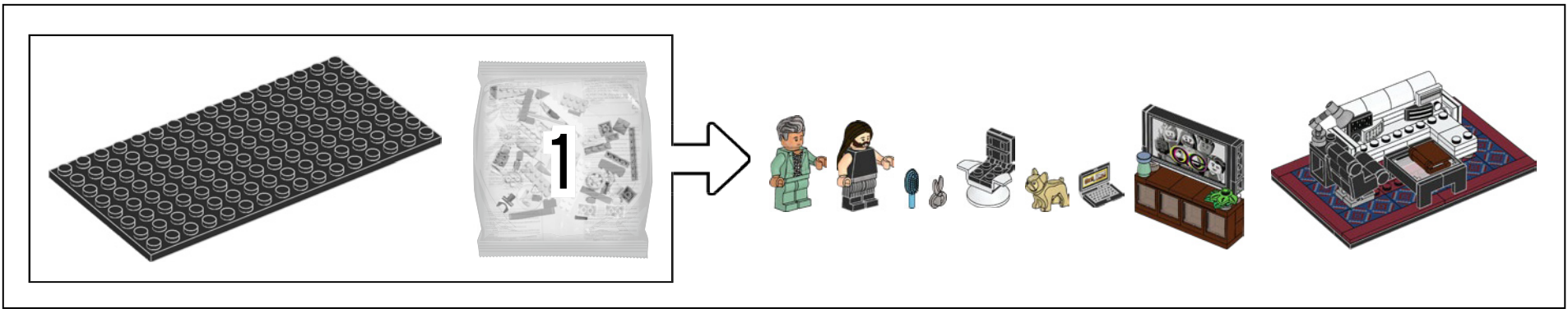

Karamo Brown

"Sono contento che mi abbiano fatto indossare il caratteristico bomber di Karamo e il berretto da baseball per coprire quell'antiestetico bernoccolo sulla testa è stata un'ottima scelta! Ha!"

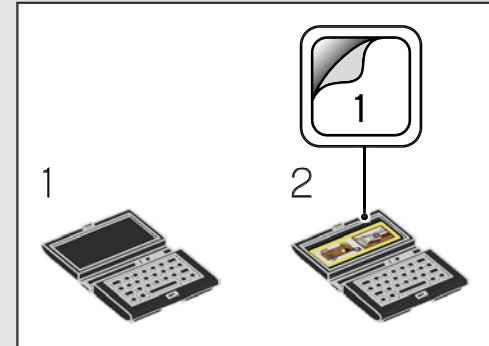

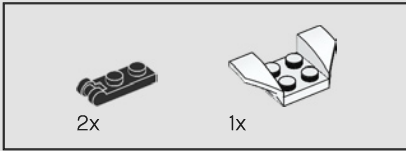
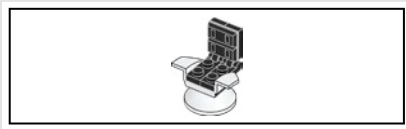

1

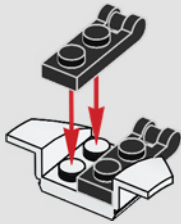

2

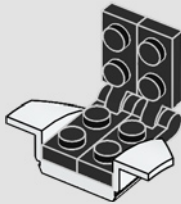

3

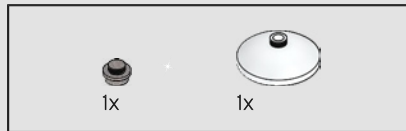
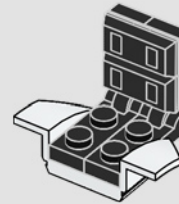

4

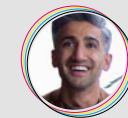
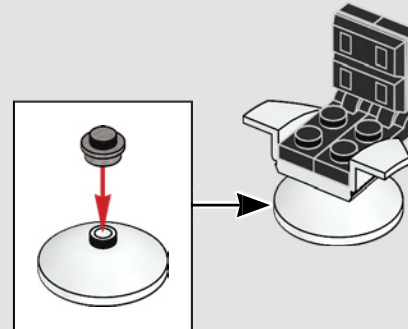

Tan France

"Ha! Quei capelli LEGO® sono pura perfezione! E proprio come i miei veri capelli... una volta applicata la lacca non si spostano di un centimetro".



Jonathan Van Ness

"I nostri personaggi LEGO non potrebbero essere più carini!"

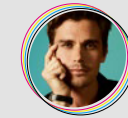

Antoni Porowski

"È così carino che hanno incluso anche Bruley! Mi manca il mio piccolo Pupperoni!"

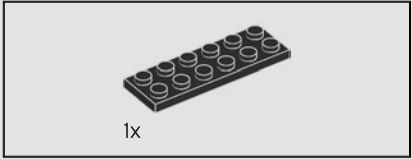
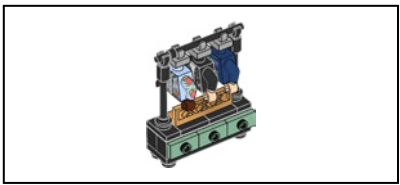

1

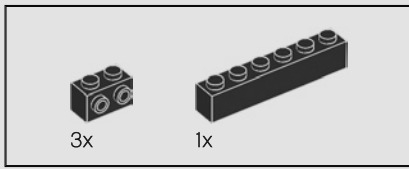
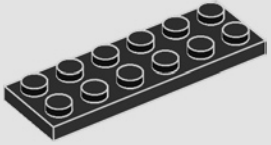

2

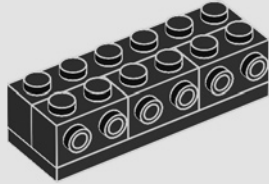

3

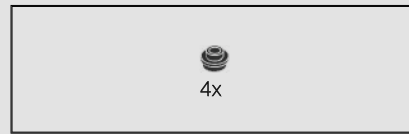
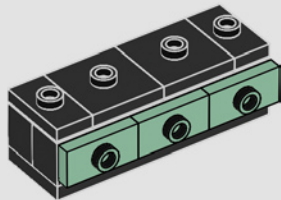

4

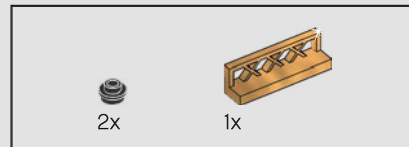
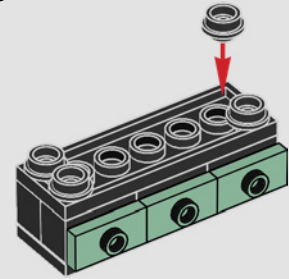
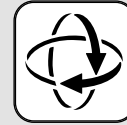

5

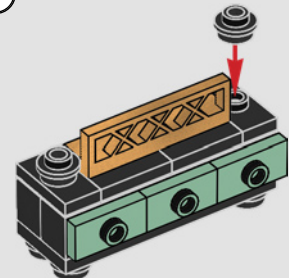
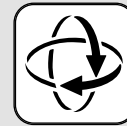



6

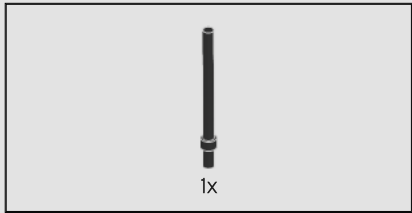
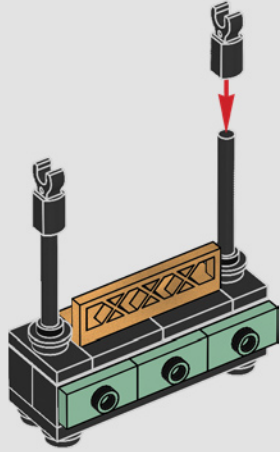

7

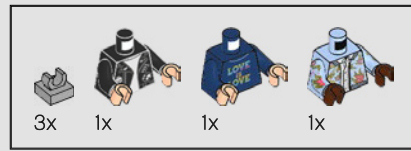
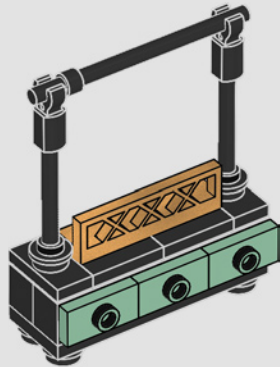

8

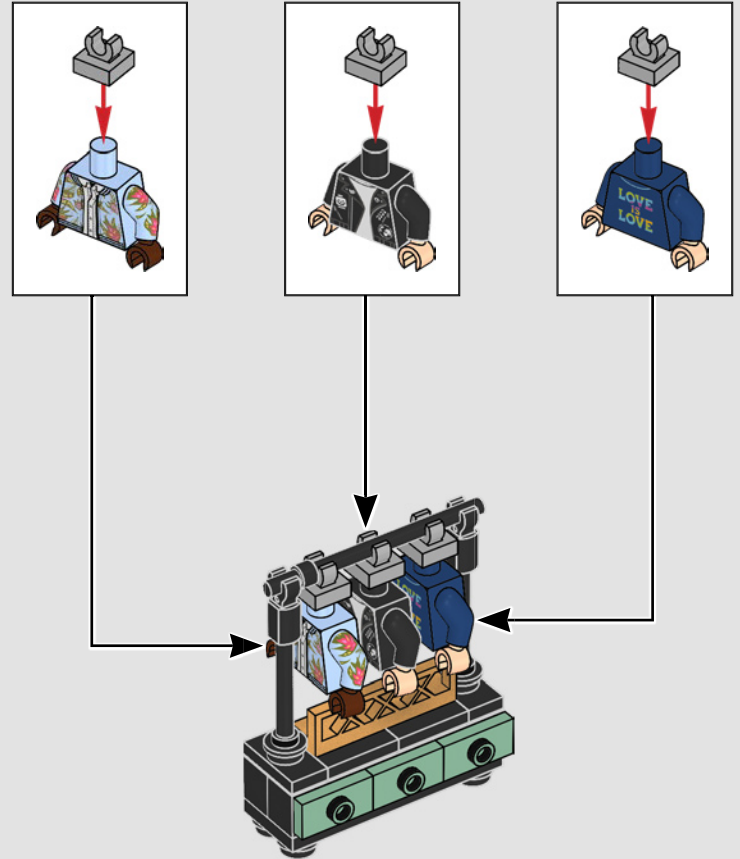

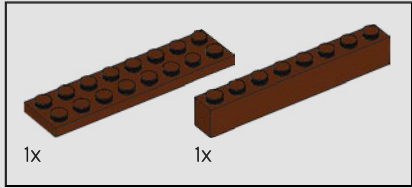

1

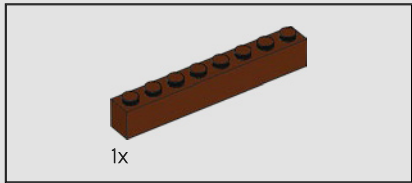
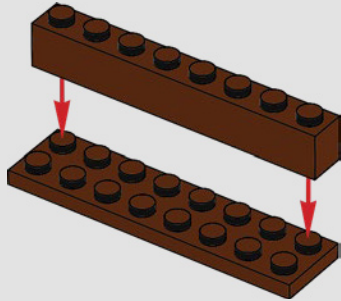

2

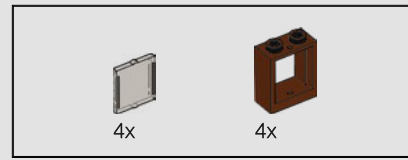
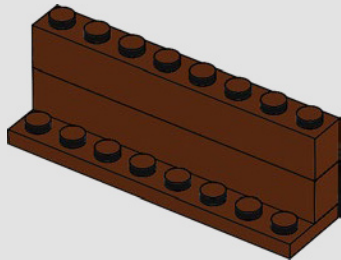

3

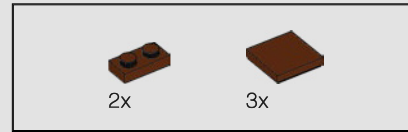
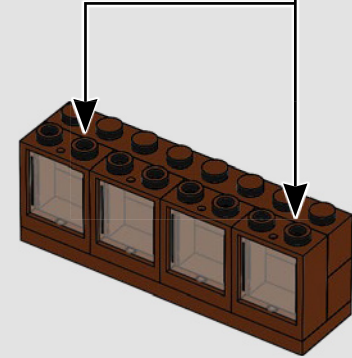
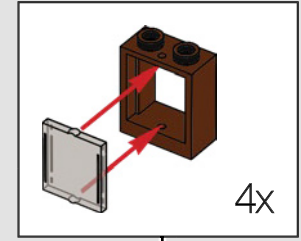

4

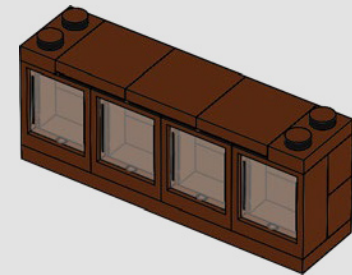



5

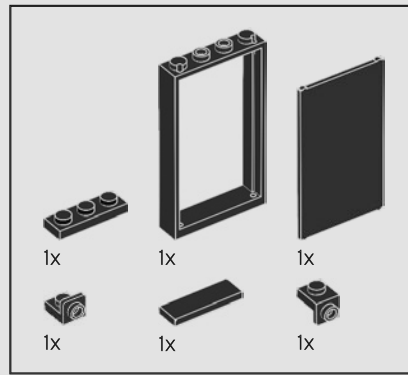
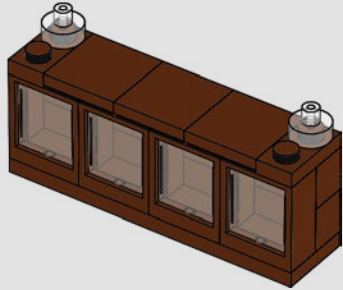

6

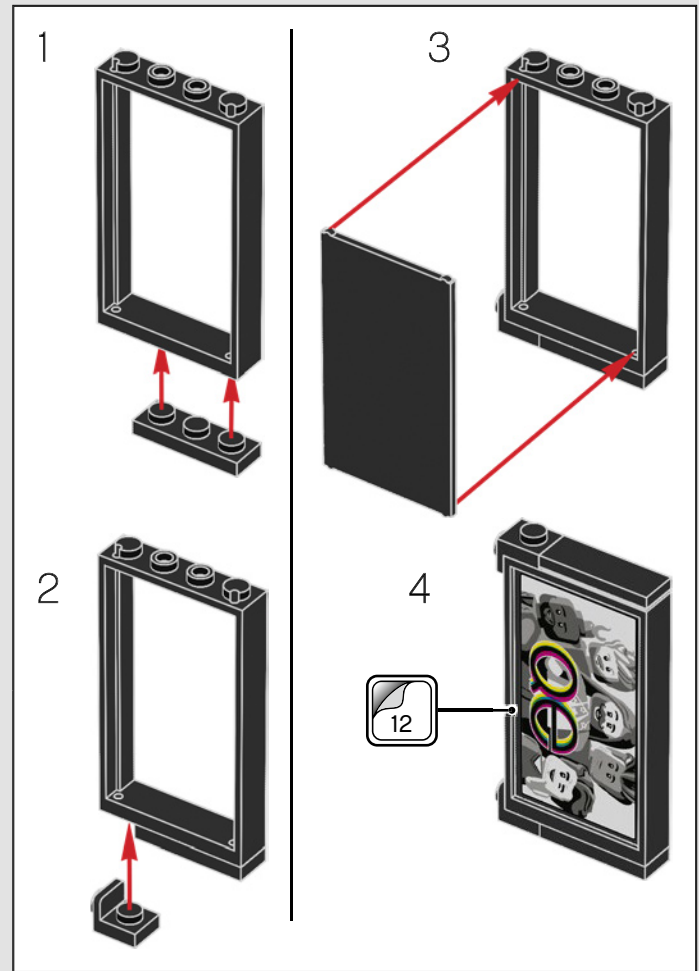
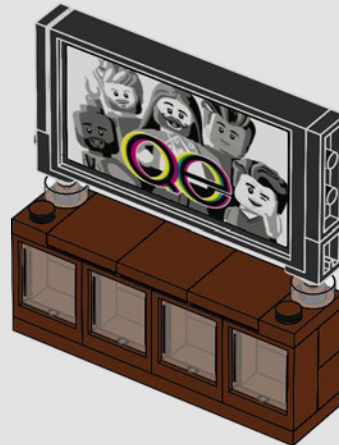

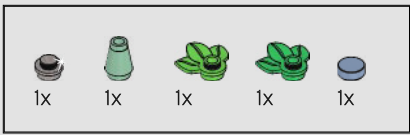

7



Jonathan Van Ness

"È così importante che l'inclusione sia incorporata nella creatività delle persone. Quindi, è fondamentale che l'azienda LEGO mostri supporto per argomenti come l'inclusività LGBTQ, e quindi sono entusiasta che questo sia accaduto".

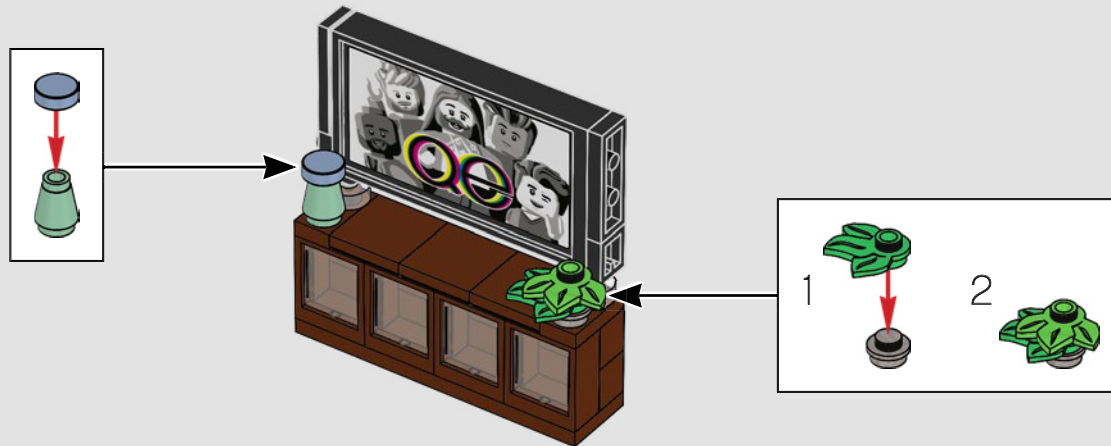

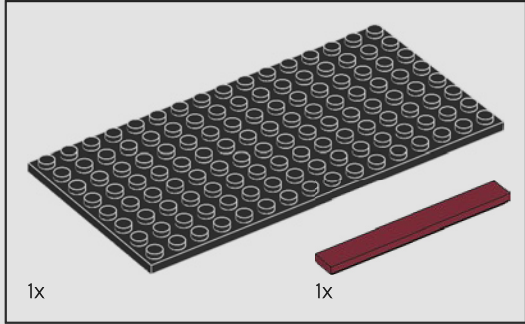
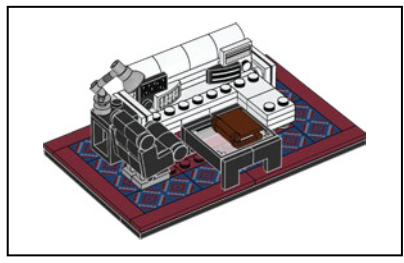

1

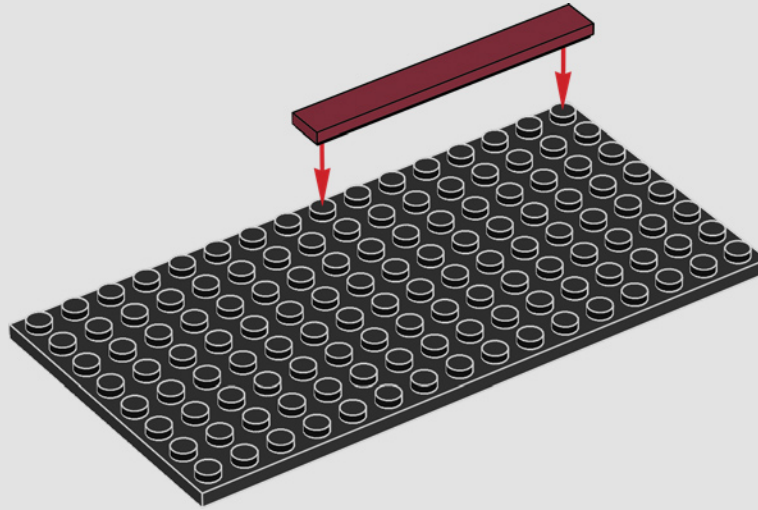

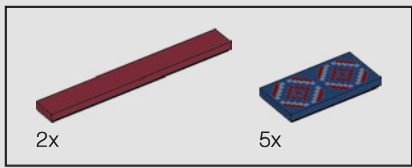

2

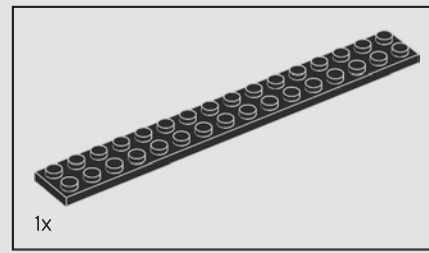
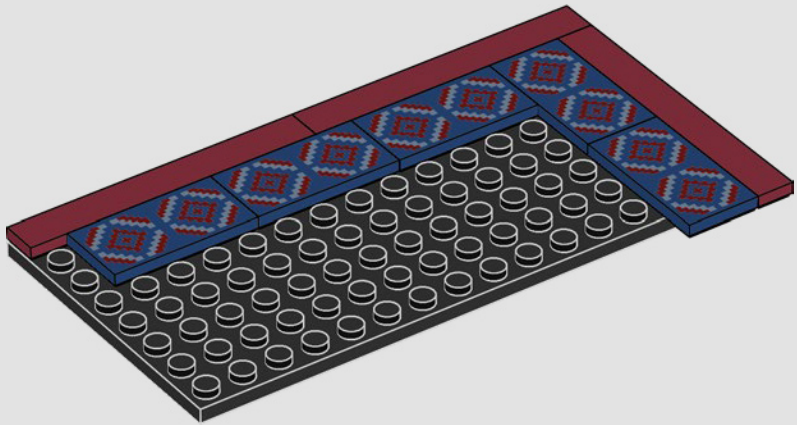

3

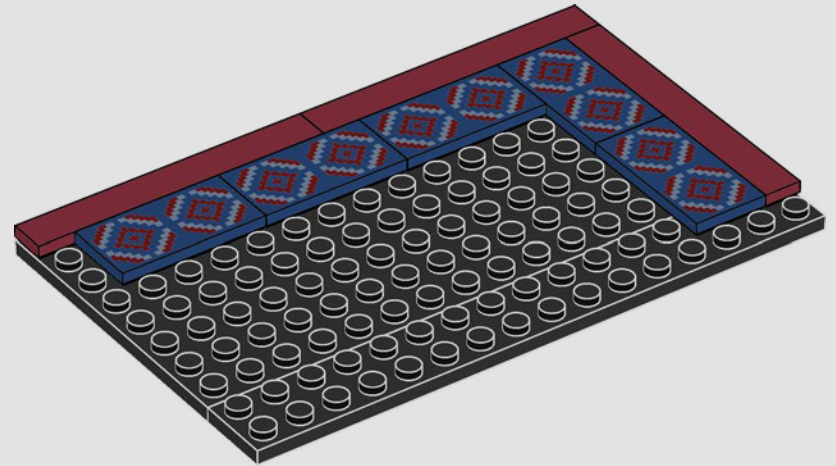

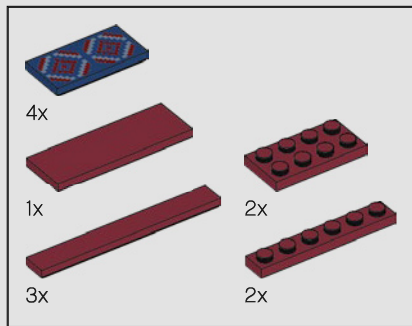

4

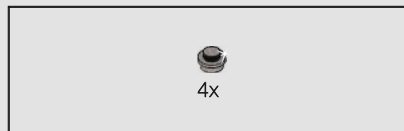
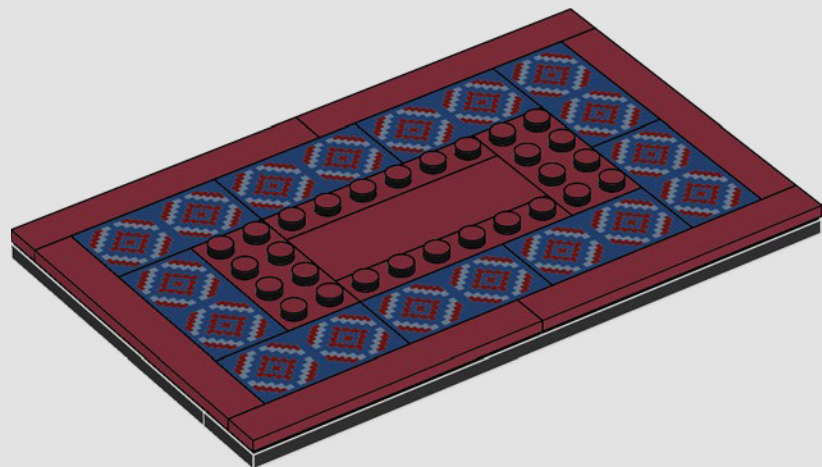

5

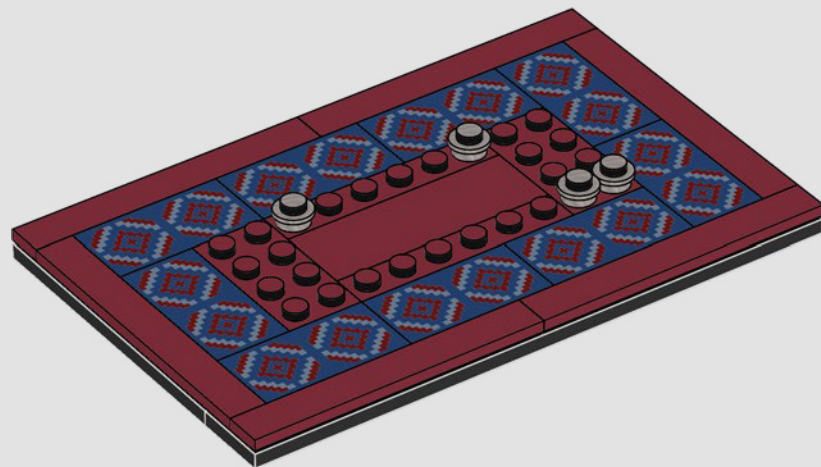

Jonathan Van Ness

"Far parte dell'immaginario delle persone che creano un mondo migliore è fantastico! Spero che le persone possano stimolare la loro immaginazione con questa collaborazione".

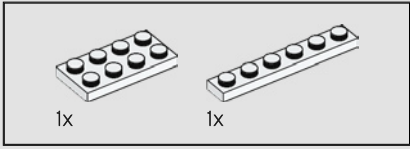
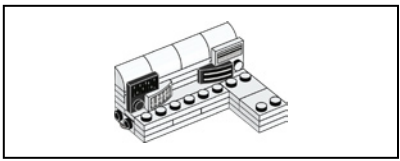

6

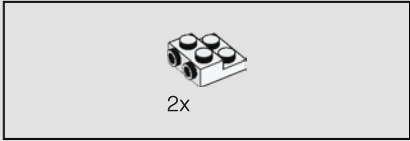
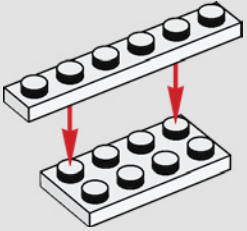

7

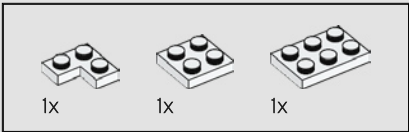
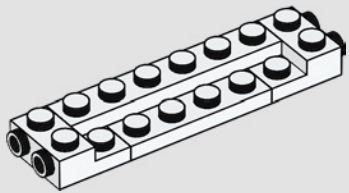

8

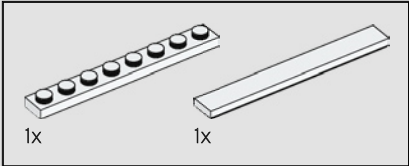
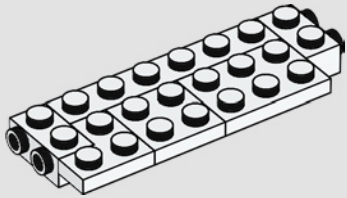

9

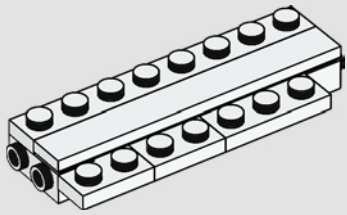

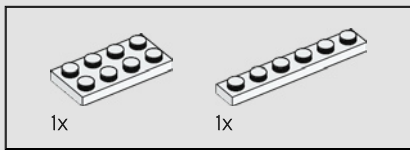

10

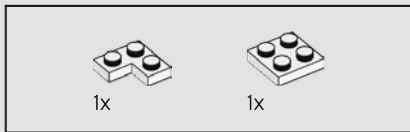
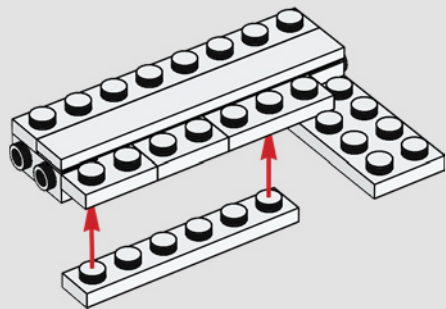

11

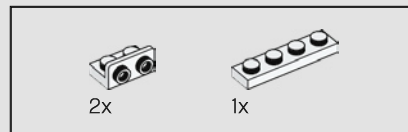
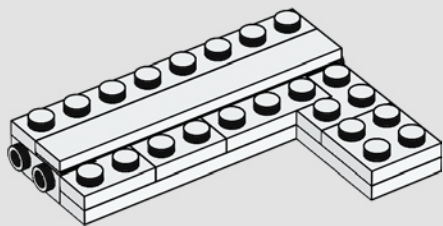

12

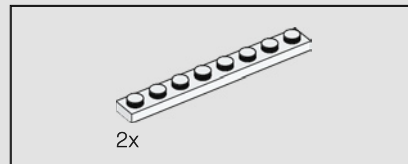
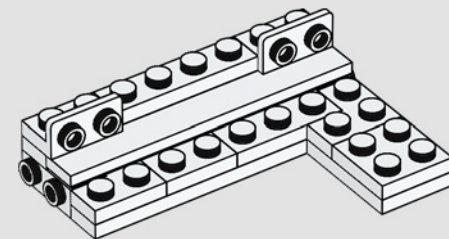

13

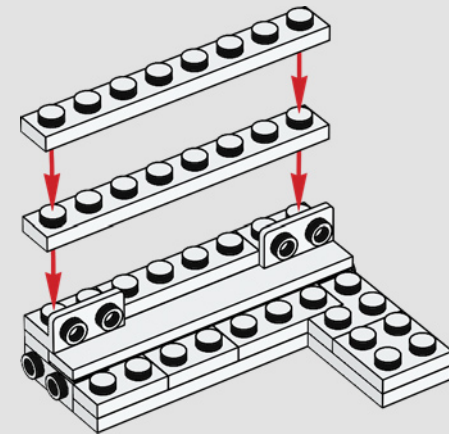

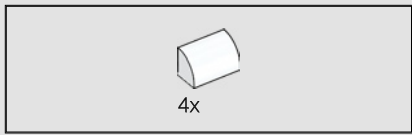

14

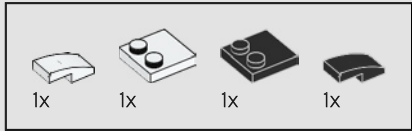
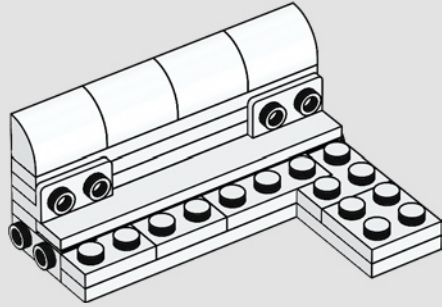

15

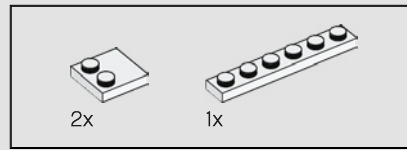
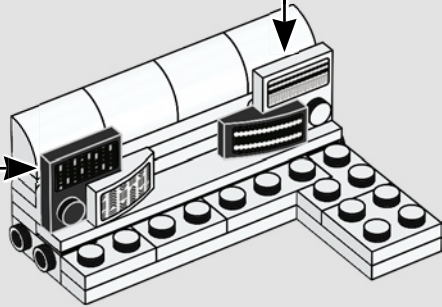
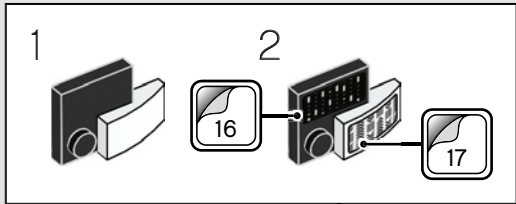
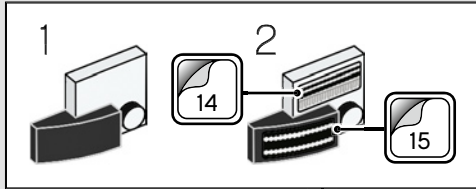

16

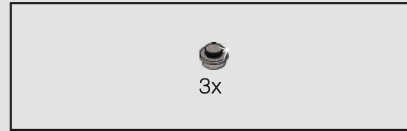
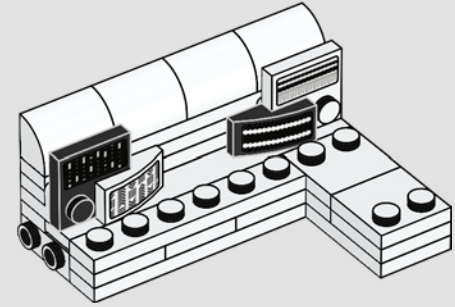

17

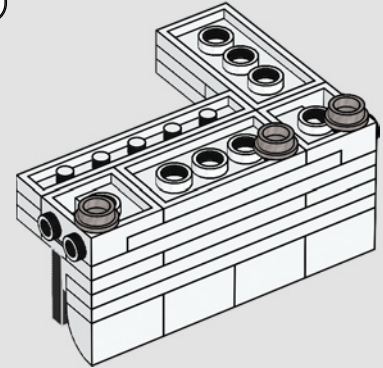
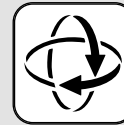

18

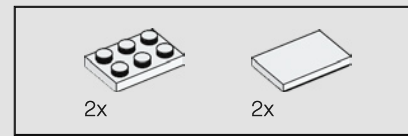
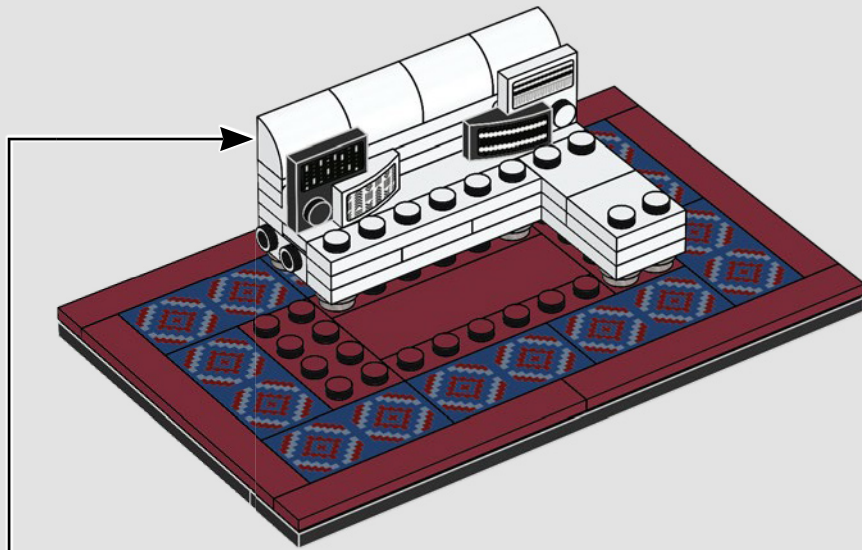

19

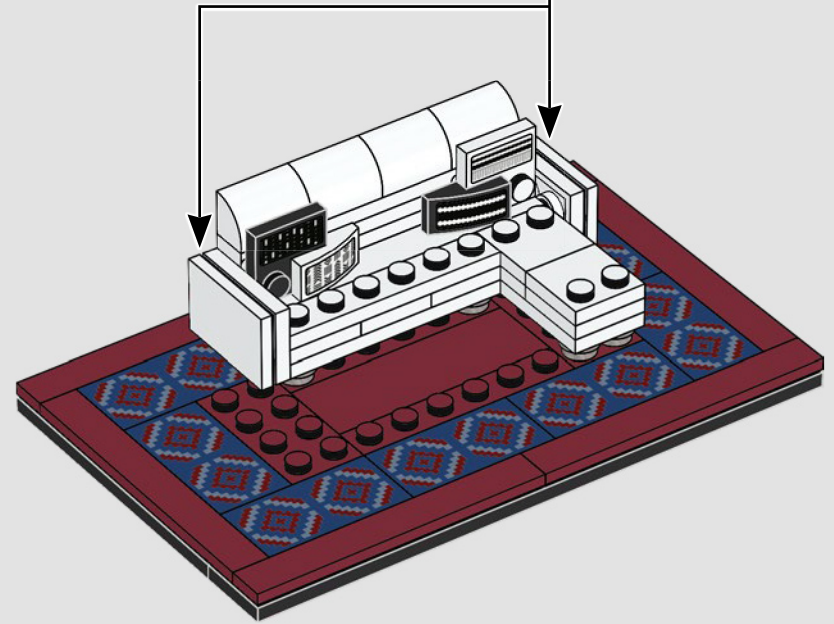
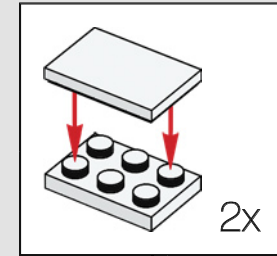

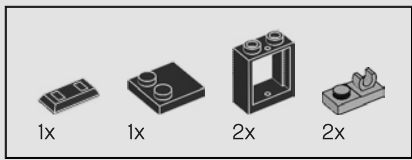

20

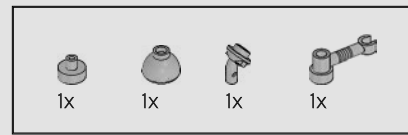
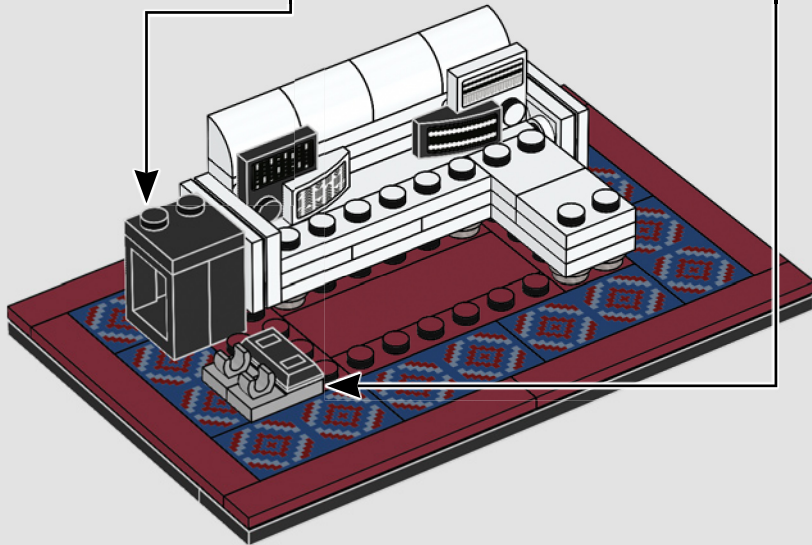
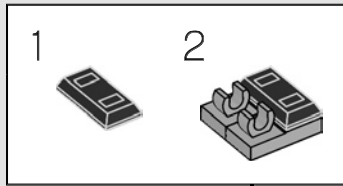
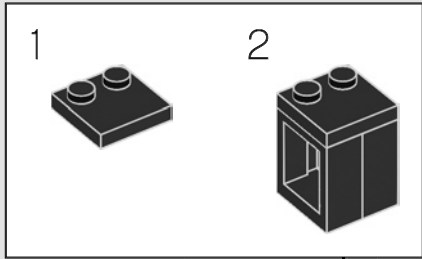

21

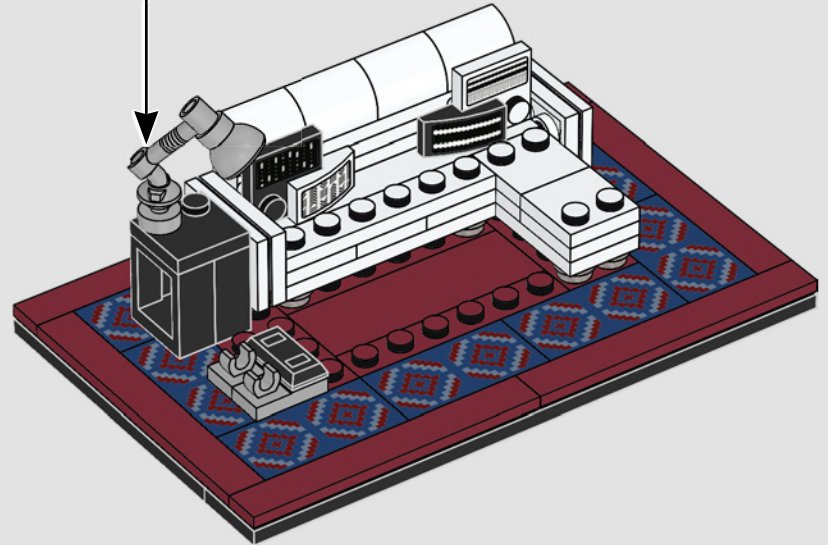
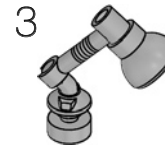
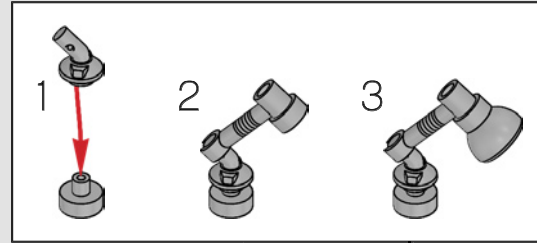

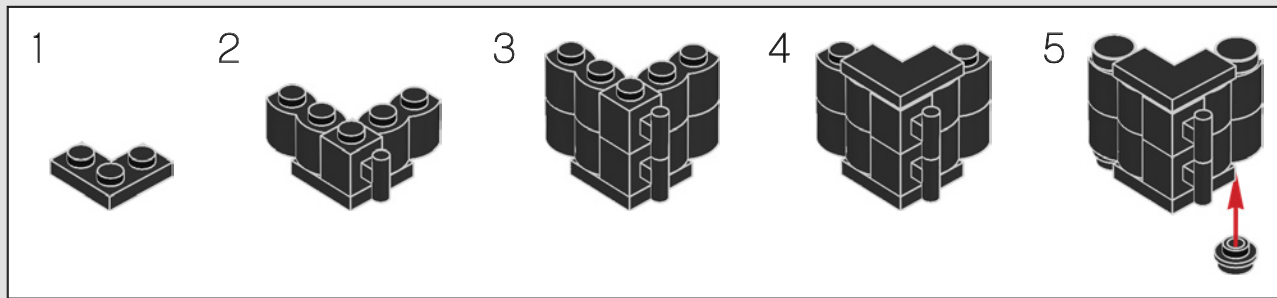
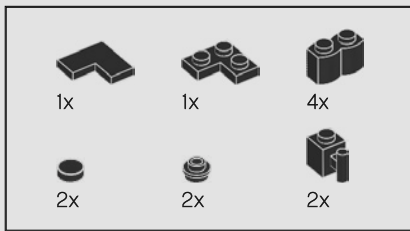

22

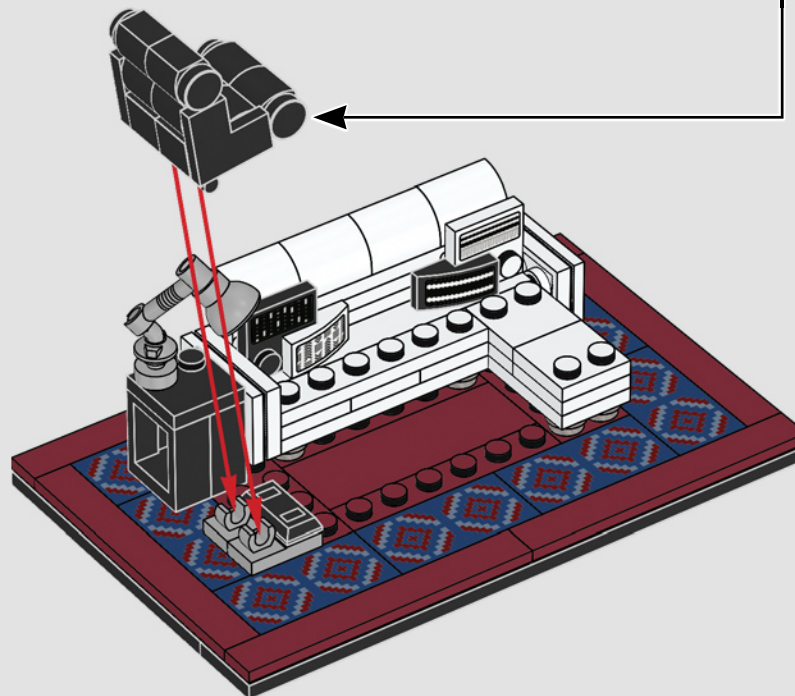

Tan France

"Adoro i processi creativi e i mattoncini LEGO® sono perfetti per liberare questa creatività... puoi costruire quello che vuoi nel tuo stile unico."

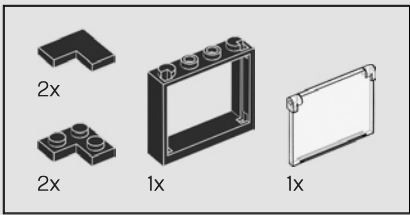

23

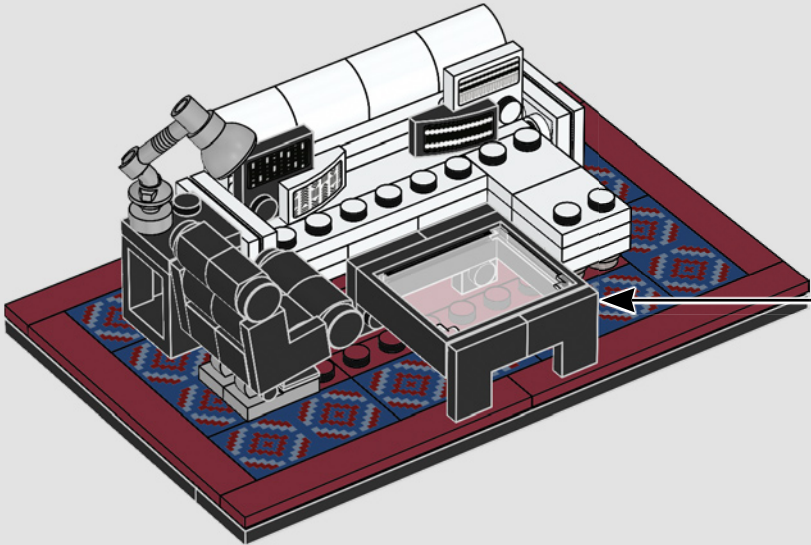
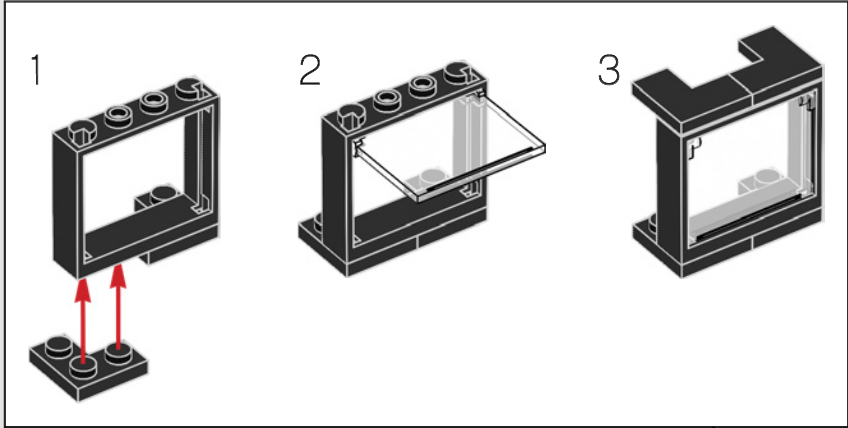

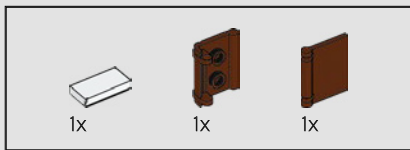

24



Karamo Brown

"Vedere questo set mi riporta alla mente tanti ricordi felici. È come essere stato miniaturizzato, con la possibilità di rivivere lo show!"

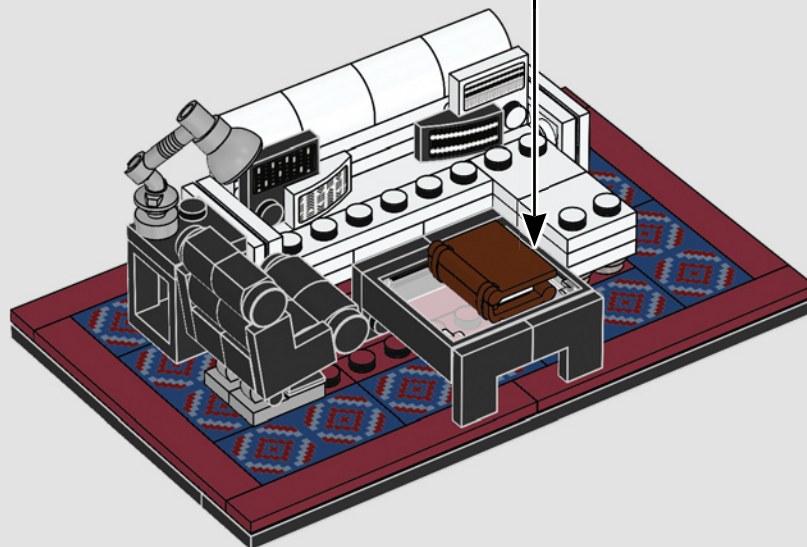
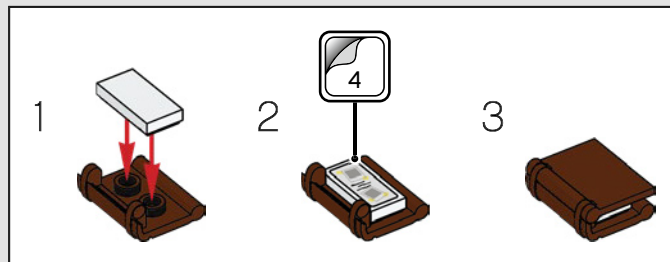

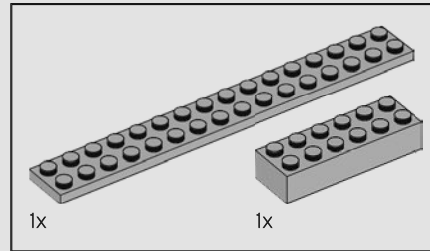
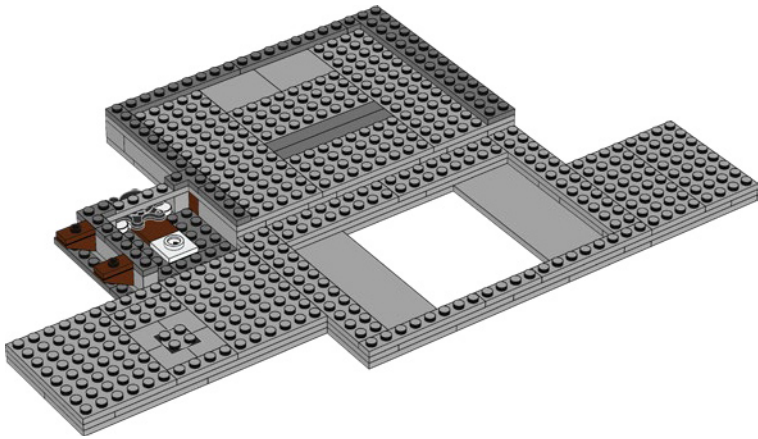
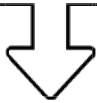

1

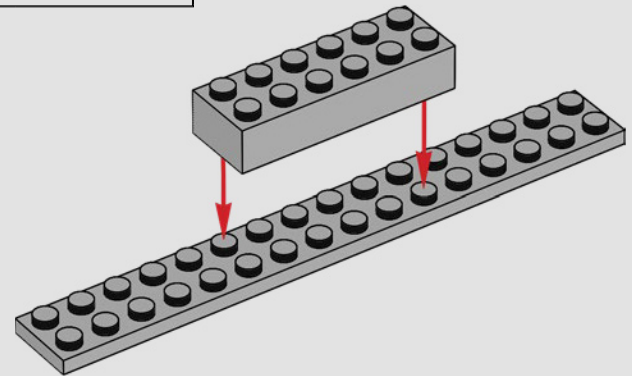

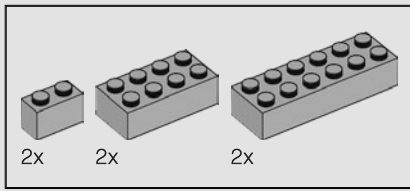

2

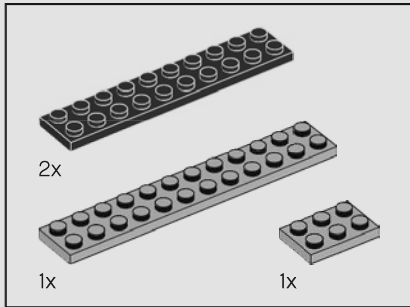
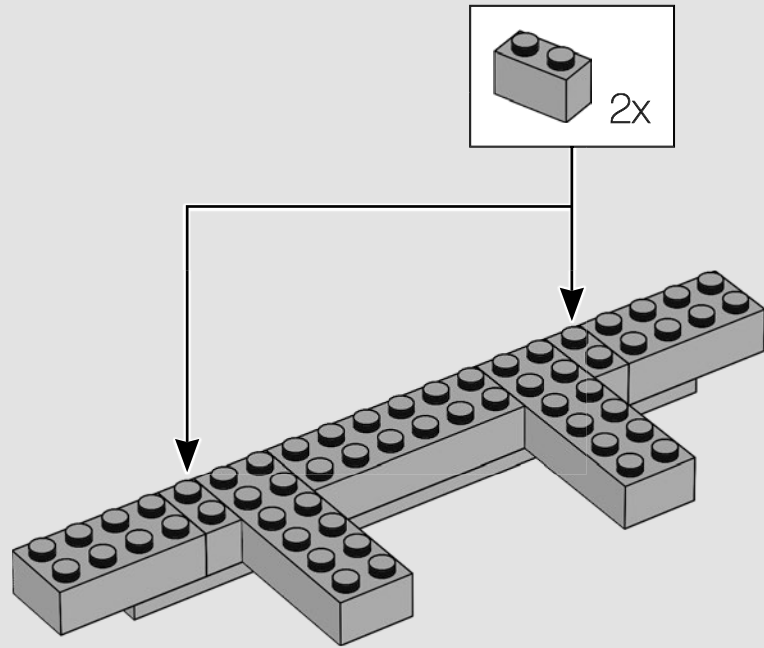

3

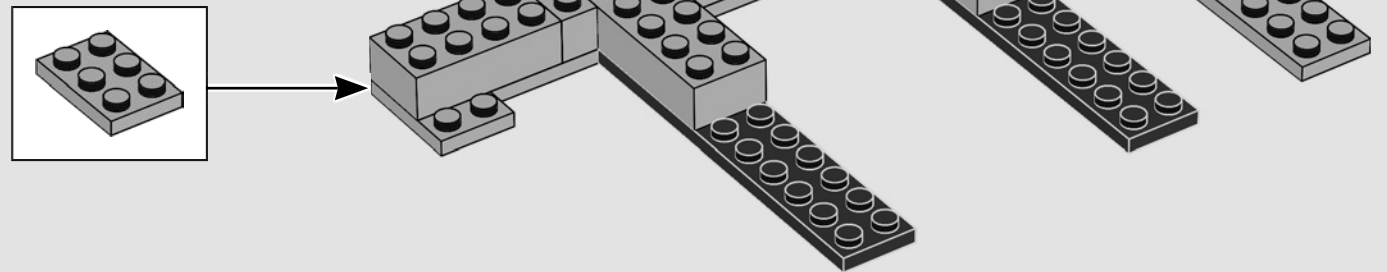

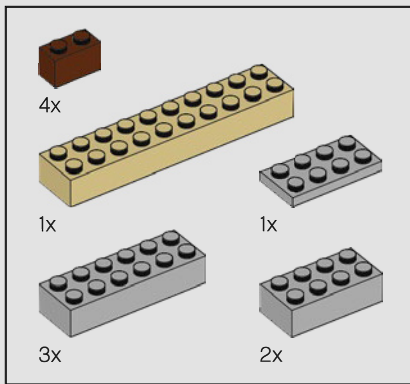

Karamo Brown

"Queer Eye è speciale per via delle persone; l'incredibile cast con cui lavoro ogni giorno e le bellissime vite che posso toccare e con cui posso interagire nello show, condividendo ogni cosa con il mondo".

4

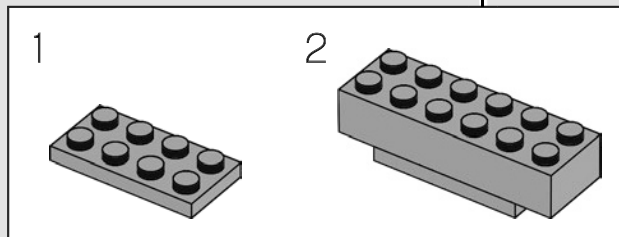
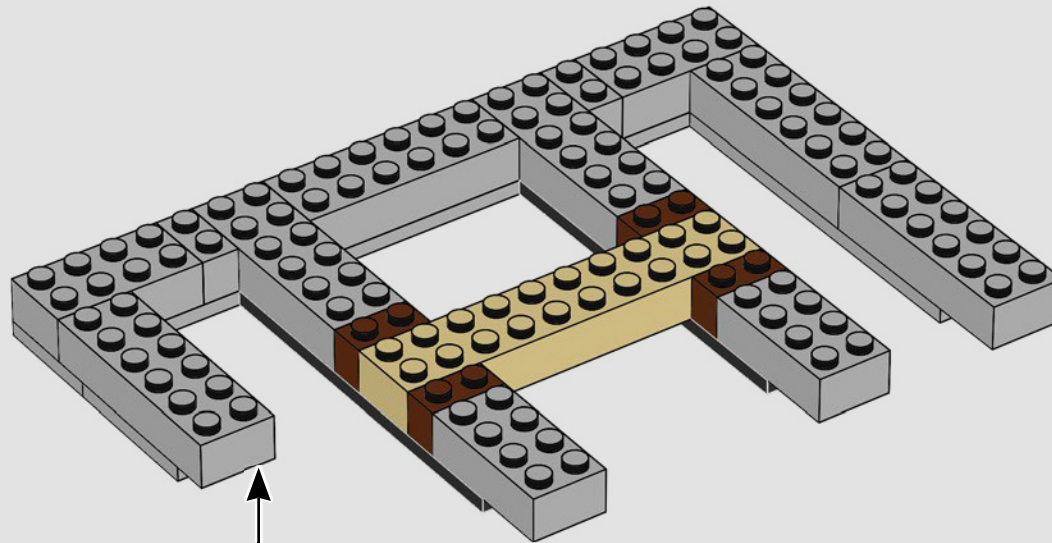

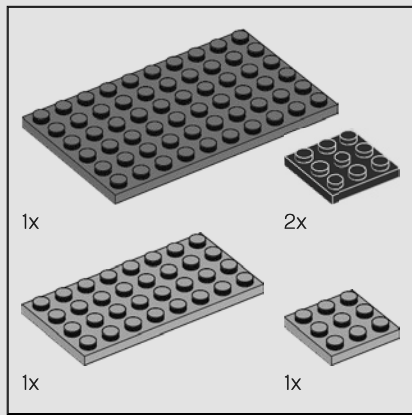

5

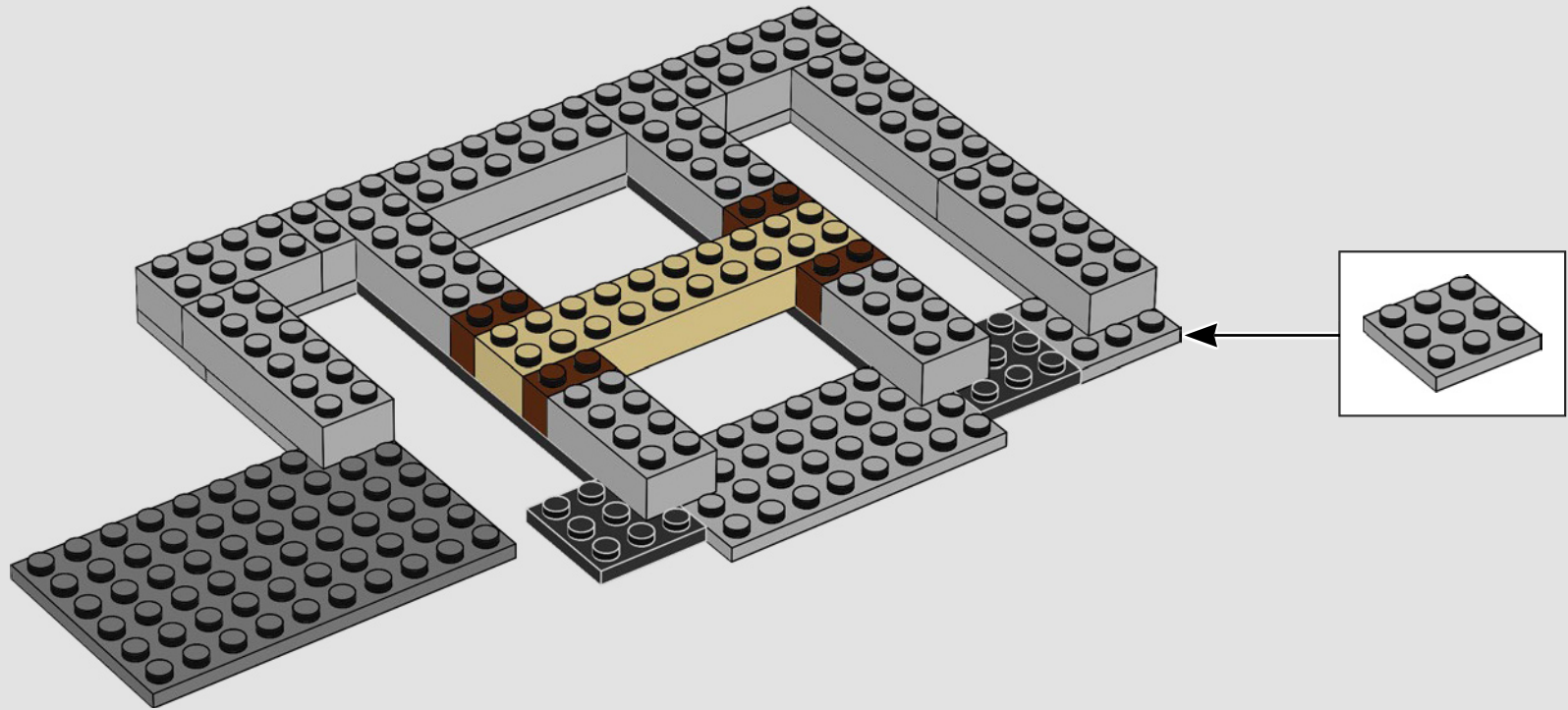

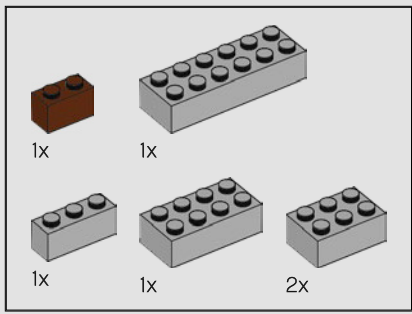

6

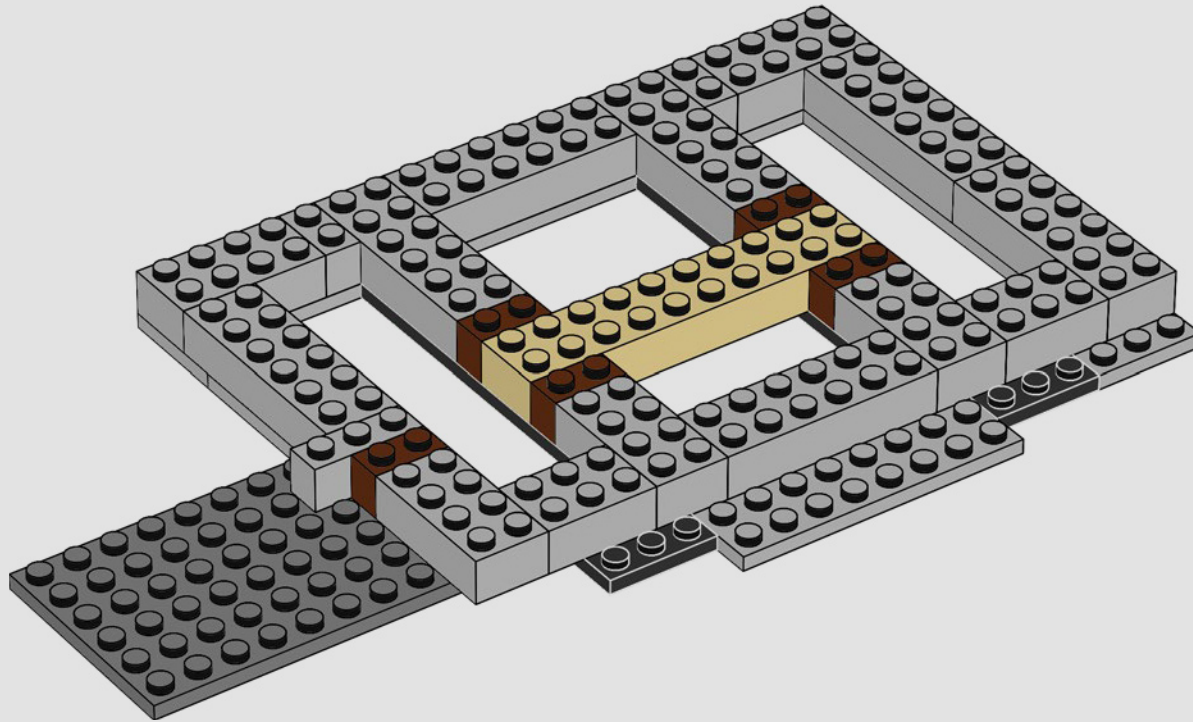

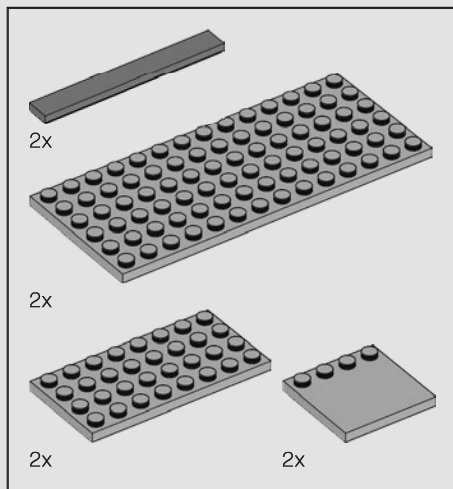

7

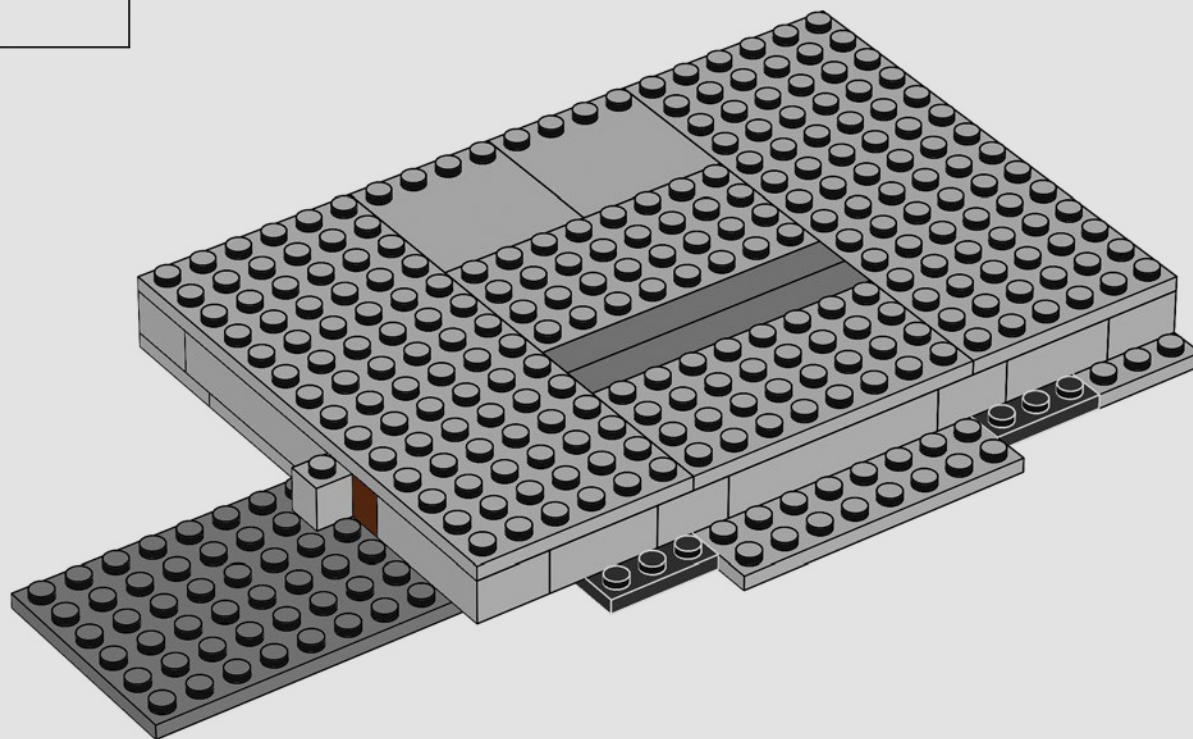

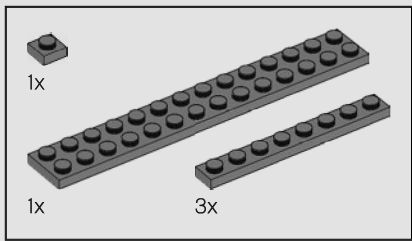

8

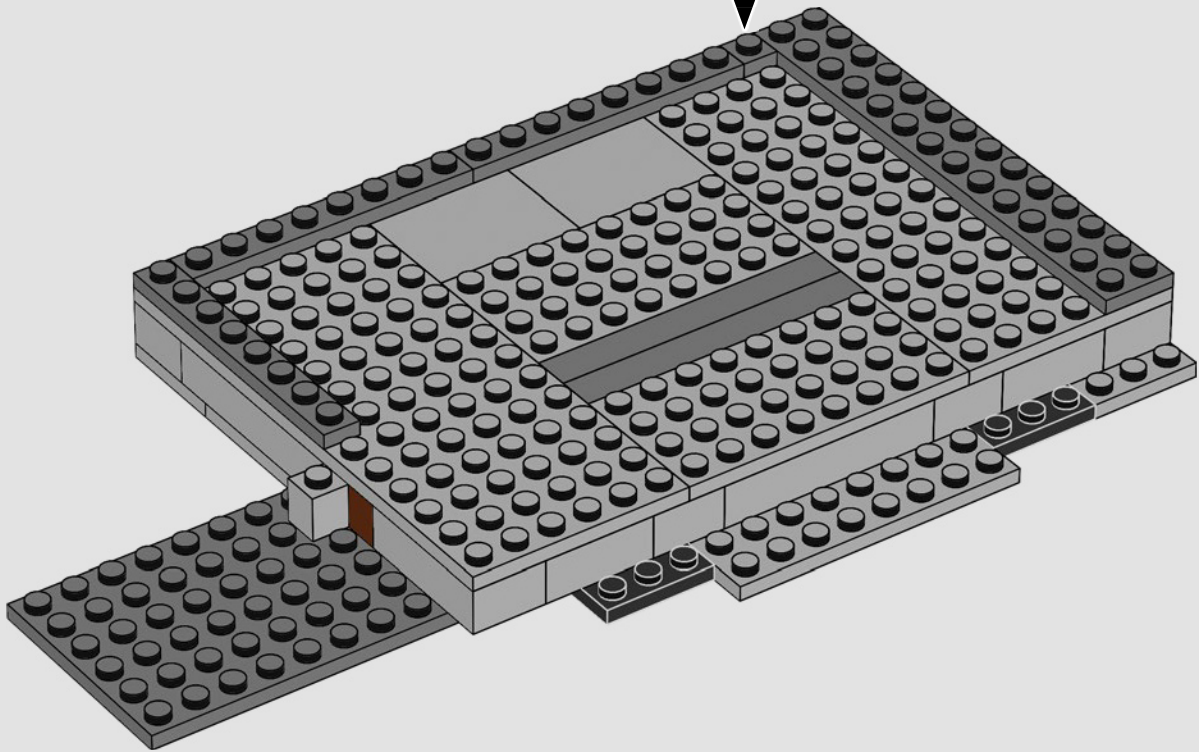
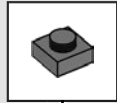

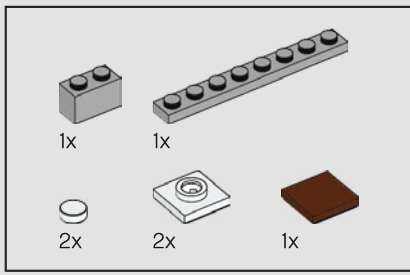

9

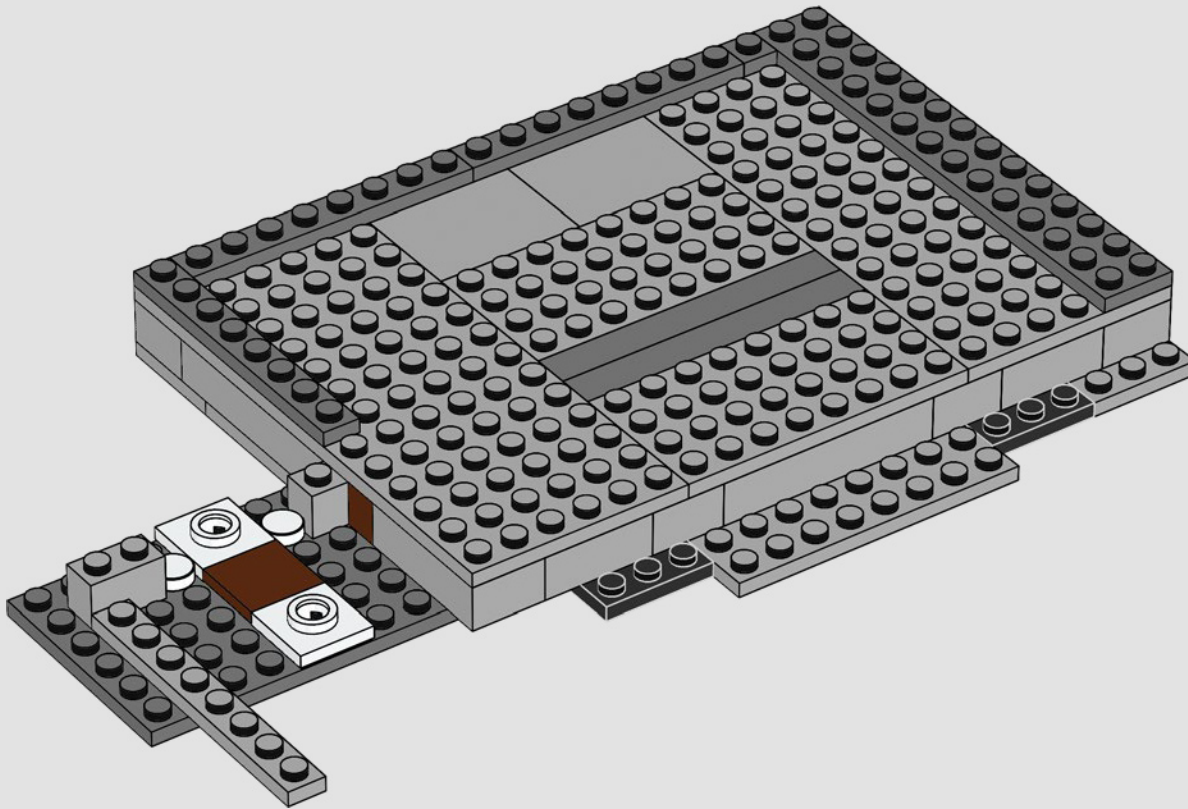

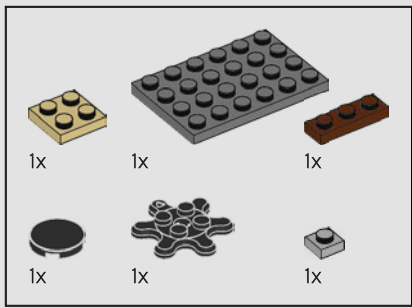

10

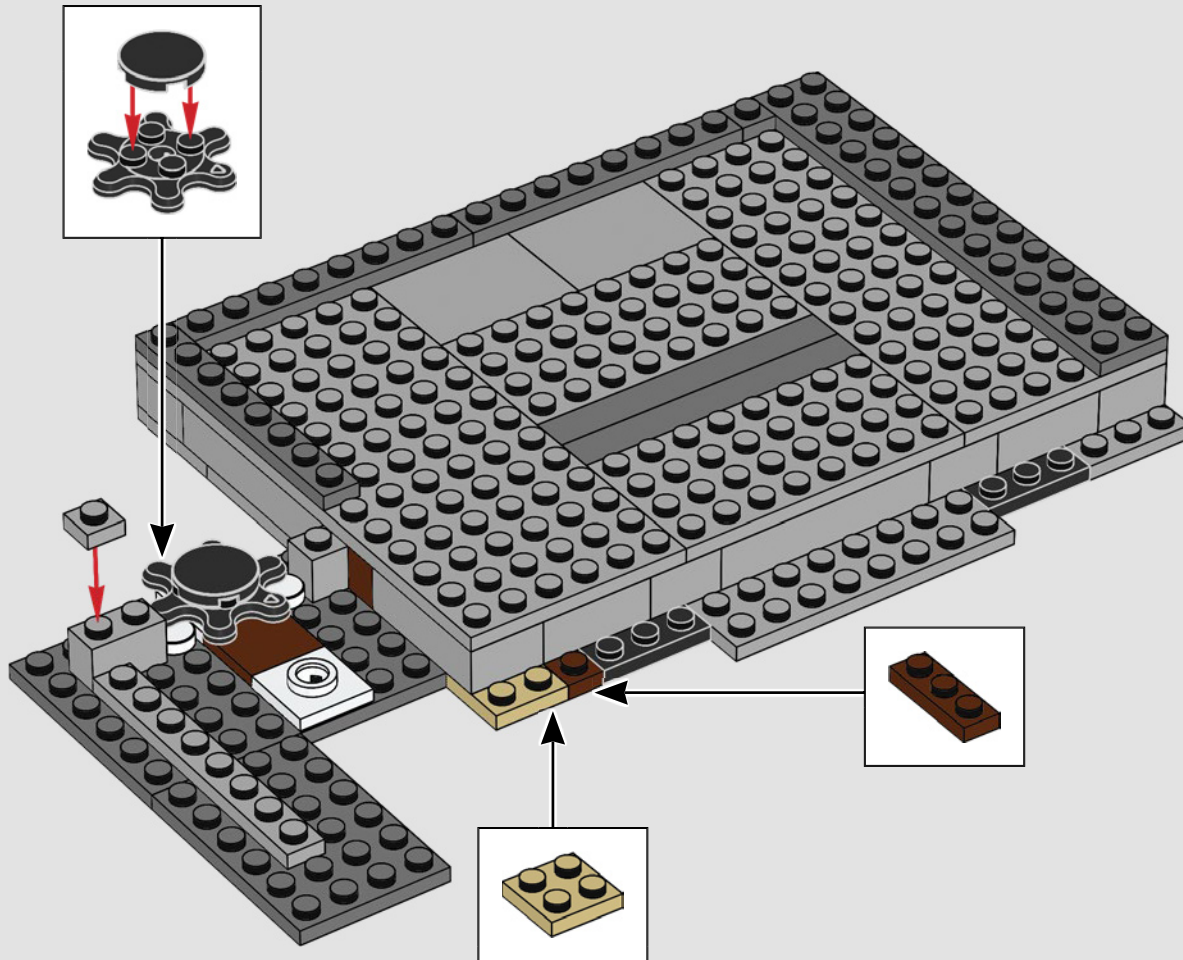

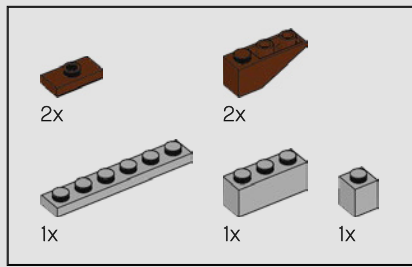

11

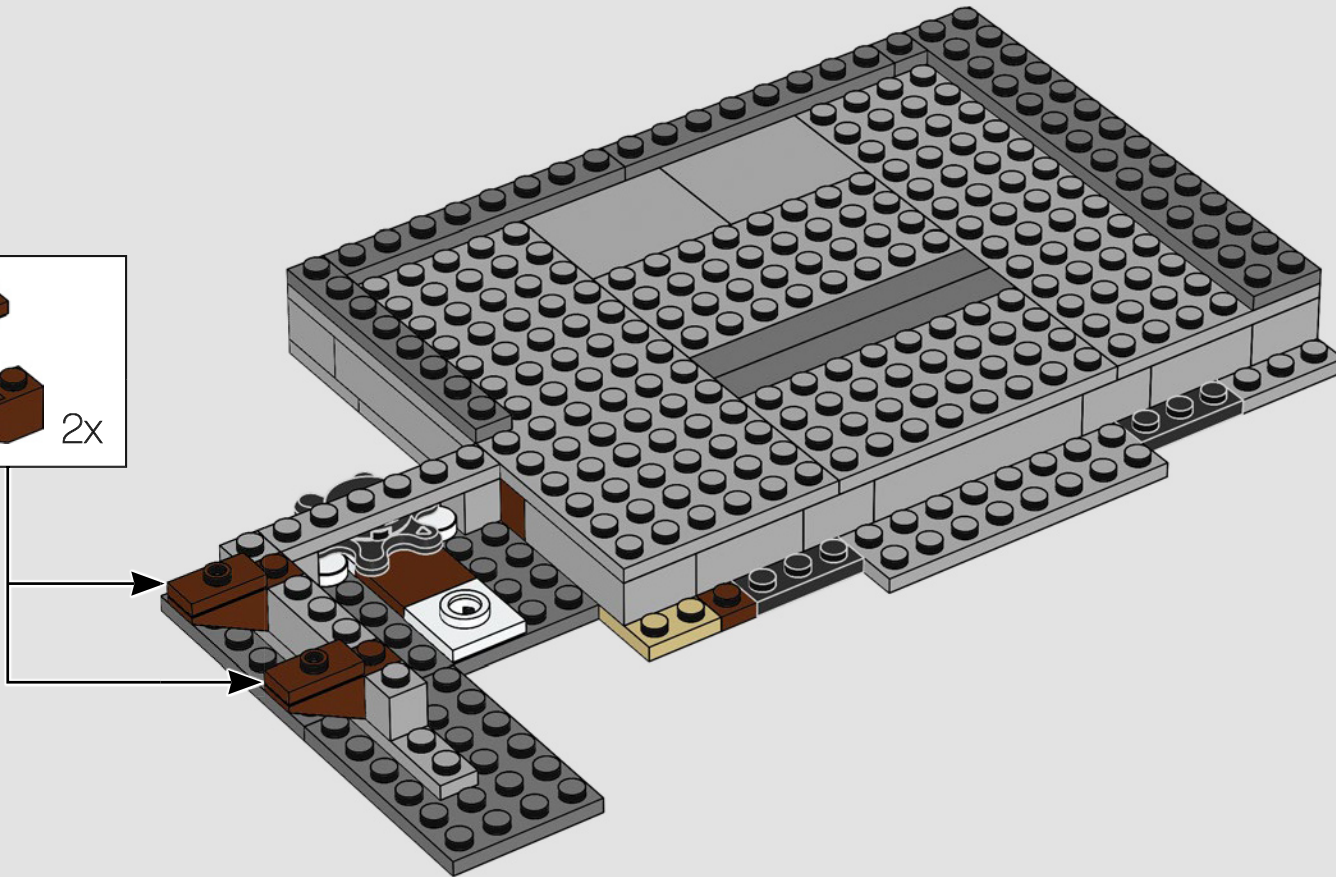
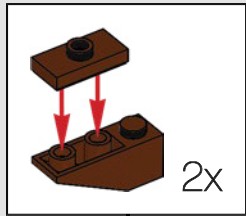

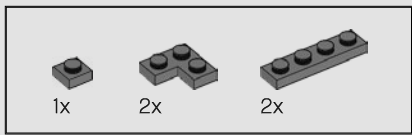

12

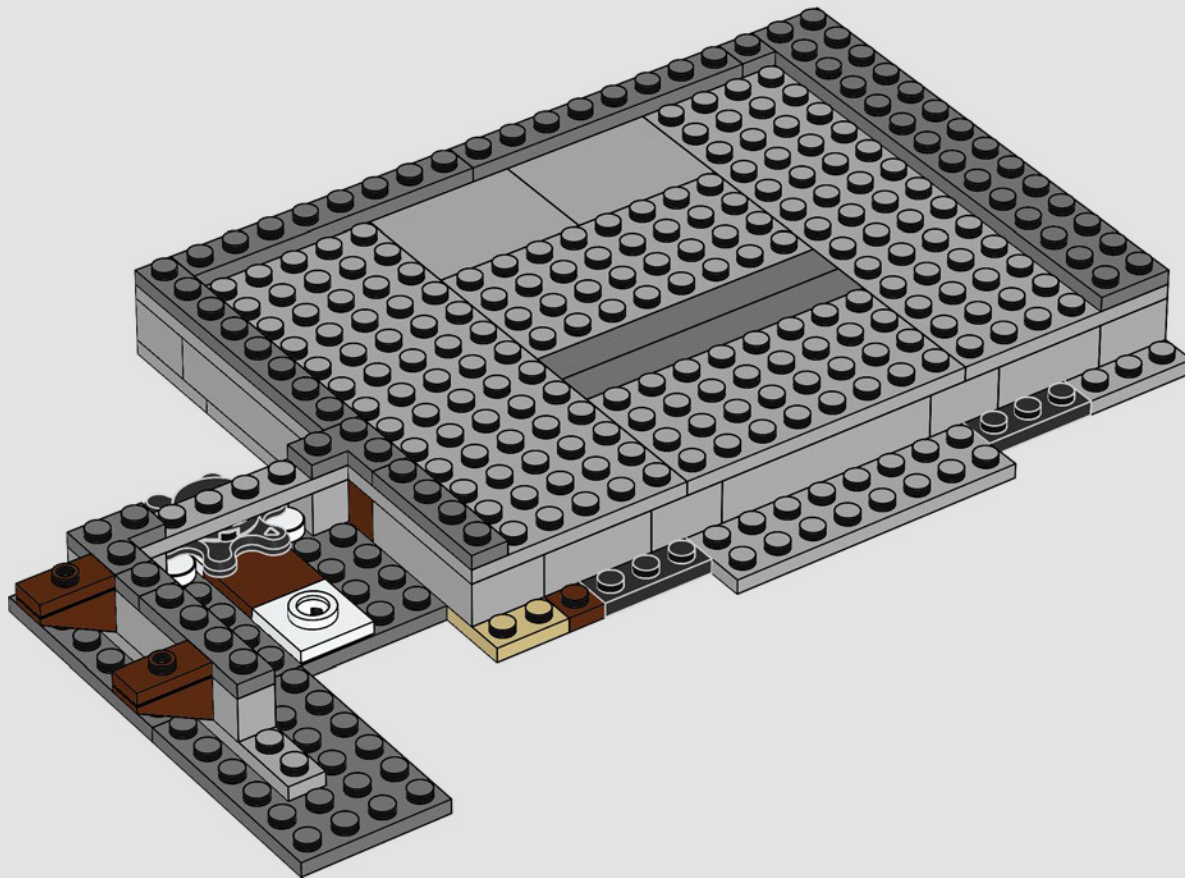

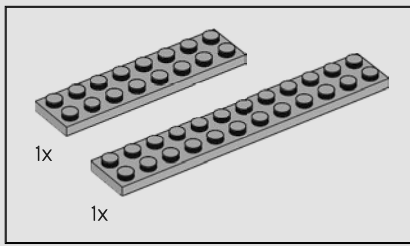

13

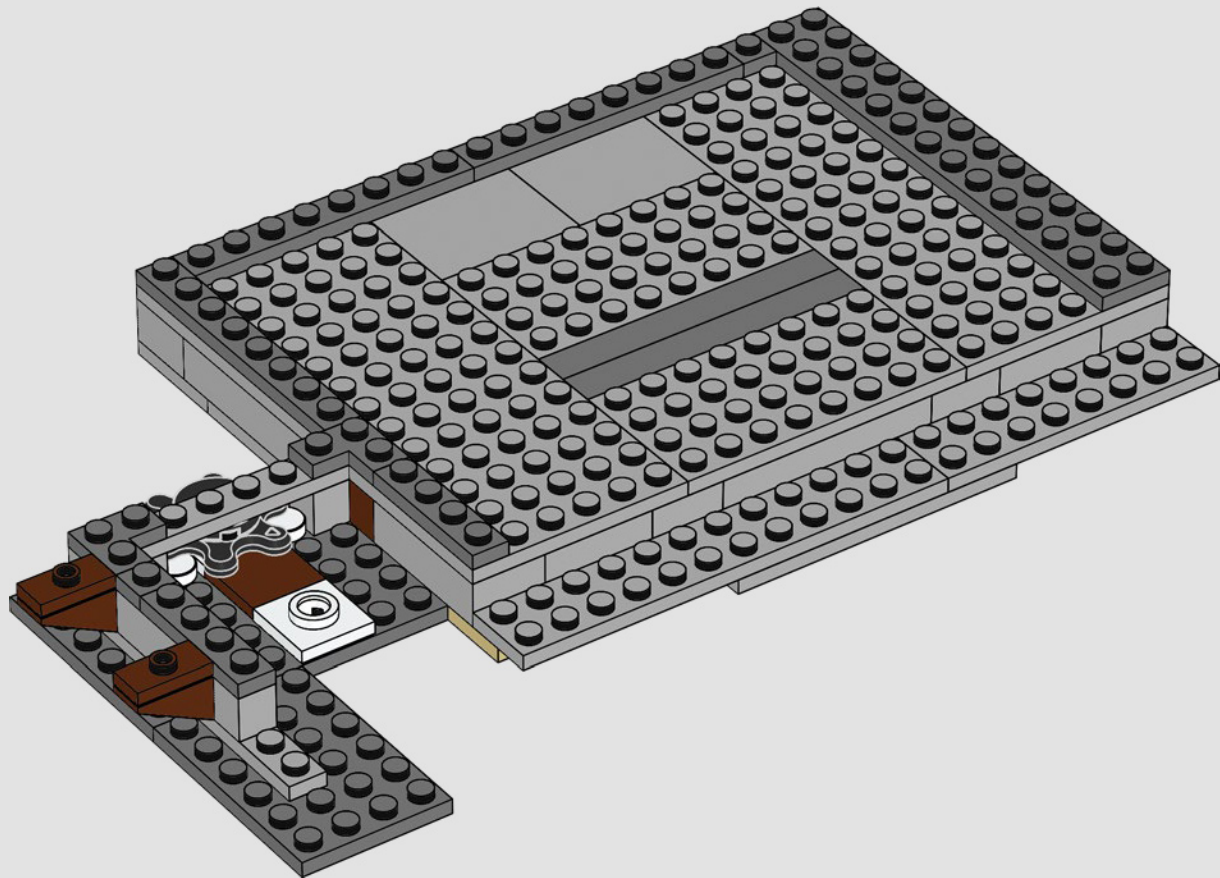

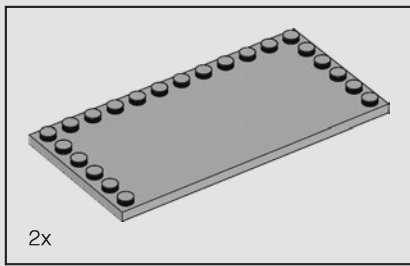

14



Jonathan Van Ness

"Il mio obiettivo con Queer Eye è creare una legacy in termini di connessione e comprensione, non solo con chi ci circonda, ma anche di comprensione e accettazione di noi stessi."

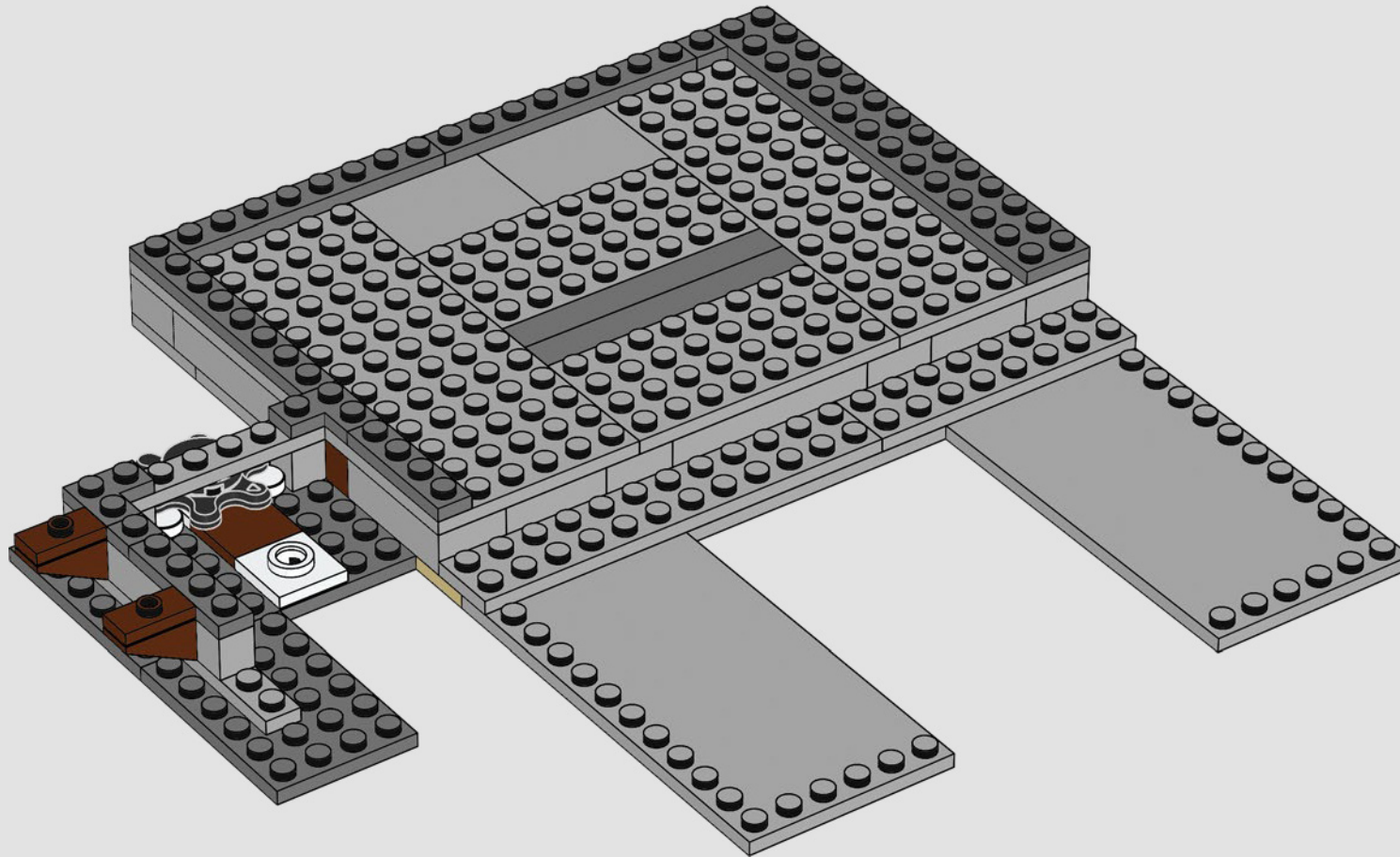

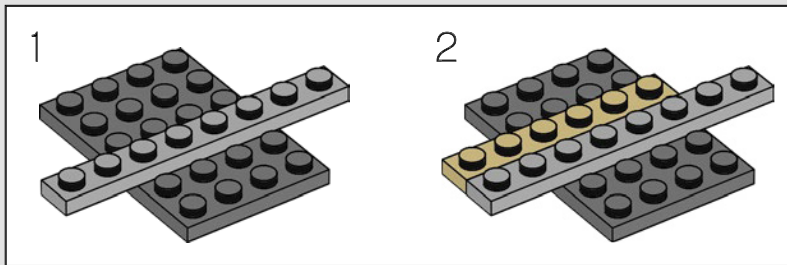
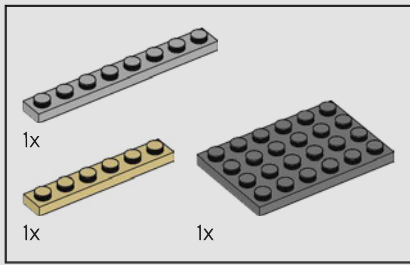

15

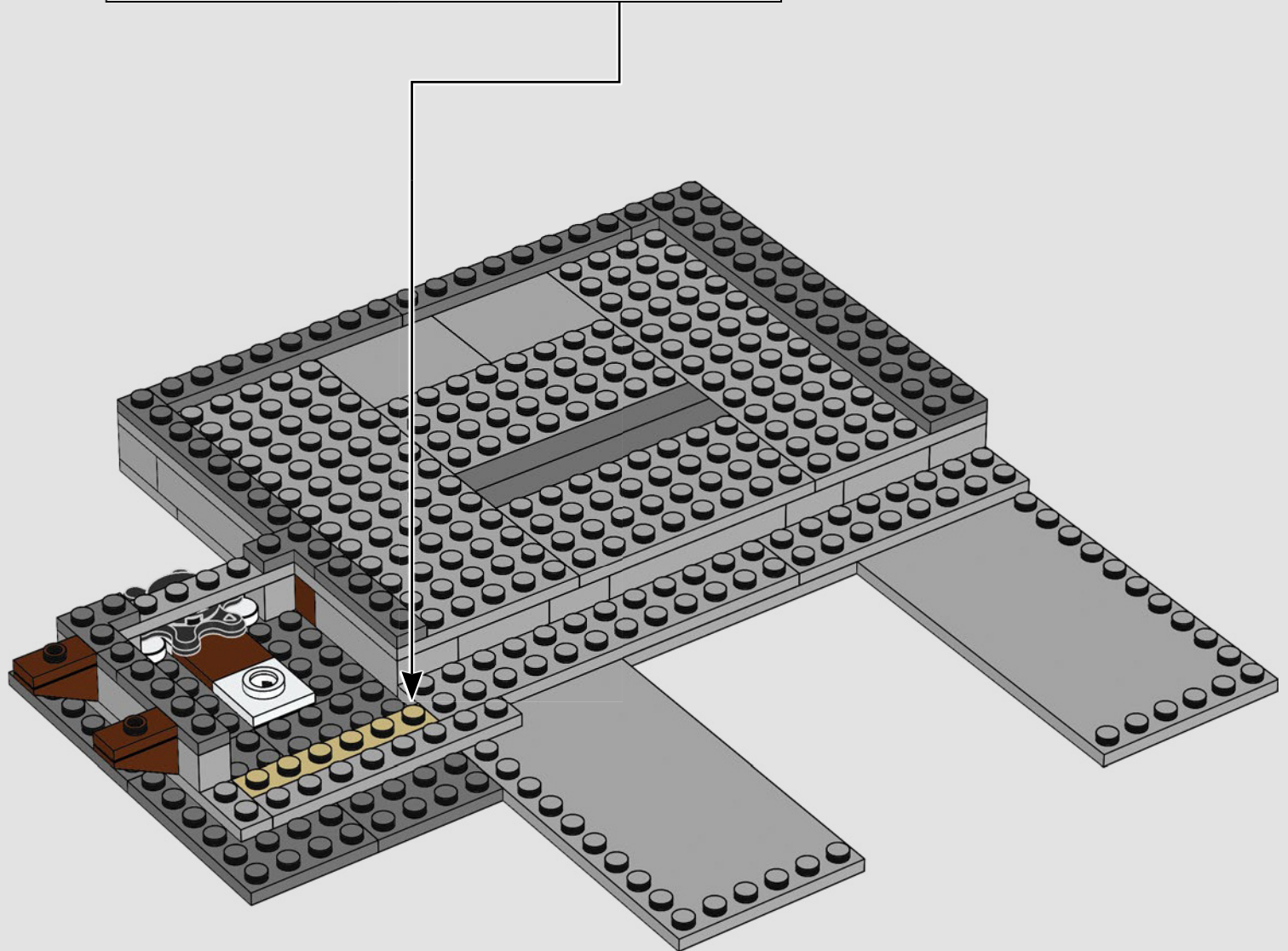

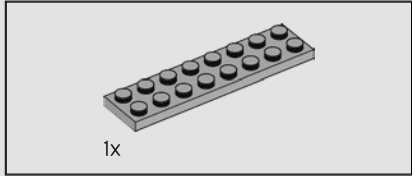
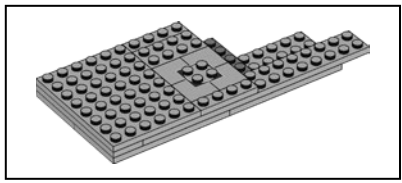

16

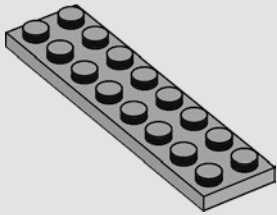

17

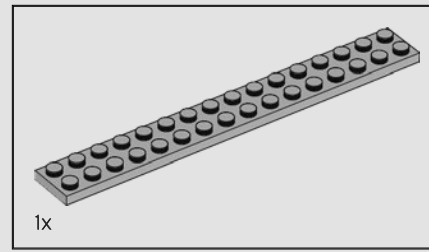
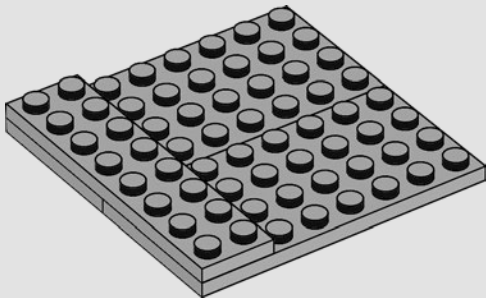

18

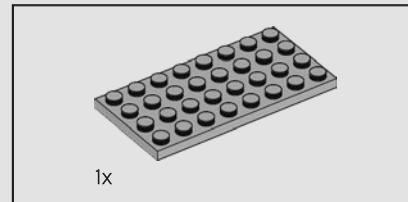
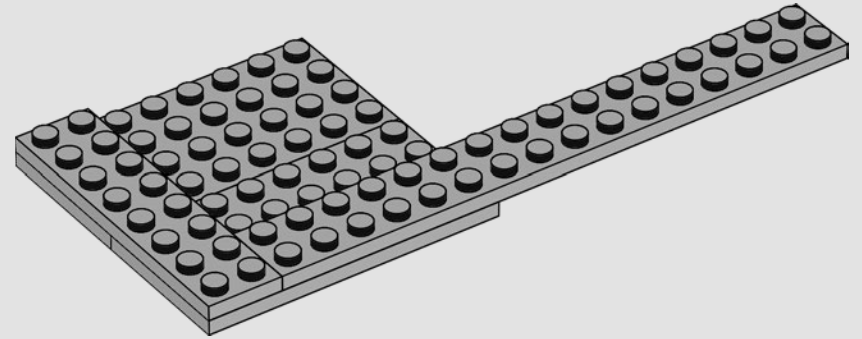

19

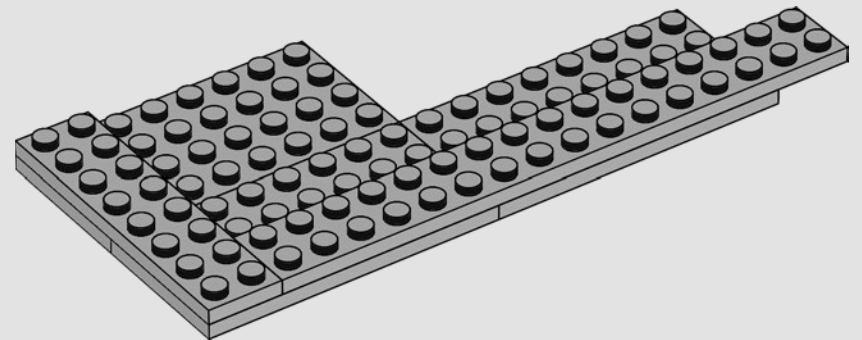

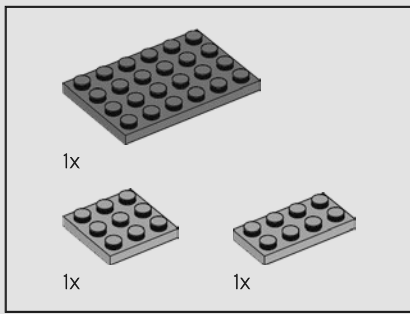

20

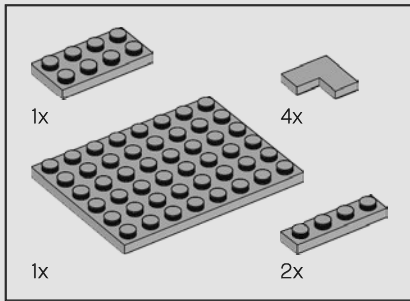
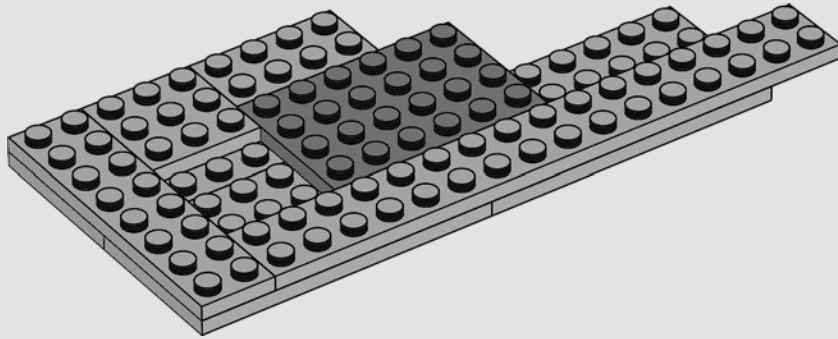

21

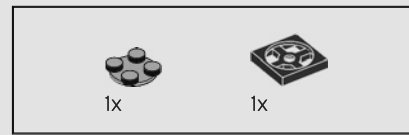
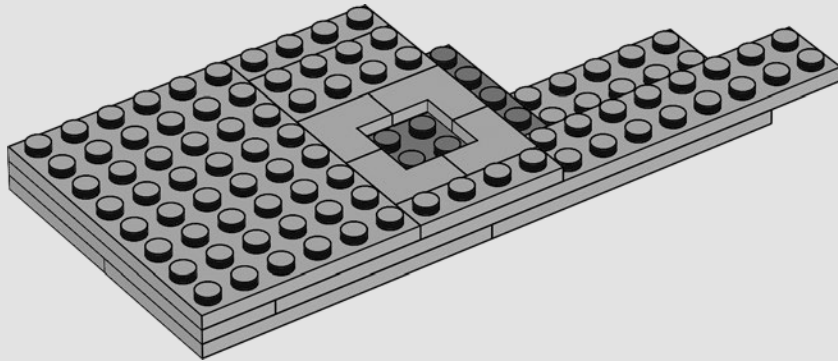

22

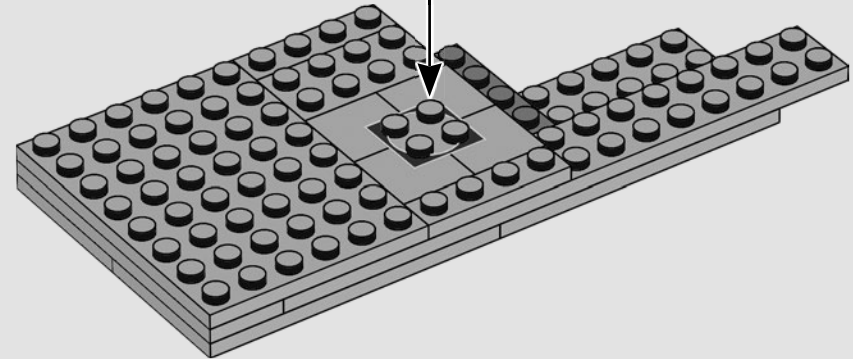
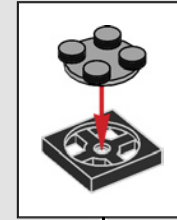



Karamo Brown

"Le costruzioni LEGO® sono state davvero speciali per me e la mia famiglia. Non solo hanno intrattenuto i miei bambini per ore, ma sono state anche una grande attività per me in quanto mi hanno permesso di connettermi e di legarmi con loro ancora di più".

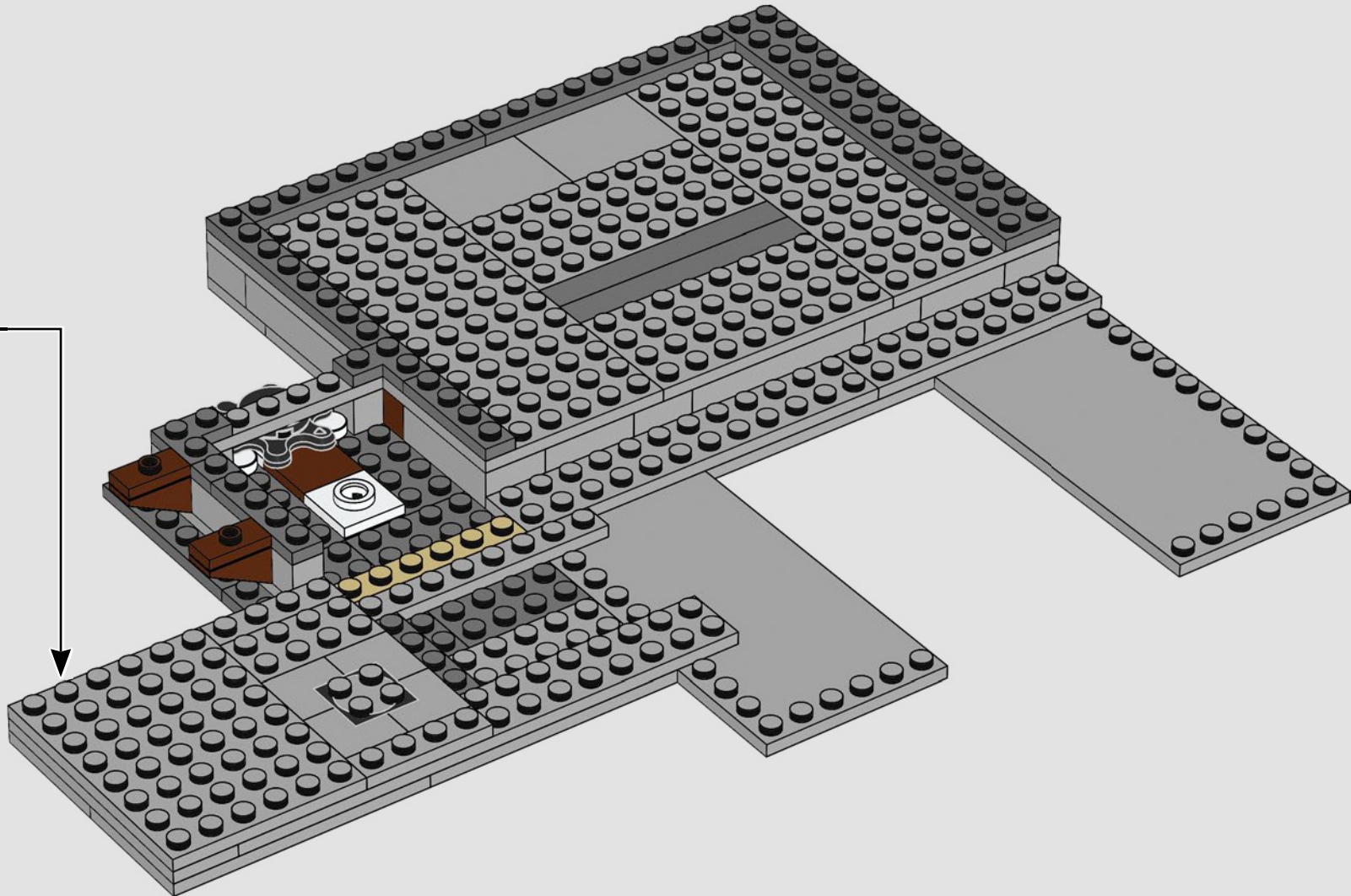

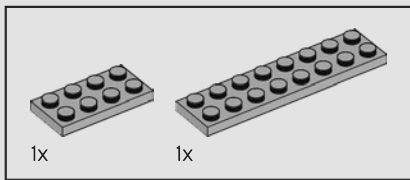

24

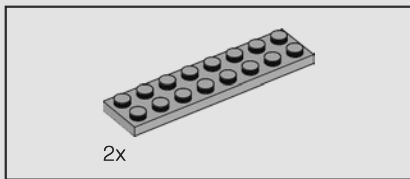
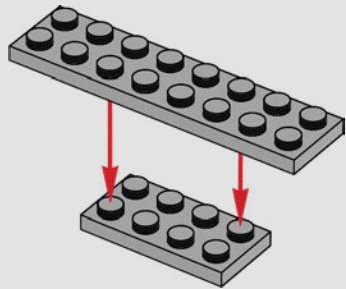

25

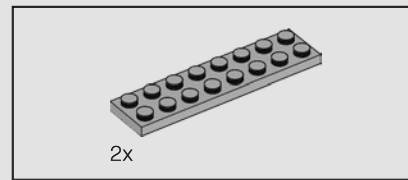
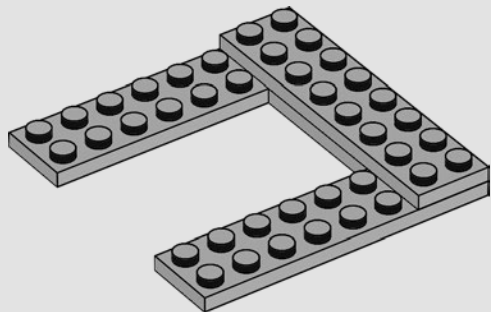

26

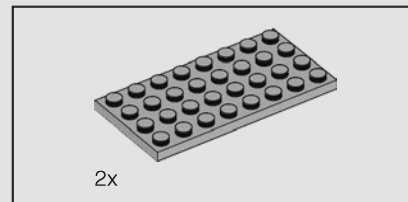
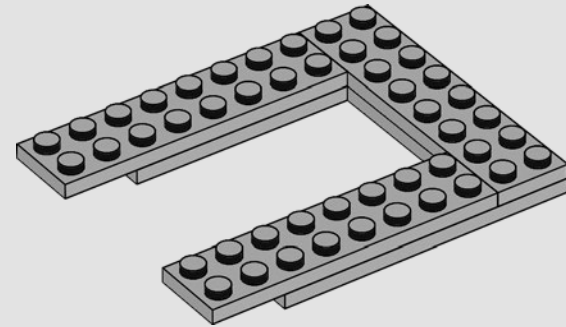

27

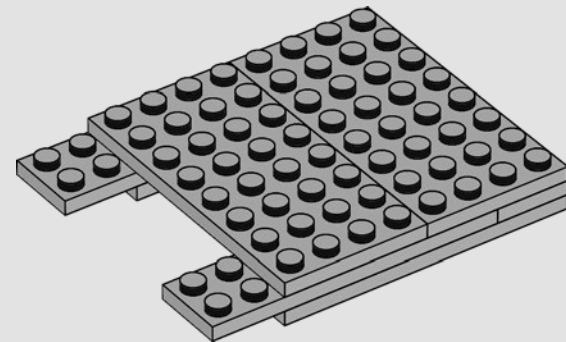

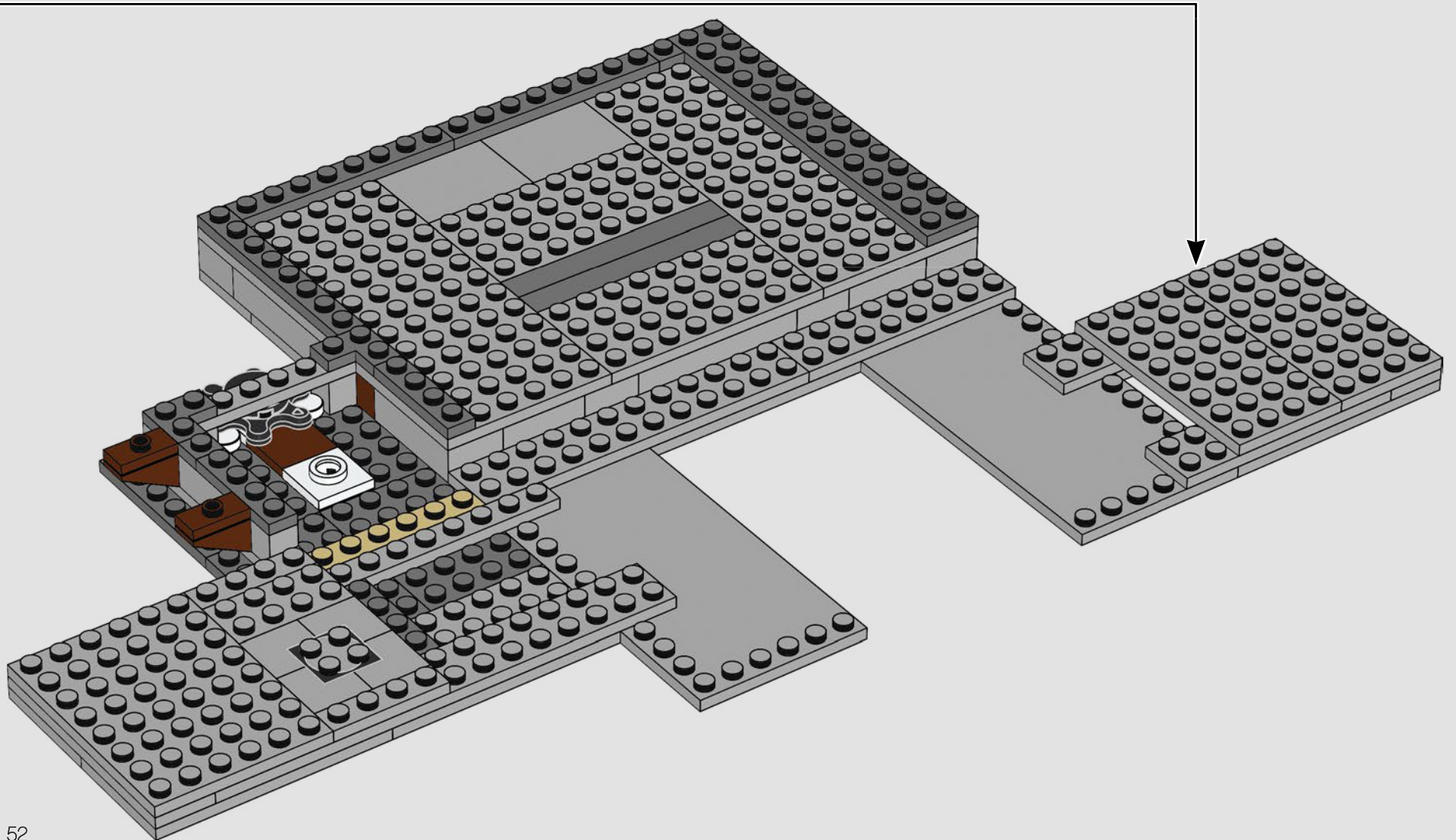

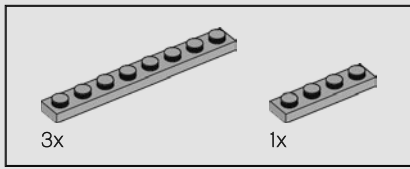

29

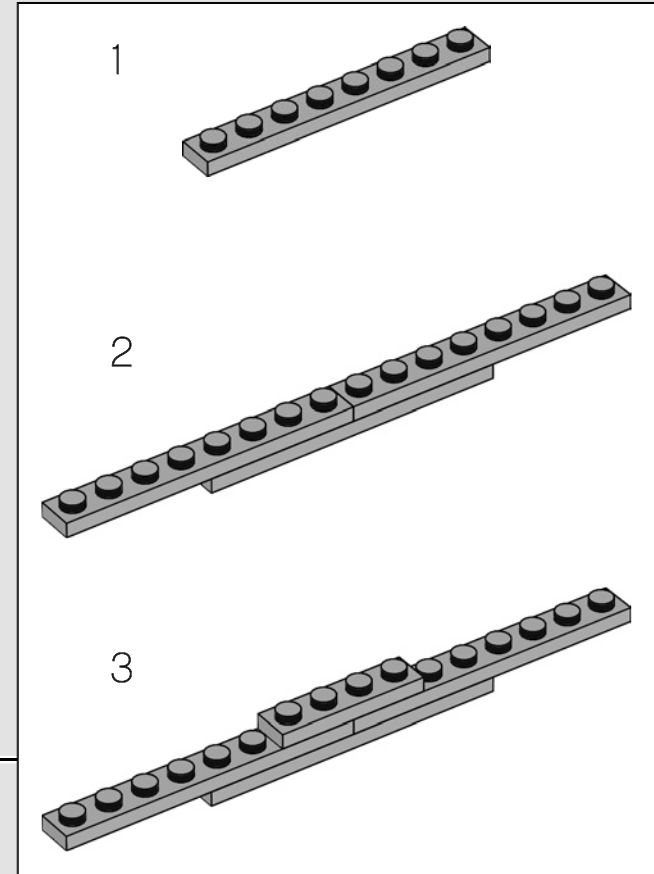
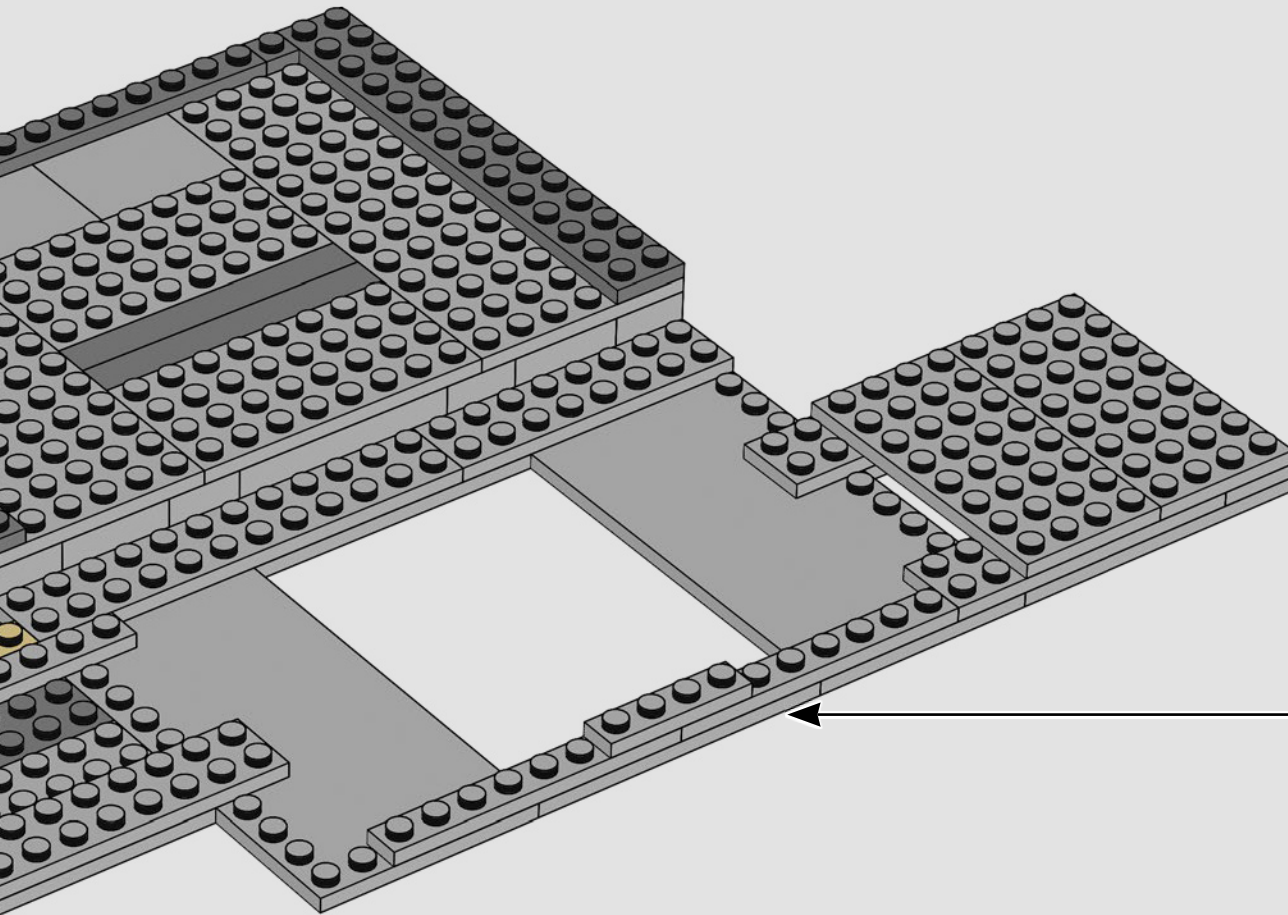

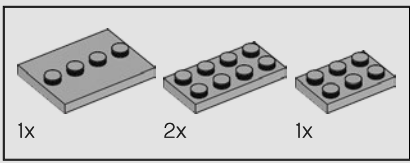

30

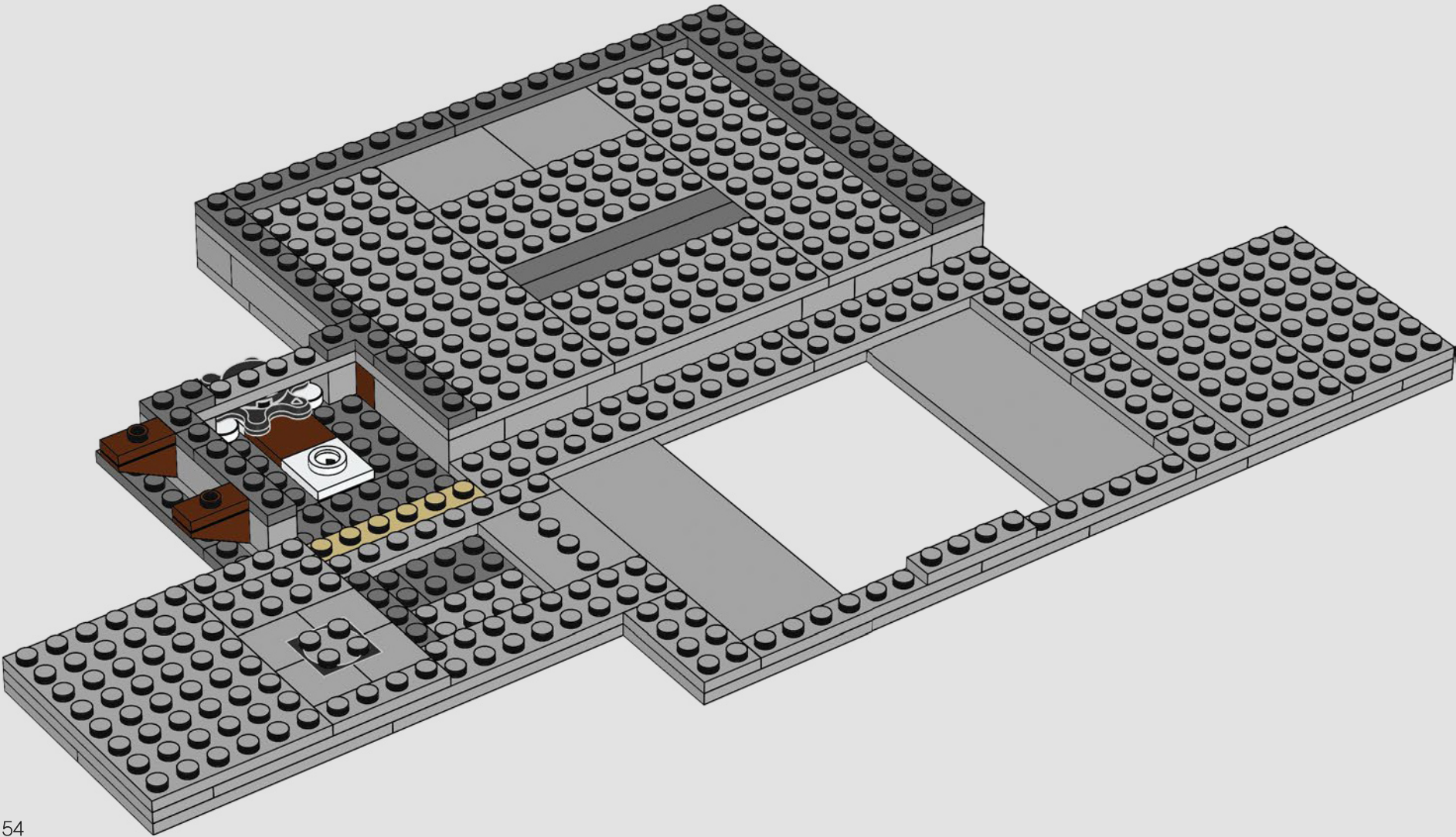

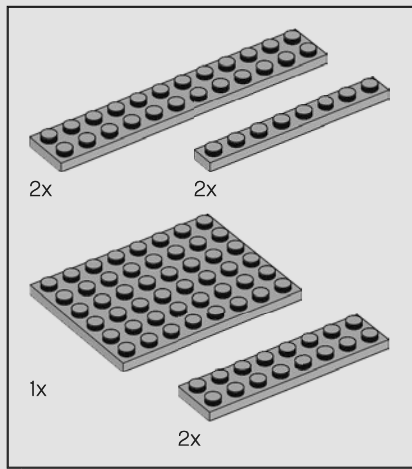

31

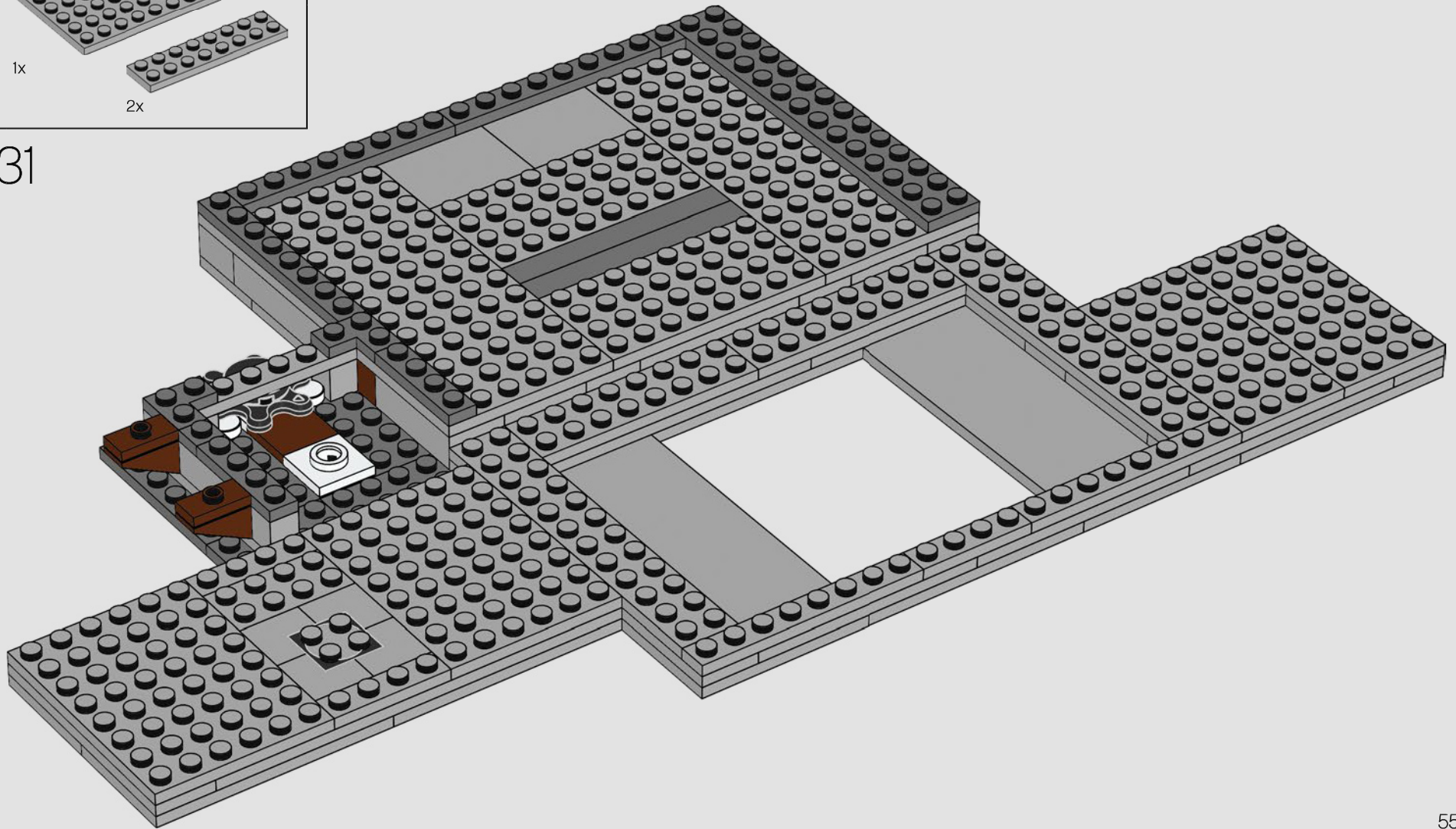

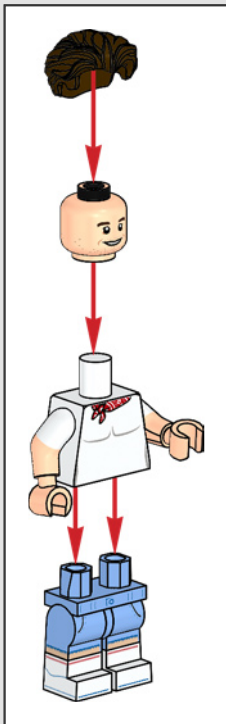
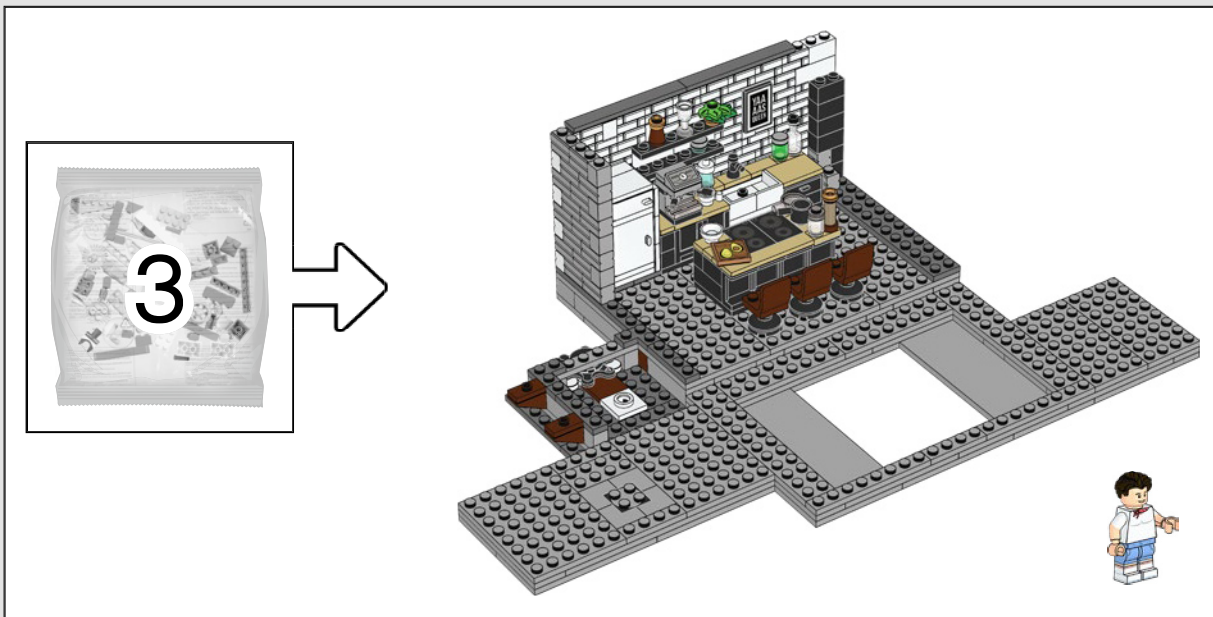

Antoni Porowski

"Adoro il piccolo foulard e, naturalmente, il mio accessorio LEGO® doveva essere un minuscolo tagliere con tanti avocado".

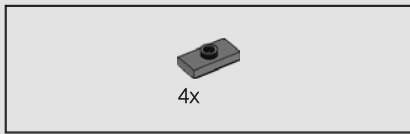

32

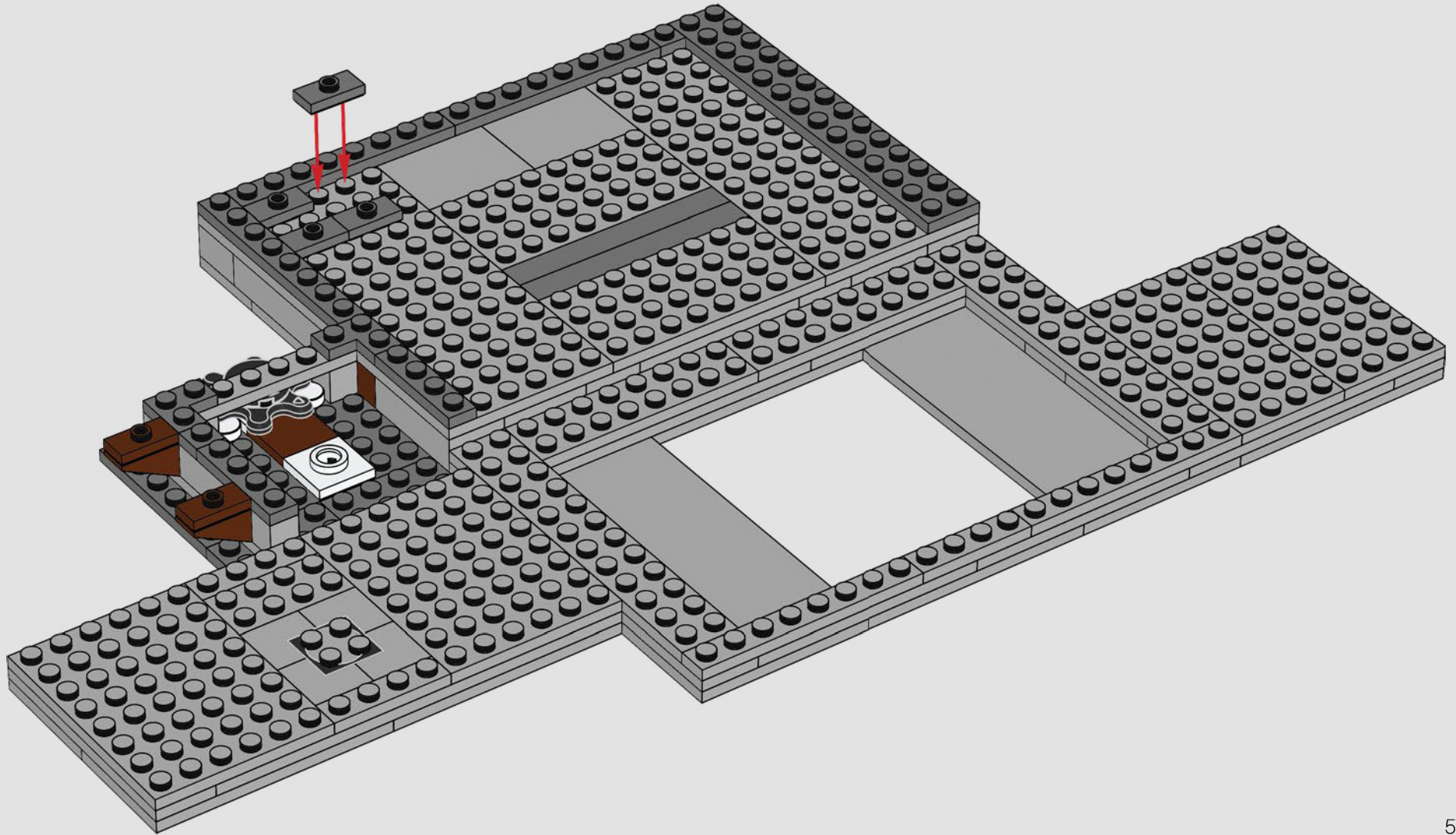

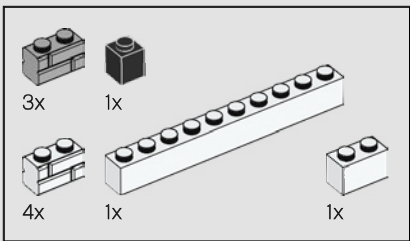

33



Bobby Berk

"Da bambino, i mattoncini LEGO® hanno acceso la fiamma creativa dentro di me e mi hanno fatto sentire come se le possibilità nella vita fossero infinite, tanto quanto le cose che ero in grado di costruire".

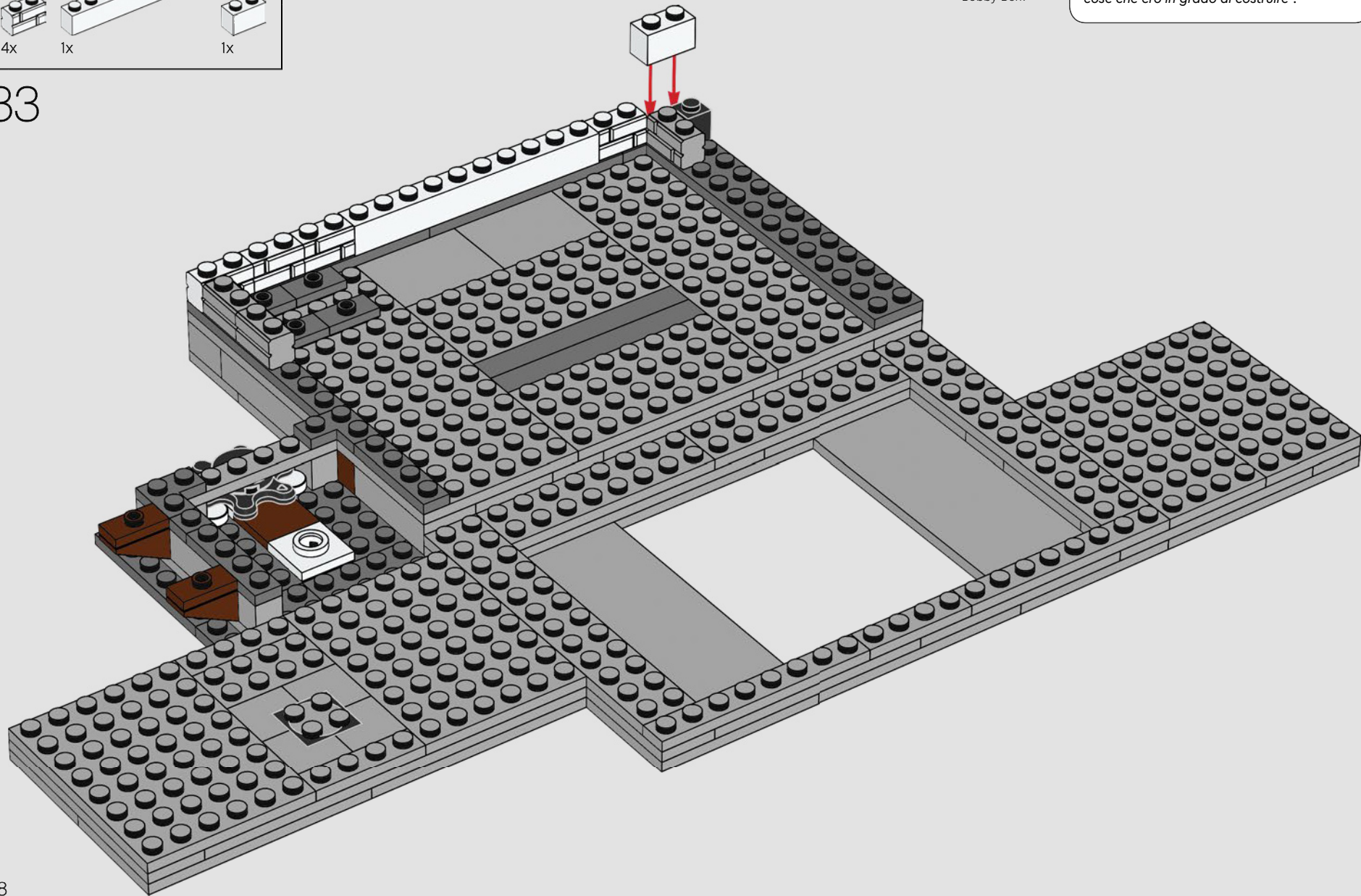

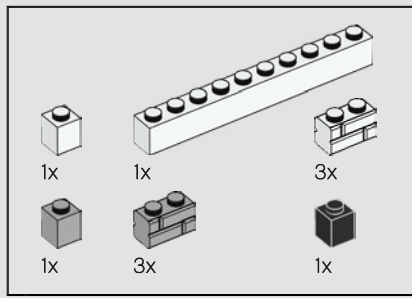

34

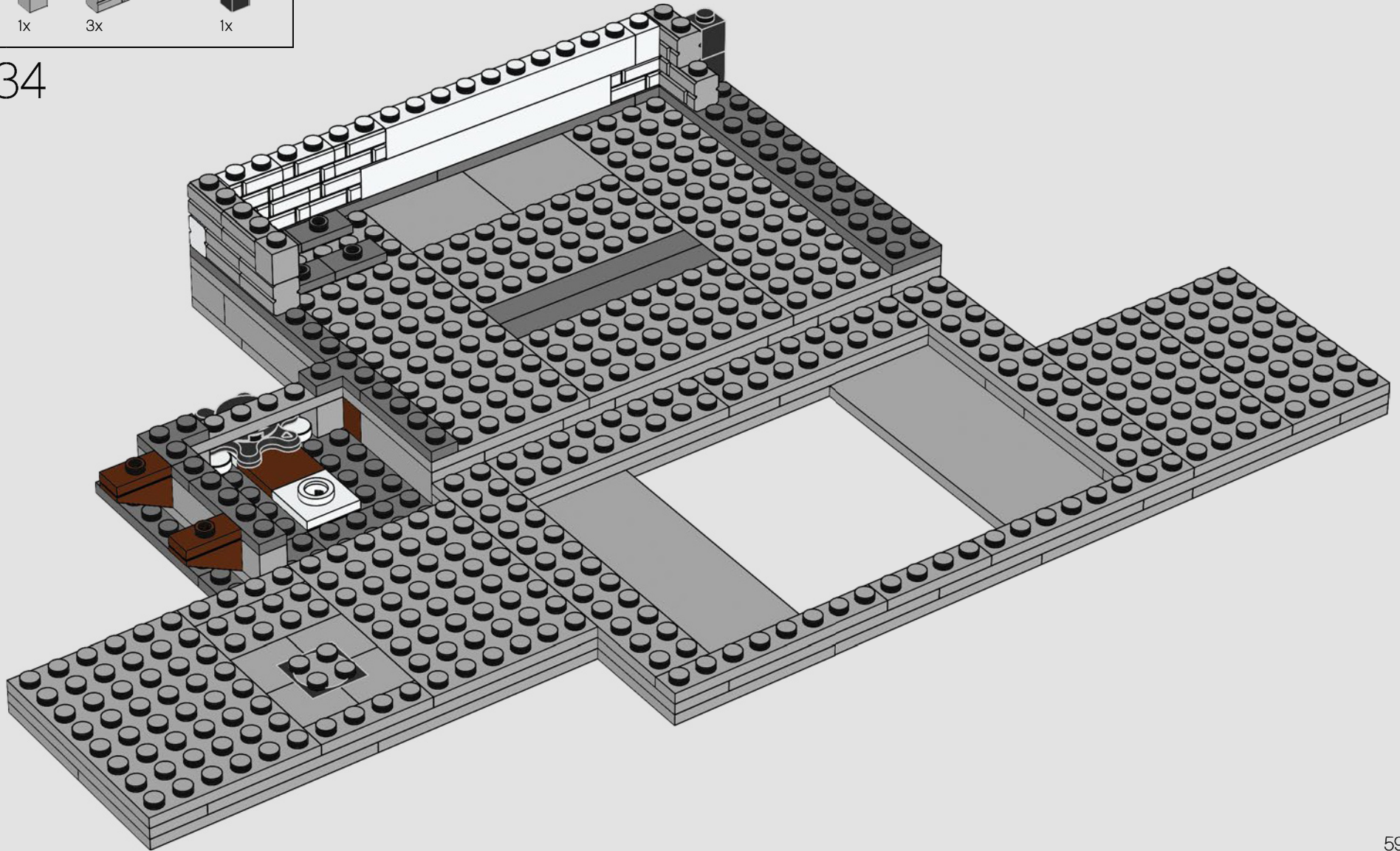

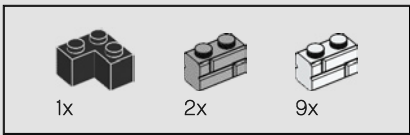

35

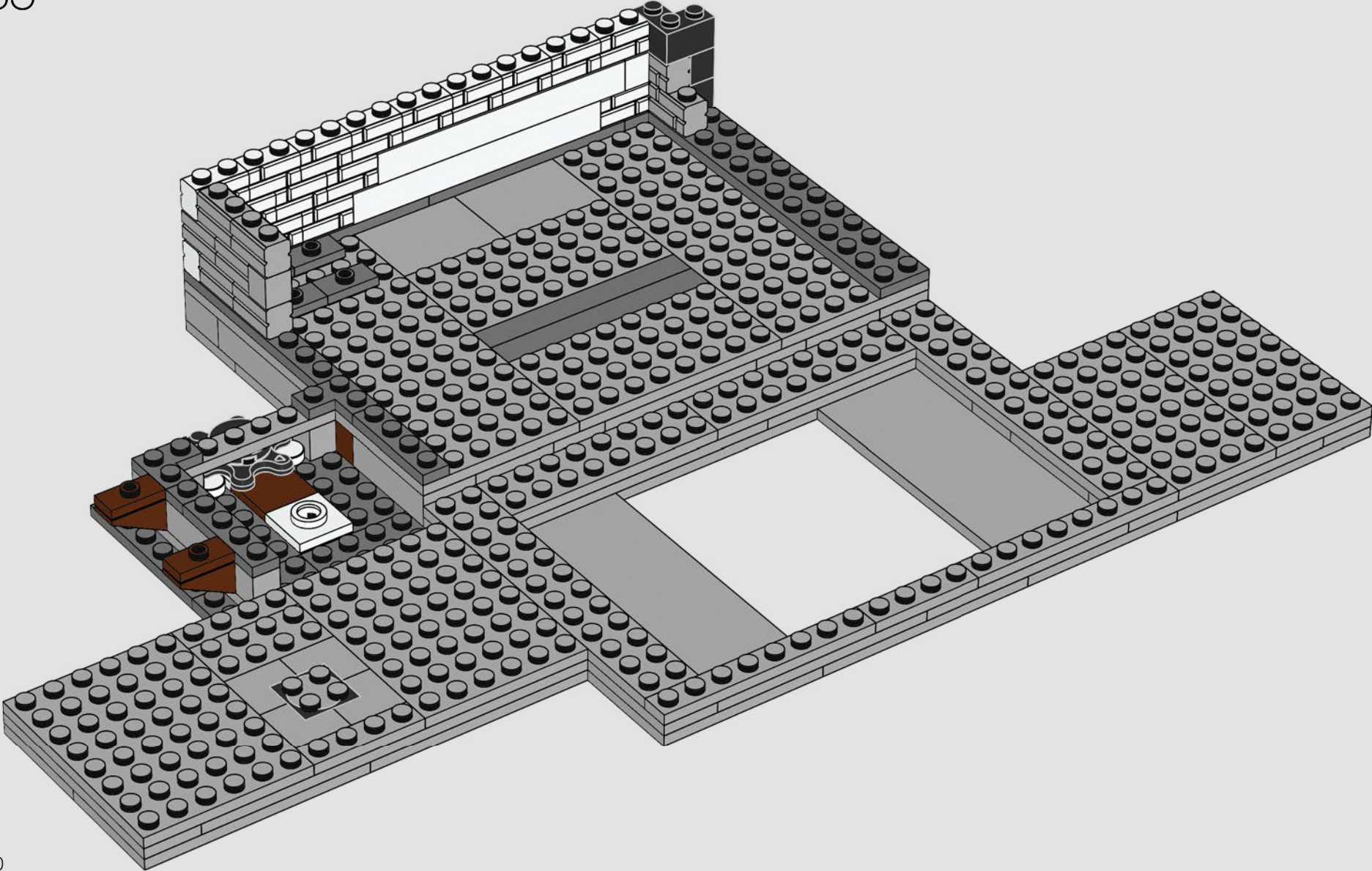

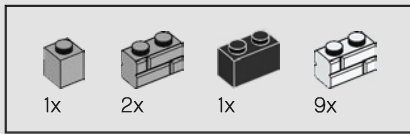

36

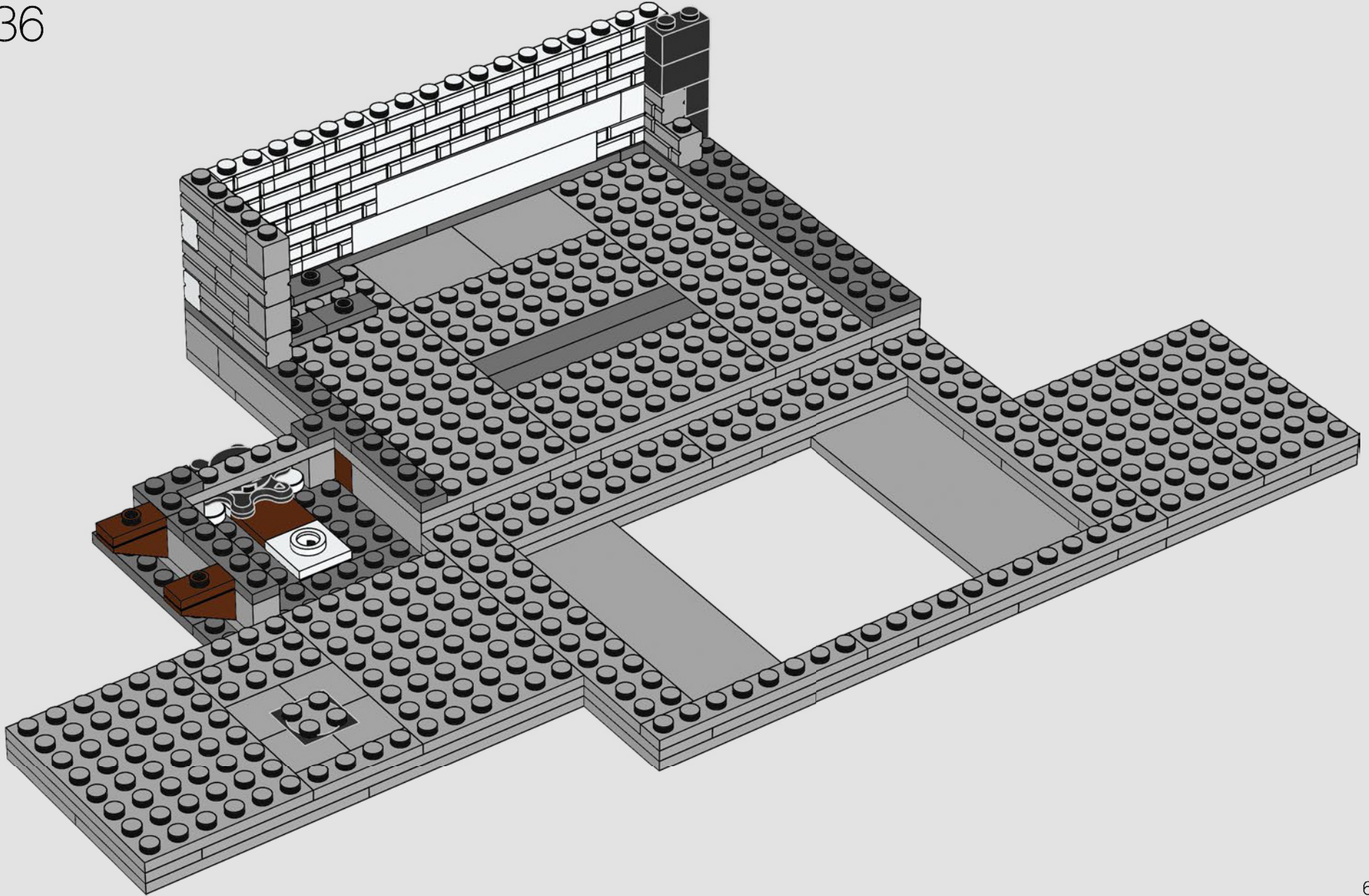

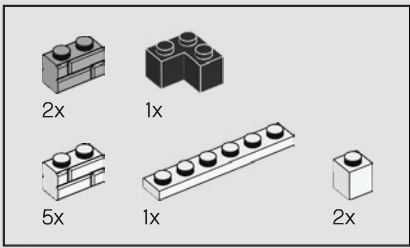

37



Bobby Berk

"Aver realizzato uno show che non solo è stato un successo, ma che ha anche aiutato milioni di persone ad amare se stesse e gli altri di più è il più grande onore della mia vita".

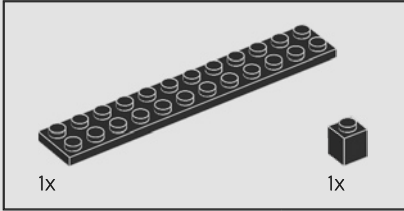
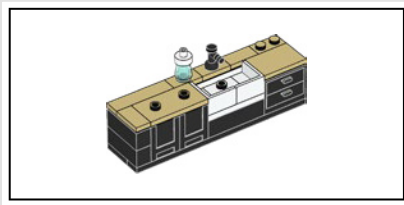

38

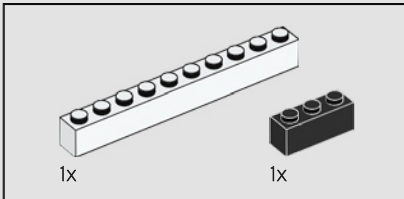
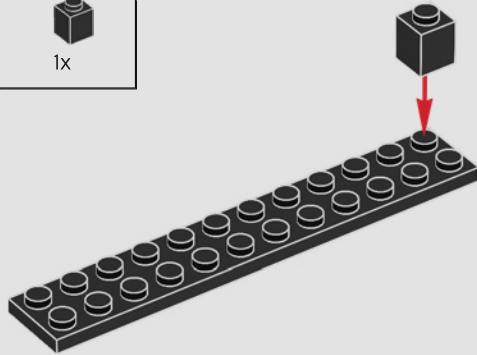

39

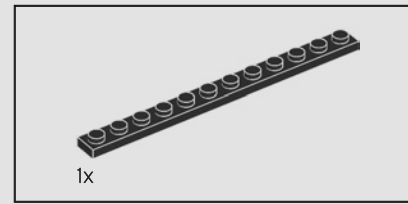
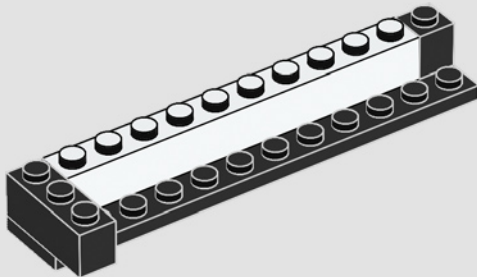

40

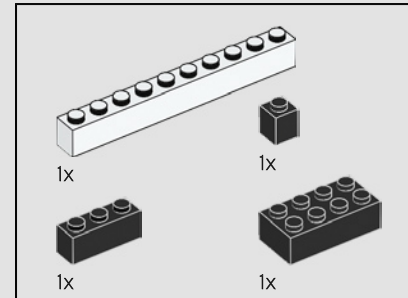
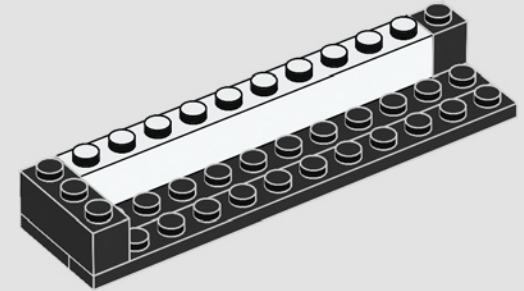

41

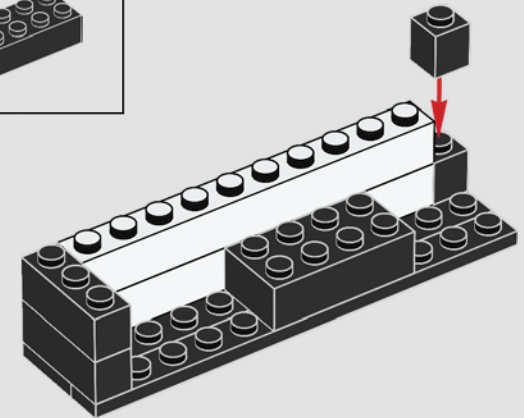



42

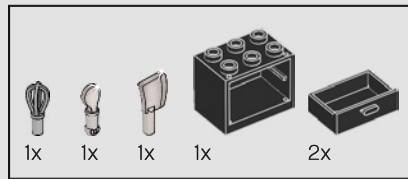
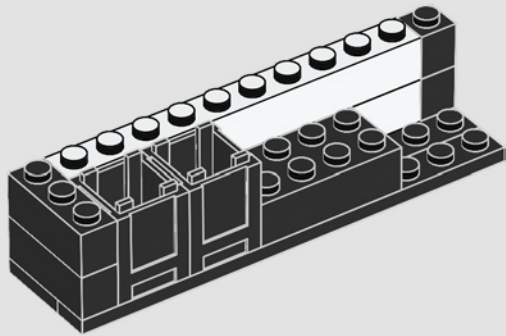

43

1

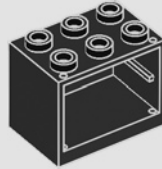

2

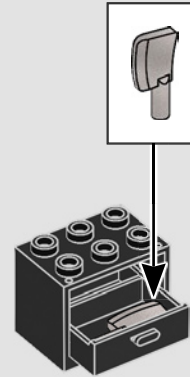

3

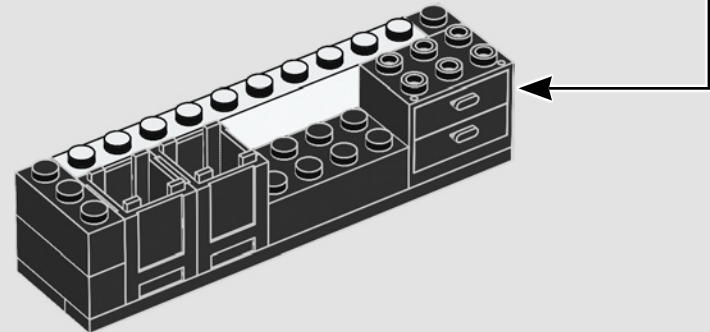
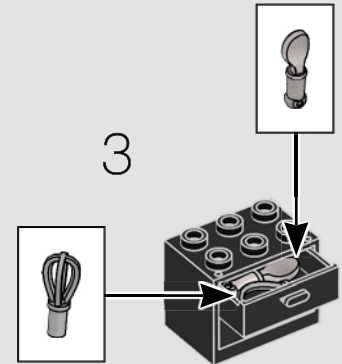

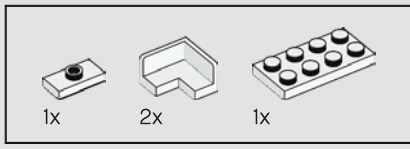

44

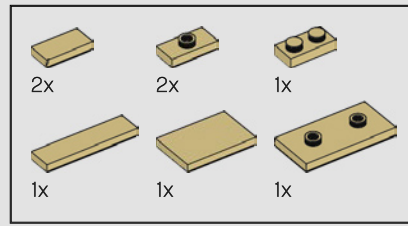
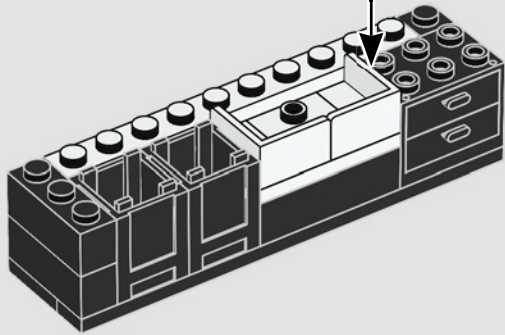
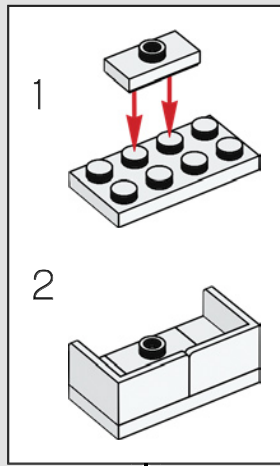

45

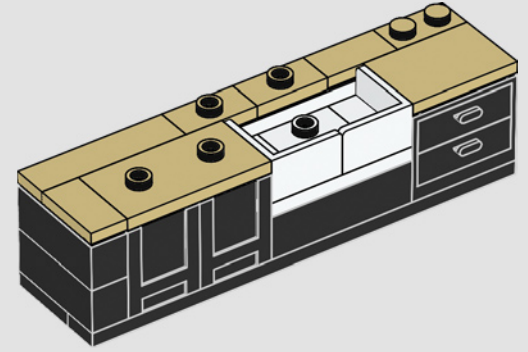

46

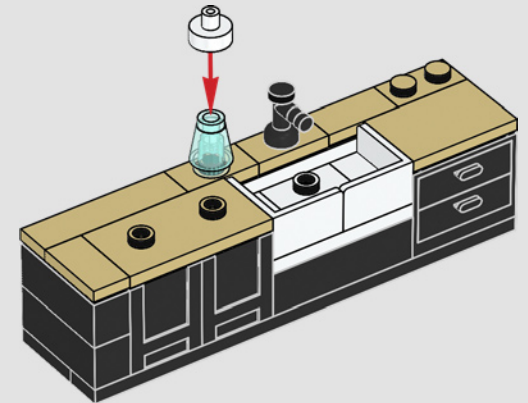

47

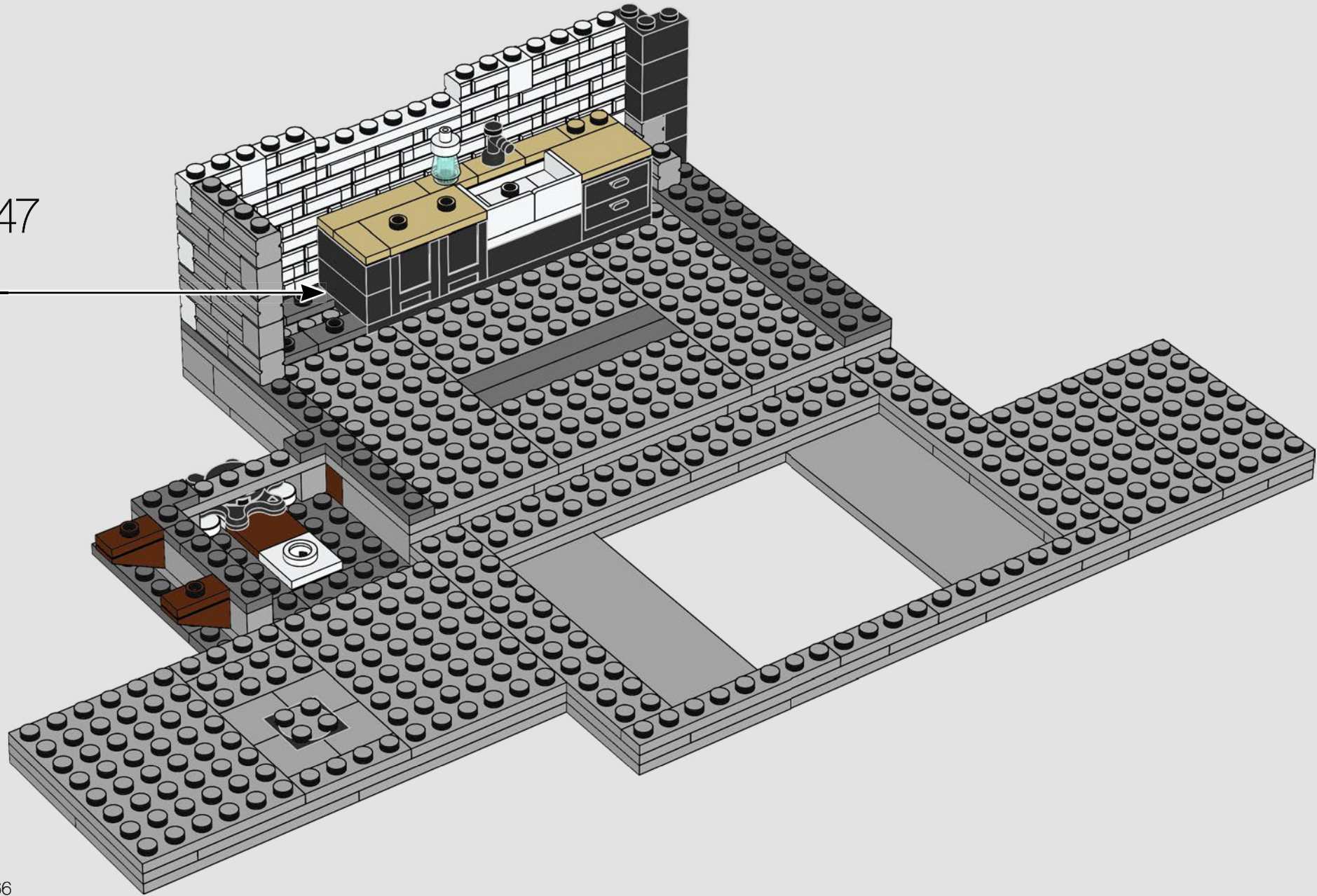

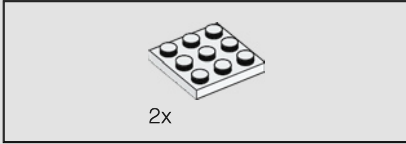
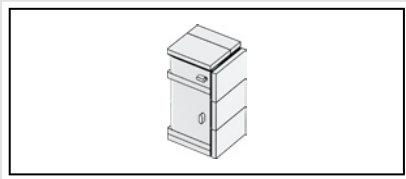

48

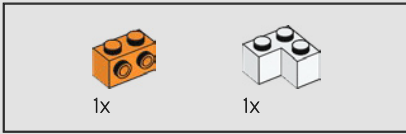
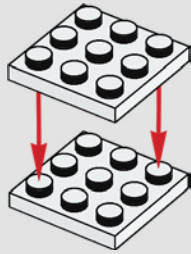

49

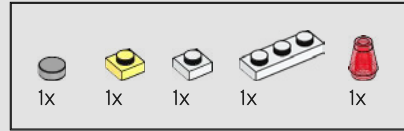
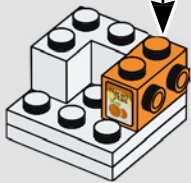
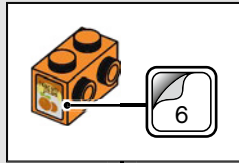

50

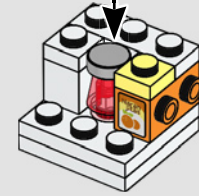
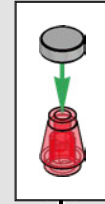

51

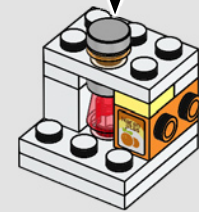
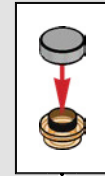

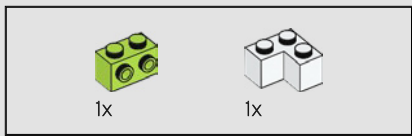

52

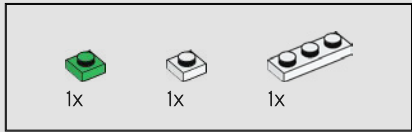
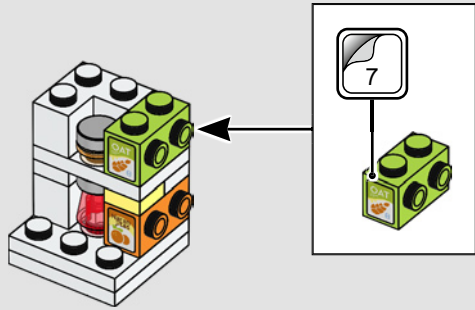

53

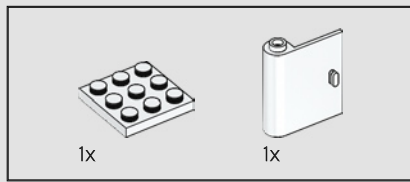

54

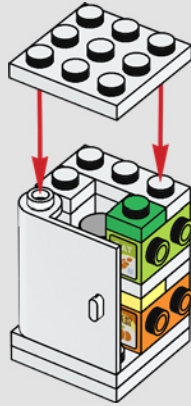

55

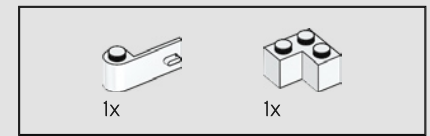
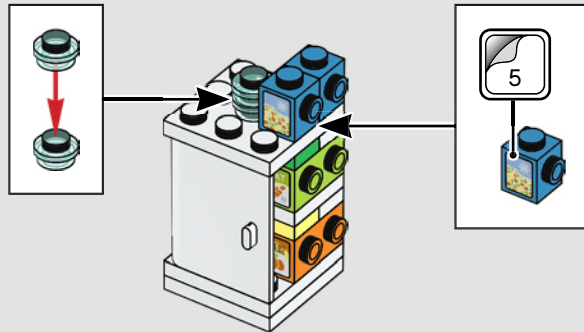

56

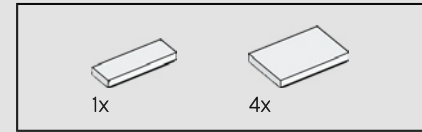

57

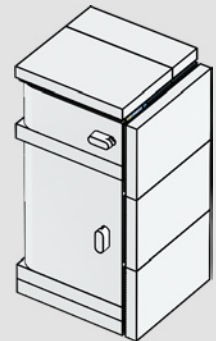

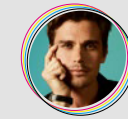

Antoni Porowski

"Costruire con i mattoncini LEGO® non è molto dissimile dal preparare un pasto. Naturalmente, puoi seguire la ricetta per avere un risultato perfetto, oppure puoi fare tutto in modo sperimentale e inventare la tua creazione".



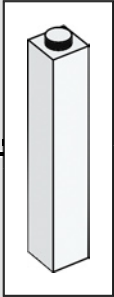
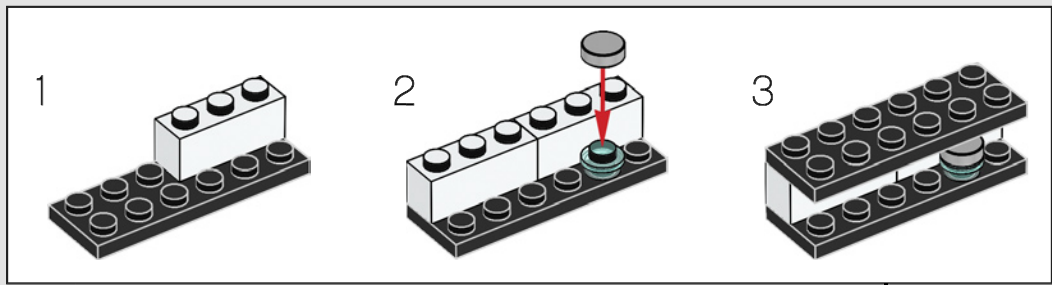
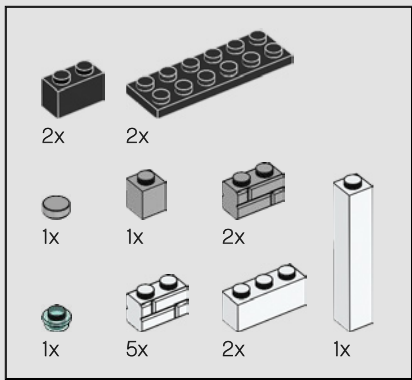

59

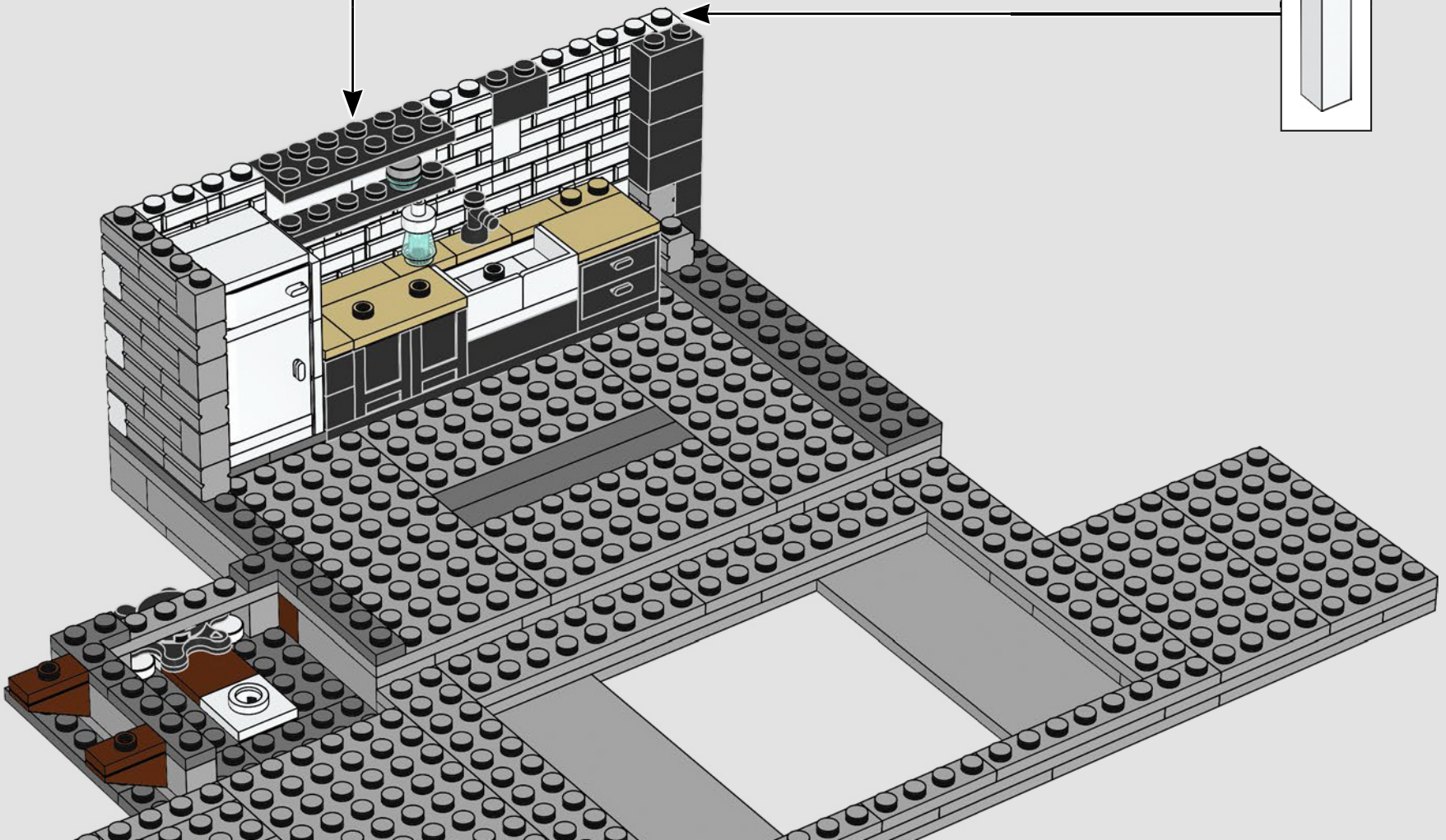

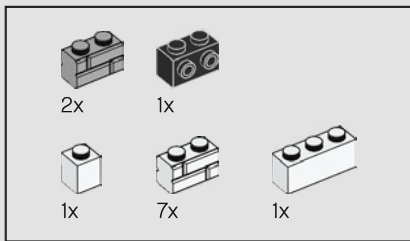

60

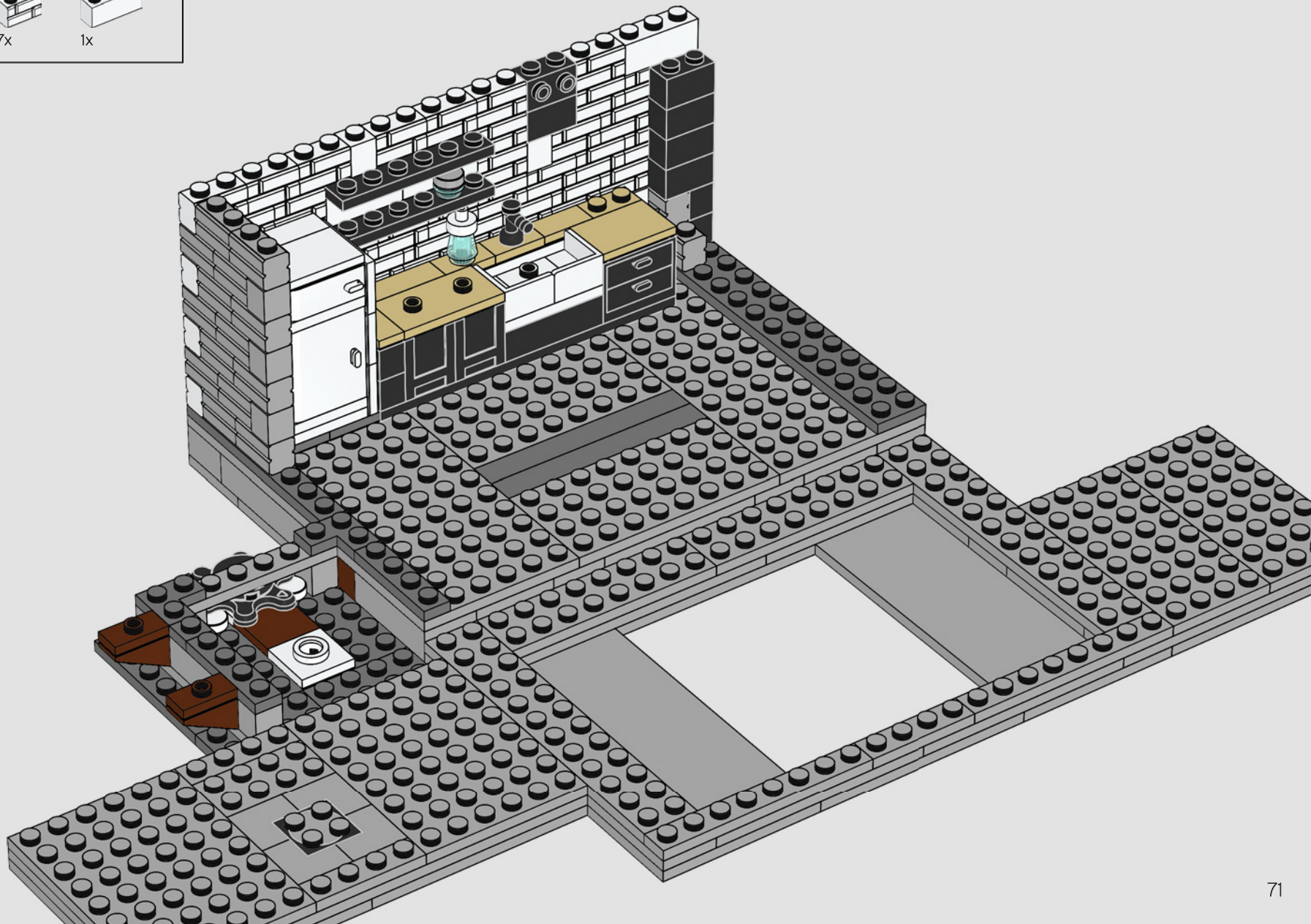

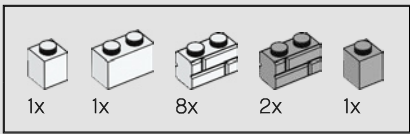

61



Bobby Berk

"In Queer Eye ci occupiamo di ricominciare da zero, ricostruire e sfruttare al meglio ciò che hai - e quale miglior giocattolo c'è per celebrare tutto questo dei mattoncini LEGO?"



62

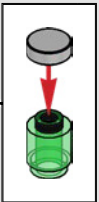
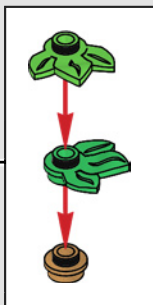
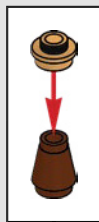
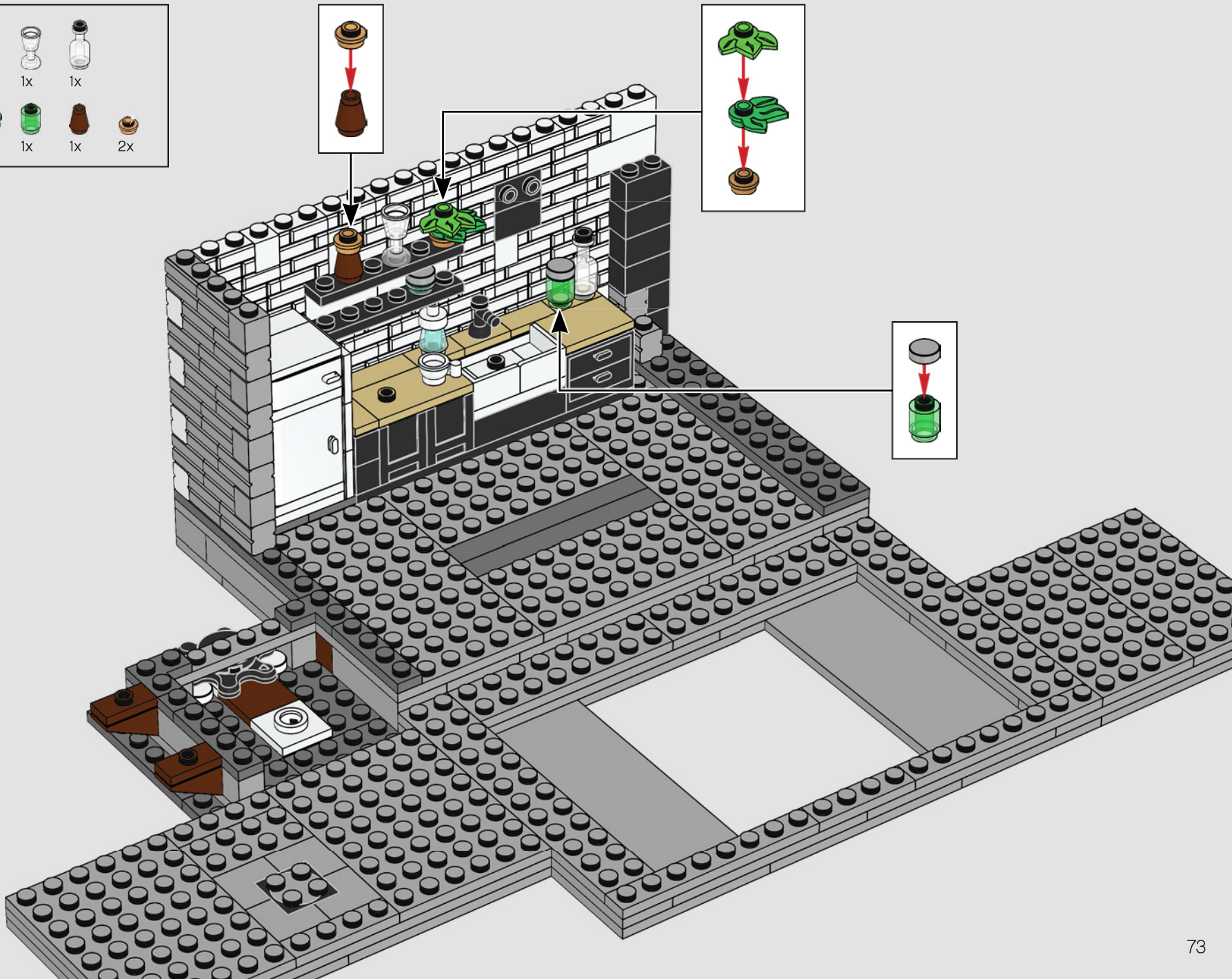

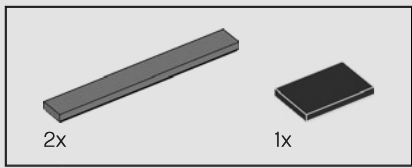

63

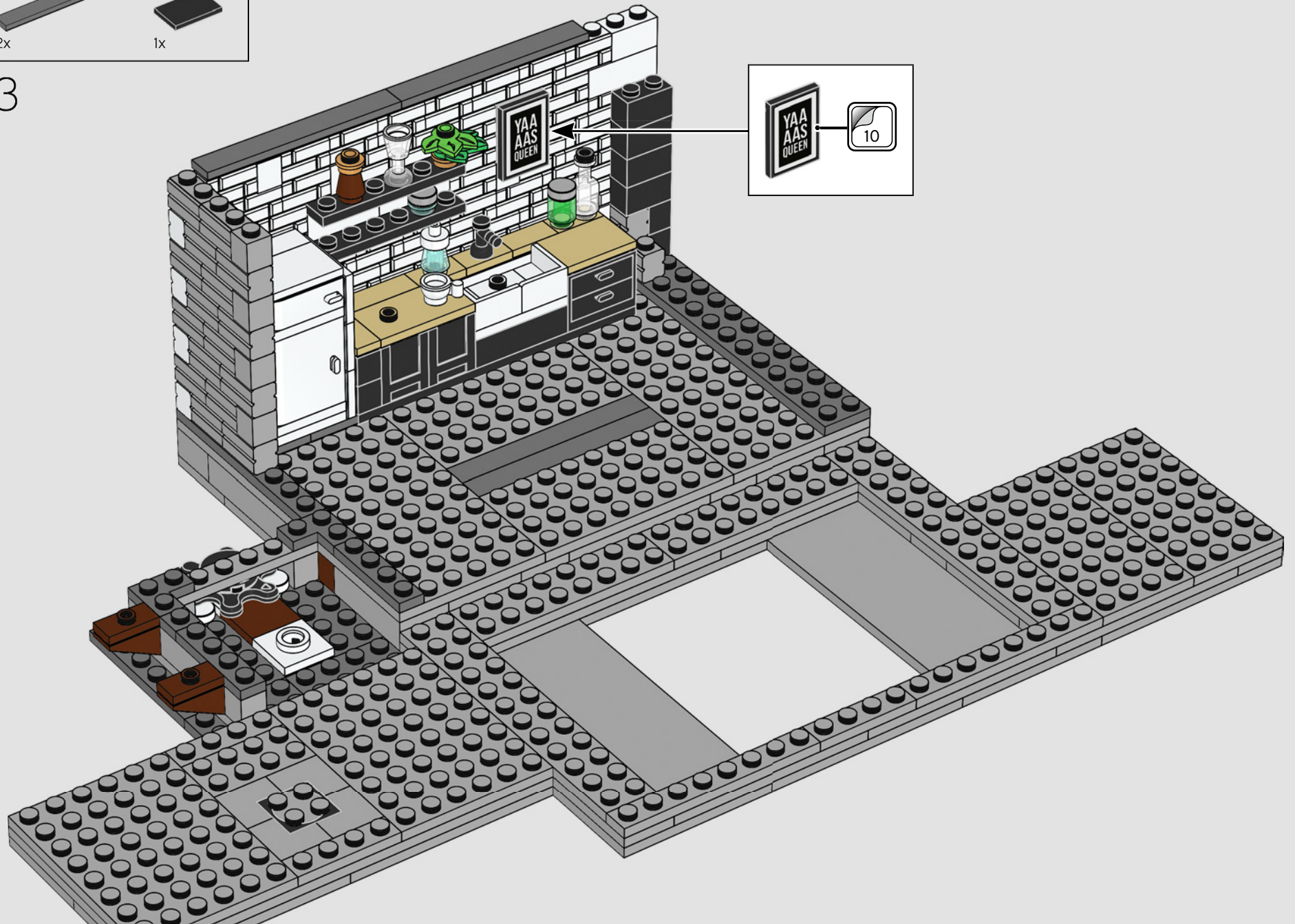

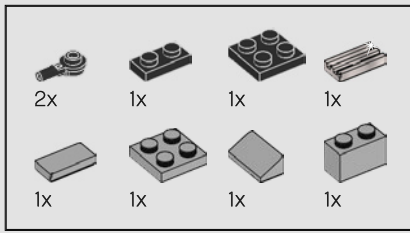

64

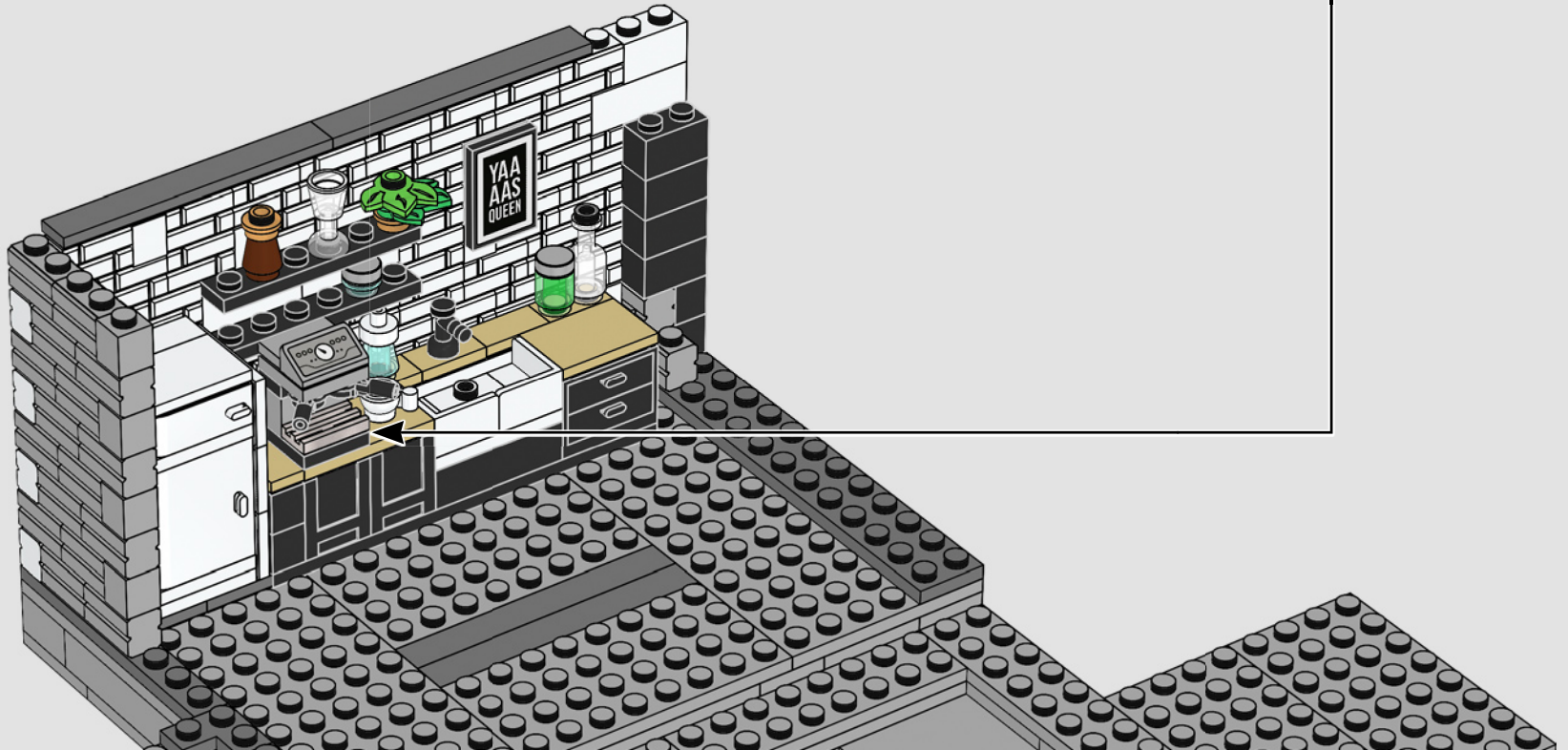
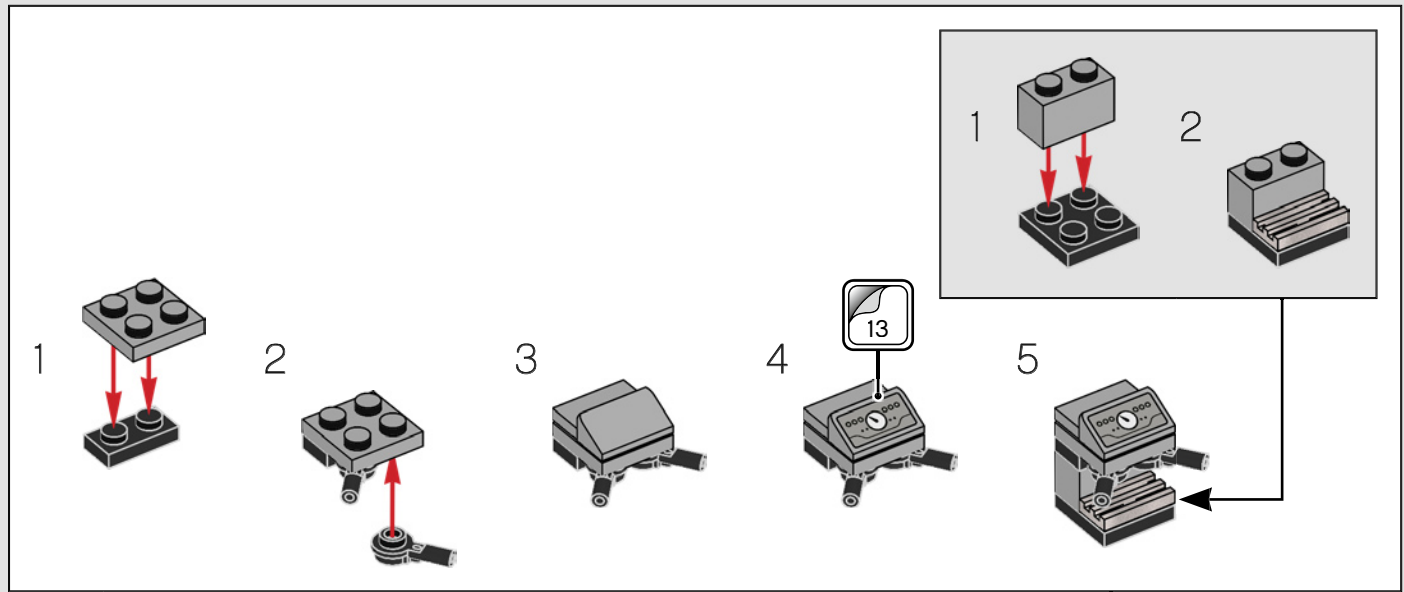

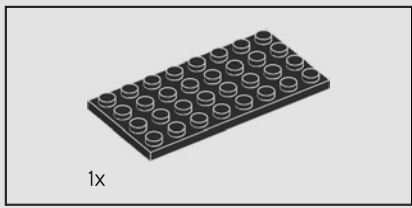

65

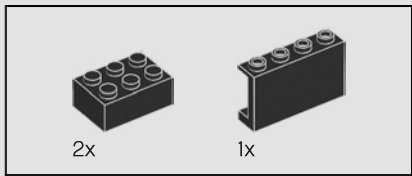
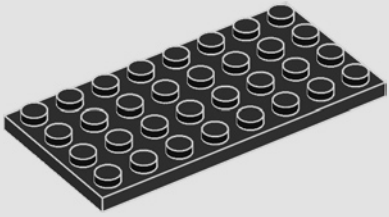

66

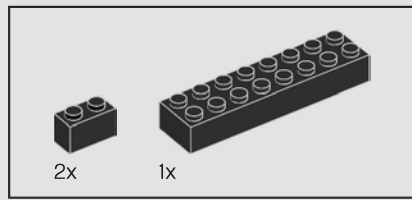
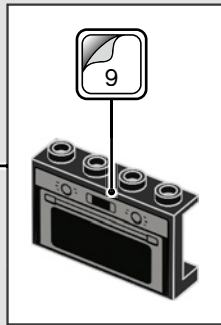
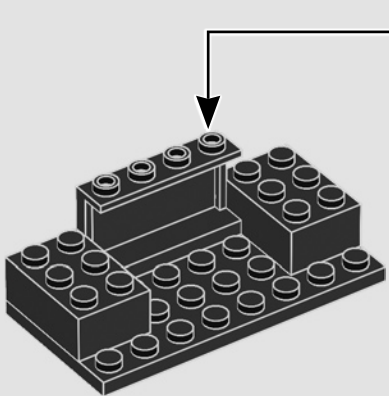

67

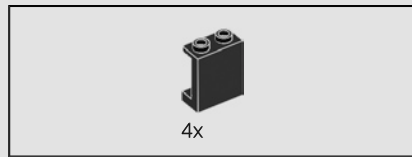
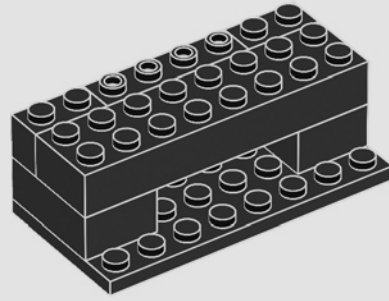

68

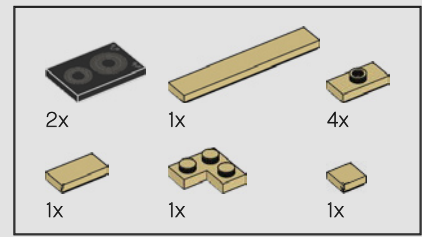
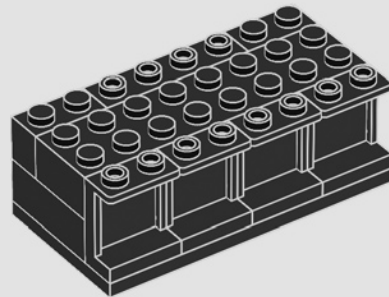

69

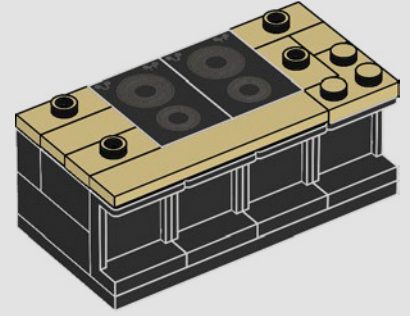

70

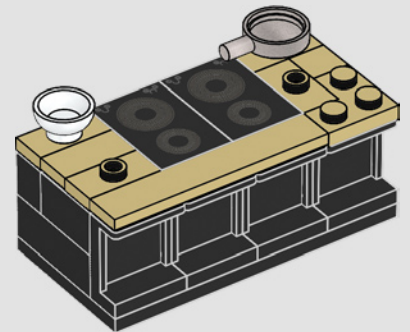

71

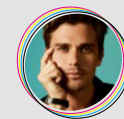
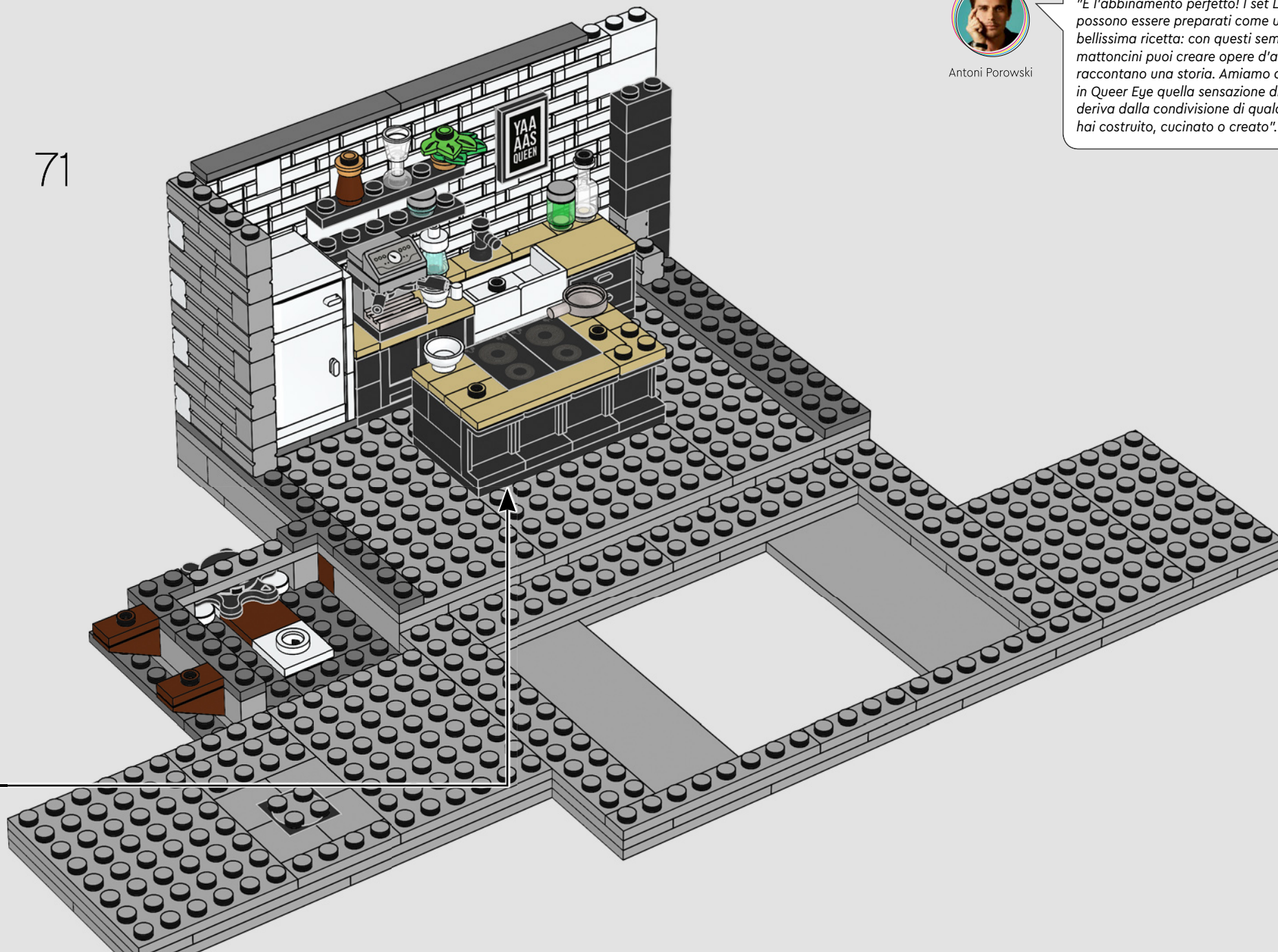

Antoni Porowski

"È l'abbinamento perfetto! I set LEGO® possono essere preparati come una bellissima ricetta: con questi semplici mattoncini puoi creare opere d'arte che raccontano una storia. Amiamo celebrare in Queer Eye quella sensazione di gioia che deriva dalla condivisione di qualcosa che hai costruito, cucinato o creato".

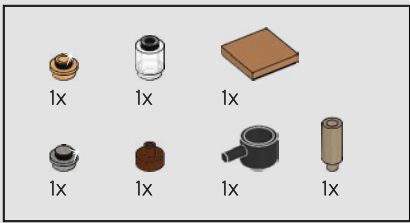

72

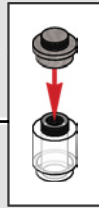
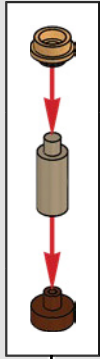
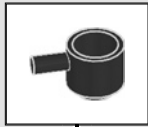
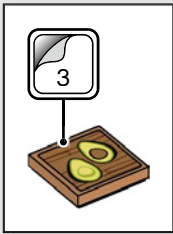

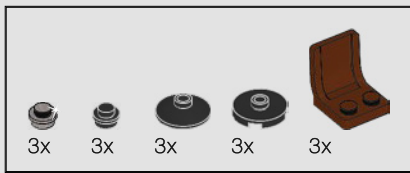

73

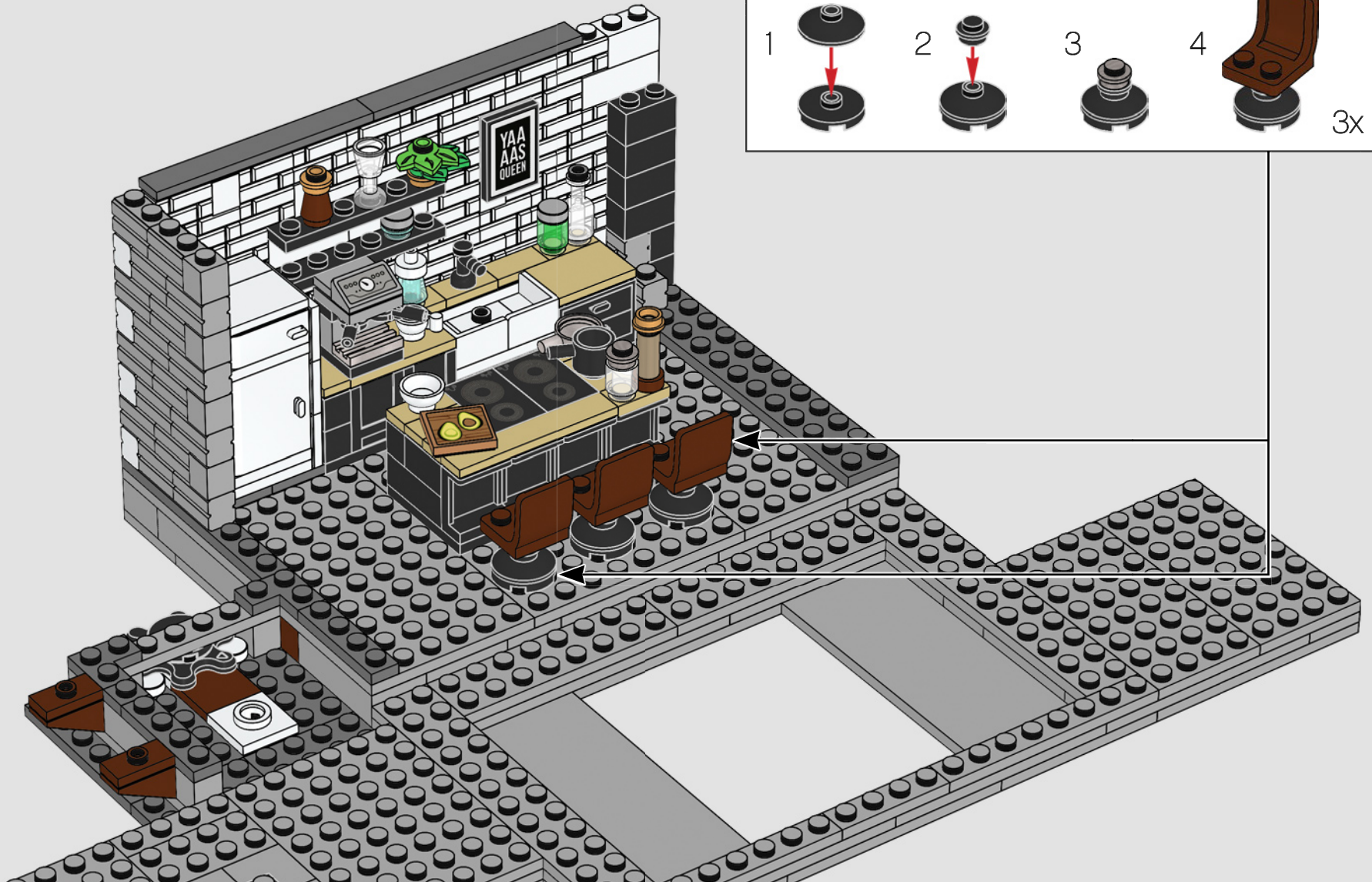
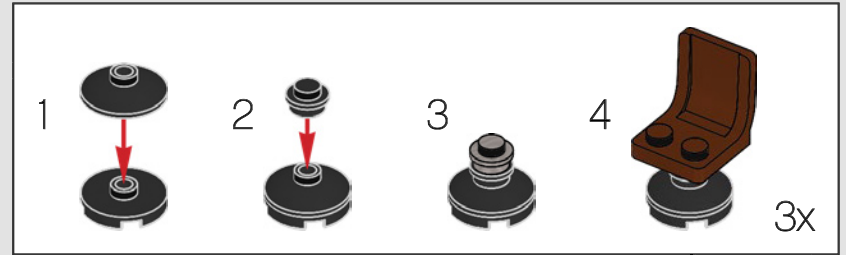

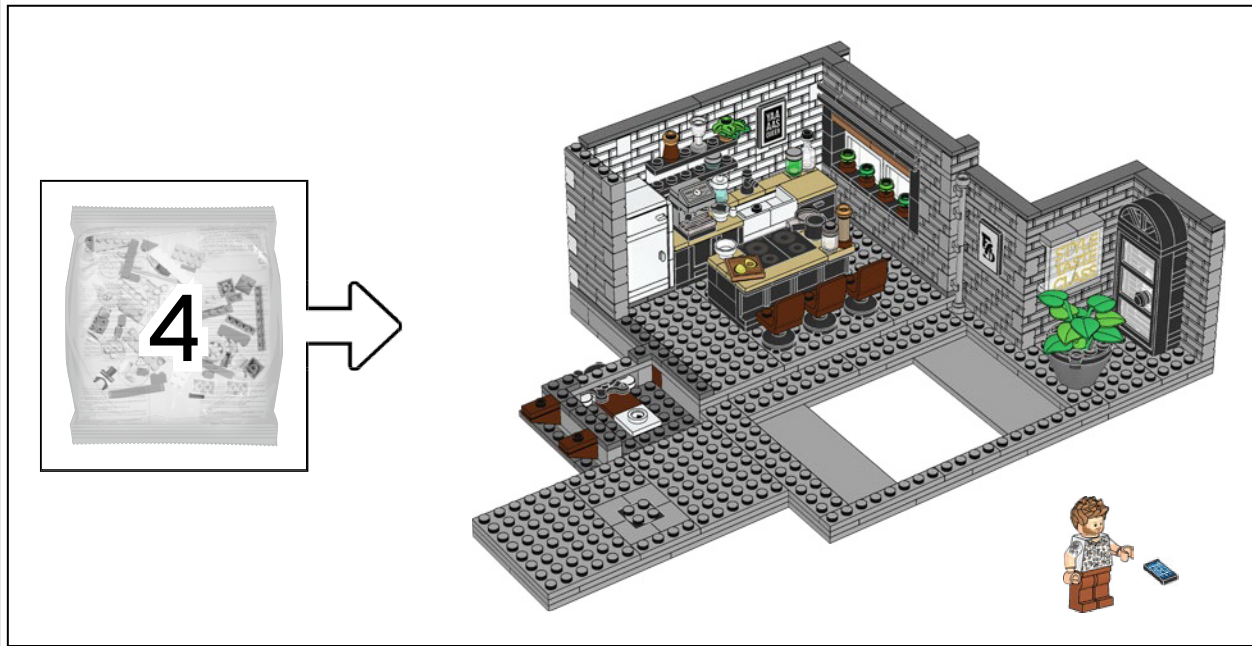

Bobby Berk

"È così surreale vedermi come minifigure LEGO®: se avessi 7 anni, rimarrei davvero sbalordito nello scoprire che una cosa del genere esiste davvero!"



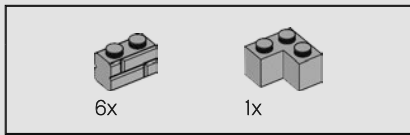

74



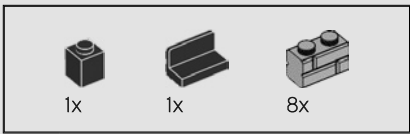

75

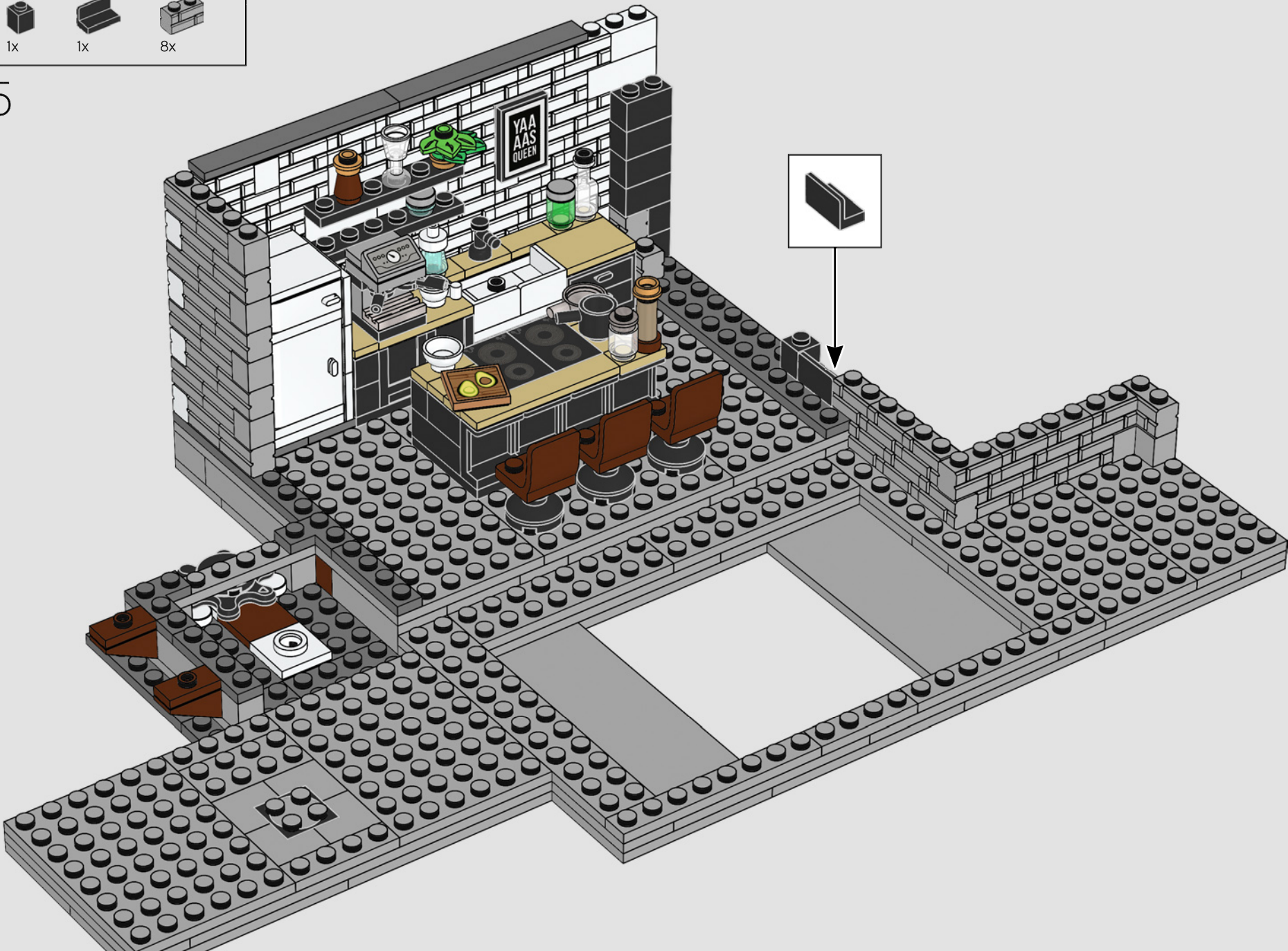

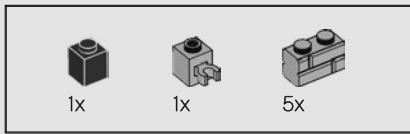

76

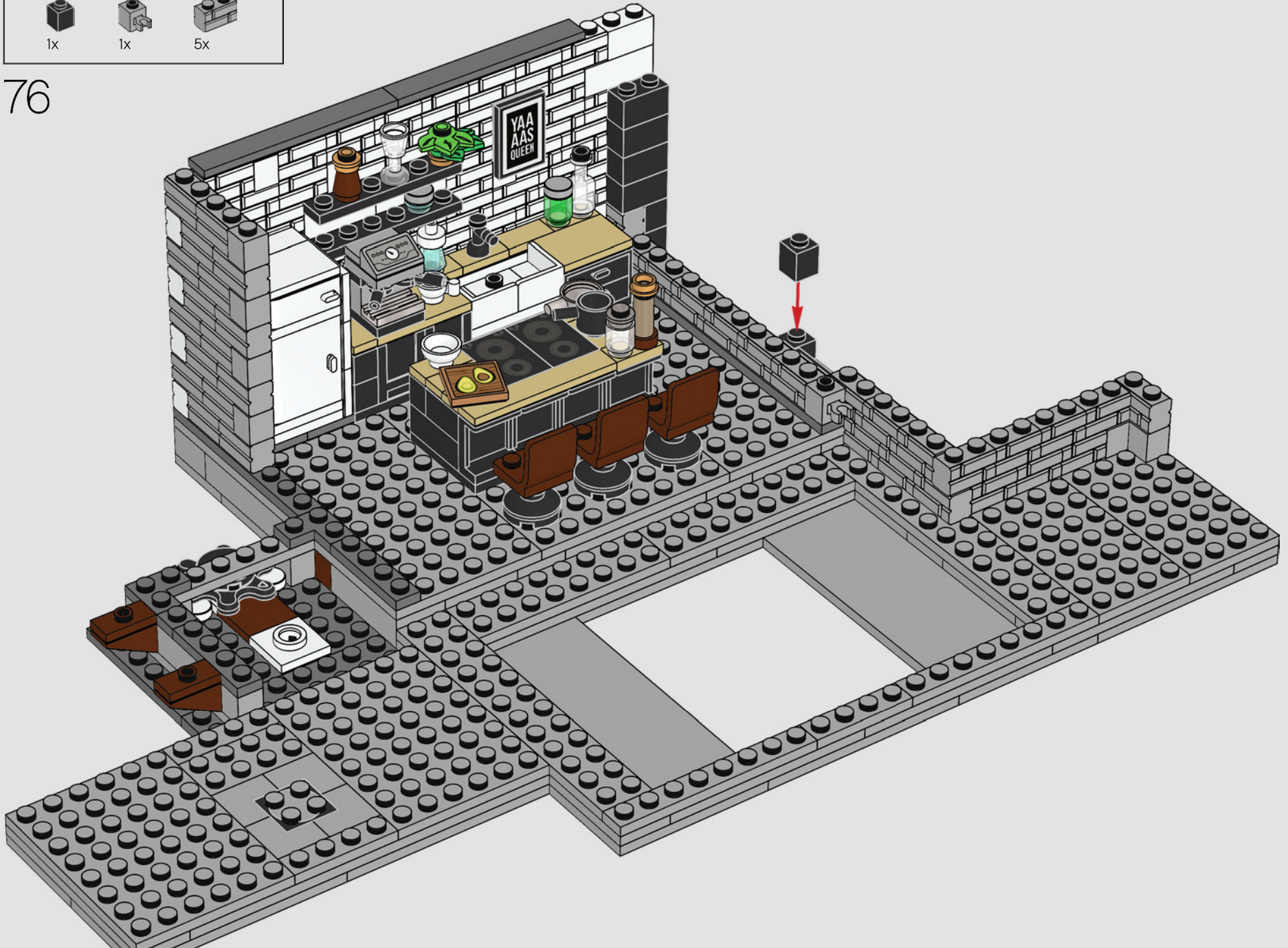

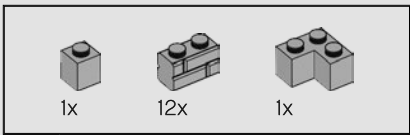

77

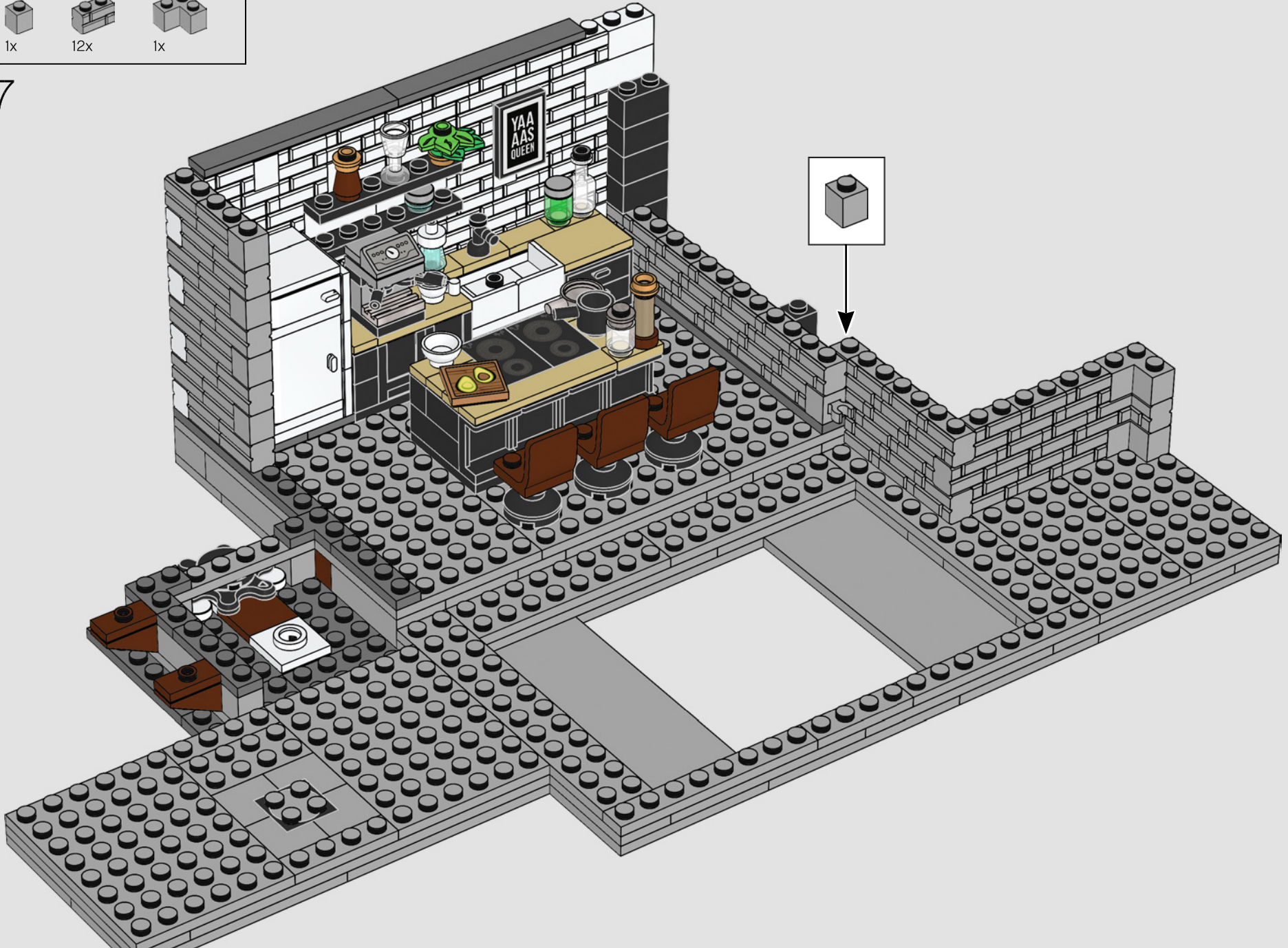



78

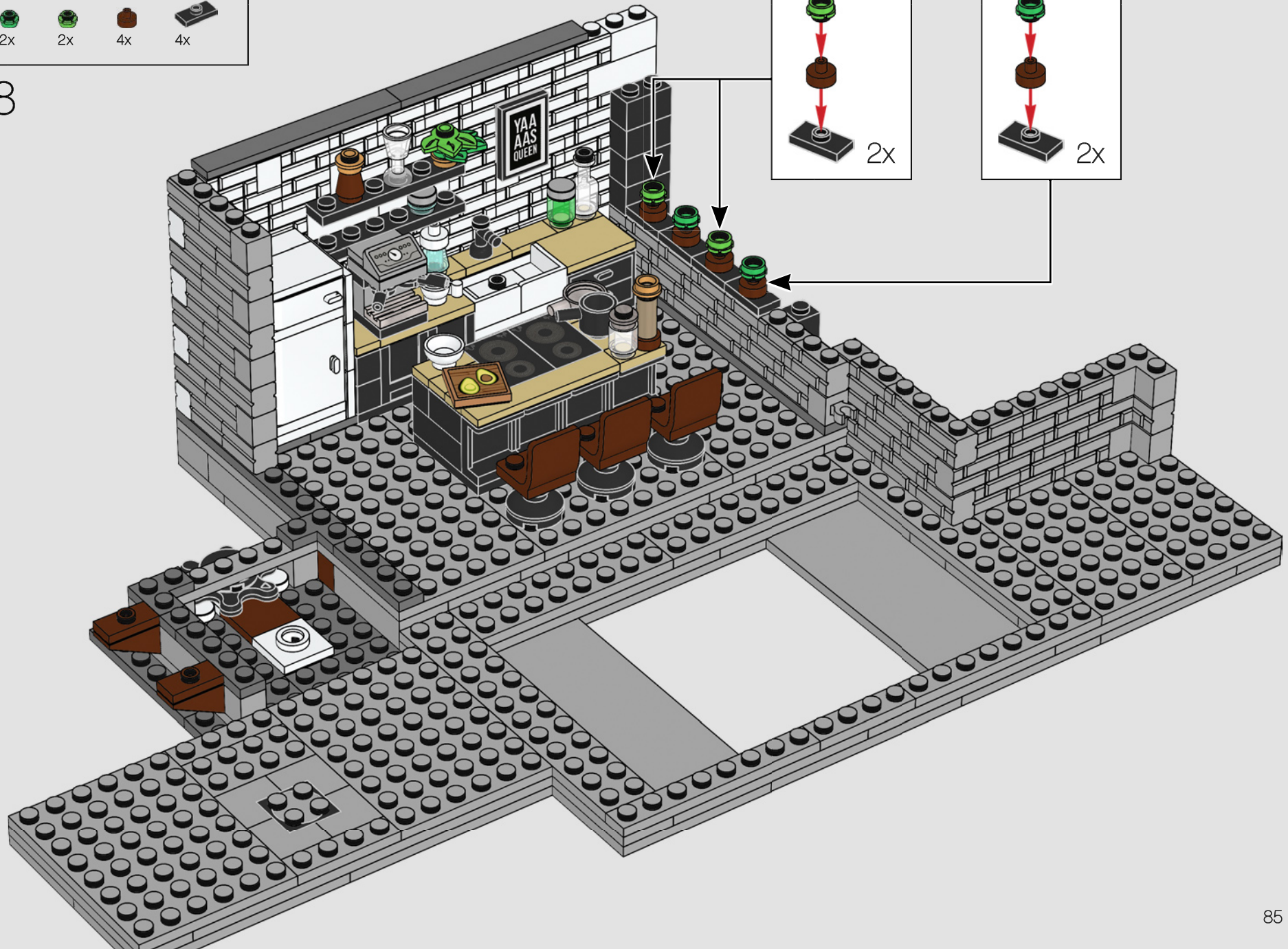
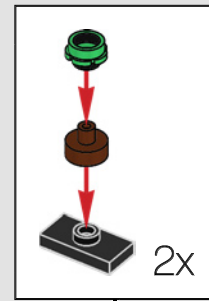
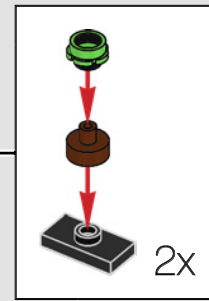

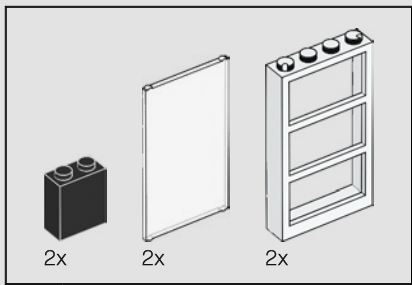

79

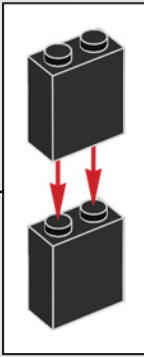
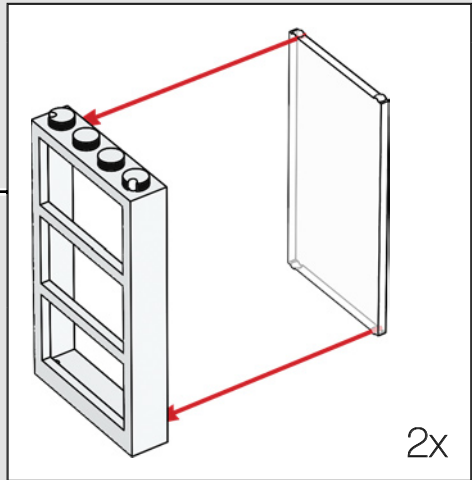
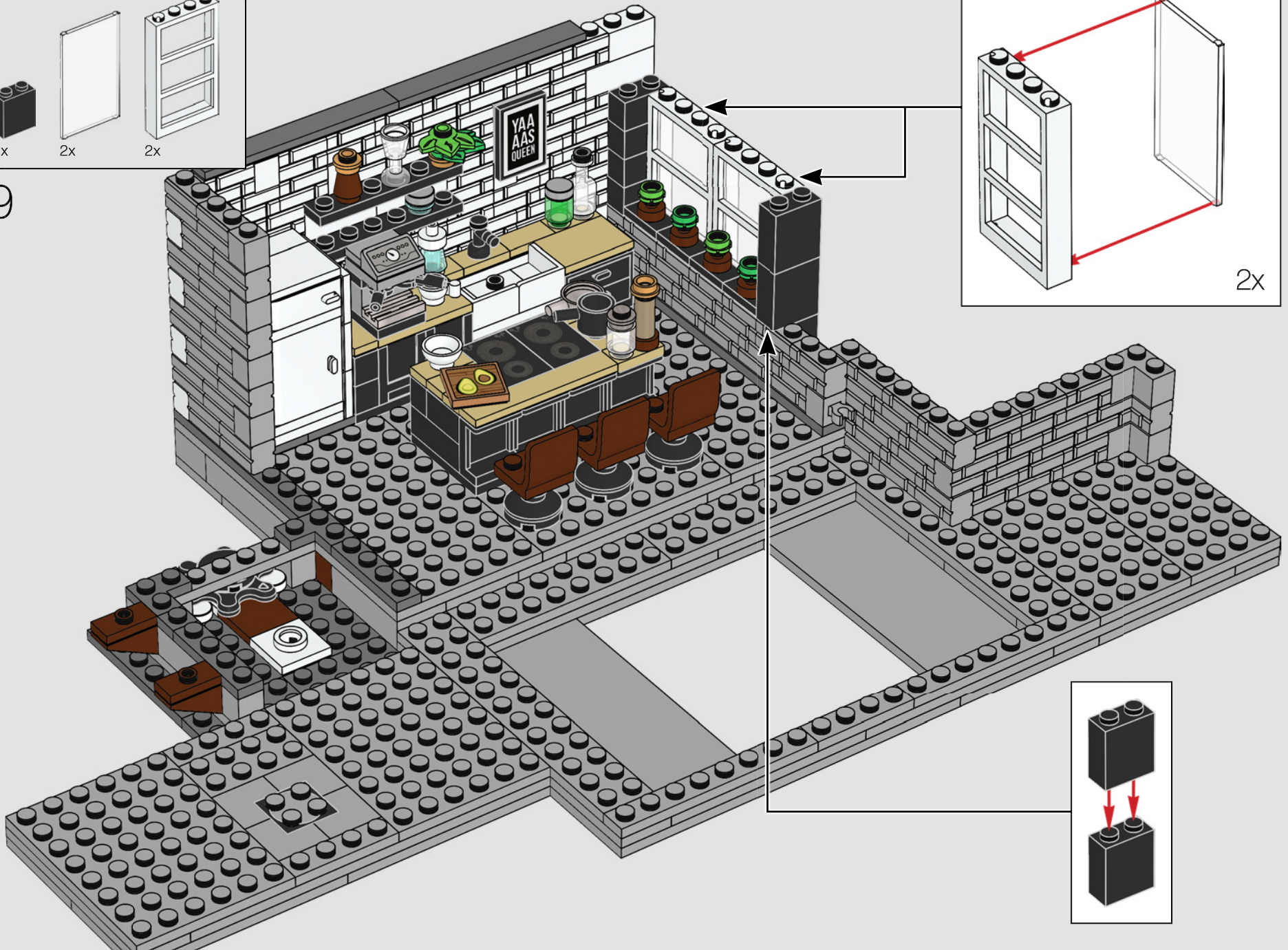

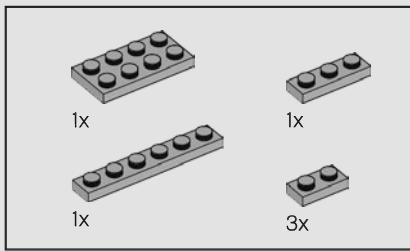

80

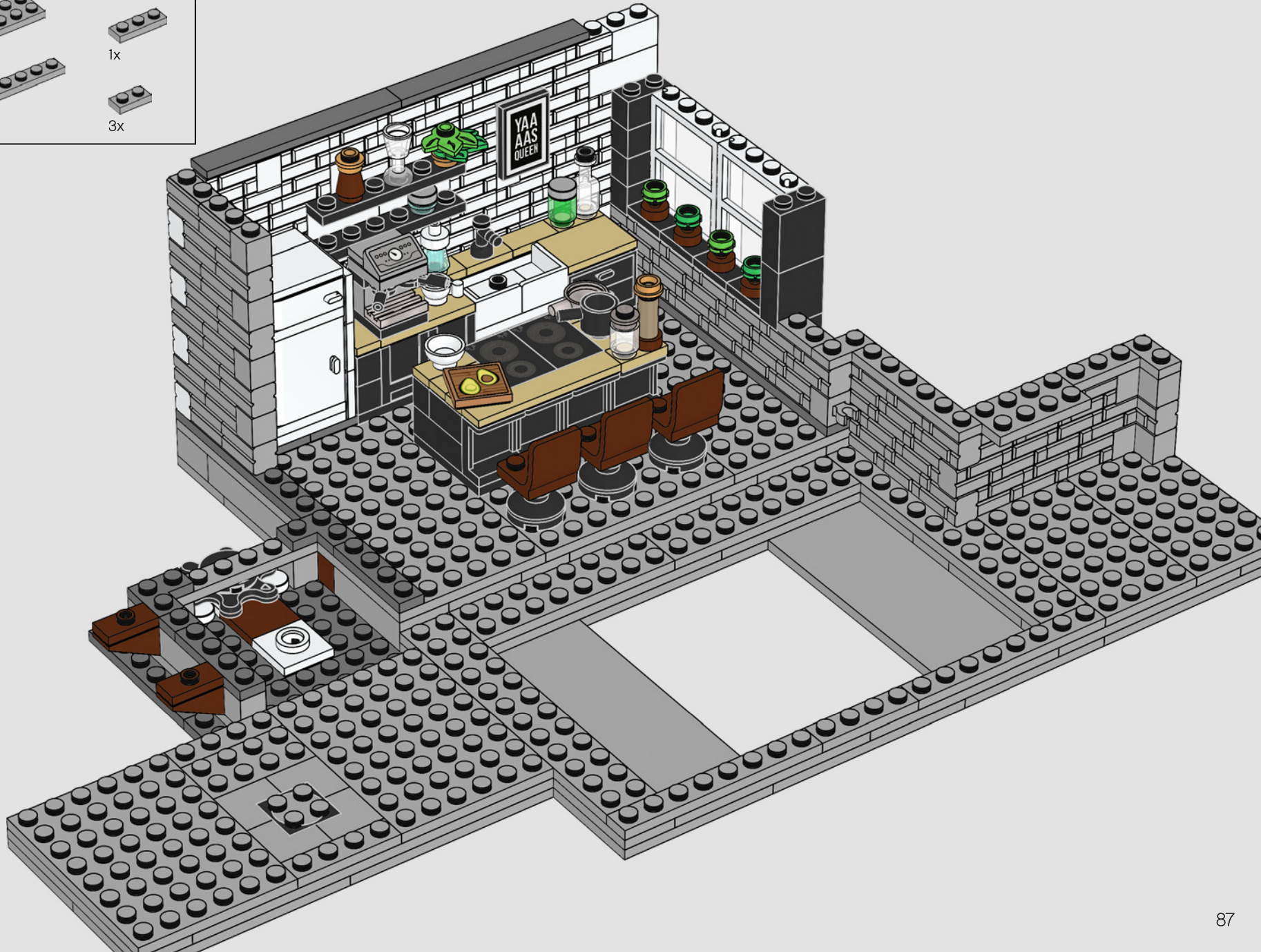

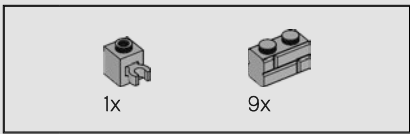

81



88

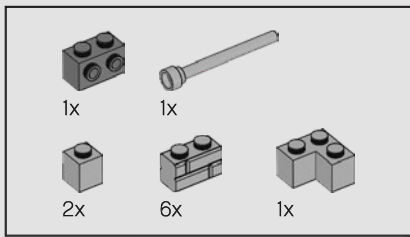

82

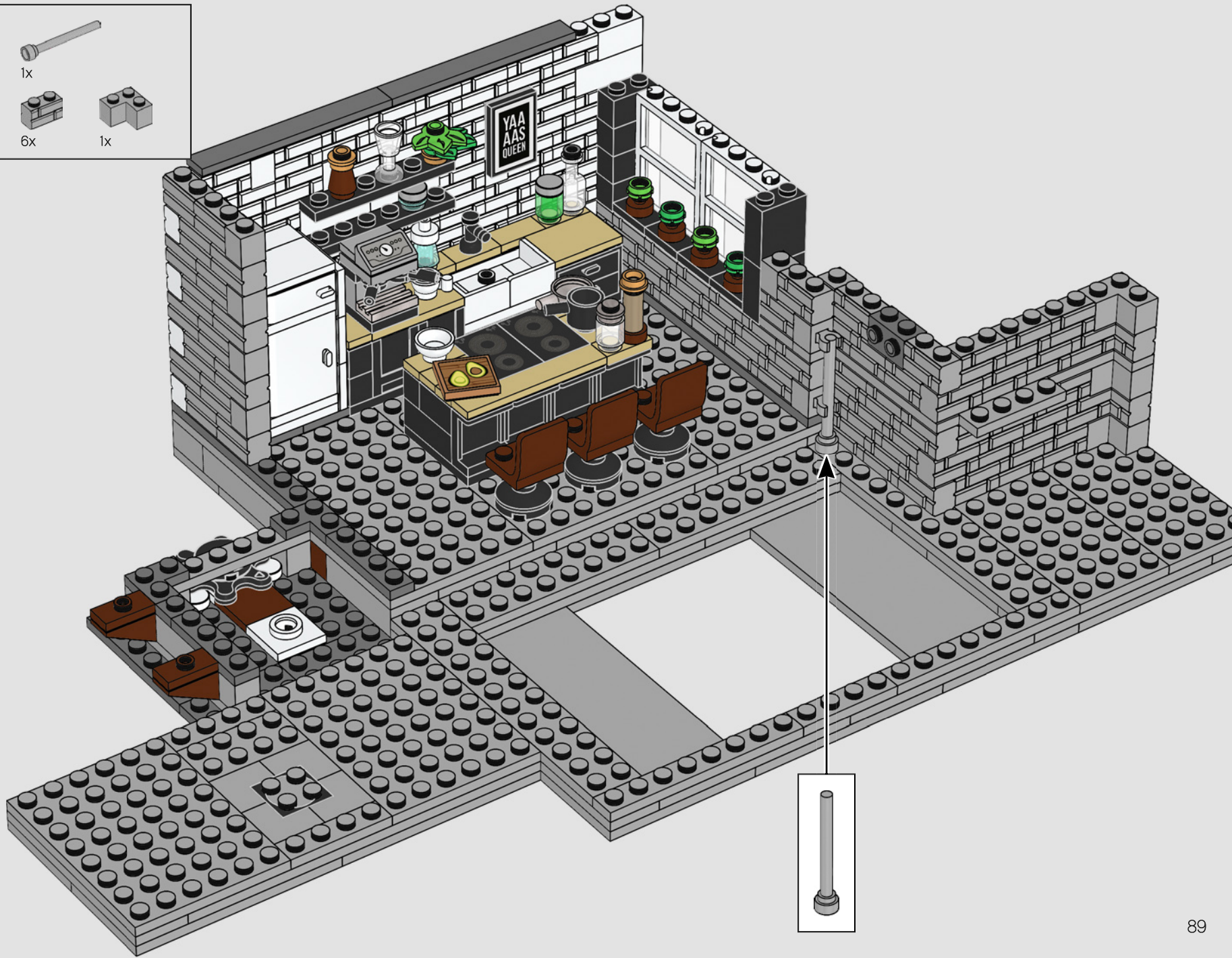

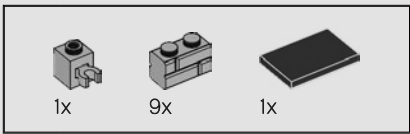

83

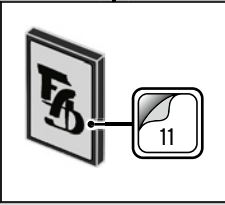
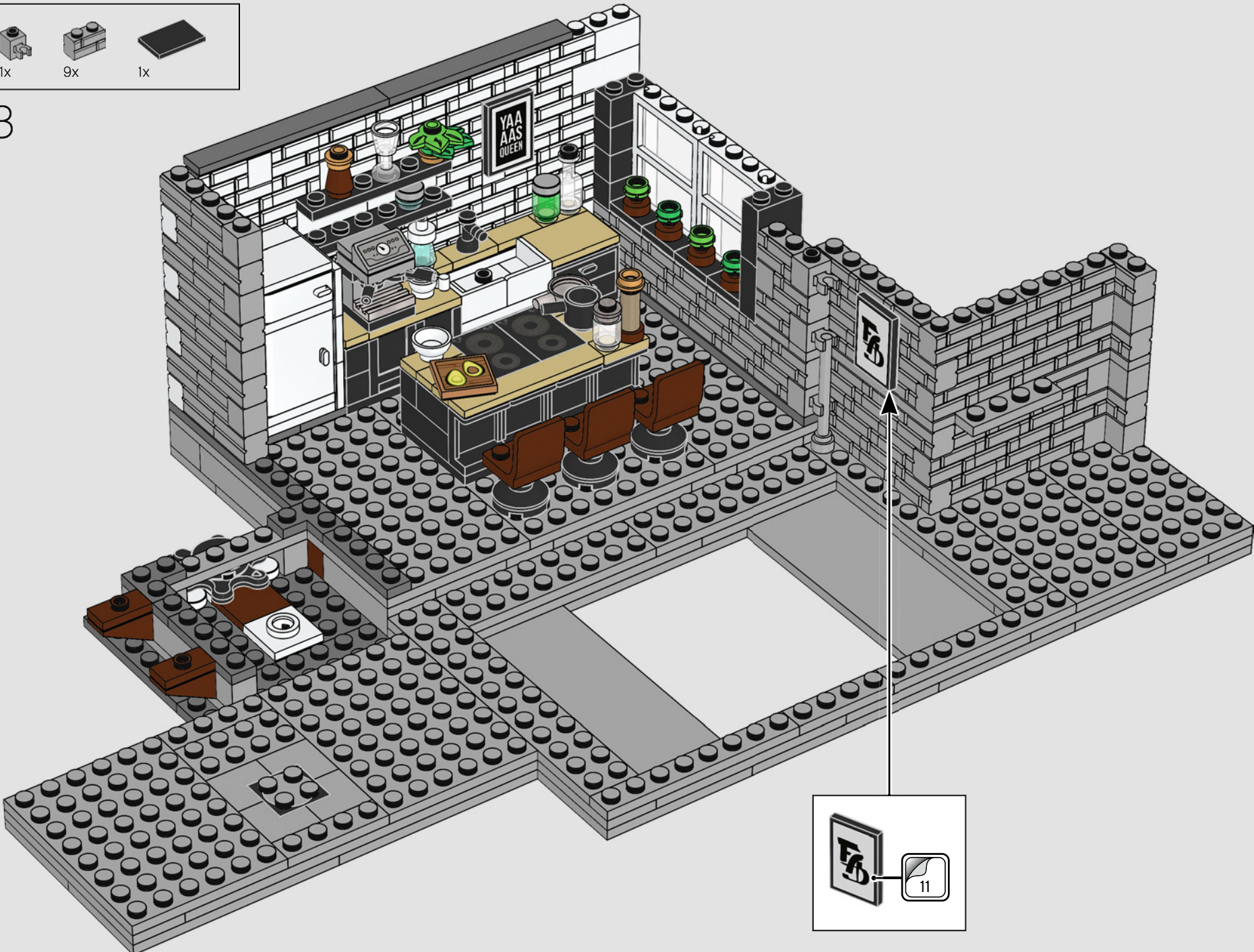

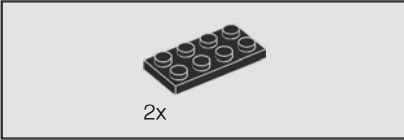
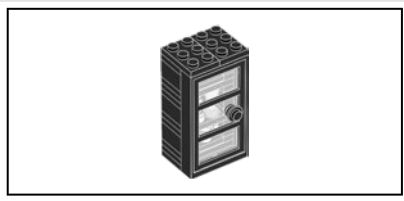

2x

84

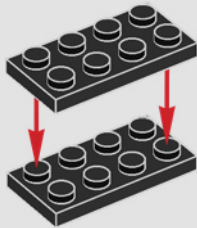

1x

2x

85

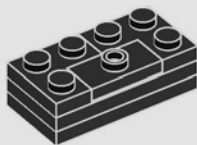

1x

1x

2x

86

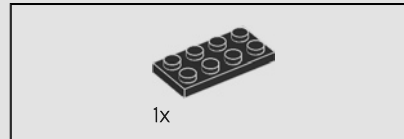
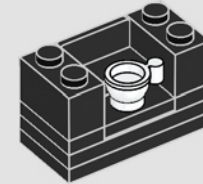

1x

87

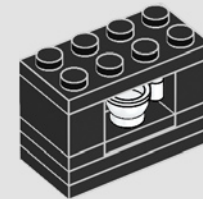



88

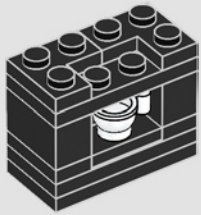

89



90

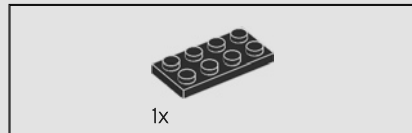

91

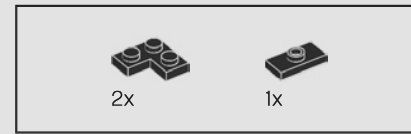

92

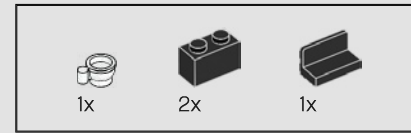

93



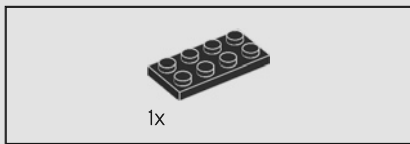

94

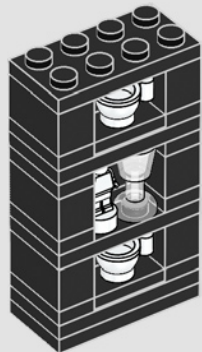

95

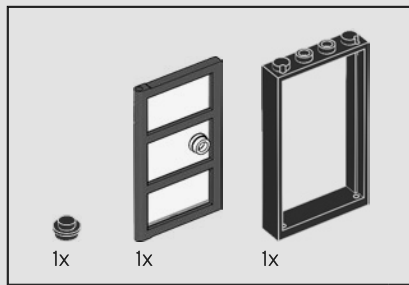
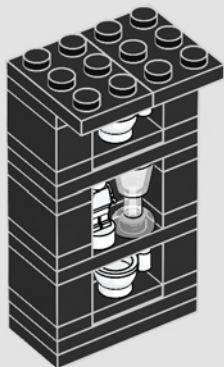

96

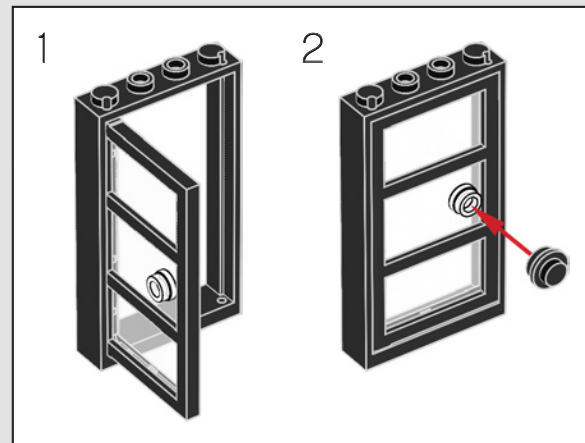
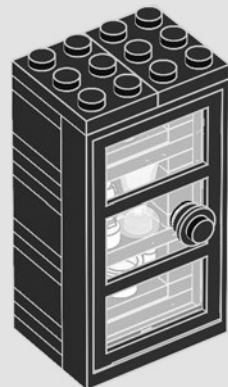

Antoni Porowski

"Durante la mia infanzia, le costruzioni LEGO® erano il mio giocattolo preferito. Costruivo città, navi pirata, distruggevo ogni cosa e ricominciavo daccapo. È davvero incredibile pensare che i bambini ora avranno opzioni LGBTQ+ con cui giocare e con cui costruire. Sono onorato di far parte di questa partnership speciale. L'Antoni di dieci anni sta urlando internamente!"

97

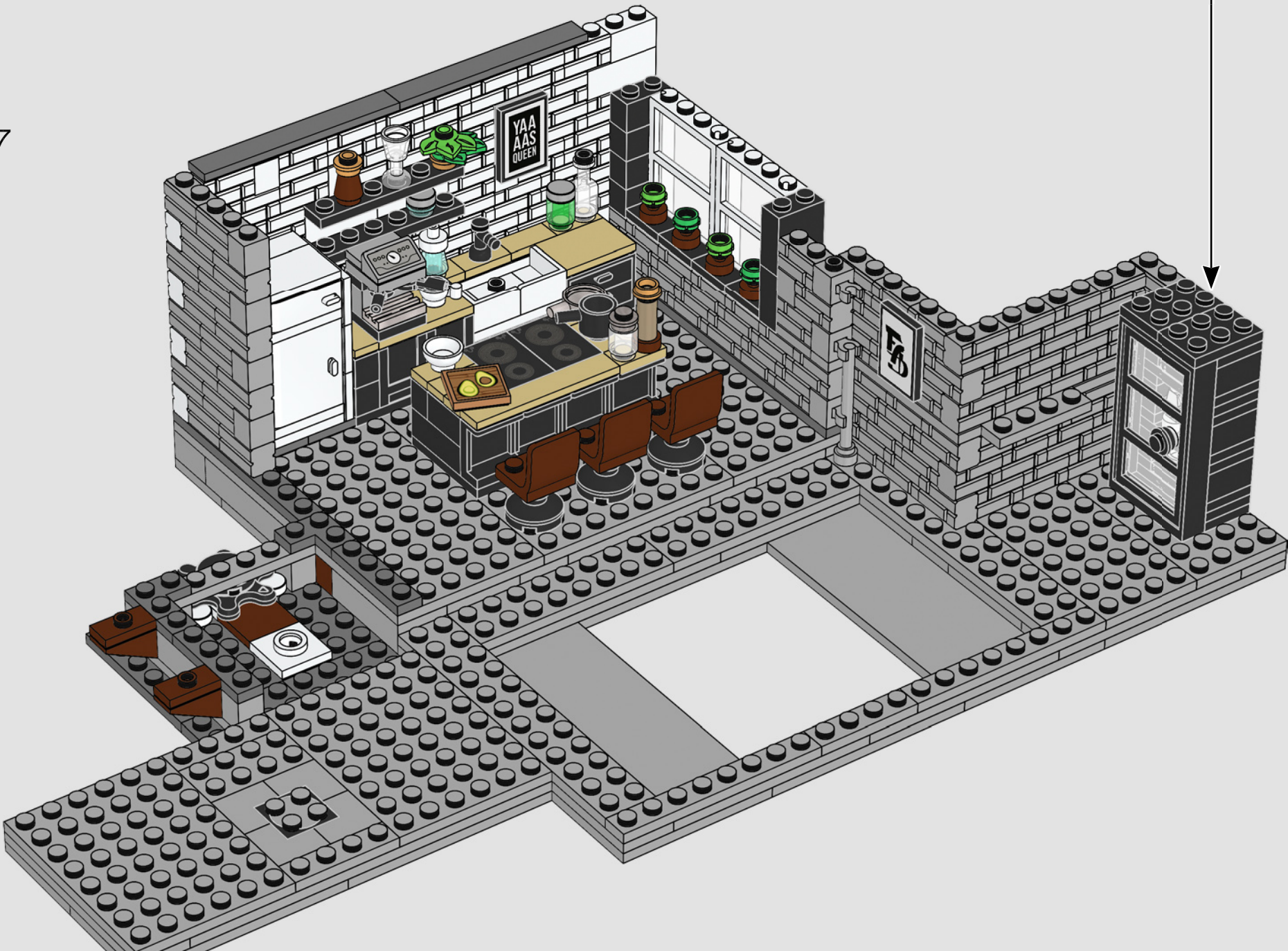

94

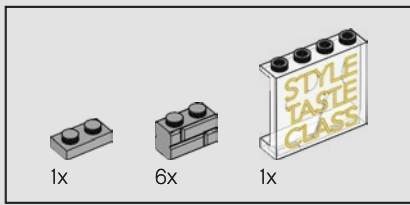

98

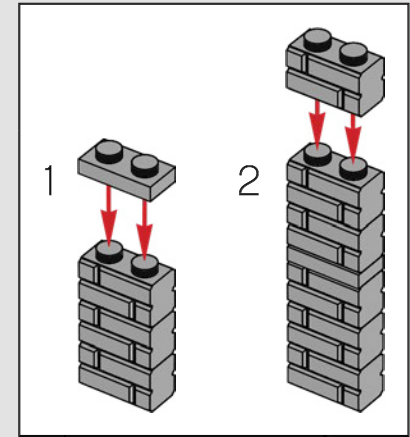
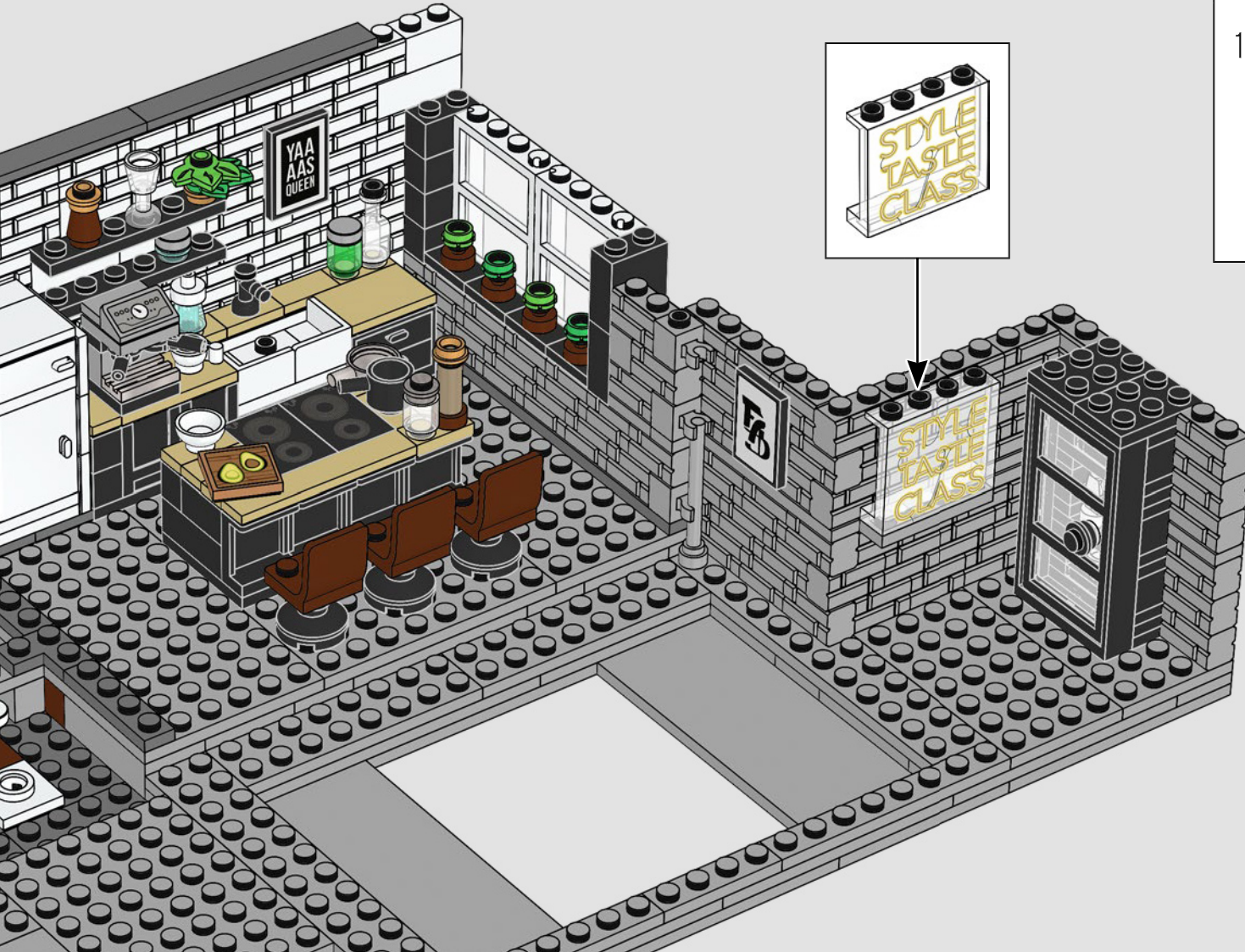

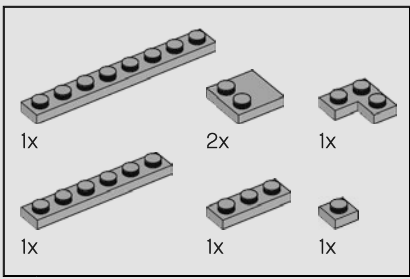

99



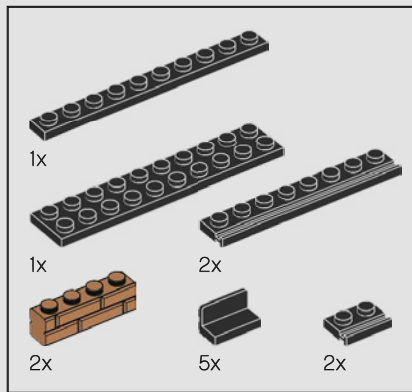

Tan France

"Noi, i Fab Five, siamo tutti ragazzini nel cuore, e quello che facciamo in Queer Eye a volte sembra più un gioco che un lavoro. È una scelta davvero naturale per noi collaborare a questo set LEGO®, un giocattolo così amato dai bambini di tutte le età!"

100

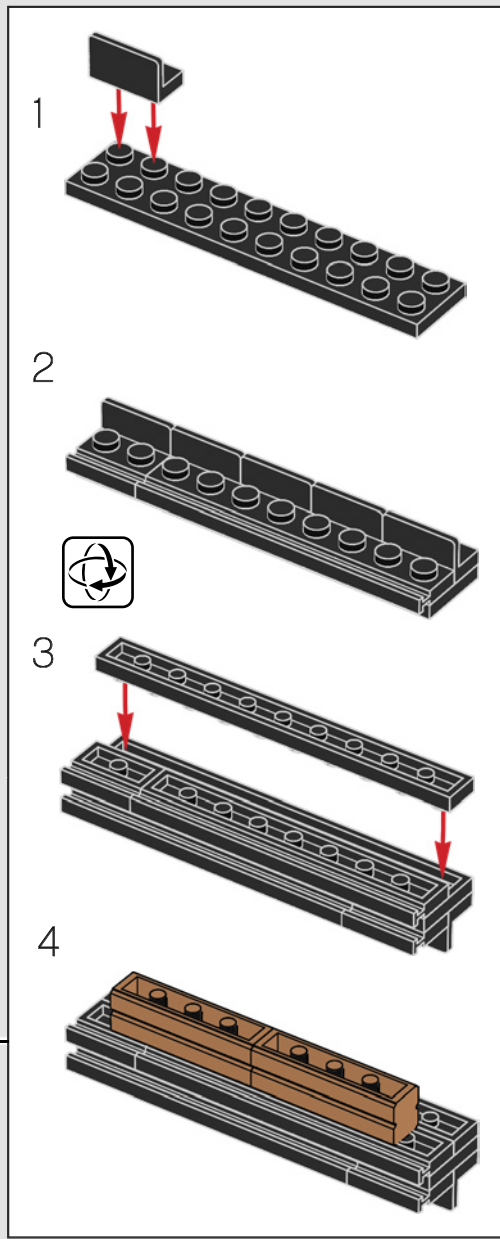

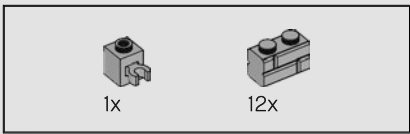

101



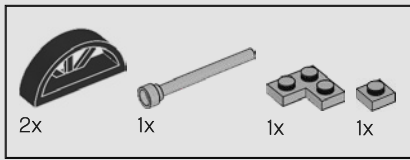

102

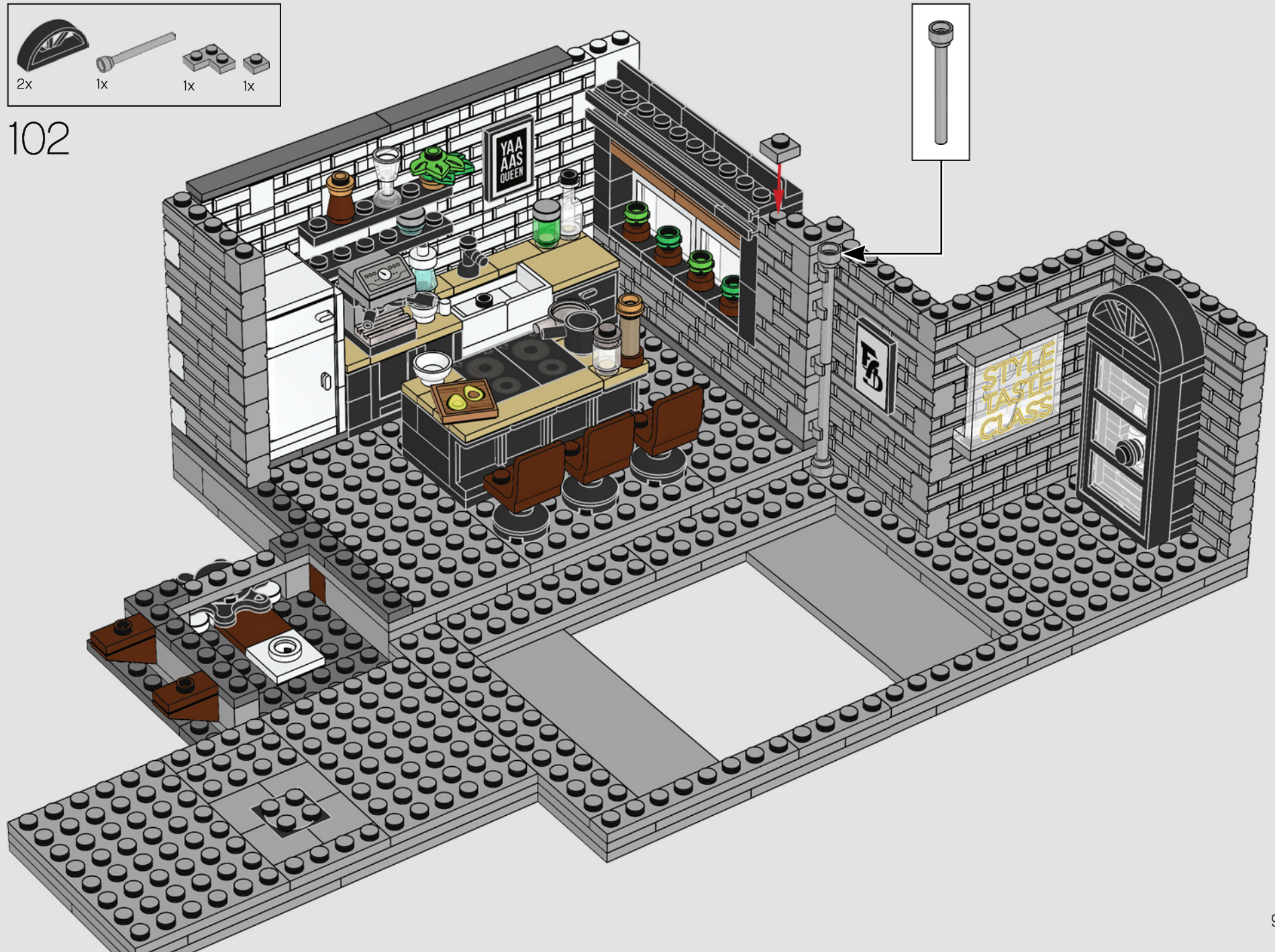



7x

103

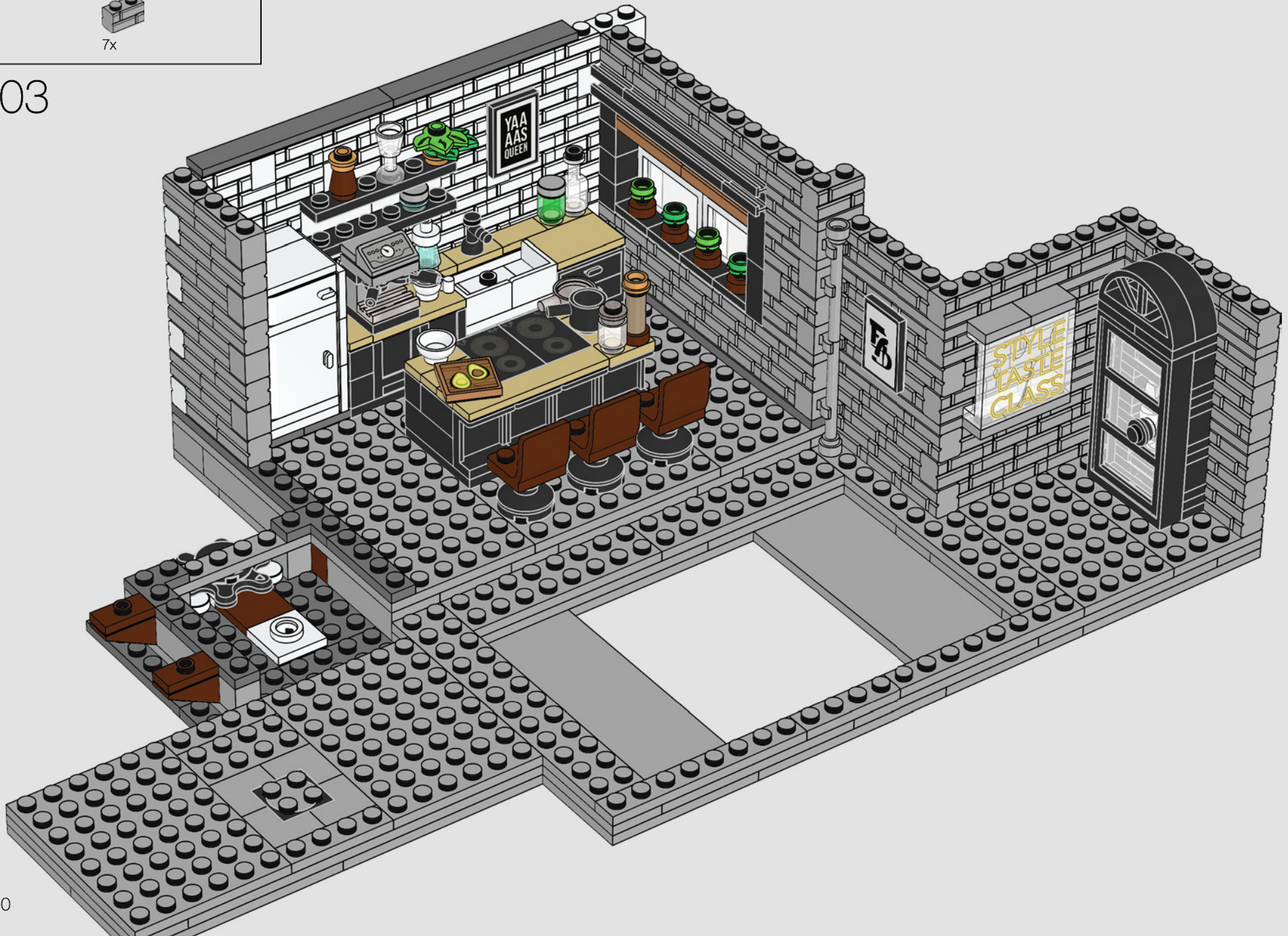

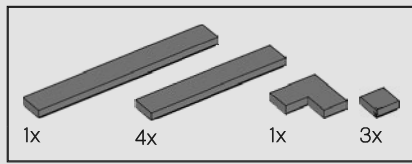

104



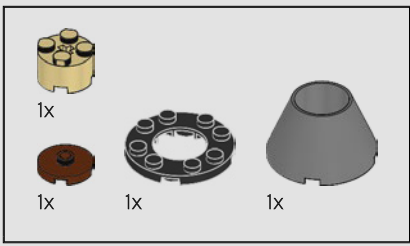

105

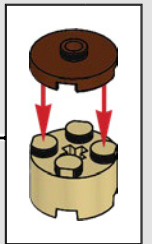
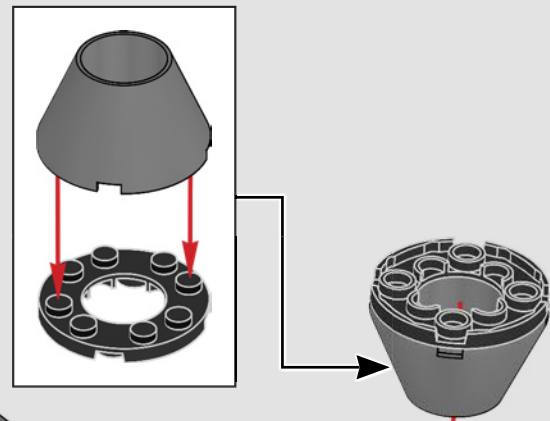

102

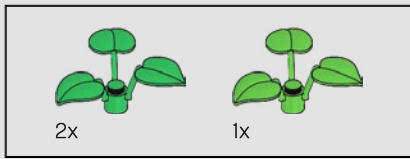

106

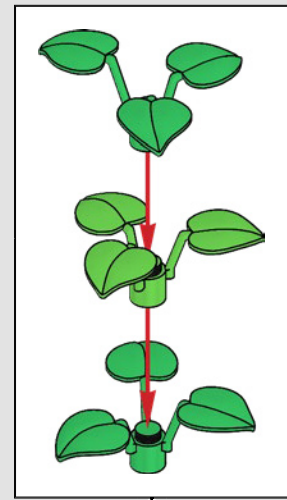
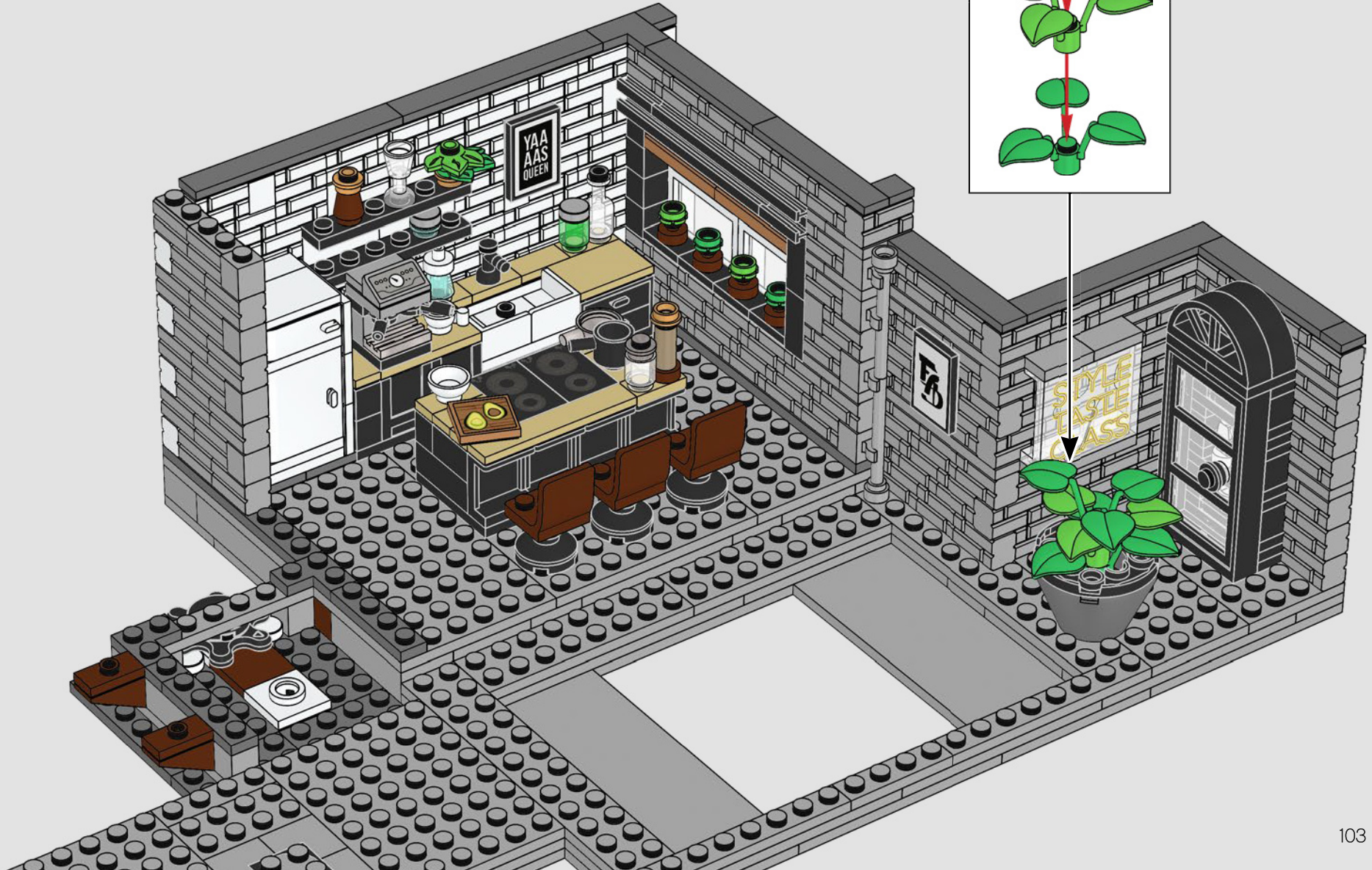

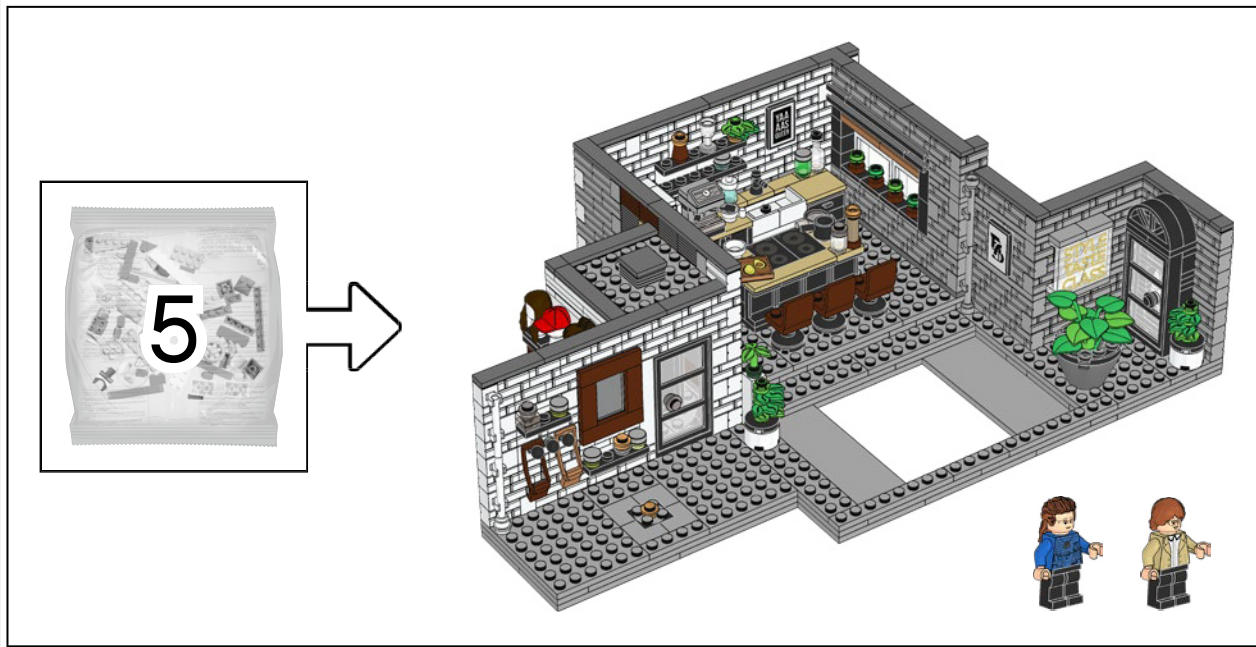

Jonathan Van Ness

"Sono molto felice che questo set contenga Kathi Dooley! È la mia eroina d'infanzia e significa così tanto per me. Inoltre, posso giocare a tagliare i suoi capelli tutte le volte che lo desidero adesso".



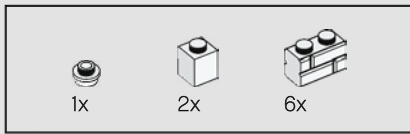

107



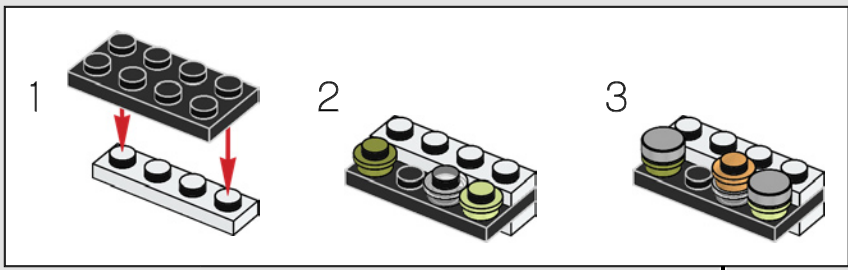
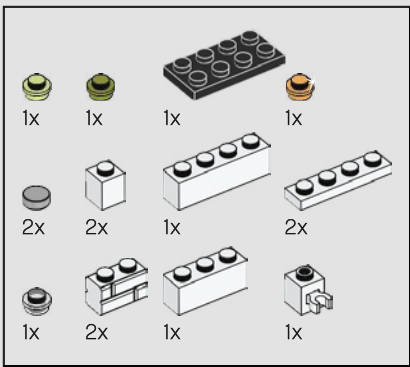

108



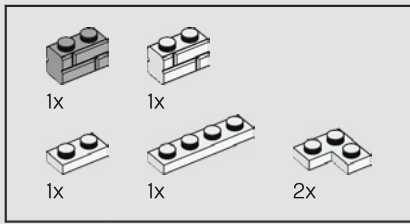

109



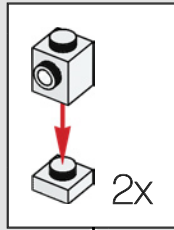
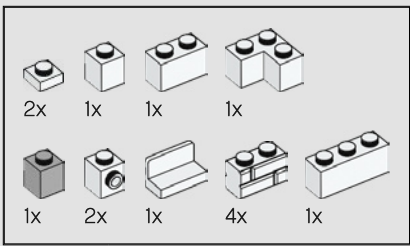

110



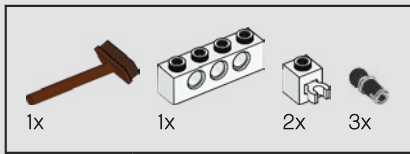

111

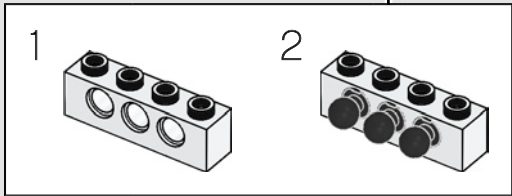
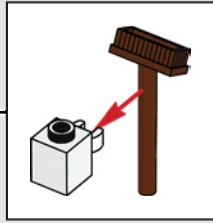

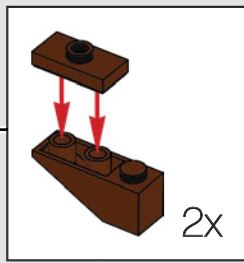
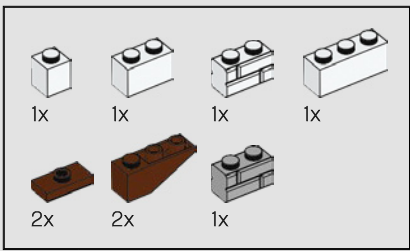

112



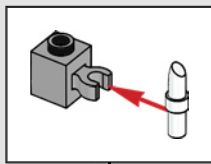
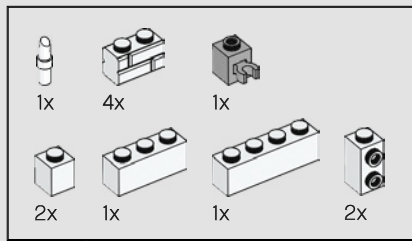

113



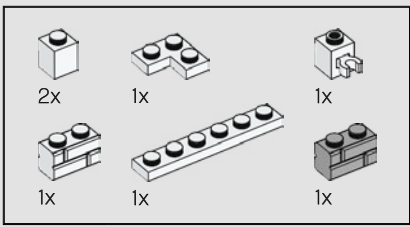

114



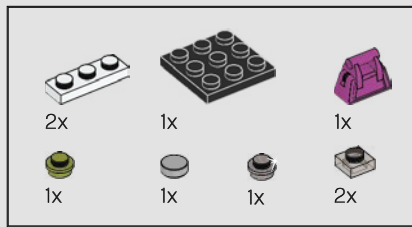

115

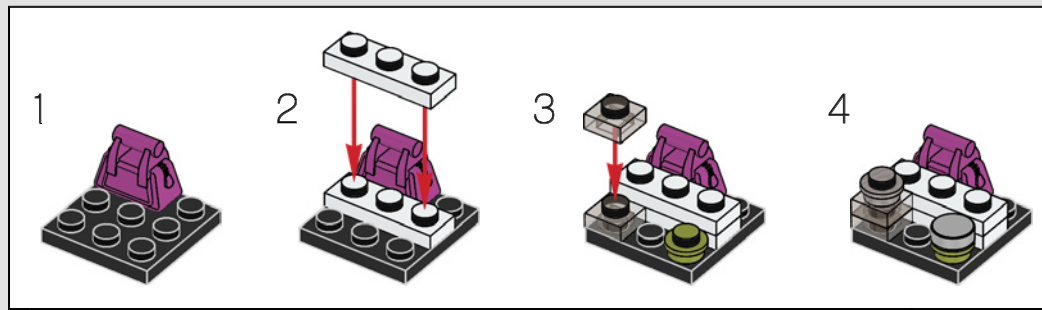

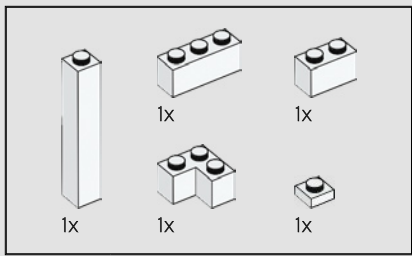

116



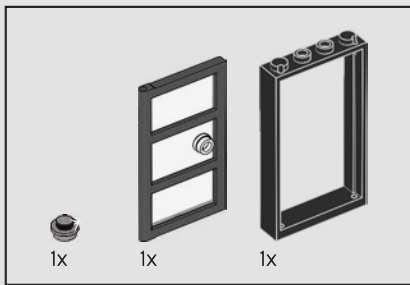

117

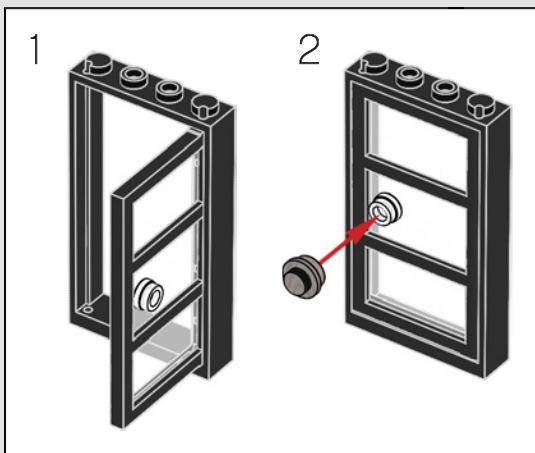

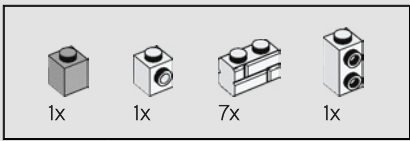

118



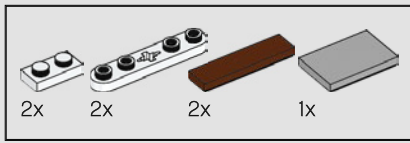

119

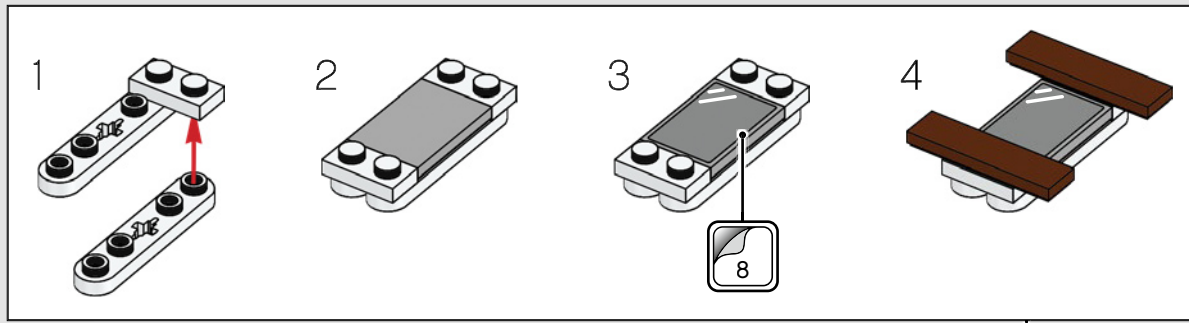

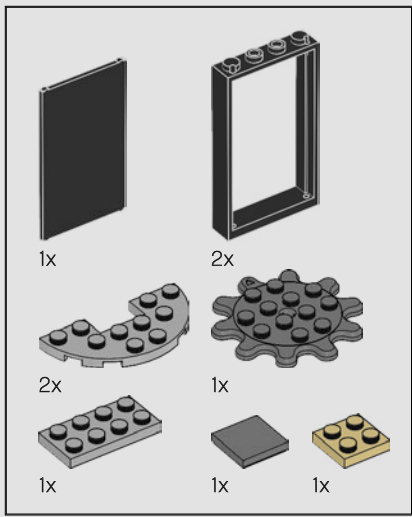

120

1

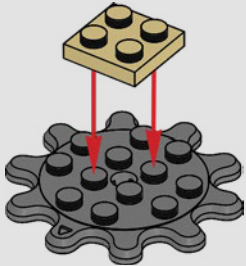

2

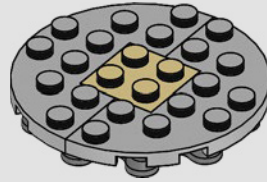

3

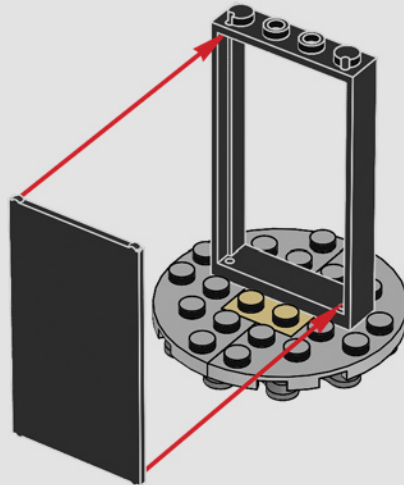

4

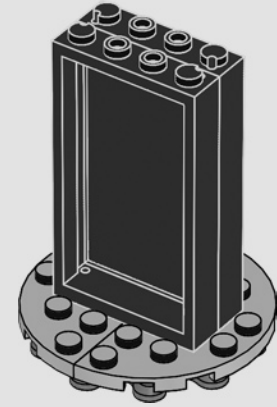

5

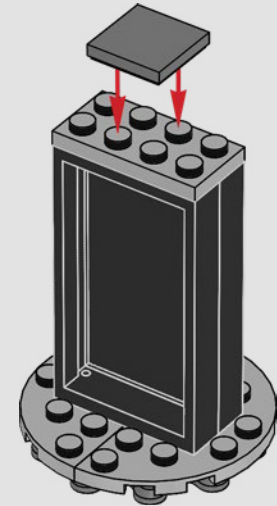

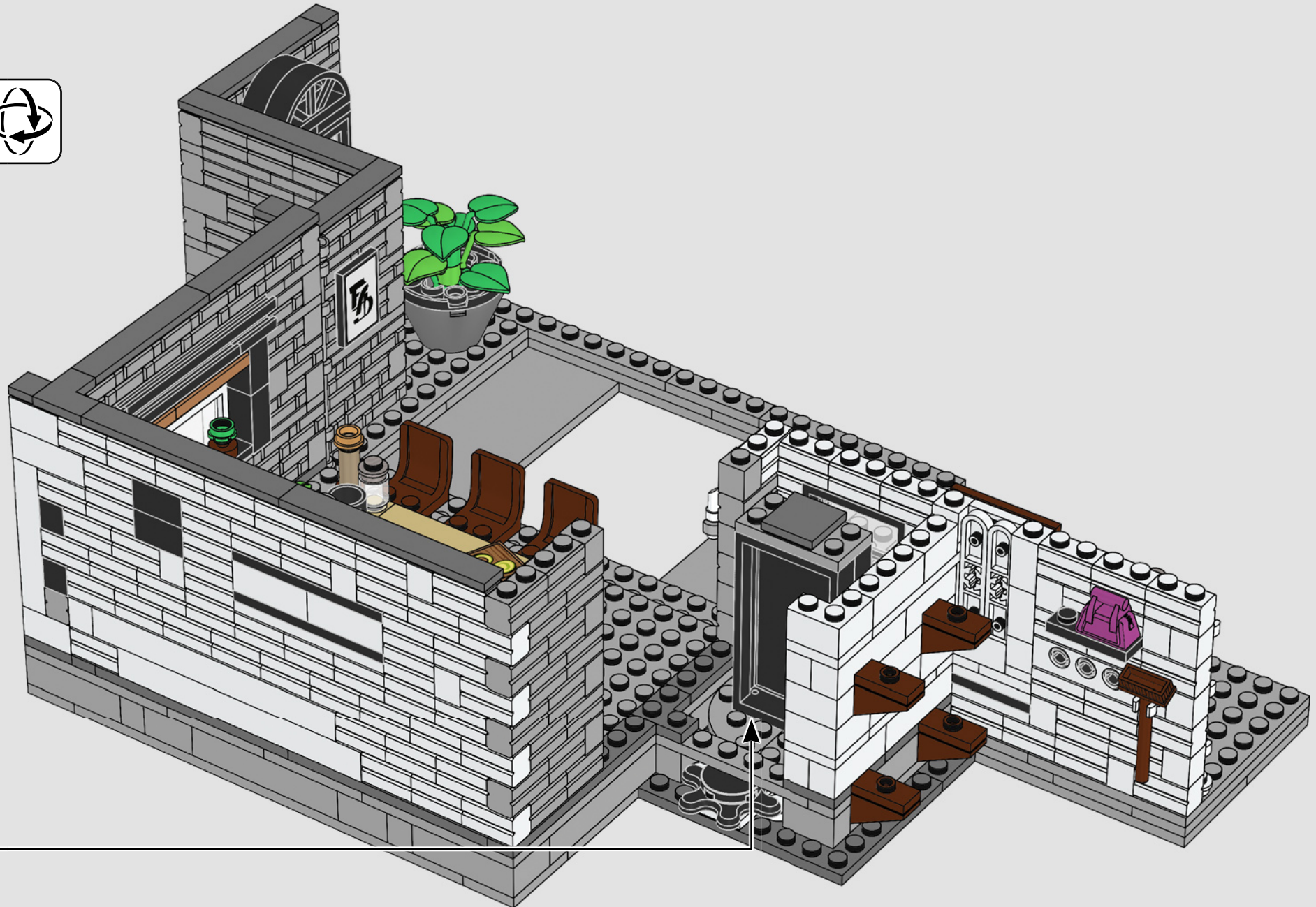

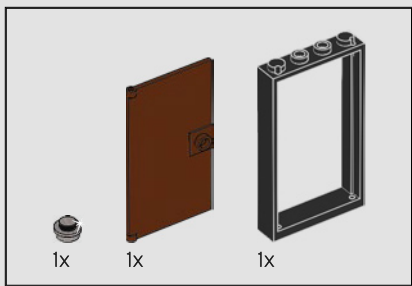

121

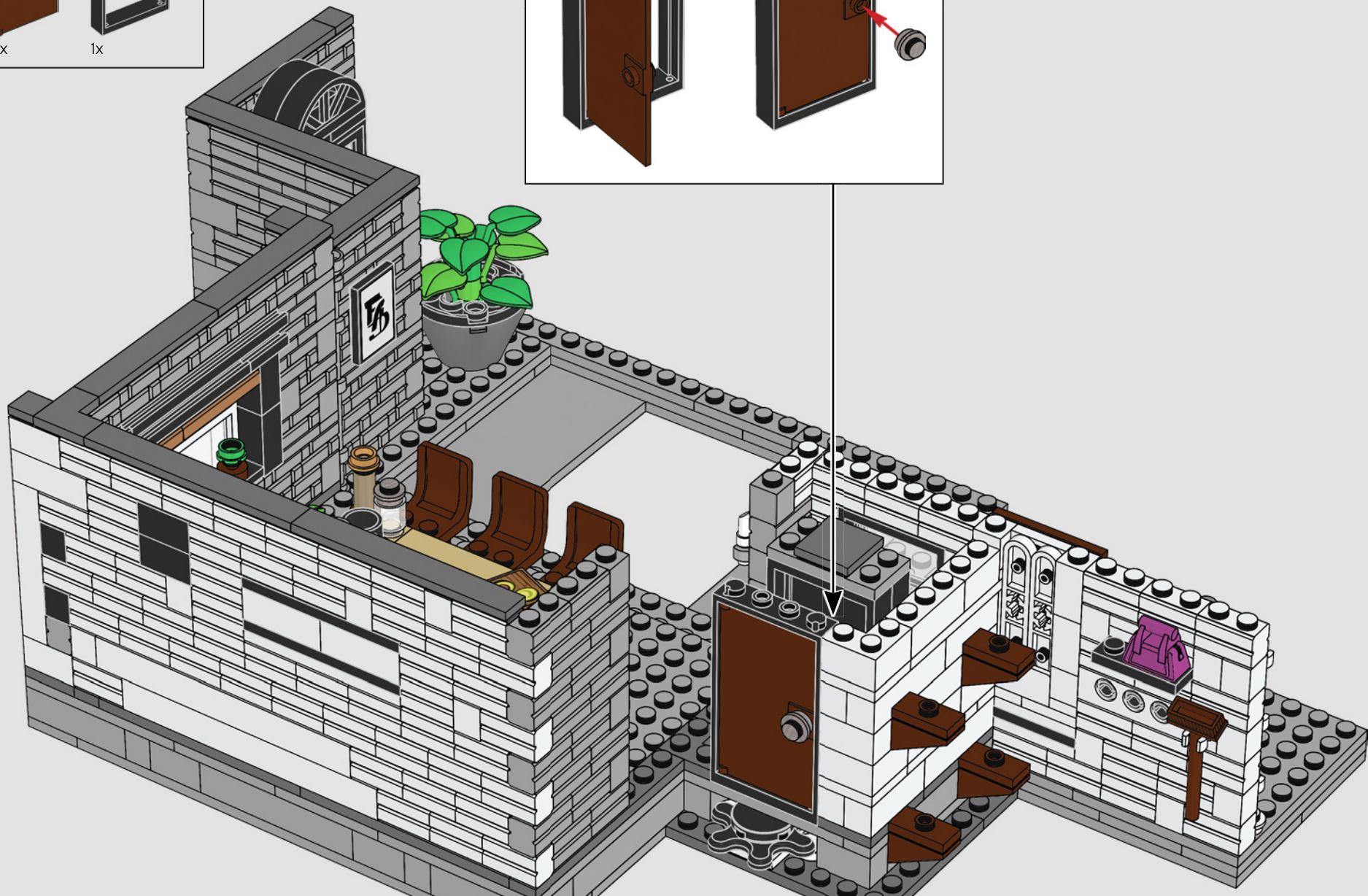
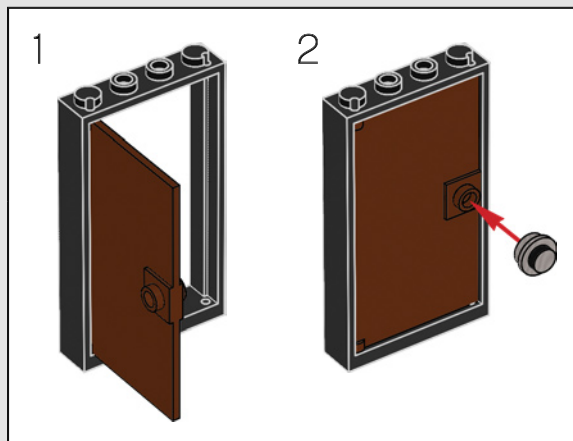

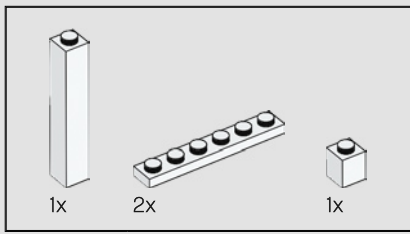

122

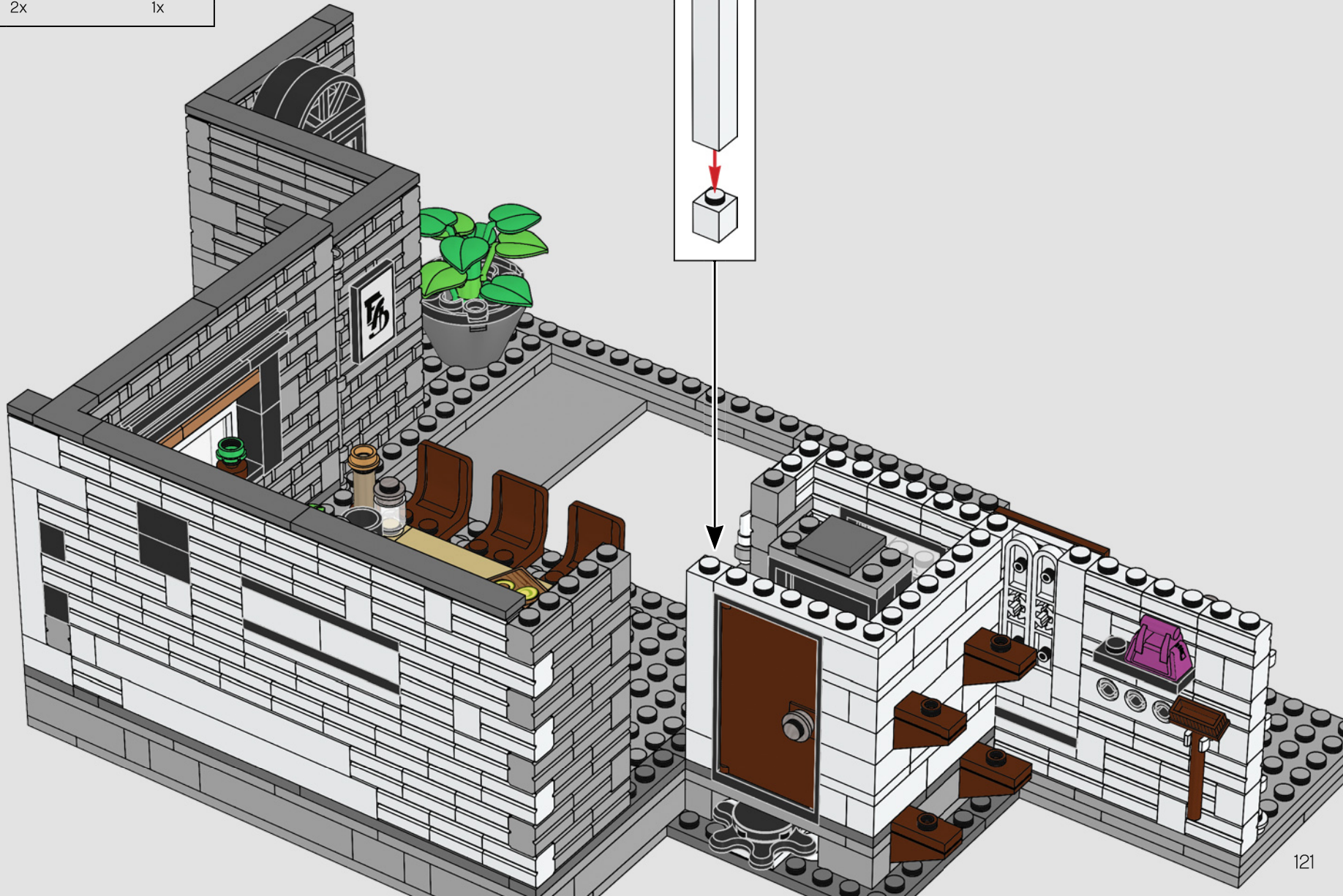

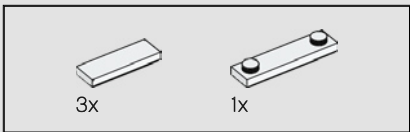

123



Tan France

"Adoro far parte dei Fab 5 e, tramite Queer Eye, riesco a evidenziare la bellezza della diversità nella nostra comunità. Questa era la mia principale speranza quando ho fatto l'audizione per lo spettacolo, e quindi sono molto grato di trovarmi in questa posizione".

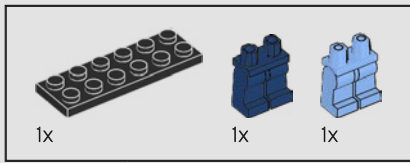

124

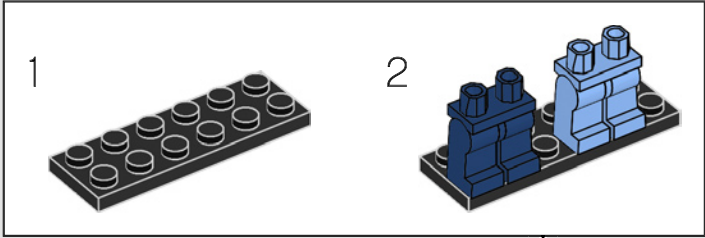
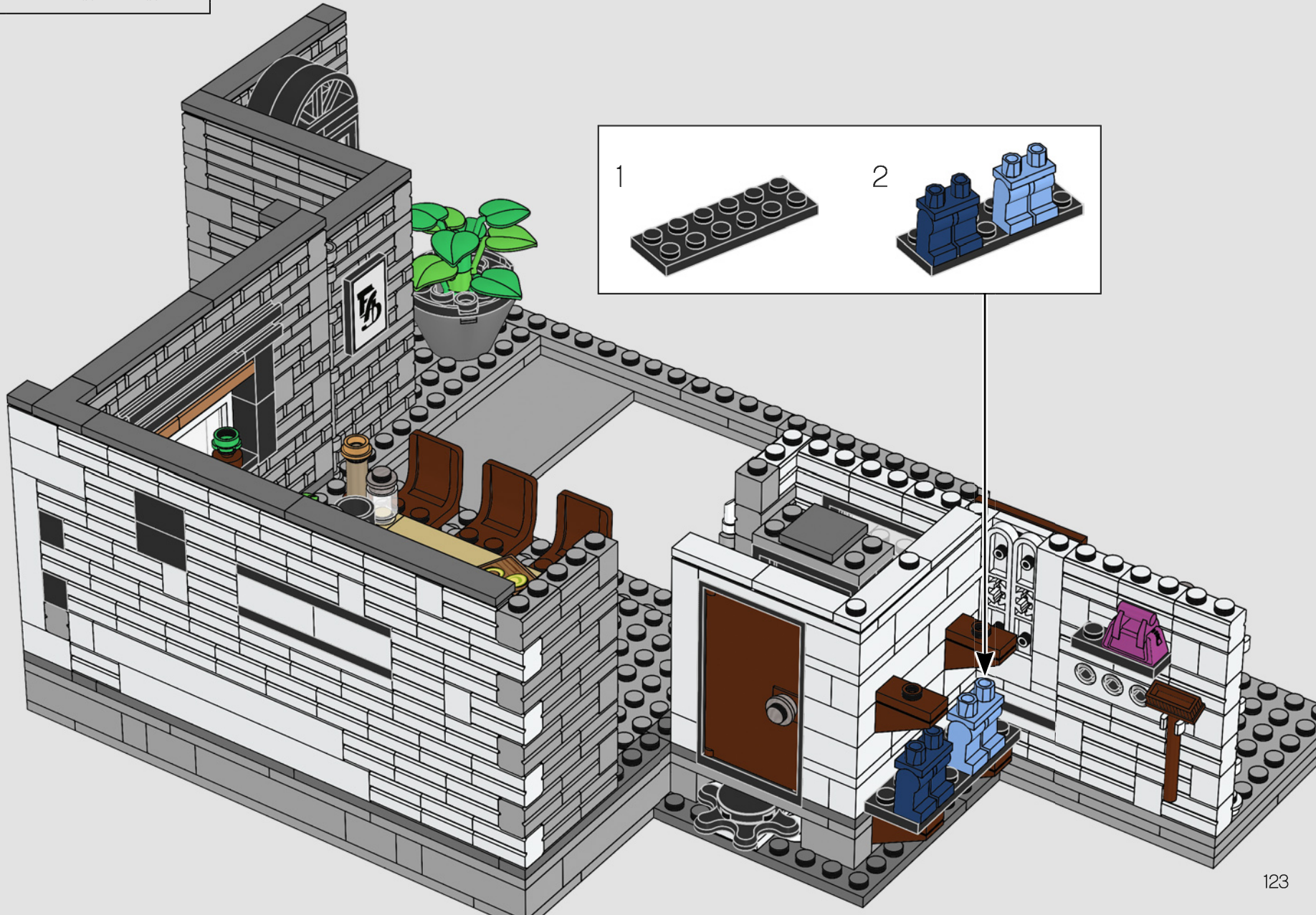

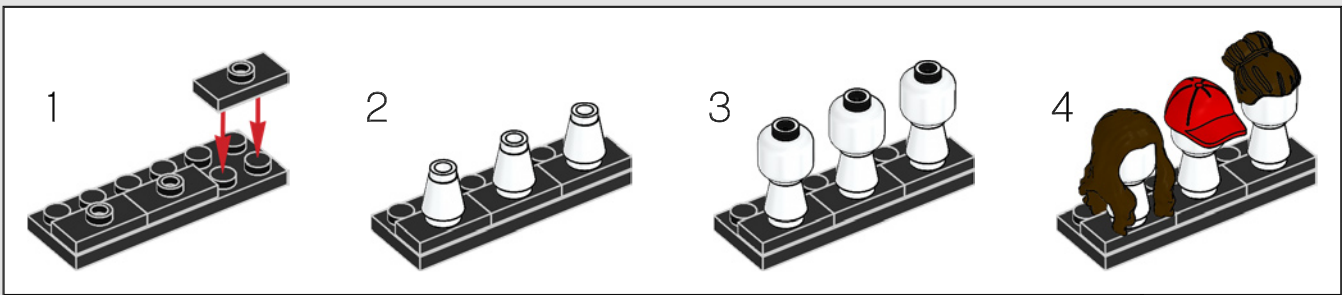
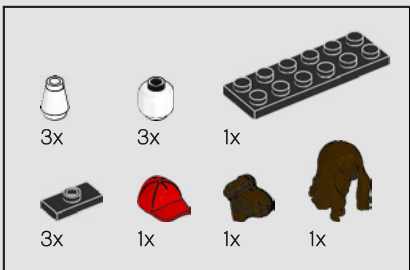

125



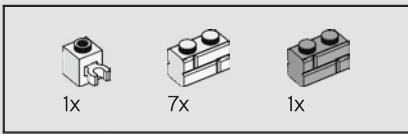

126



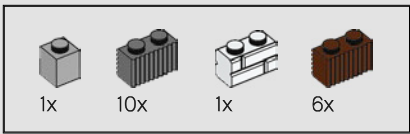

127

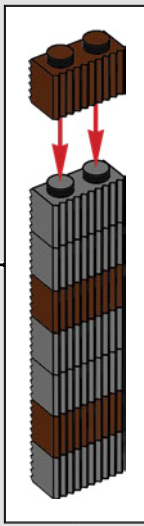
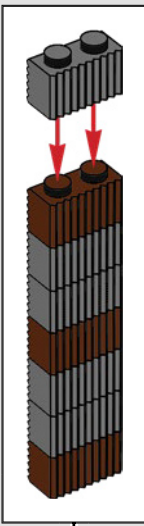

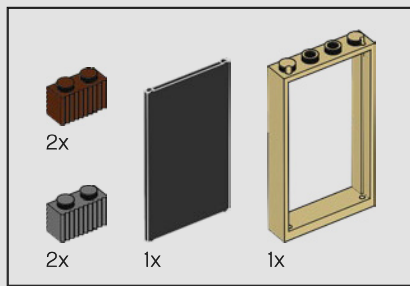

128

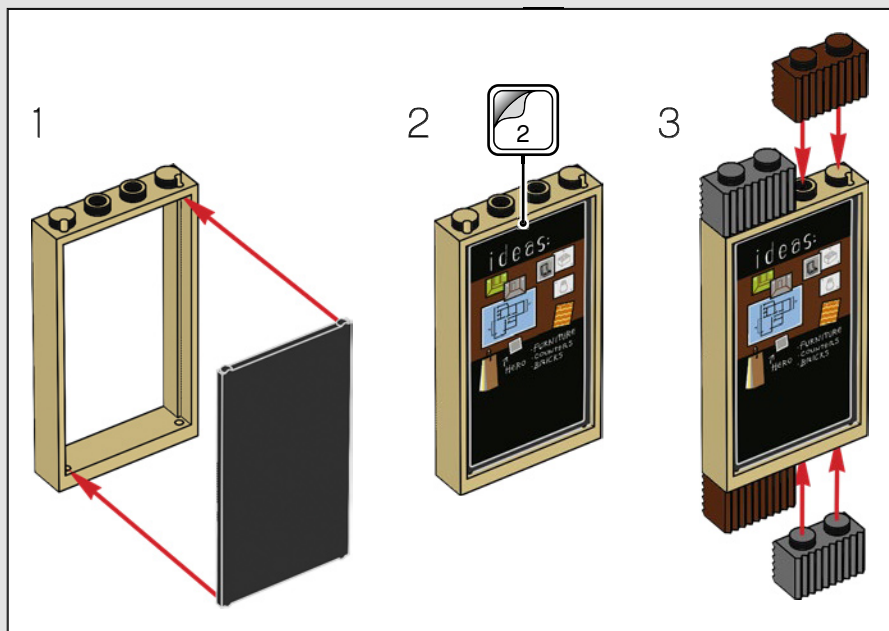

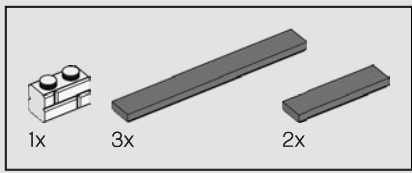

129

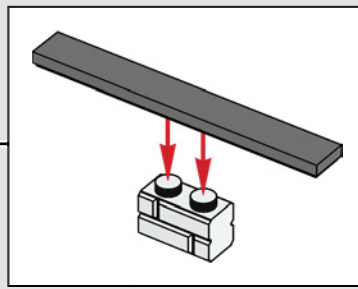

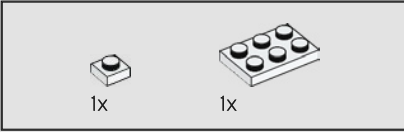
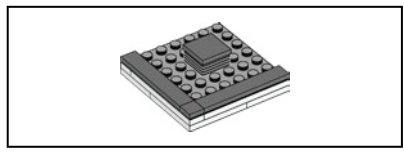

130

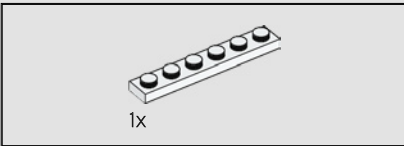
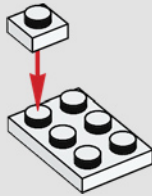

131

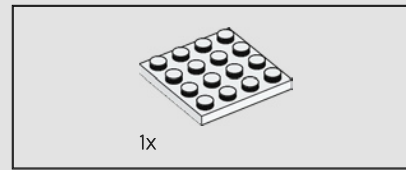
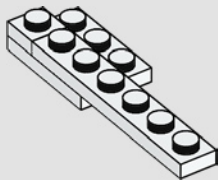

132

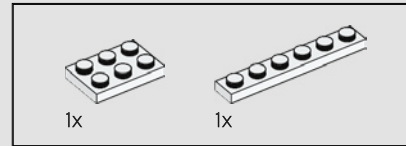
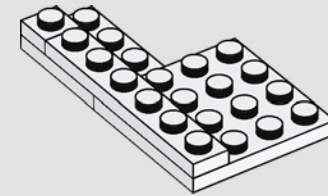

133

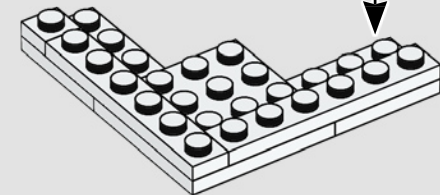
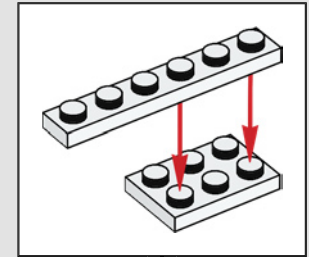

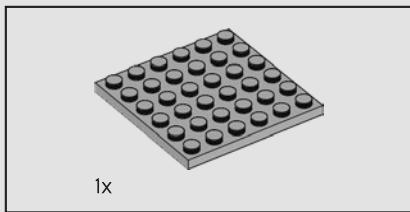

134

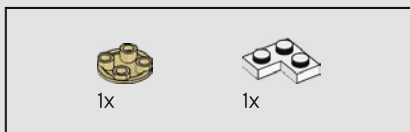
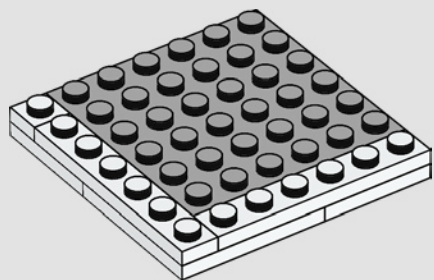

135

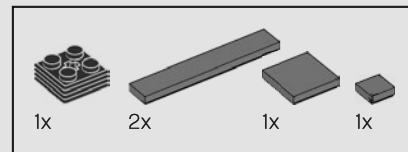
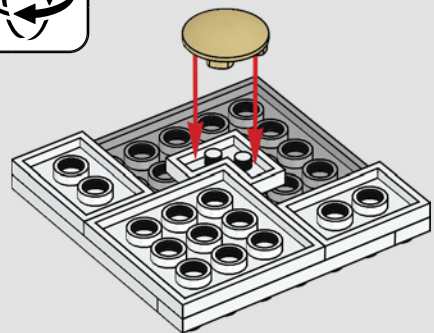

136

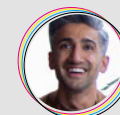
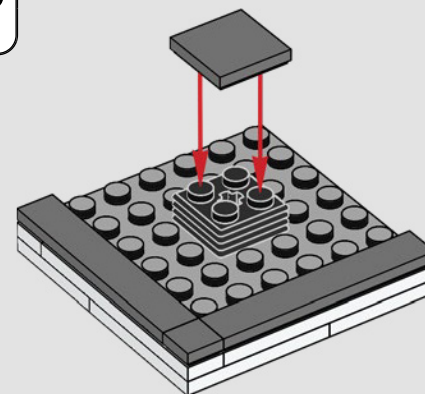

Tan France

"Quella camera di trasformazione è geniale! La ruoti e 'Ta-daaa!' ecco che avviene la grande rivelazione!"

137



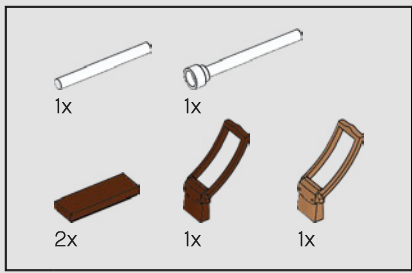

138



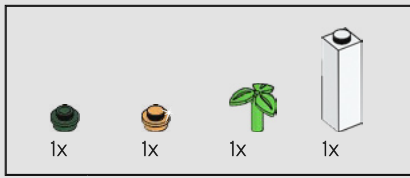

139

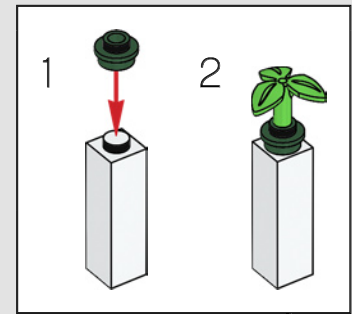

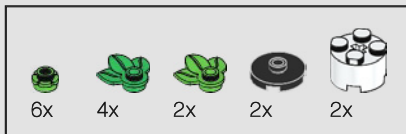

140

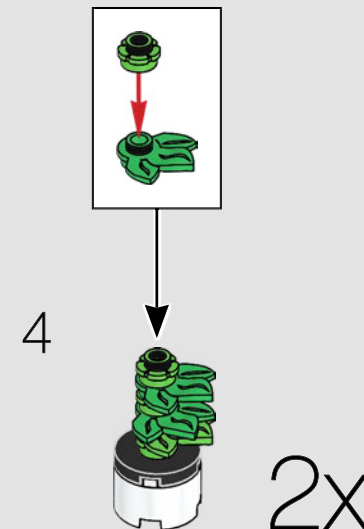
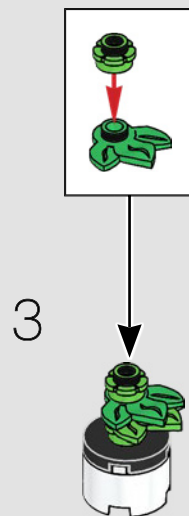
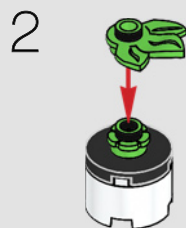
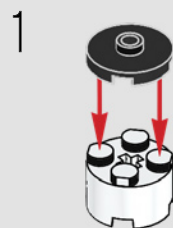

Karamo Brown

"Da adulto, qualsiasi processo creativo può aiutarti a concentrarti e portarti fuori dal tuo spazio mentale. Costruire con i mattoncini LEGO® è un modo perfetto per rilassarsi ed eliminare lo stress, facendoti sentire anche che hai davvero realizzato qualcosa con i modelli che crei. Quindi, proprio come il nostro show, le costruzioni LEGO possono aiutare a cementare le vite delle persone. Questa è la partnership perfetta".





Bobby Berk

"Sono così contento del set. Penso che siamo davvero riusciti a catturare l'essenza di ogni aspetto del nostro loft originale!"





FEEDBACK AND WIN



FEEDBACK AND WIN

Your feedback will help shape the future development of this product series.

Please visit:

FEEDBACK UND GEWINNEN

Dein Feedback trägt zur Weiterentwicklung dieser Produktreihe bei.

Geh auf:

COMMENTEZ ET GAGNEZ

Vos commentaires nous aideront à concevoir les futurs produits de cette gamme.

Rendez-vous sur :

COMENTA Y GANA

Tu opinión nos ayudará a dar forma al desarrollo de esta serie de productos en el futuro.

Visita:

反馈有奖

您的反馈将有助于我们在今后改进本系列产品。

请访问：

[LEGO.com/productfeedback](https://www.lego.com/productfeedback)

By completing, you will automatically enter a drawing to win a LEGO® set.

Terms & Conditions apply.

Durch Ausfüllen nimmst du automatisch an der Verlosung eines LEGO® Preises teil.

Es gelten die Teilnahmebedingungen.

En envoyant vos commentaires, vous serez automatiquement inscrit(e) à un tirage au sort qui vous permettra de remporter un prix LEGO®.

Offre soumise à conditions.

Al contestar, participarás automáticamente en el sorteo y podrás ganar un set LEGO®.

Sujeto a Términos y Condiciones.

完成我们的反馈调查，即可自动进入抽奖环节，赢取乐高®套装。

适用《条款和条件》。

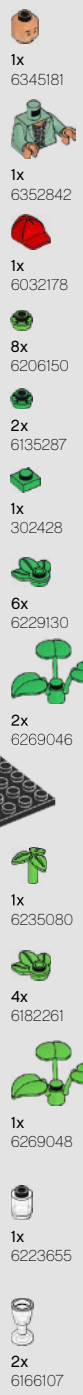

- 1x 6345181
- 1x 6352842
- 1x 6032178
- 8x 6206150
- 2x 6135287
- 1x 302428
- 6x 6229130
- 2x 6269046
- 1x 6235080
- 4x 6182261
- 1x 6269048
- 1x 6223655
- 2x 6166107



Customer Service
Kundenservice
Service Consommateurs
Servicio Al Consumidor
LEGO.com/service or dial



: 00800 5346 5555
 : 1-800-422-5346



LEGO and the LEGO logo are trademarks of the LEGO Group. ©2021 The LEGO Group.

©2021, Scout Productions, Inc. and the Queer Eye logo are trademarks or registered trademarks of Scout Productions, in the United States of America and elsewhere. All rights reserved.