



# STYLE TALKS CLASS

"Aunque no estés  
preparado para vivir a  
todo volumen, súbelo  
hasta la mitad y  
avanza poco a poco".

— Bobby Berk

## QUEER EYE

MÁS QUE UN CAMBIO DE LOOK

Mientras que muchos *reality shows* se dedican a sacar a relucir los defectos de la gente, *Queer Eye* gira en torno a su resurgimiento. Los Fab Five utilizan sus propias experiencias personales —tanto positivas como negativas— para causar un impacto constructivo y duradero en todas las personas, o héroes, como el equipo prefiere llamarlas, que encuentran en su camino.

Visita a las minifiguras de los Fab Five en la versión LEGO® de su *loft* original de Atlanta. Todos están aquí: el diseñador de moda Tan France, el experto en cultura Karamo Brown, el especialista en gastronomía Antoni Porowski, el diseñador de interiores Bobby Berk y el consultor de estética Jonathan Van Ness. ¡Necesitan tu ayuda para llevar a cabo su última transformación! Esperamos que disfrutes tu estancia...



HOLLYWOOD



"Como estilista, mi objetivo es ayudar a la gente a ser la mejor versión de sí mismos".

— Tan France



## TAN FRANCE

MODA



Nacido en Doncaster (Yorkshire del Sur) y de padres pakistaníes, Tan France comenzó a trabajar en los EE. UU. en 2008 y hoy vive en Salt Lake City (Utah). Como diseñador y experto en moda, Tan ayuda a las personas a recuperar la confianza en sí mismas al hacerlas sentirse bien con lo que visten. ¡Casi siempre, sus mágicos cambios de imagen acaban con su característico *tuck* francés!



*"La comida puede ofrecerte un momento de puro placer emocional en un mundo, por lo general, complicado".*

— Antoni Porowski

# ANTONI POROWSKI

GASTRONOMÍA

Hijo de inmigrantes polacos, Antoni creció en Montreal (Canadá) y habla polaco, inglés y francés. Después de mudarse a los EE. UU., estudió psicología y teatro, aunque finalmente dedicó su talento a la cocina. Antes de formar parte de los Fab Five y animar a la gente a iniciarse en el mundo de la cocina, trabajó para Ted Allen, el experto gastronómico que aparecía en el programa *Queer Eye* original, emitido a principios de la década de 2000.



# KARAMO BROWN

CULTURA

Karamo Brown es el *life coach* y terapeuta del grupo. Ayuda a los héroes del programa a comprenderse bien a sí mismos y los anima a superar las adversidades que cambiaron sus vidas. Nacido en Houston (Texas) y de ascendencia jamaicana y cubana, Karamo vive ahora en Los Ángeles con sus dos hijos y es un promotor activo de la comunidad LGTB negra.



*"La vida no es algo que te suceda. La vida es algo que te responde".*

- Karamo Brown





*"Cuando eres feliz en casa, esa alegría salpica a todas las demás áreas de tu vida".*

— Bobby Berk



## **BOBBY BERK**

DISEÑO

Bobby creció en un pequeño pueblo de Misuri. En 2003 se mudó a Nueva York con solo 100 dólares en el bolsillo. Se abrió camino hasta convertirse en el director creativo de una empresa de muebles para el hogar antes de lanzar su propia tienda en línea. En el programa de Netflix *Queer Eye*, Bobby renueva los espacios en los que viven los héroes para ayudarlos a transformar sus vidas.

"El modo en que cuidas de ti es el modo en que te ve el mundo".

— Jonathan Van Ness



# JONATHAN VAN NESS

GROOMING

En su papel como entusiasta animador de los Fab Five, Jonathan empuja a los héroes del programa a encontrar tiempo para sí mismos a través de sus propios momentos de estética y cuidado personal. Cuando no está arreglándole el peinado a los protagonistas de *Queer Eye*, Jonathan es el efusivo presentador de una serie de reconocidos pódcast y un gran fan de la gimnasia y el patinaje artístico; ¡incluso se rumorea que el propio Jonathan ya domina tanto el *toe loop* como el salto Axel en el hielo!







Bruley era el adorable *bulldog* francés de las temporadas 3 y 4. Nos dejó en 2019, y ahora vivirá para siempre en formato LEGO®.



## TODOS LOS INVITADOS SON HÉROES

Cada uno de los héroes de *Queer Eye* tiene una historia especial que contar. Algunos han vivido la traumática experiencia de perder a un ser querido, han superado una patología grave o han padecido el rechazo de su familia. Otros se han entregado tanto a los demás y a sus comunidades que han tenido poco tiempo para cuidar de sí mismos. Todos ellos son héroes para los Fab Five y, por eso, merecen una transformación que haga sus vidas más sencillas, saludables y felices.



## EL INVITADO DE ESTA SEMANA

¡Un set LEGO® *Queer Eye* no podría estar completo sin que alguien pasara por una mágica transformación! Te presentamos a Kathi Dooley, una maestra entregada a su profesión cuya comprensión y amabilidad

resultaron fundamentales para Jonathan durante los primeros años de su vida. Es hora de que Jonathan y sus amigos le devuelvan el favor...

Transformación LEGO de Kathi Dooley



Antes

Después



La increíble habilidad para el diseño de Bobby se hizo evidente desde muy temprana edad... ¡con un set LEGO!



# MÁS QUE UN CAMBIO DE LOOK

¡UNA VERDADERA COLABORACIÓN!

Este set LEGO® *Queer Eye* es el resultado de una verdadera colaboración al estilo de los Fab Five entre el equipo de diseño de LEGO y el gurú de diseño del programa, Bobby Berk. Para Bobby, el proyecto no tardó en convertirse en una pasión: "LEGO desempeñó un papel sumamente importante durante mi niñez. Conectar los pequeños ladrillos ponía a funcionar mi imaginación y creatividad como ninguna otra cosa". Desde la perspectiva de Matthew Ashton, vicepresidente de Diseño en LEGO, esta colaboración fue una alianza perfecta: "Compartimos muchísimos valores, como la amabilidad, el aprendizaje, la creatividad y la diversión. Mientras que los Fab Five se dedican a rehacer las vidas de las personas, nuestra misión es inspirar a niños y adultos a ser creativos y participar en rehacer un mundo más positivo".

La primera tarea consistió en decidir exactamente qué representar en el set. El equipo consensuó rápidamente que se crearía un modelo del escenario original del *loft* de la primera temporada, y juntos definieron el plano y la distribución de las habitaciones. Para Matthew, capturar tantos detalles como fuera posible era fundamental: "Queríamos replicar los muebles e incluir detalles emblemáticos como el letrero con la leyenda 'STYLE, TASTE, CLASS'. También queríamos incluir un área distinta para cada uno de los chicos y representar las inigualables habilidades y aportaciones al equipo de cada uno de ellos".

*"¡Colaborar con el equipo de LEGO fue un sueño hecho realidad en todos los aspectos! Lo que sería el sueño de cualquier niño es ahora mi realidad".*

— Bobby Berk



Bobby y Matthew en las etapas iniciales del proceso de diseño.



# CONECTAR TODAS LAS PIEZAS

Al igual que para los Fab Five, el trabajo en equipo es un ingrediente esencial para el desarrollo de un set LEGO® que se vuelva inolvidable. Los otros miembros del *dream team* de Matthew en LEGO fueron Diego Sancho, diseñador gráfico sénior, y Ruth Kelly, diseñadora de elementos sénior.

Diego asumió la importante tarea de capturar la esencia de los Fab Five en forma de minifiguras LEGO y de diseñar adornos y calcomanías que dieran vida al *loft*: "Tuve la oportunidad de dar mi toque personal a la decoración del *loft*, ¡y de agregar algunos increíbles huevos de Pascua para los fans! Puse la leyenda 'Yaaas Queen' en la cocina para celebrar el divertido grito de guerra de la comunidad LGBTQ+. Además, si miras de cerca las pinceladas del cuadro, ¡notarás que dice 'FAB 5'!".

Ruth se enfrentó un desafío muy diferente: "Ninguna de nuestras pelucas tenía la altura y el volumen del pelo de Tan, por lo que mi trabajo consistió en esculpir una nueva. Decidimos moldear la peluca en reluciente plástico color plata para 'elevar' el *look* de Tan".

Matthew está orgulloso de la versión final del set y de lo que significa la alianza: "Los Fab Five fueron una influencia positiva en la vida de muchísimas personas. Es importante celebrar la amabilidad, y esta colaboración representa una oportunidad perfecta para poner de manifiesto este valor".



De izquierda a derecha:  
Ruth Kelly, diseñadora sénior de Elementos  
Matthew Ashton, vicepresidente de Diseño  
Diego Sancho, diseñador gráfico sénior



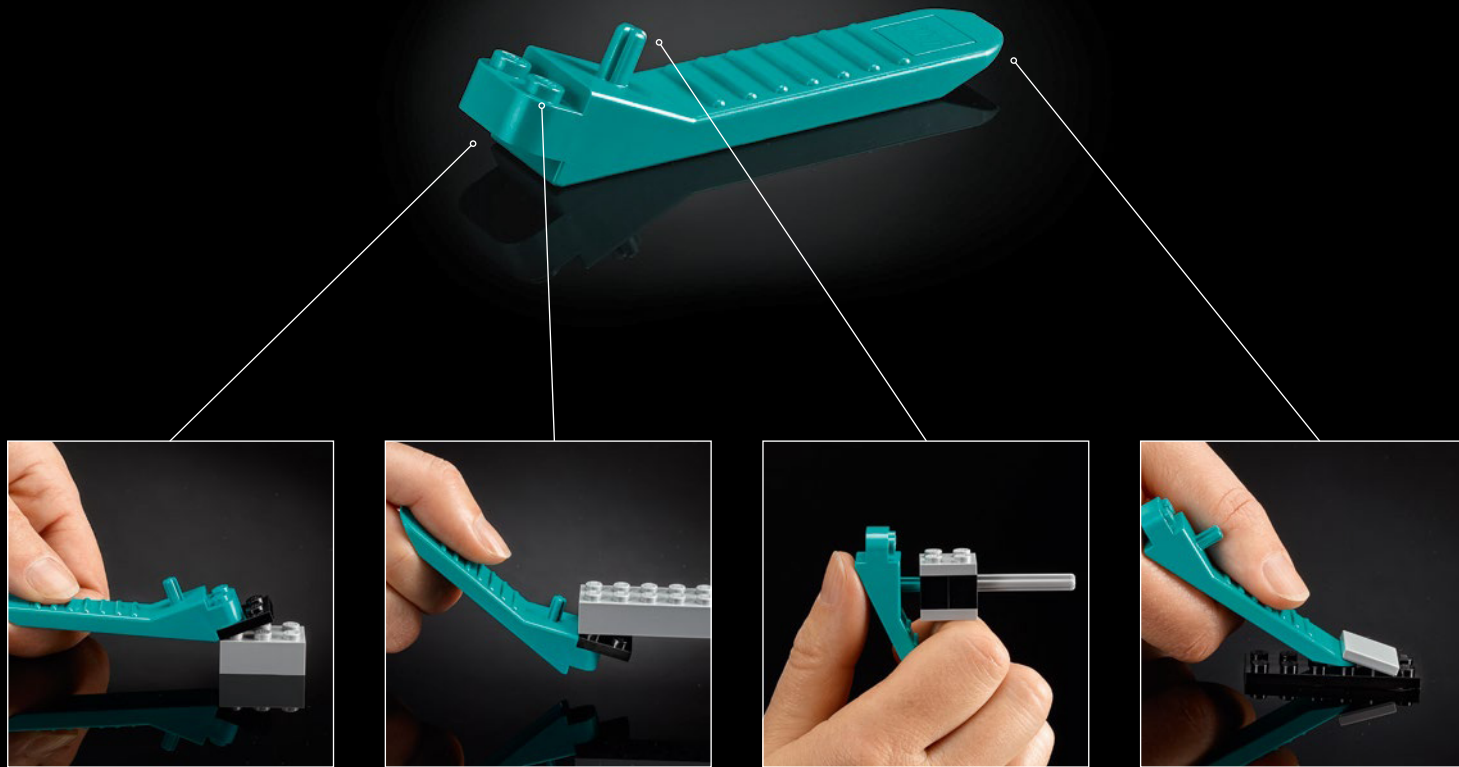

[LEGO.com/brickseparator](https://www.lego.com/brickseparator)

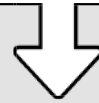
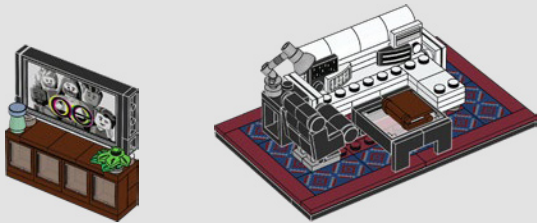
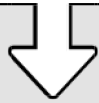

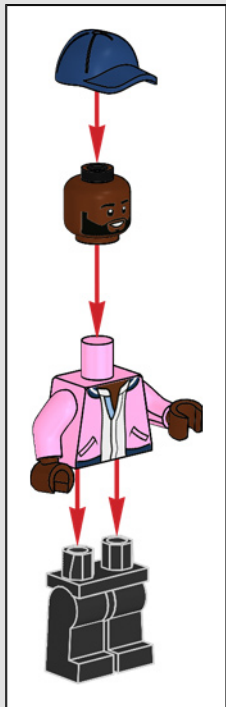
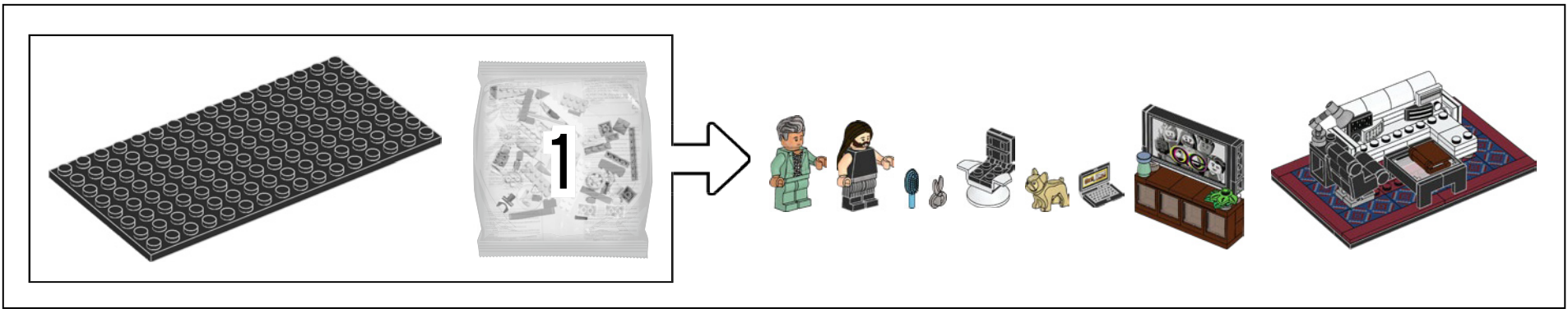

Karamo Brown

*"Me encantó ver que me reprodujeran luciendo la cazadora que me caracteriza y una gorra perfectamente a juego: ¡así queda oculto ese enorme bulto en mi cabeza! Es simplemente maravilloso".*

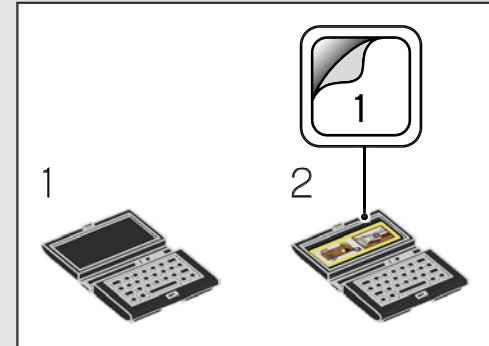



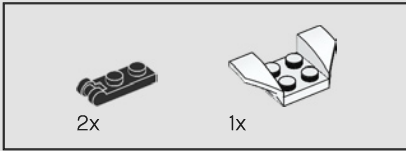
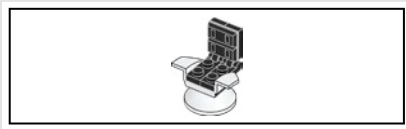

1

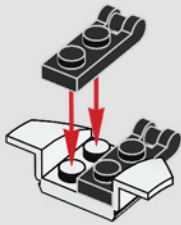

2

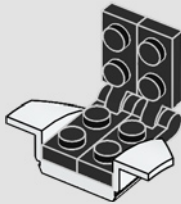

3

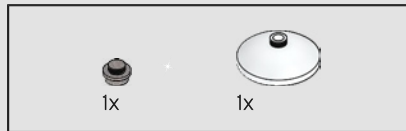
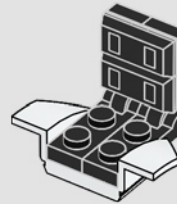

4

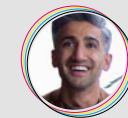
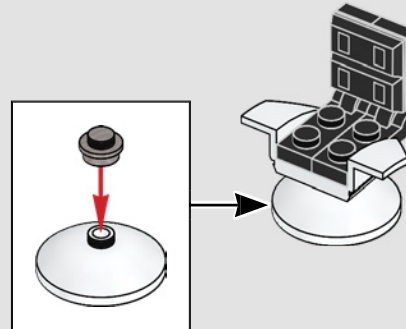

Tan France

*"¡Mira! ¡Esa peluquita LEGO® es simplemente perfecta! Y, al igual que mi pelo bajo el efecto del fijador, no se mueve ni un centímetro!"*



Jonathan Van Ness

*"¡Nuestras versiones LEGO son una monada!"*

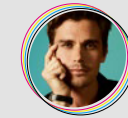

Antoni Porowski

*"Menudo detallazo que hayan incluido a Bruley. ¡Cómo echo de menos a ese adorable cachorrito!"*

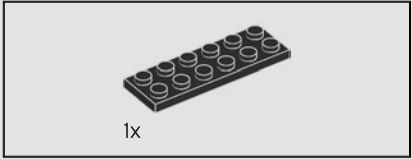
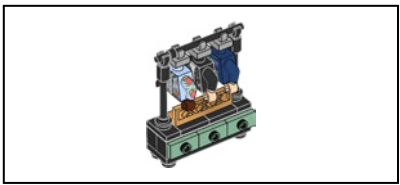

1

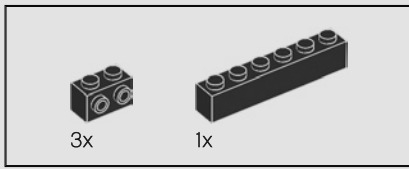
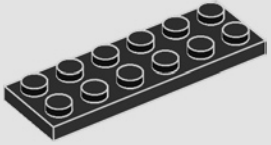

2

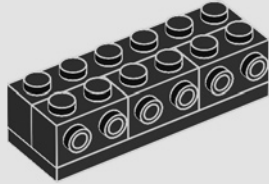

3

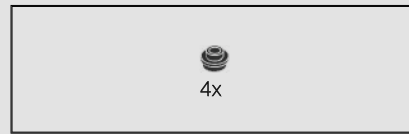
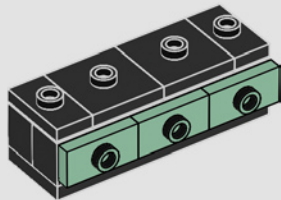

4

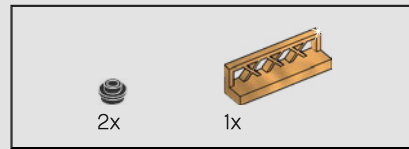
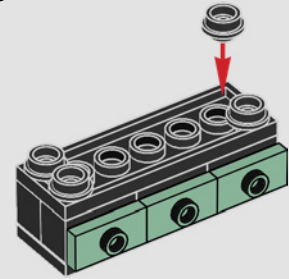
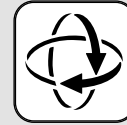

5

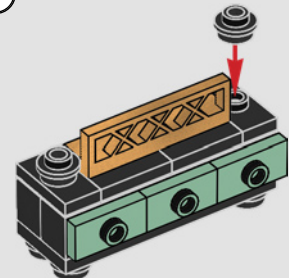
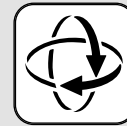



6

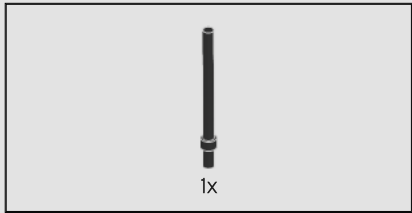
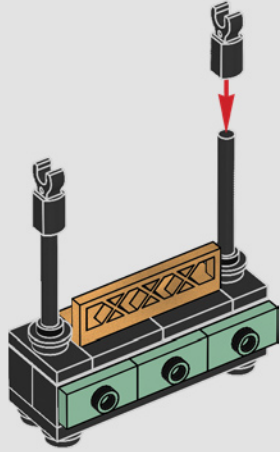

7

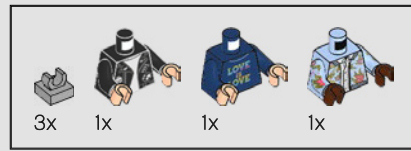
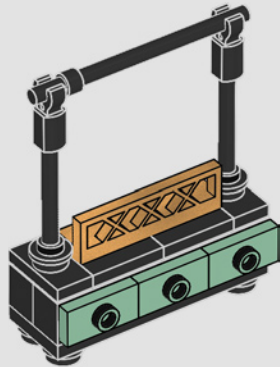

8

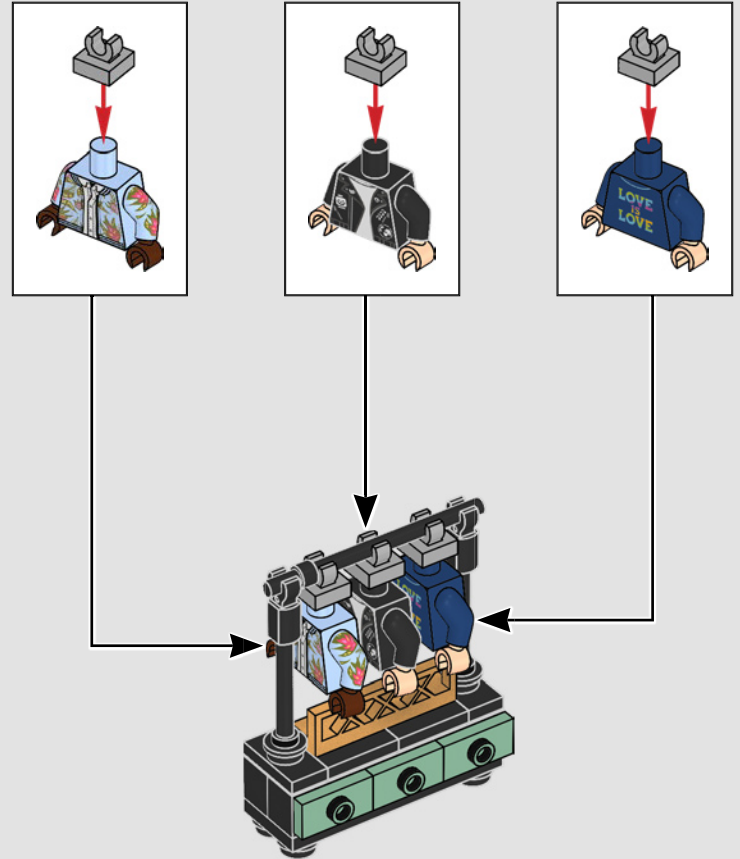

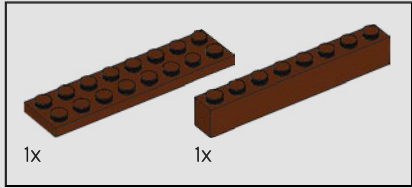

1

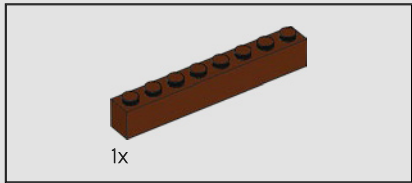
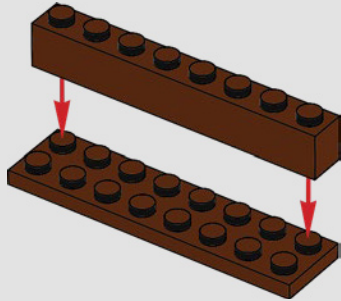

2

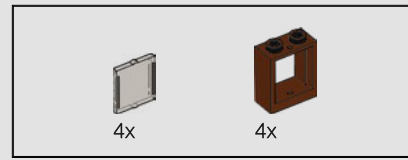
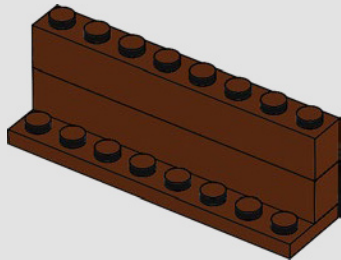

3

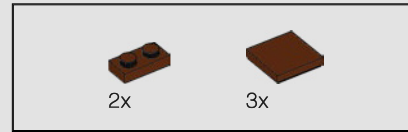
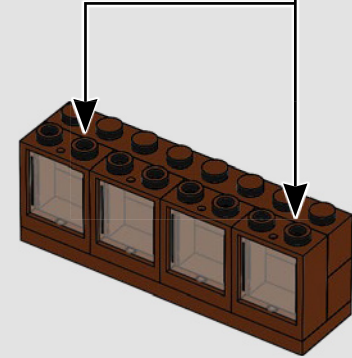
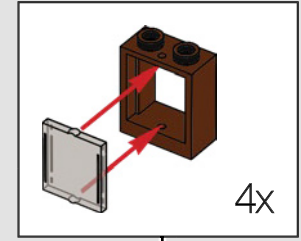

4

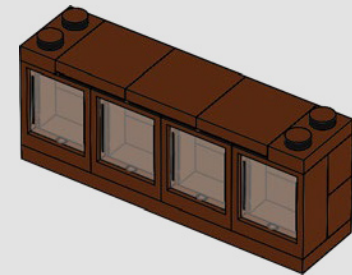



5

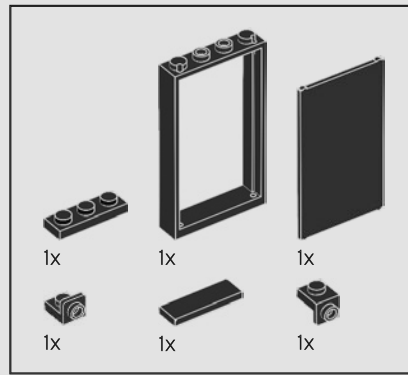
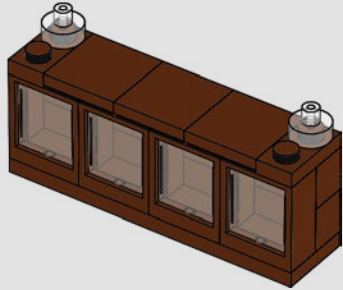

6

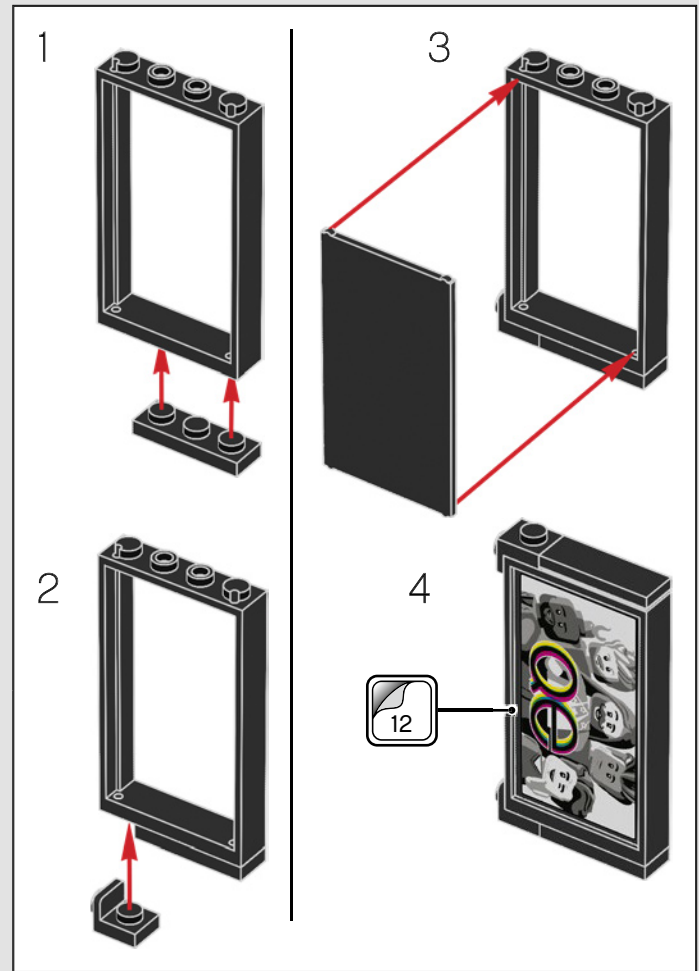
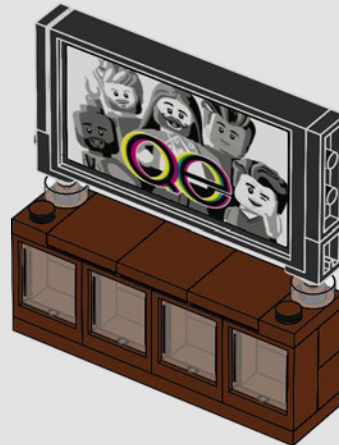



7



Jonathan Van Ness

"Es importante que la inclusión forme parte de la creatividad de las personas. Por eso, el hecho de que una empresa como LEGO muestre su respaldo por temas como la inclusión de la comunidad LGBTQ es algo necesario, y me encanta que esté sucediendo".

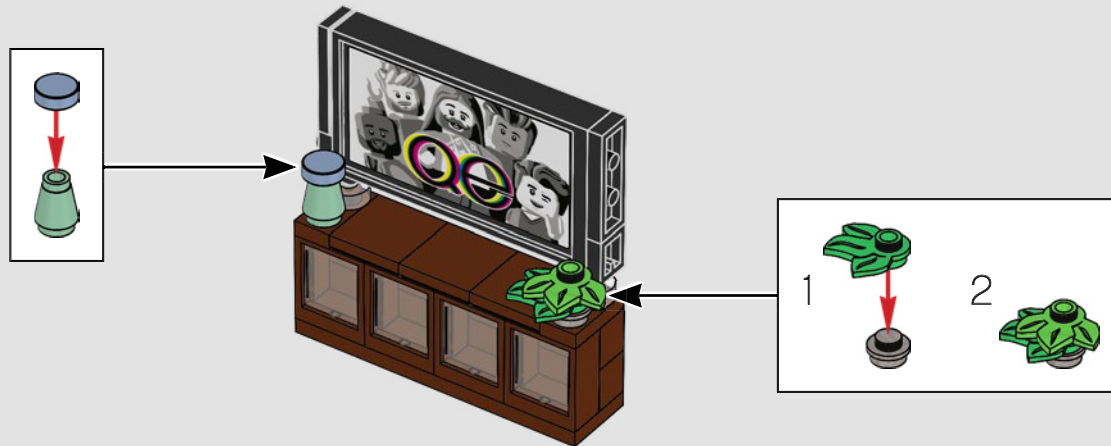

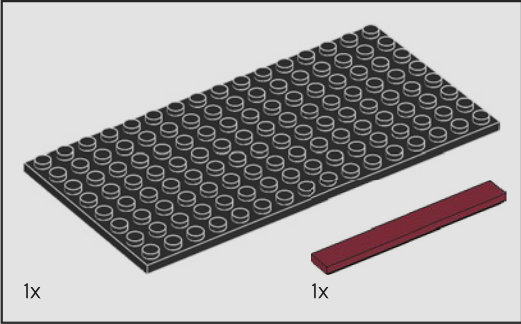
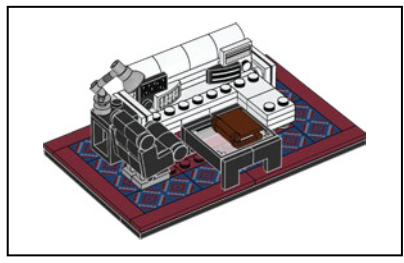

1

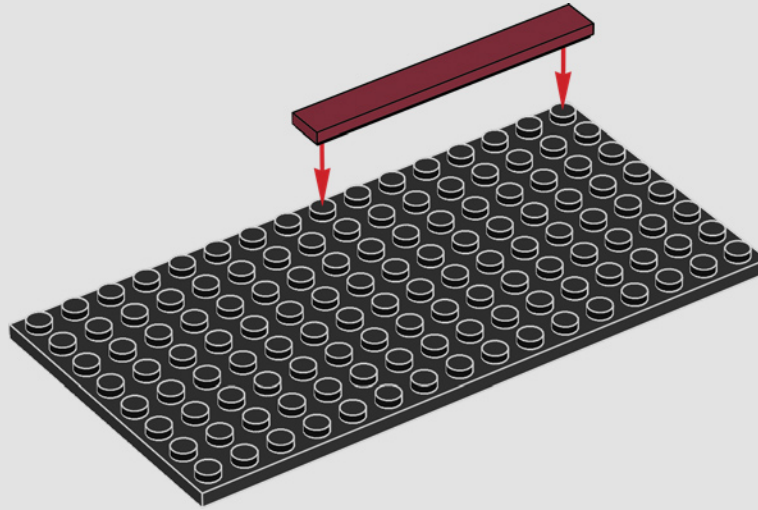

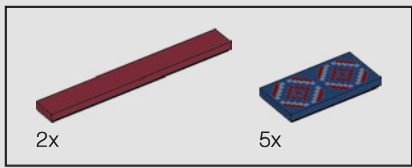

2

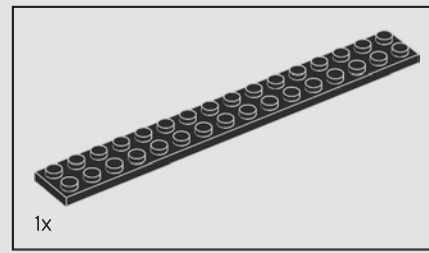
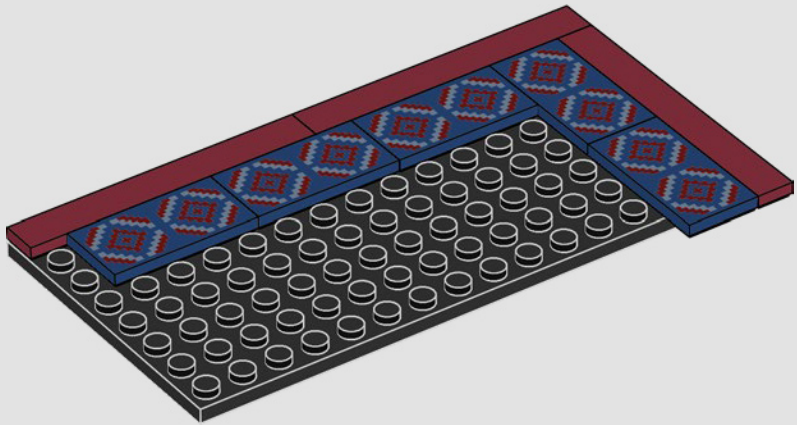

3

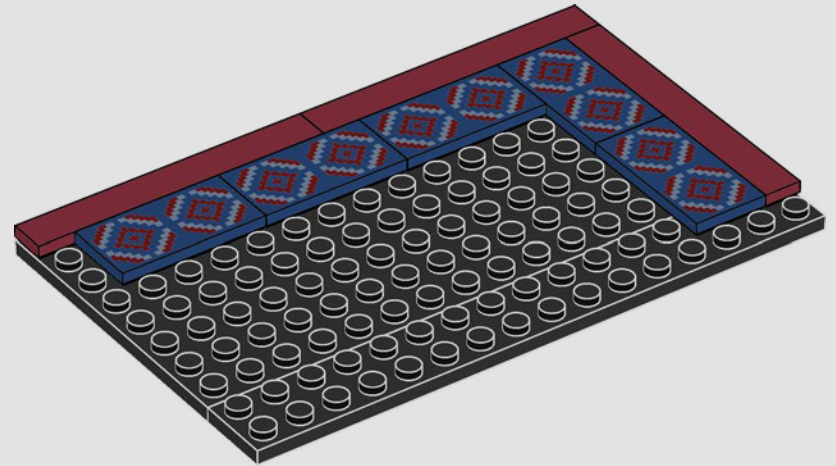



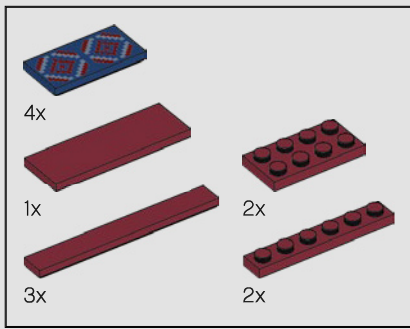

4

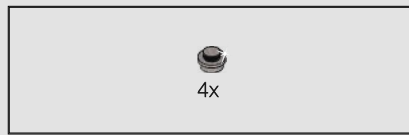
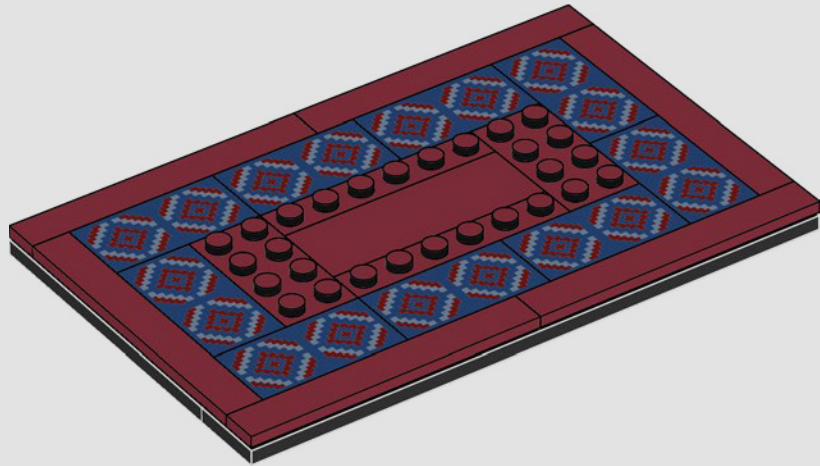

5

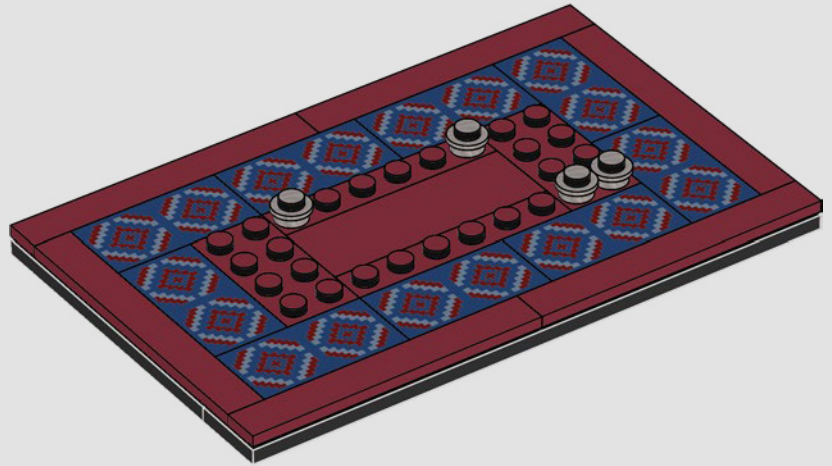

Jonathan Van Ness

*"¡Es maravilloso formar parte de la imaginación de quienes se dedican a crear un mundo mejor! Espero que esta colaboración estimule la imaginación de la gente".*

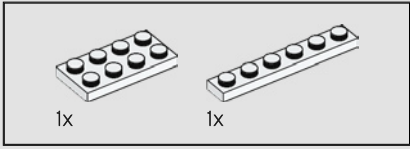
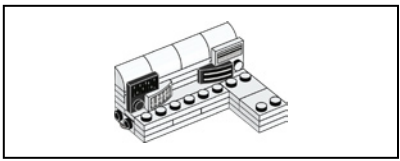

6

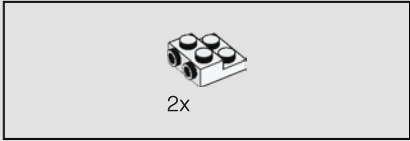
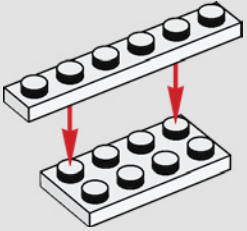

7

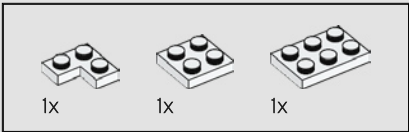
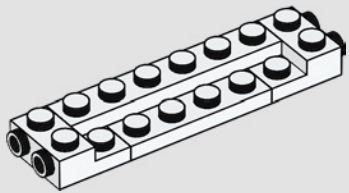

8

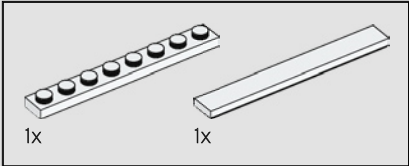
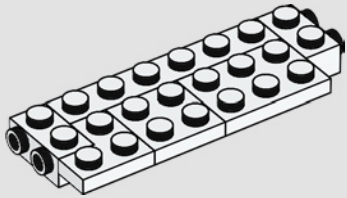

9

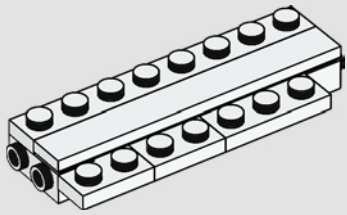

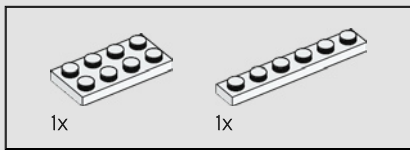

10

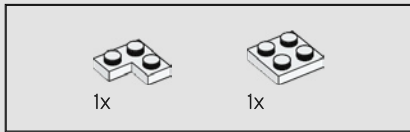
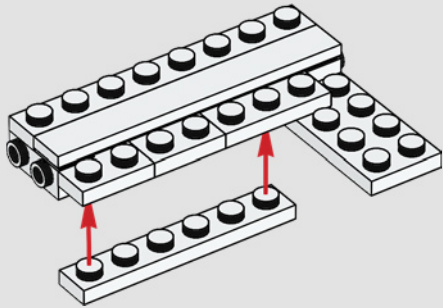

11

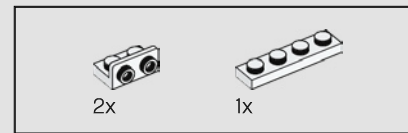
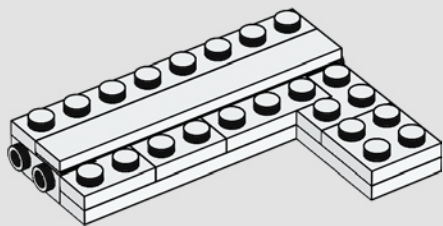

12

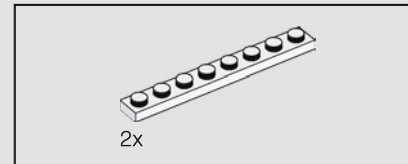
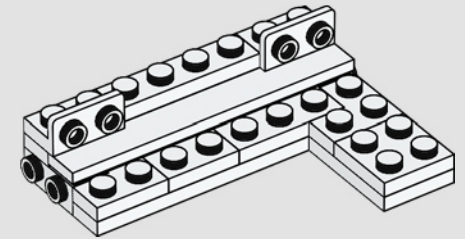

13

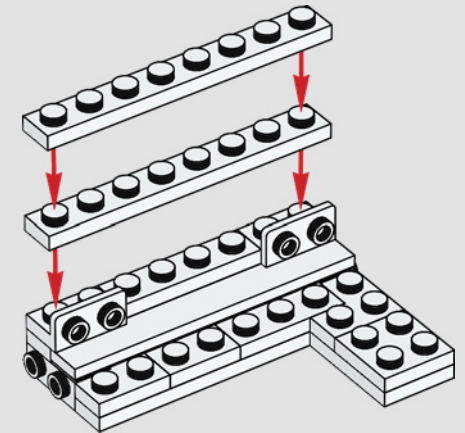

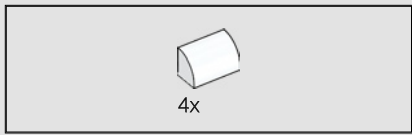

14

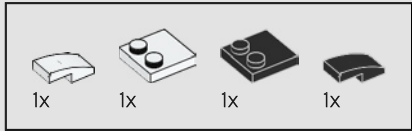
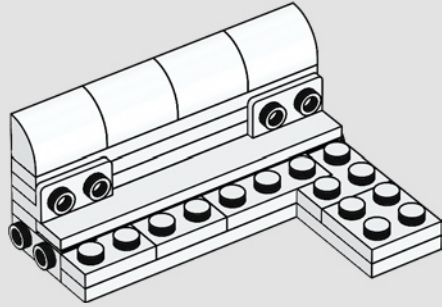

15

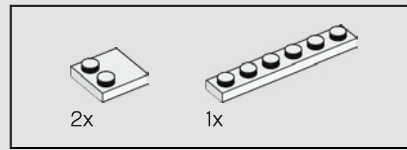
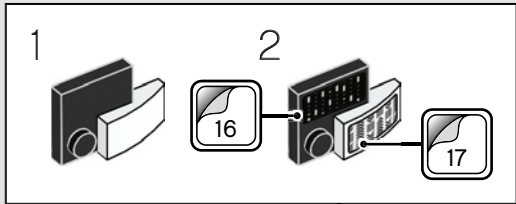
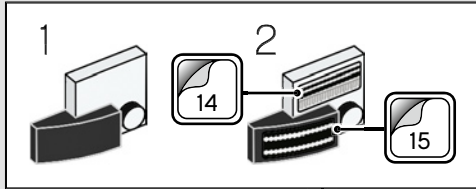

16

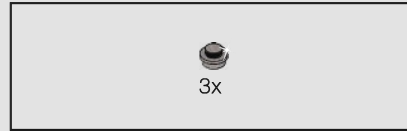
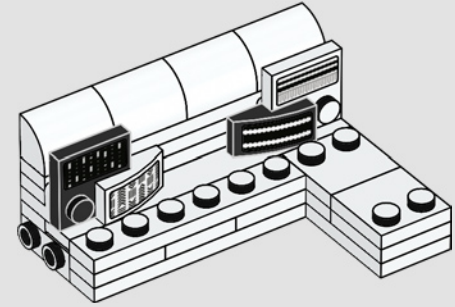

17

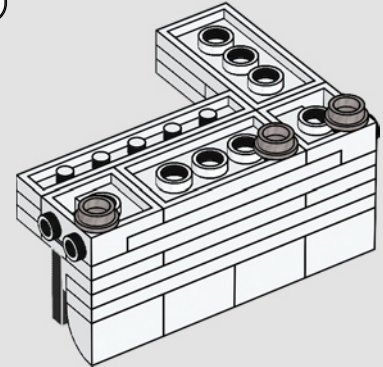
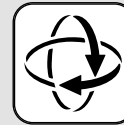

18

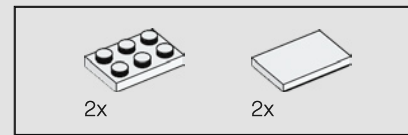
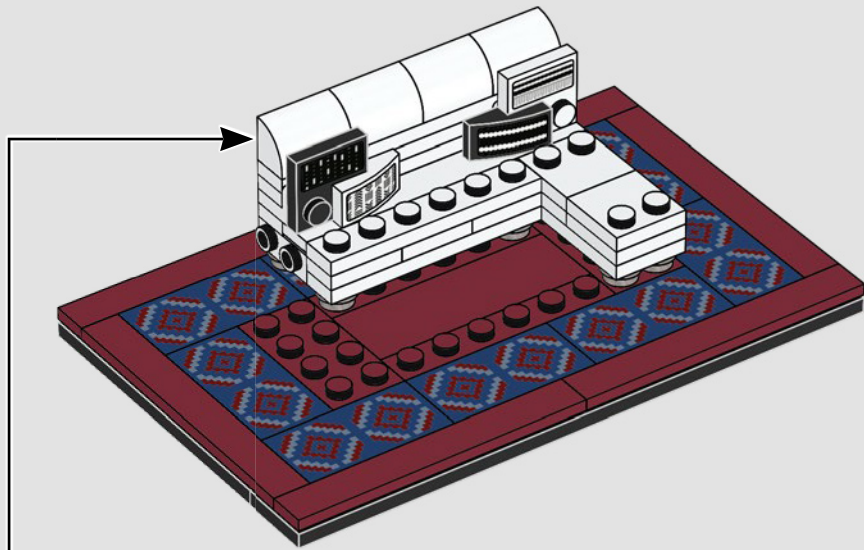

19

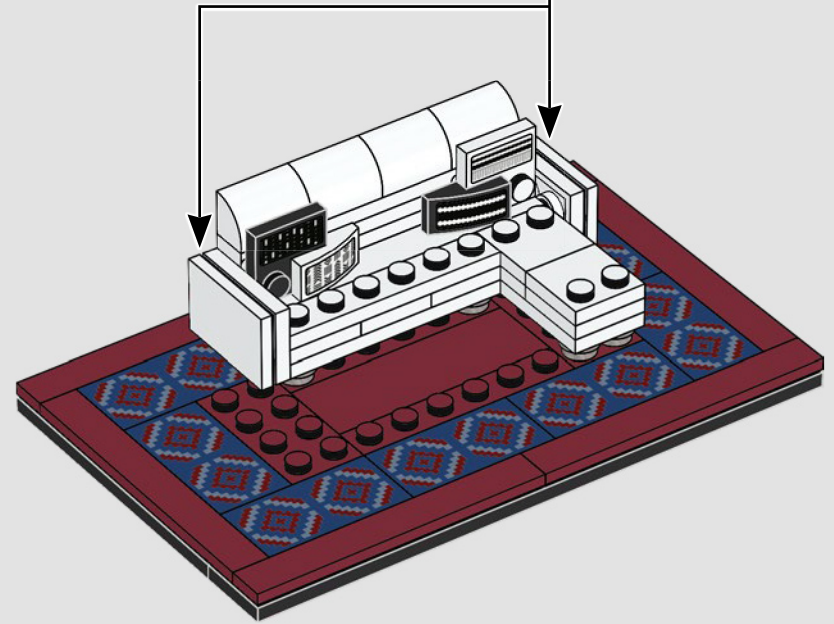
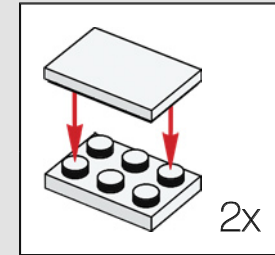

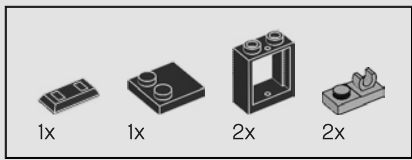

20

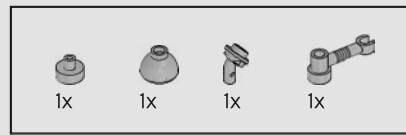
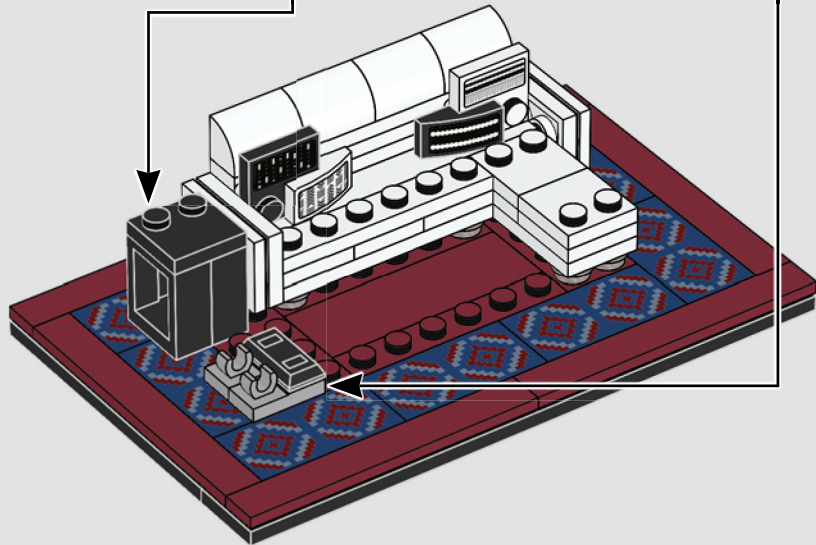
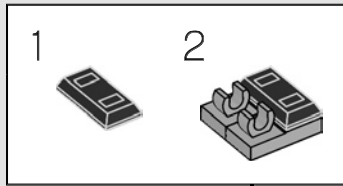
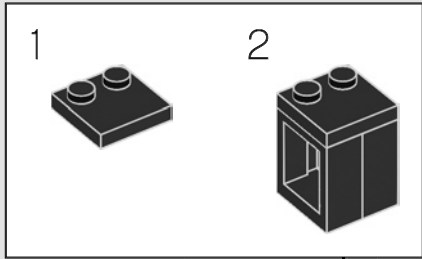

21

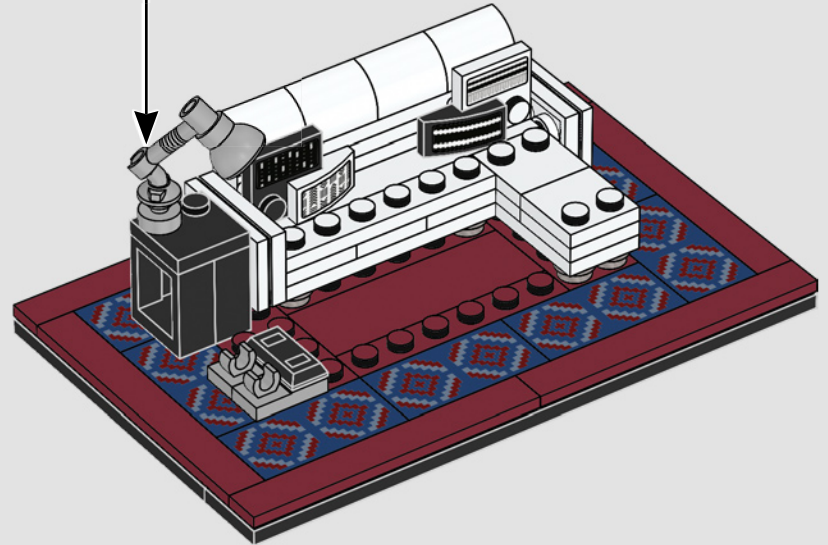
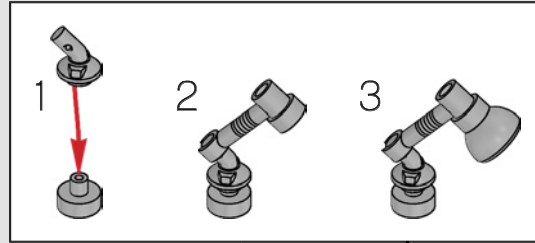

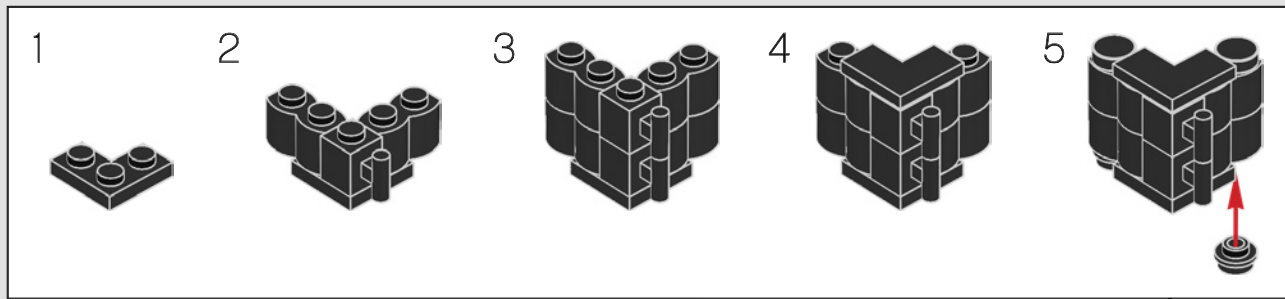
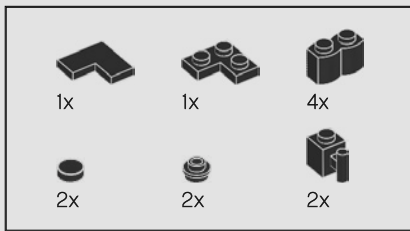

22

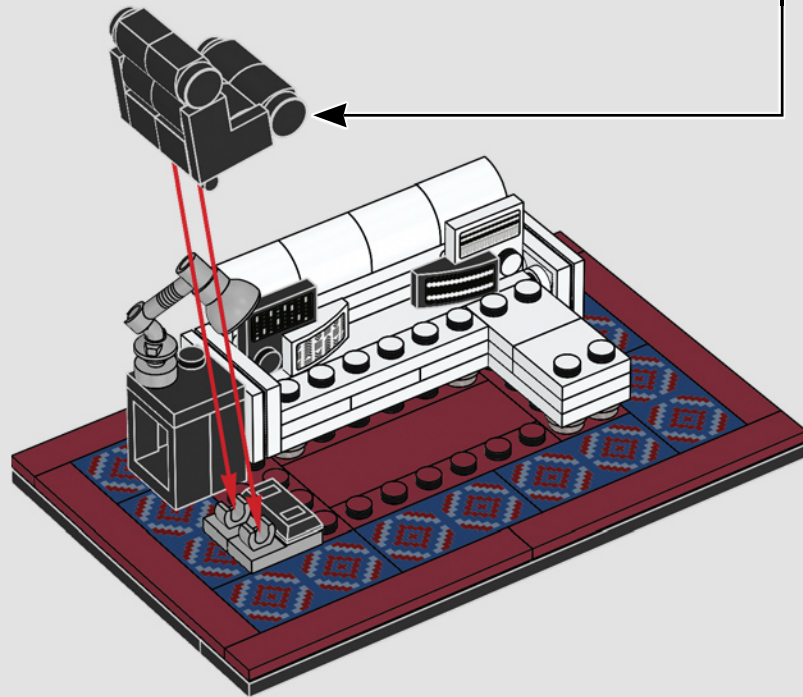

Tan France

*"Me encanta el proceso creativo, y LEGO® es ideal para liberar tu creatividad: puedes construir cualquier cosa que quieras con el estilo personal que te hace único".*

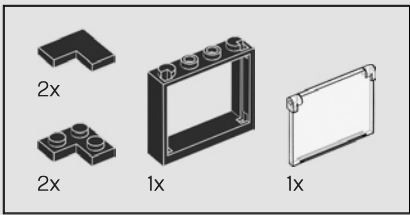

23

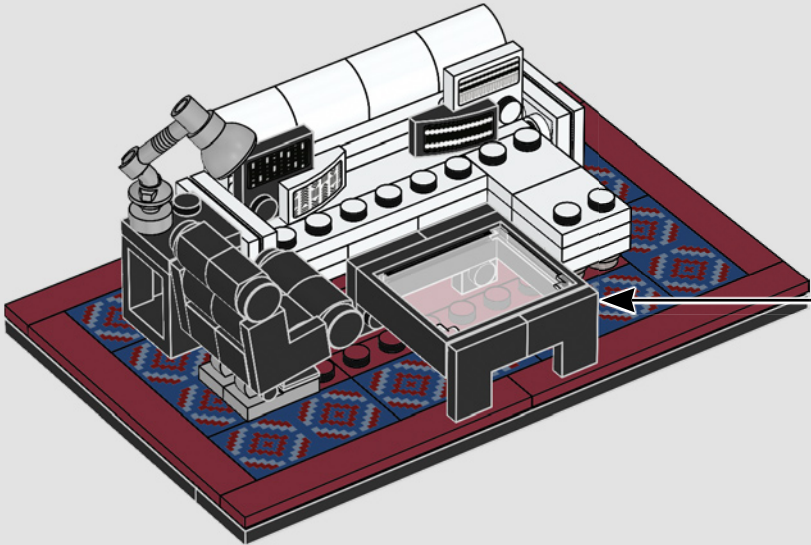
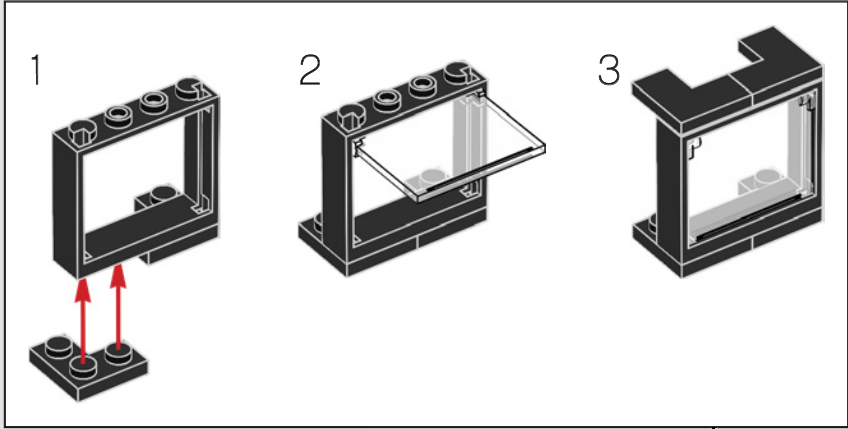



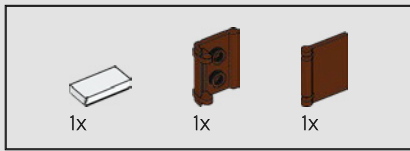

24



Karamo Brown

"Ver el set me trae muchísimos recuerdos felices. ¡Es como si me hubieran reducido a escala miniatura y pudiera vivir una vez más cada fantástica experiencia que pasé en el programa!"

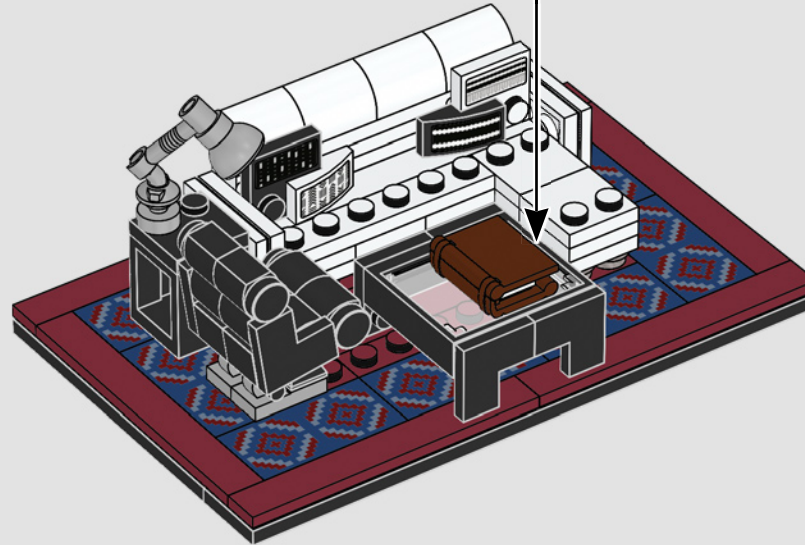
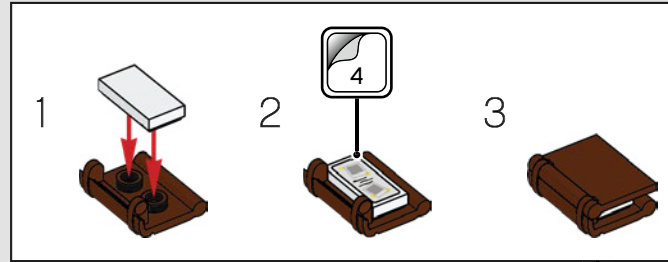

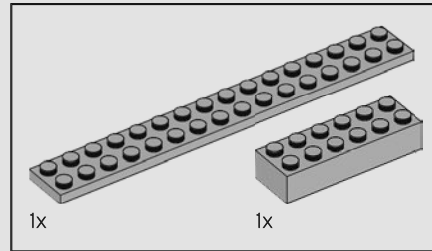
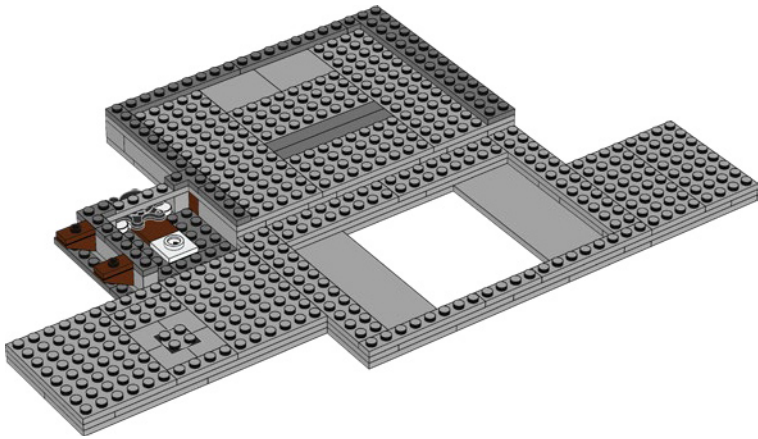
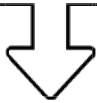

1

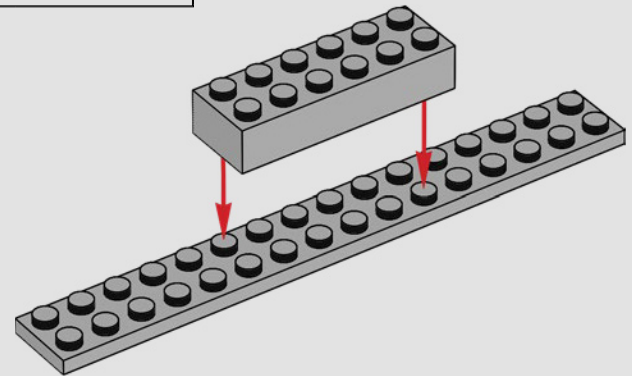

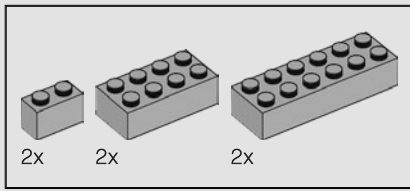

2

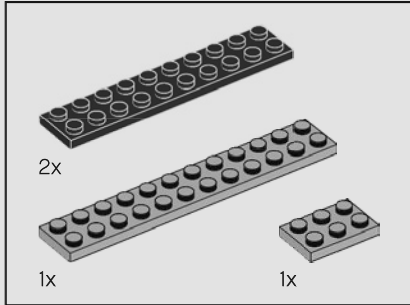
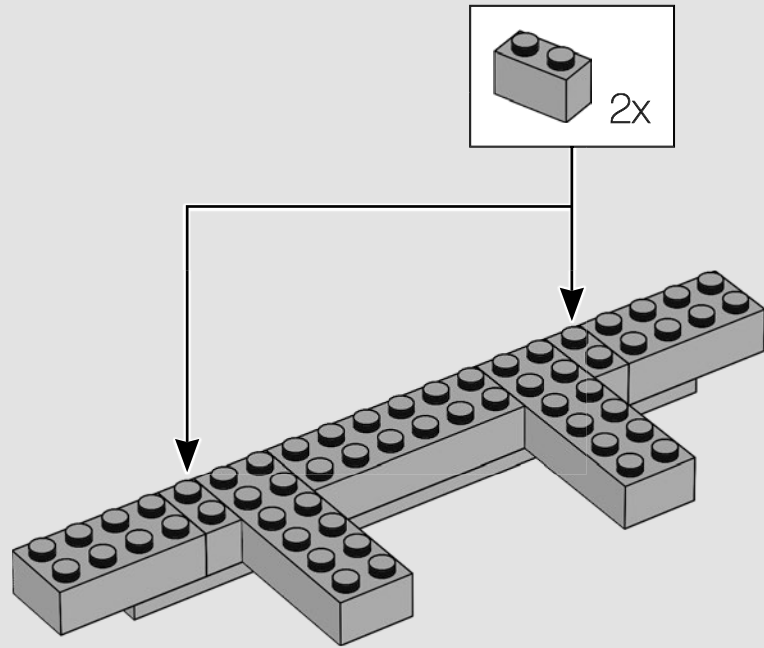

3

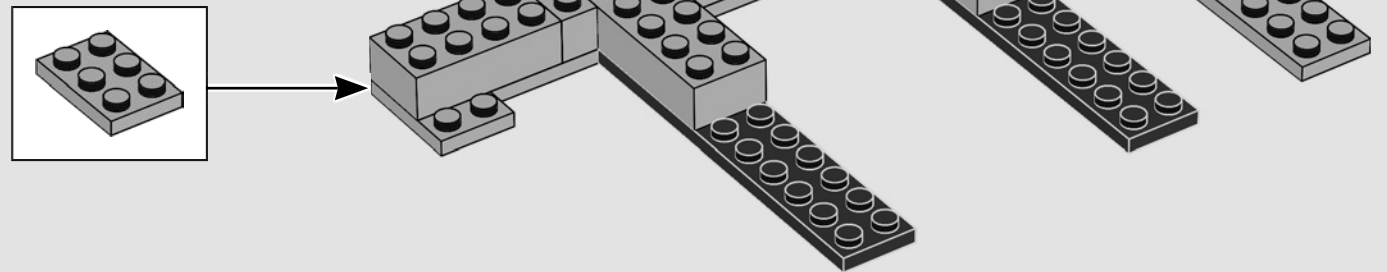

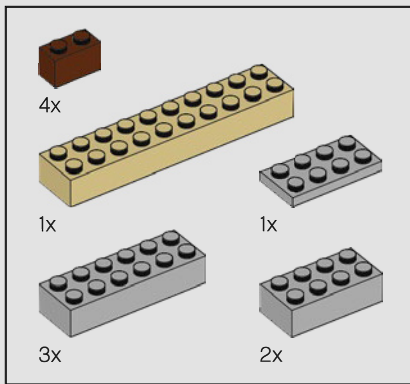

4

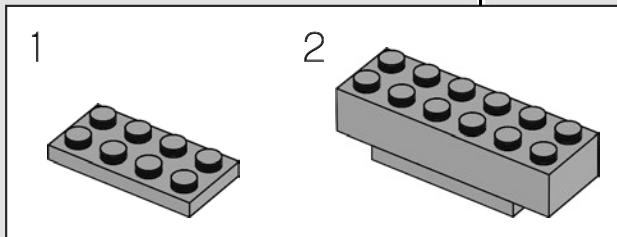
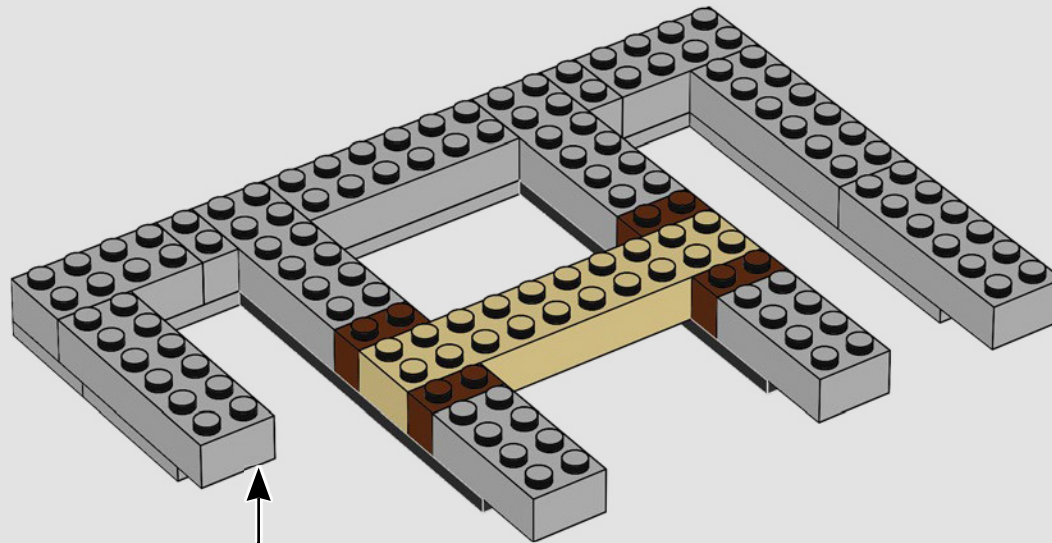

Karamo Brown

*"Lo que hace especial a Queer Eye es la gente: el increíble elenco con el que trabajo todos los días y las hermosas vidas en las que tengo la oportunidad de influir y con las que puedo interactuar en el programa y compartir con el mundo".*

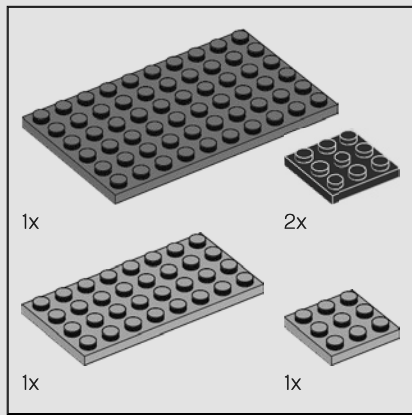

5

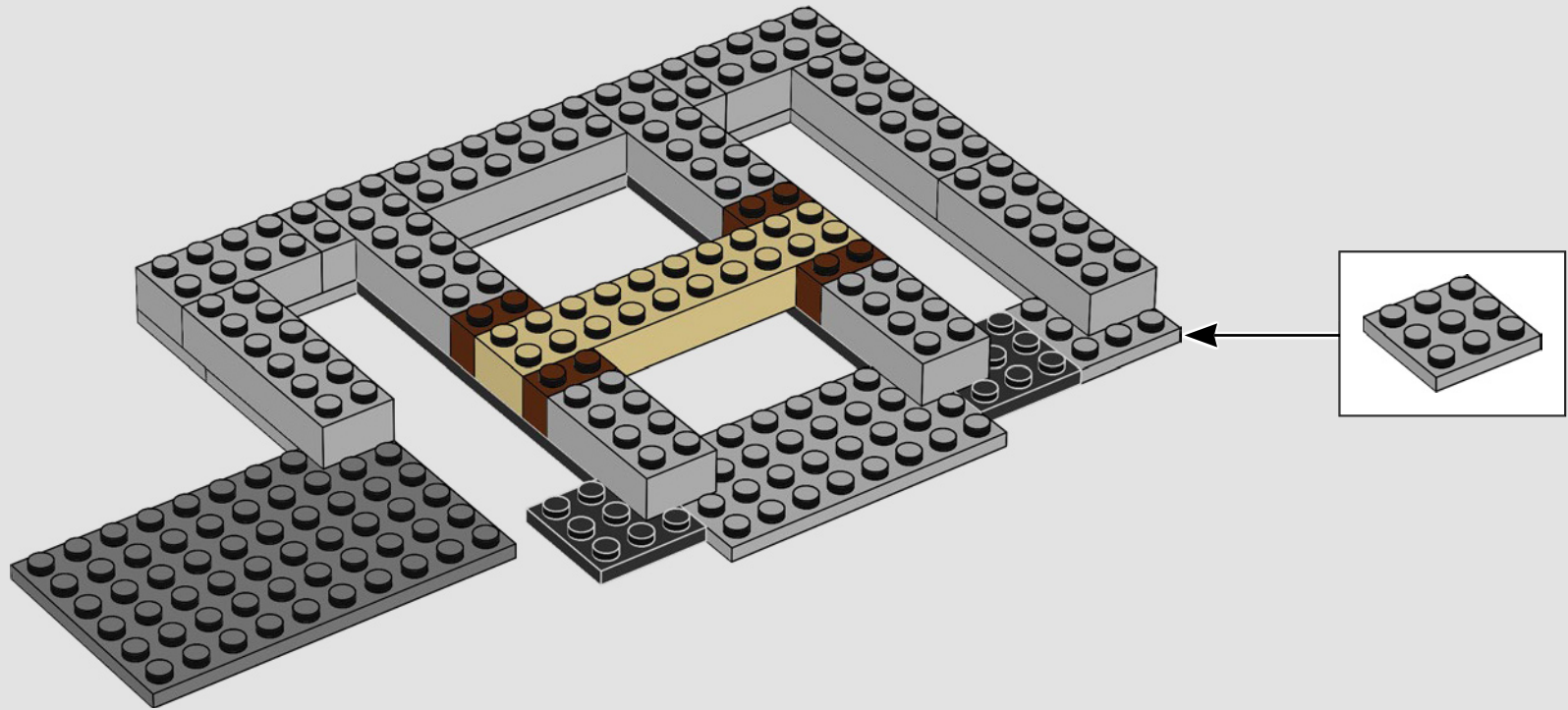

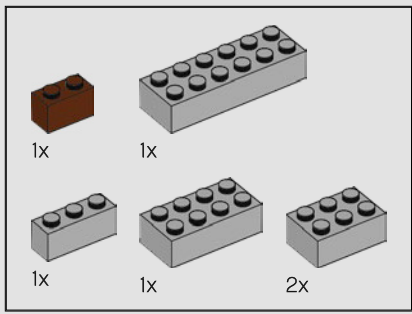

6

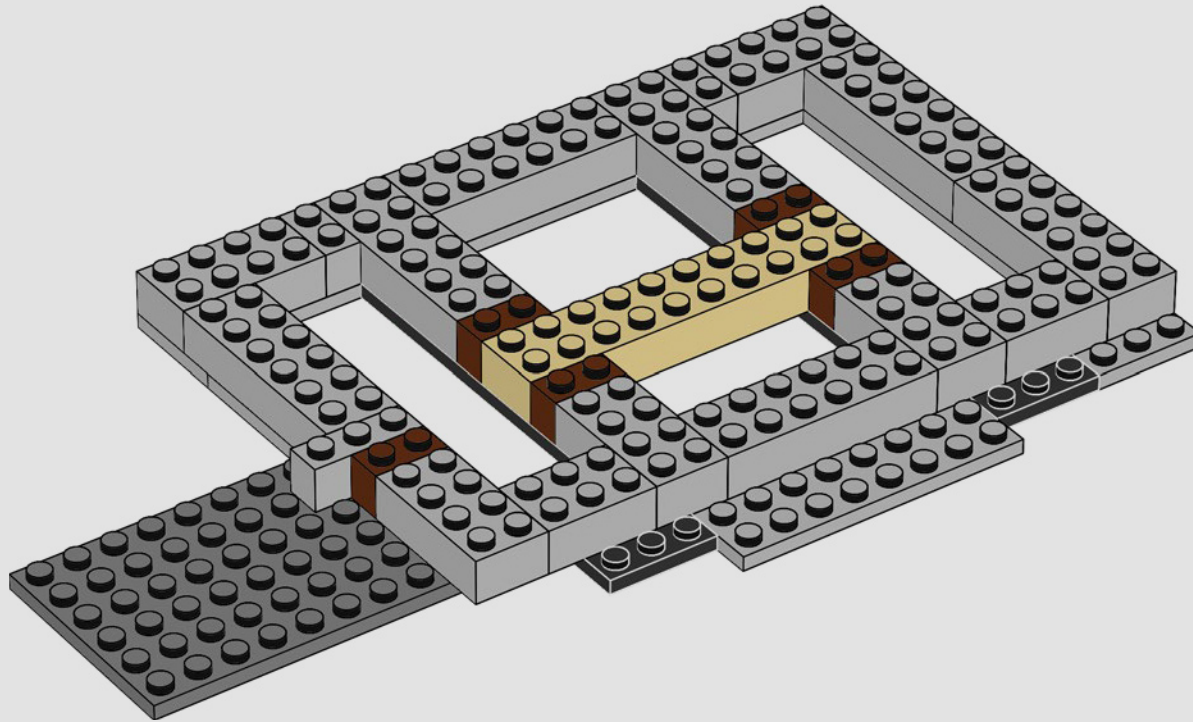

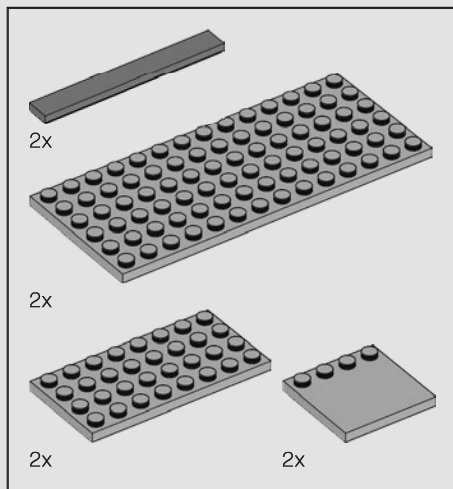

7

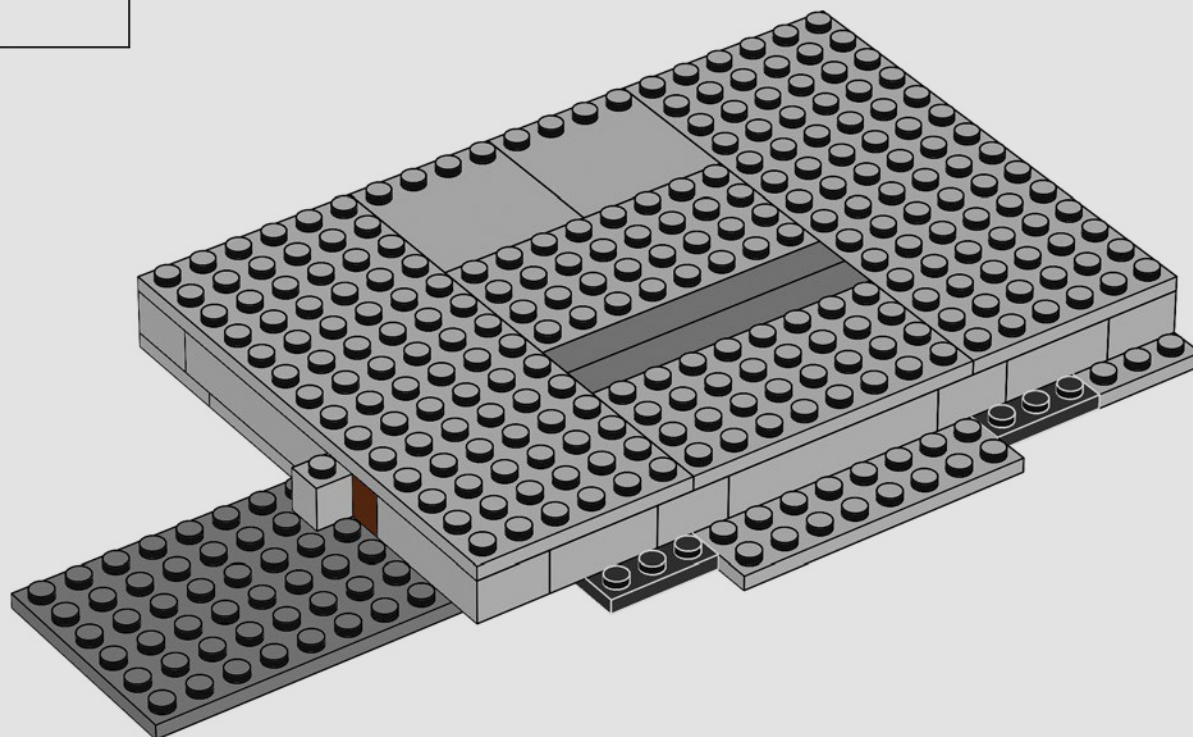

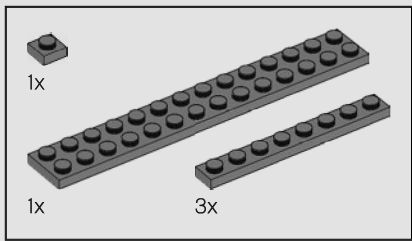

8

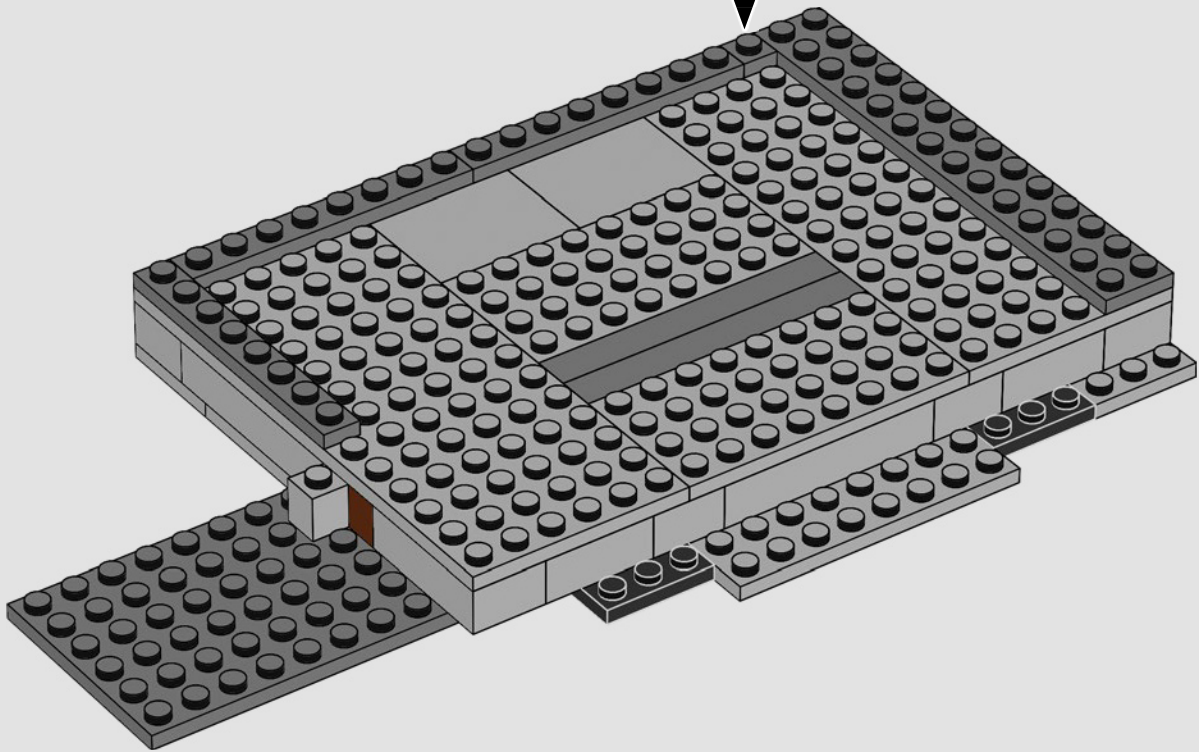
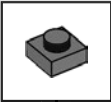



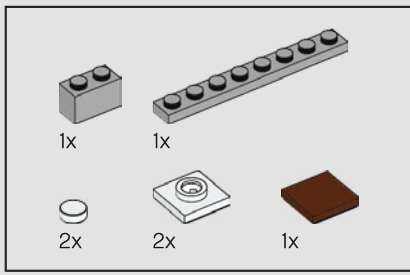

9

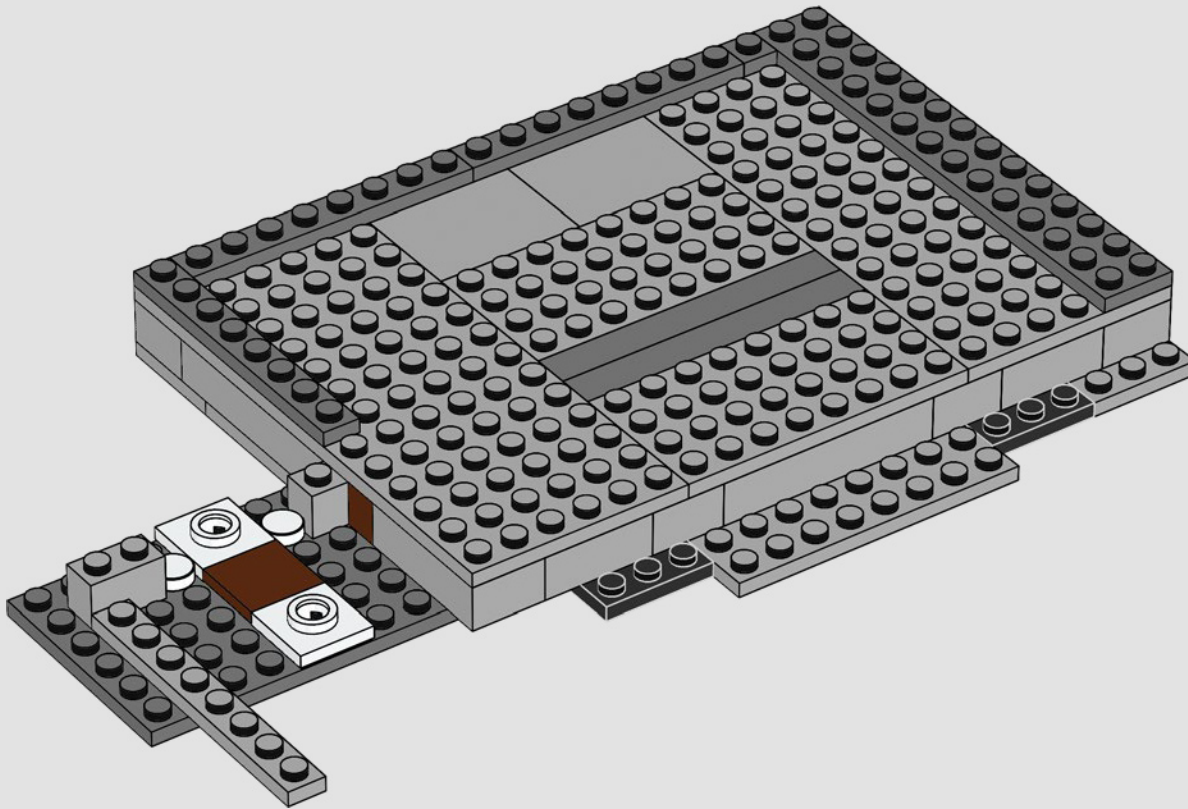

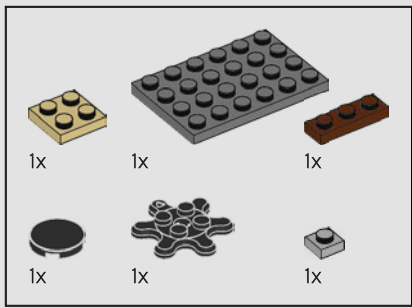

10

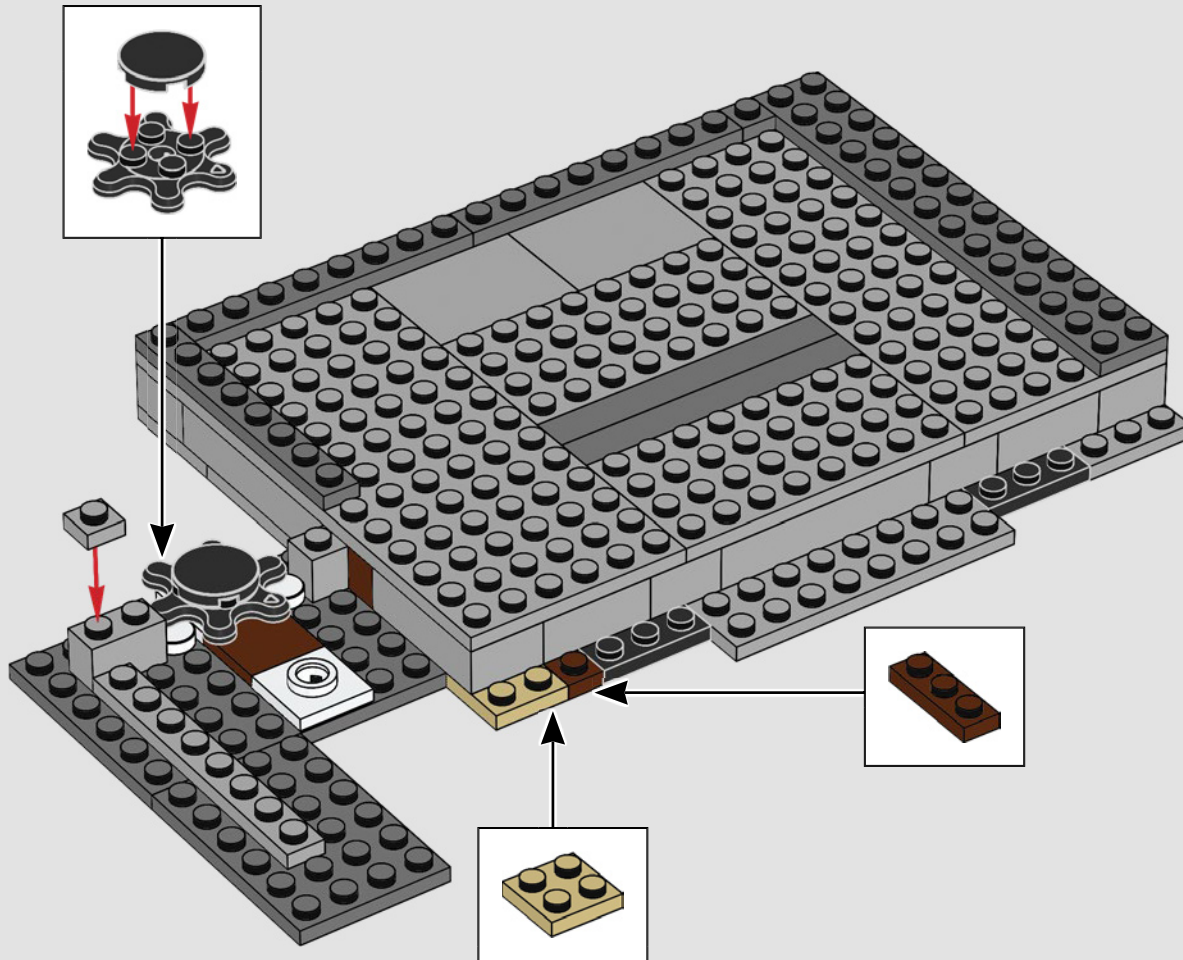

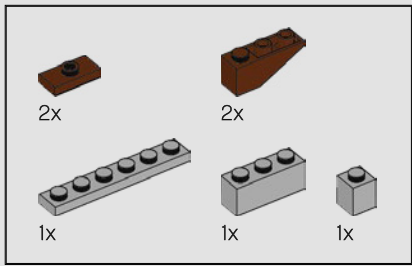

11

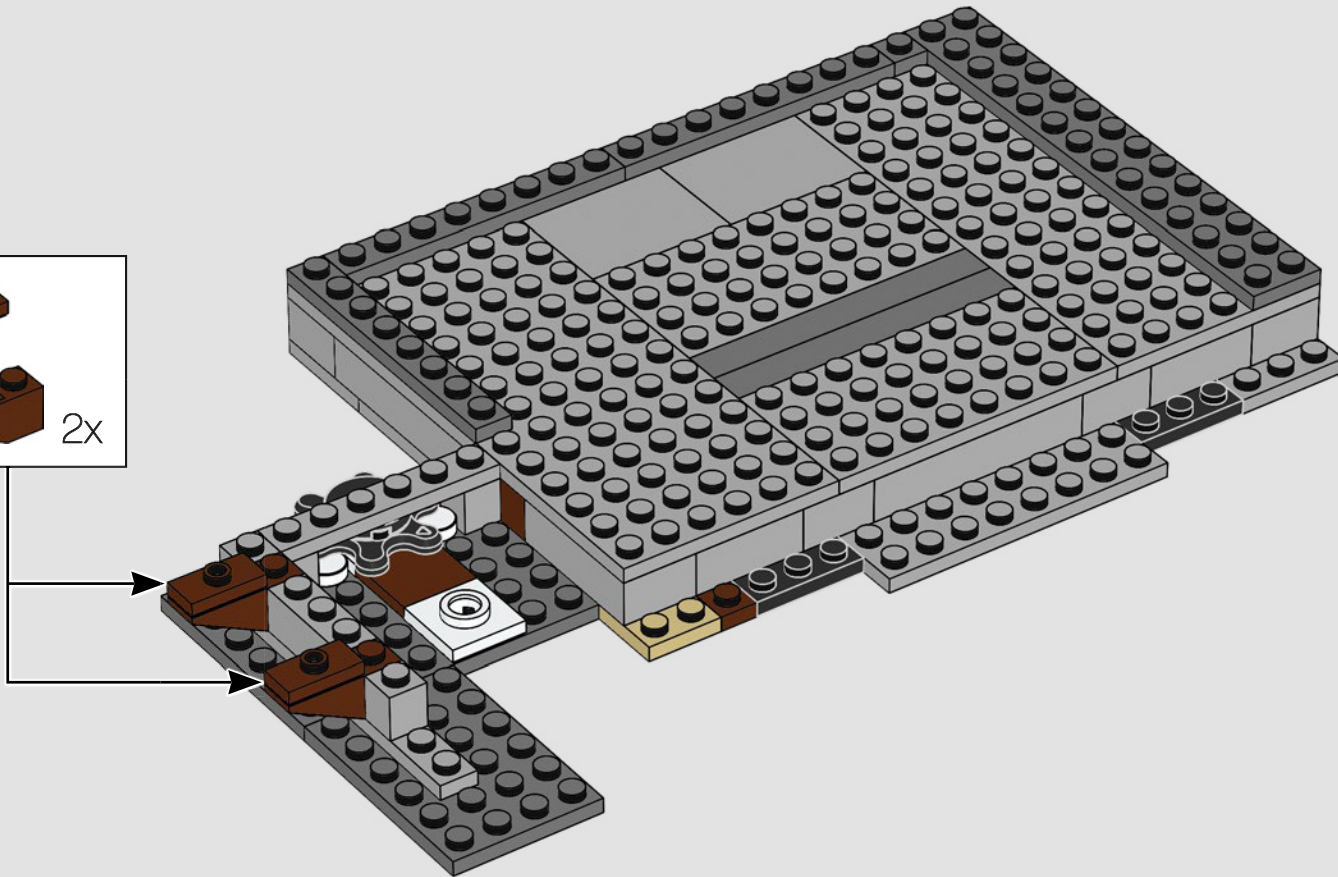
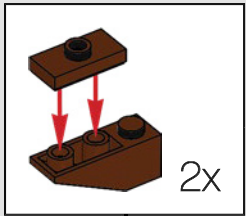

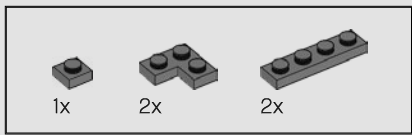

12

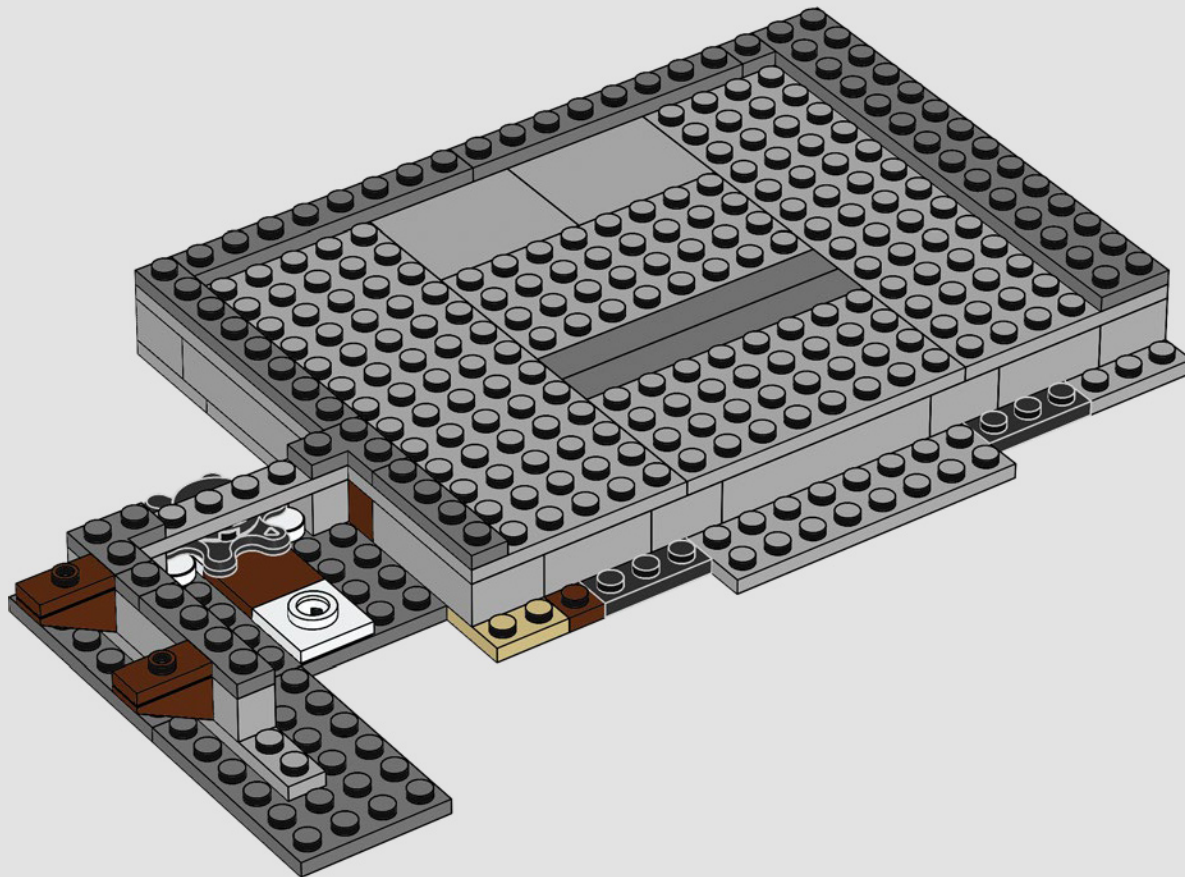

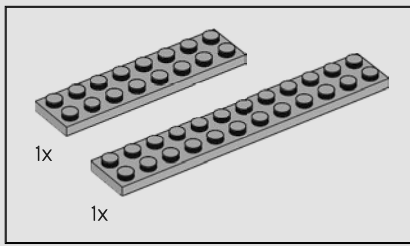

13

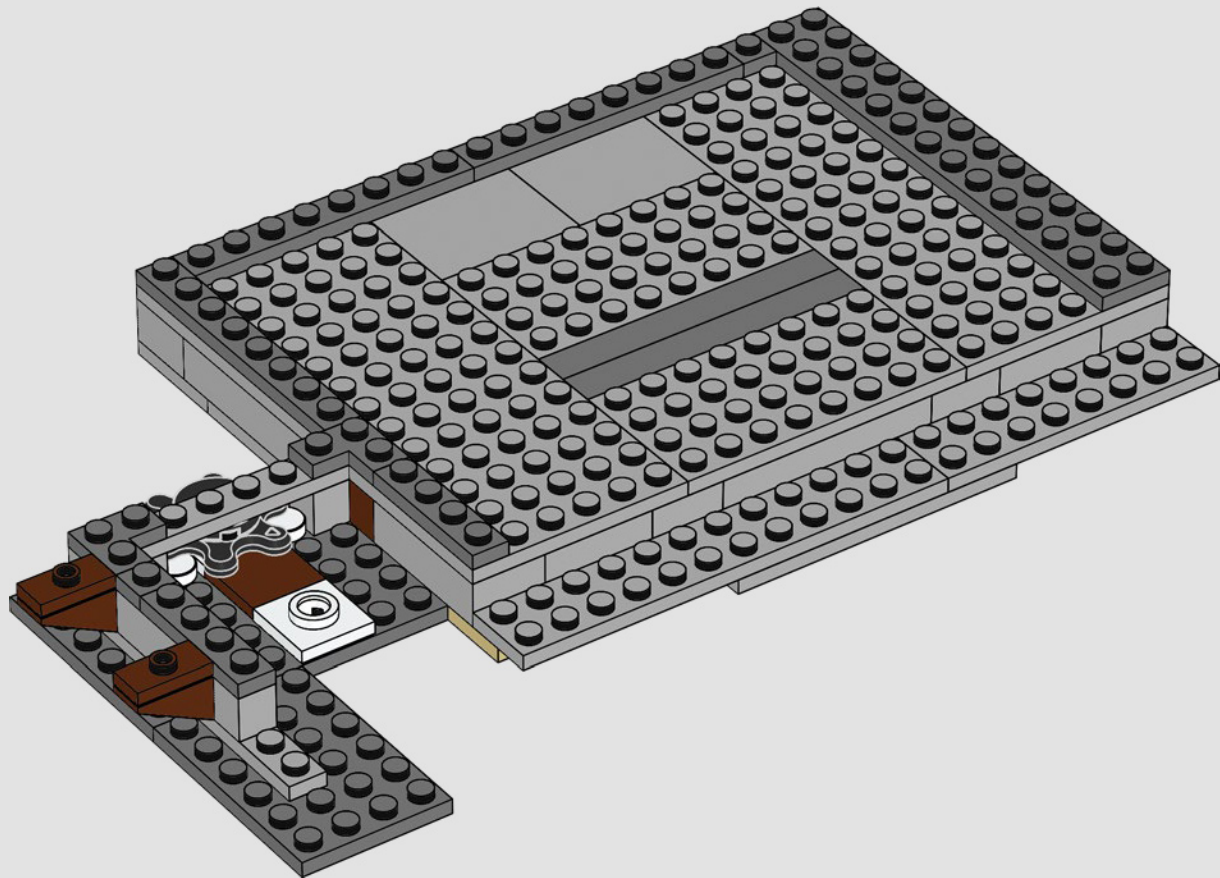

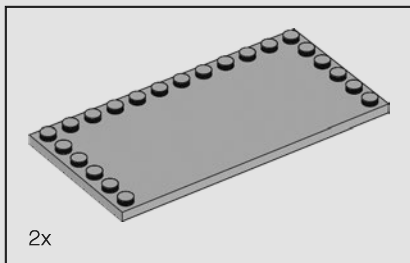

14

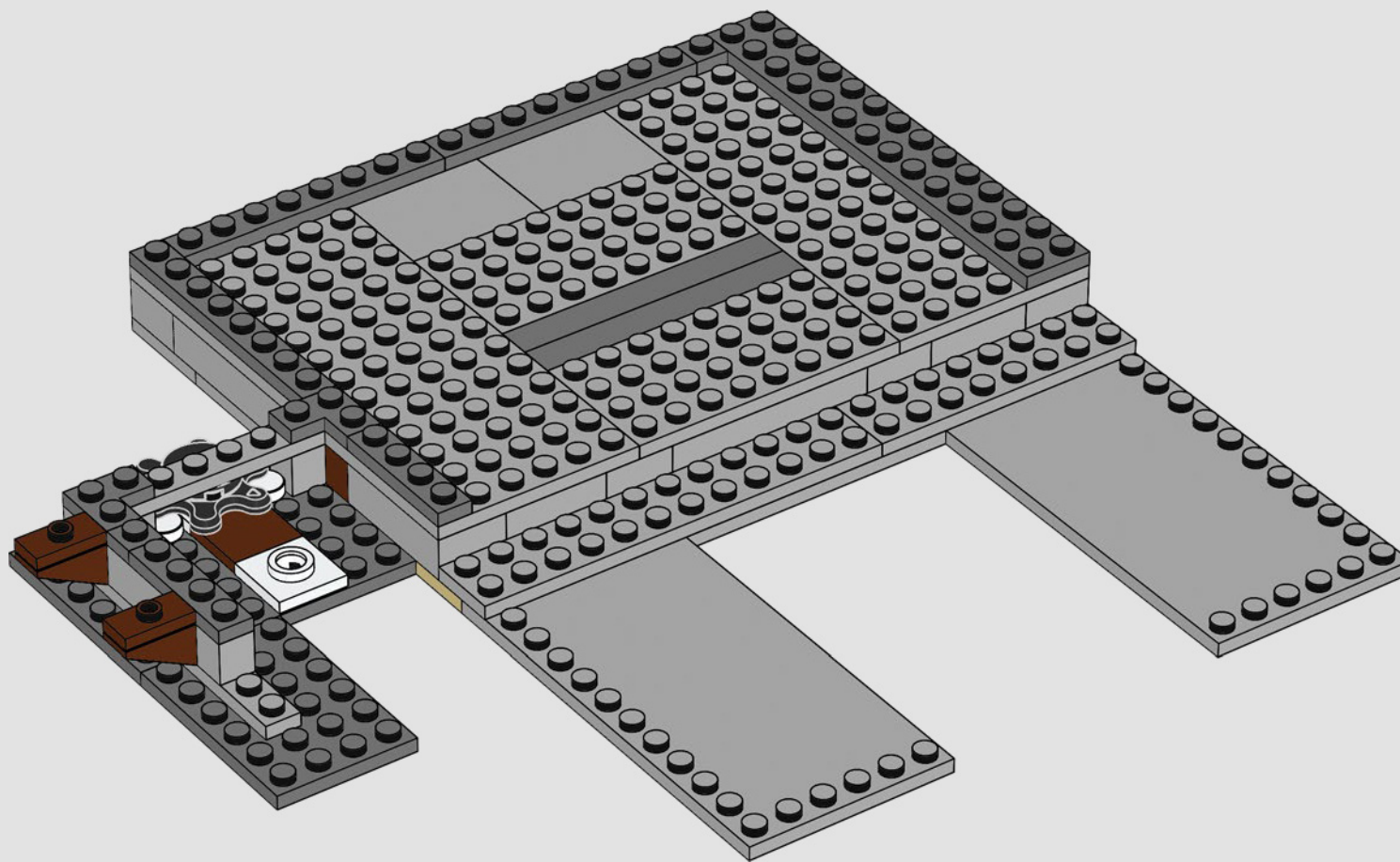

Jonathan Van Ness

*"Mi objetivo en Queer Eye es crear un legado de conexión y entendimiento, no solo para ofrecerlo a quienes nos rodean, sino también para comprendernos y aceptarnos a nosotros mismos".*

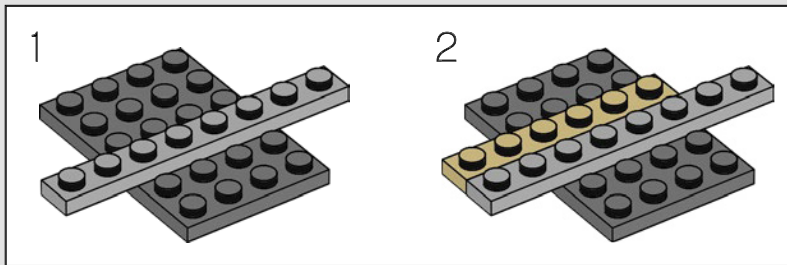
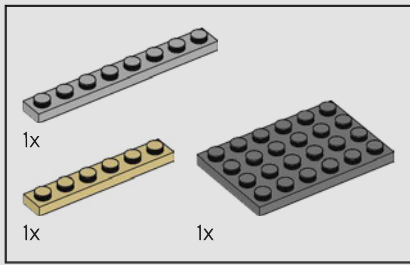

15

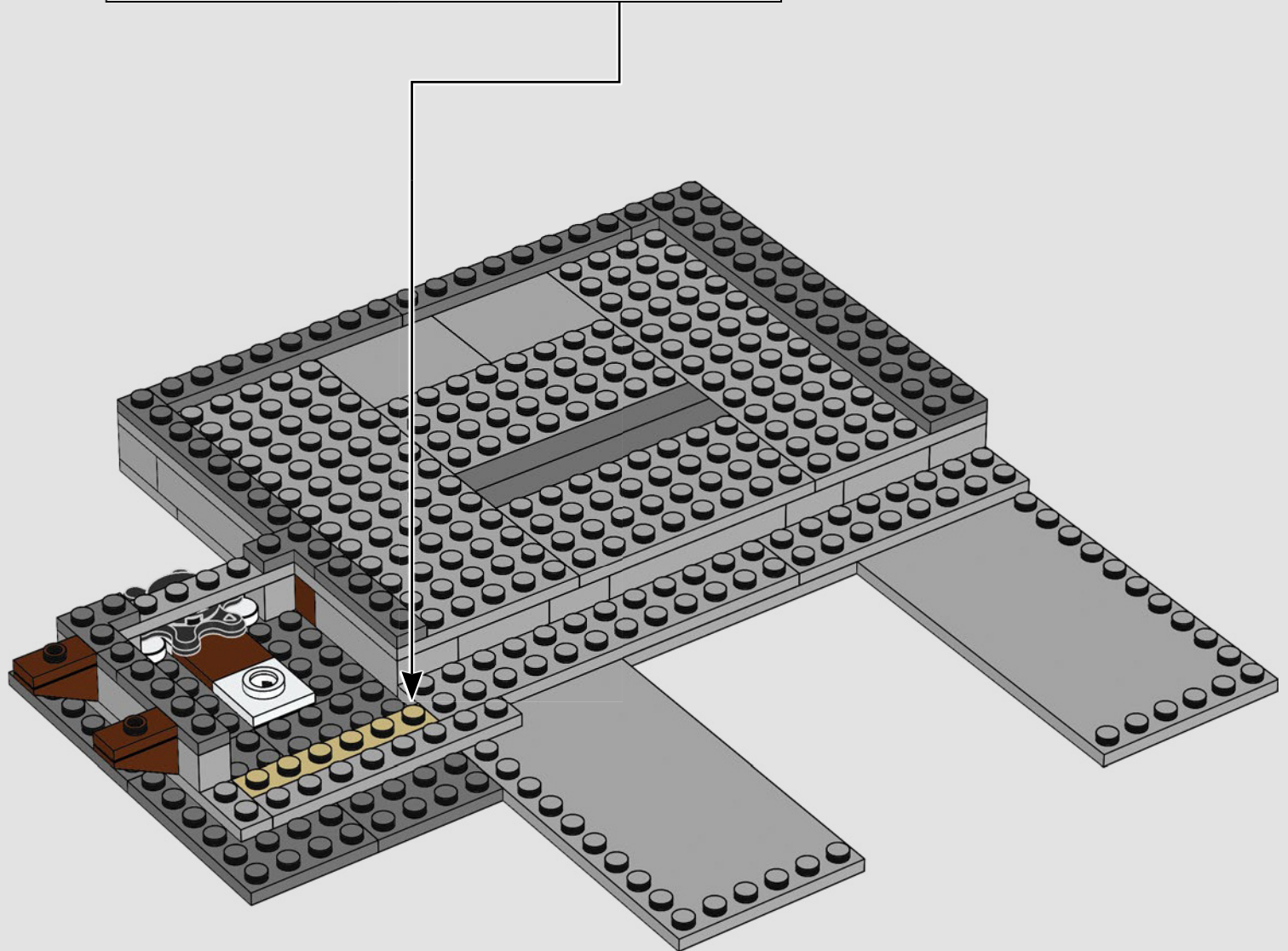

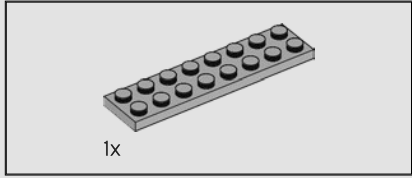
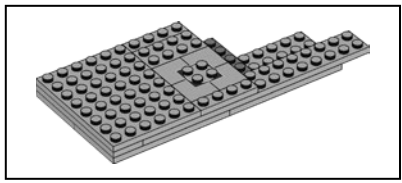

16

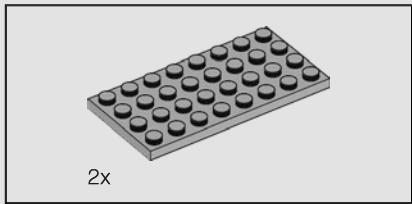
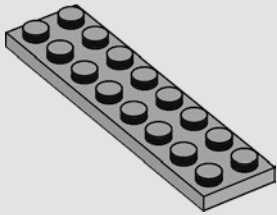

17

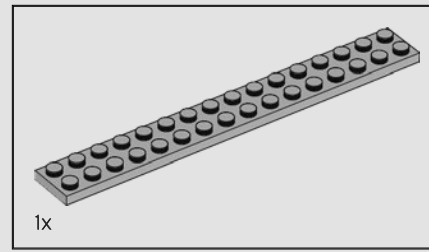
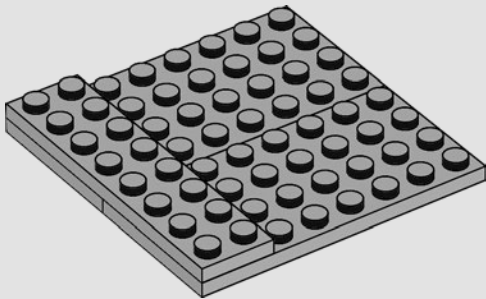

18

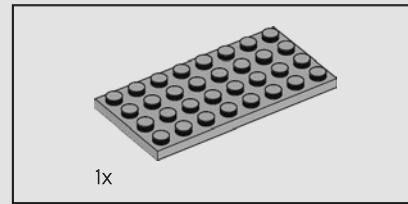
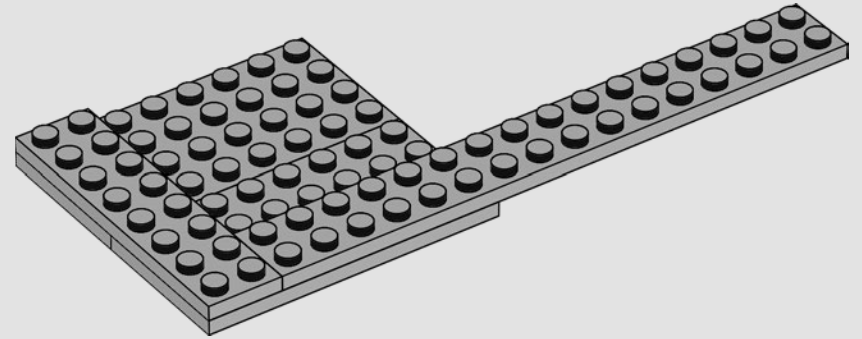

19

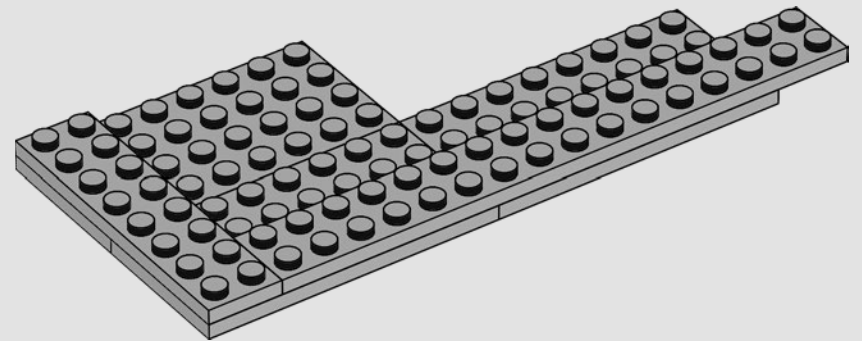



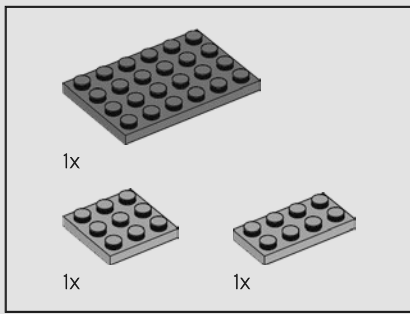

20

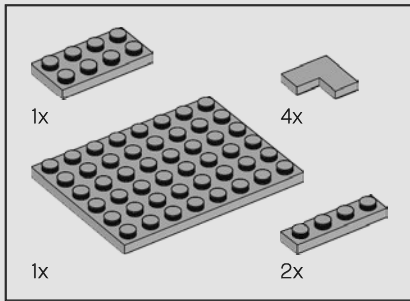
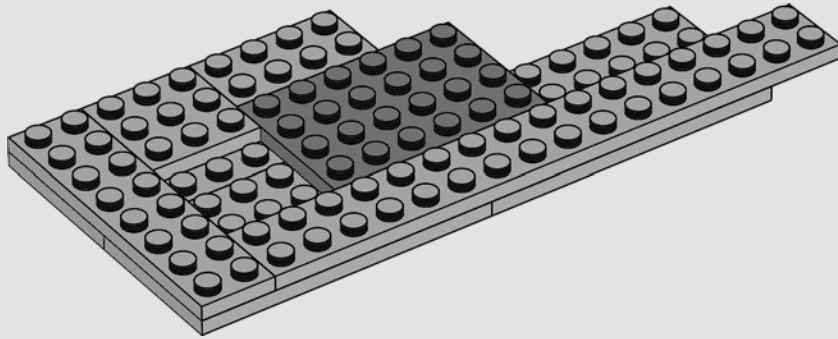

21

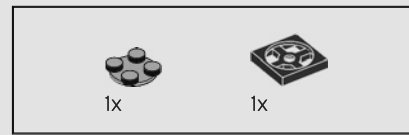
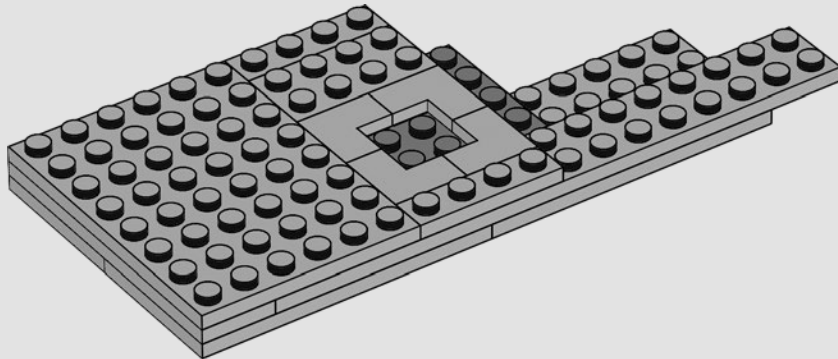

22

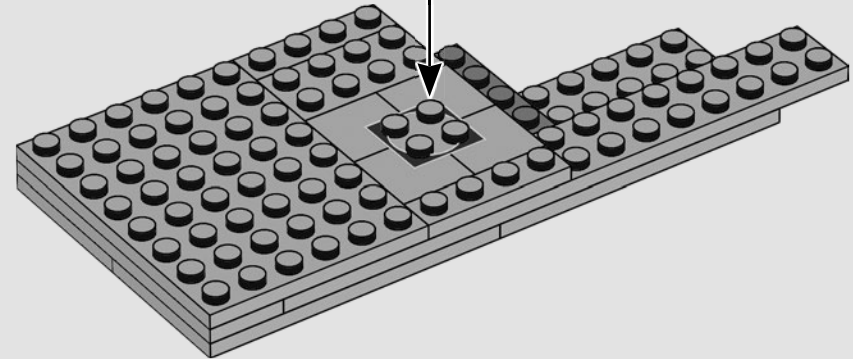
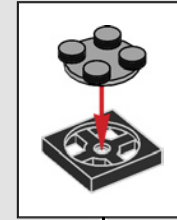



Karamo Brown

"LEGO® ha sido algo muy especial para mí y para mi familia. No solo porque LEGO ha mantenido a mis hijos entretenidos durante horas, sino también porque ha sido una excelente actividad para fortalecer mis vínculos con ellos".

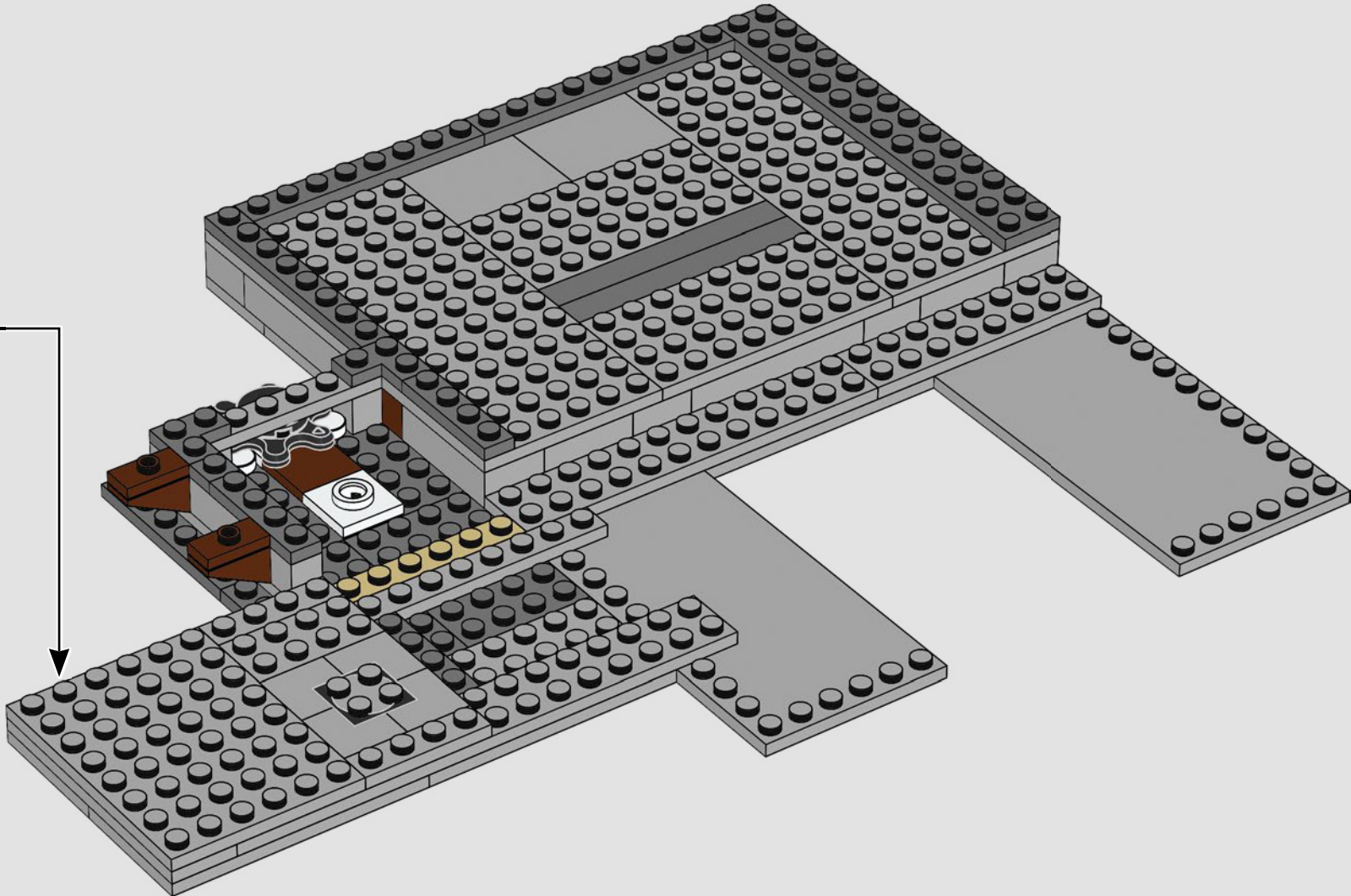

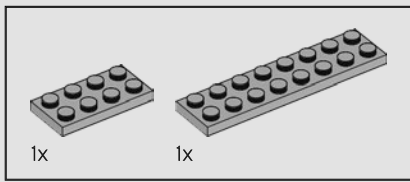

24

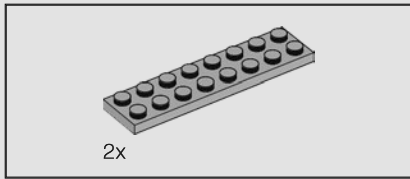
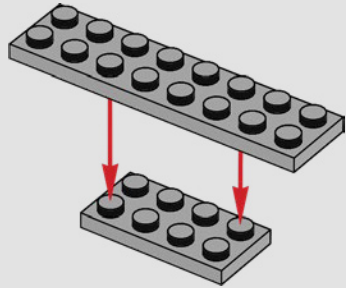

25

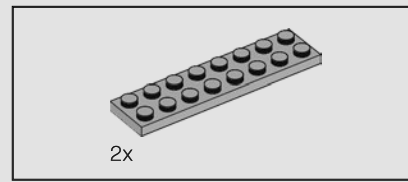
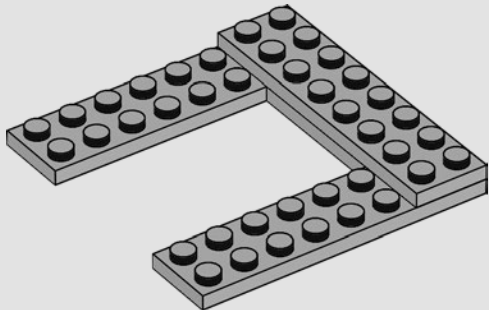

26

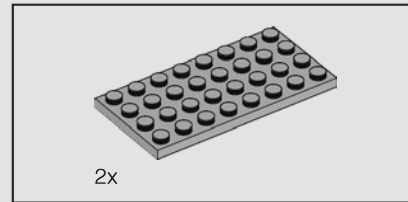
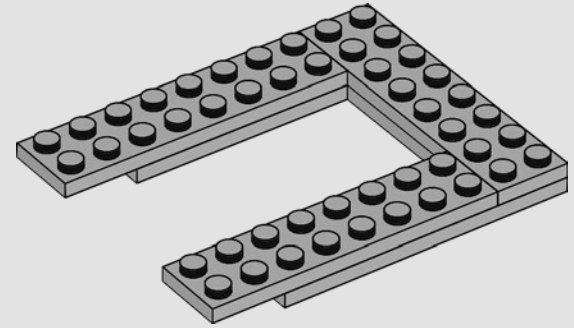

27

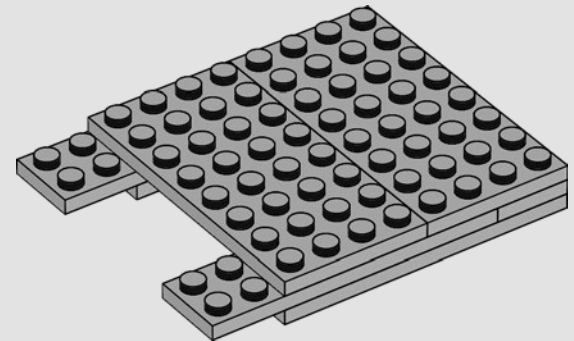

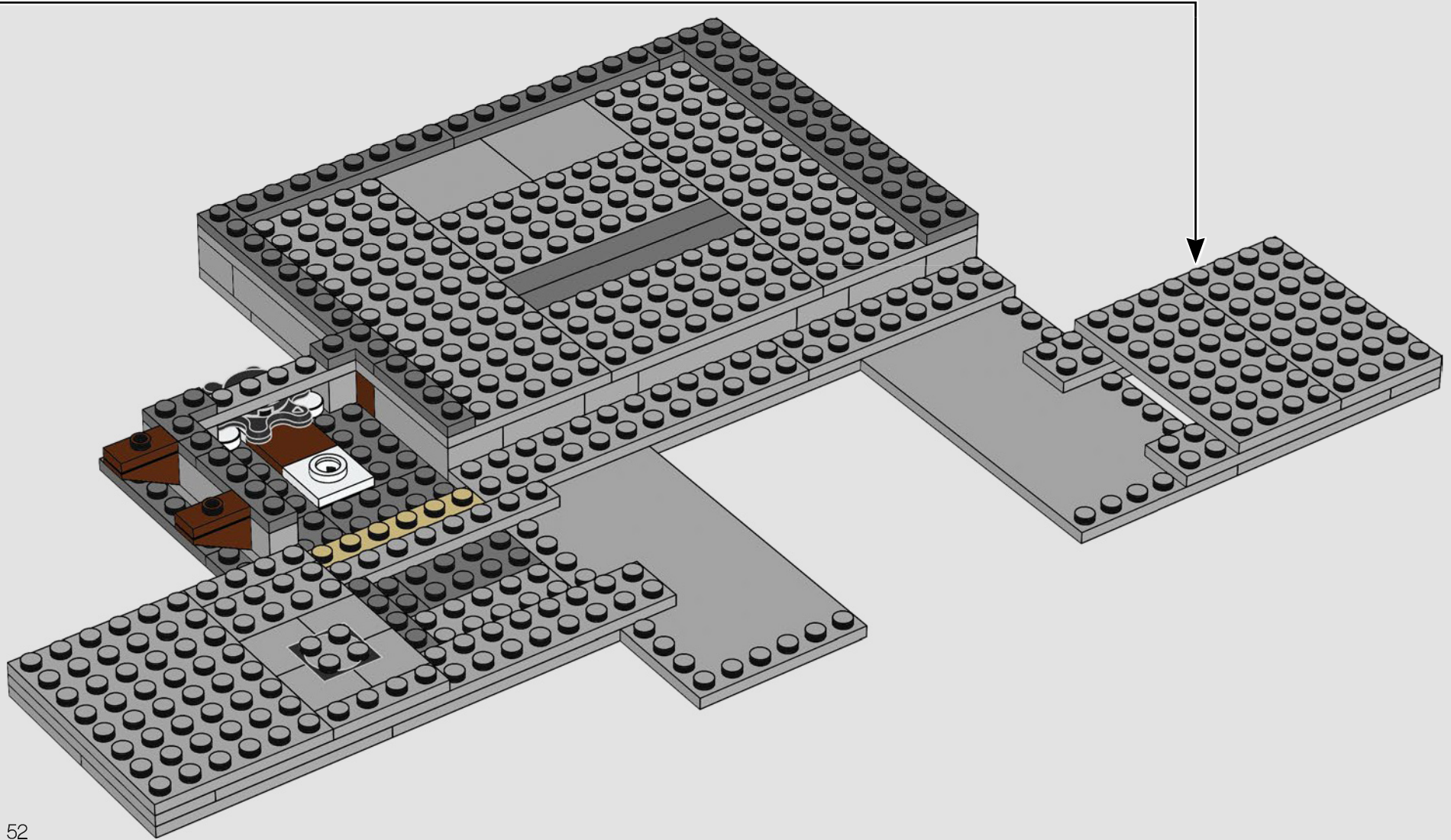

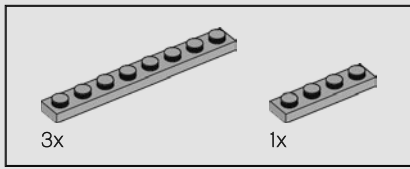

29

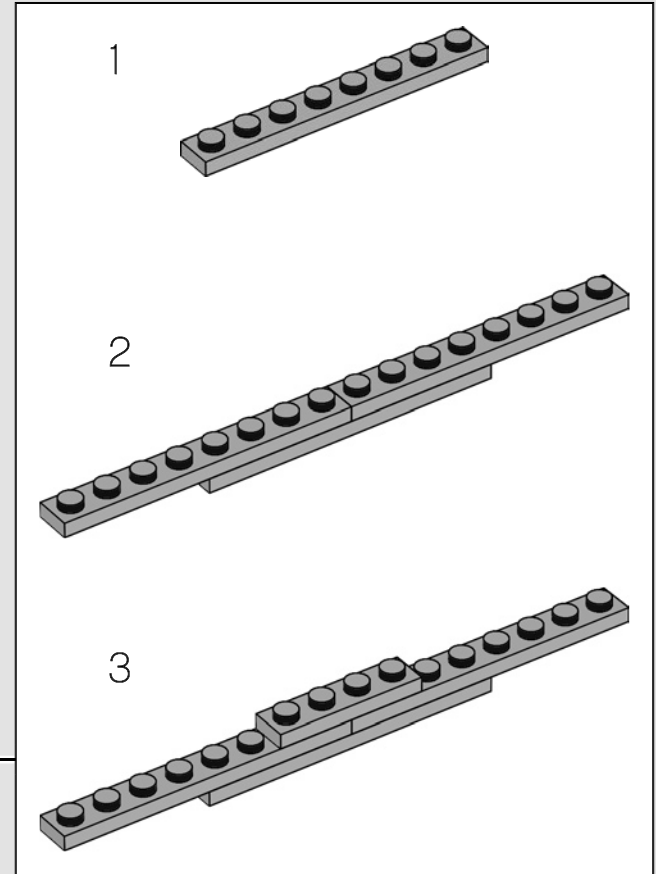
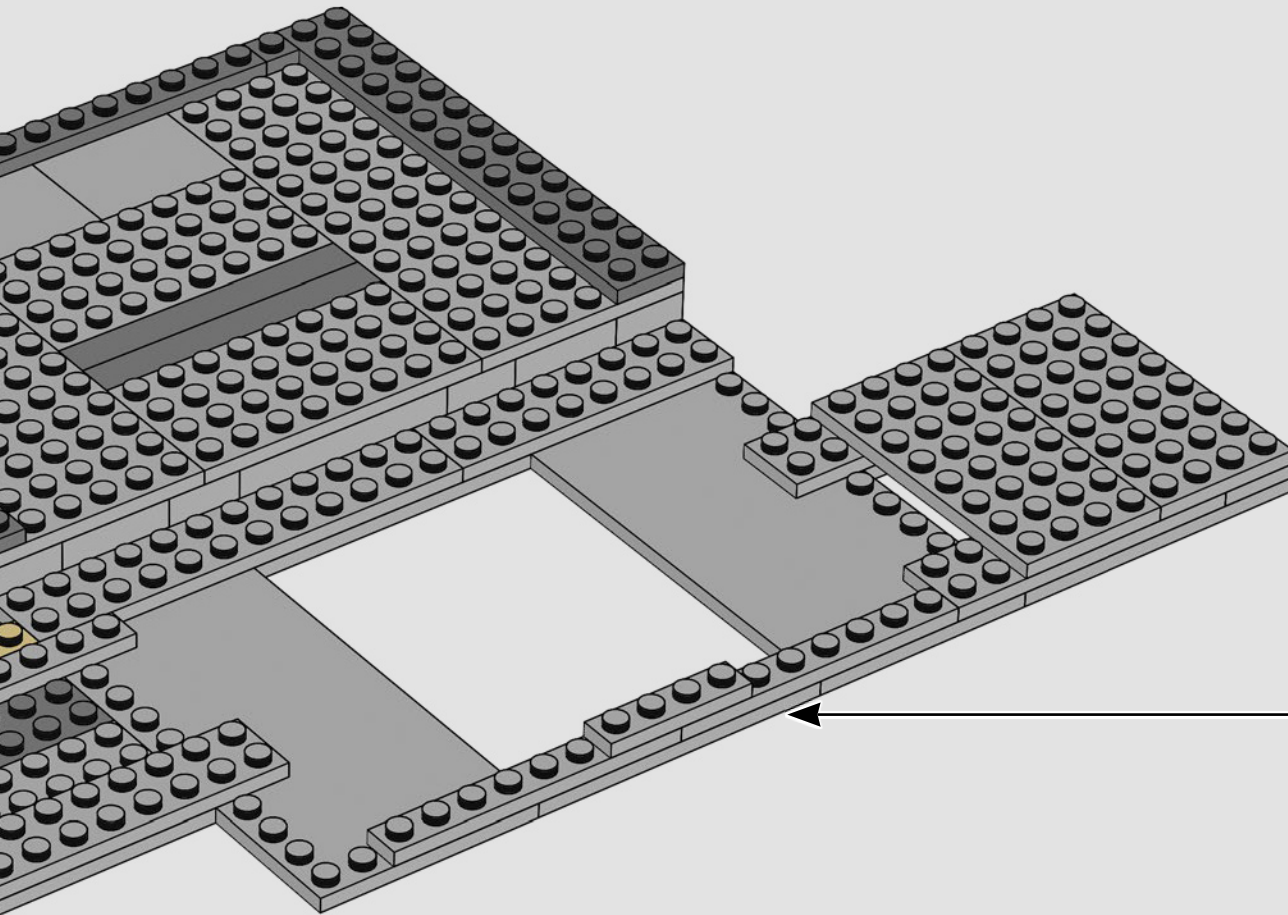

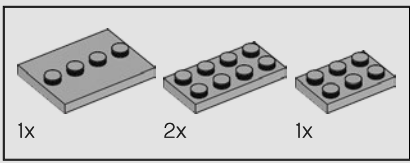

30

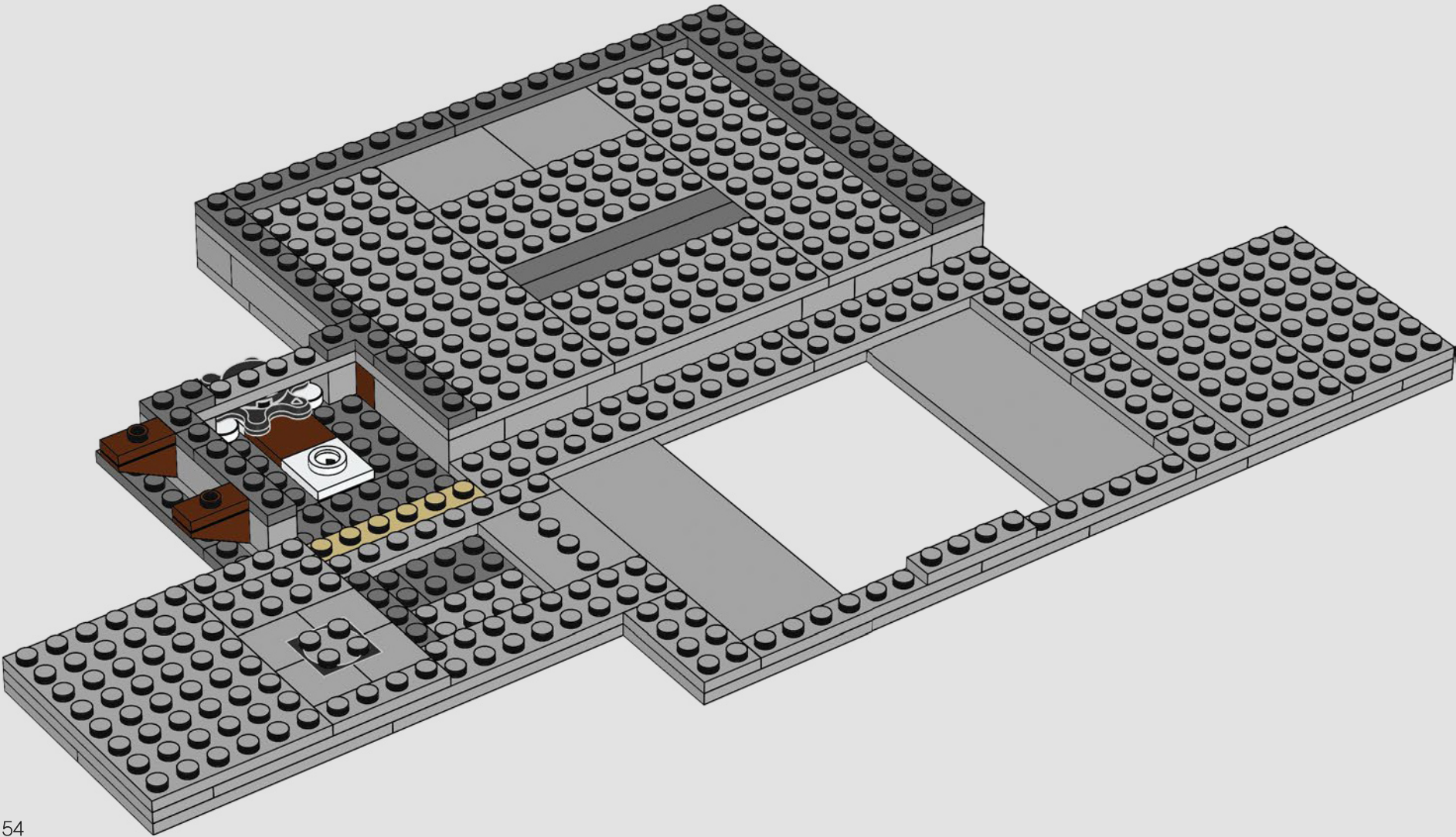

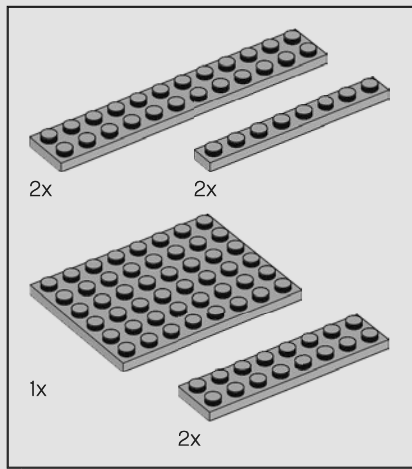

31

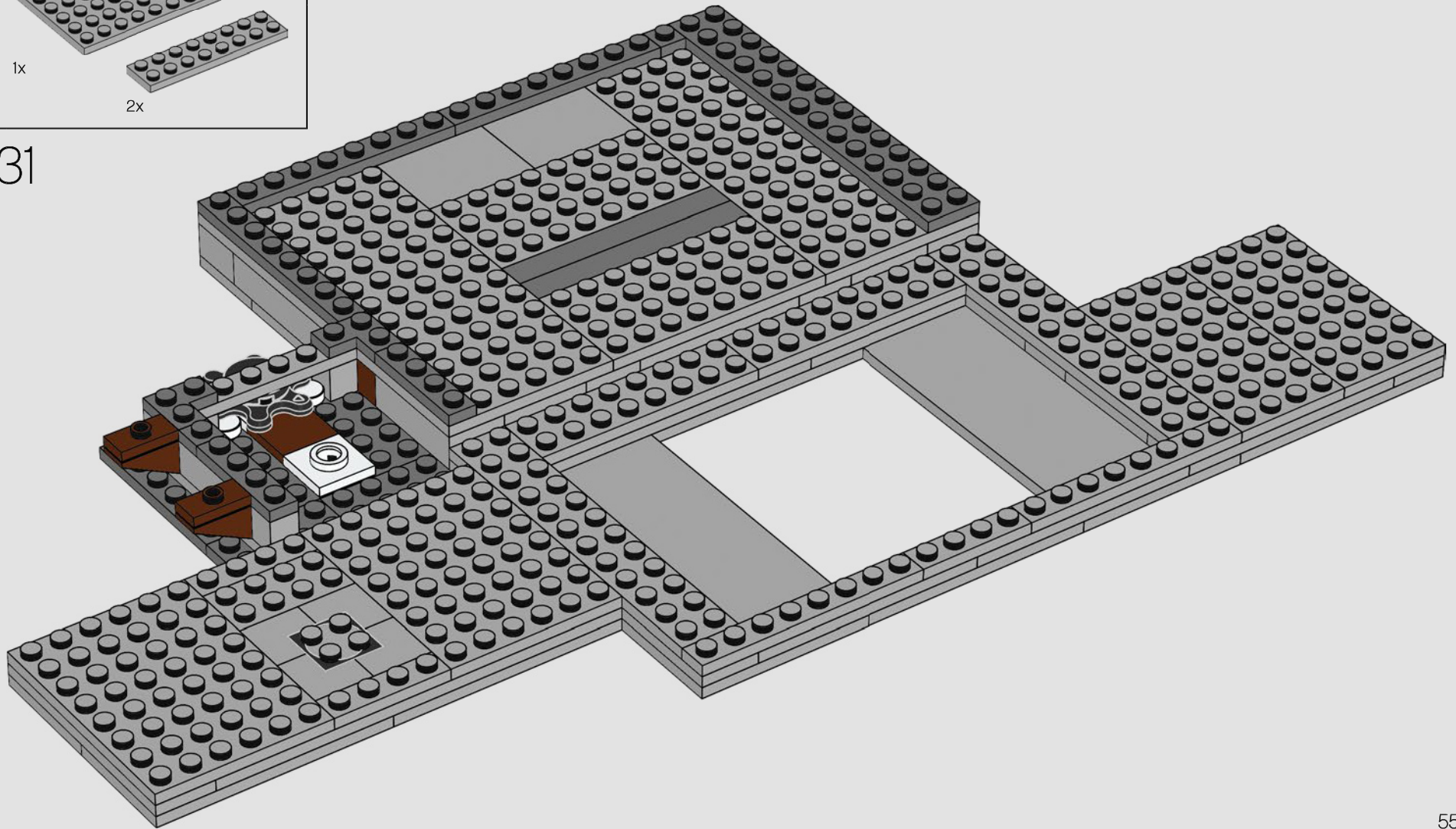

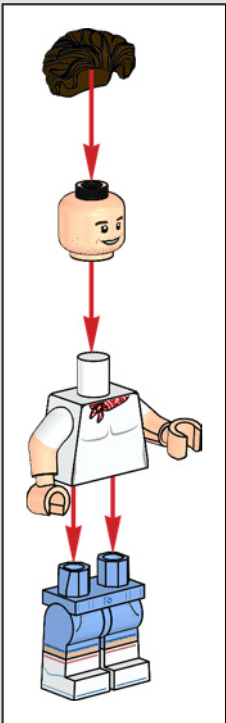
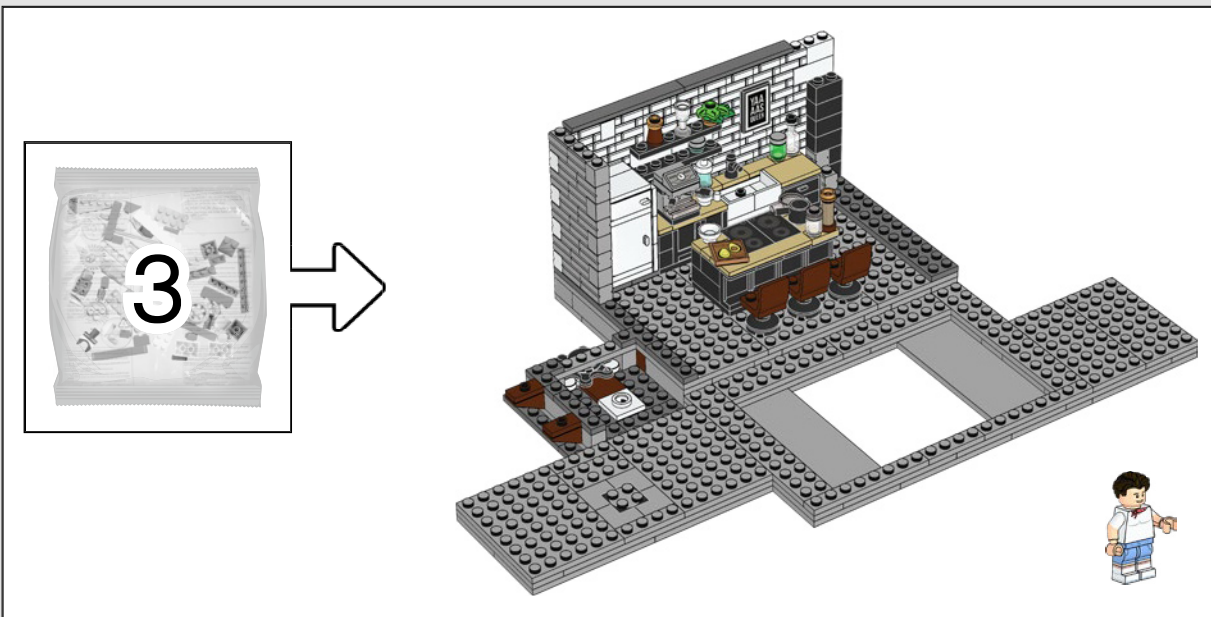

Antoni Porowski

*"Me encanta el pañuelo en miniatura y, por supuesto, mi accesorio LEGO® no podía ser otra cosa que una pequeña tabla de cortar con aguacates".*



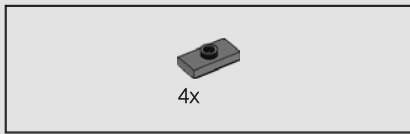

32

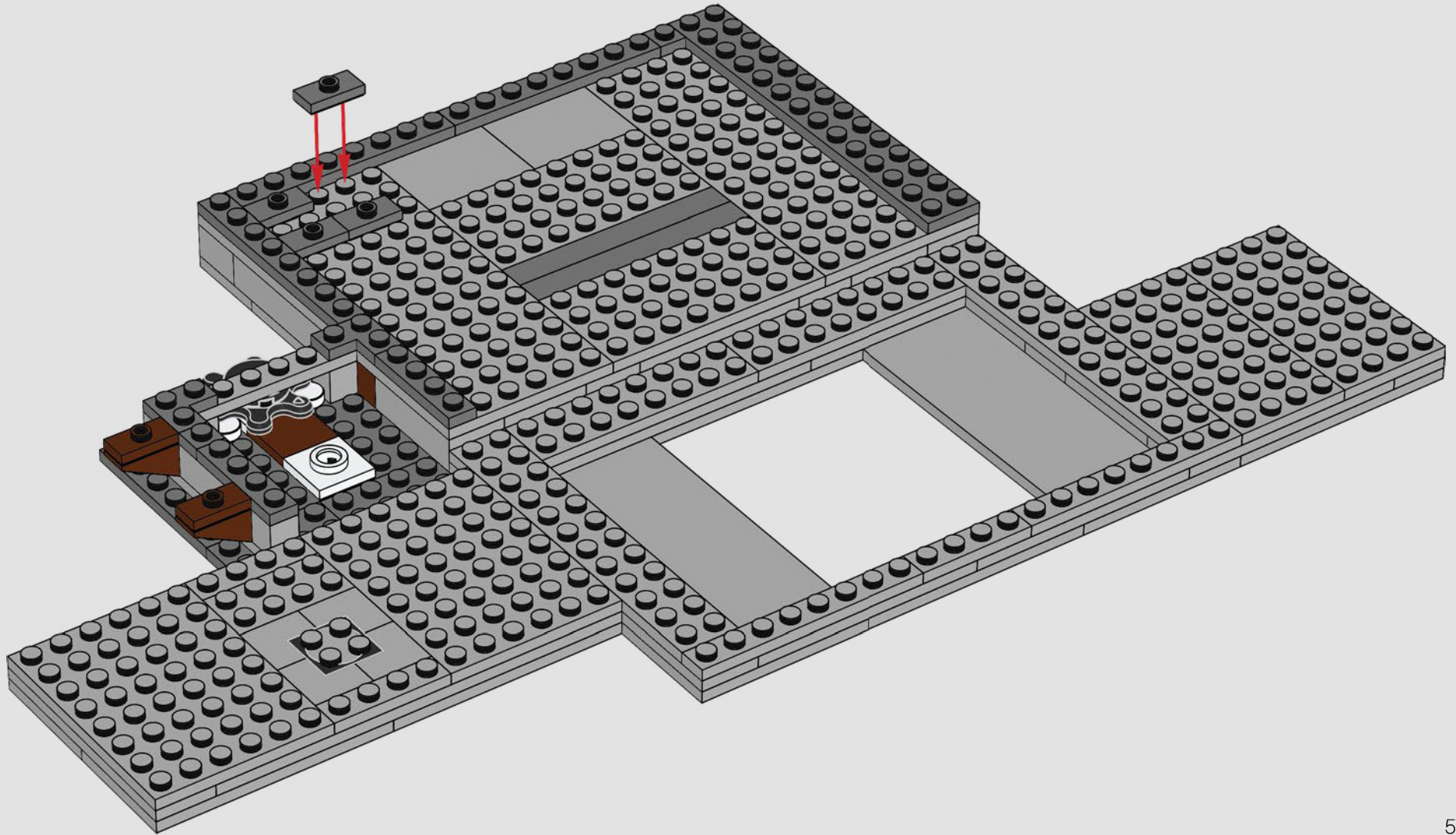

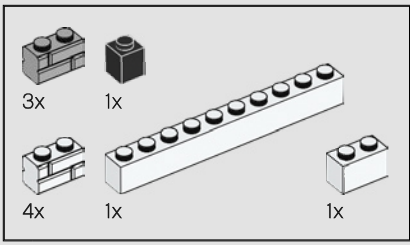

33

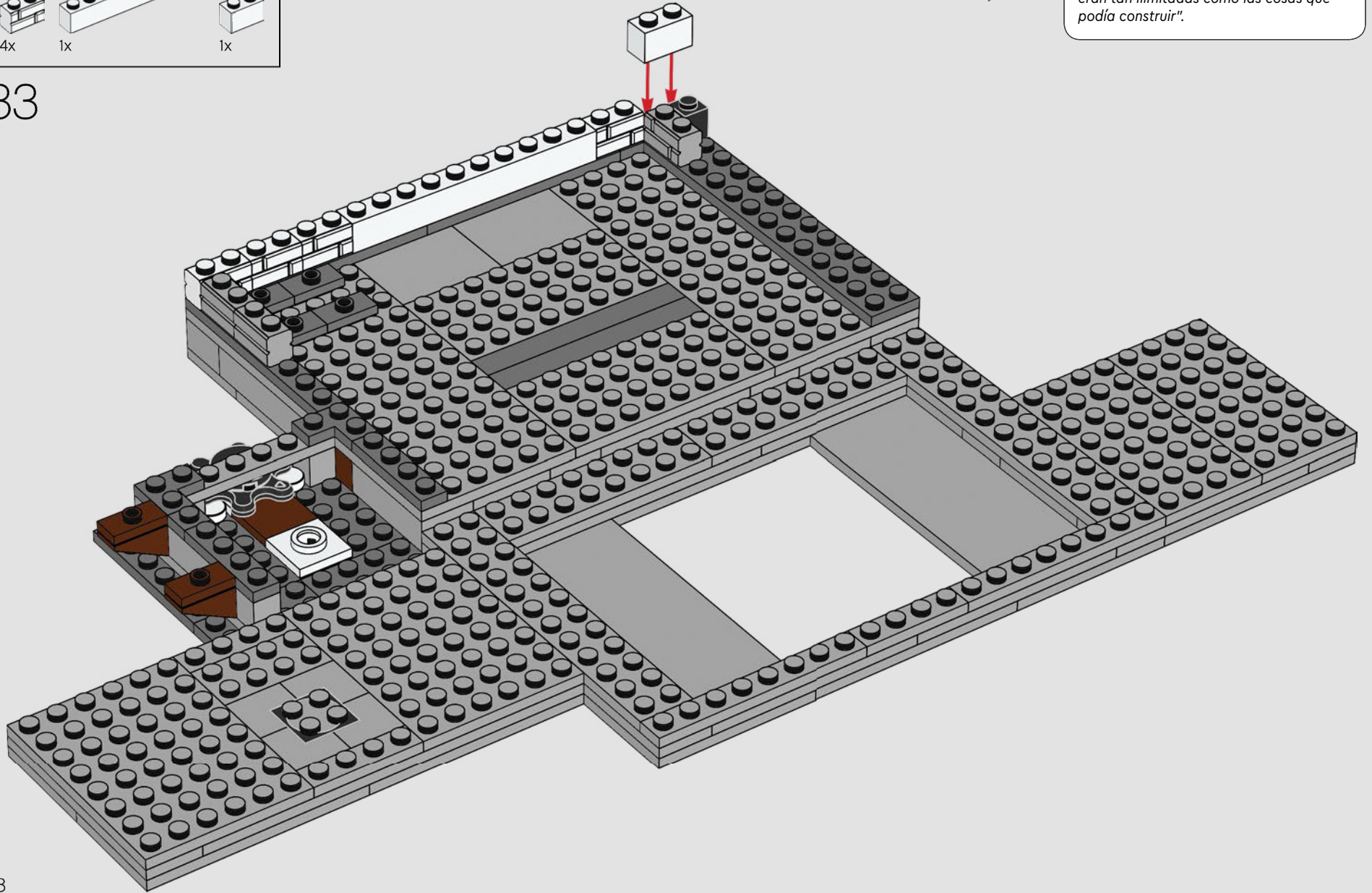

Bobby Berk

*"Cuando era niño, LEGO® encendió la llama creativa dentro de mí y me hacía sentir que las posibilidades en la vida eran tan ilimitadas como las cosas que podía construir".*

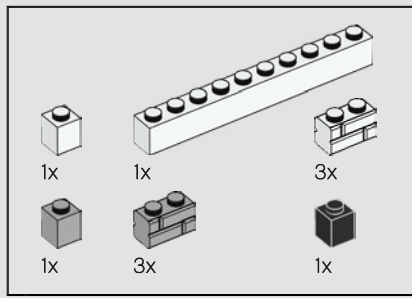

34

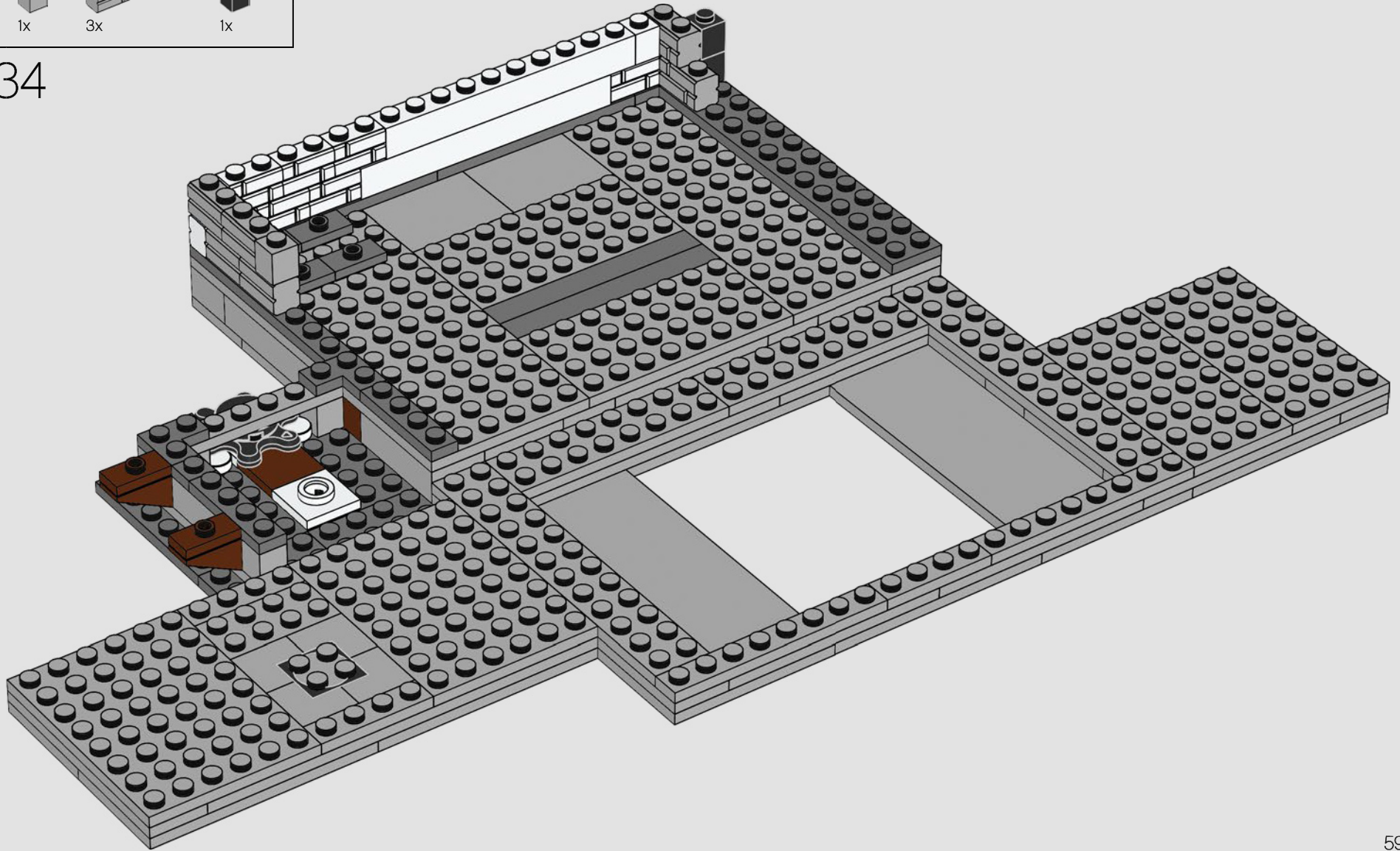

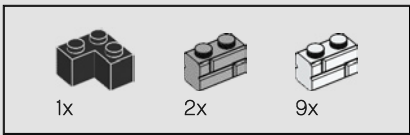

35

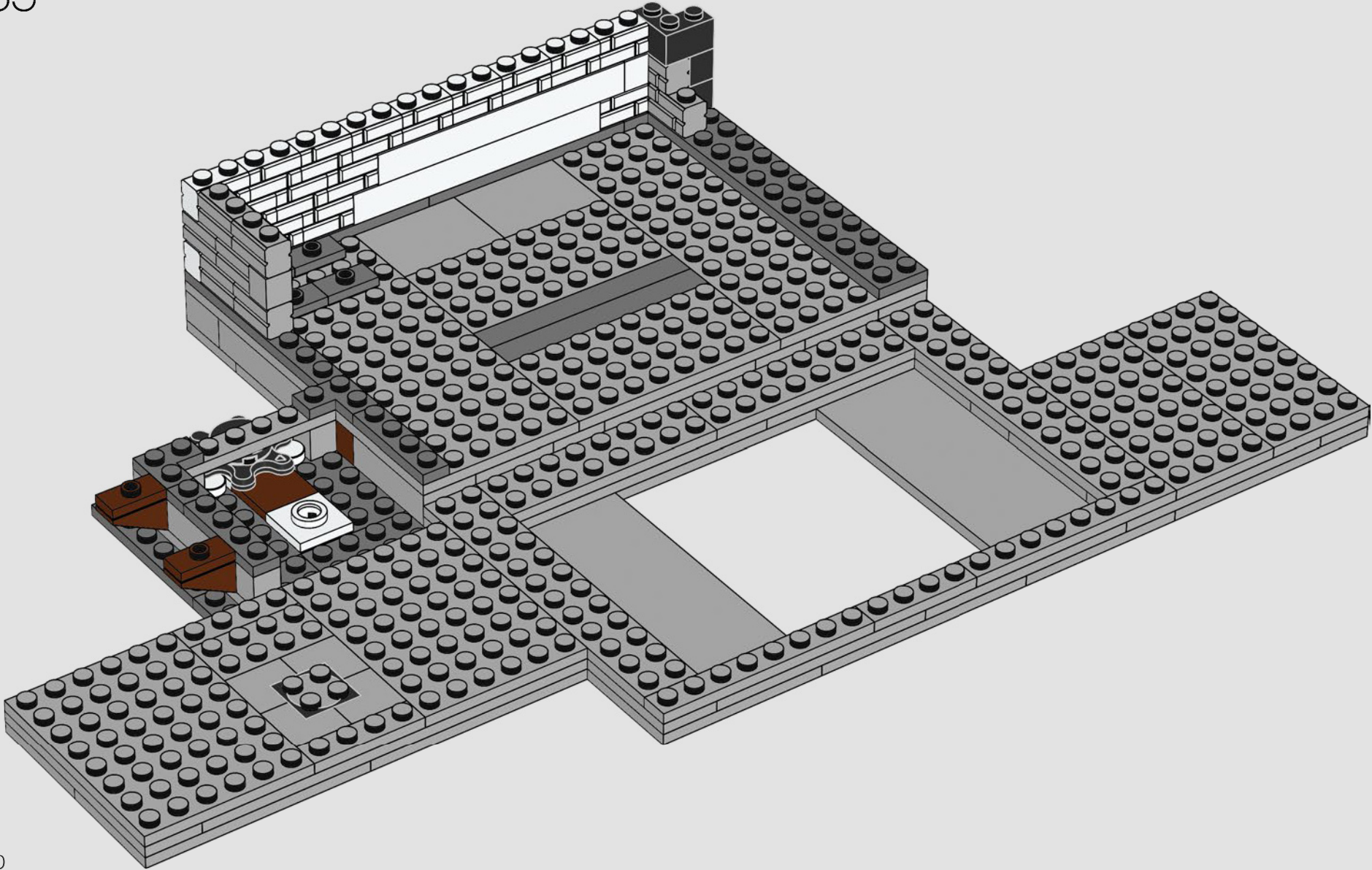

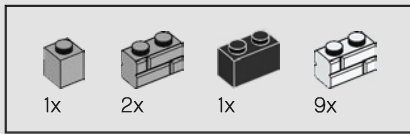

36

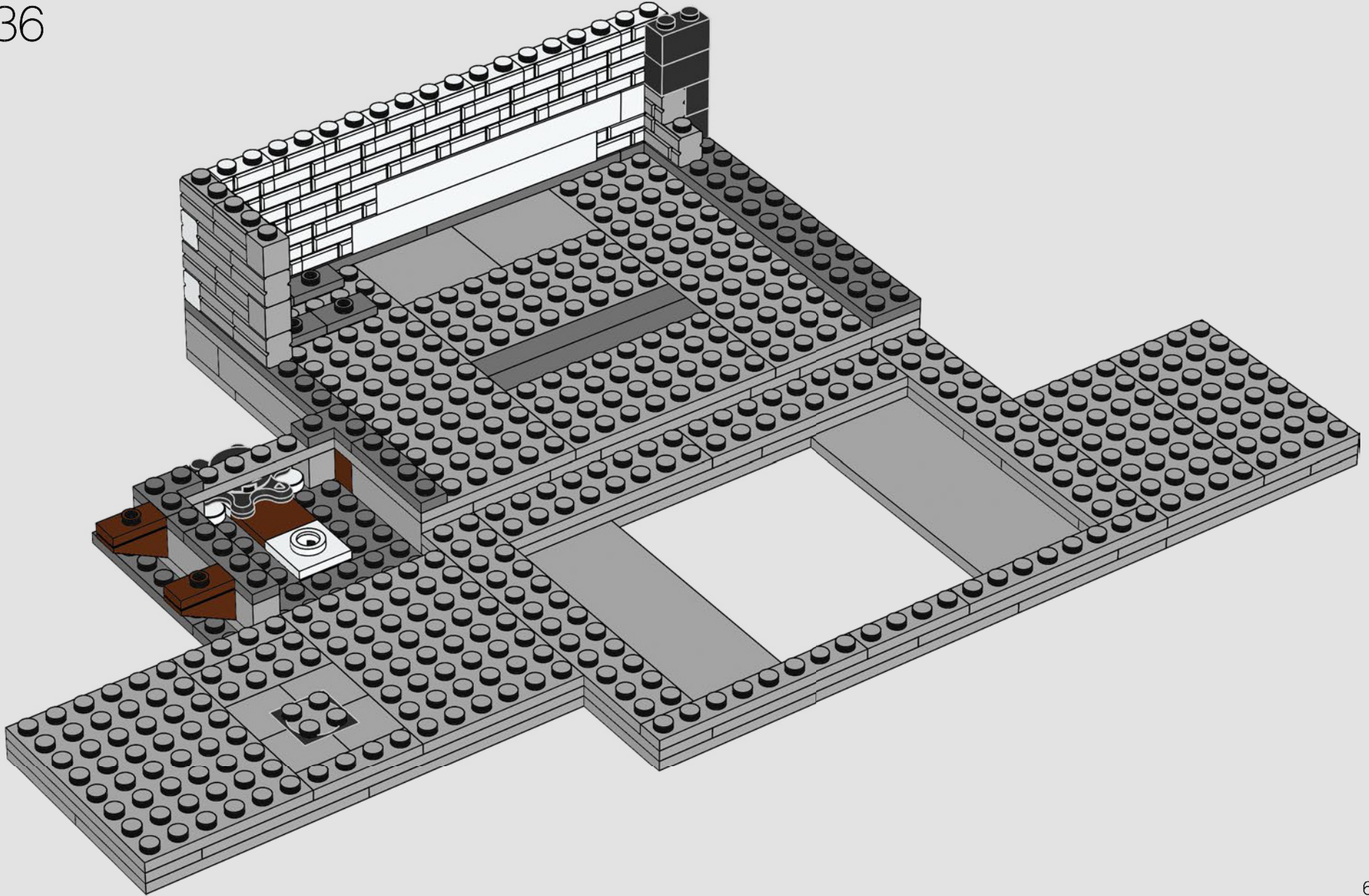

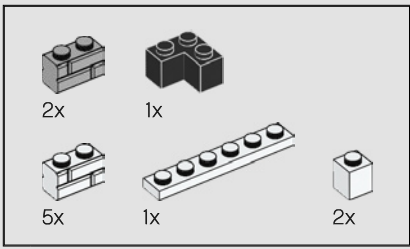

37

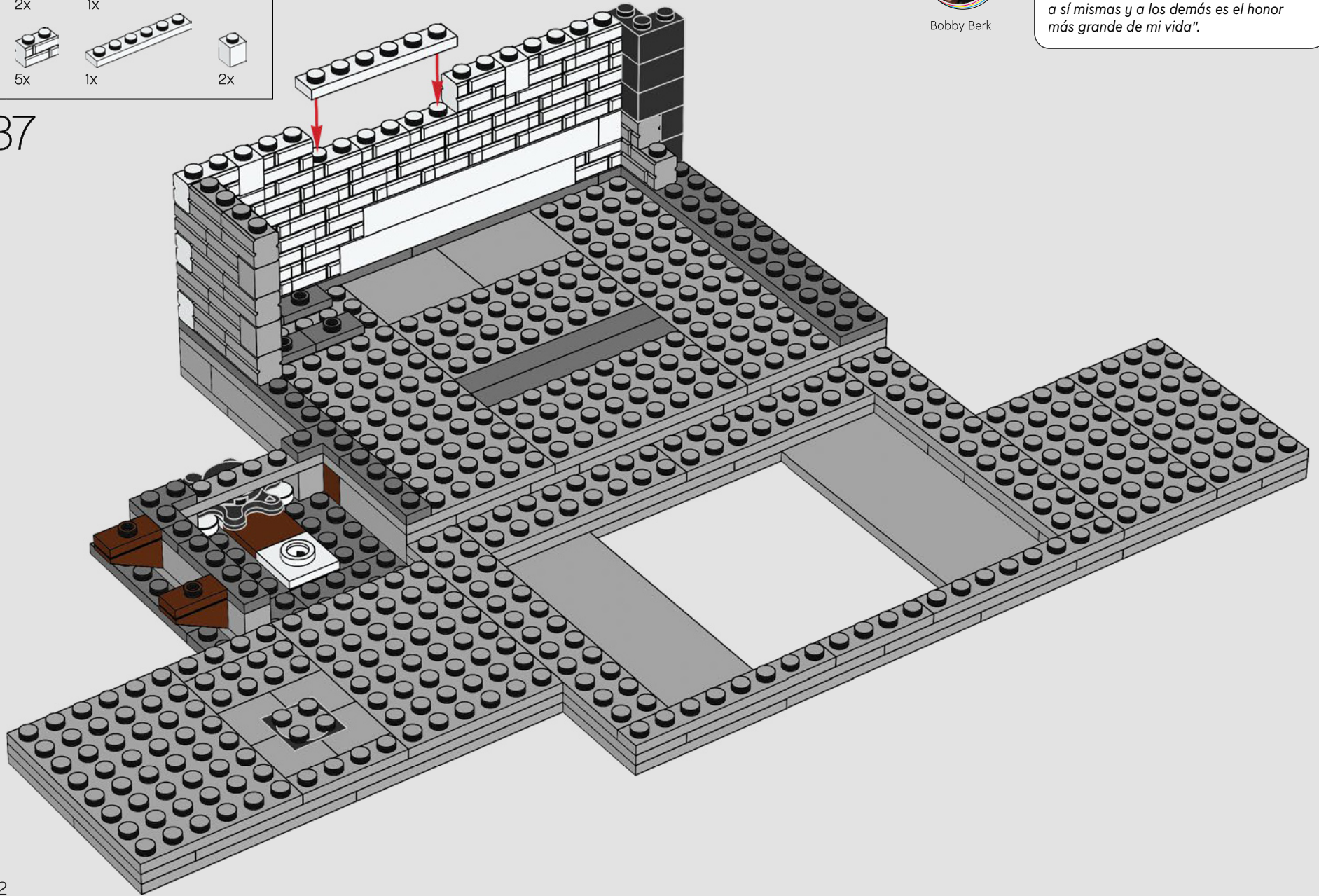

Bobby Berk

*"Haber sido capaz de crear un programa que además de ser un éxito haya podido ayudar a millones de personas a amarse a sí mismas y a los demás es el honor más grande de mi vida".*

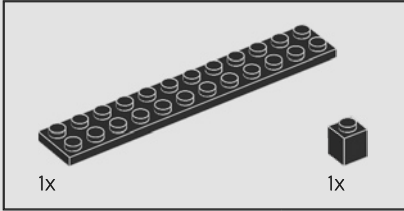
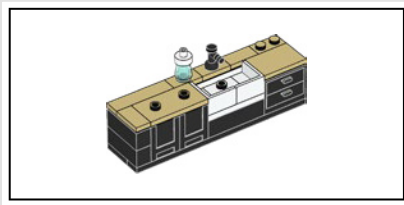

38

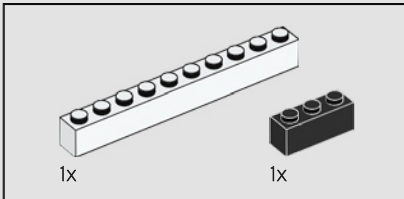
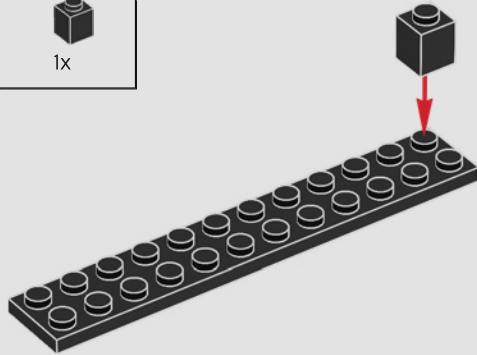

39

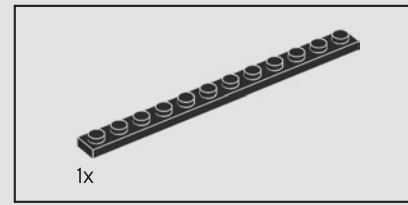
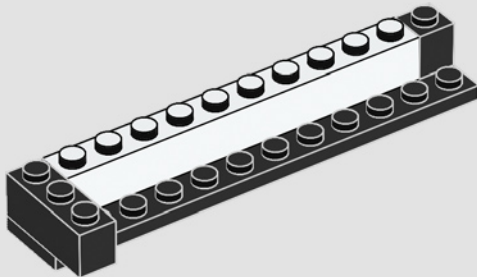

40

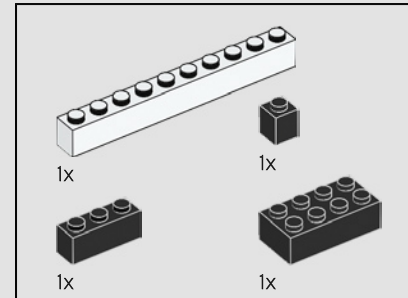
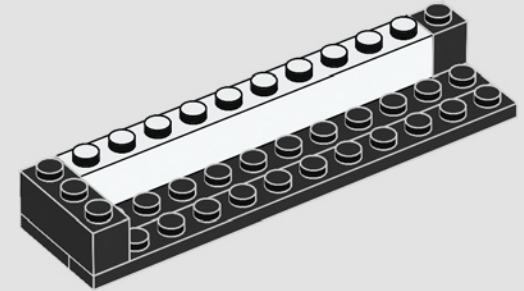

41

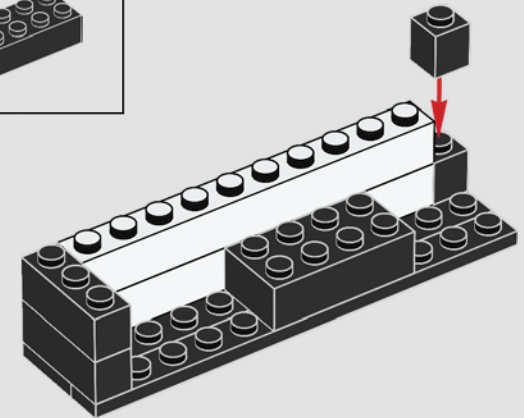



42

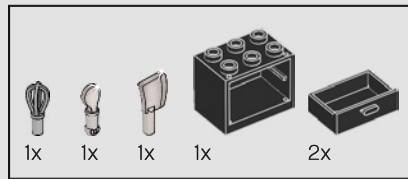
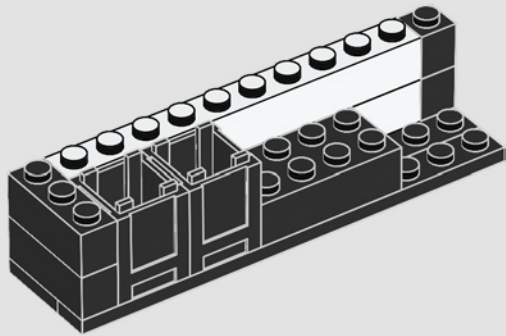

43

1

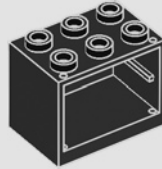

2

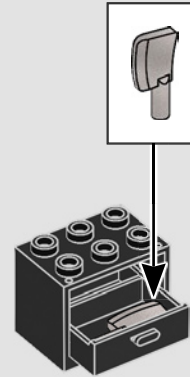

3

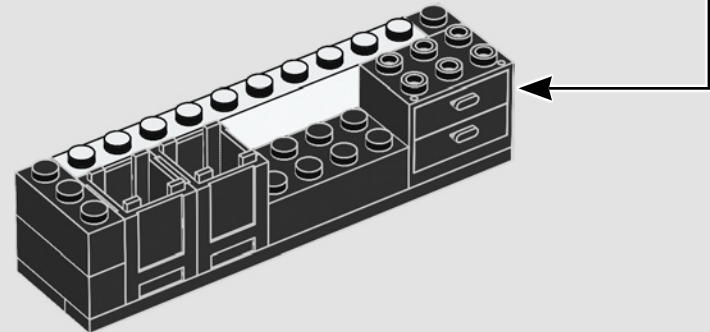
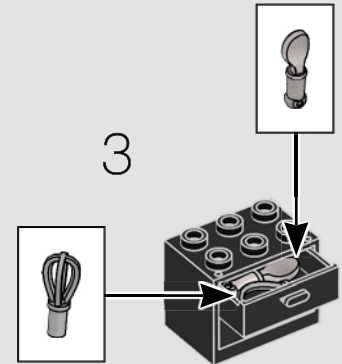



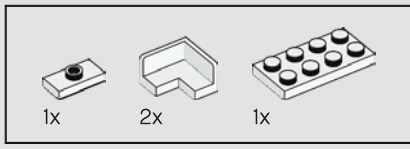

44

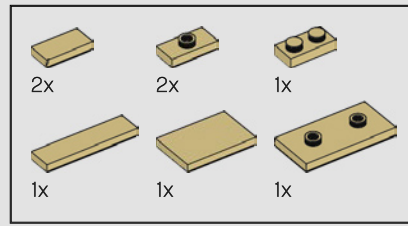
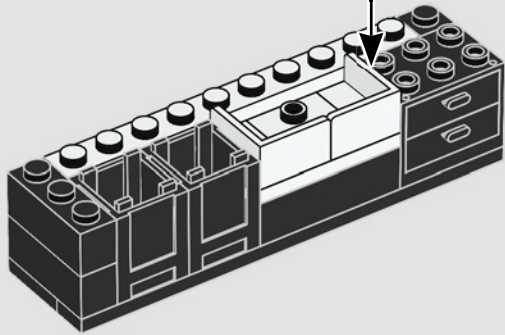
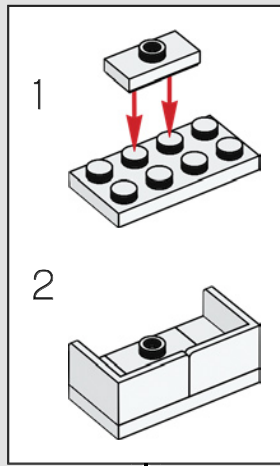

45

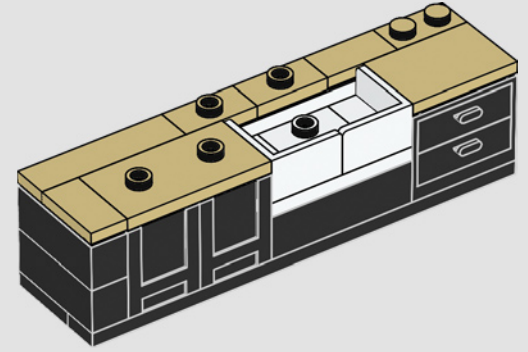

46

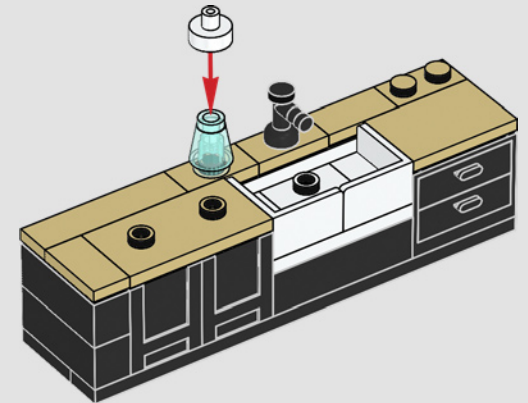

47

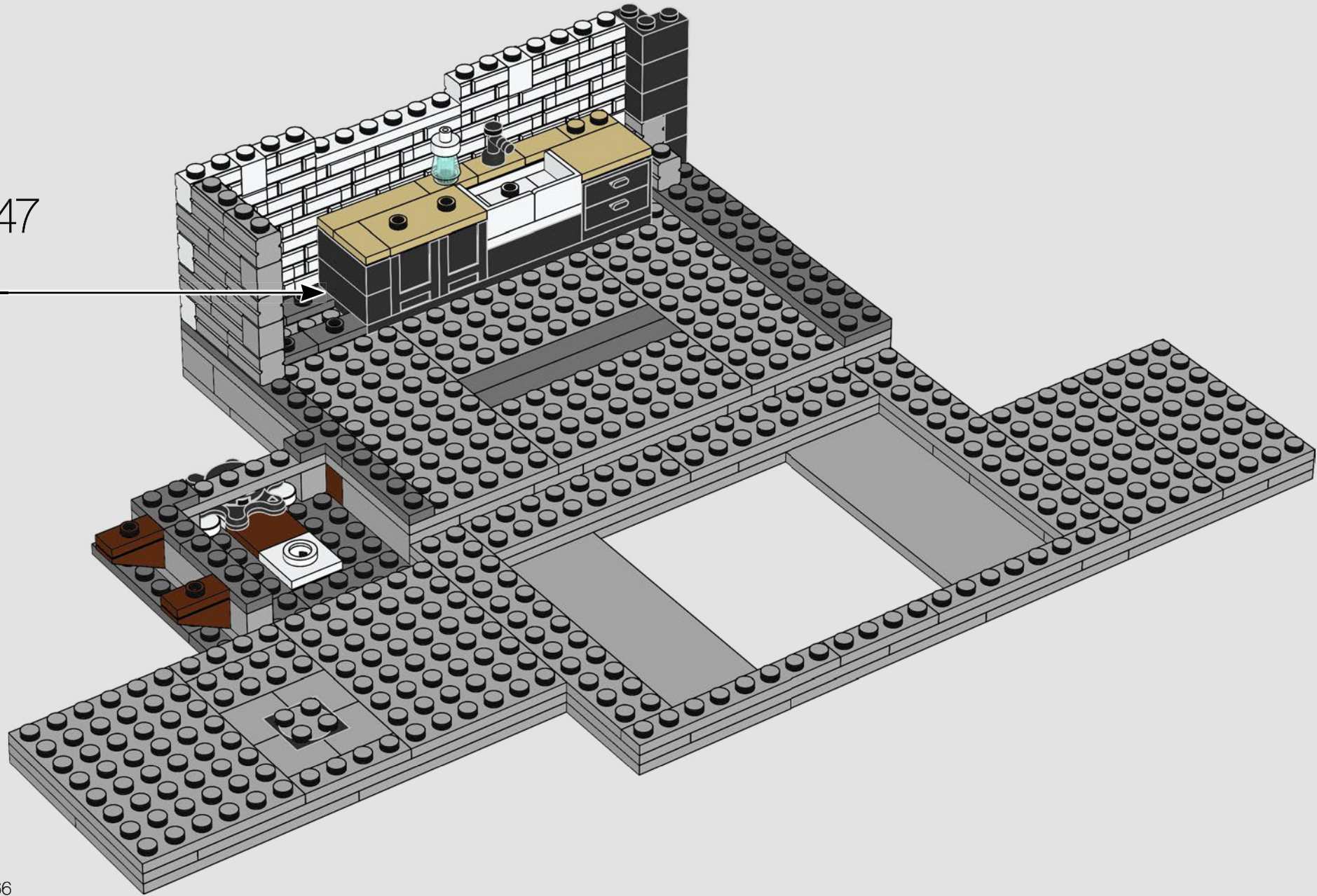

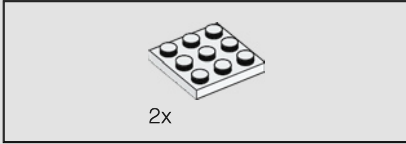
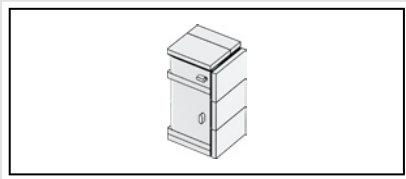

48

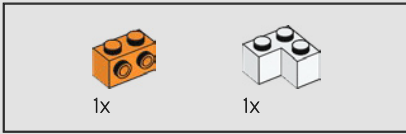
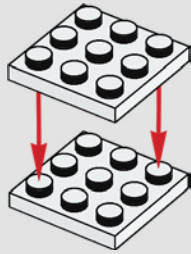

49

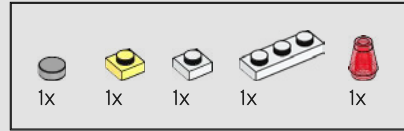
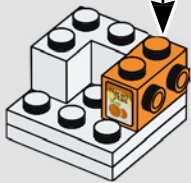
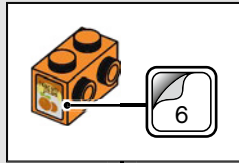

50

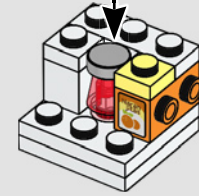
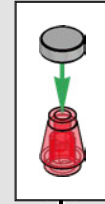

51

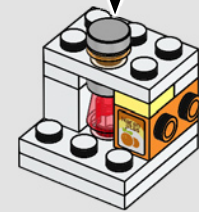
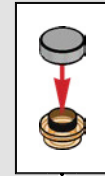

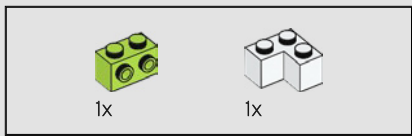

52

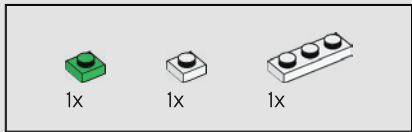
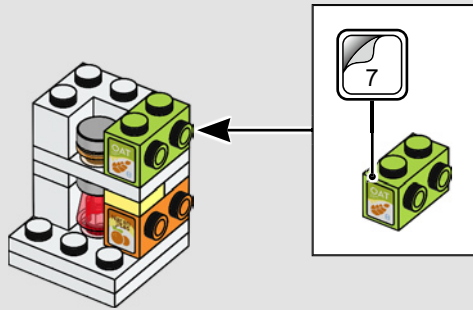

53

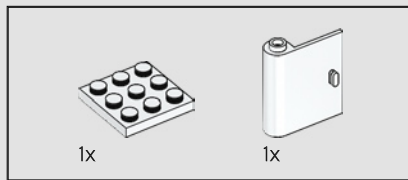

54

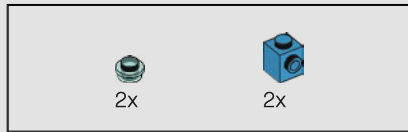
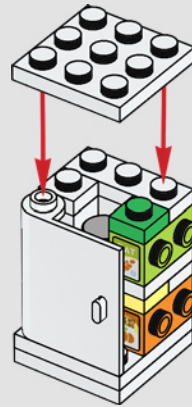

55

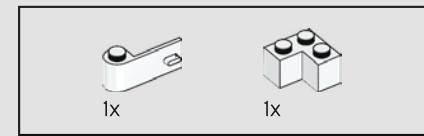
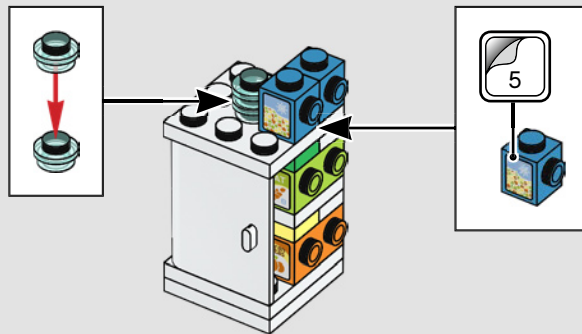

56

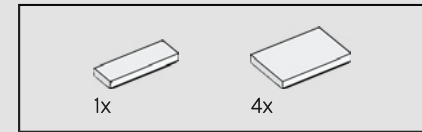

57

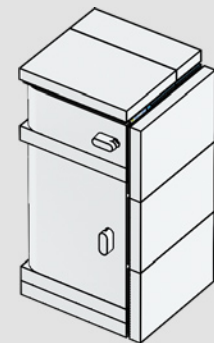

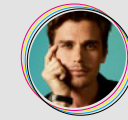

Antoni Porowski

"Construir con LEGO® es, en muchos sentidos, como cocinar una receta. Puedes seguir los pasos al pie de la letra y obtener un resultado perfecto que ha pasado todas las pruebas, o puedes elegir experimentar y crear algo de tu cosecha".



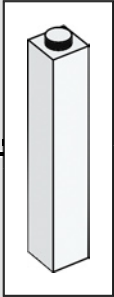
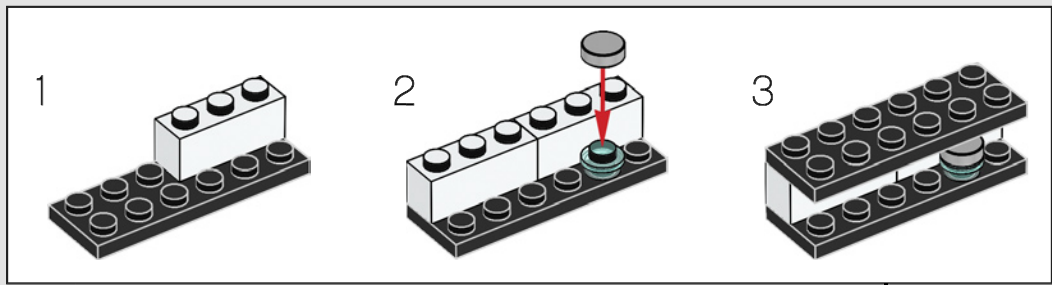
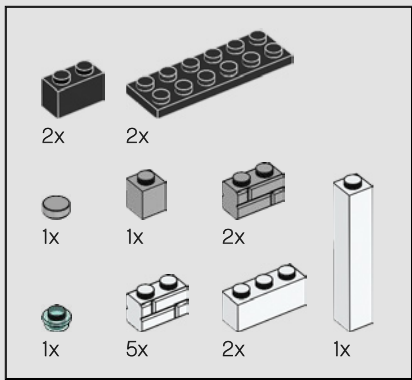

59

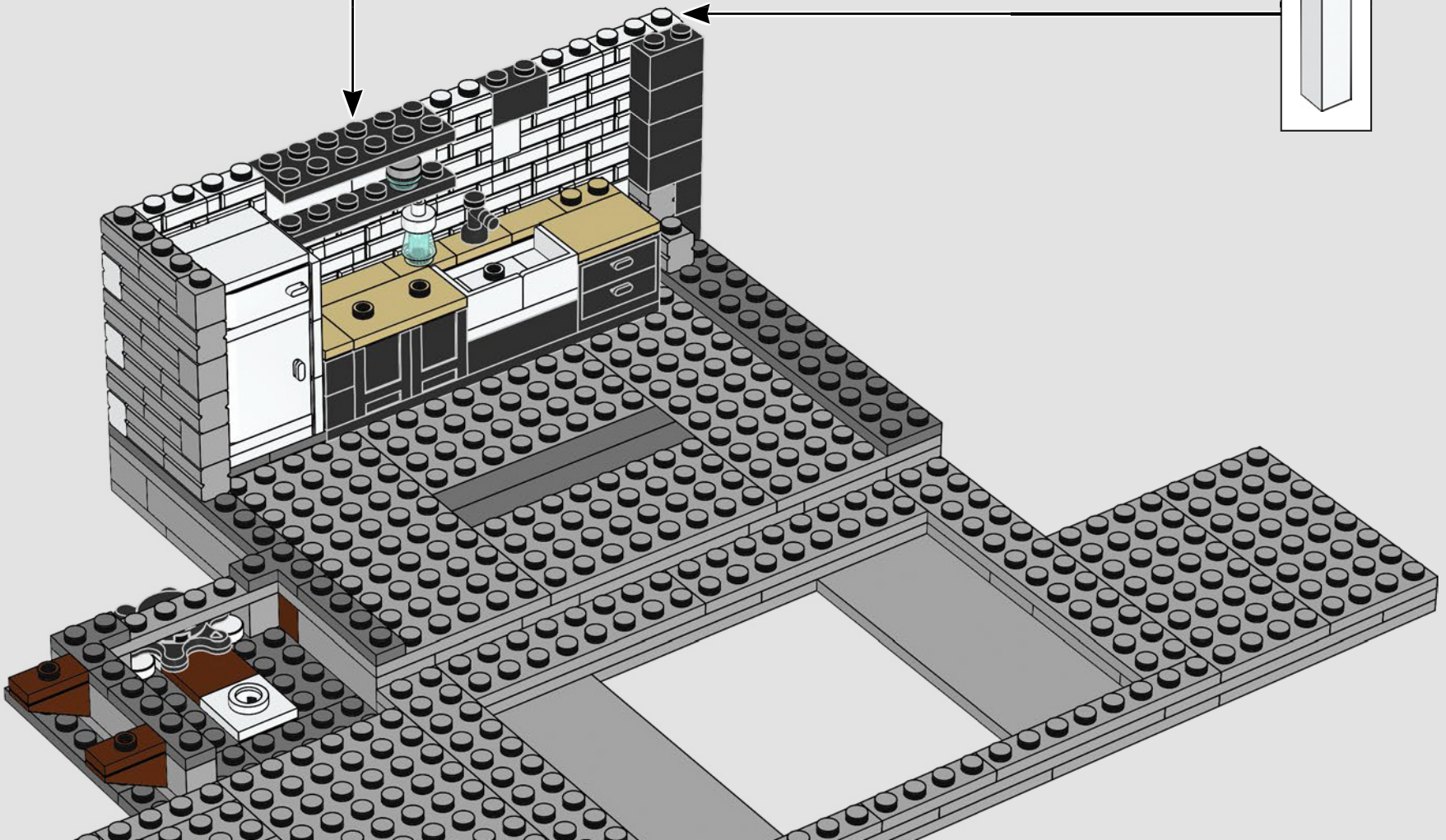

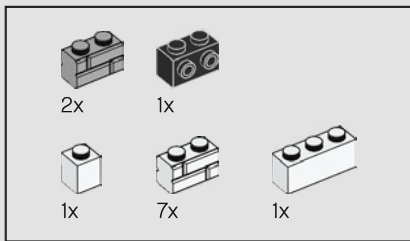

60

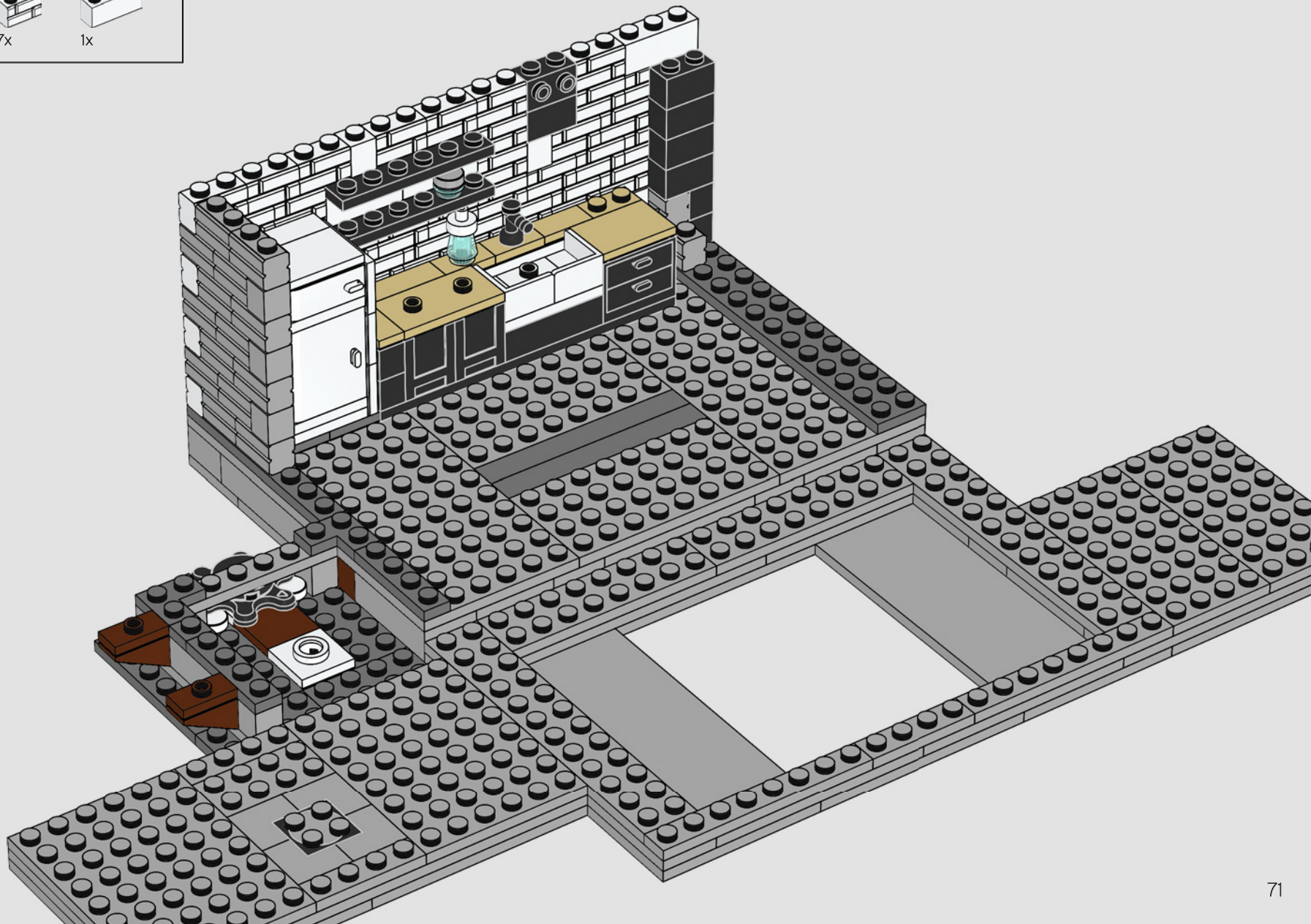

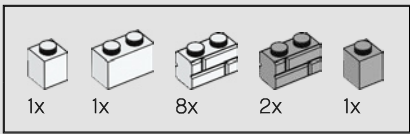

61



Bobby Berk

"En Queer Eye se trata de empezar de nuevo, de reconstruir y de sacar el mejor partido a lo que tienes. ¿Con qué otro juguete podrían celebrarse tales cosas mejor que con LEGO?"





62

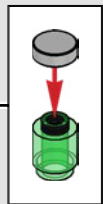
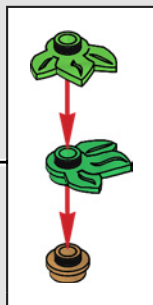
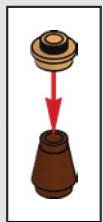
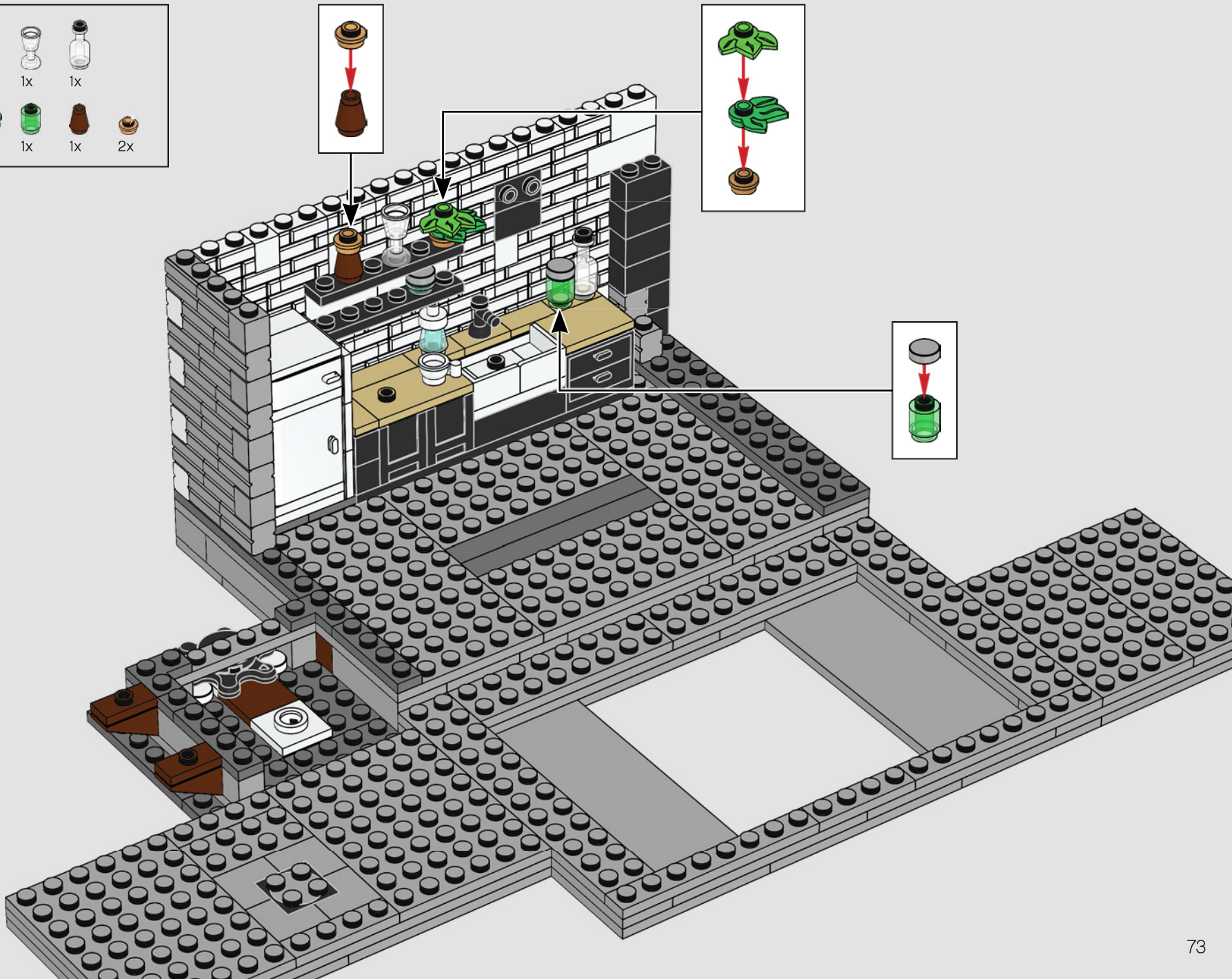

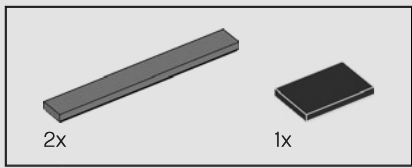

63

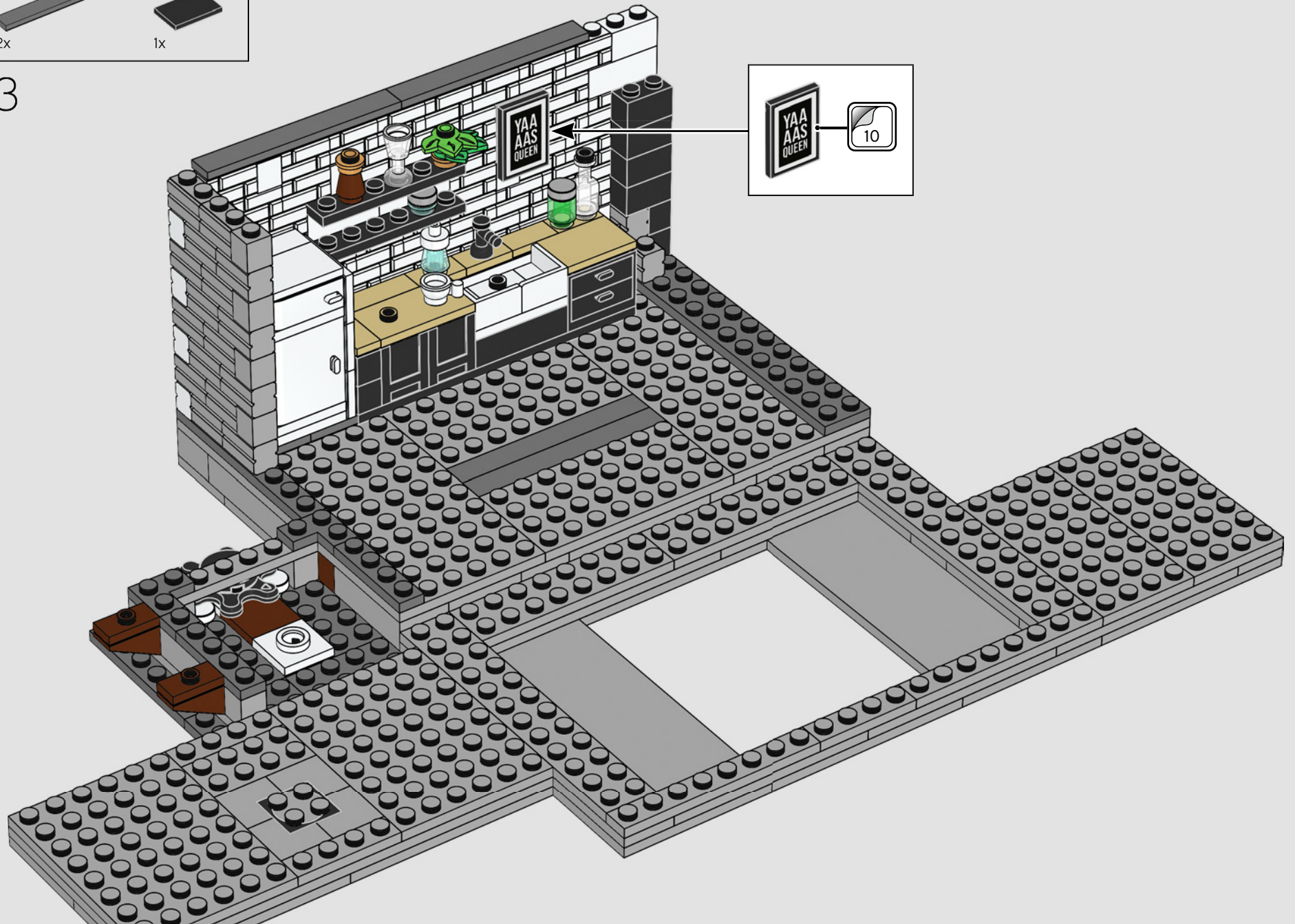

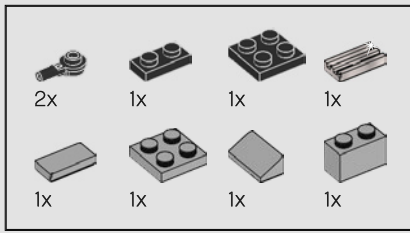

64

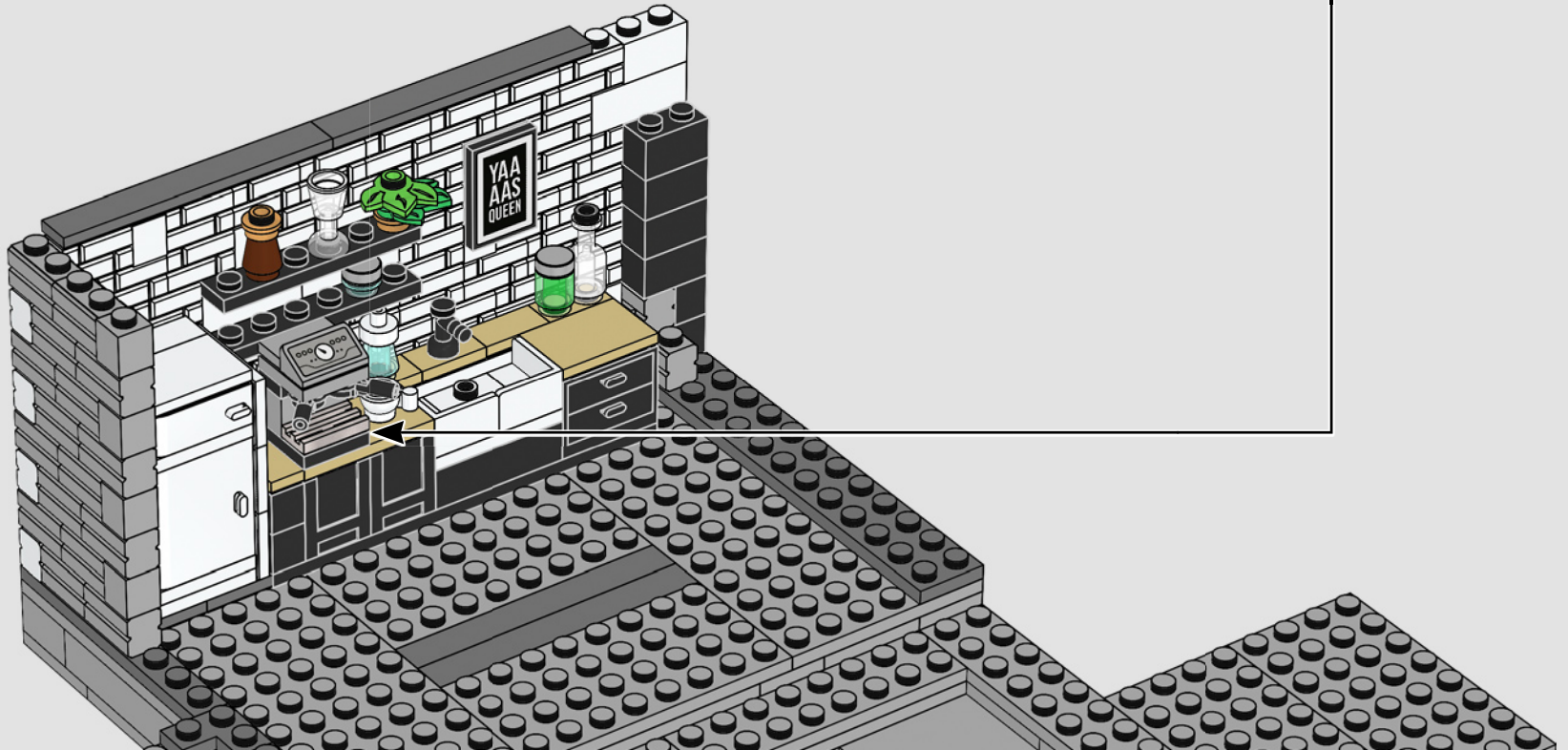
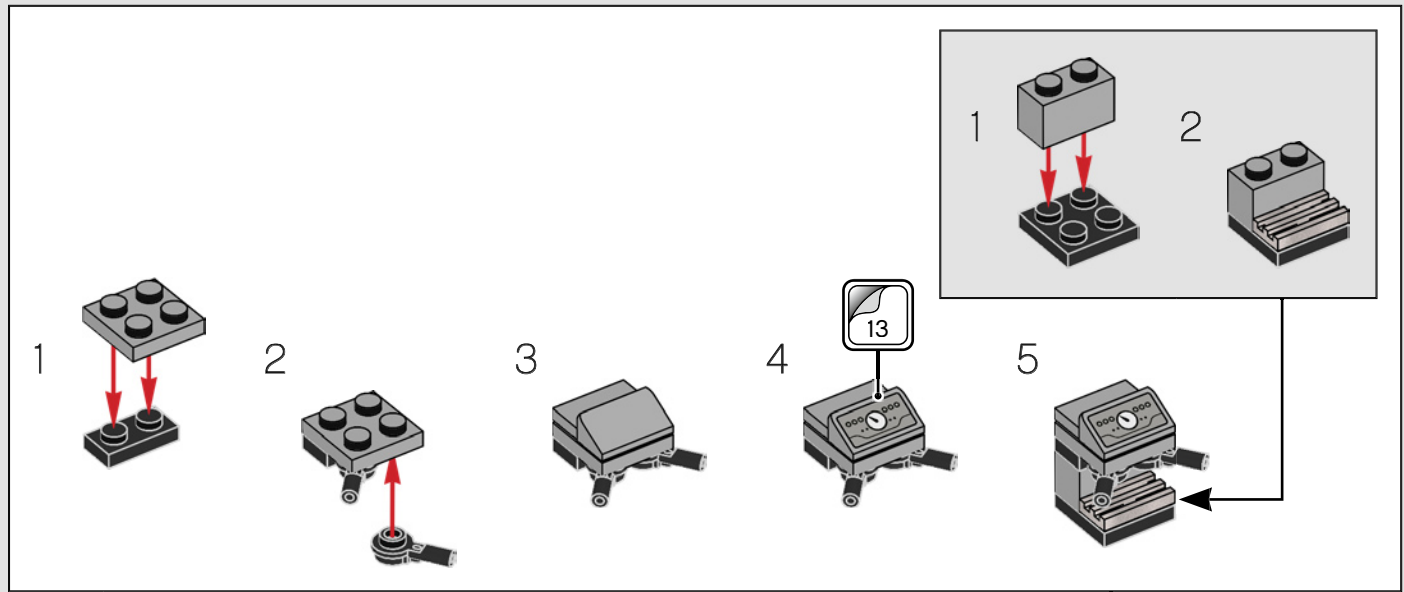

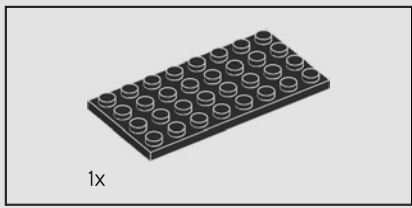

65

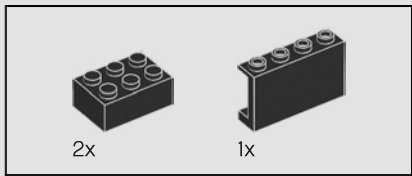
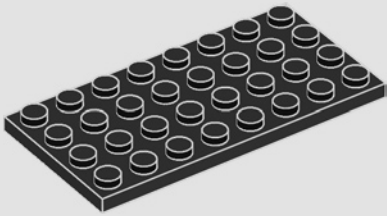

66

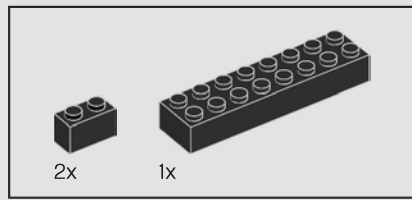
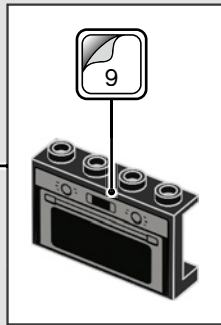
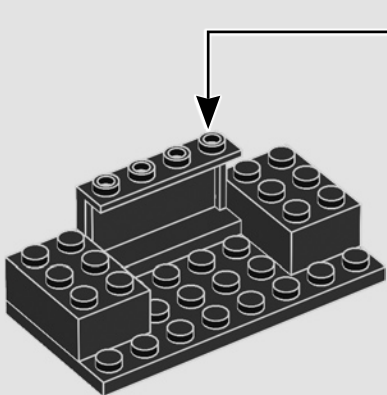

67

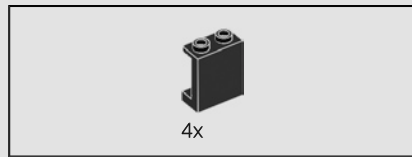
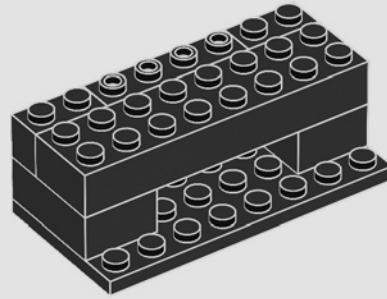

68

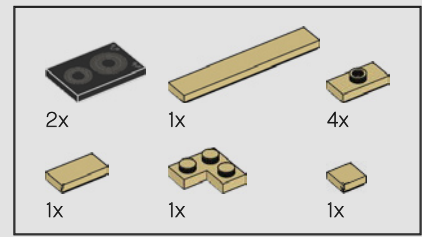
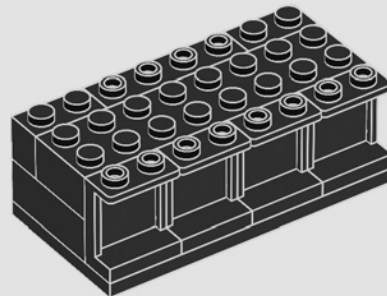

69

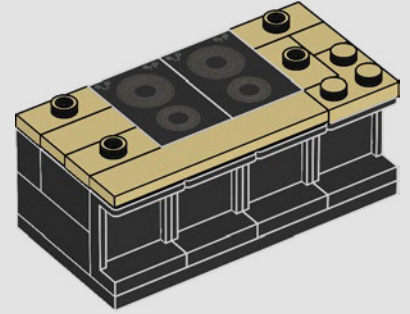

70

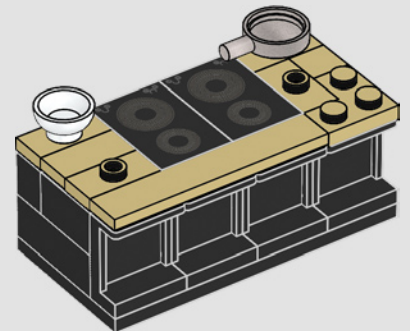

71

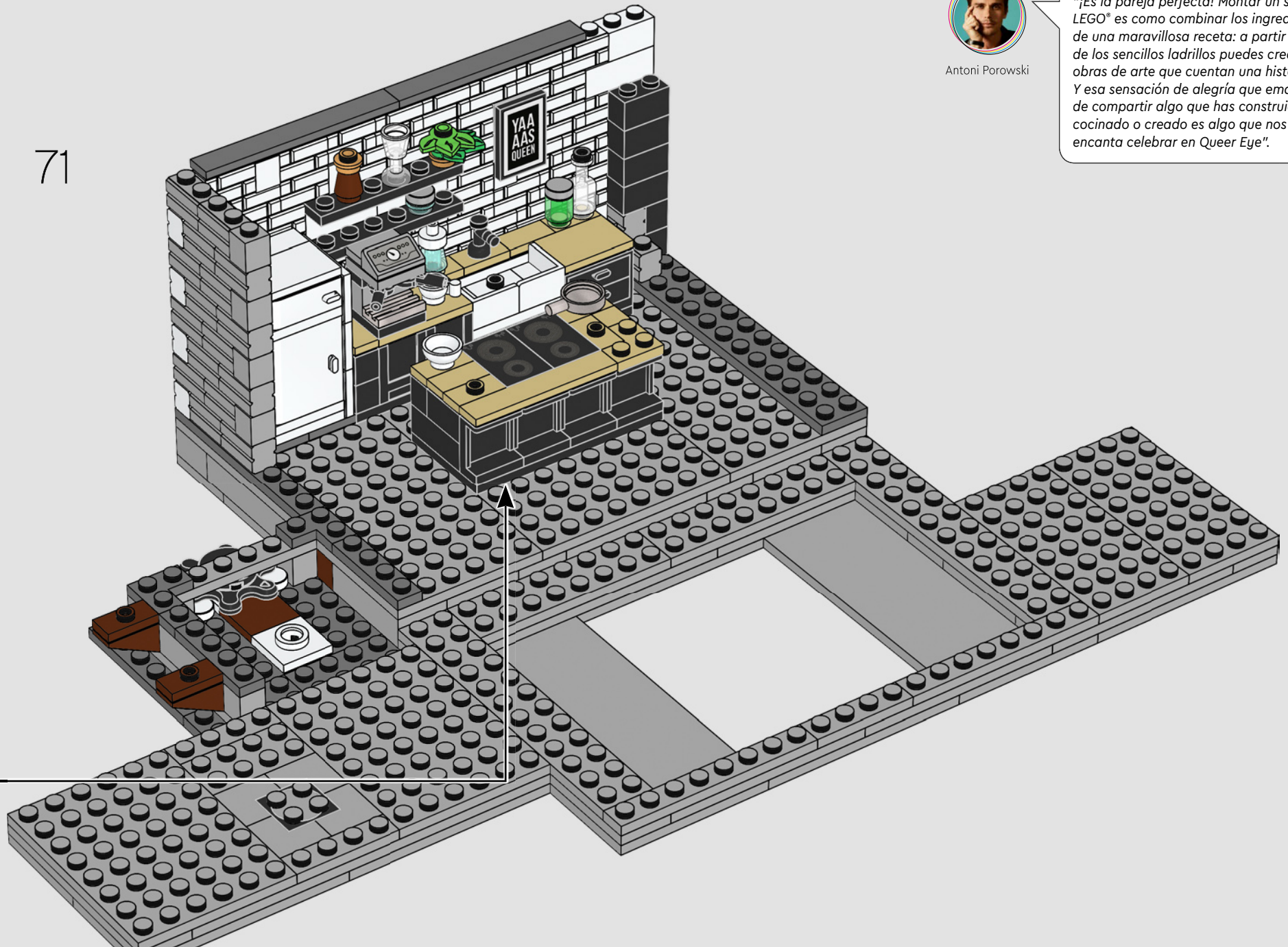

Antoni Porowski

*"¡Es la pareja perfecta! Montar un set LEGO es como combinar los ingredientes de una maravillosa receta: a partir de los sencillos ladrillos puedes crear obras de arte que cuentan una historia. Y esa sensación de alegría que emana de compartir algo que has construido, cocinado o creado es algo que nos encanta celebrar en Queer Eye".*

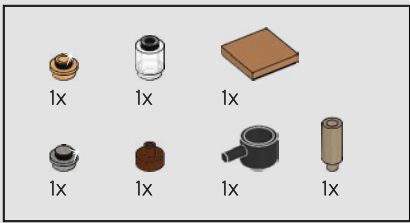

72

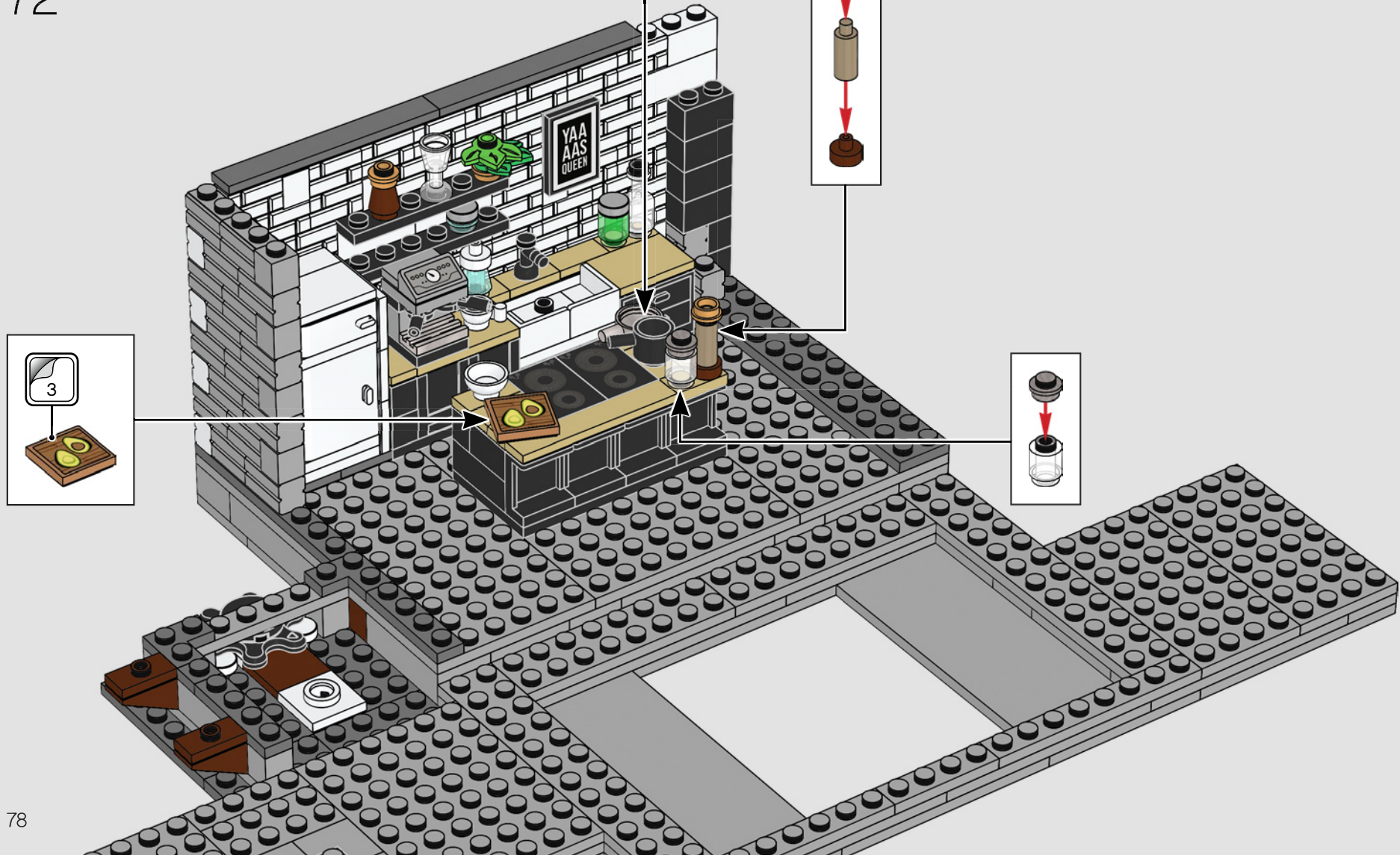
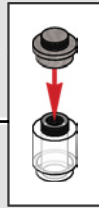
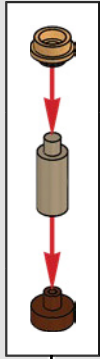
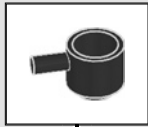
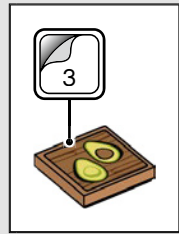

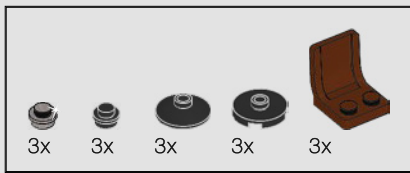

73

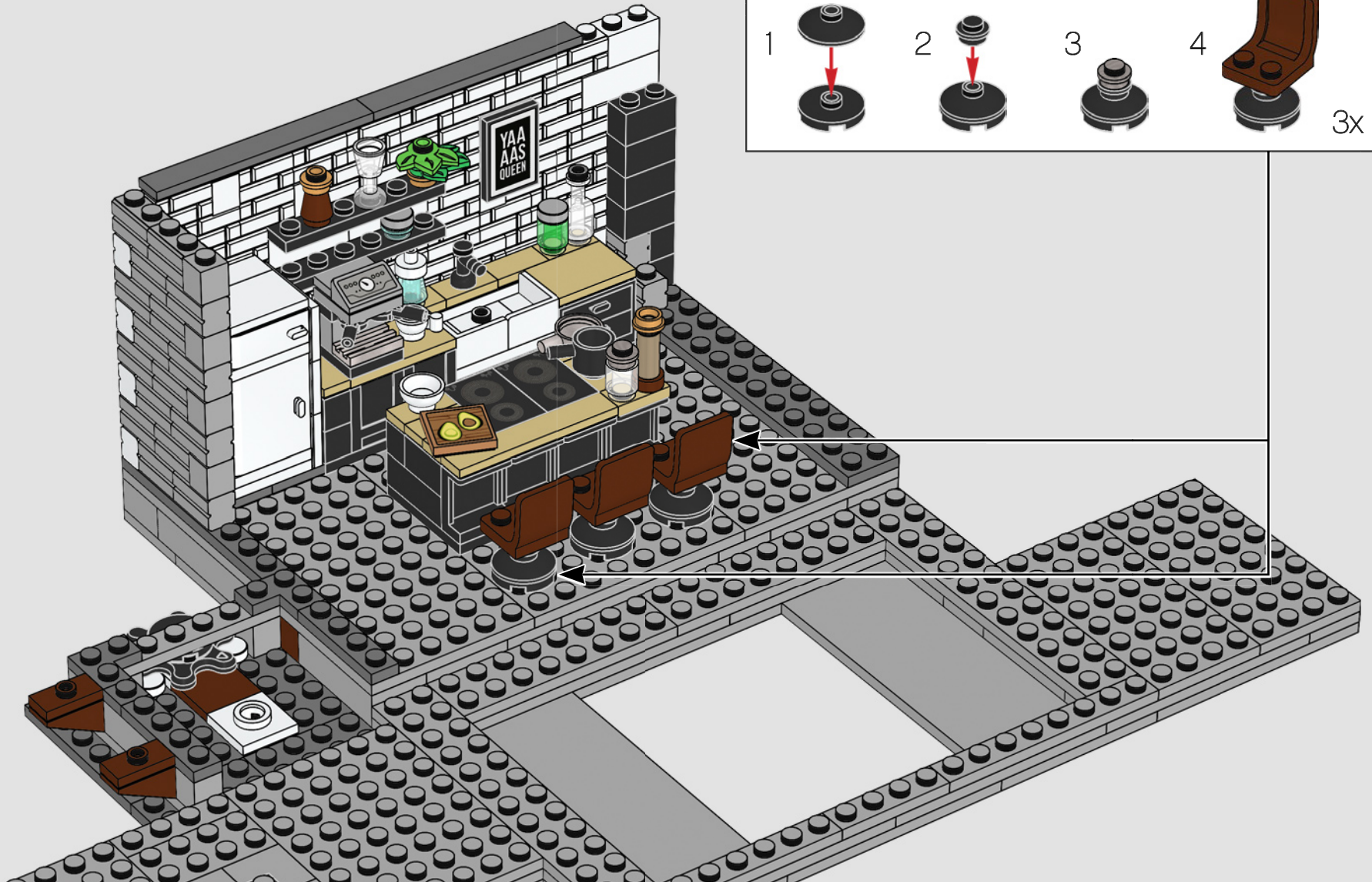
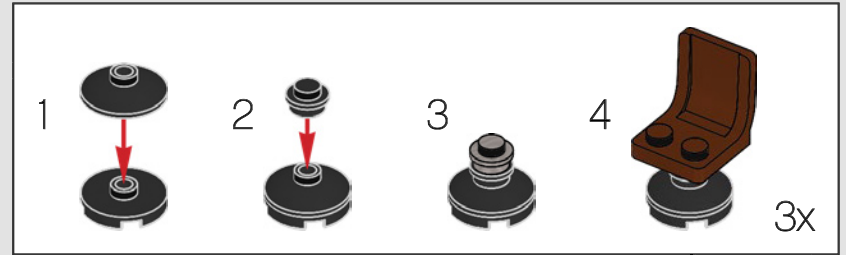

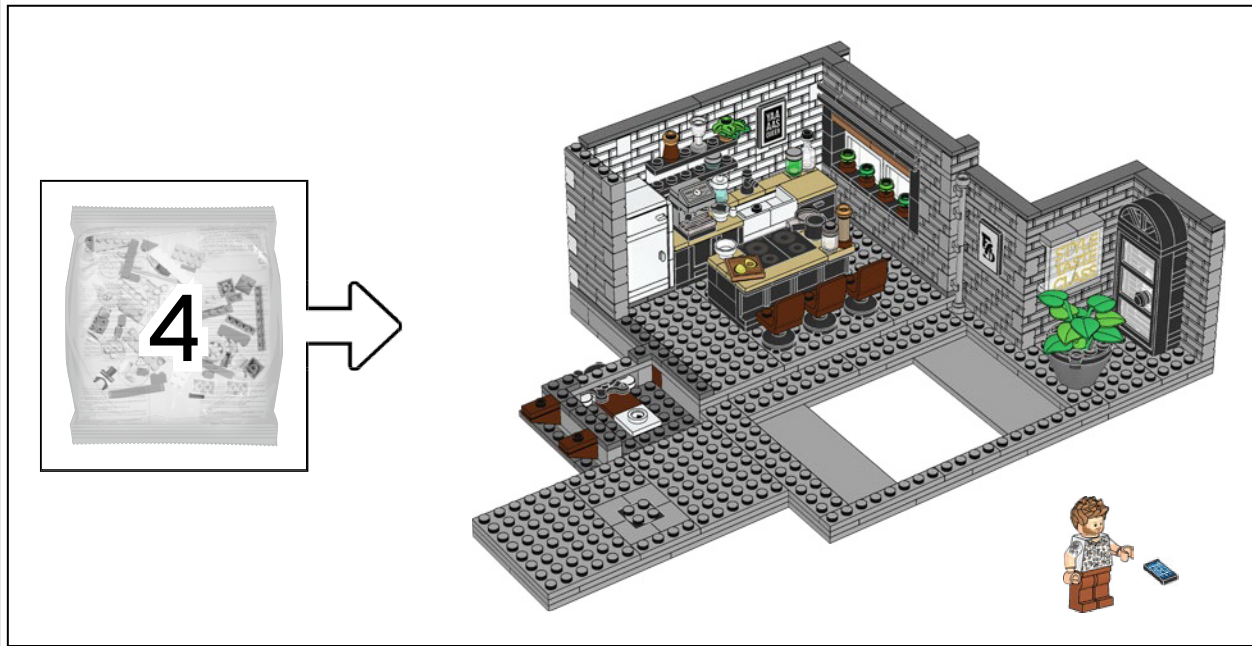

Bobby Berk

*"Verme en forma de minifigura LEGO® es una experiencia surrealista: ¡el yo de 7 años no hubiera podido contener la emoción al saber que esto sucedería!"*





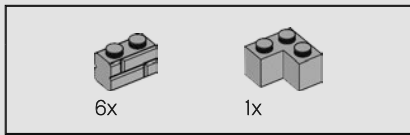

74



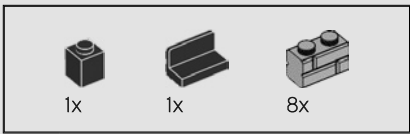

75

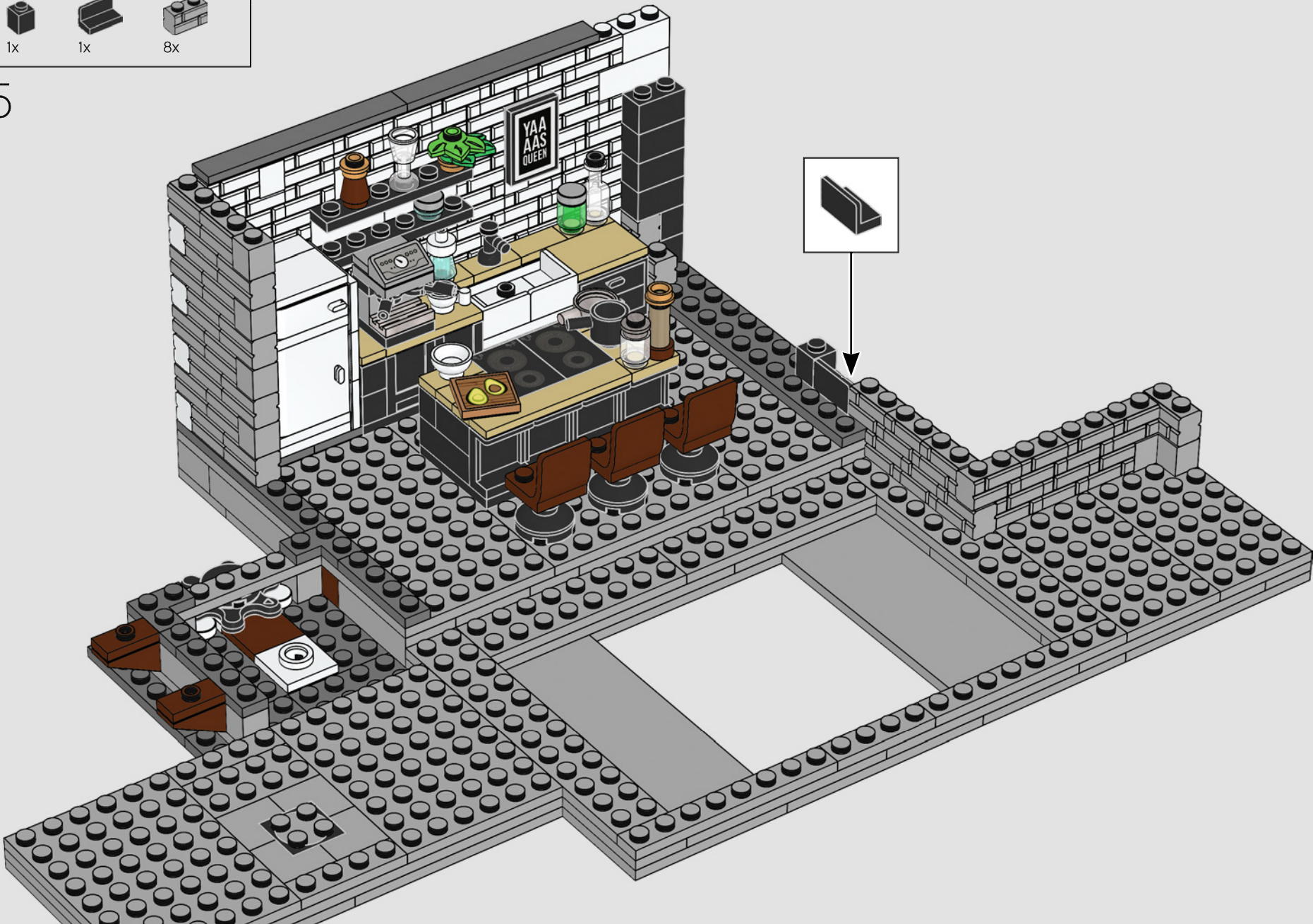

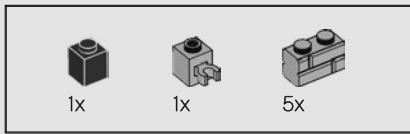

76

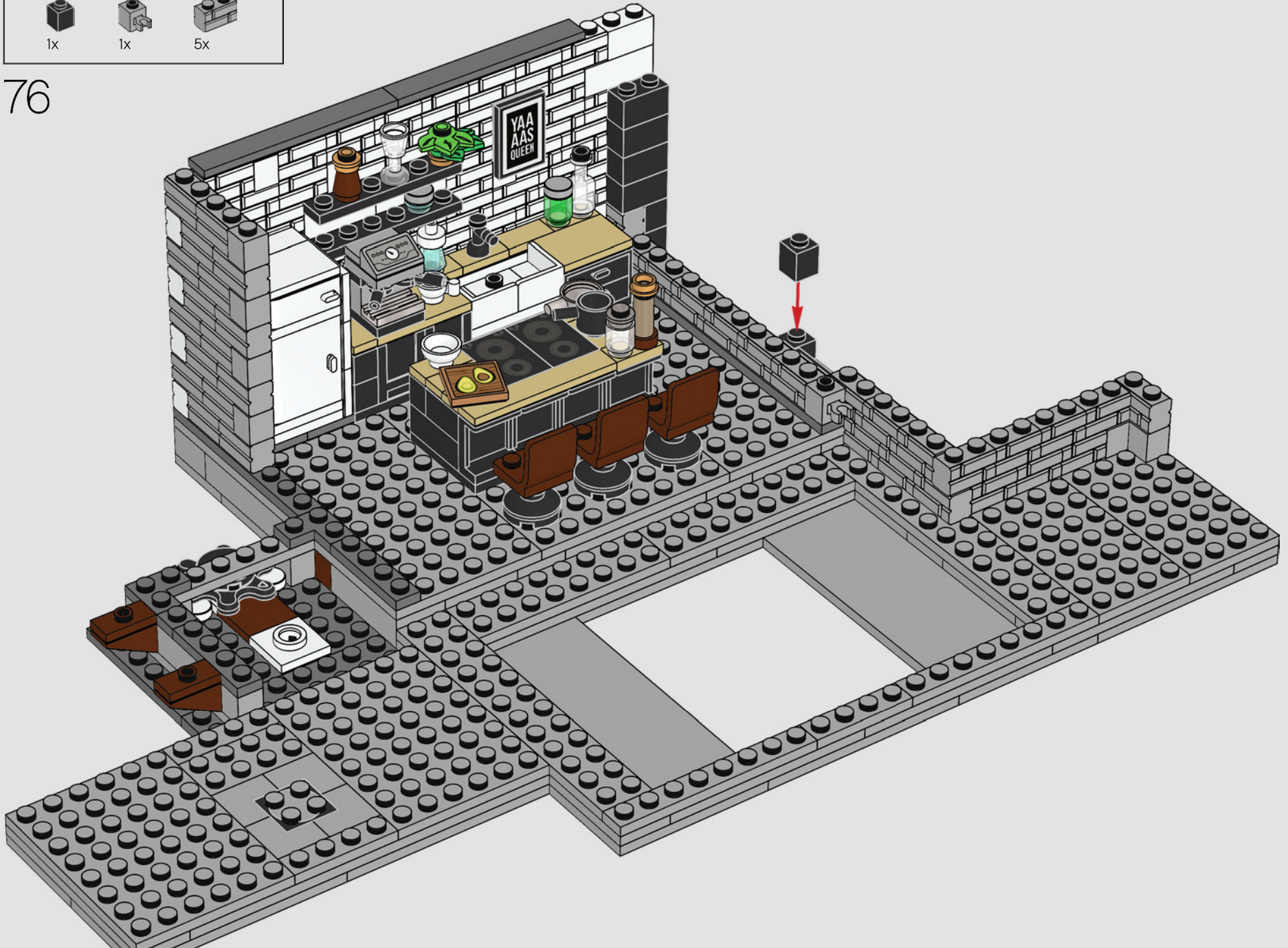

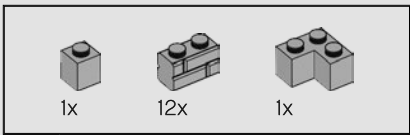

77

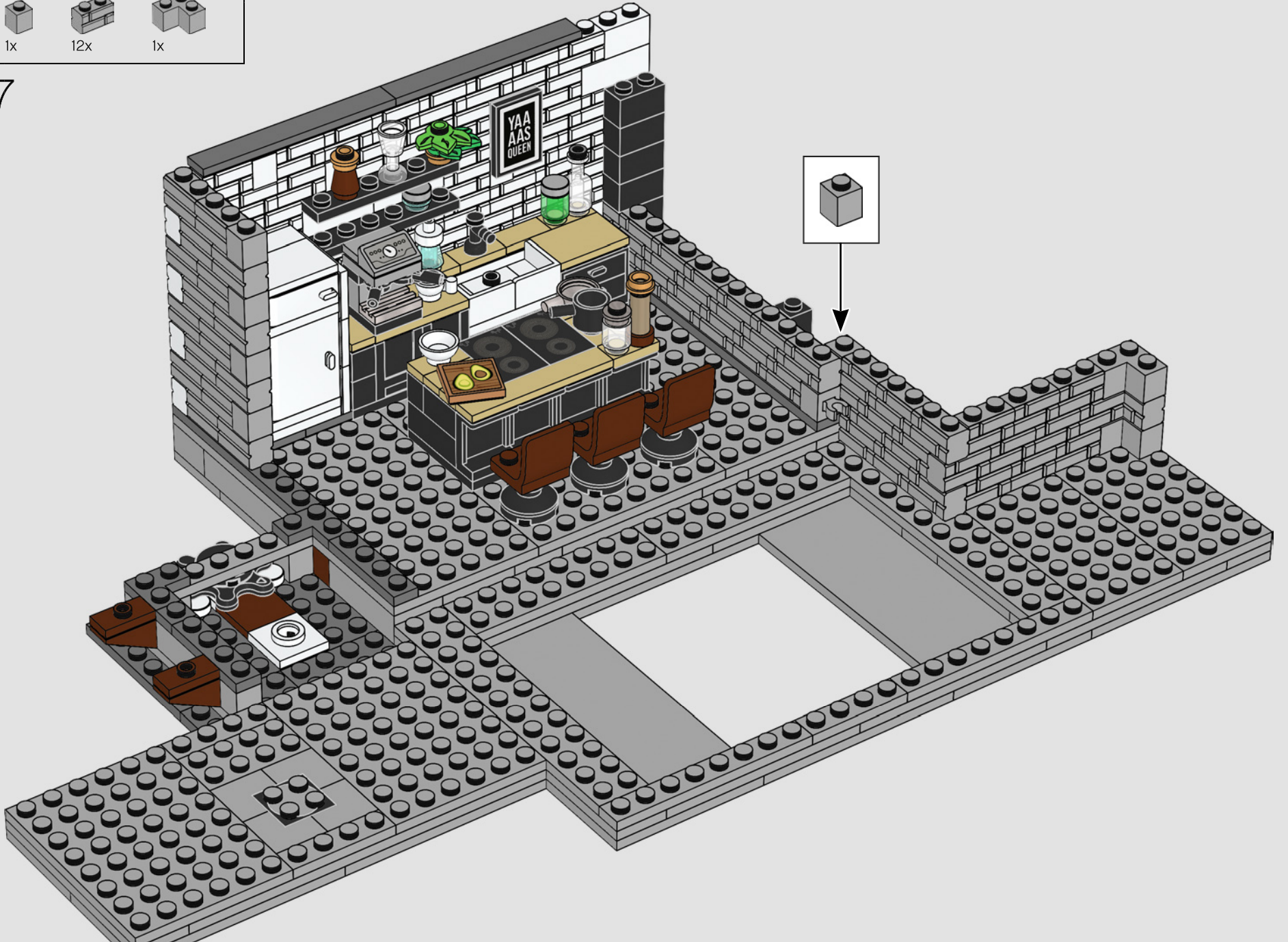



78

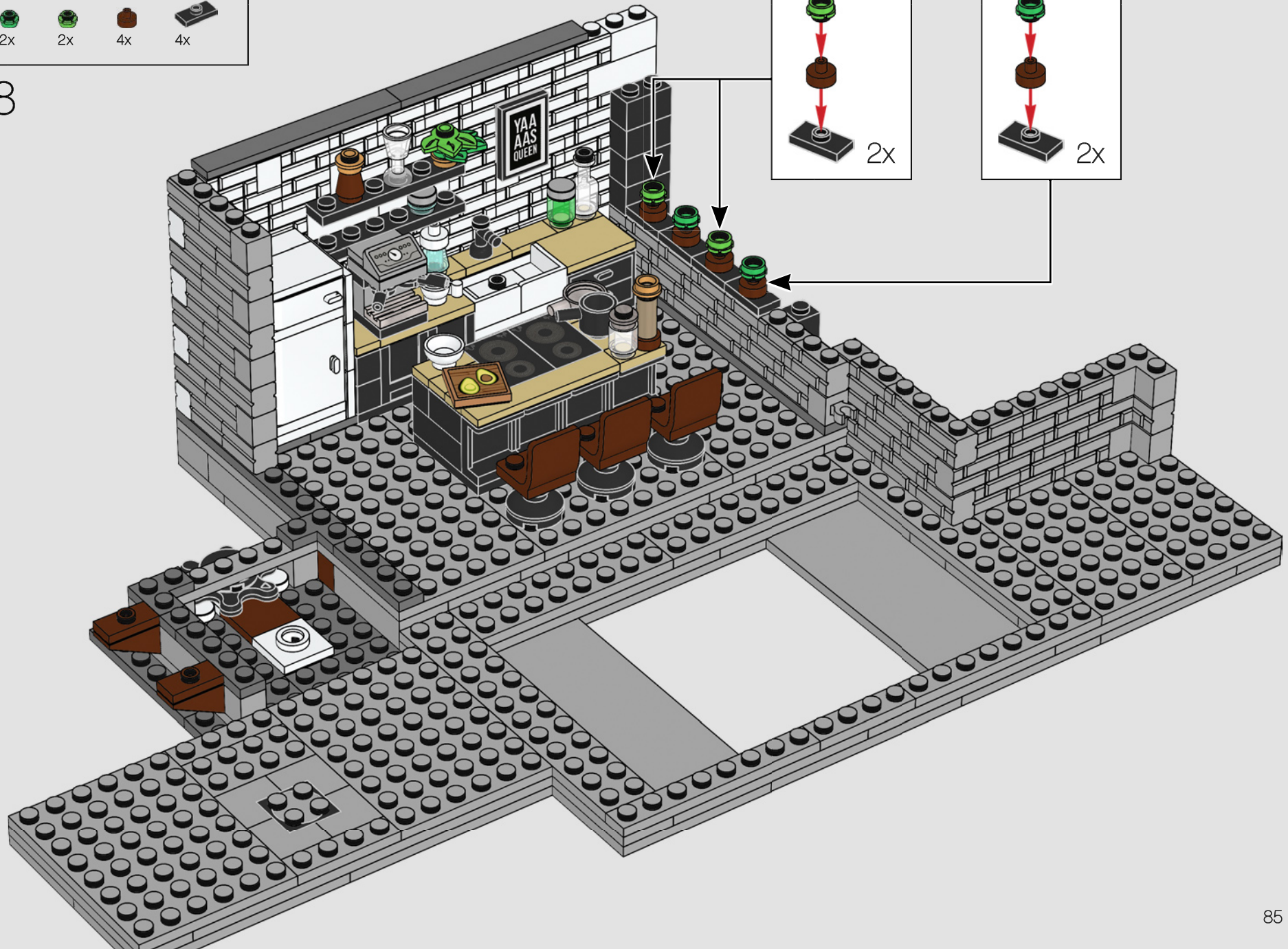
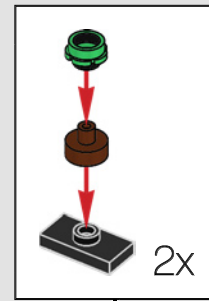
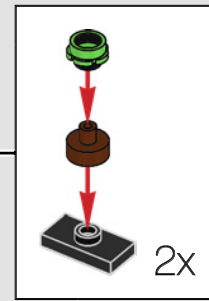

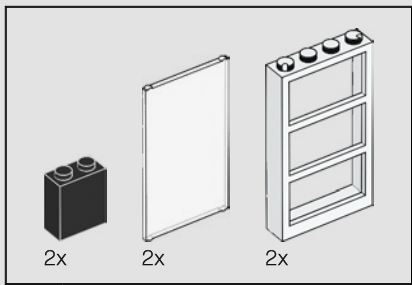

79

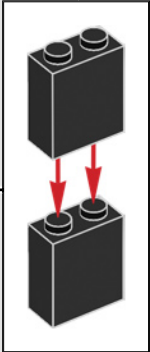
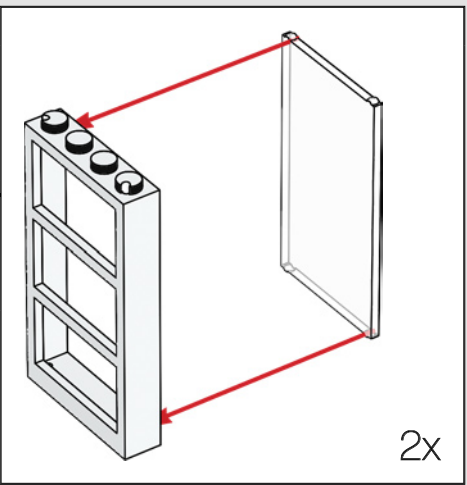
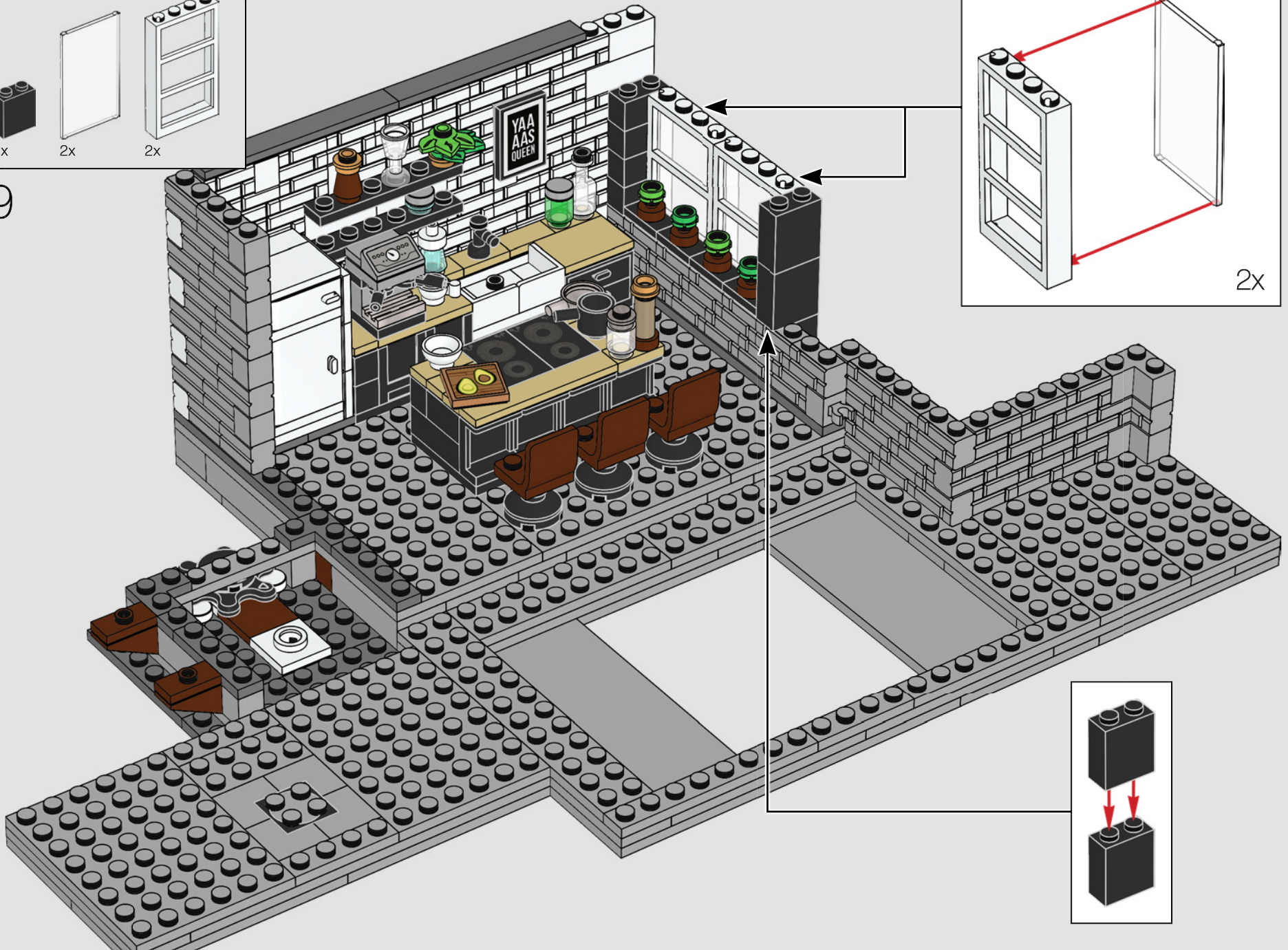

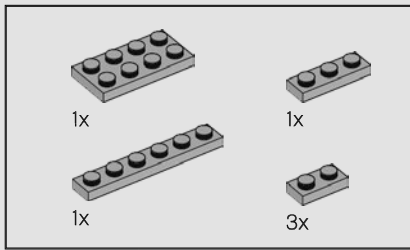

80

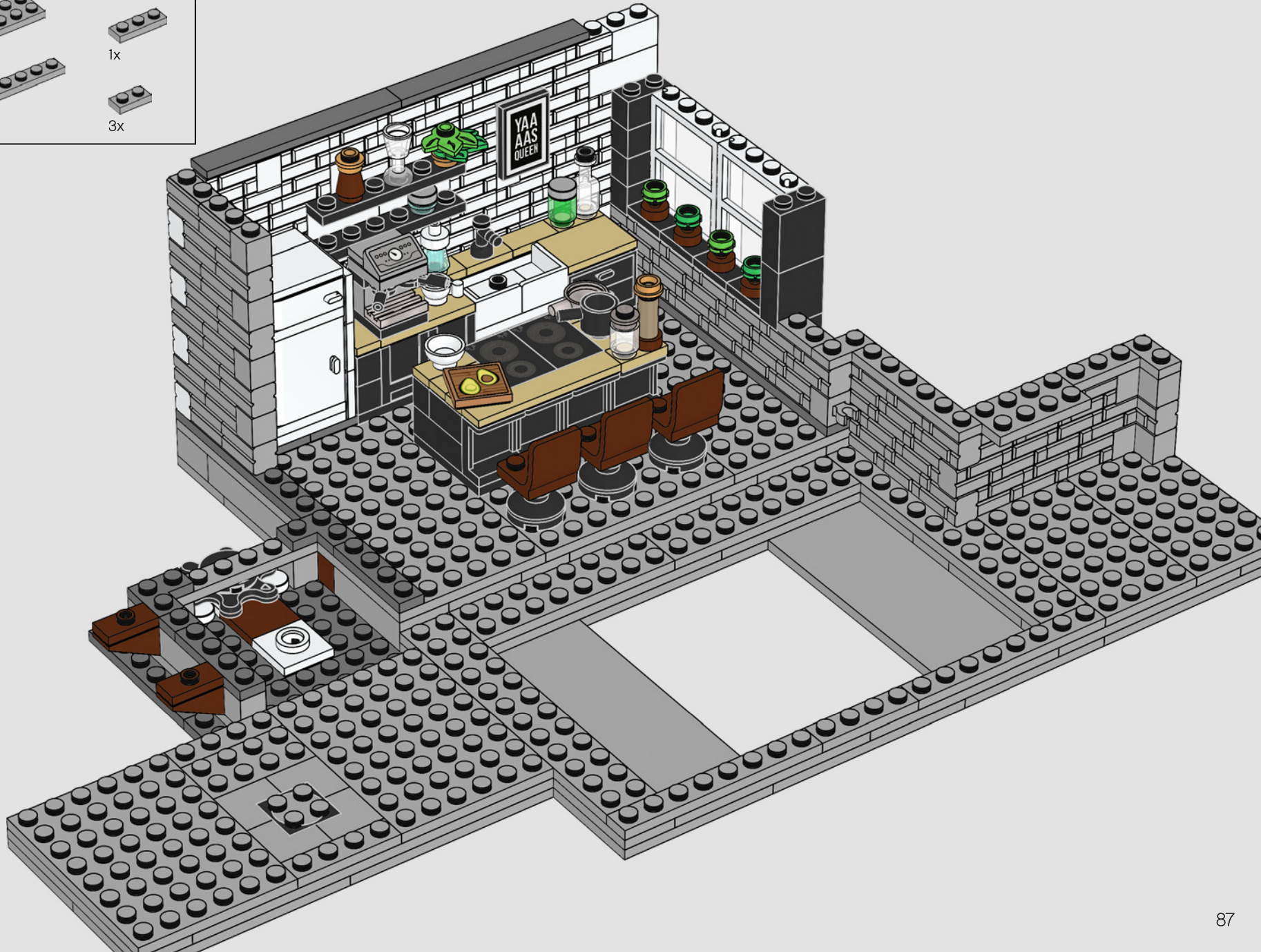

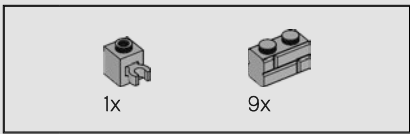

81



88



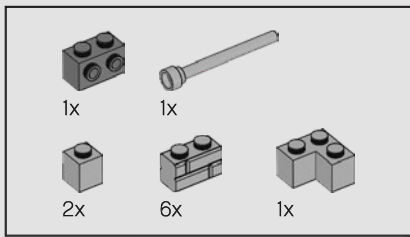

82

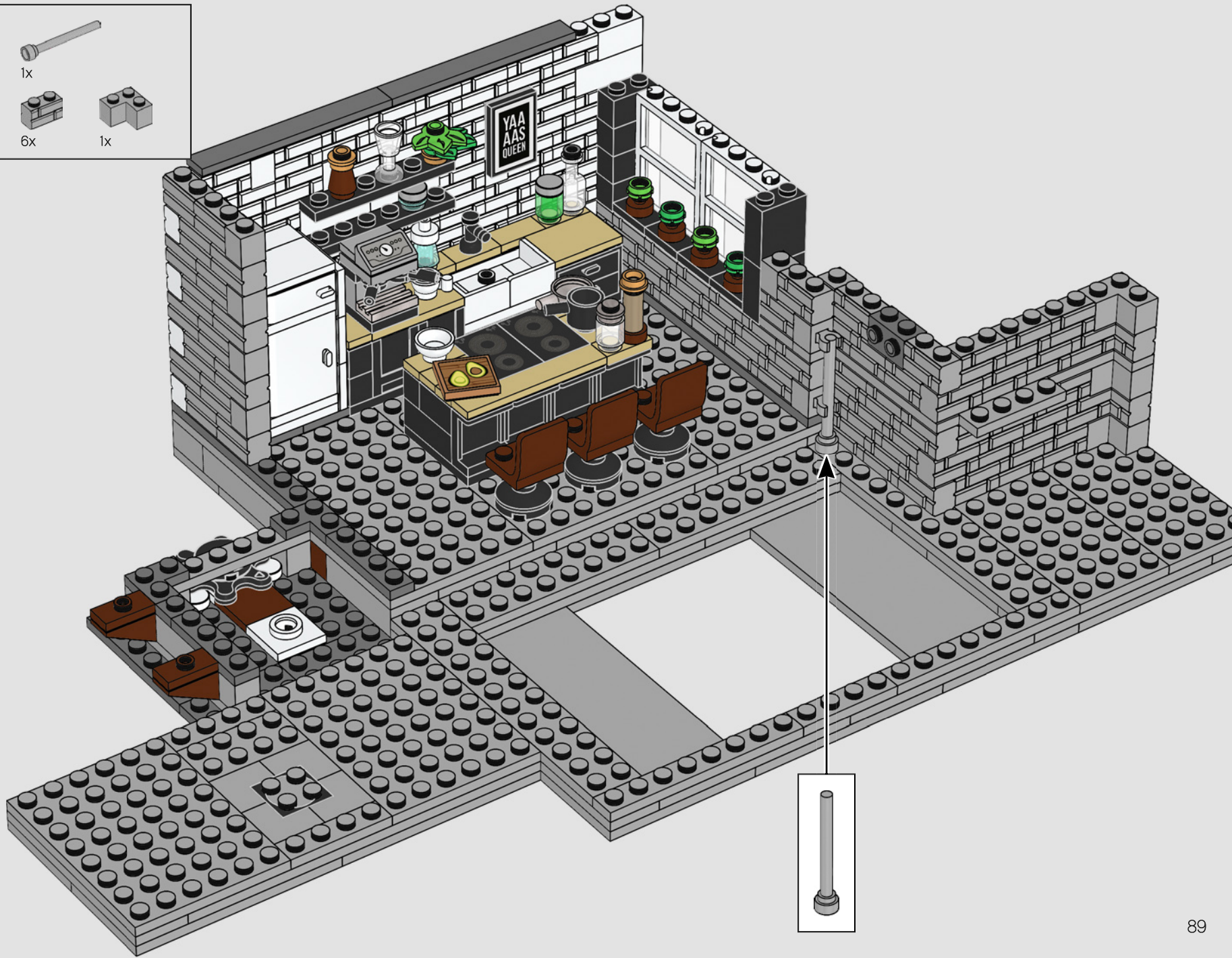

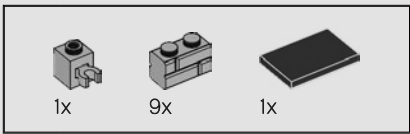

83

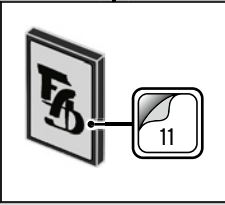
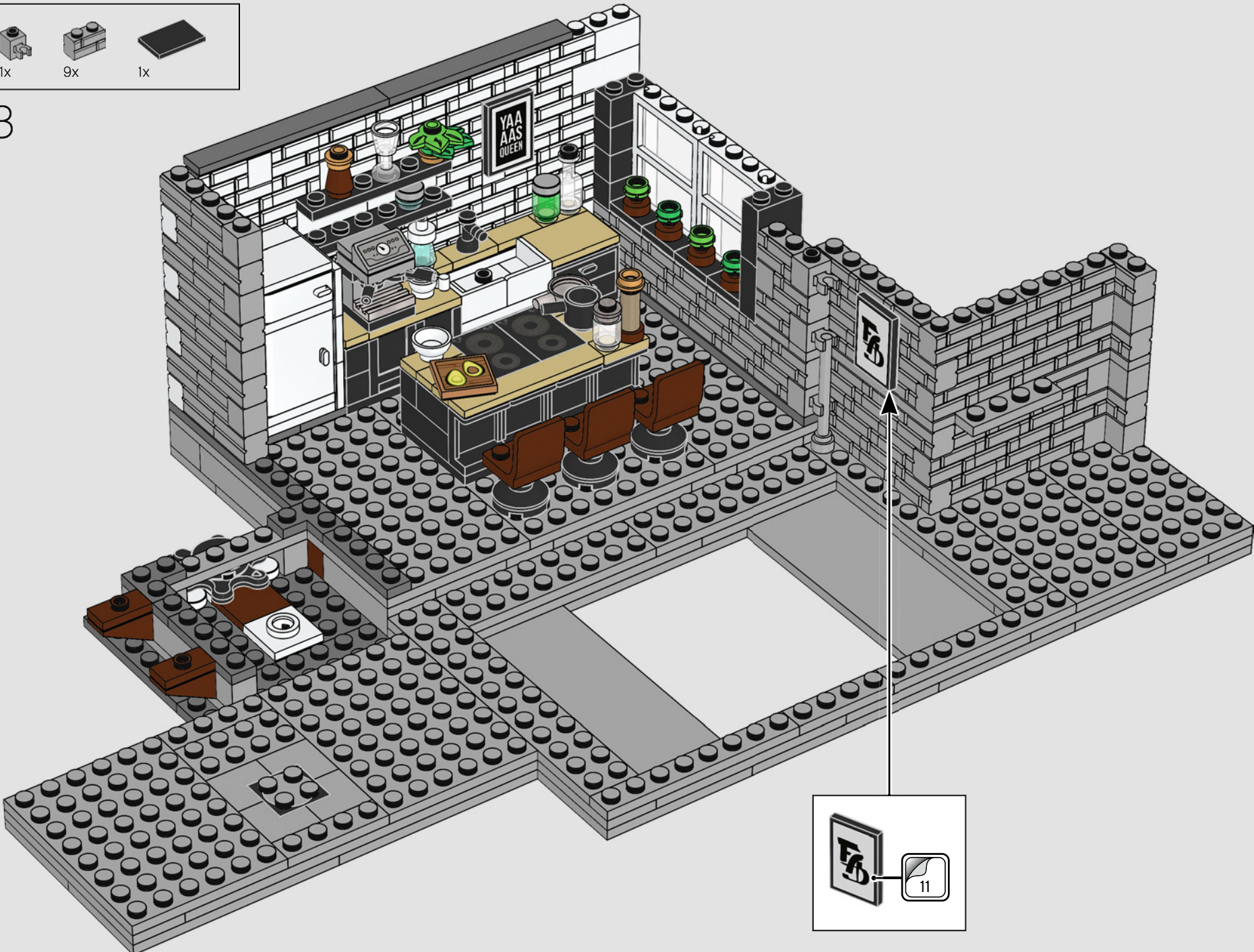

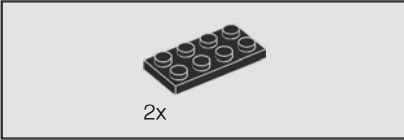
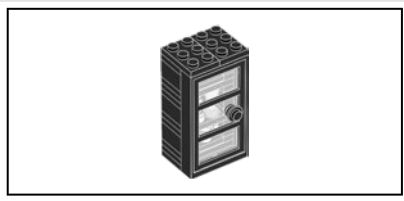

2x

84

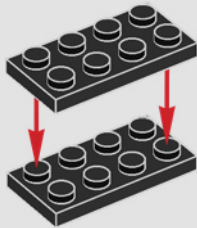

1x

2x

85

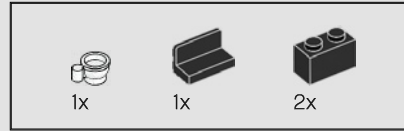
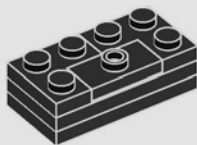

1x

1x

2x

86

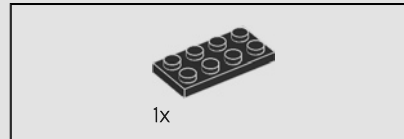
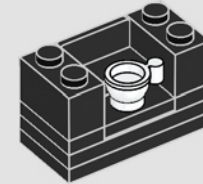

1x

87

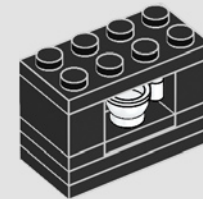



88

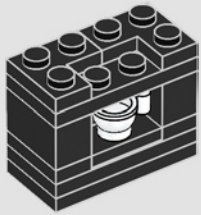

89



90

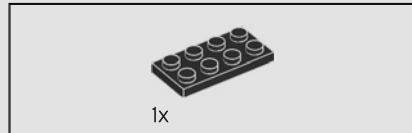

91

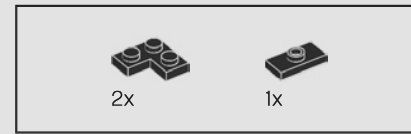

92

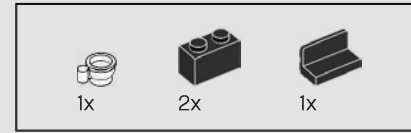

93



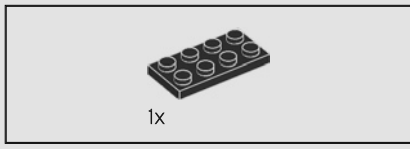

94

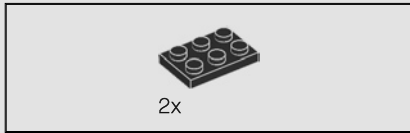

95

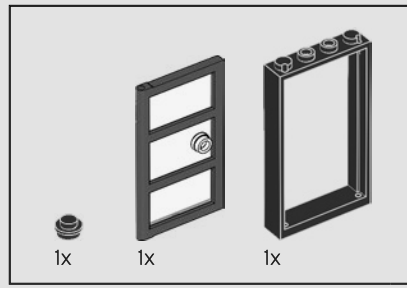
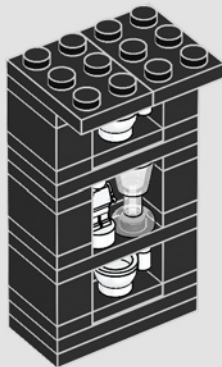

96

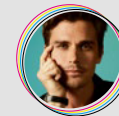
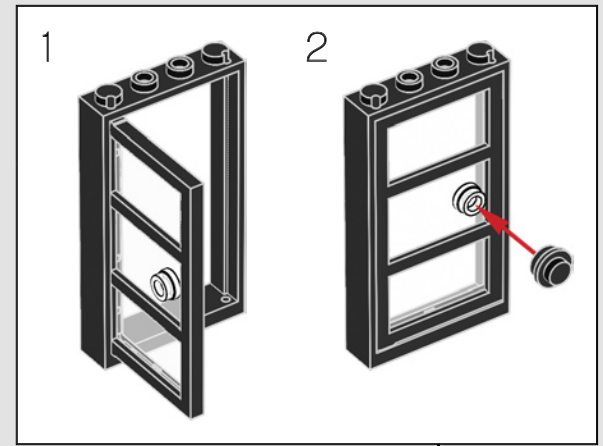
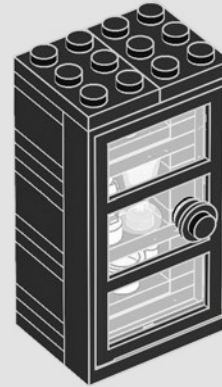

Antoni Porowski

"Cuando era niño, mis juguetes favoritos eran LEGO®. Construía ciudades y barcos piratas, los destruía y volvía a empezar. Es increíble pensar que los niños ahora tendrán opciones LGBTQ+ para jugar y construir. Me siento honrado de formar parte de esta alianza especial. El Antoni de diez años de edad que llevo dentro está gritando de emoción".

97

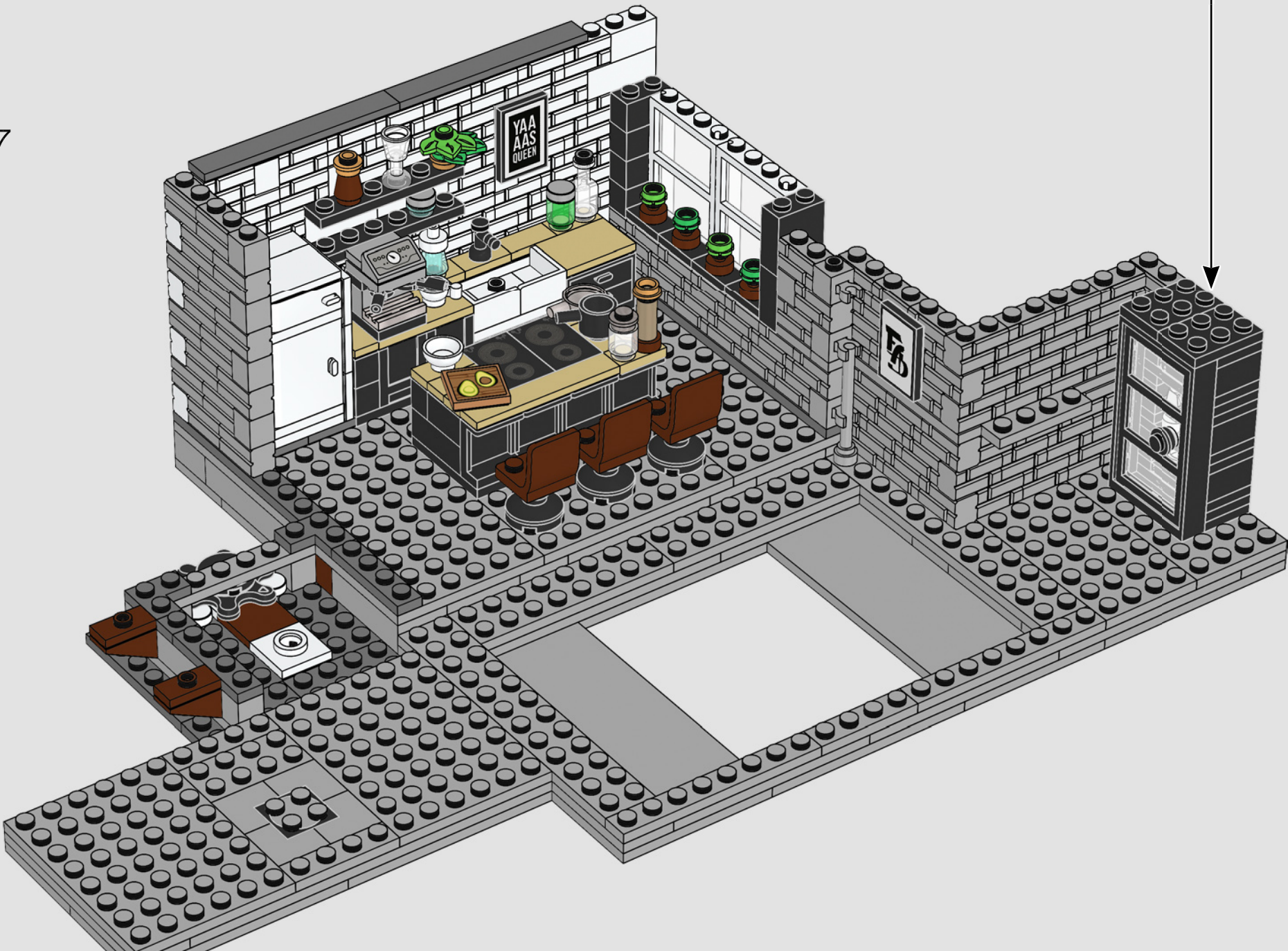

94

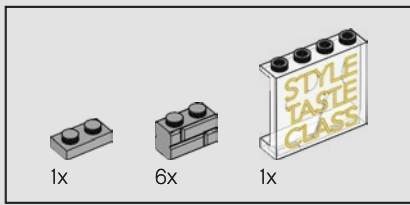

98

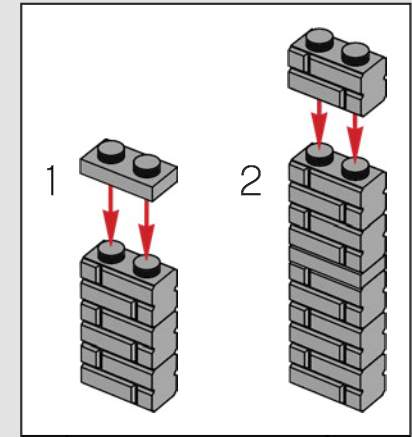
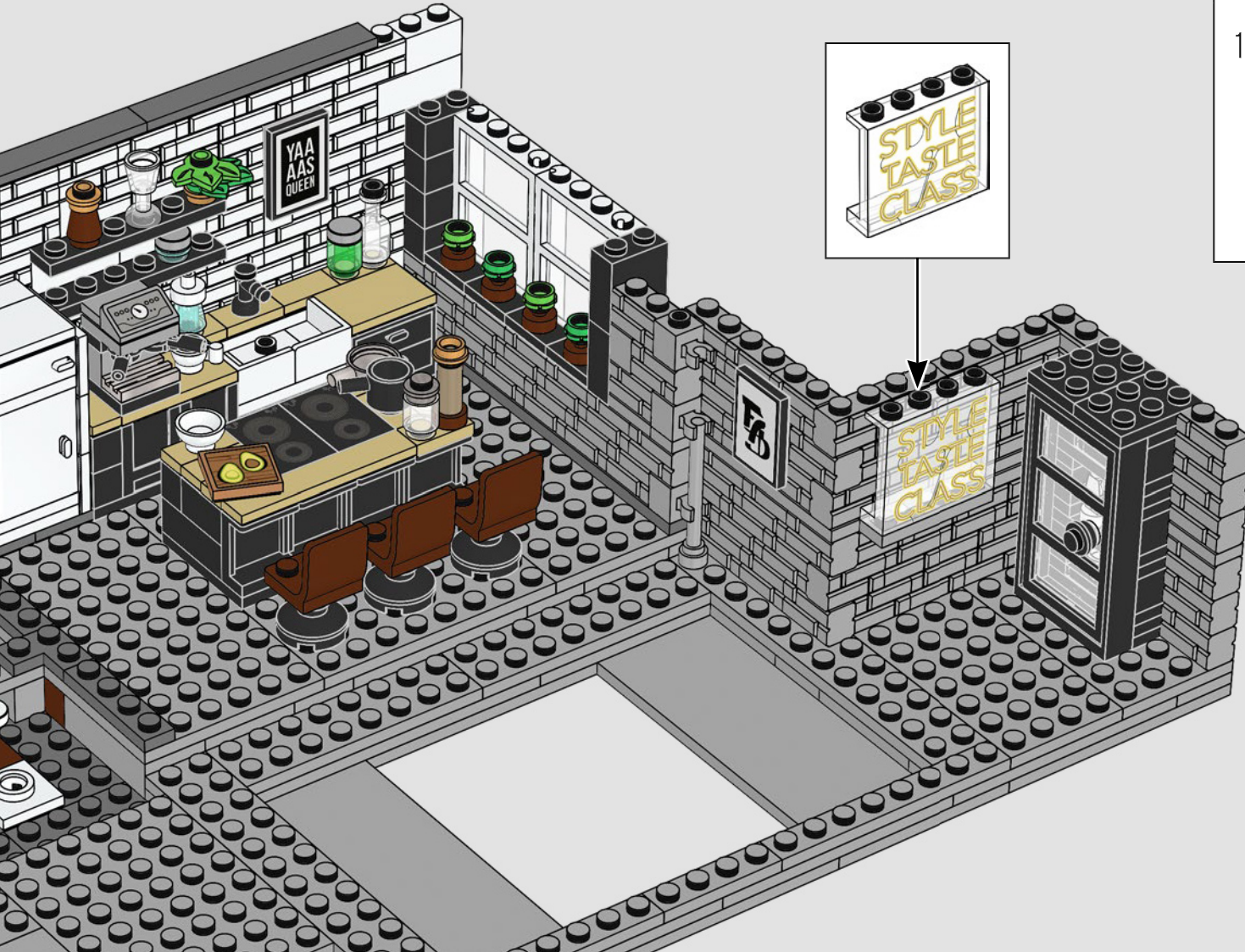

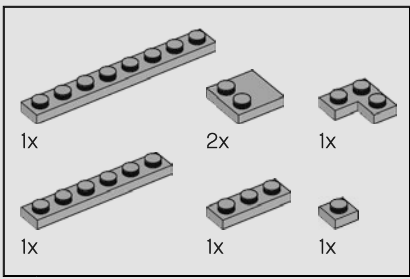

99





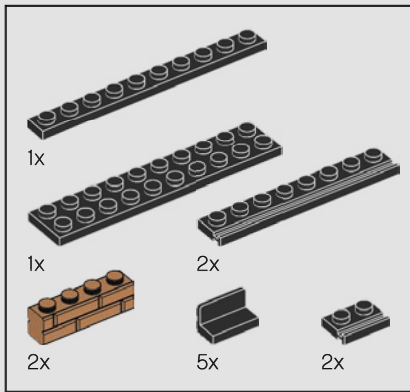

Tan France

"En el fondo de nuestros corazones, los Fab Five somos solo niños grandes, y lo que hacemos en *Queer Eye* a veces se siente más como si fuera un juego que como trabajo de verdad. Por eso, colaborar en este set LEGO®, un juguete tan querido por niños de todas las edades, nos resultó totalmente natural".

100

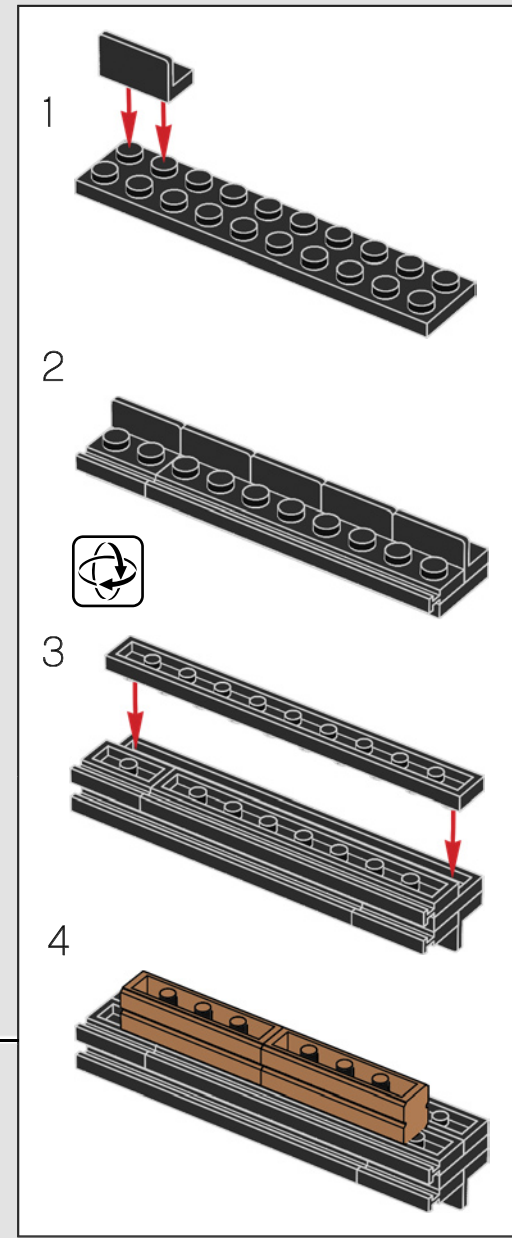

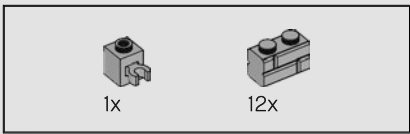

101



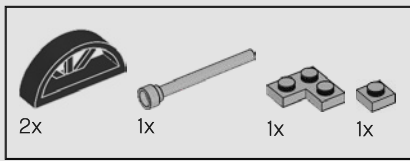

102

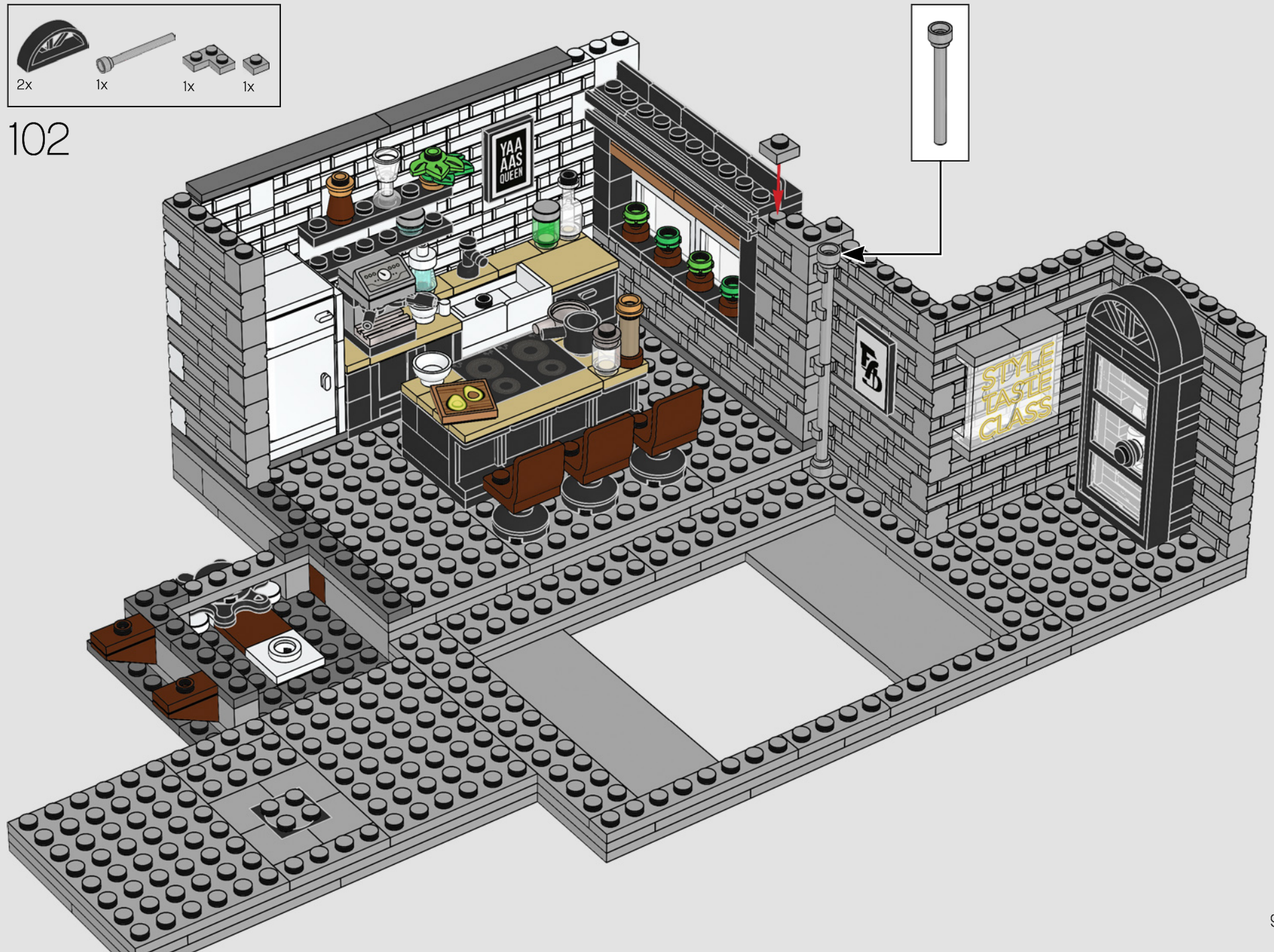



7x

103

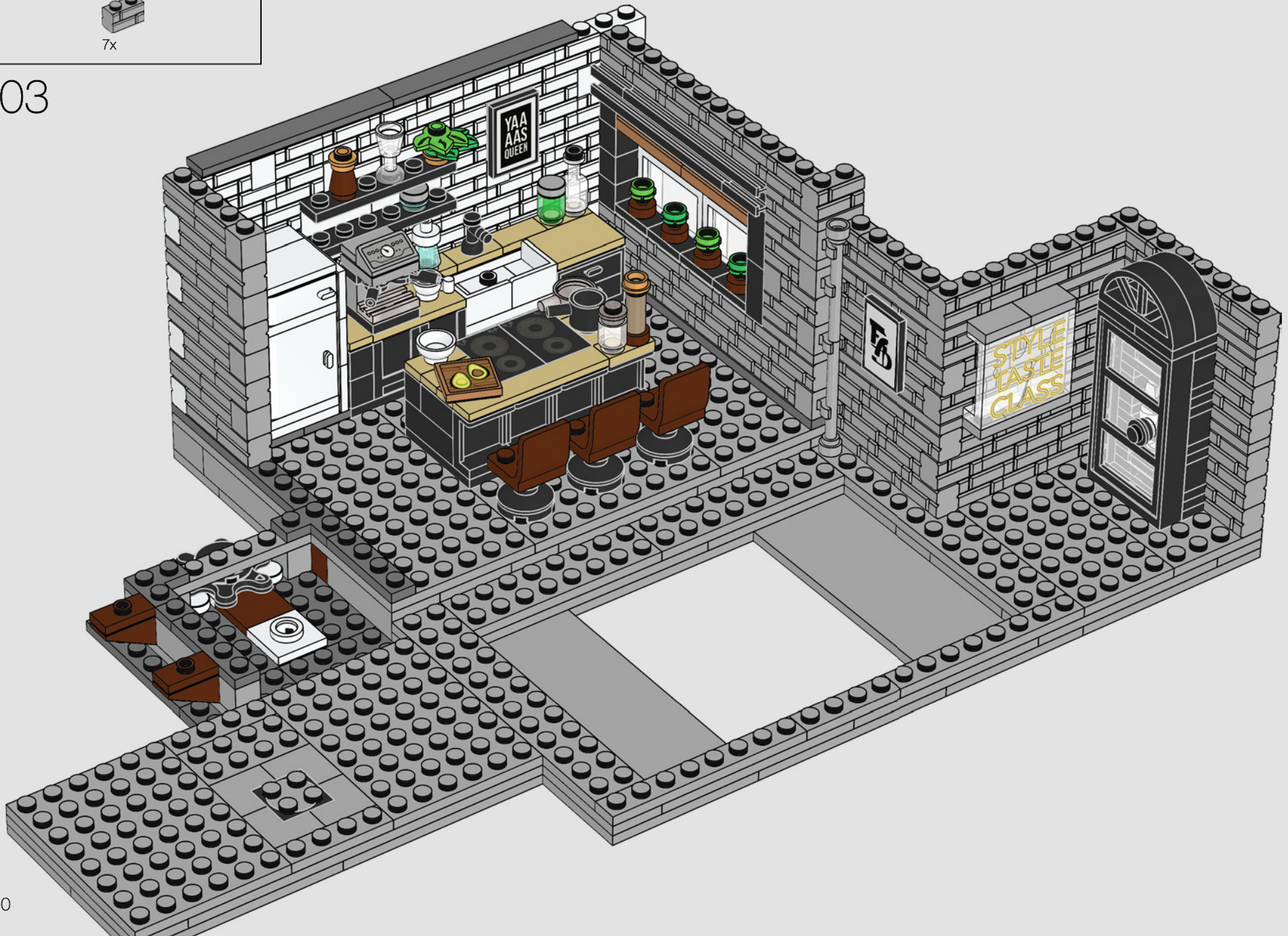

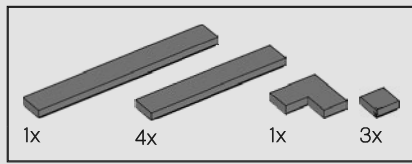

104



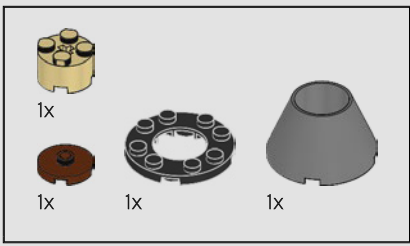

105

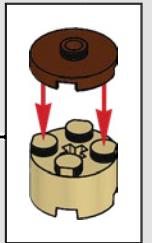
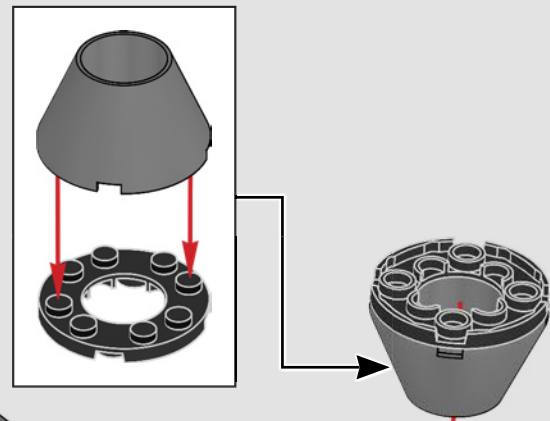

102

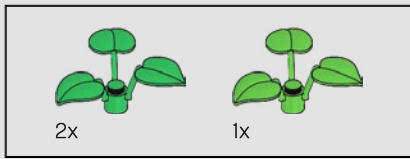

106

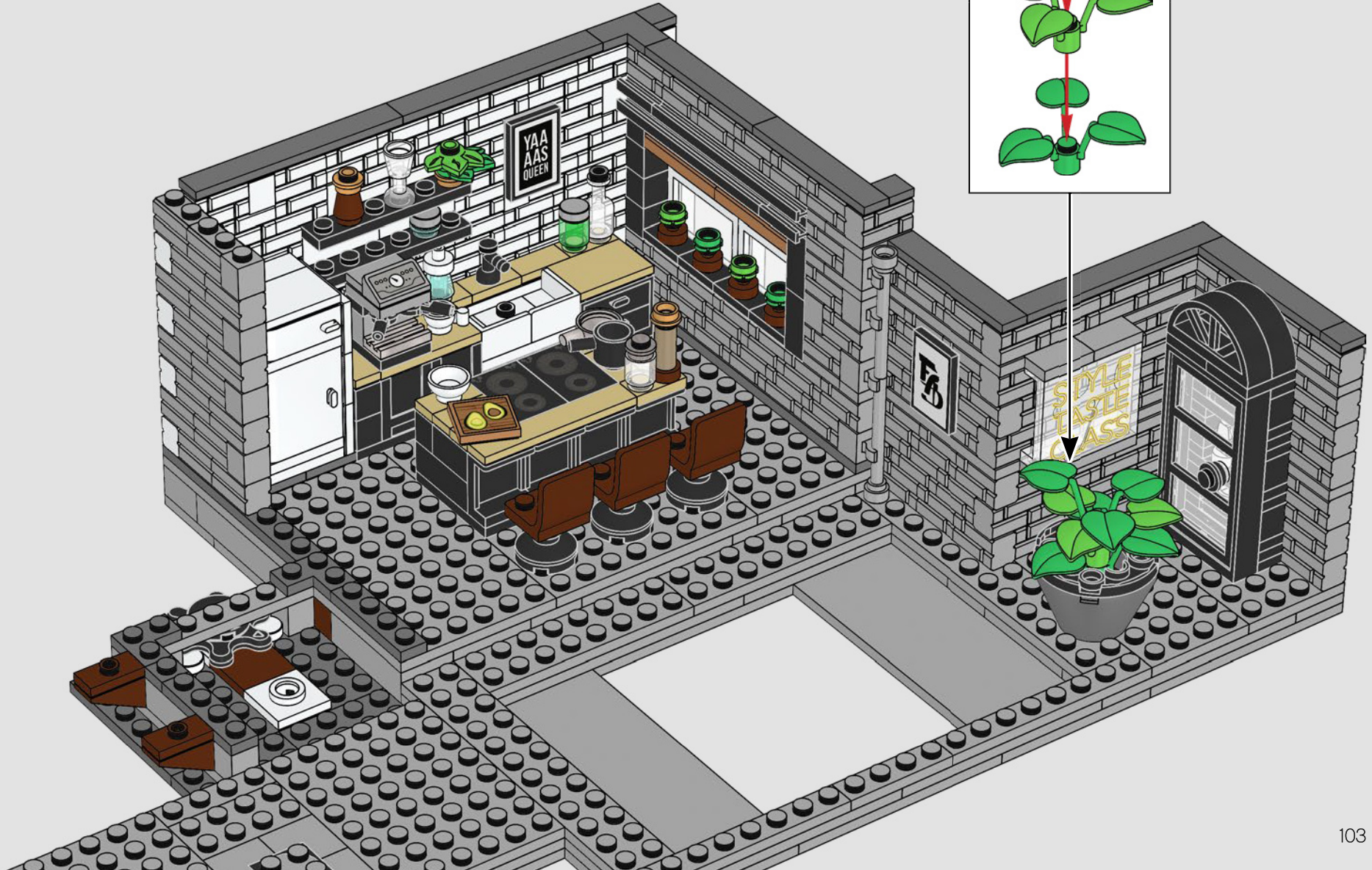

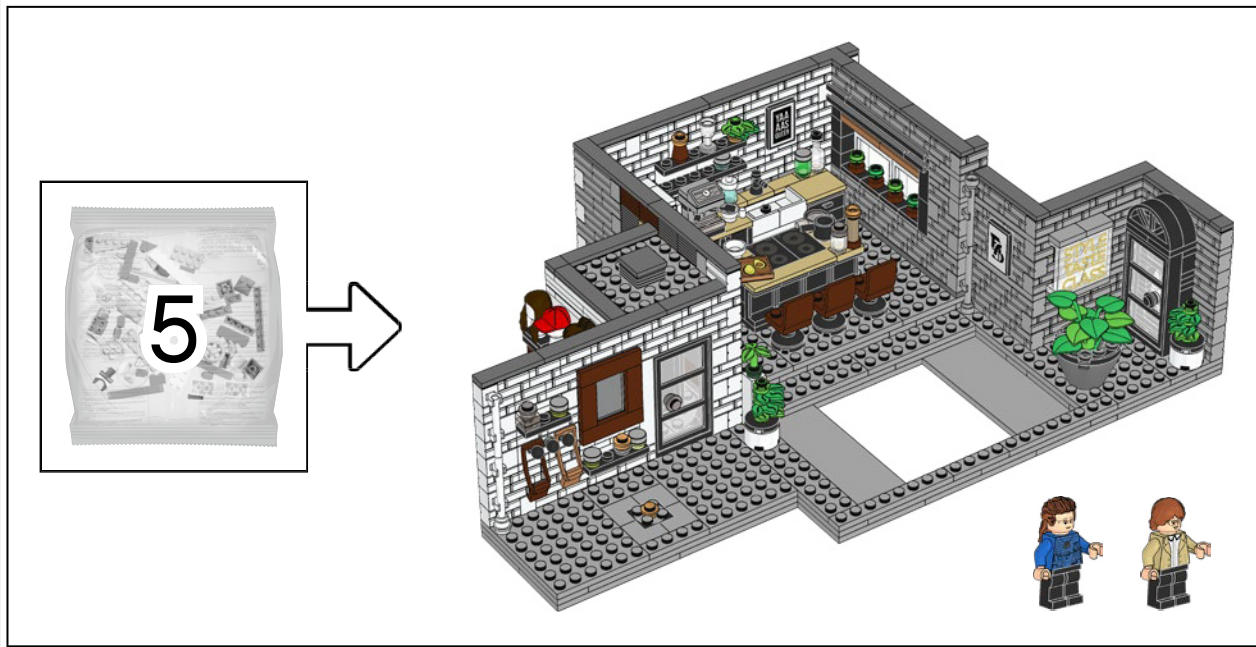

Jonathan Van Ness

"Me encantó ver a Kathi Dooley representada en este set. Significa mucho para mí, ya que es mi heroína de la niñez. Además, ¡ahora puedo jugar a cortarle el pelo tantas veces como quiera!"





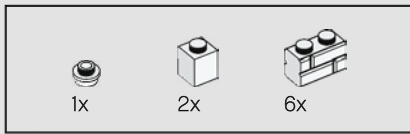

107



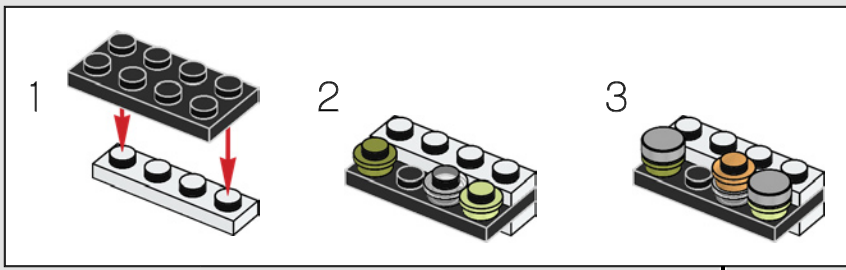
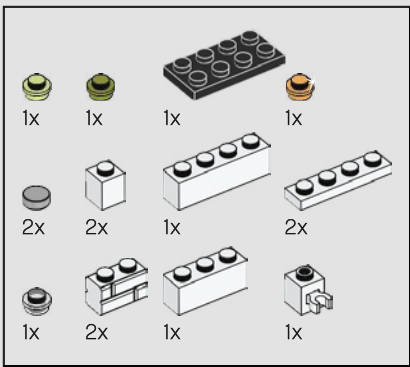

108



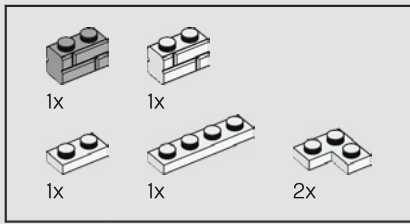

109



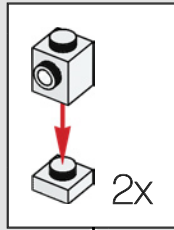
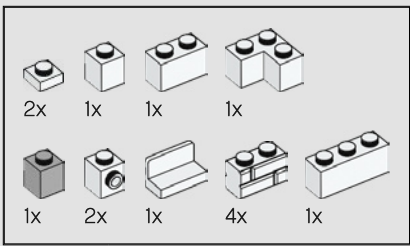

110



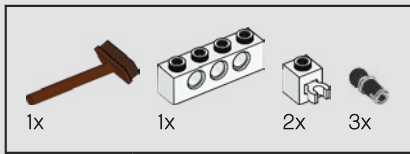

111

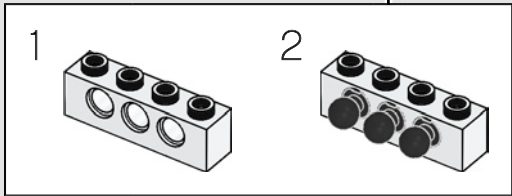
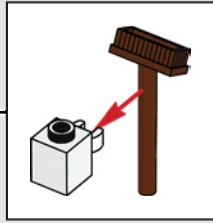

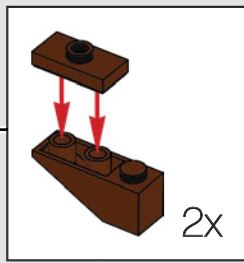
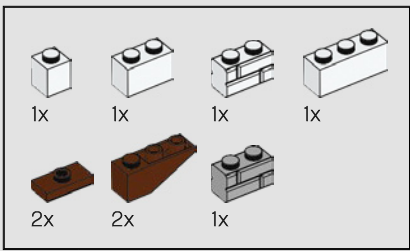

112



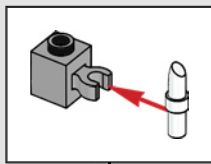
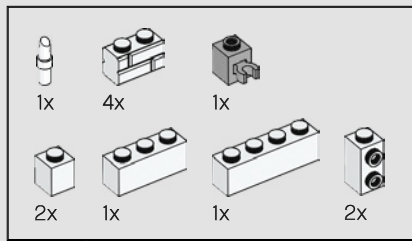

113



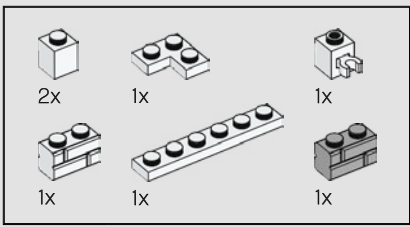

114





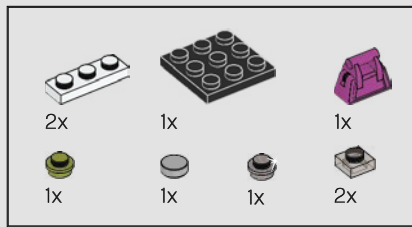

115

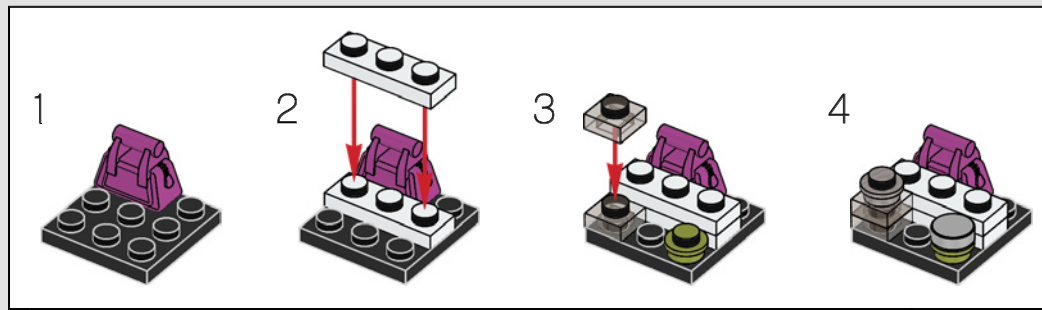

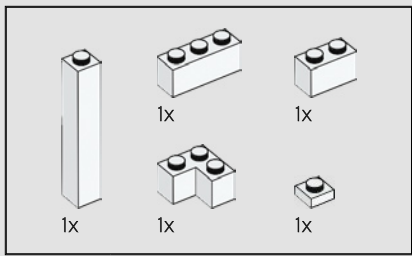

116



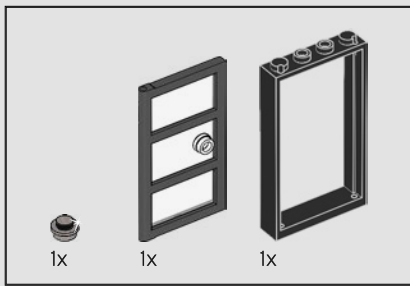

117

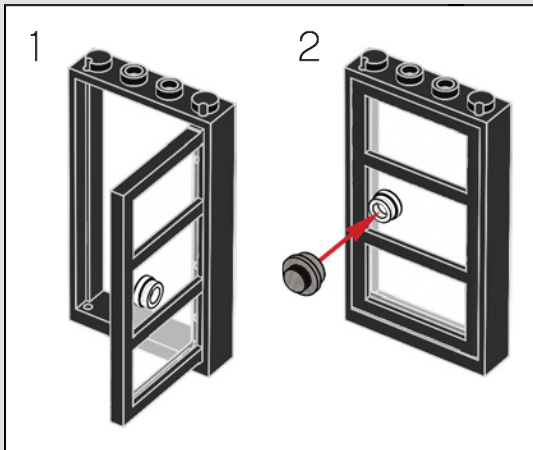

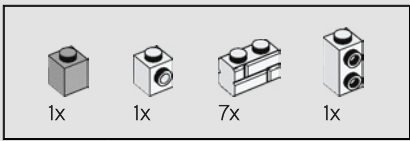

118



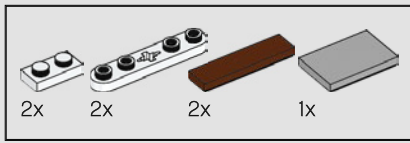

119

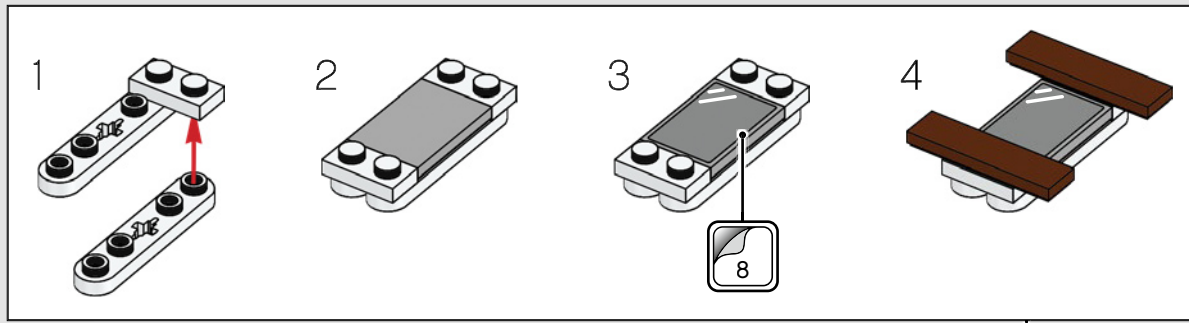

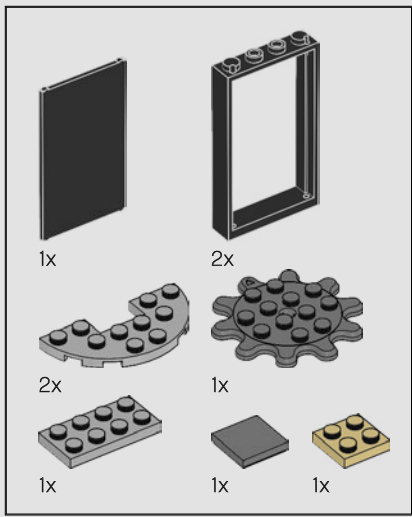

120

1

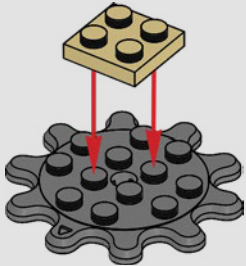

2

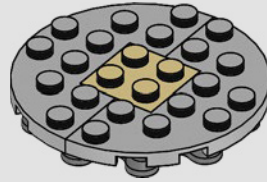

3

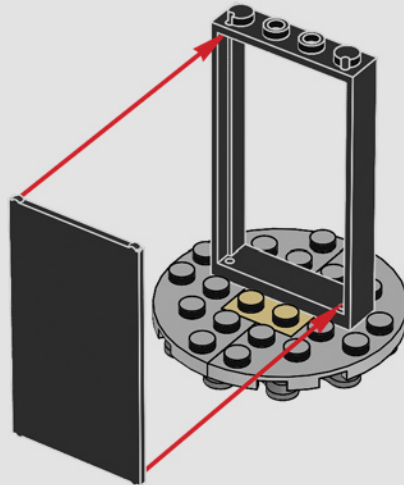

4

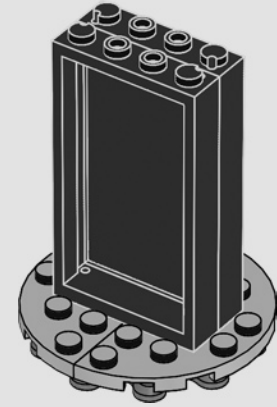

5

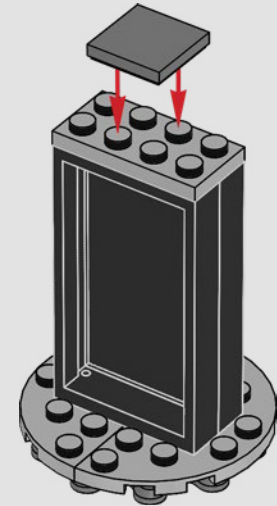

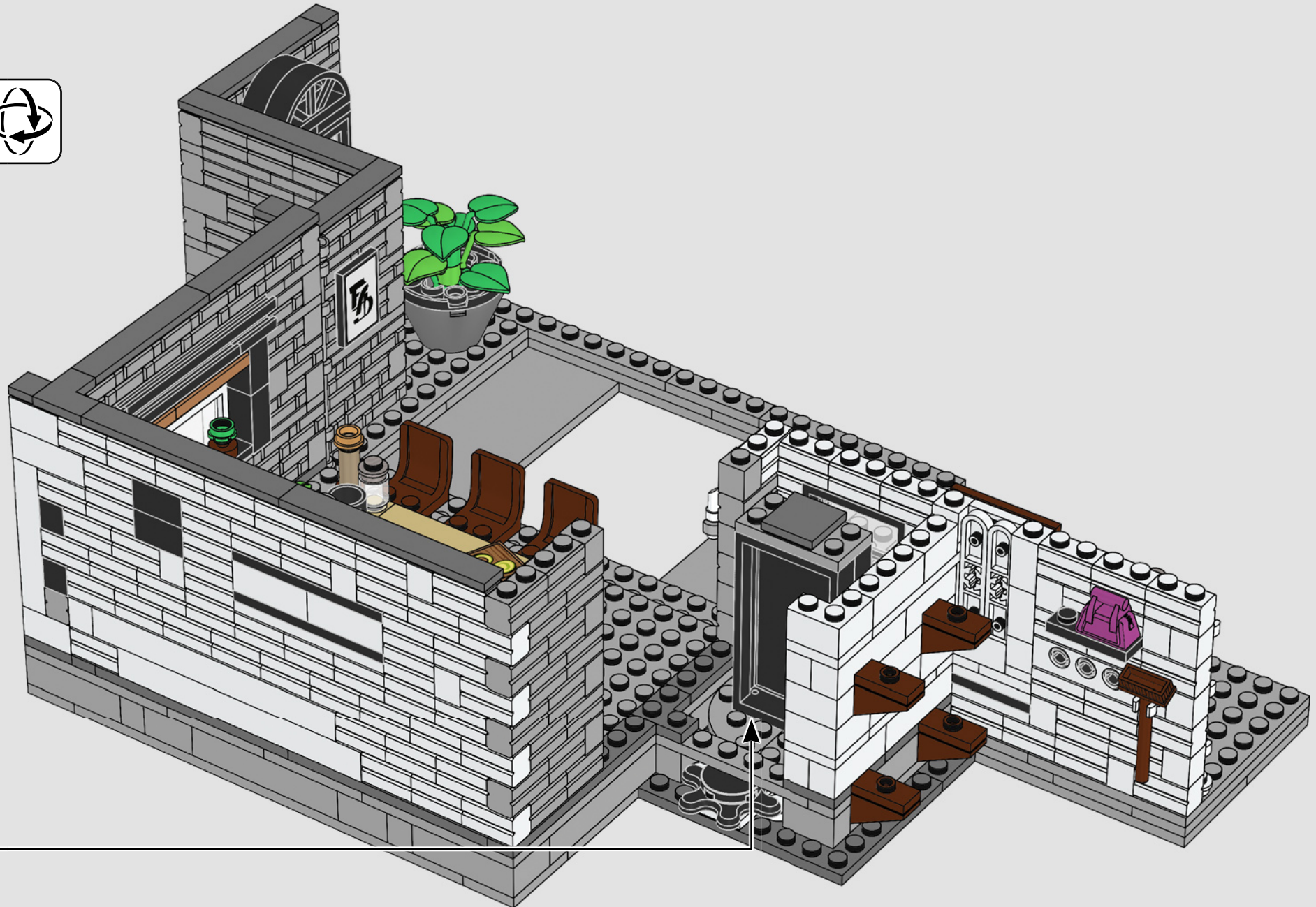

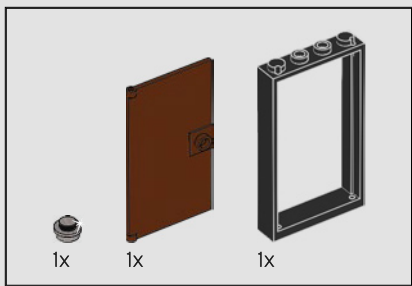

121

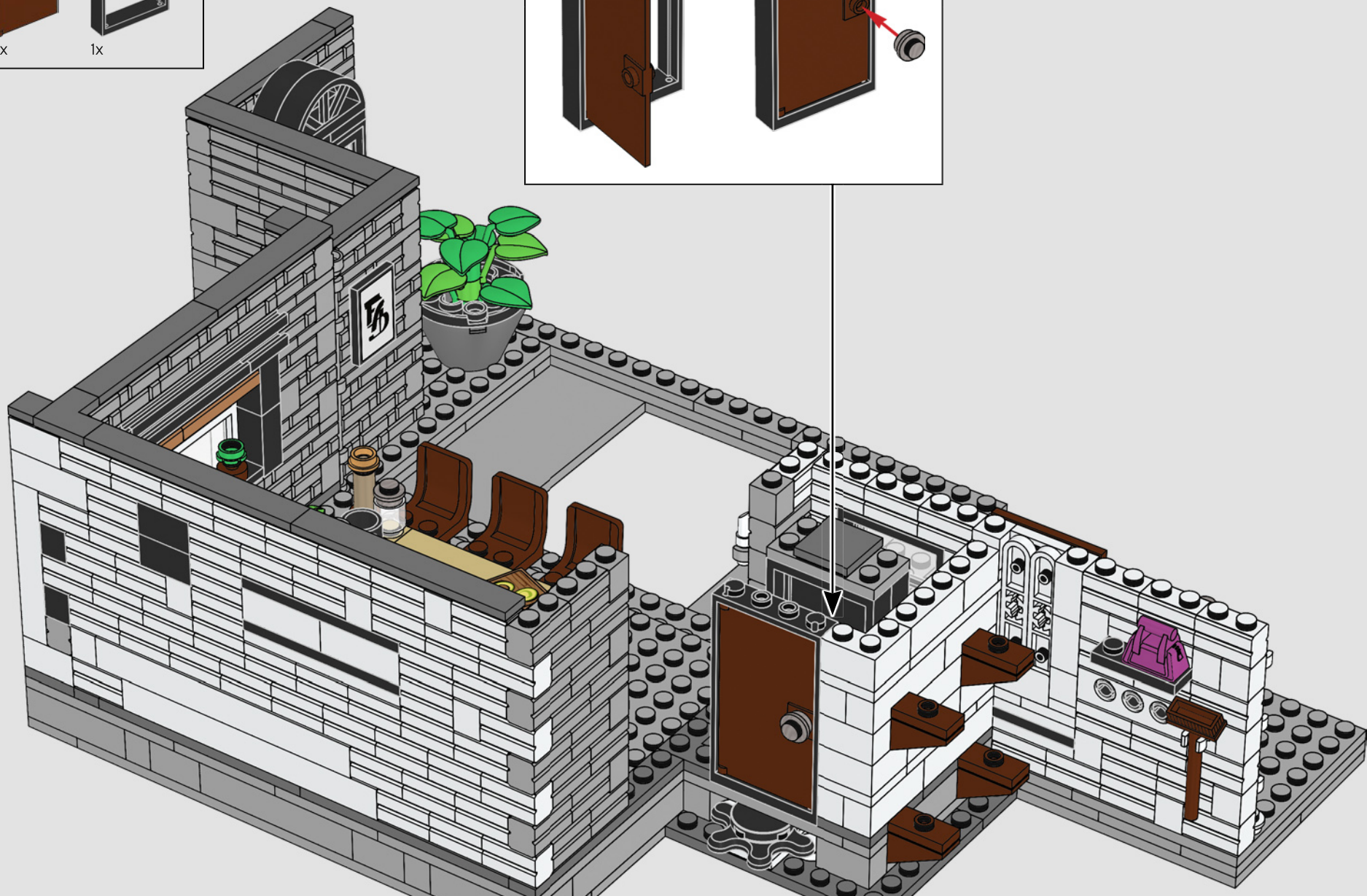
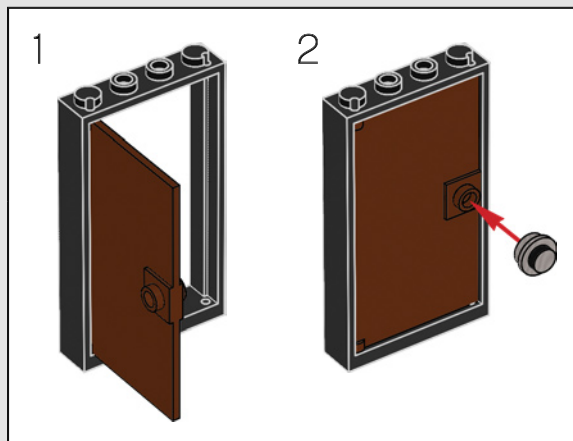



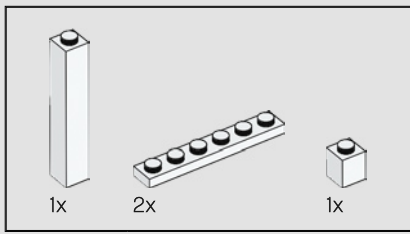

122

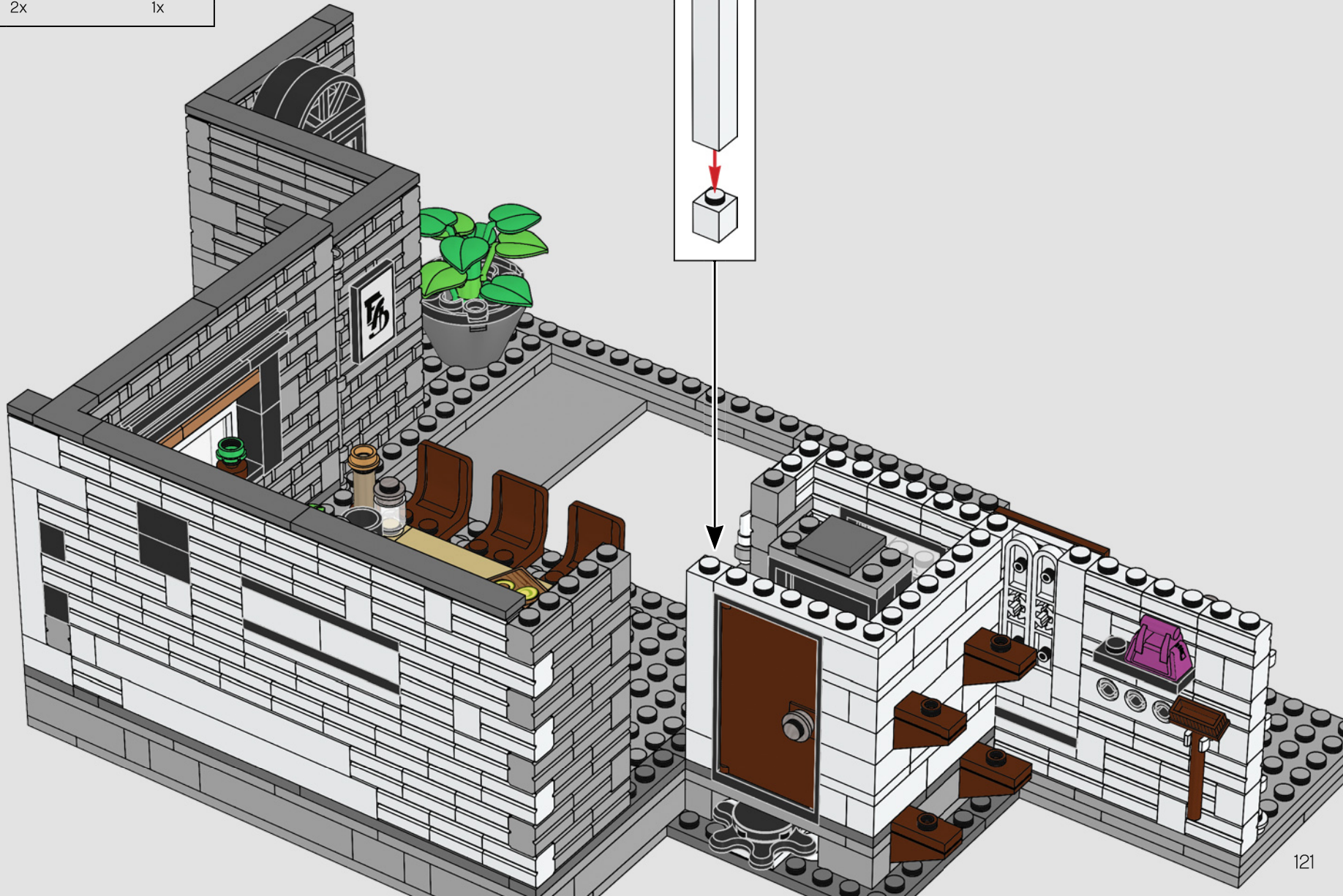

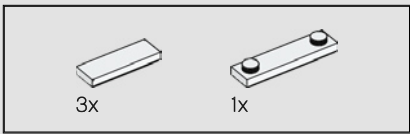

123



Tan France

"Me encanta formar parte de los Fab Five y, a través de Queer Eye, tener la oportunidad de hacer resaltar la belleza de la diversidad de nuestra comunidad. Esa era mi mayor aspiración cuando me presenté a la audición para el programa, y me siento muy agradecido de ocupar este lugar".

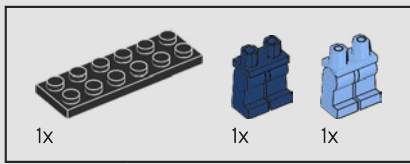

124

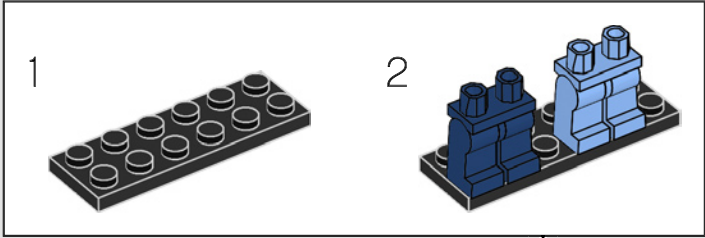
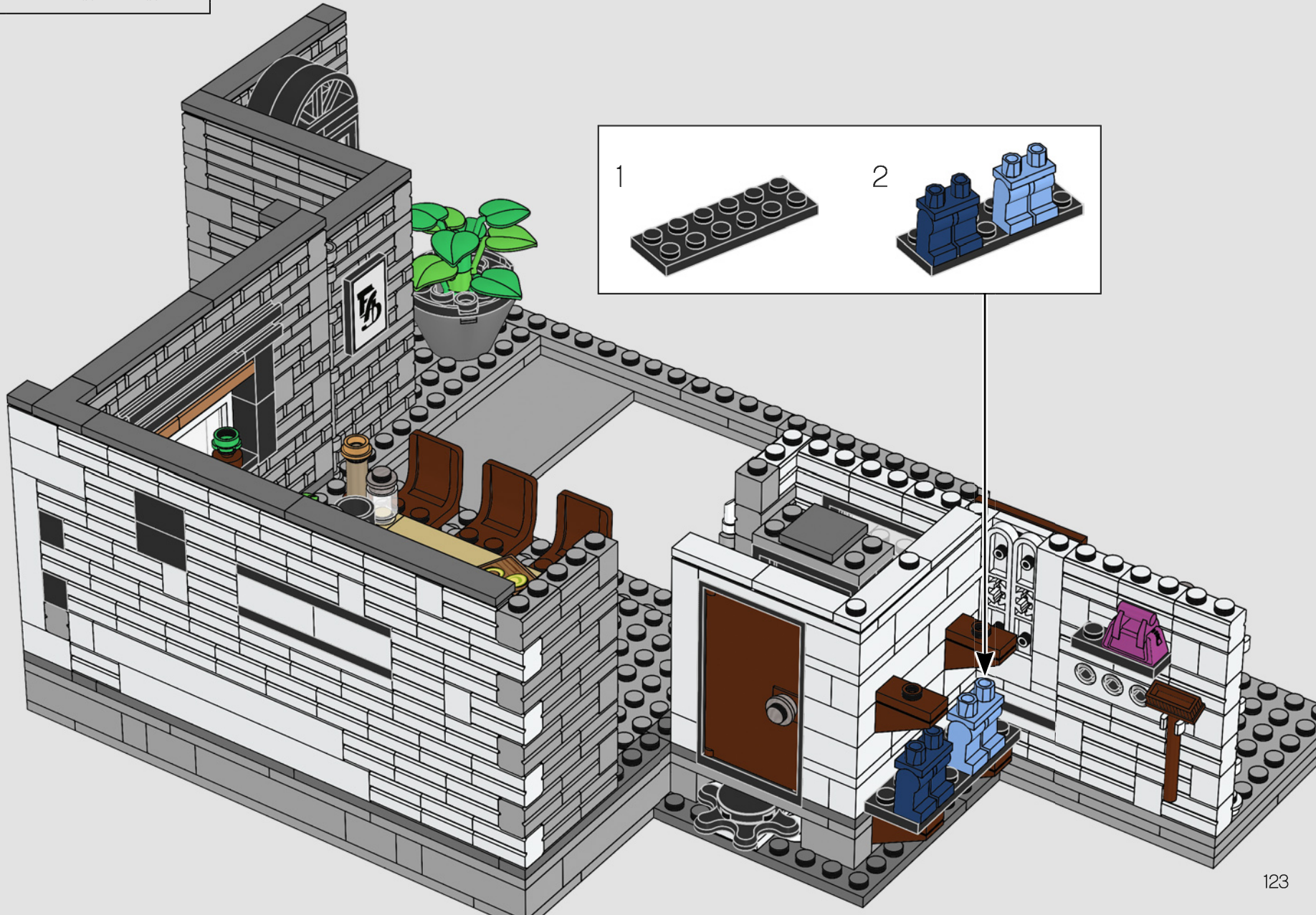

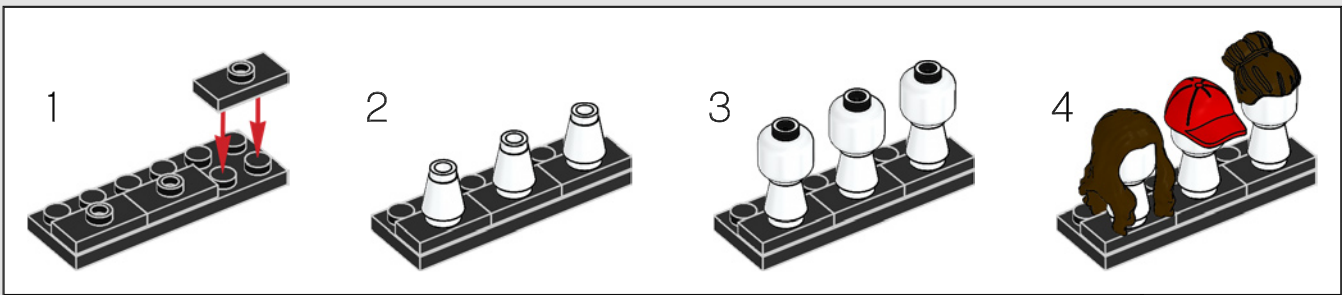
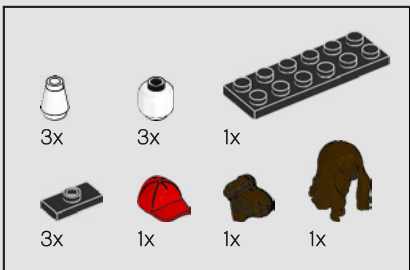

125



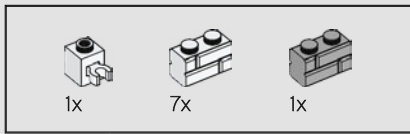

126



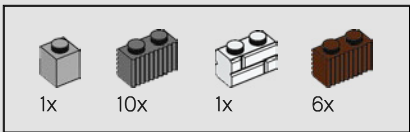

127

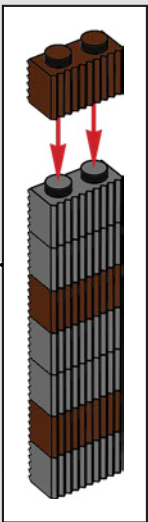
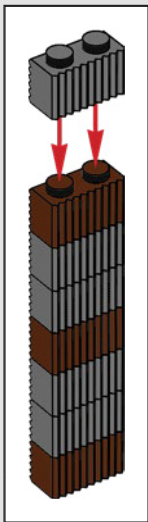

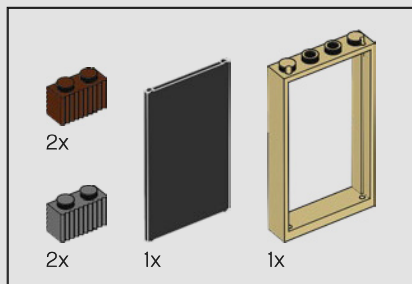

128

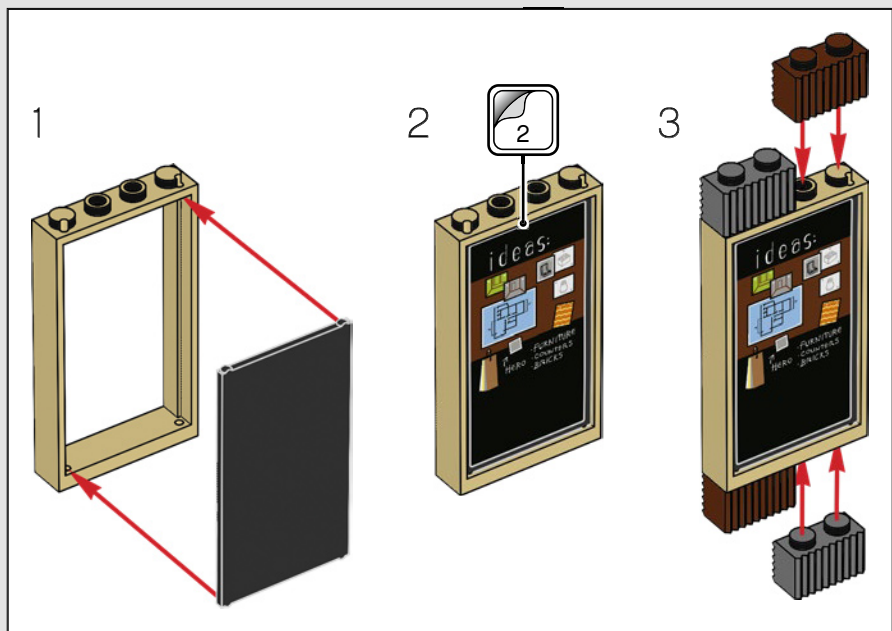

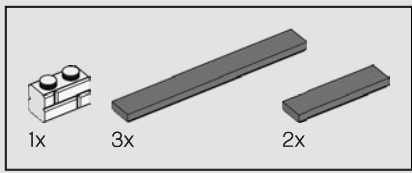

129

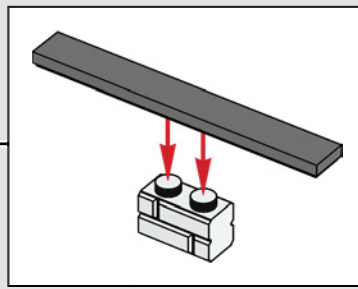



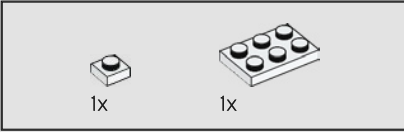
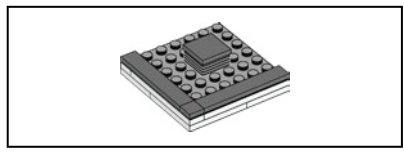

130

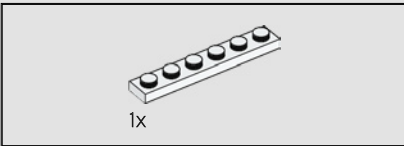
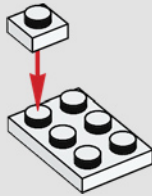

131

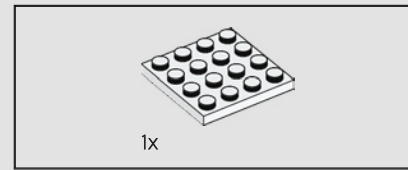
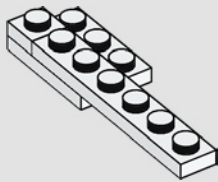

132

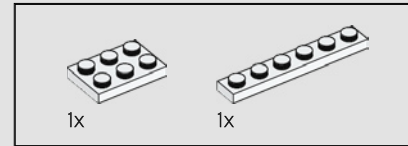
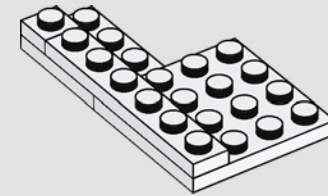

133

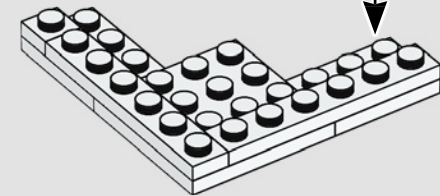
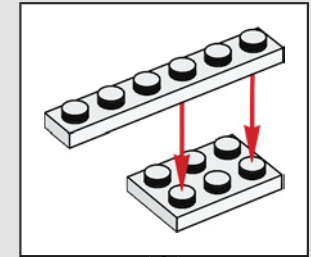

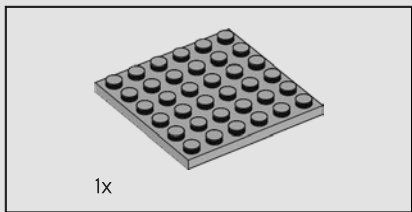

134

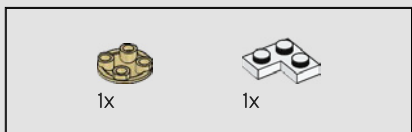
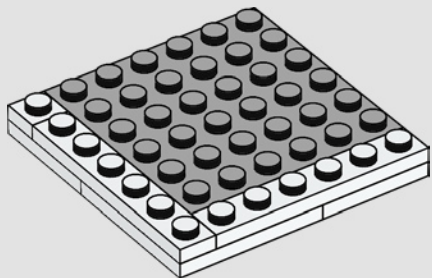

135

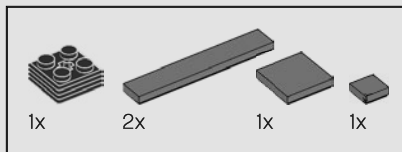
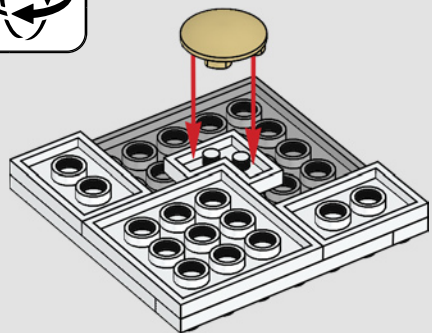

136

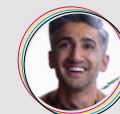
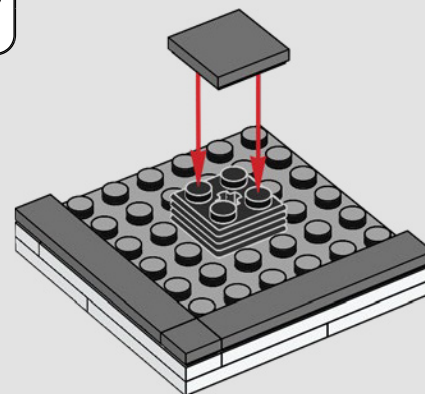

Tan France

"¡La cámara de transformación es maravillosa! Un giro y, ¡sorpresa!, la gran revelación".

137



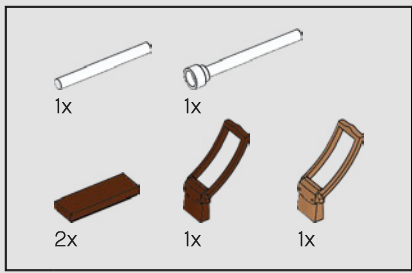

138



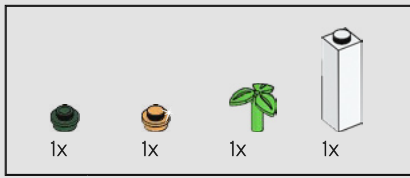

139

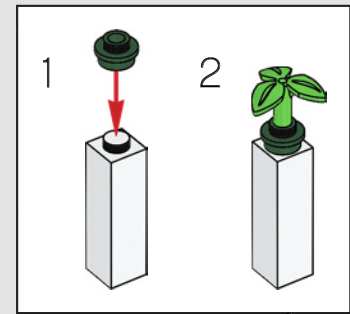

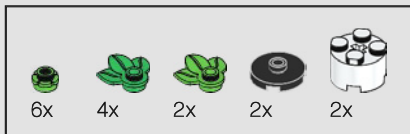

140



Karamo Brown

"En tu vida adulta, cualquier proceso creativo puede ayudarte a concentrar tu atención y despejar la mente. Además de ser una excelente manera de relajarte y desestresarte, construir con LEGO® te hace sentirte verdaderamente realizado al terminar cualquier creación. Igual que nuestro programa, LEGO pone su granito de arena para conectar las piezas de las vidas de las personas. Eso hace perfecta esta alianza".

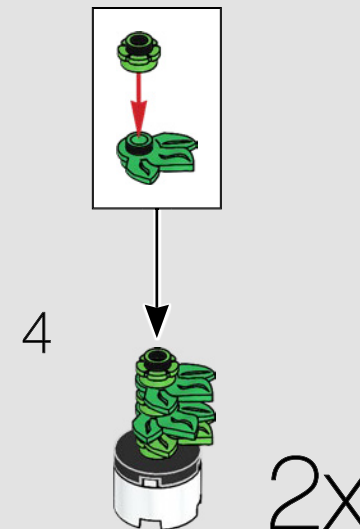
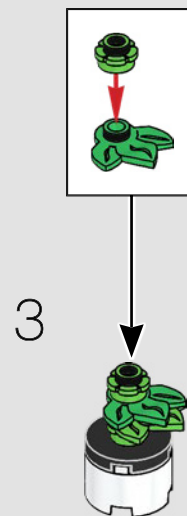
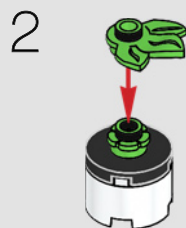
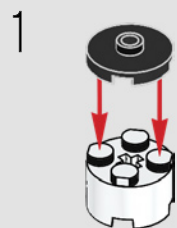





Bobby Berk

"Me llena de satisfacción ver la versión final del set. ¡Creo que pudimos captar bien la esencia de todo lo que había en el loft original!"







# FEEDBACK AND WIN



## FEEDBACK AND WIN

Your feedback will help shape the future development of this product series.

Please visit:

## FEEDBACK UND GEWINNEN

Dein Feedback trägt zur Weiterentwicklung dieser Produktreihe bei.

Geh auf:

## COMMENTEZ ET GAGNEZ

Vos commentaires nous aideront à concevoir les futurs produits de cette gamme.

Rendez-vous sur :

## COMENTA Y GANA

Tu opinión nos ayudará a dar forma al desarrollo de esta serie de productos en el futuro.

Visita:

## 反馈有奖

您的反馈将有助于我们在今后改进本系列产品。

请访问：

---

[LEGO.com/productfeedback](https://www.lego.com/productfeedback)

---

By completing, you will automatically enter a drawing to win a LEGO® set.

Terms & Conditions apply.

Durch Ausfüllen nimmst du automatisch an der Verlosung eines LEGO® Preises teil.

Es gelten die Teilnahmebedingungen.

En envoyant vos commentaires, vous serez automatiquement inscrit(e) à un tirage au sort qui vous permettra de remporter un prix LEGO®.

Offre soumise à conditions.

Al contestar, participarás automáticamente en el sorteo y podrás ganar un set LEGO®.

Sujeto a Términos y Condiciones.

完成我们的反馈调查，即可自动进入抽奖环节，赢取乐高®套装。

适用《条款和条件》。

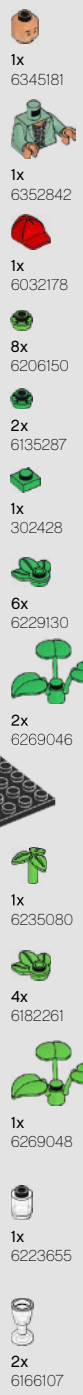



**Customer Service**  
**Kundenservice**  
**Service Consommateurs**  
**Servicio Al Consumidor**  
**LEGO.com/service or dial**



: 00800 5346 5555  
 : 1-800-422-5346



LEGO and the LEGO logo are trademarks of the LEGO Group. ©2021 The LEGO Group.

©2021, Scout Productions, Inc. and the Queer Eye logo are trademarks or registered trademarks of Scout Productions, in the United States of America and elsewhere. All rights reserved.