

10277

CROCODILE LOCOMOTIVE

LA LOCOMOTIVE
CROCODILE

LOCOMOTORA
COCODRILO



Booklet available in English on
Livret disponible en français sur
Folleto disponible en español en

[LEGO.com/service/buildinginstructions](https://www.lego.com/service/buildinginstructions)

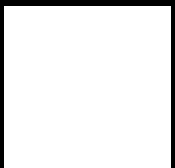

The pantograph sits on top of the roof of the locomotive's central section and is in constant contact with the overhead power line.

Le pantographe, situé au-dessus du toit de la section centrale de la locomotive, est en contact constant avec la ligne électrique aérienne.

El pantógrafo se encuentra ubicado encima de la sección central de la locomotora y permanece en contacto constante con la línea eléctrica suspendida.

With numerous long tunnels to negotiate in countries like Switzerland and Austria, electric locomotives were much preferable to the more traditional steam engines that produced smoke.

Avec de nombreux longs tunnels à négocier dans des pays comme la Suisse et l'Autriche, les locomotives électriques étaient de loin préférables aux machines à vapeur plus traditionnelles qui produisaient de la fumée.

Los numerosos y largos túneles que debían atravesar los trenes en países como Suiza y Austria hacían preferibles las locomotoras eléctricas a las tradicionales máquinas de vapor por el humo que producían estas últimas.

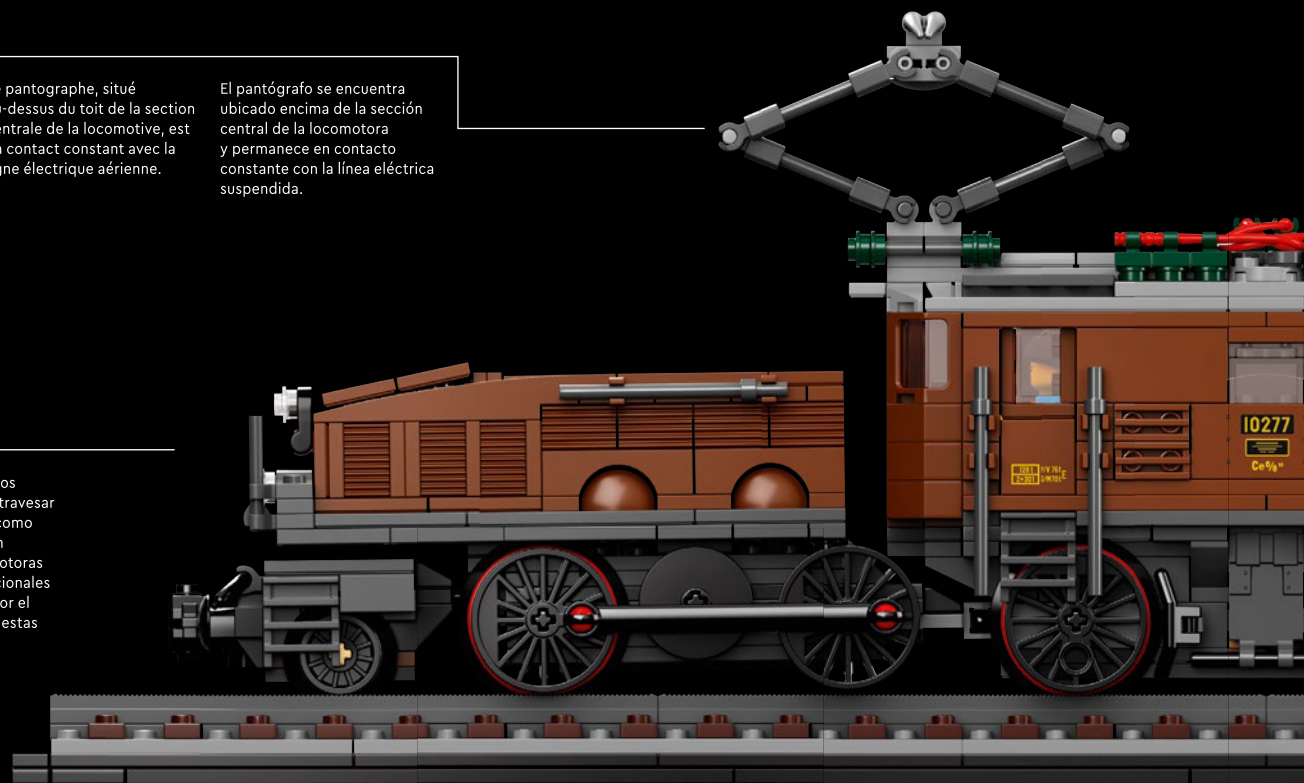

CROCODILE LOCOMOTIVE

The powerful "Crocodile locomotive" was originally constructed to move heavy freight through the steep mountains of Switzerland. The specially designed pivoting center section allowed it to negotiate the tightest of Alpine curves.

Though originally only meant to pull freight trains, this type of locomotive was also used on passenger services and was still in service until the 1980s.

This much revered locomotive celebrated its 100th anniversary in 2019.

LA LOCOMOTIVE CROCODILE

La puissante « locomotive crocodile » a originellement été fabriquée pour transporter des marchandises lourdes à travers les montagnes escarpées de la Suisse. La section centrale pivotante a été spécialement conçue pour lui permettre de négocier les courbes alpines les plus serrées.

Bien qu'à l'origine, ce type de locomotive a été construit pour tirer les trains de marchandises, il a également été utilisé pour assurer les services aux passagers et était encore en service jusque dans les années 1980.

Cette locomotive très vénérée a fêté son 100^e anniversaire en 2019.

LOCOMOTORA COCODRILLO

La potente locomotora cocodrilo se diseñó para transportar mercancías pesadas a través de las escarpadas montañas de Suiza. Gracias a su sección central articulada especial, era capaz de superar hasta las curvas alpinas más cerradas.

Aunque su propósito original era solo jalar trenes de carga, este tipo de locomotora se usó también para el transporte de pasajeros y estuvo en servicio hasta la década de 1980.

Esta veneradísima locomotora celebró su centenario en 2019.

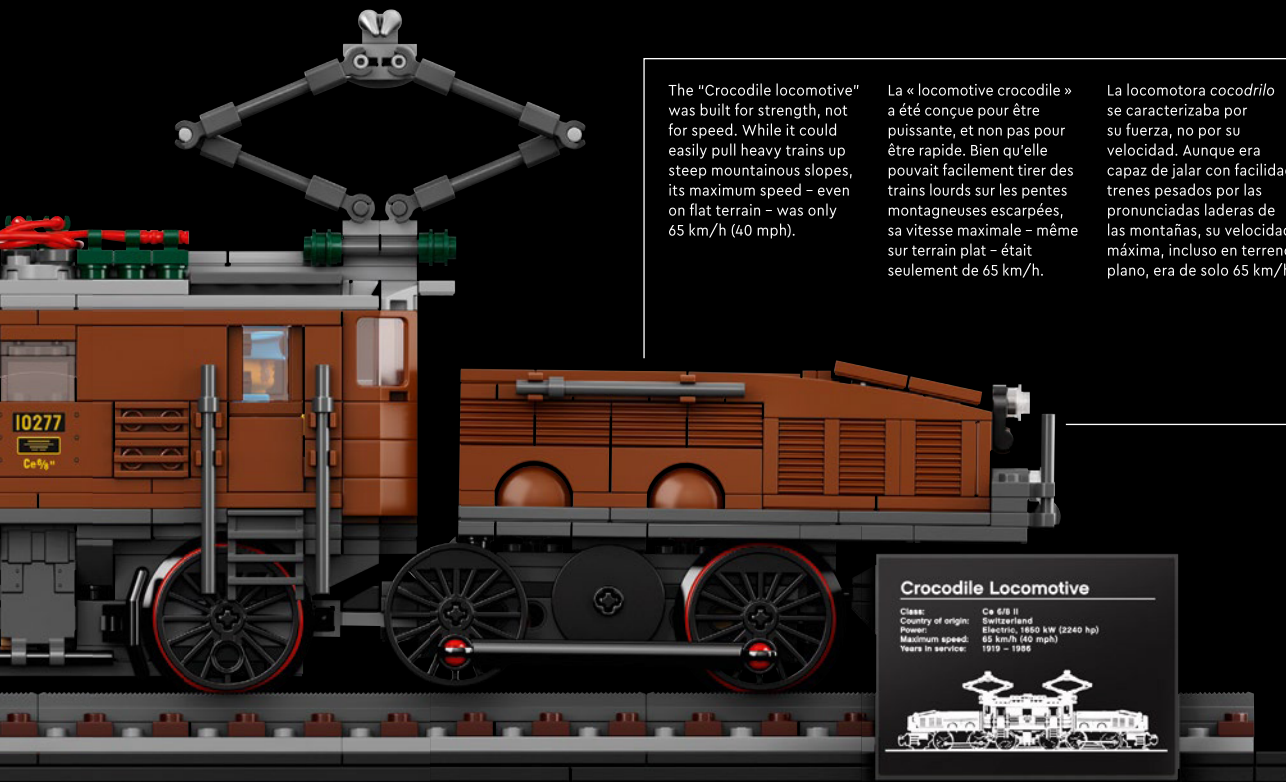

The "Crocodile locomotive" was built for strength, not for speed. While it could easily pull heavy trains up steep mountainous slopes, its maximum speed – even on flat terrain – was only 65 km/h (40 mph).

La « locomotive crocodile » a été conçue pour être puissante, et non pas pour être rapide. Bien qu'elle pouvait facilement tirer des trains lourds sur les pentes montagneuses escarpées, sa vitesse maximale – même sur terrain plat – était seulement de 65 km/h.

La locomotora cocodrilo se caracterizaba por su fuerza, no por su velocidad. Aunque era capaz de jalar con facilidad trenes pesados por las pronunciadas laderas de las montañas, su velocidad máxima, incluso en terreno plano, era de solo 65 km/h.

Crocodile Locomotive

Class: Ce 6/8 II
 Country of origin: Switzerland
 Power: Electric, 1850 kW (2440 hp)
 Maximum speed: 65 km/h (40 mph)
 Years in service: 1919 – 1986



With long "snouts" at either end, it's easy to see why this distinctive-looking engine quickly became known as the "Crocodile locomotive". These elongated sections contained the motors and drive axles which were connected to a center section that housed the transformer, pantograph and crew cab.

Avec de longs « museaux » à chaque extrémité, il est facile de voir pourquoi ce véhicule unique a rapidement été surnommé « locomotive crocodile ». Ces sections allongées contenaient les moteurs et les essieux moteurs qui étaient reliés à une section centrale abritant le transformateur, le pantographe et la cabine de l'équipage.

A la vista del peculiar aspecto de la máquina y los largos "hocicos" con que cuenta en cada extremo, resulta evidente cómo fue que la locomotora cocodrilo adoptó tan rápidamente un nombre como ese. Tales secciones alargadas contenían los motores y los ejes de transmisión, conectados a una sección central que albergaba el transformador, el pantógrafo y la cabina del personal técnico.

Ready for Powered Up
 Compatible avec Powered Up
 Compatible con Powered Up



10277

+



88009

+



88013

+



LEGO® Powered Up
 LEGO.com/apps

=



DOWNLOAD FREE APP!
 TÉLÉCHARGE L'APPLI GRATUITE !
 ¡DESCARGA GRATIS LA APP!

ELECTRIC MOTORS
 MOTEURS ÉLECTRIQUES
 MOTORES ELÉCTRICOS

SMART DEVICE REQUIRED BUT NOT INCLUDED
 APPAREIL INTELLIGENT REQUIS, MAIS NON INCLUS
 SE REQUIERE UN DISPOSITIVO INTELIGENTE
 (NO INCLUIDO)



LEGO.com/brickseparator

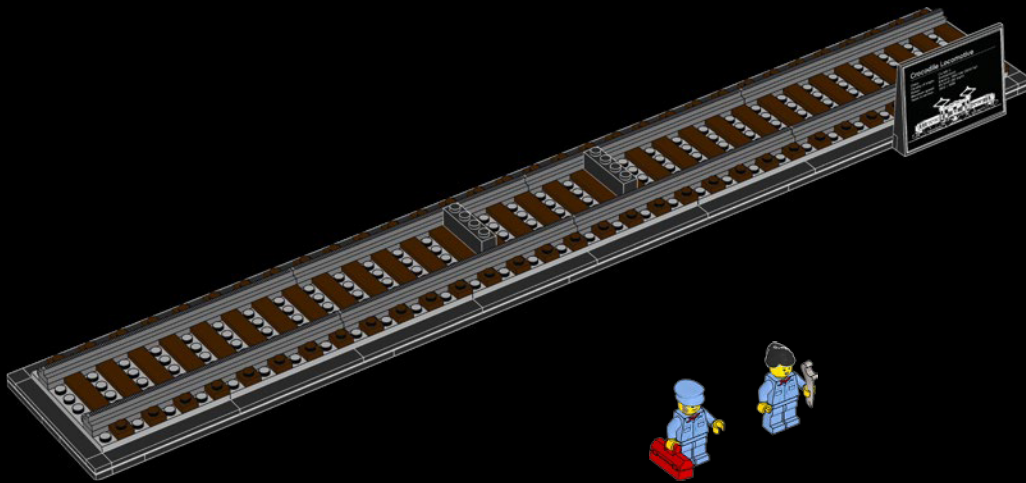
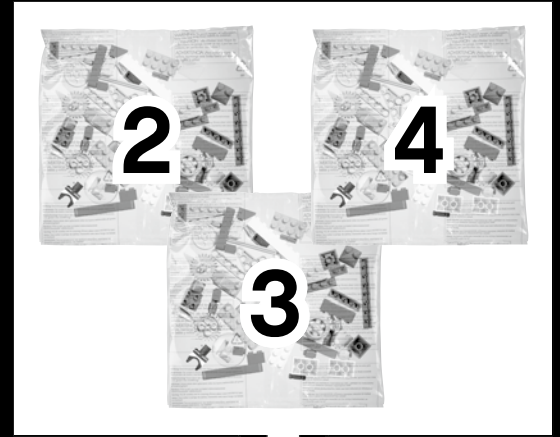

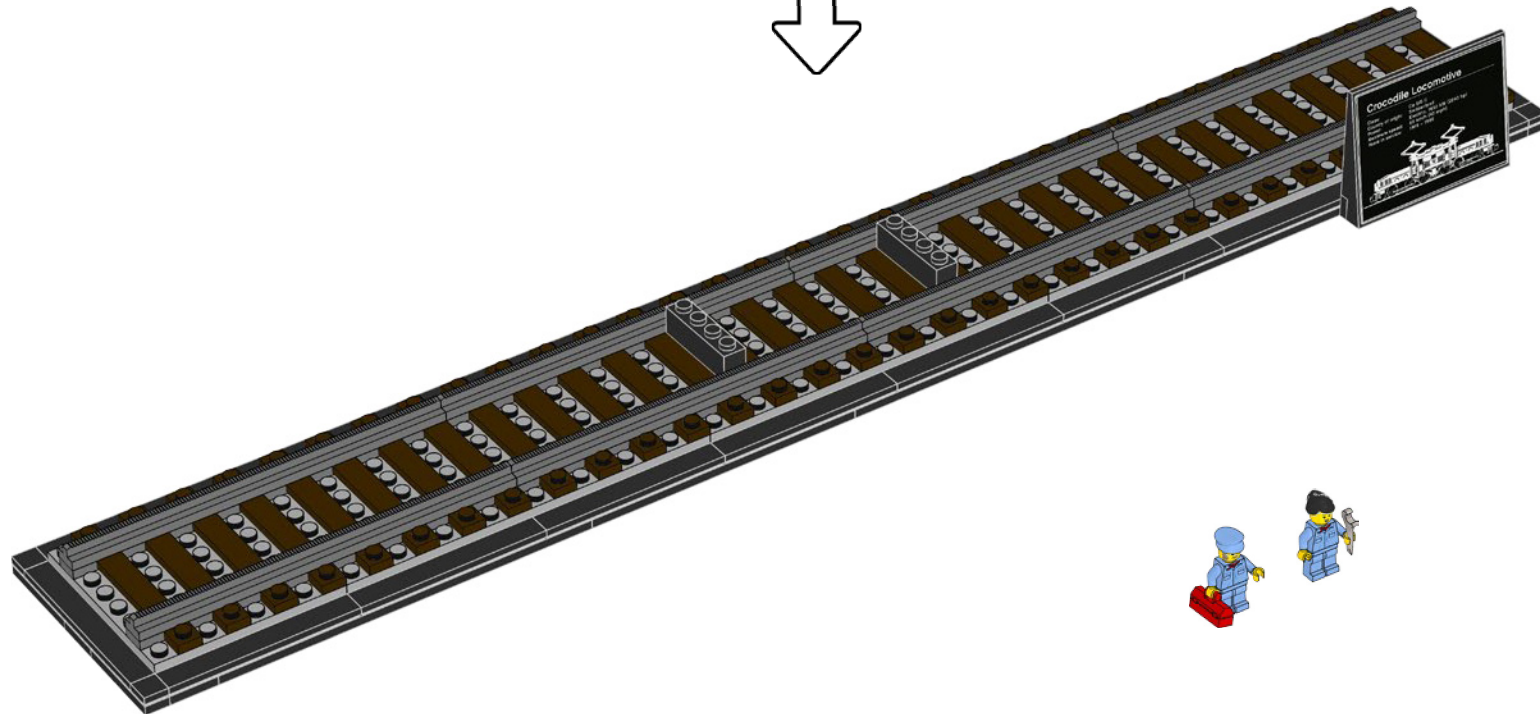
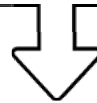

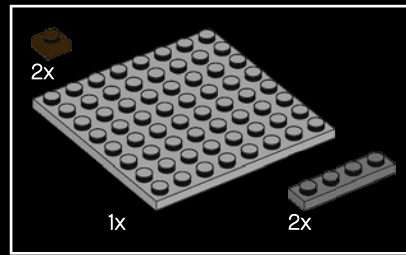
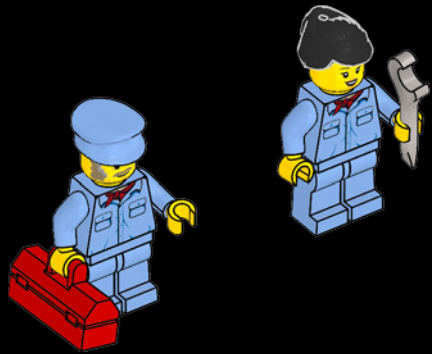

1

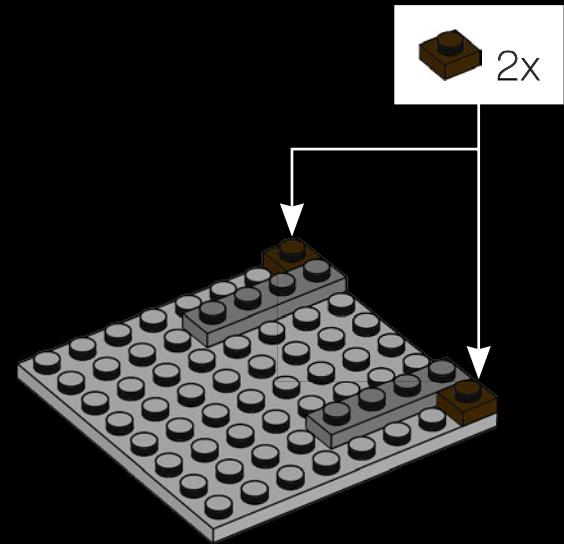

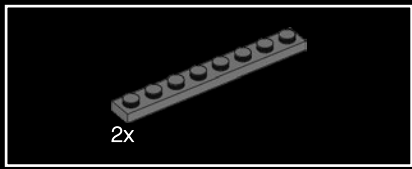

2

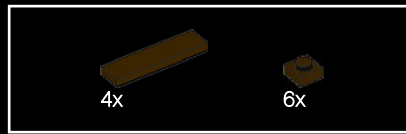
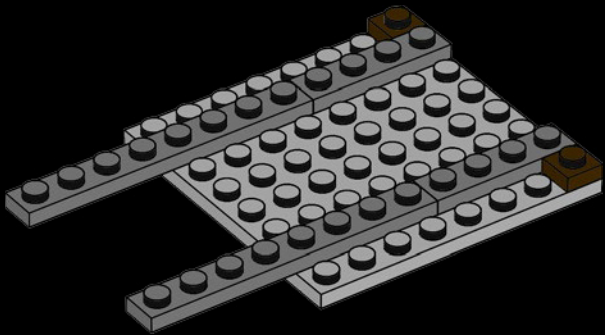

3

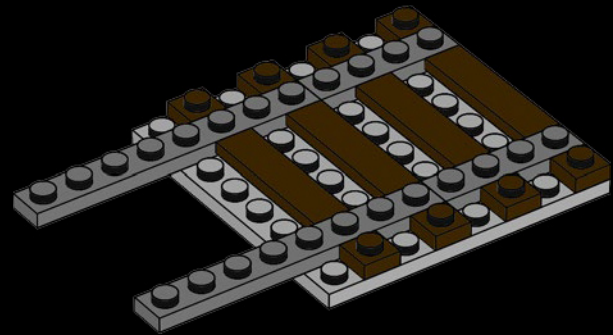

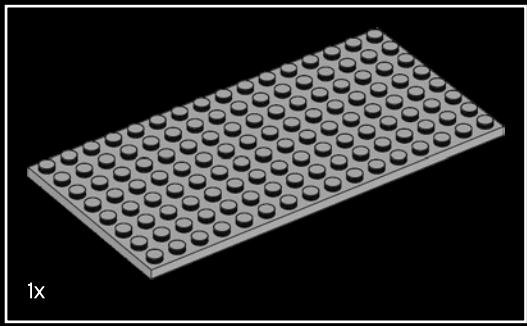

4

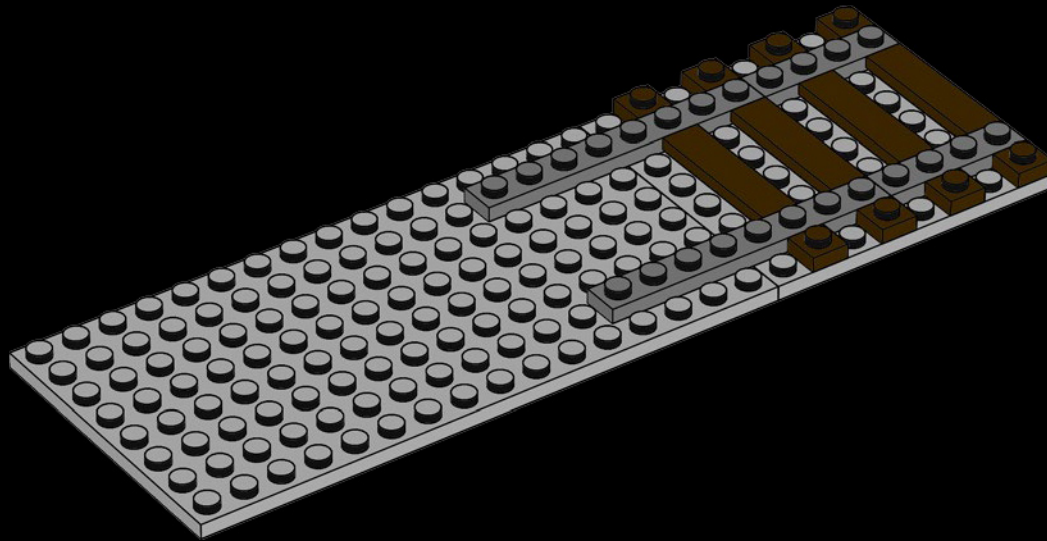

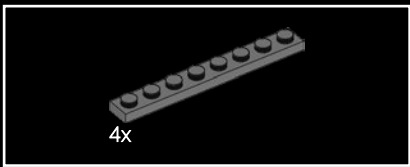

5

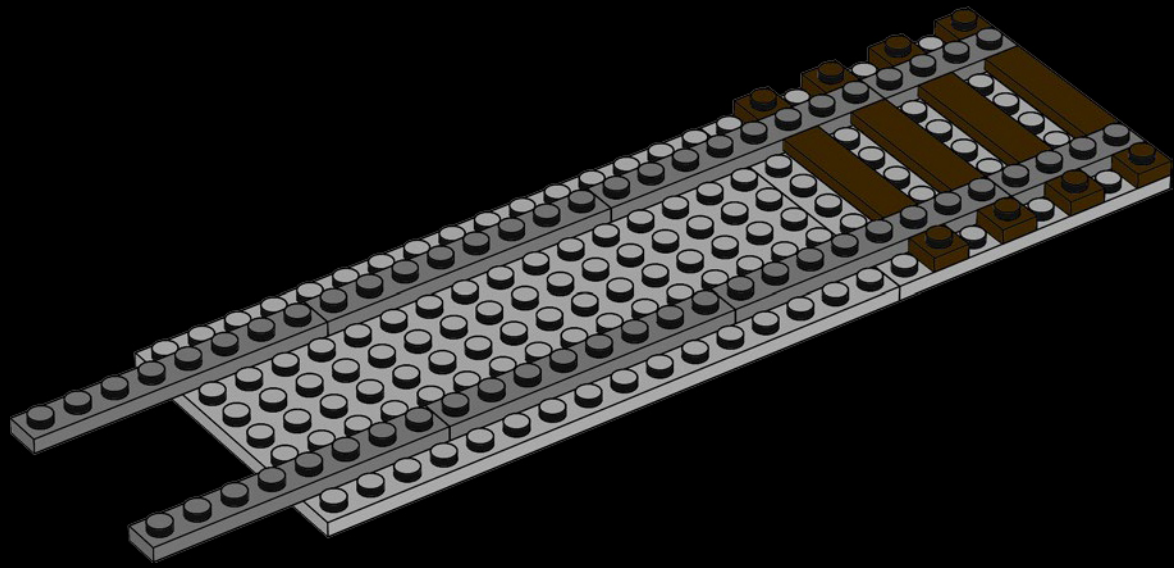

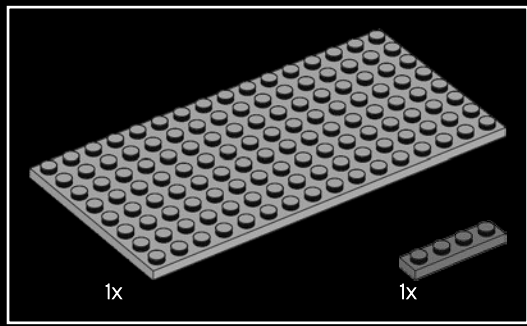

6

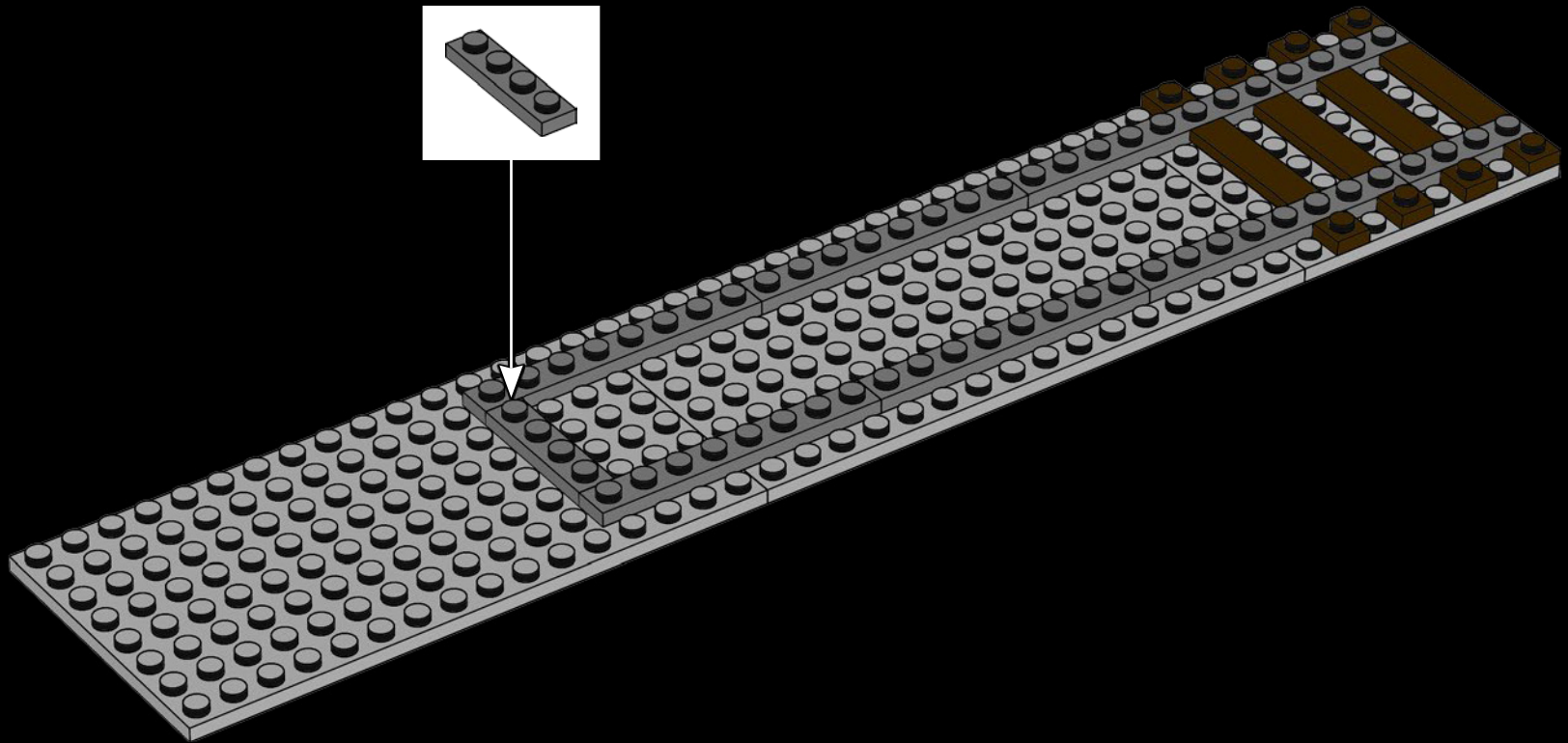
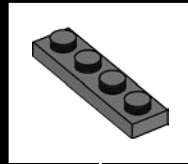

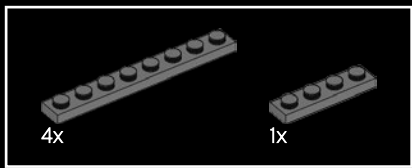

7

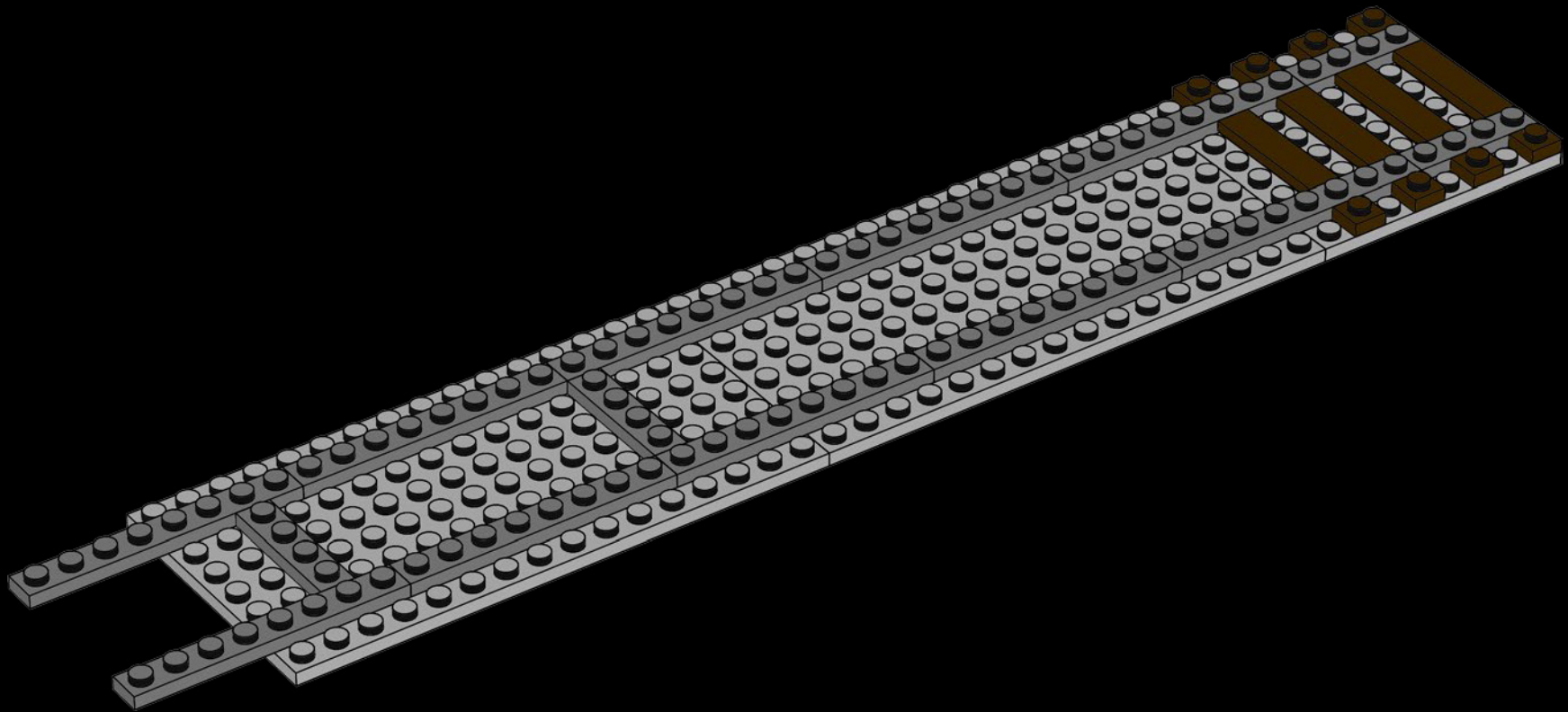

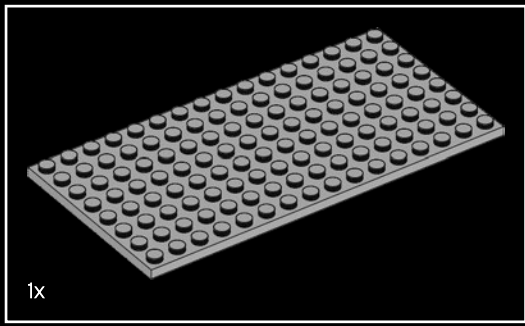

1x

8

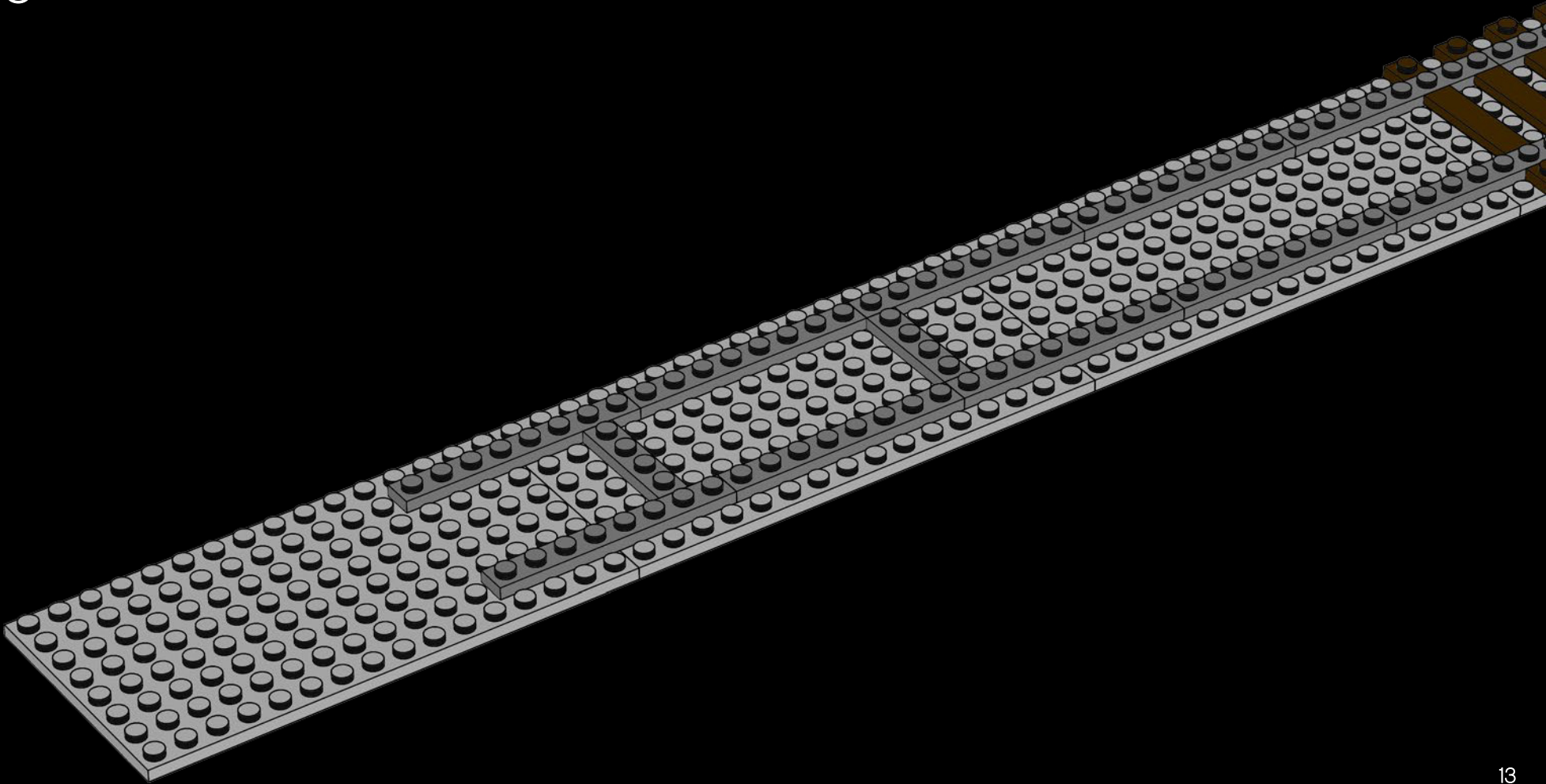

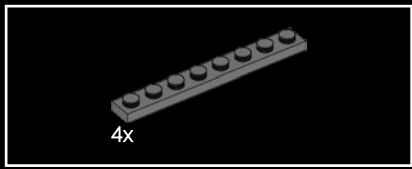

9

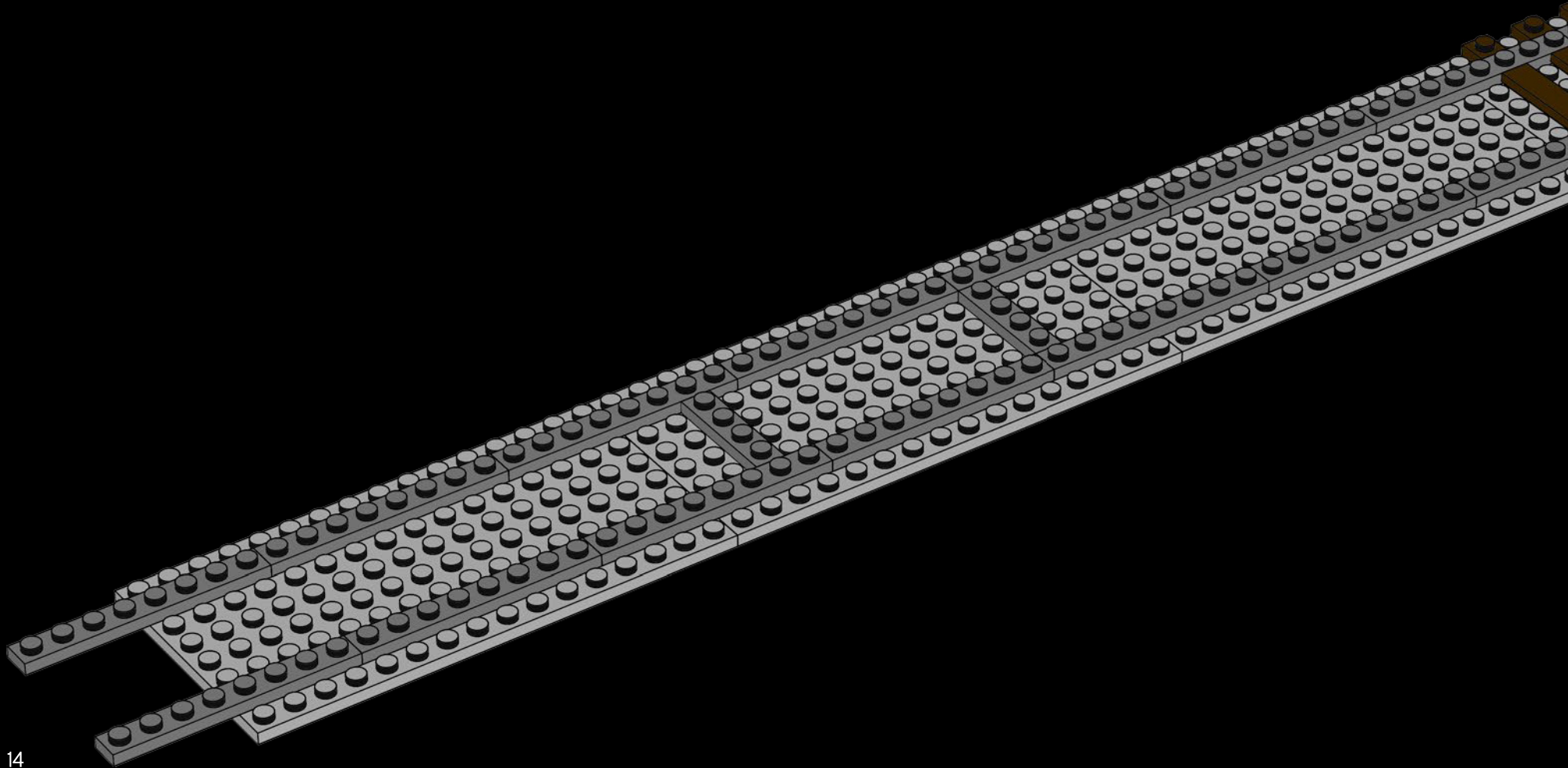

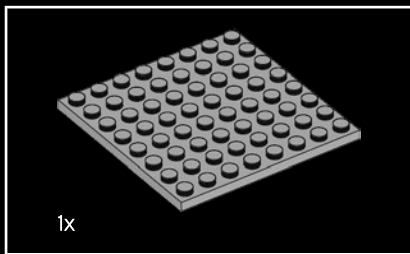

10

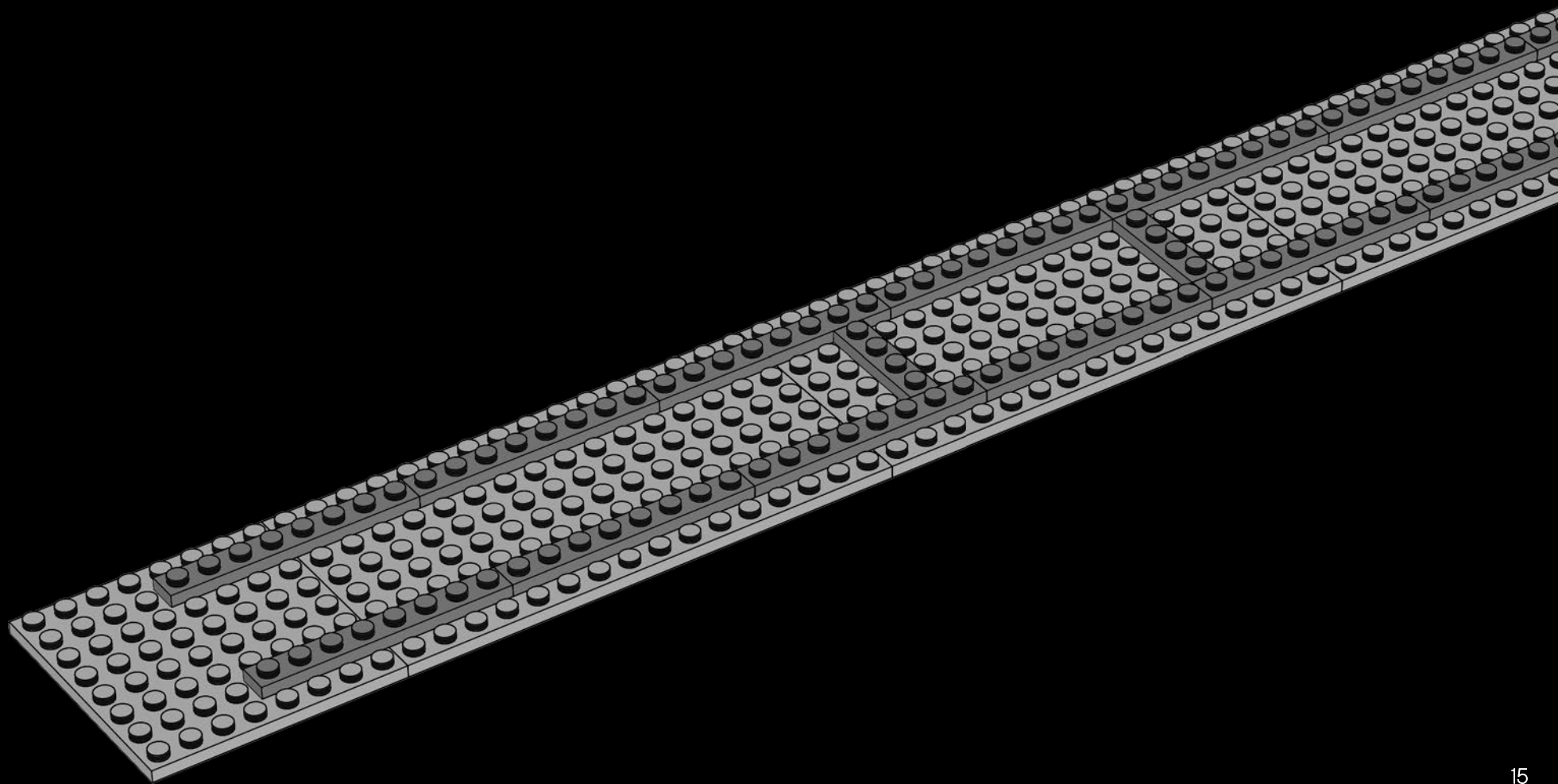

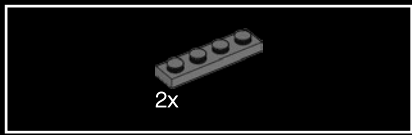

11

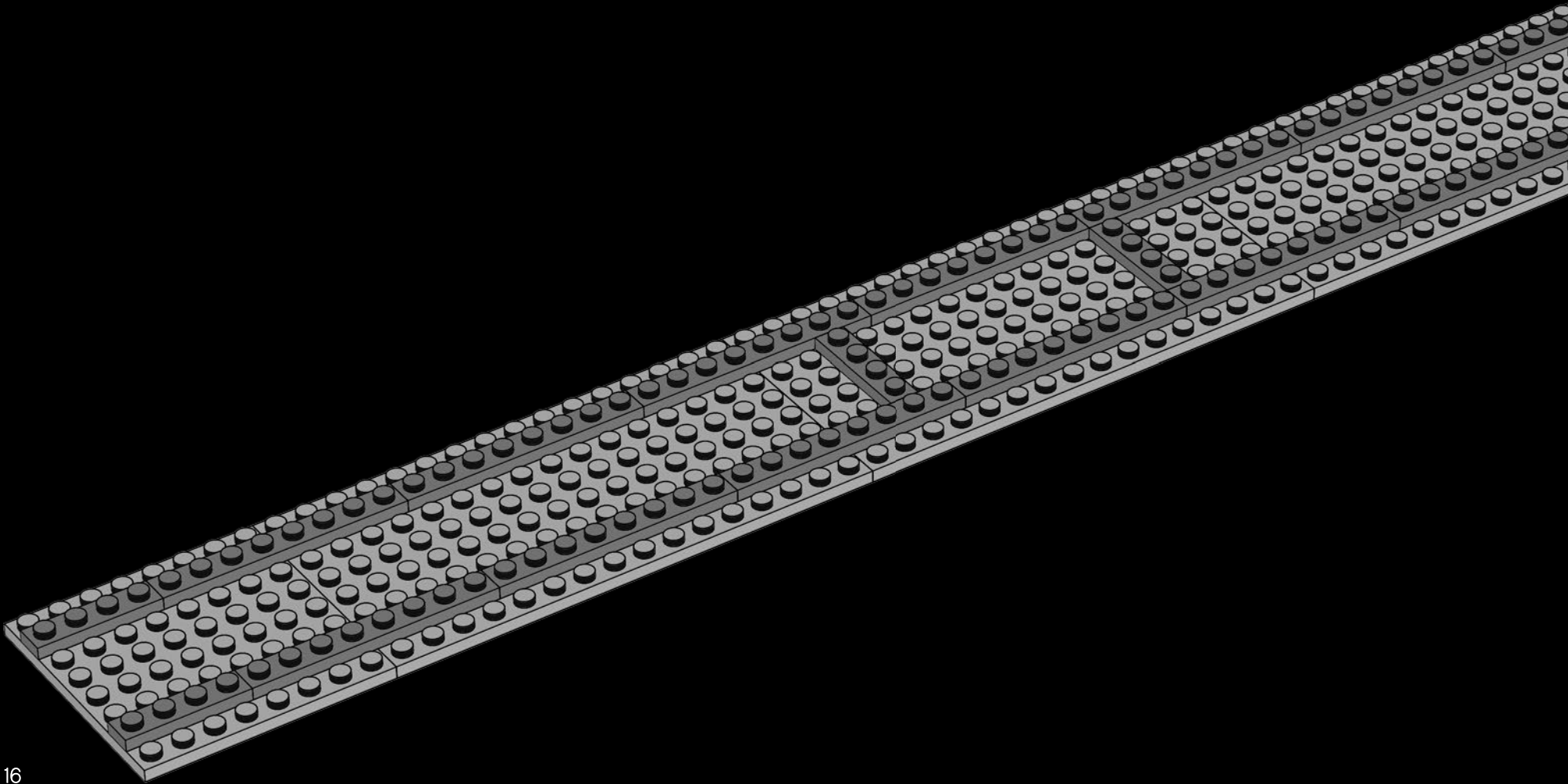

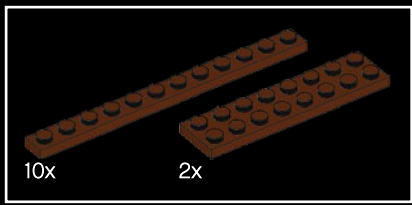

13

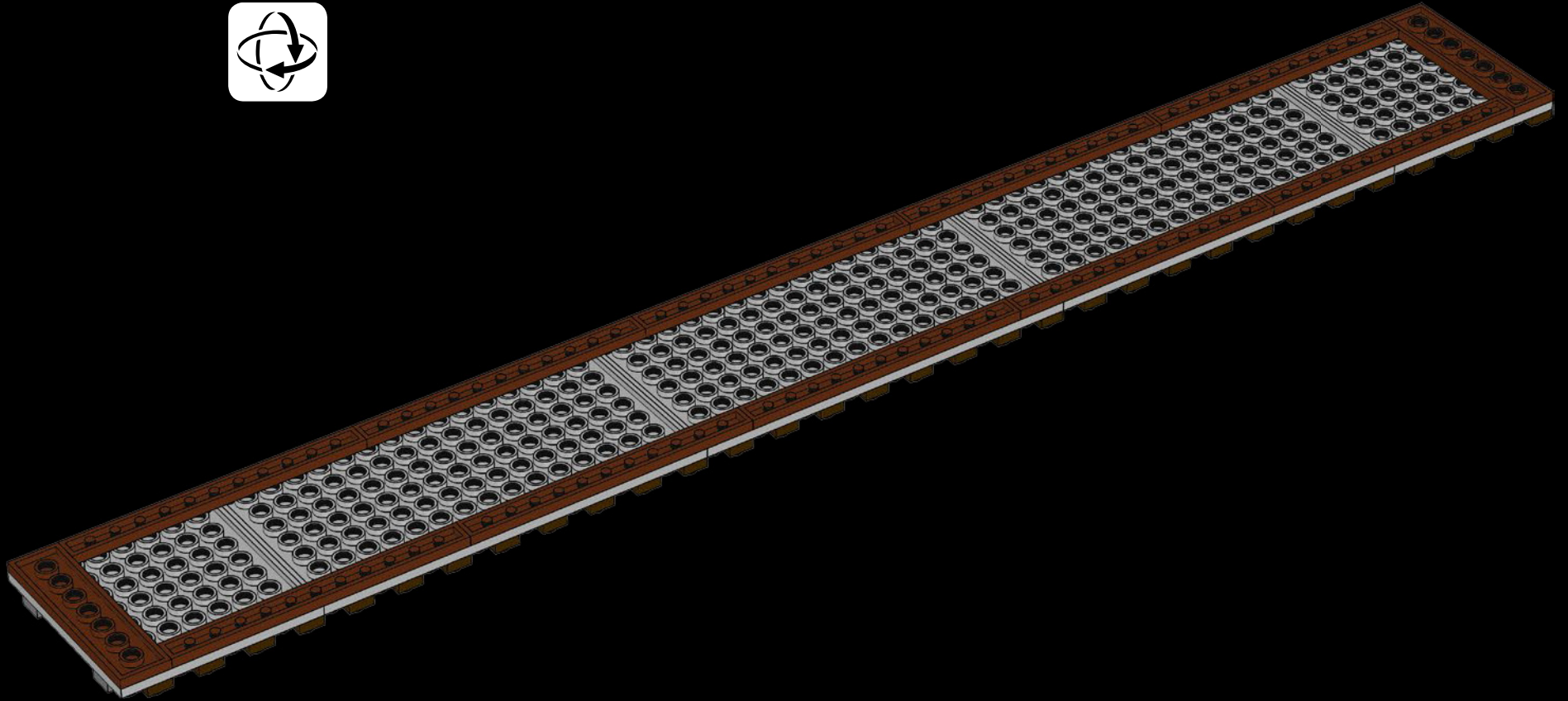

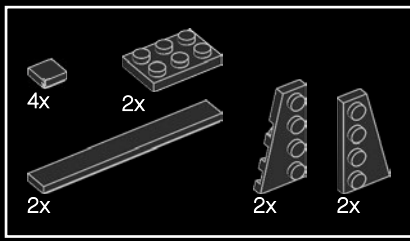

14

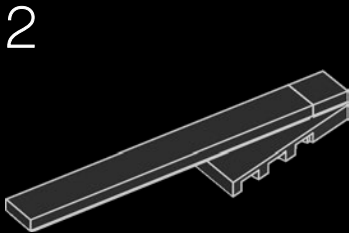
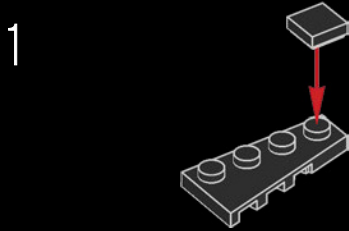

3

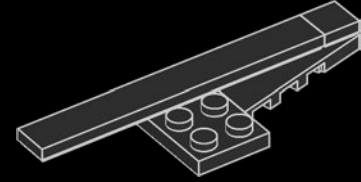

4

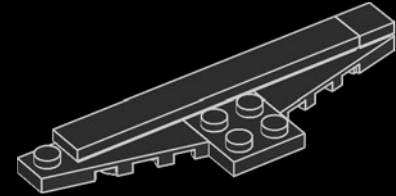

5

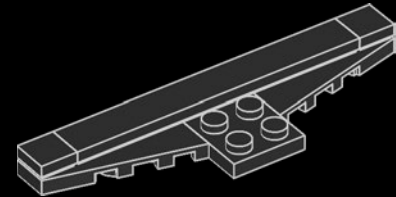

2x

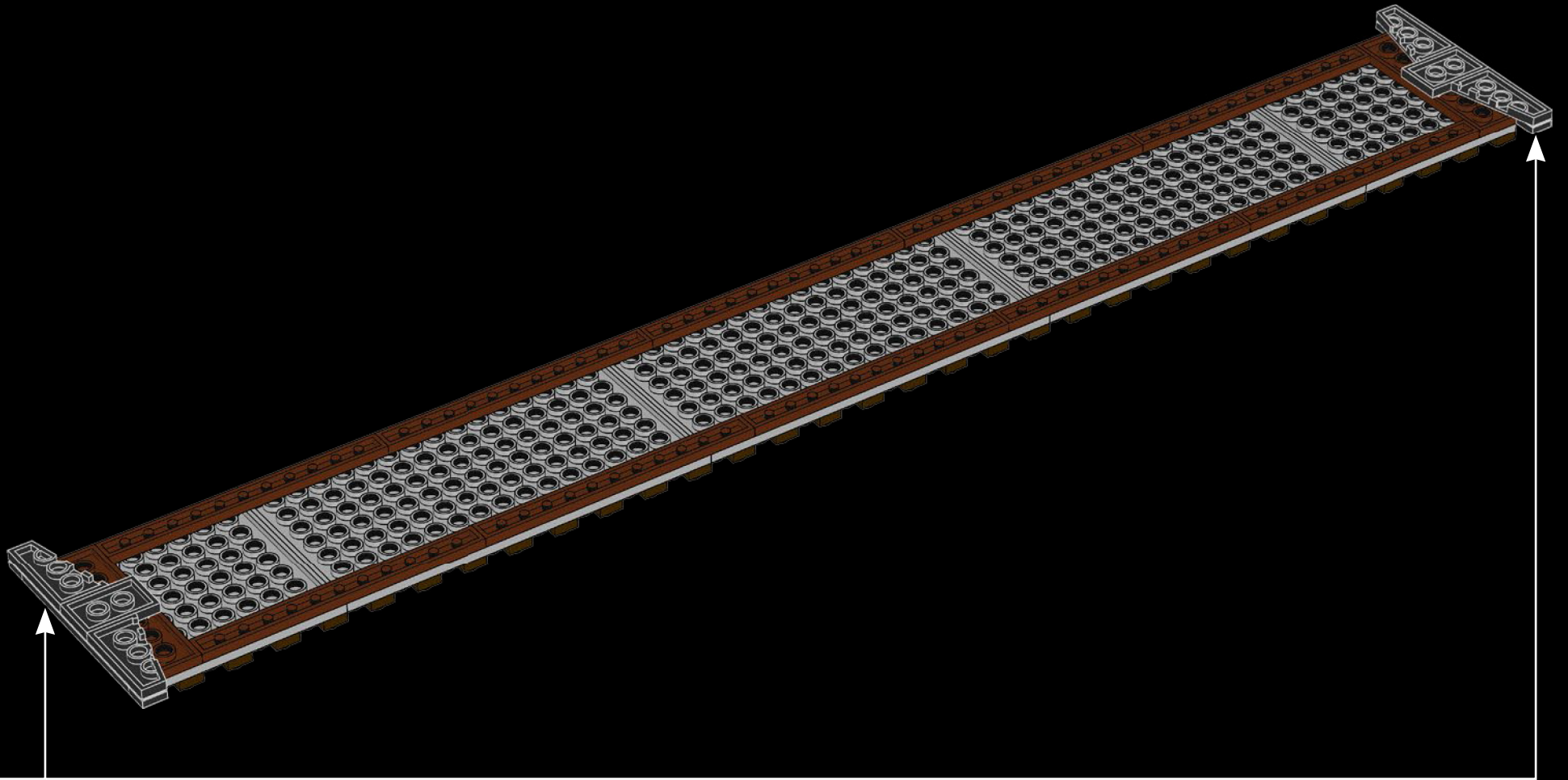

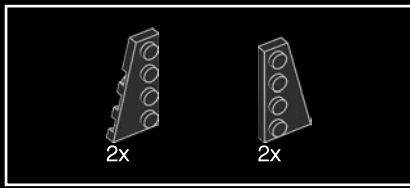

15

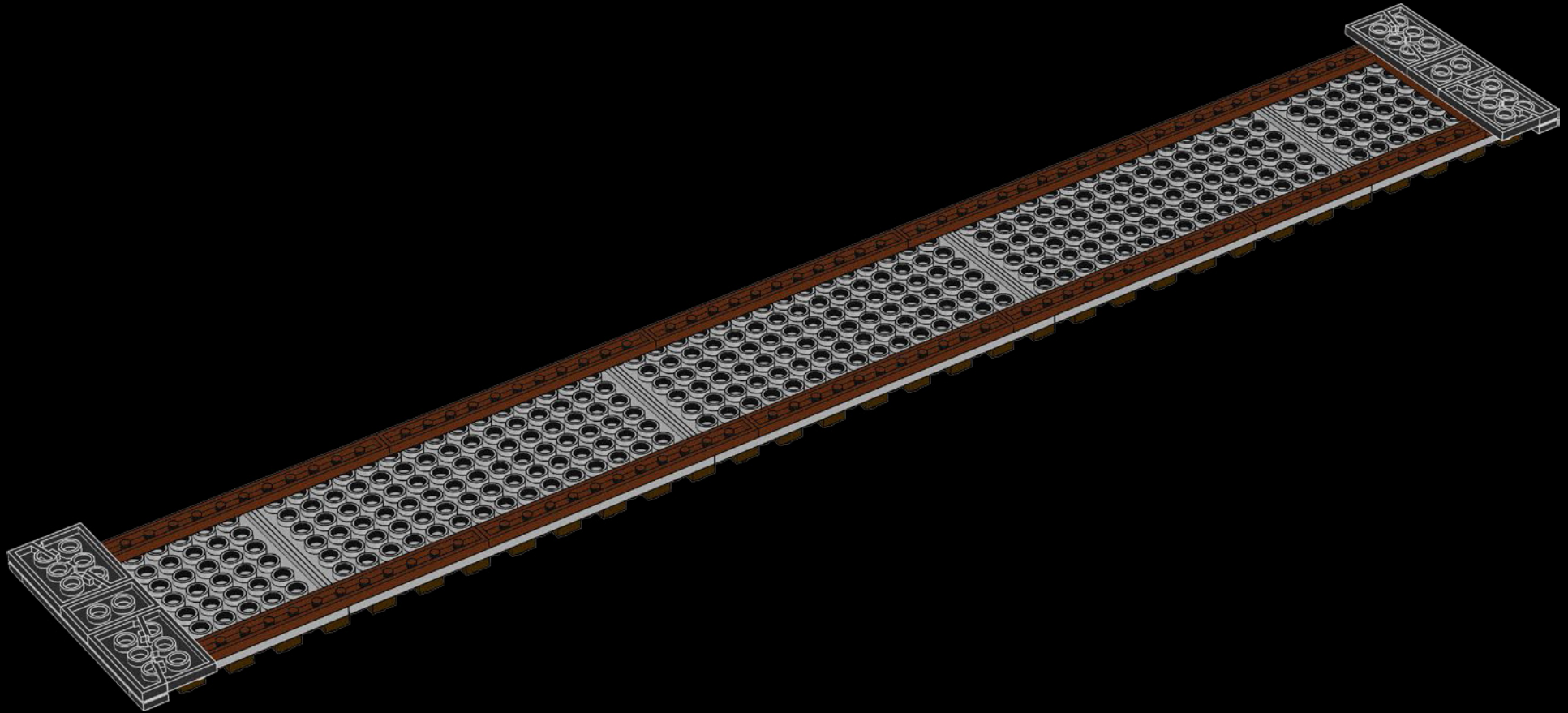

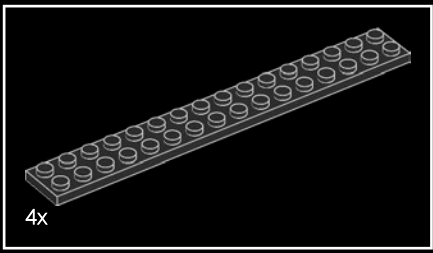

16

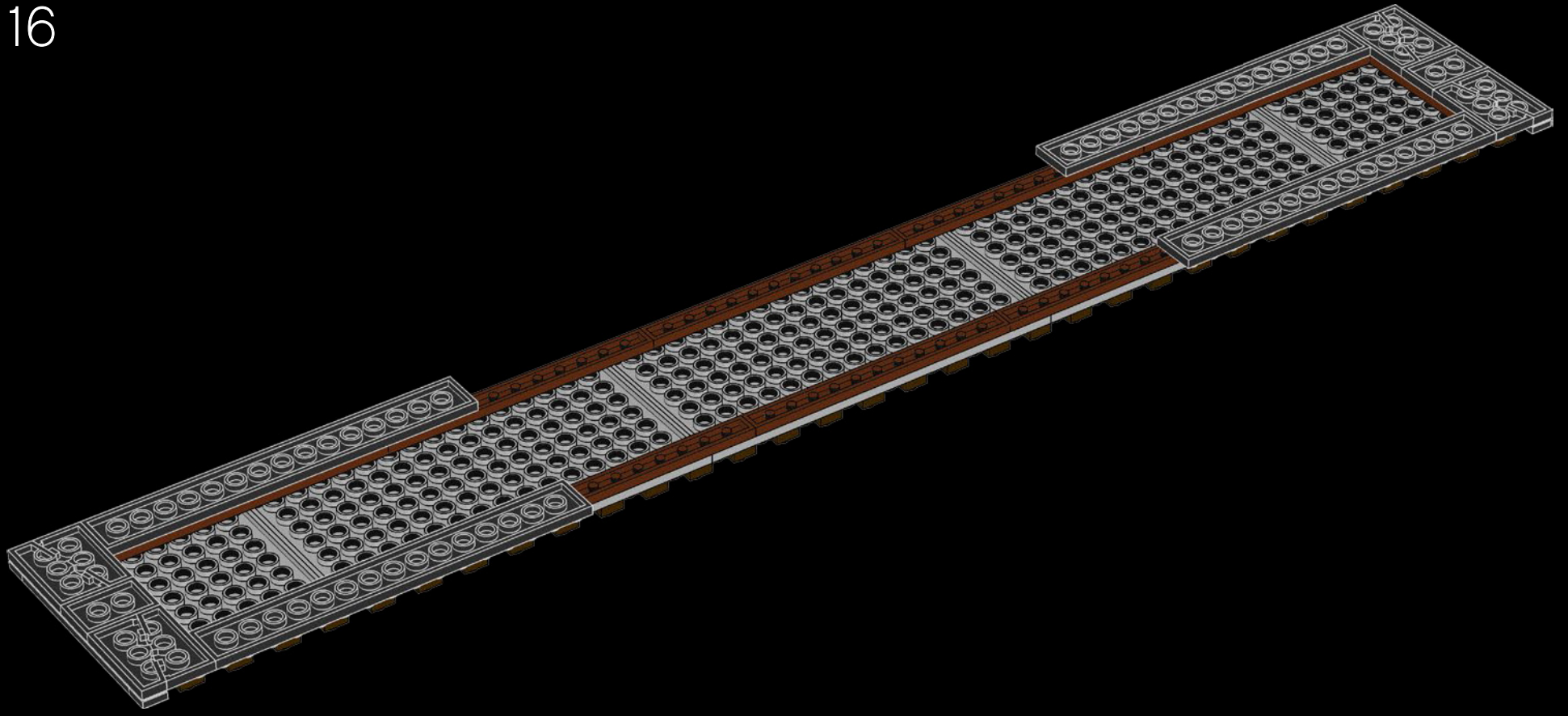

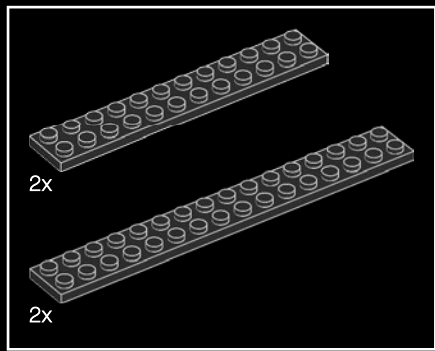

17

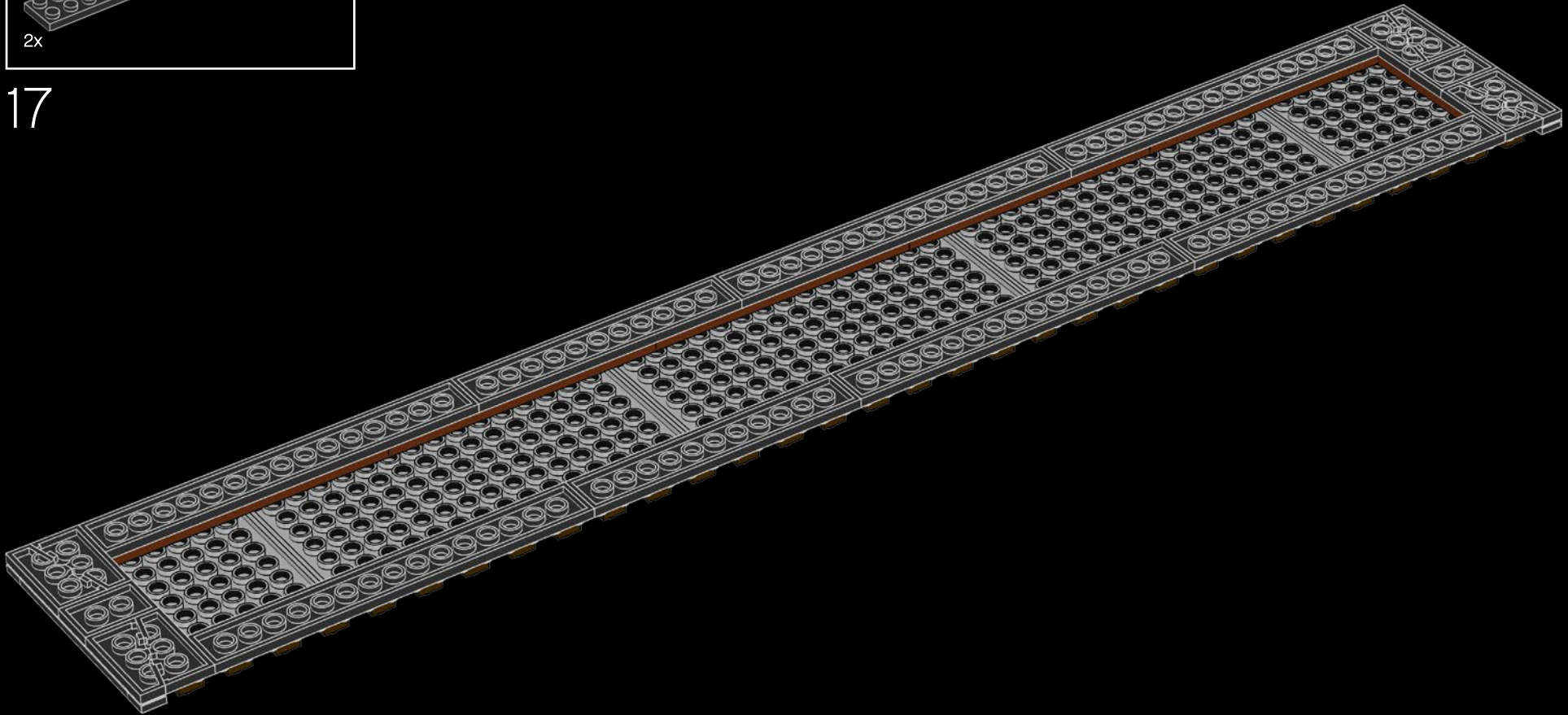

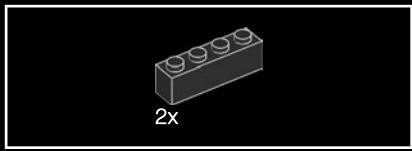

18

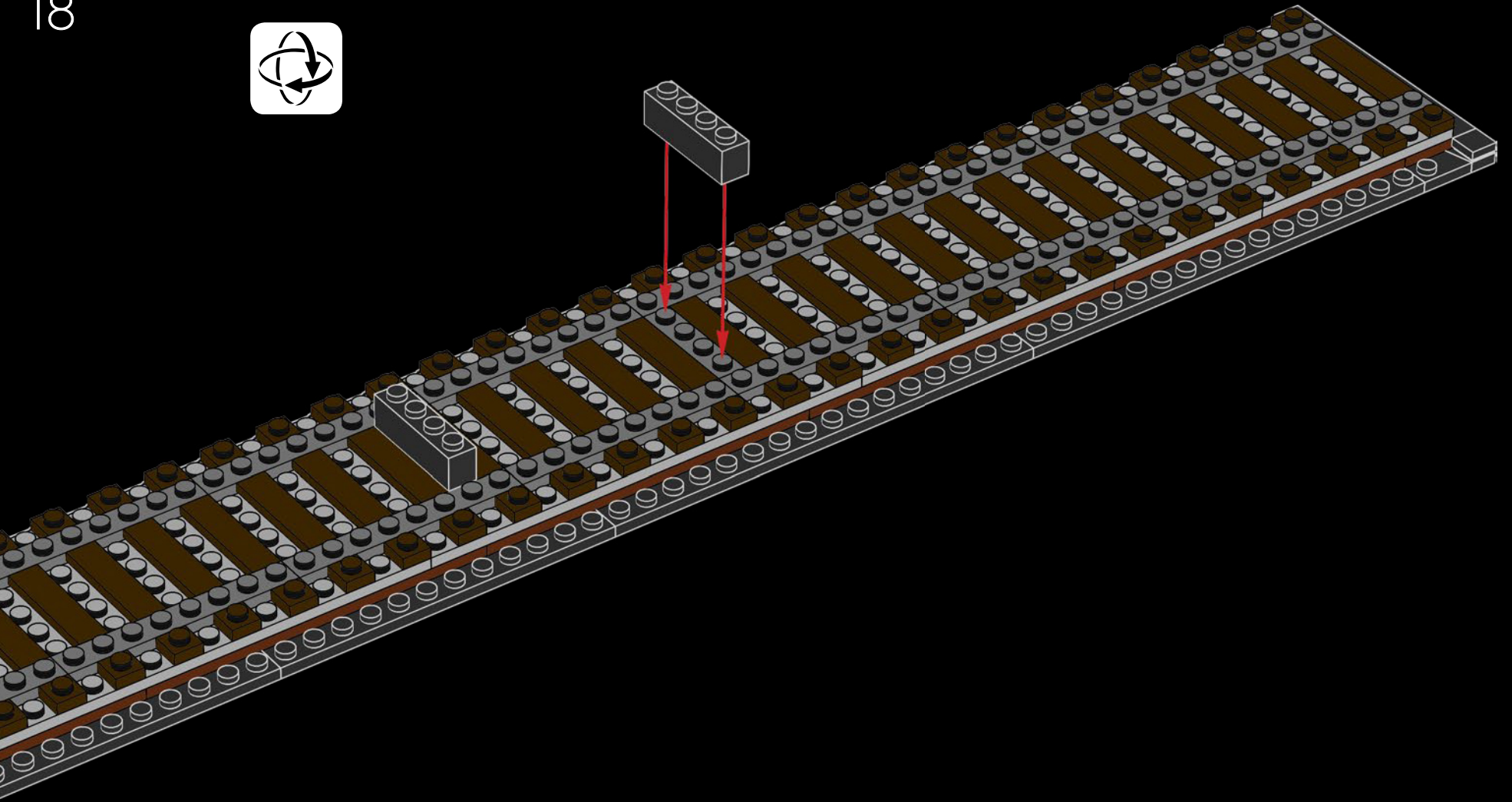

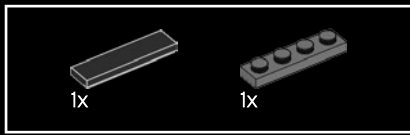

19

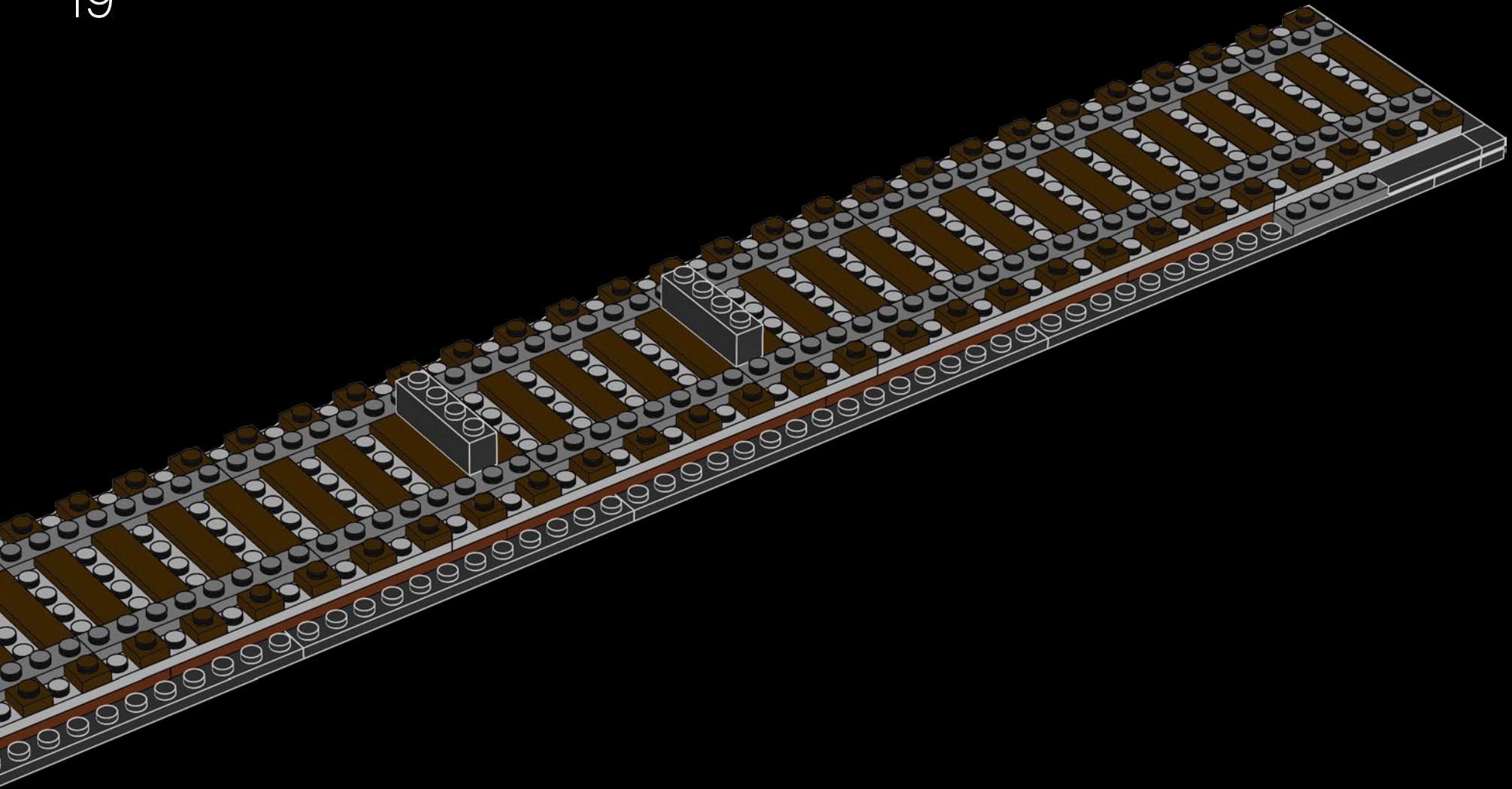

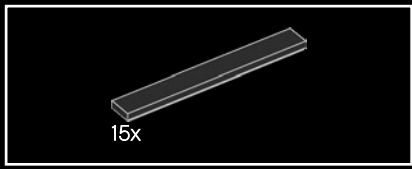

20

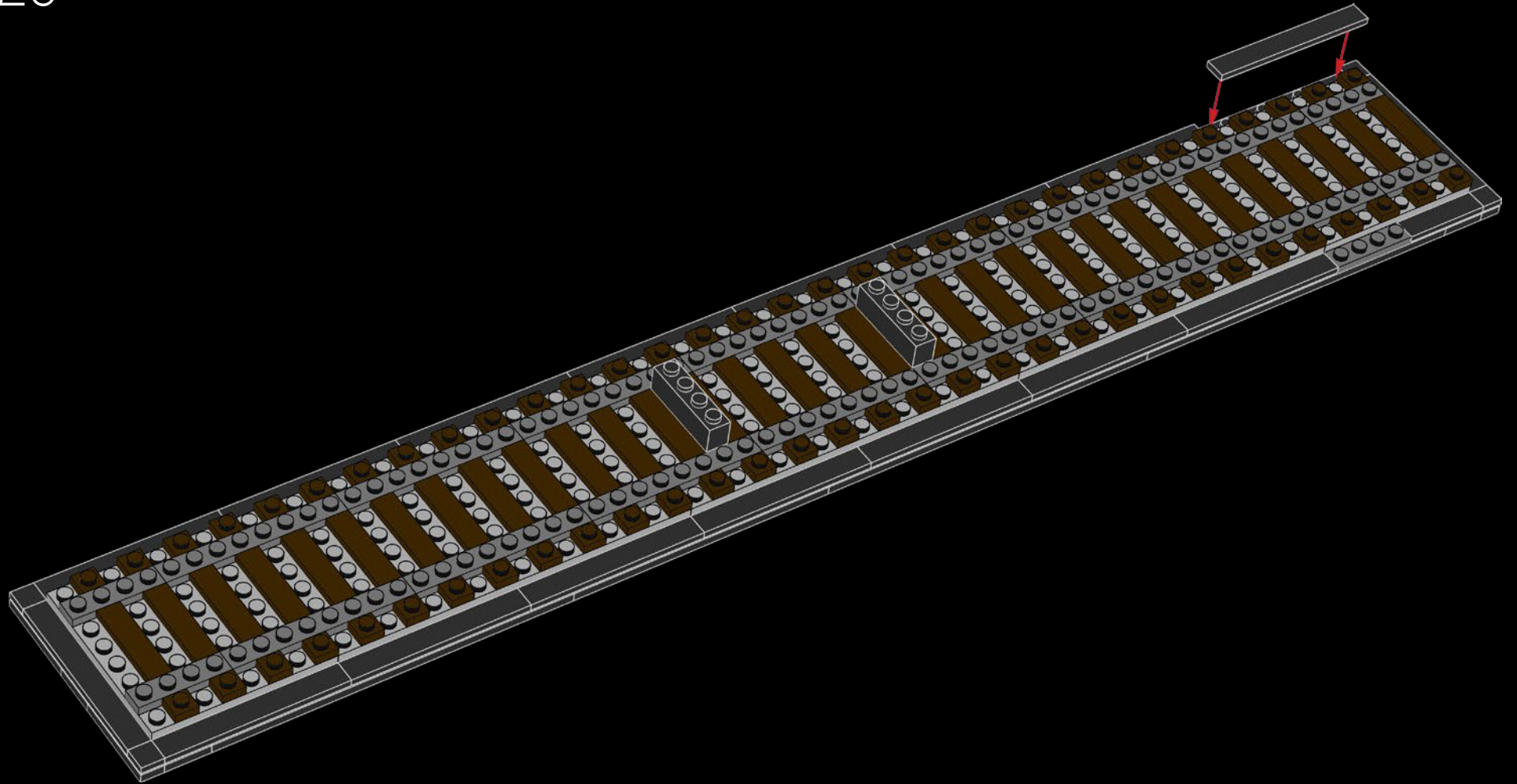

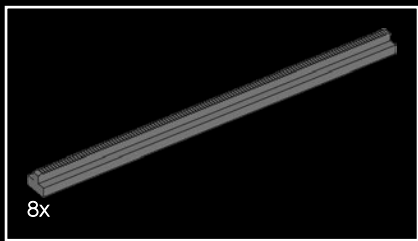

21

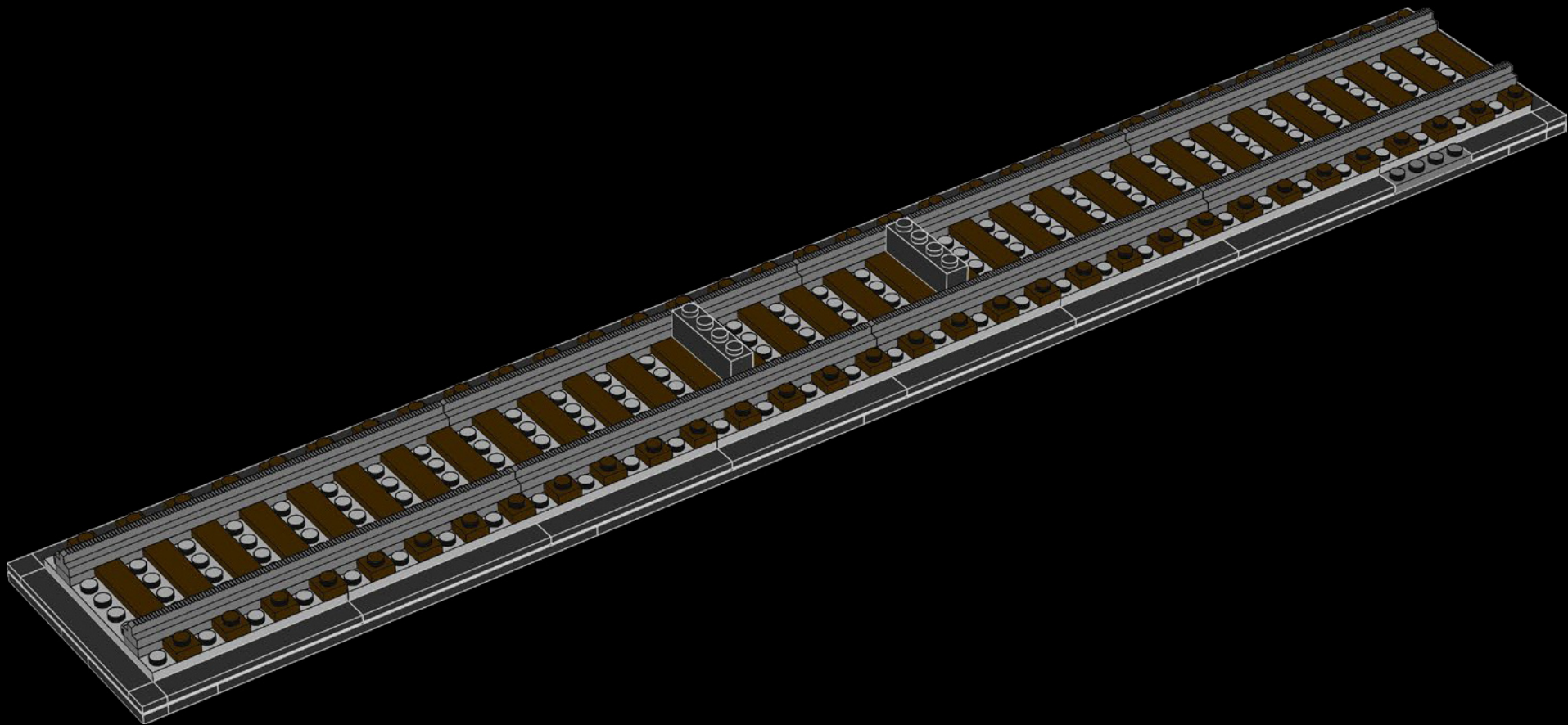

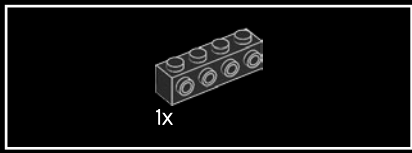

22

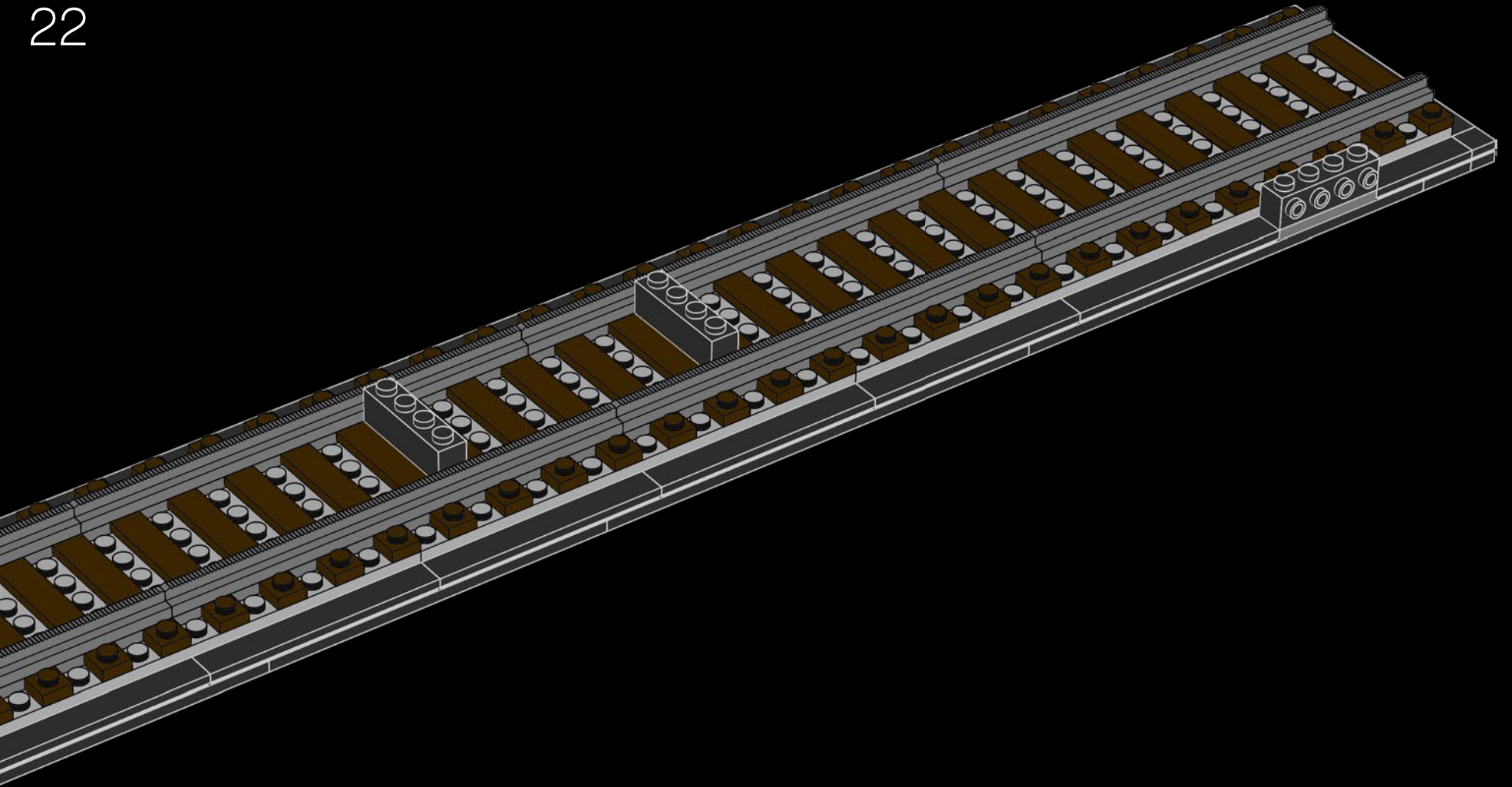

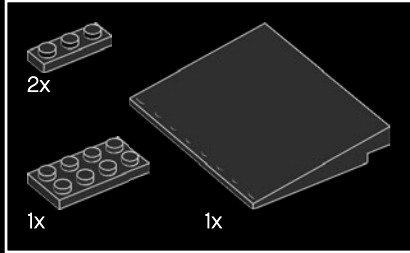

23

1

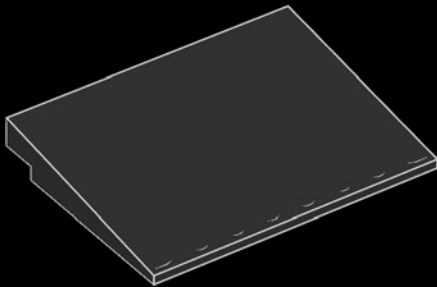

2

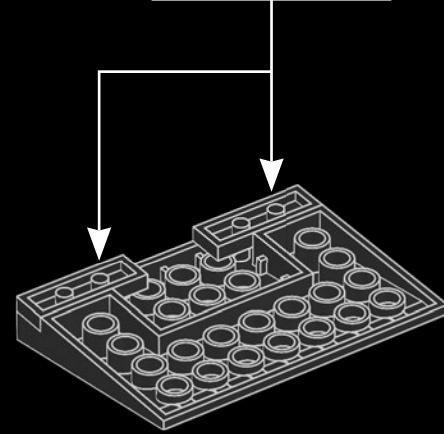
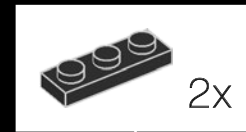

3

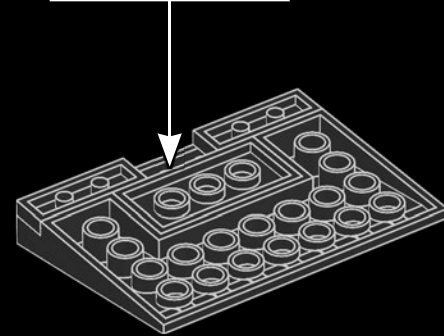
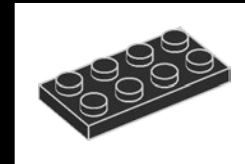



4

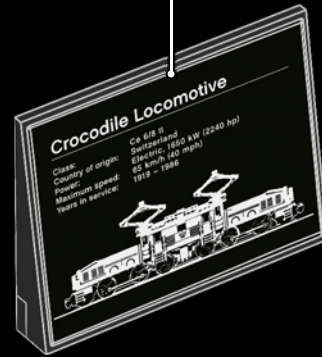

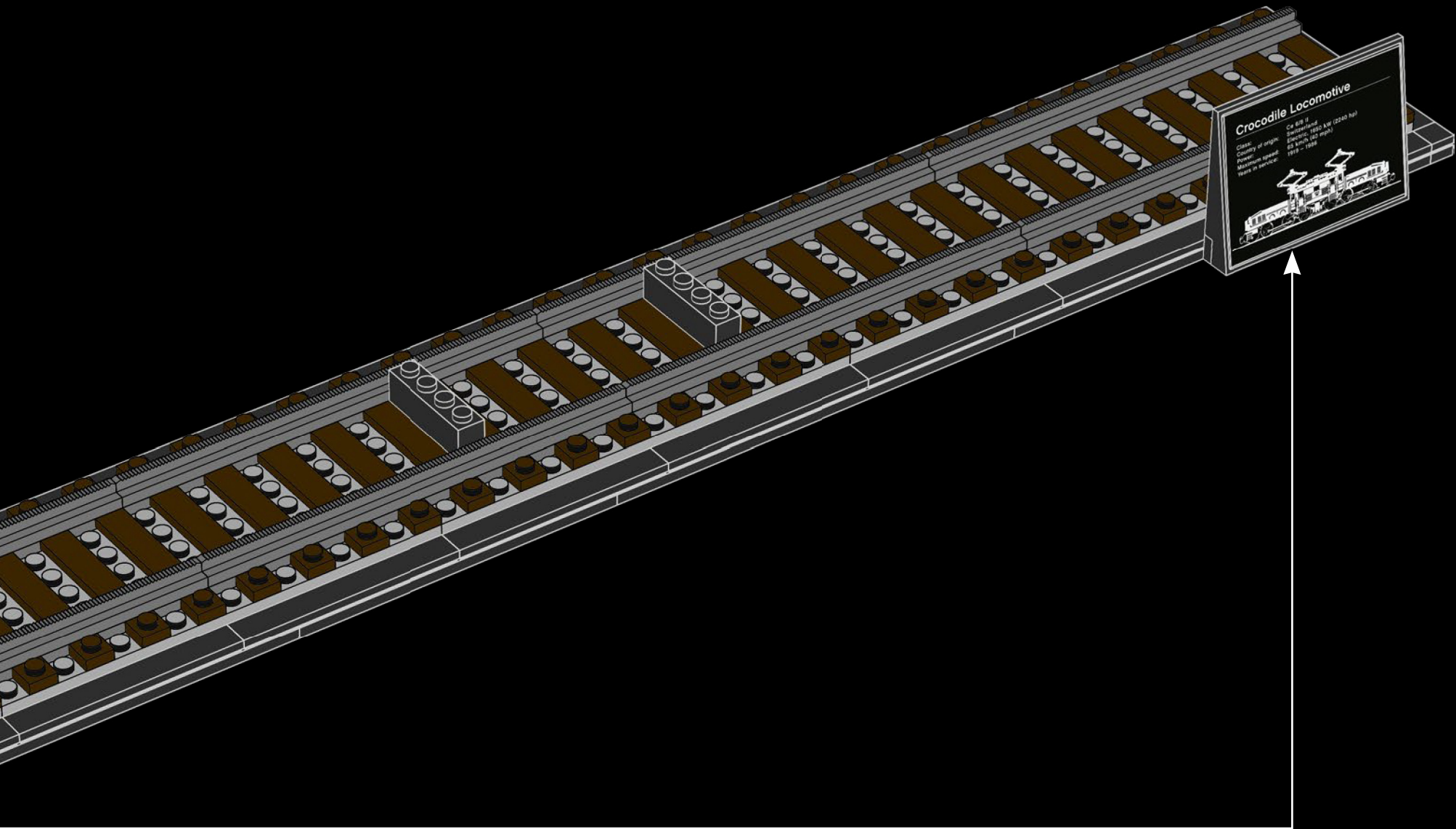

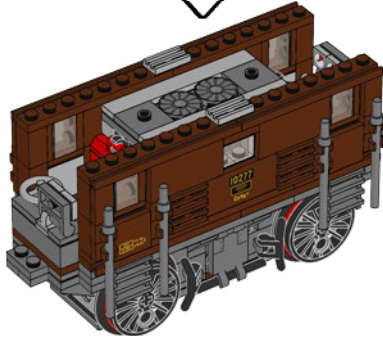
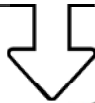

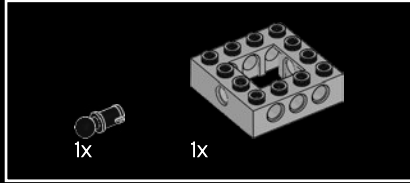
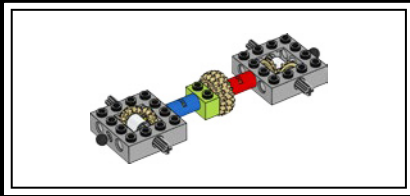

1

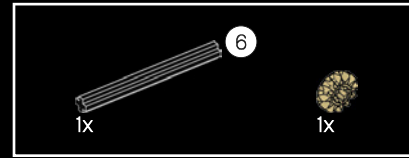
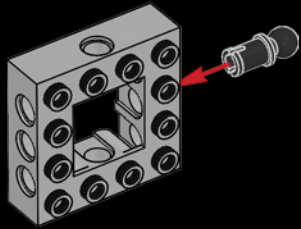

2

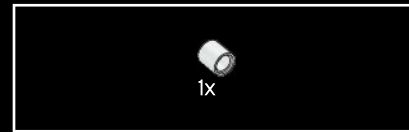
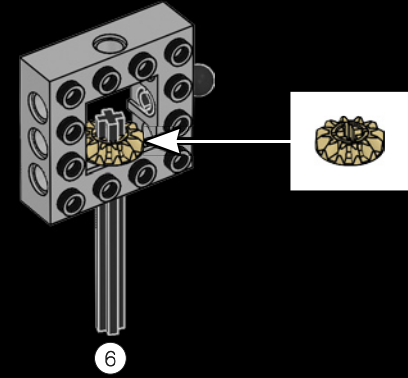

3

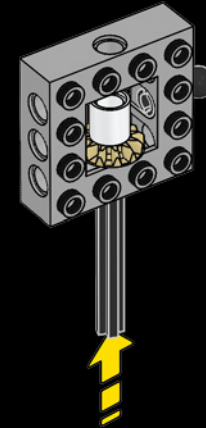

4

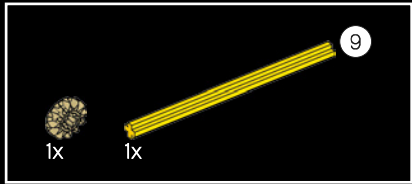
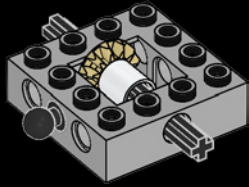

5

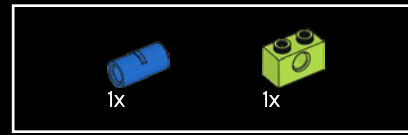
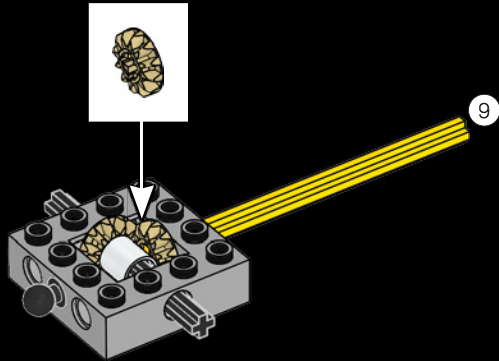

6

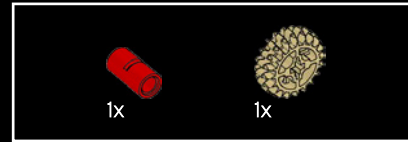
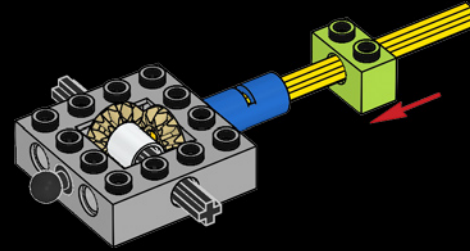

7

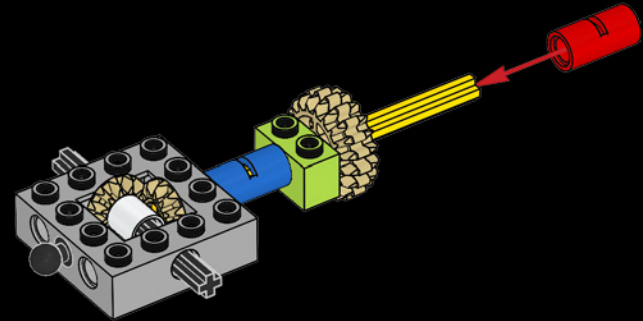

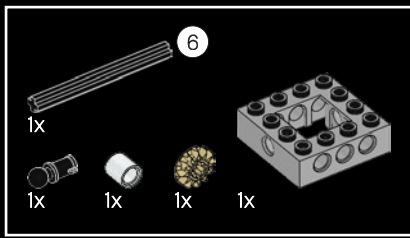

8

1

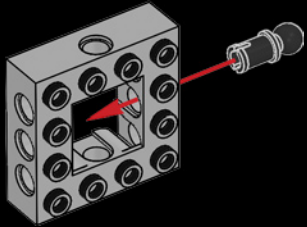

2

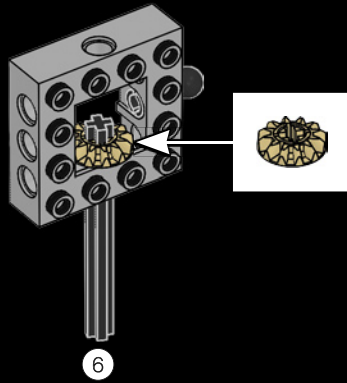

3

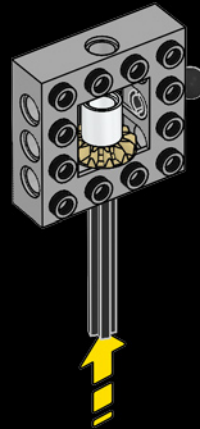

4

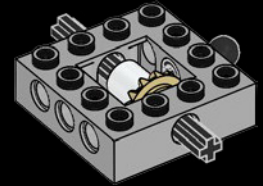

1x

9

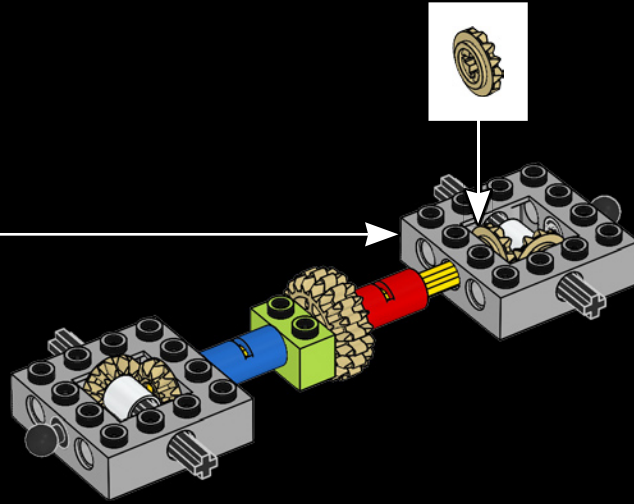

10

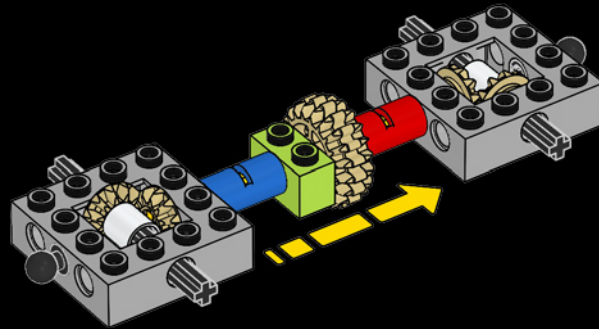

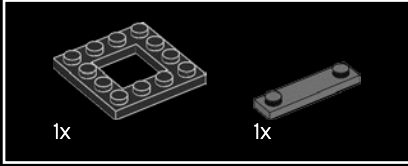
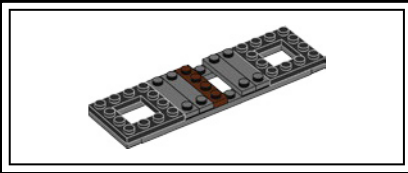

11

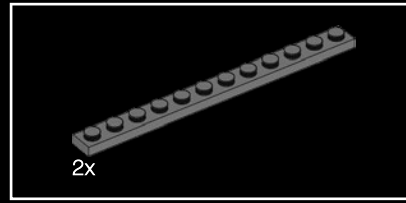
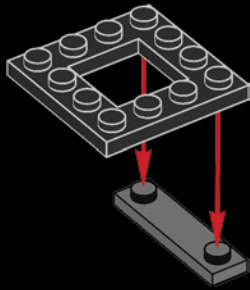

12

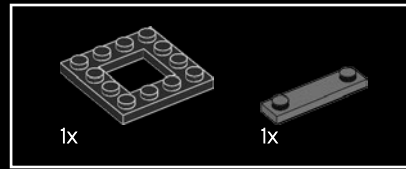
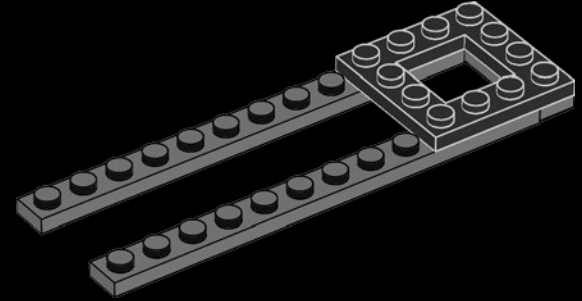

13

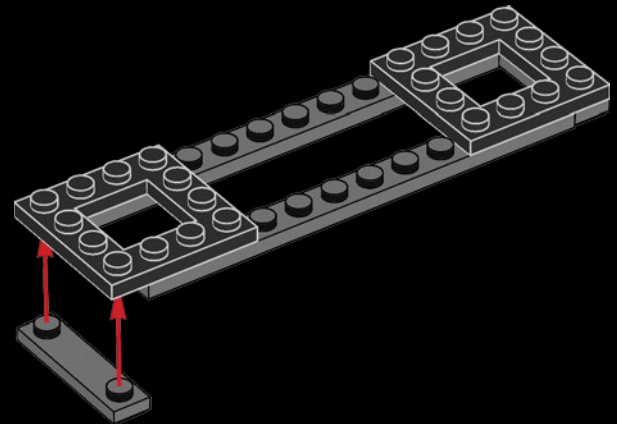



14

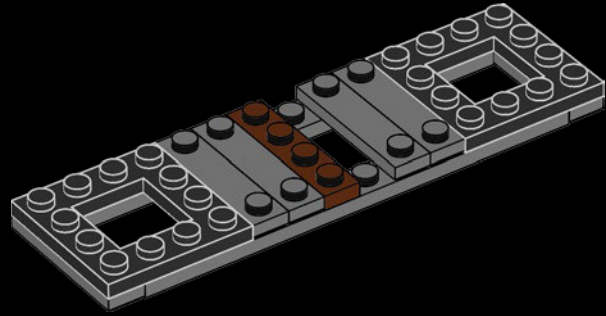

15

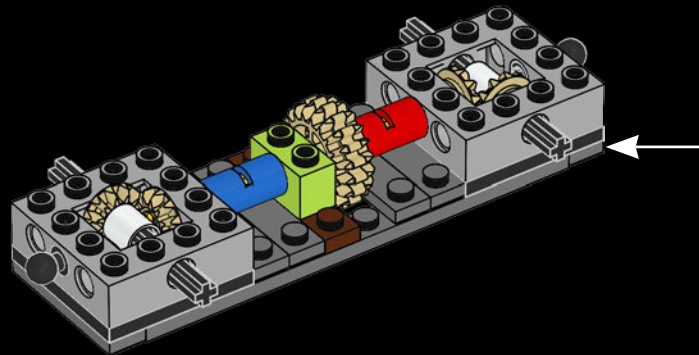

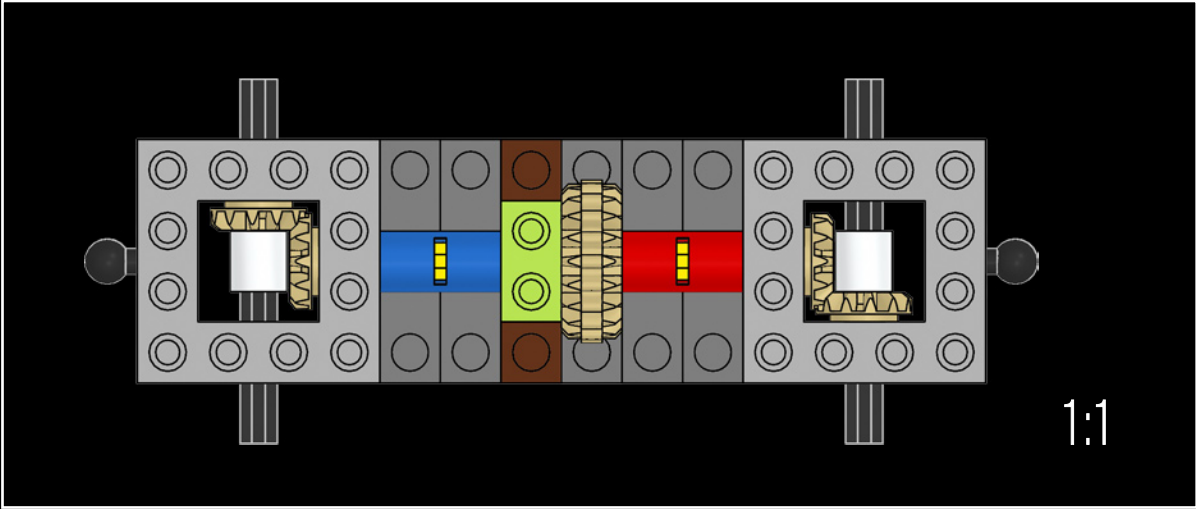



4x

16

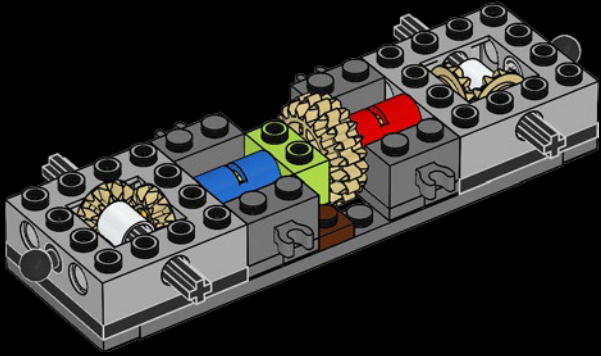

2x

18

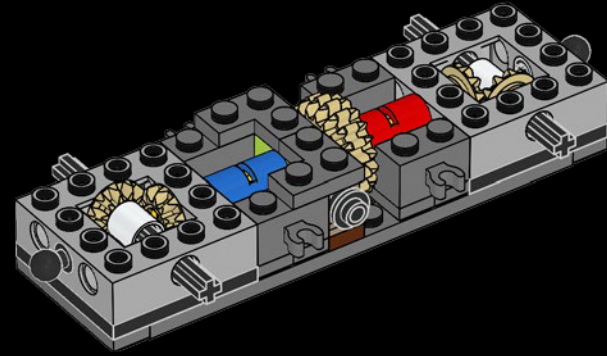

2x



2x

17

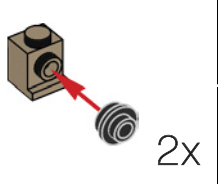

2x

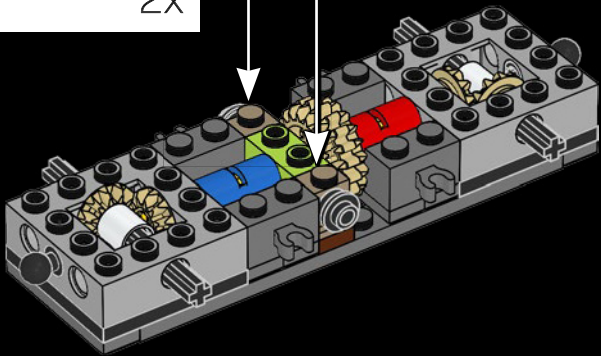

1x



2x

19

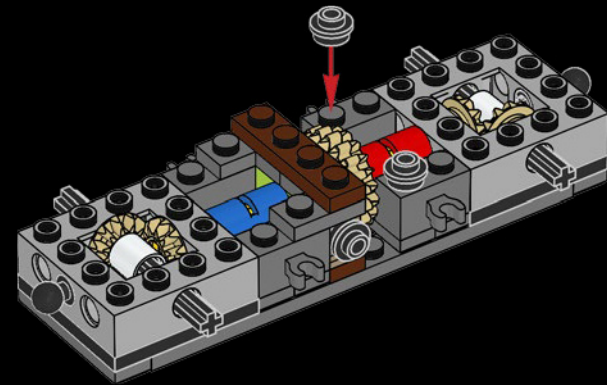

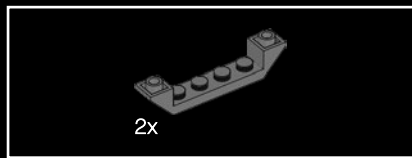

20

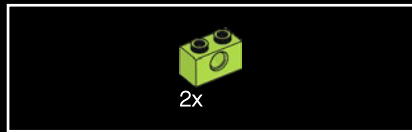
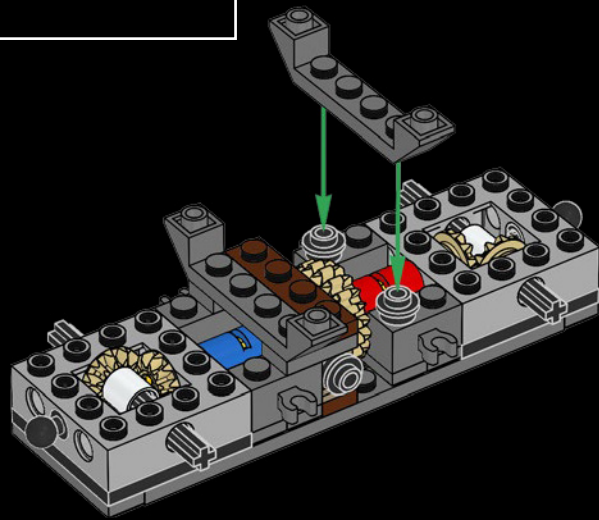

21

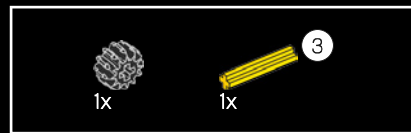
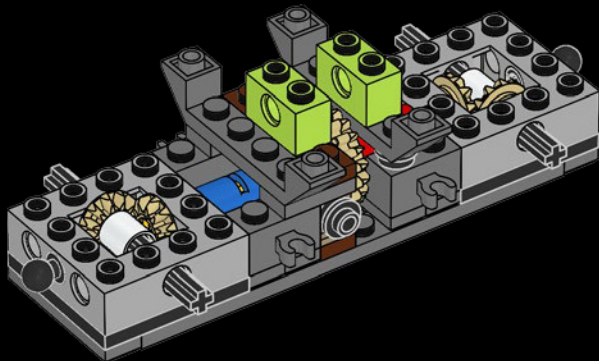

22

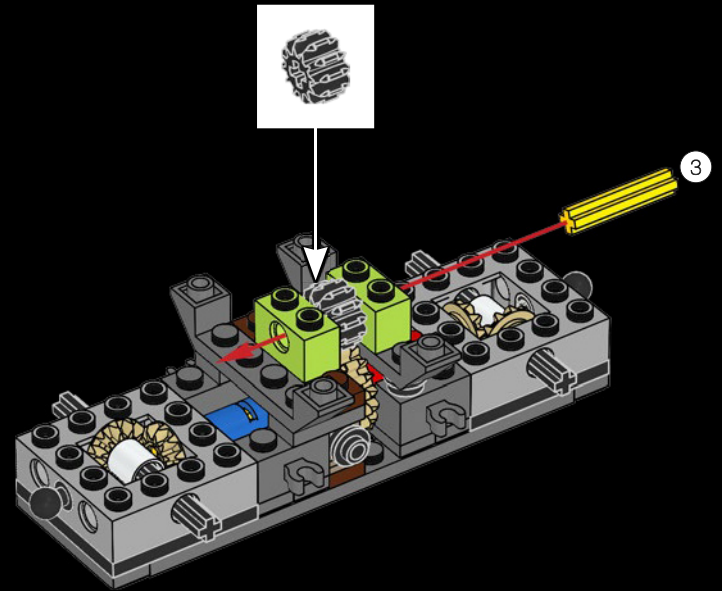

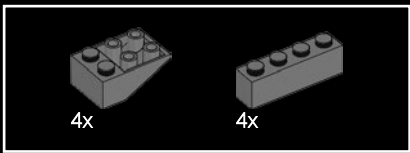

23

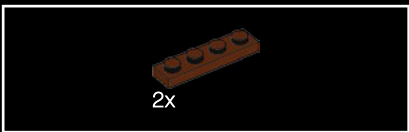
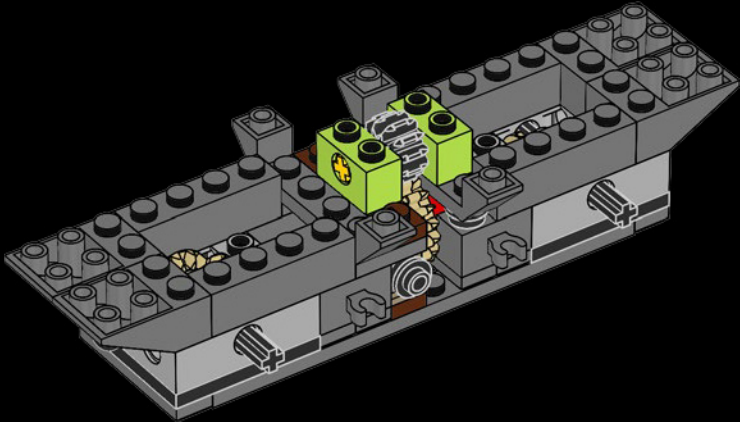

24

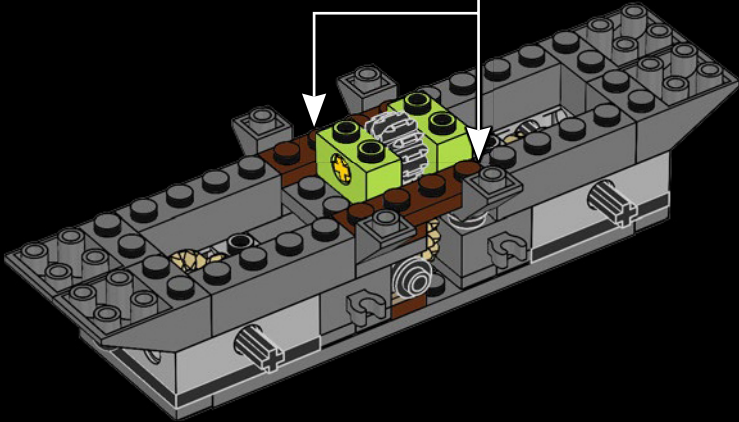
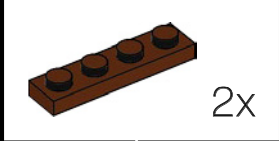

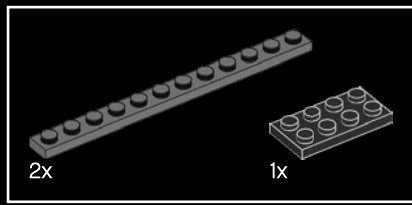

25

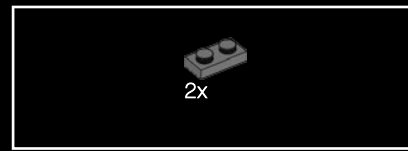
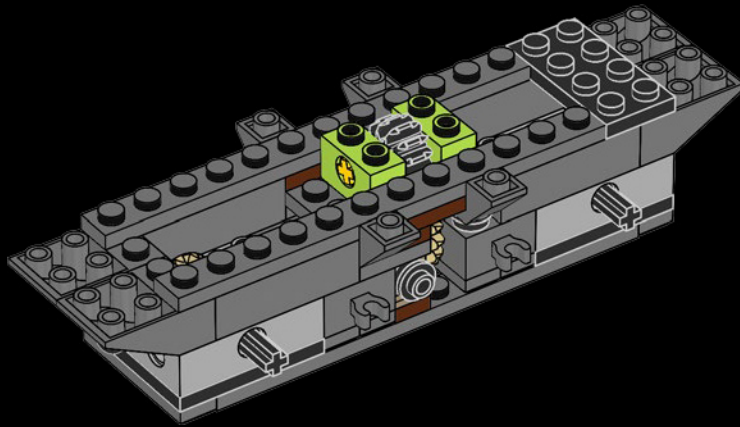

26

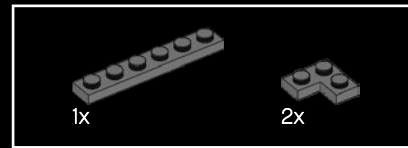
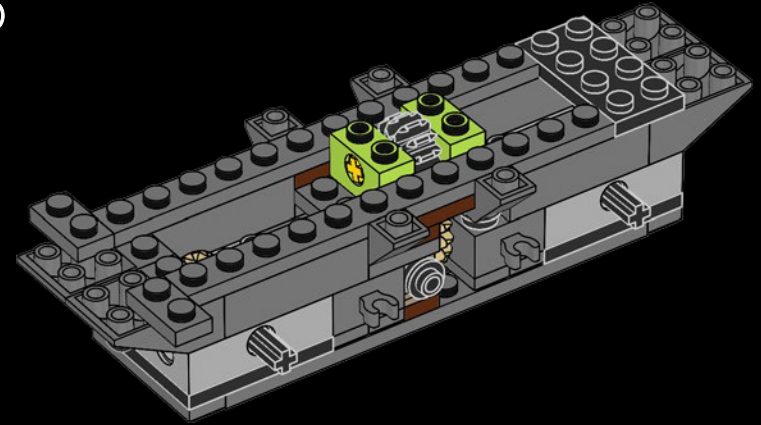

27

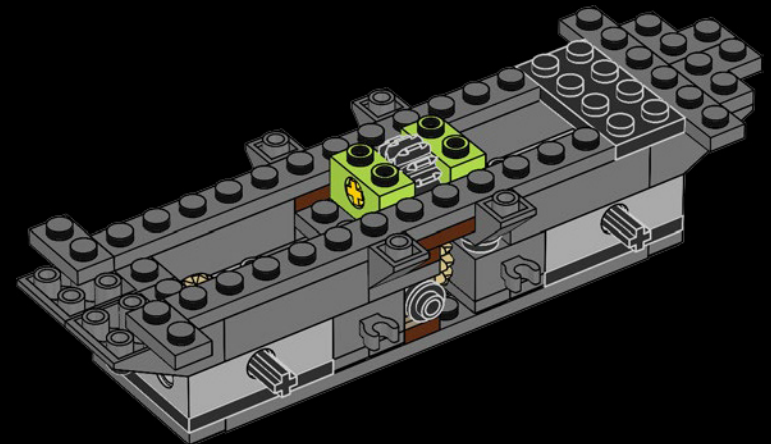



28

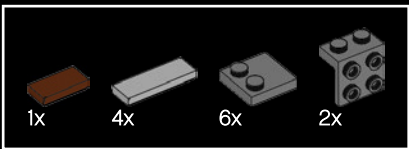
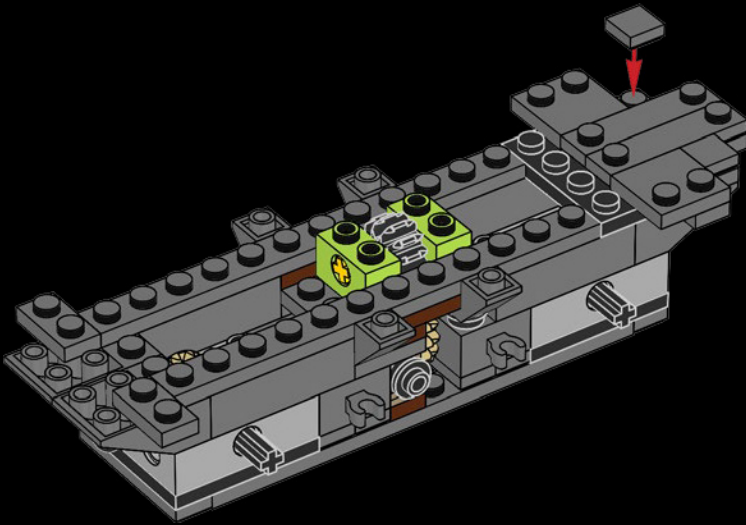

29

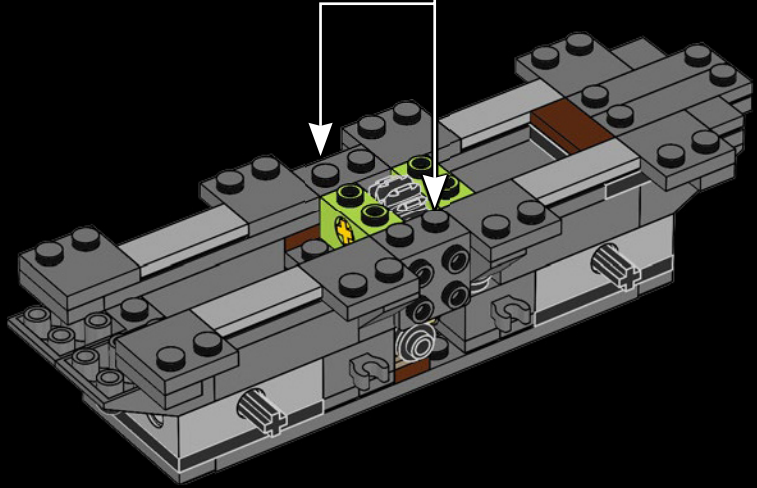
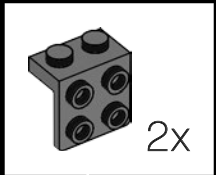

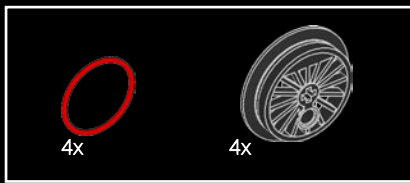

30

1



2

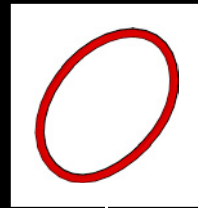

4x

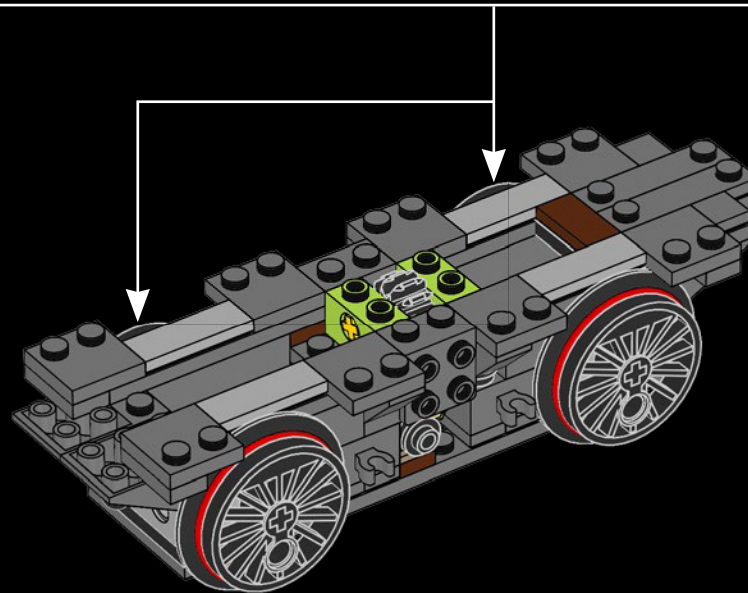

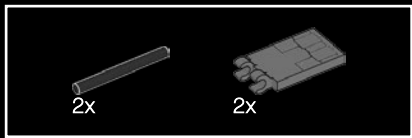

31

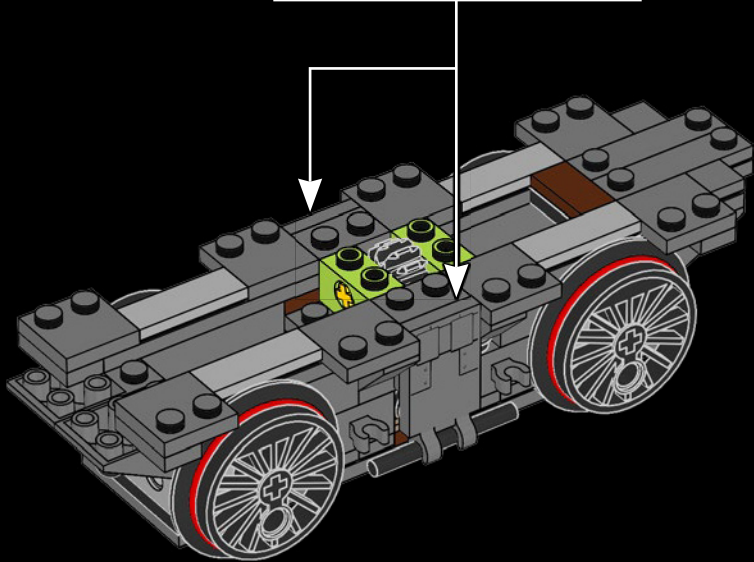
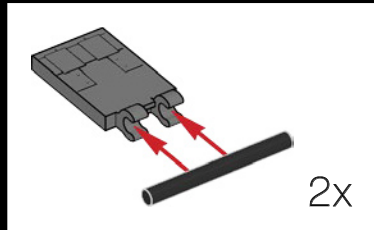

32

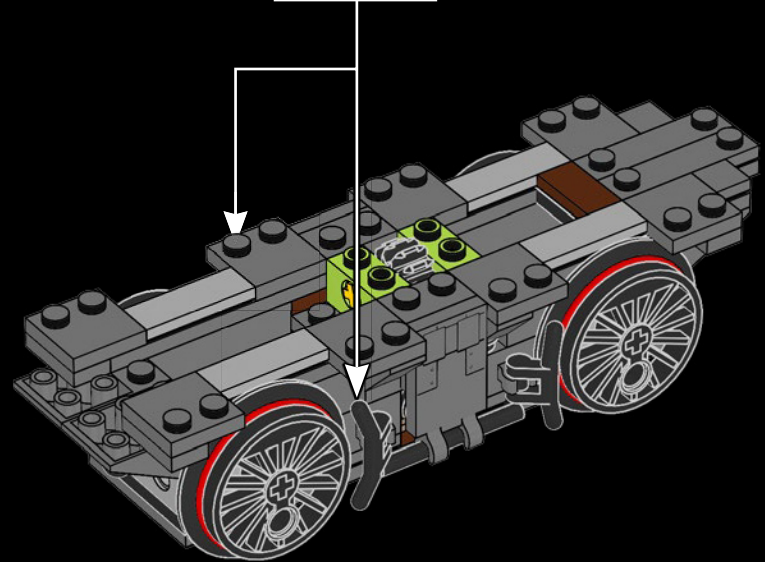

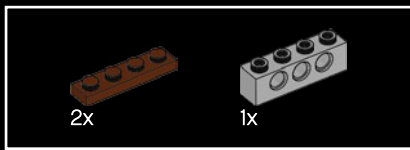

33

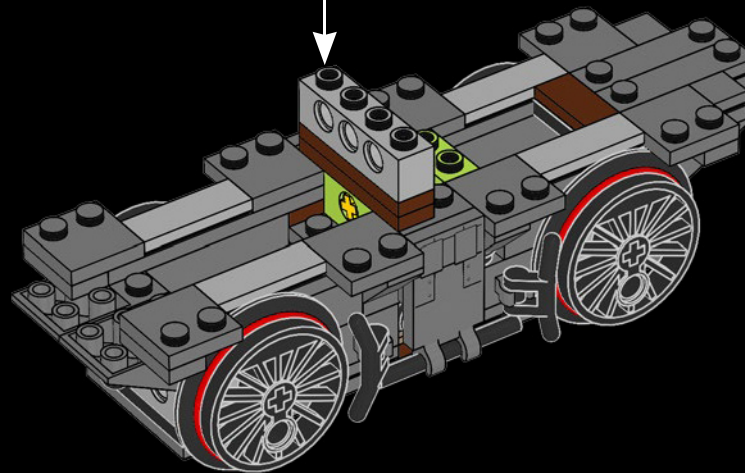
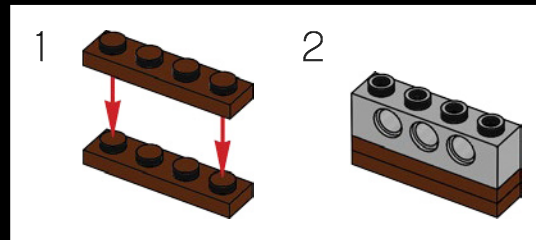

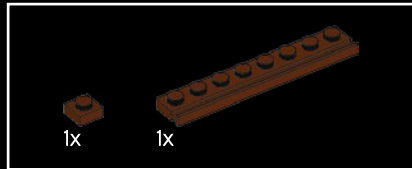
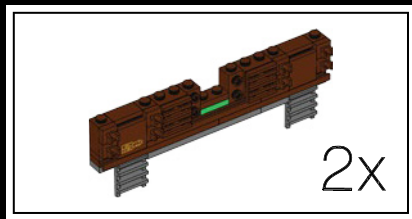

34

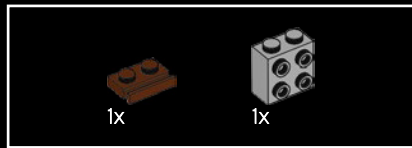
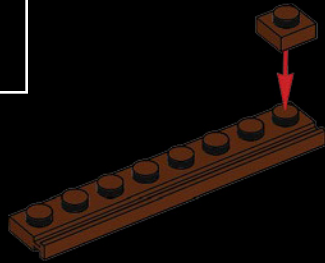

35

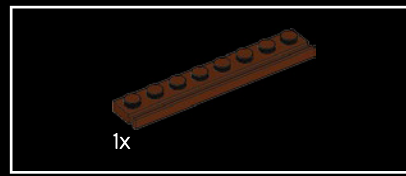
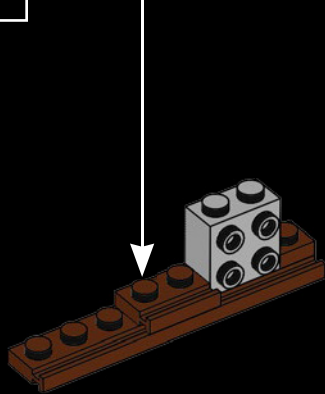
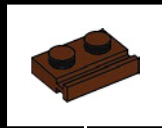

36

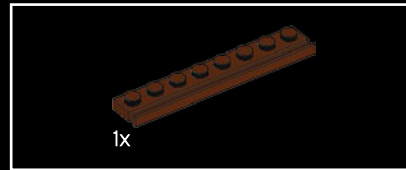
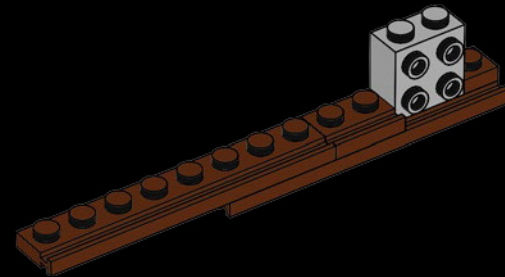

37

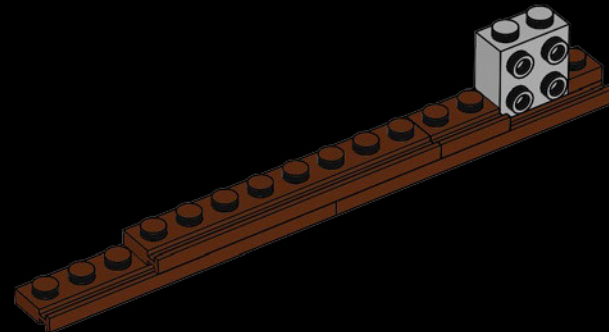

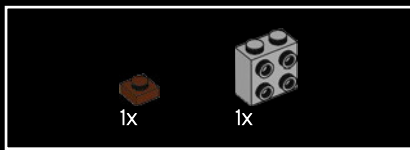

38

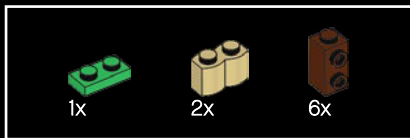
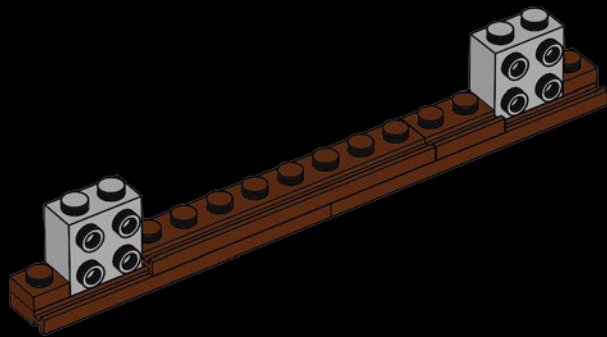

39

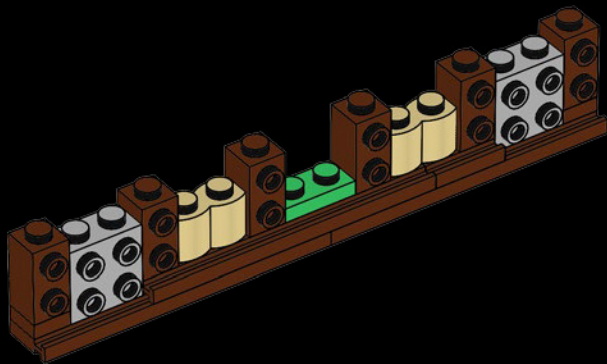

40

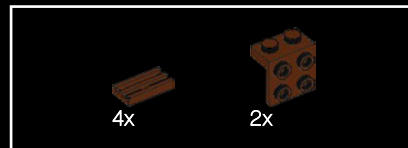
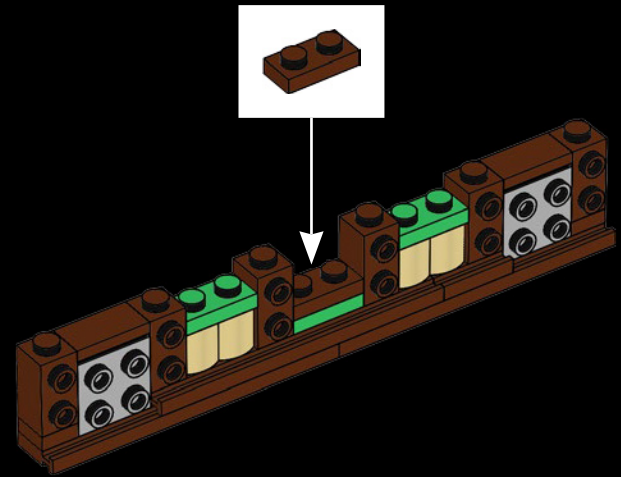

41

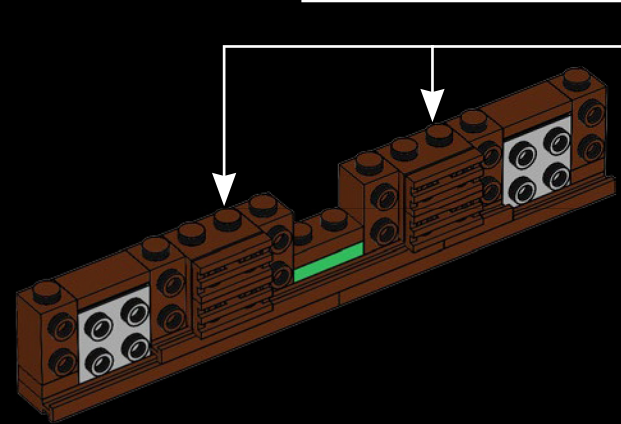
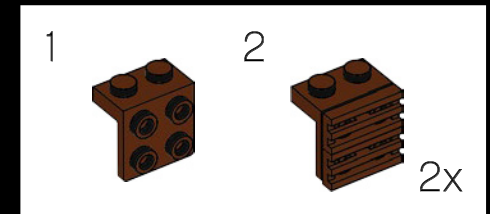

2x

42

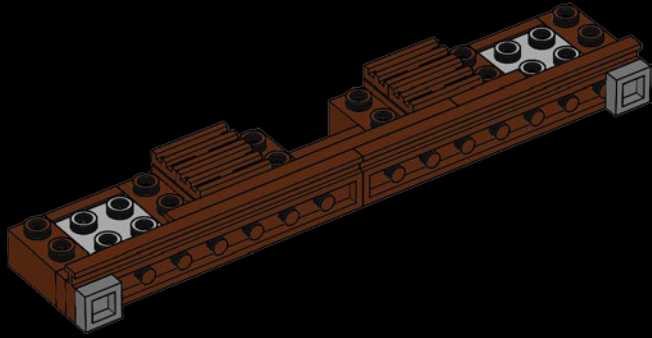

2x

43

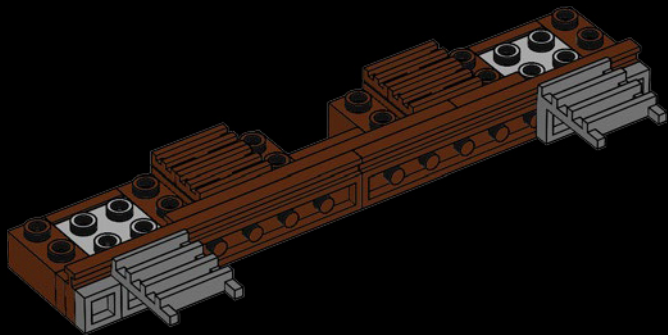

1x

1x

44

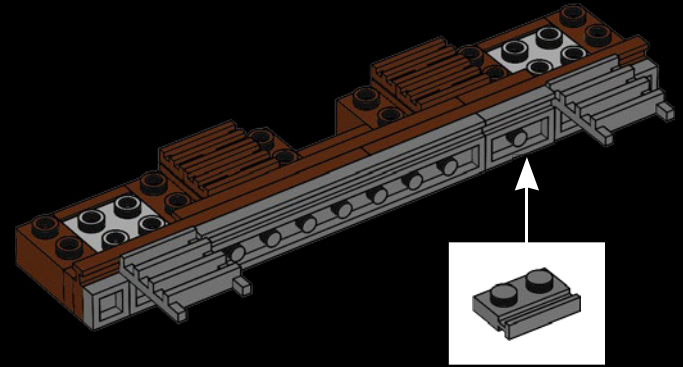

1x

1x

45

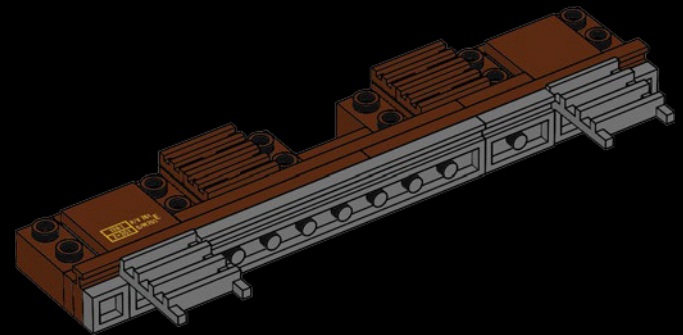



46

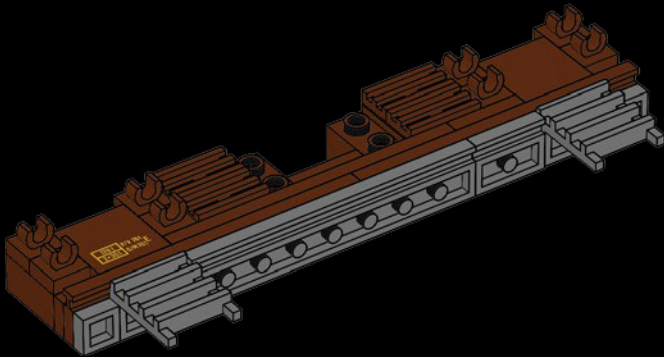

47

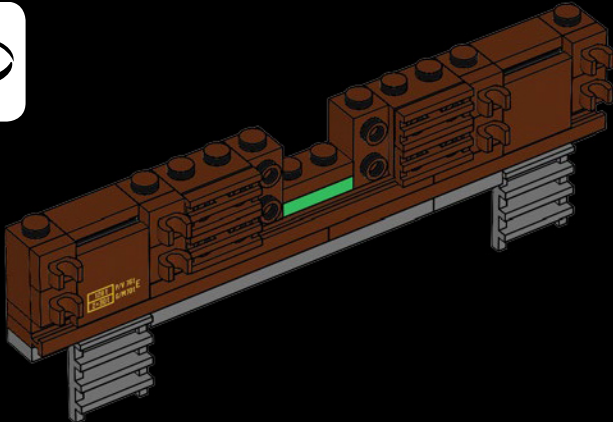

2x

48

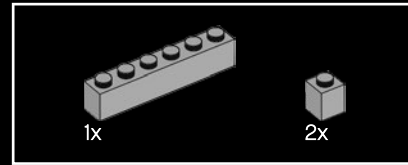
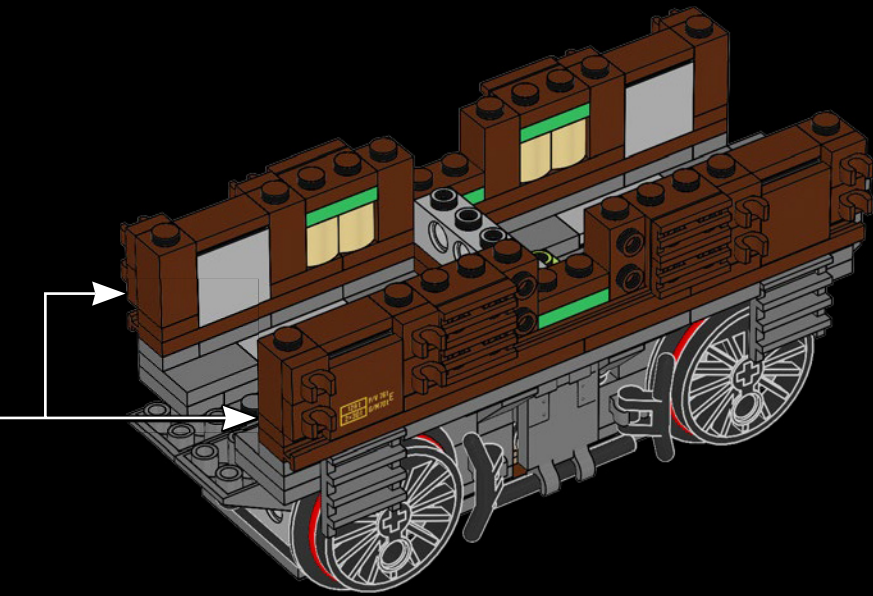

49

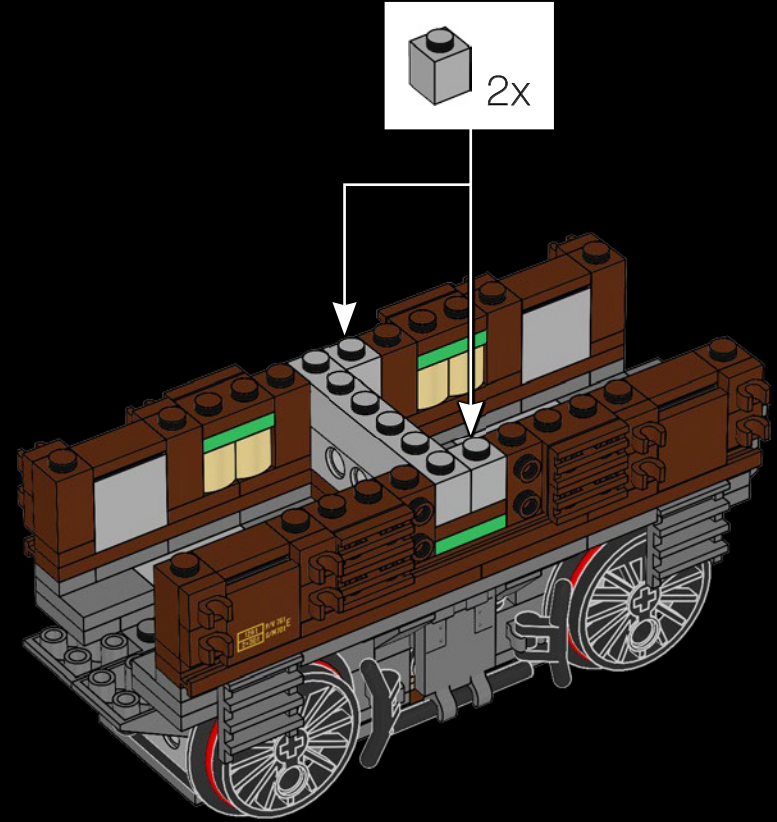

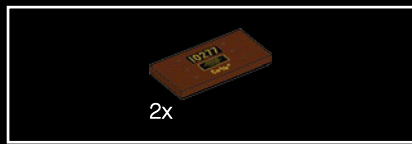

50

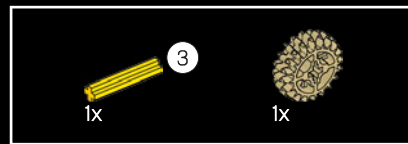
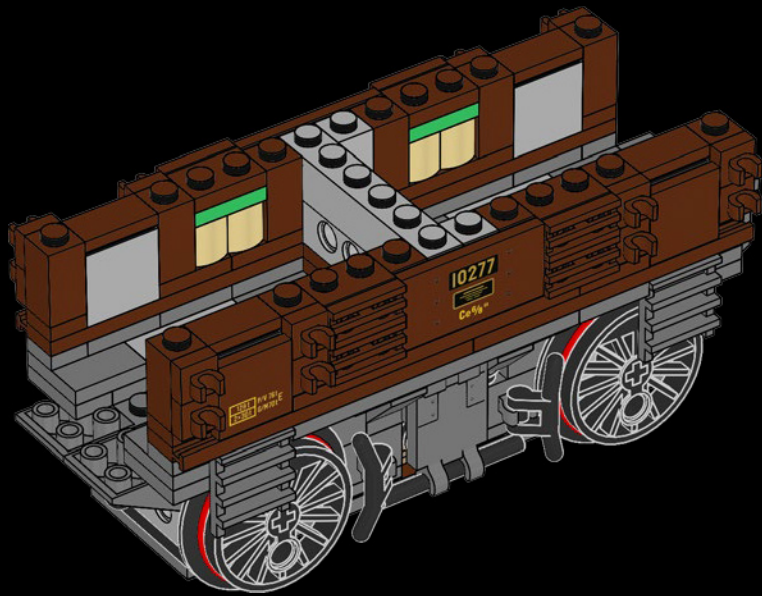

51

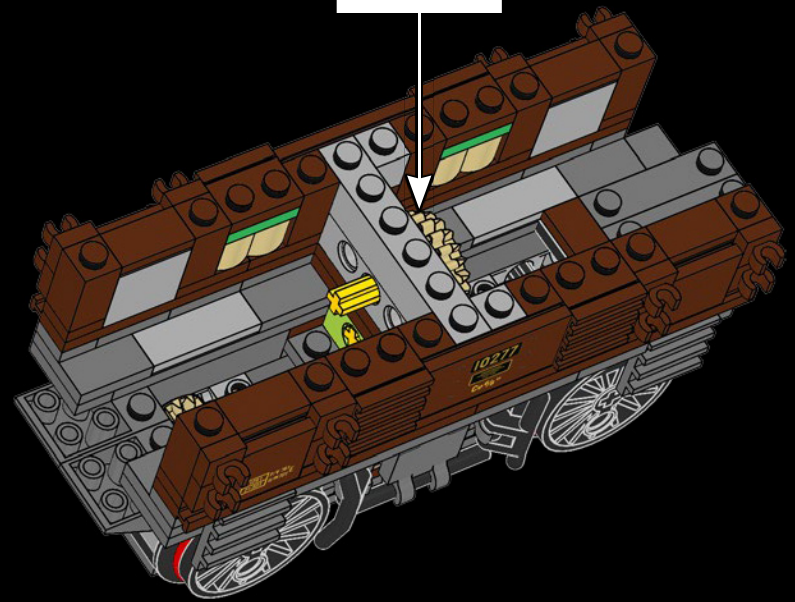
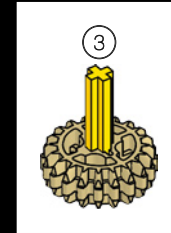



52

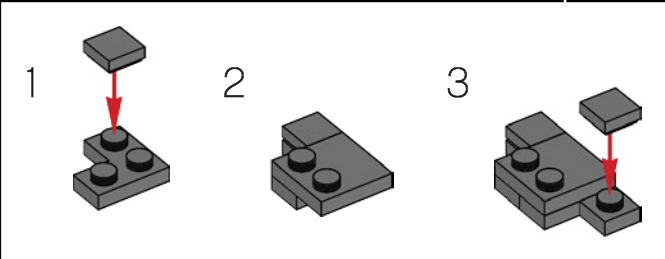
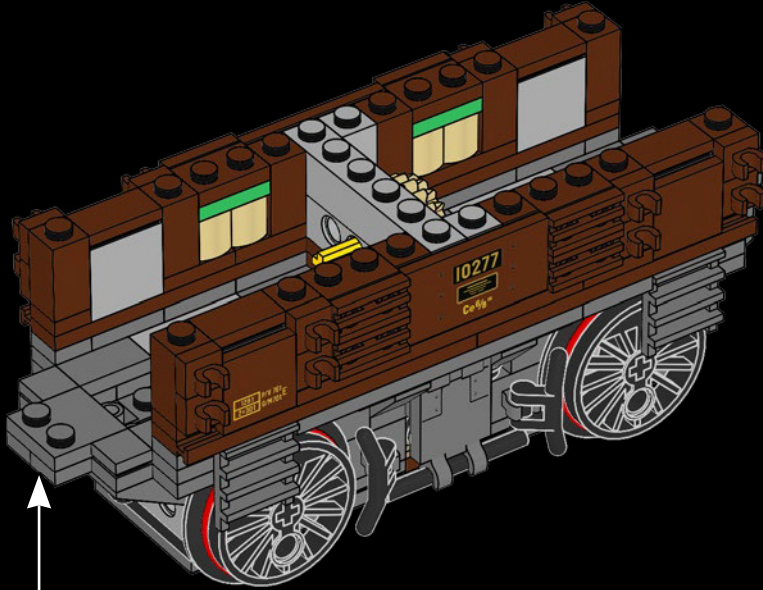

54

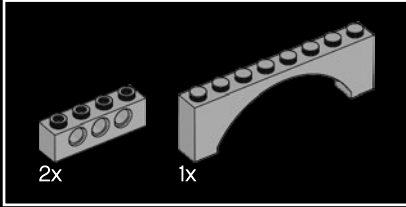
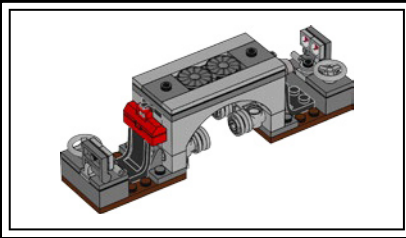

53

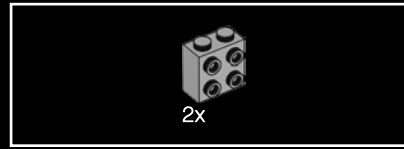
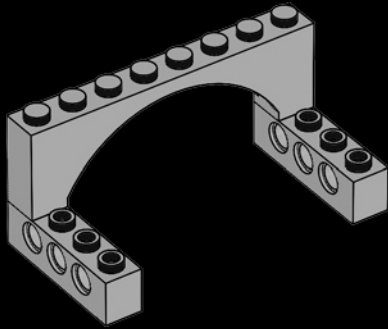

54

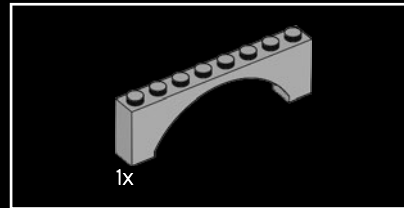
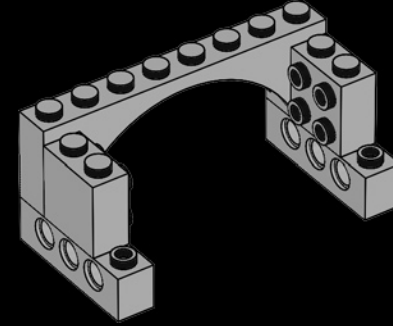

55

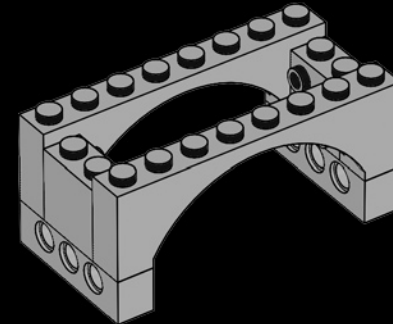



2x

56

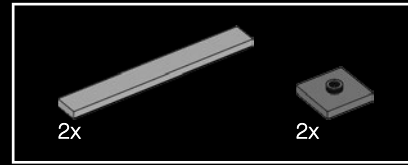
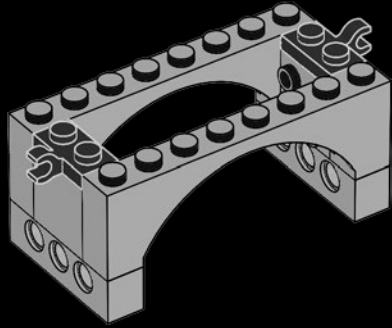

2x

2x

58

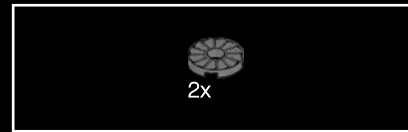
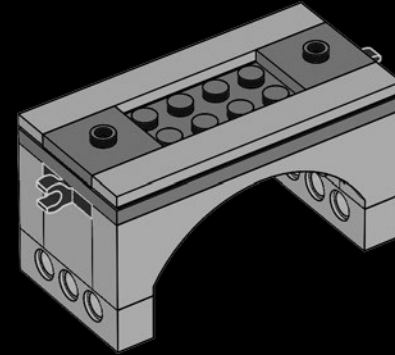

2x

59

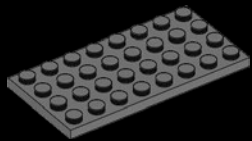
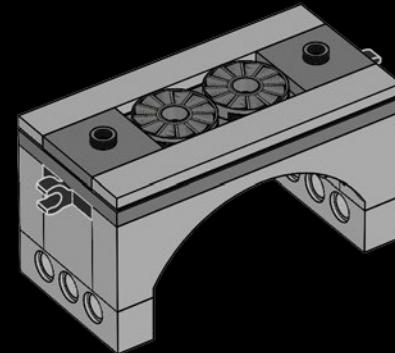

1x

57

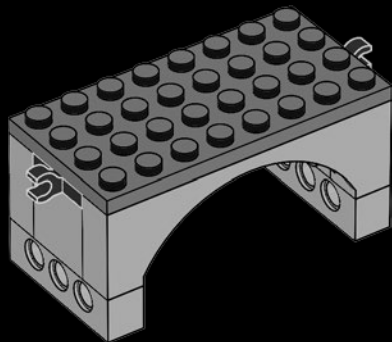

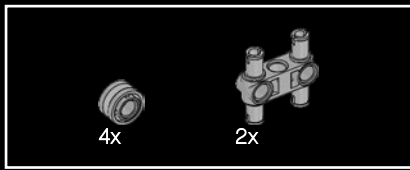

60

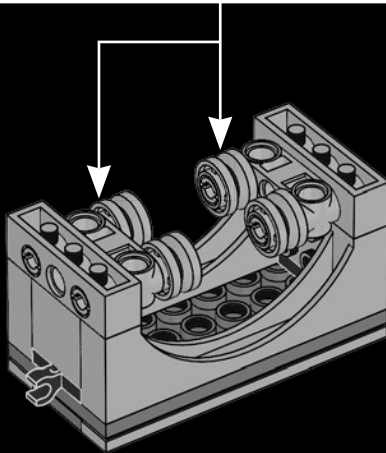
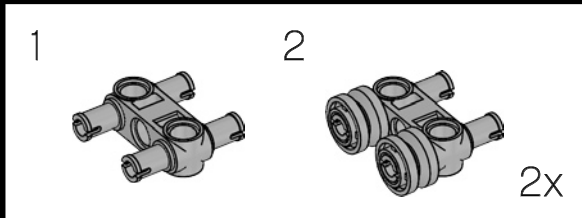

61

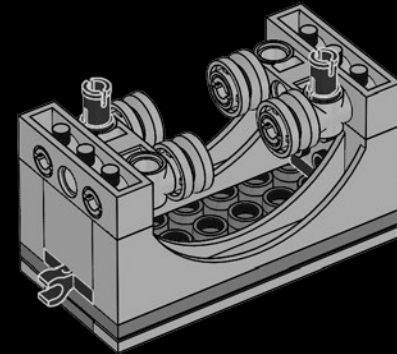

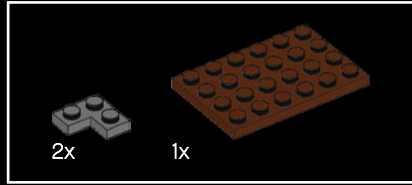
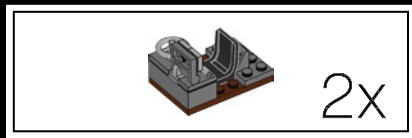

62

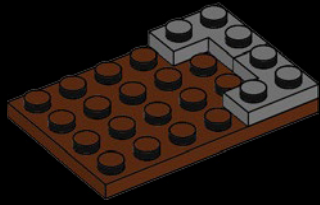

63

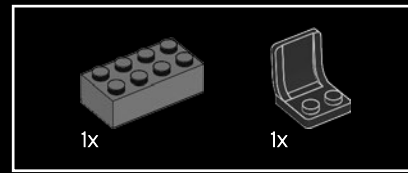
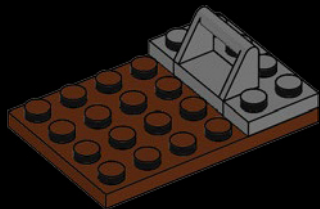

64

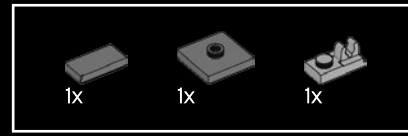
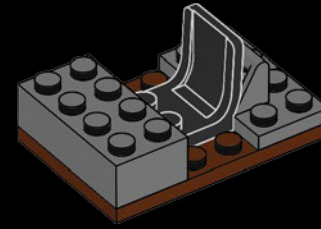

65

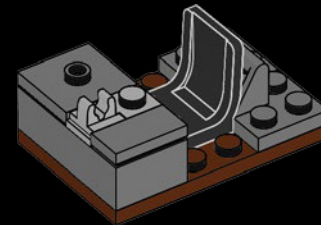



66

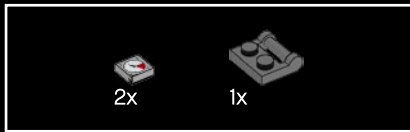
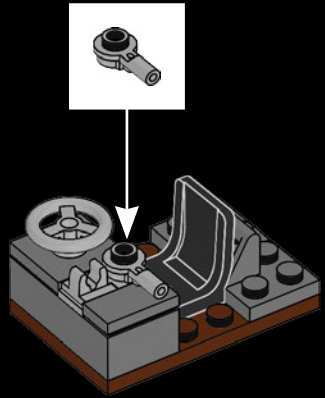

67

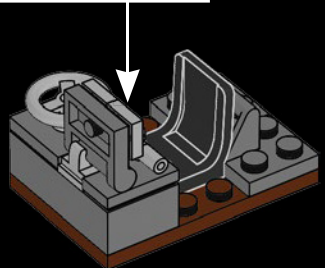
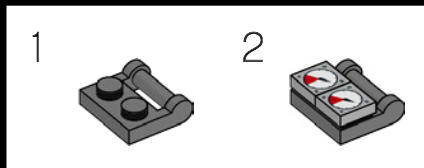

2x

68

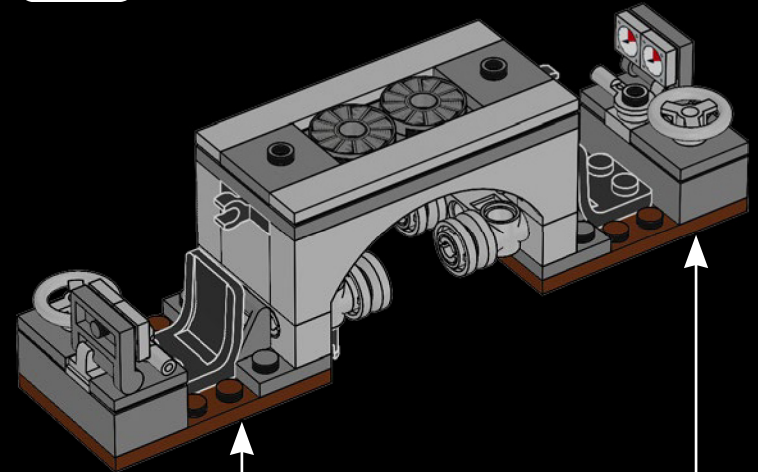

69

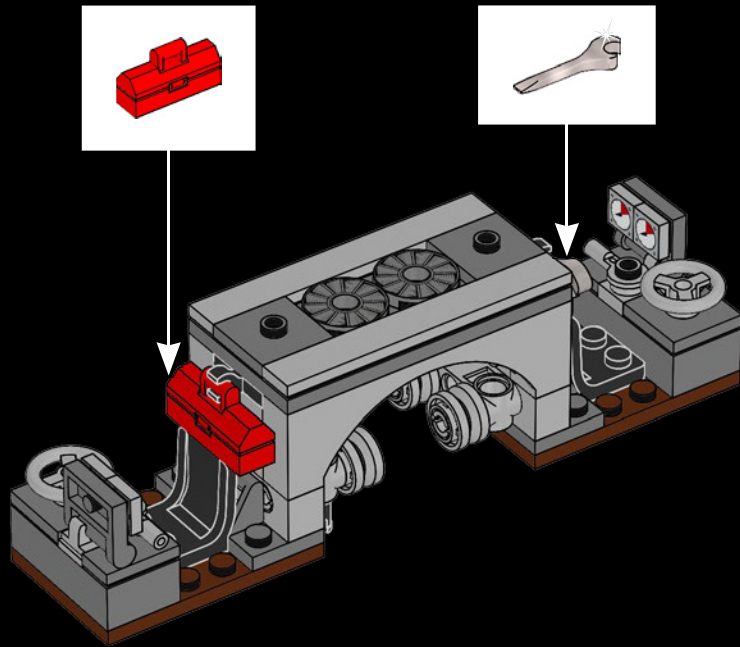

70

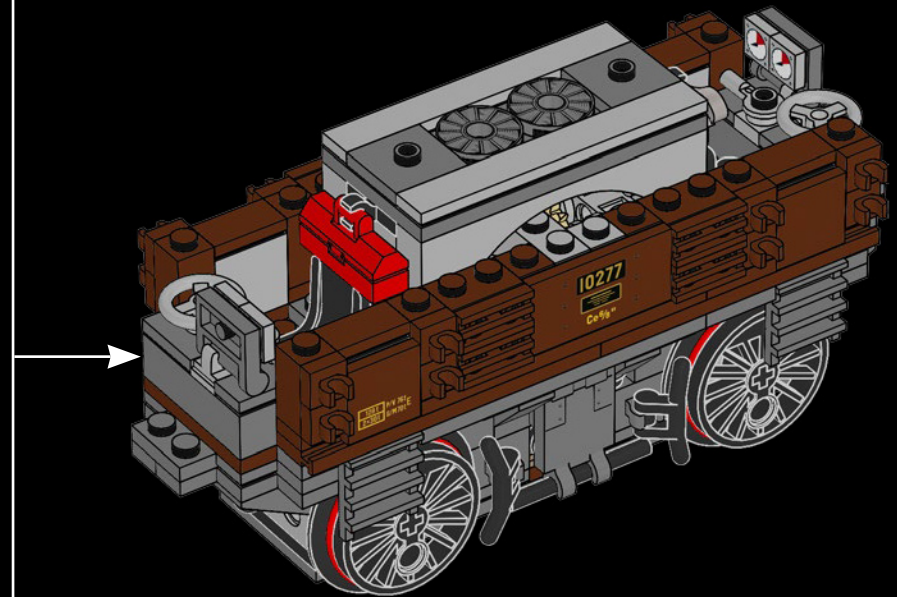



71

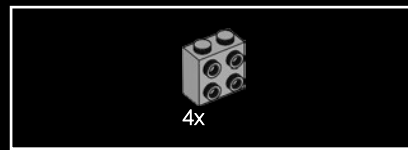
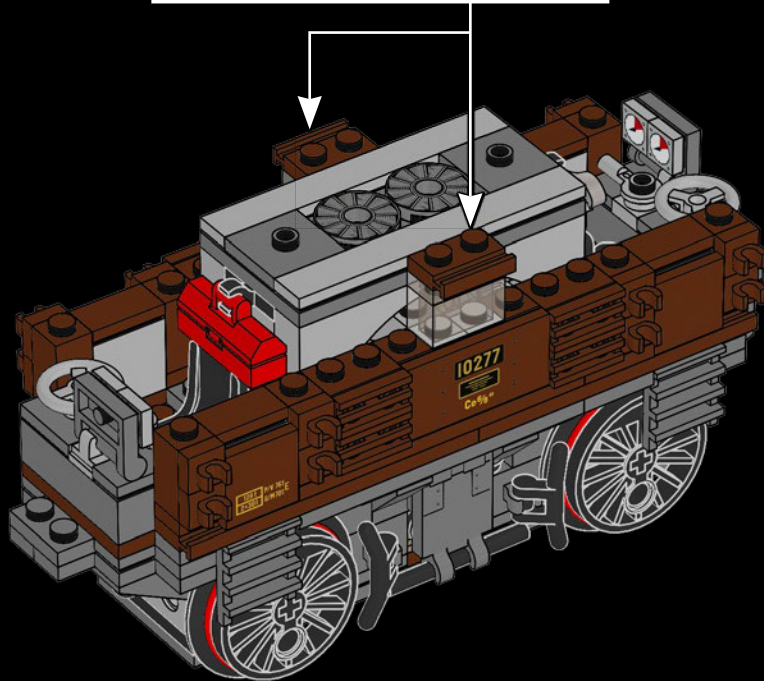
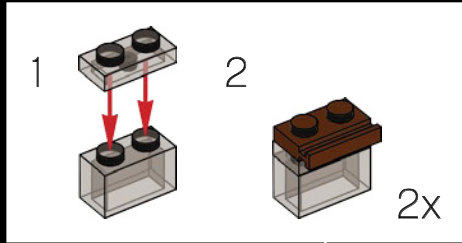

72

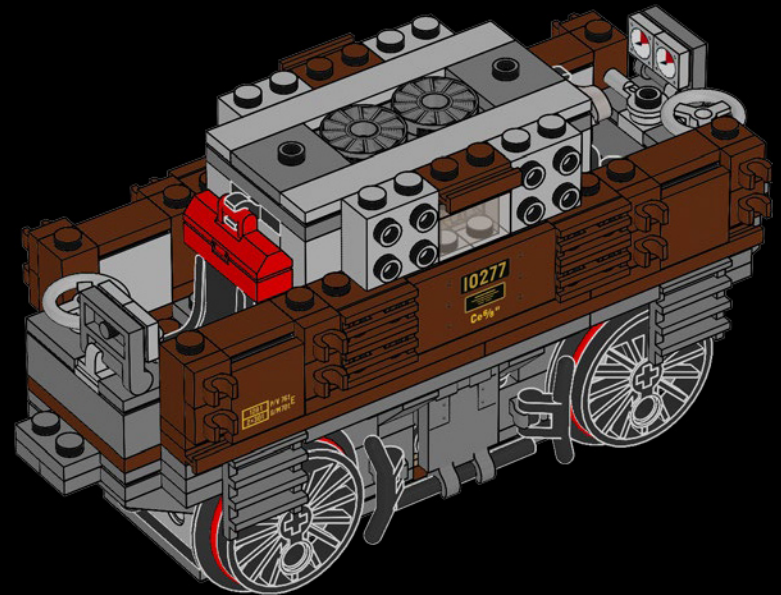



4x

73



4x

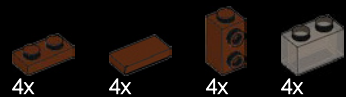
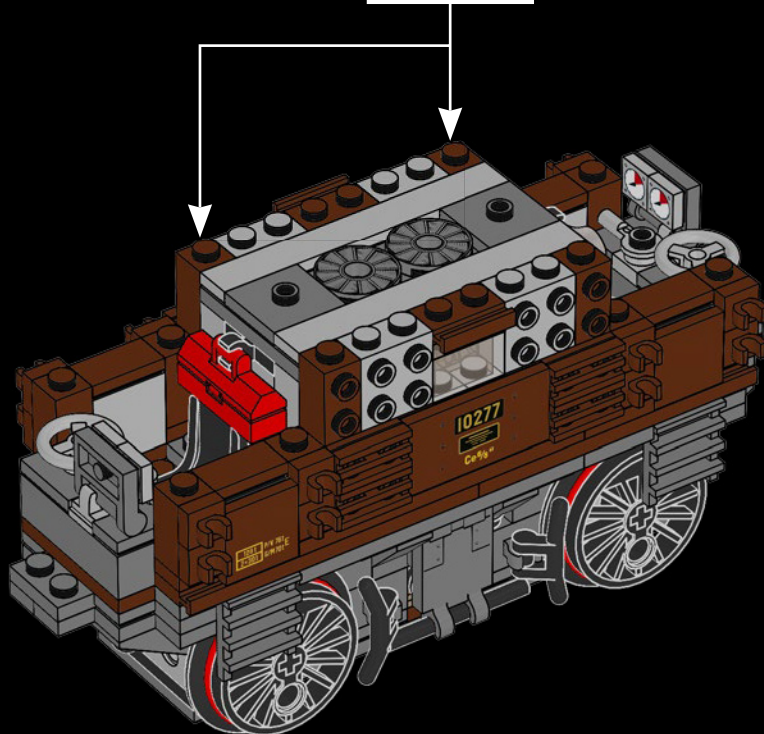

4x

4x

4x

4x

74

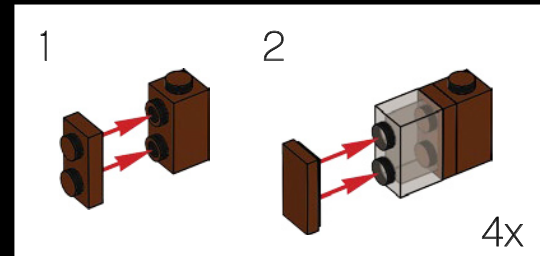

1

2

4x

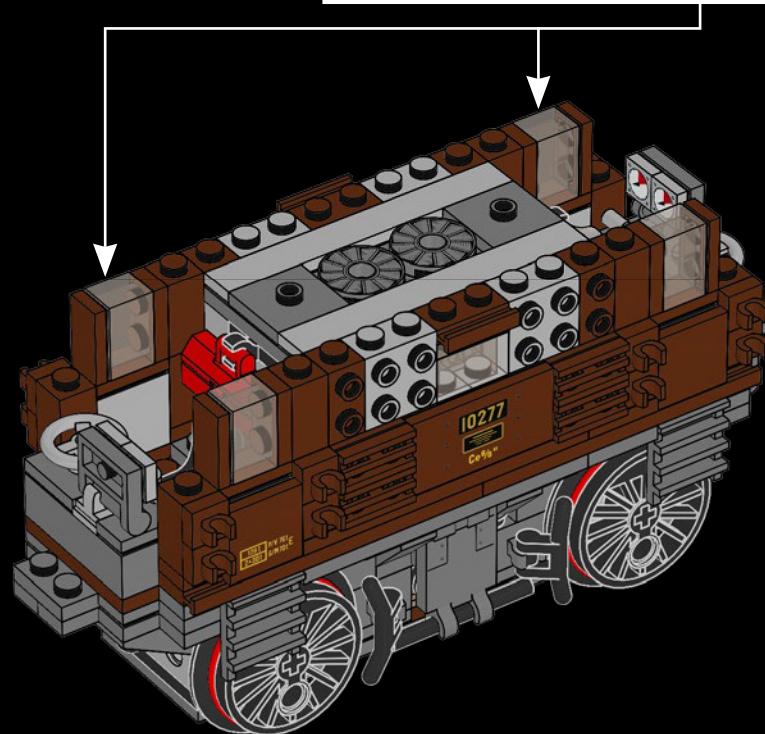

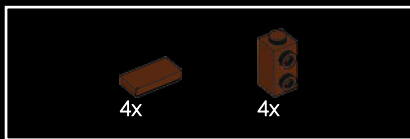

75

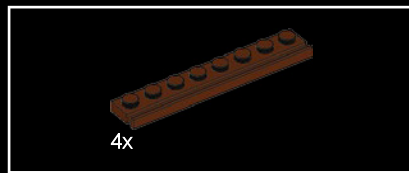
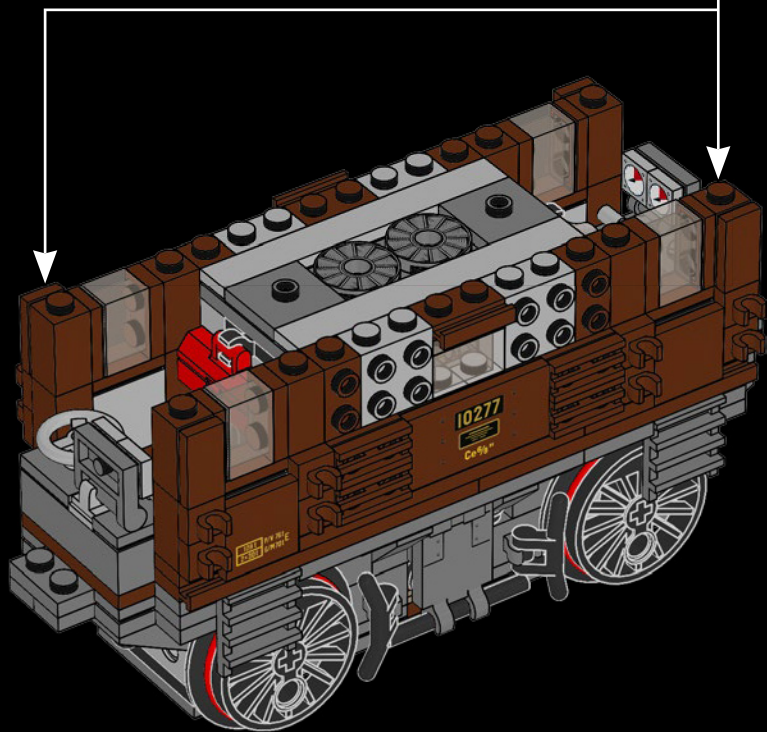
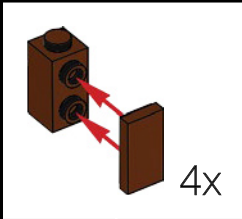

76

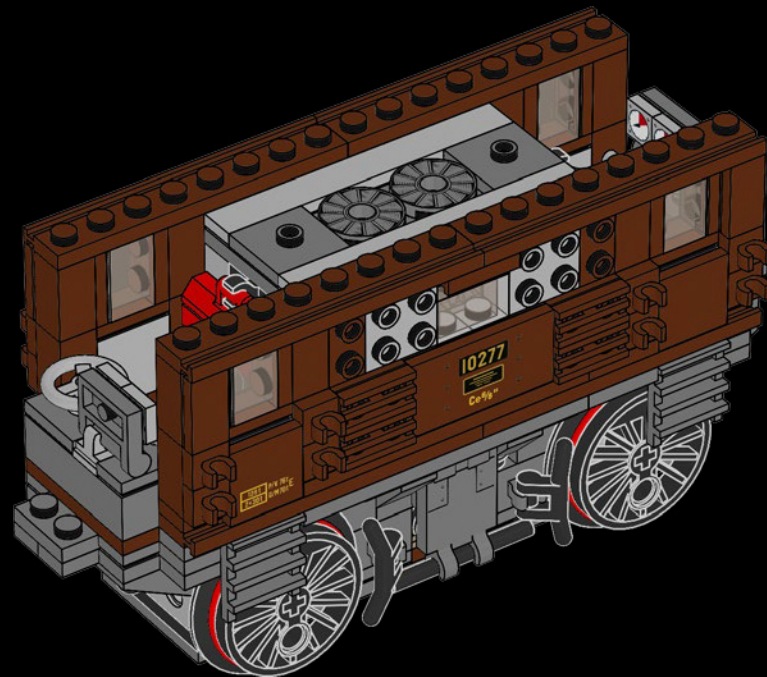

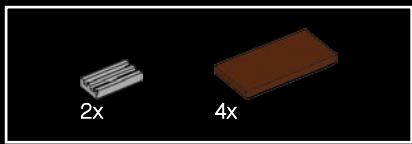

77

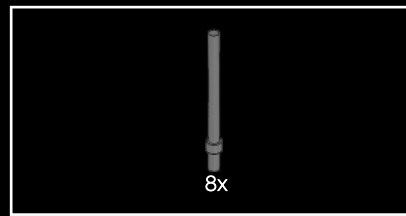
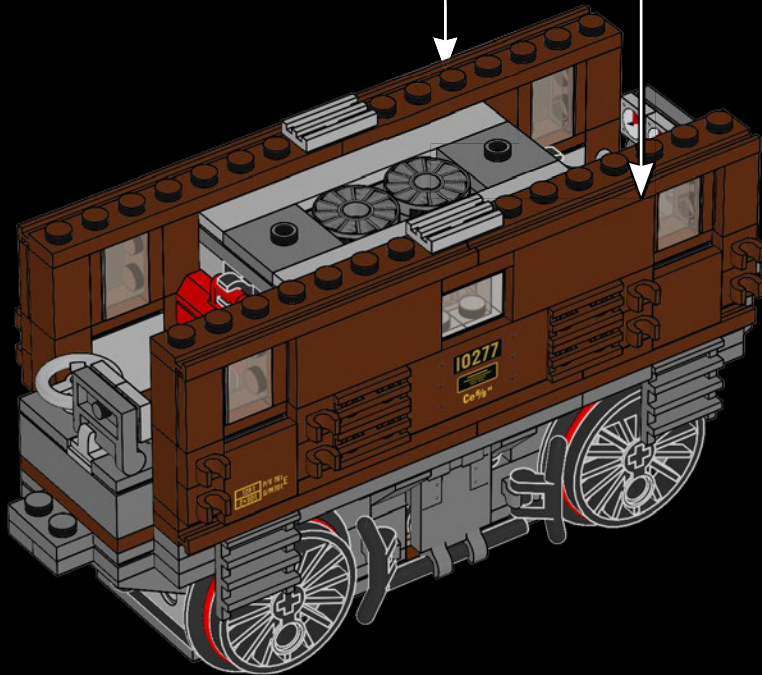
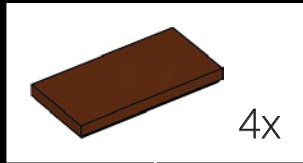

78

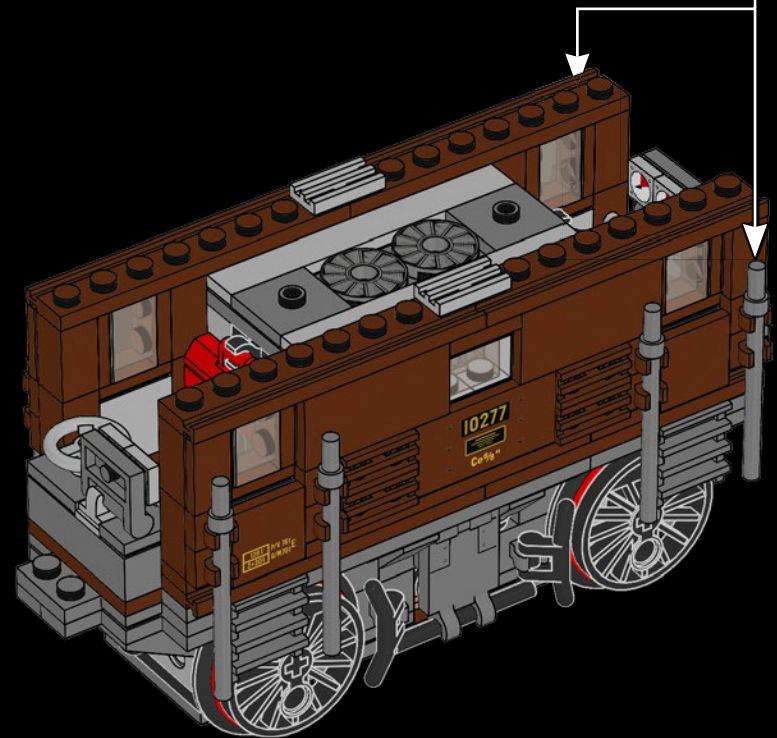
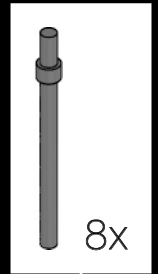

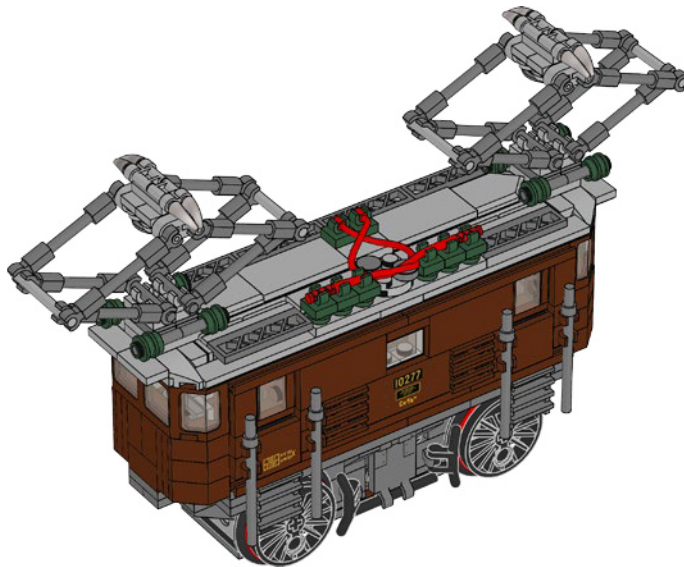
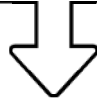

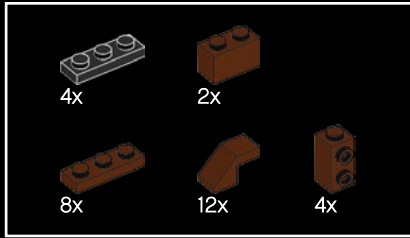
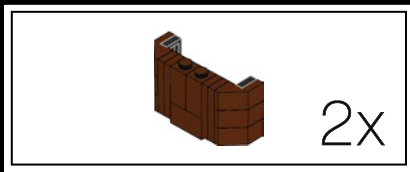

79

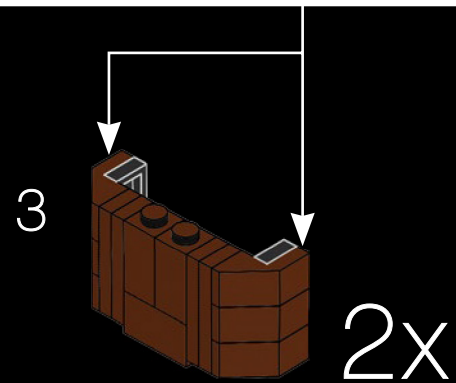
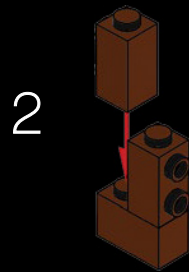
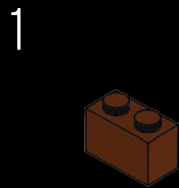
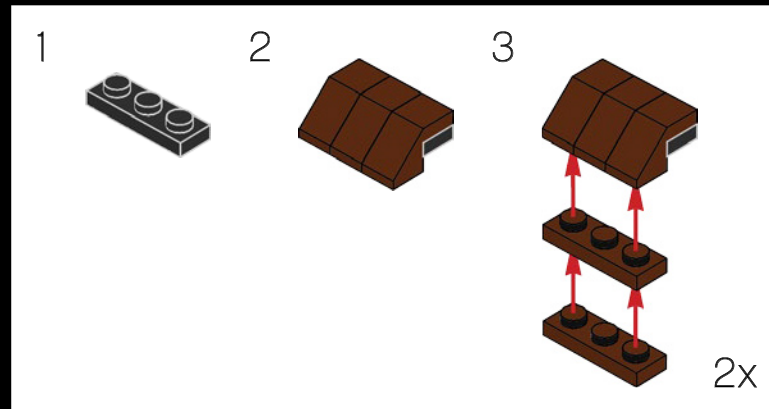

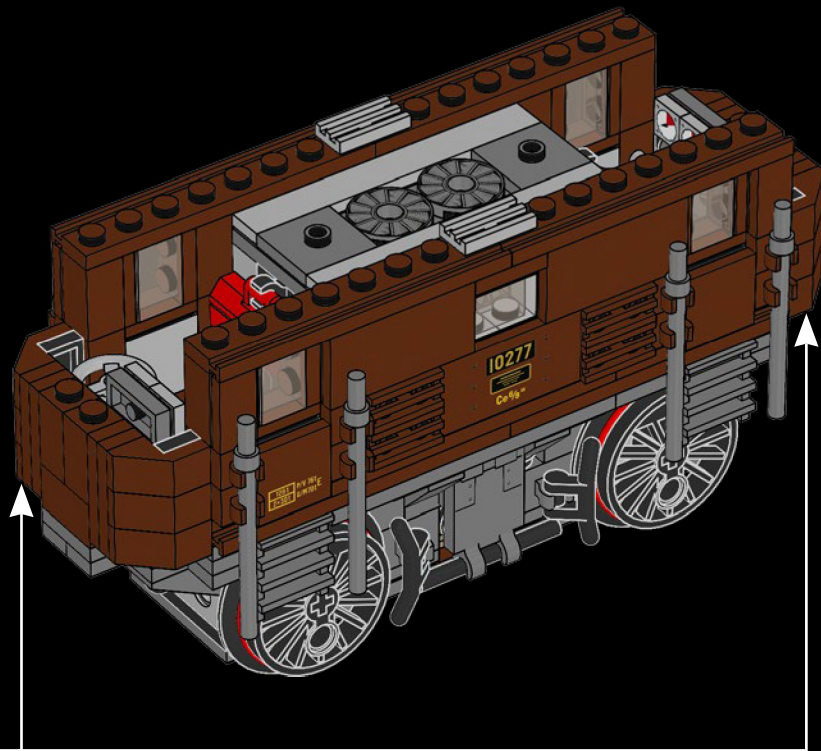

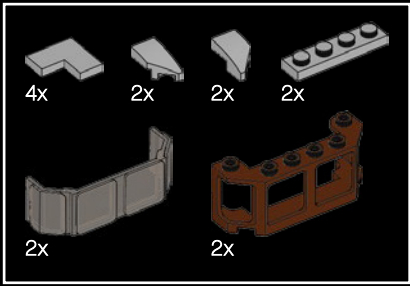

80

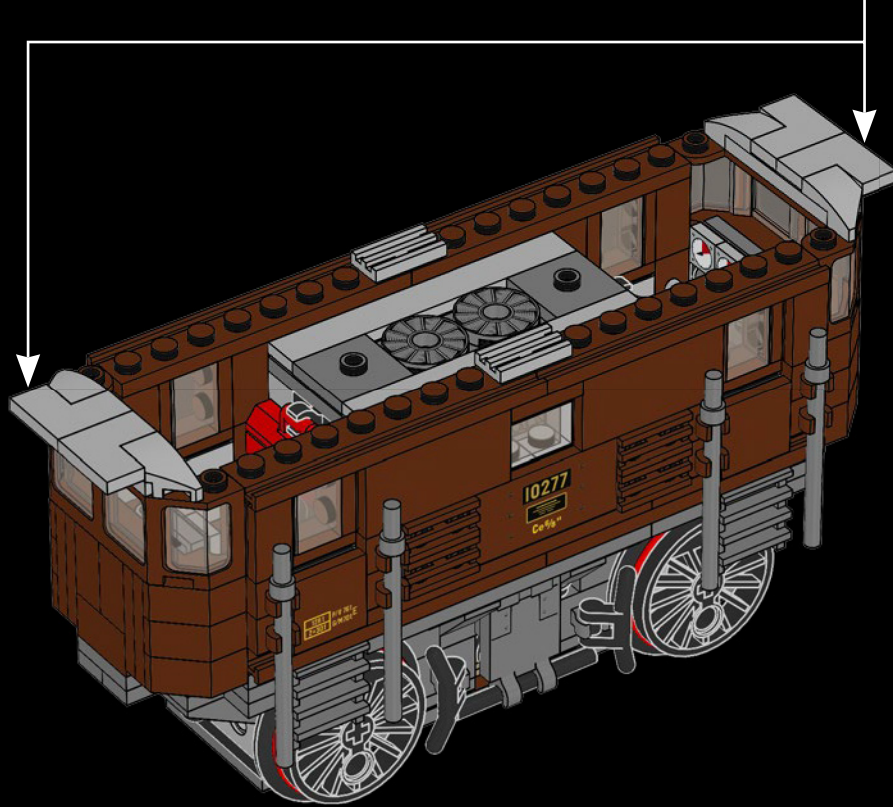
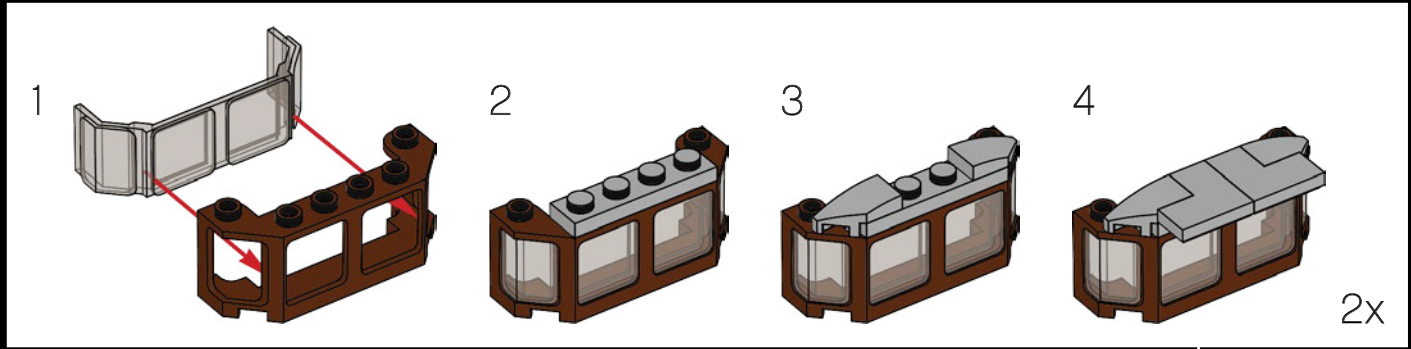

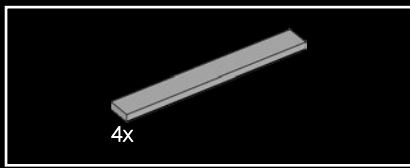

81

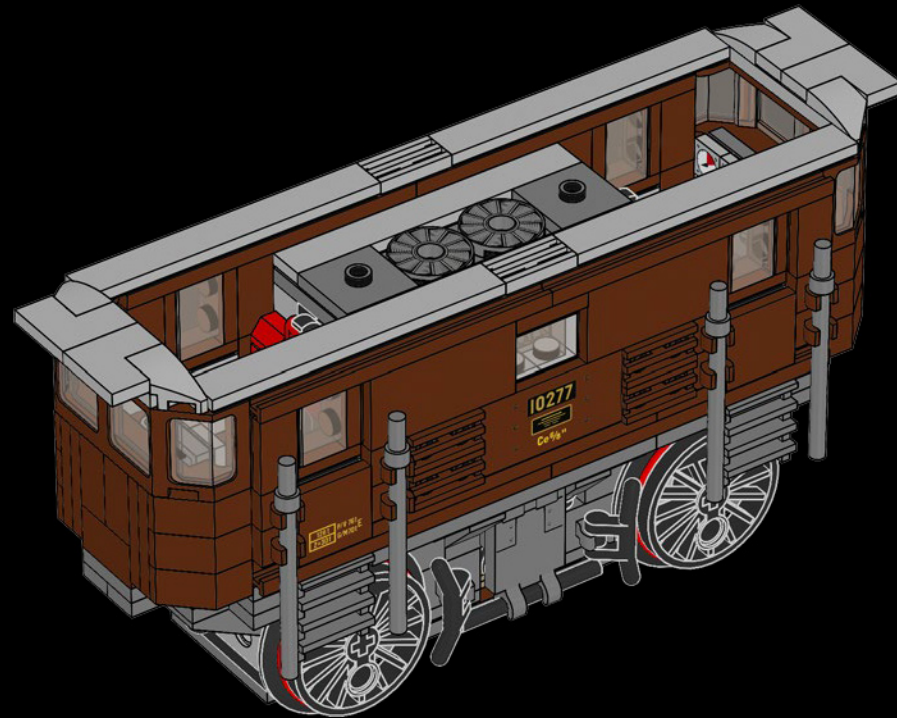

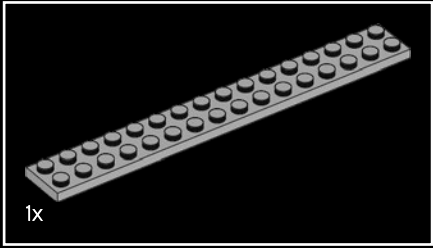
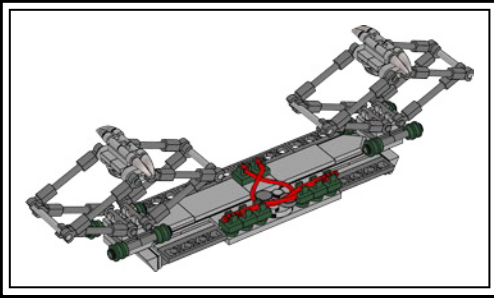

1x

82

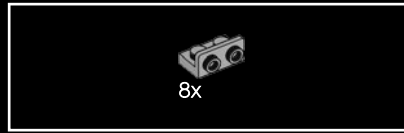
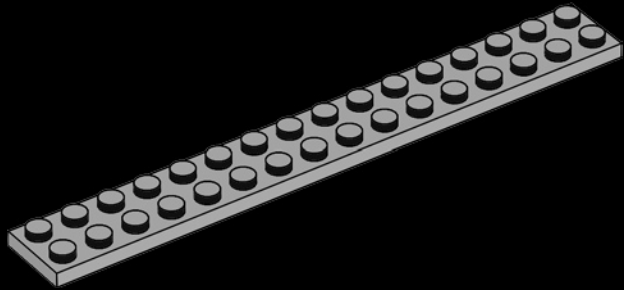

8x

83

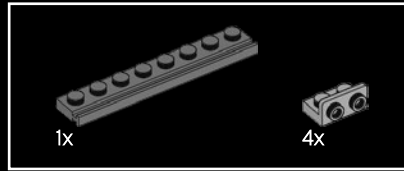
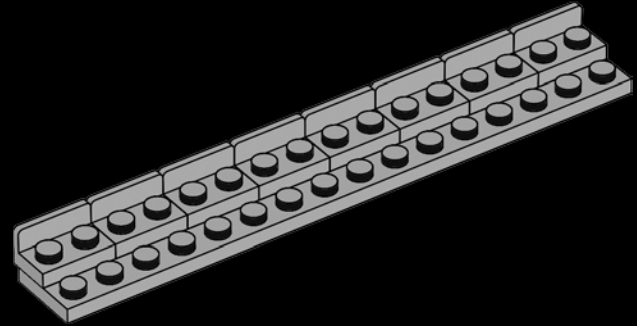

1x

4x

84

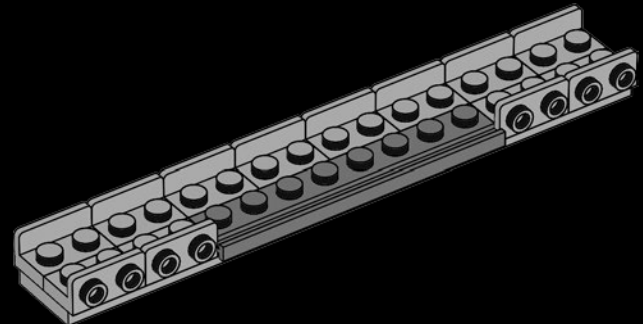

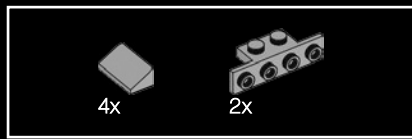

85

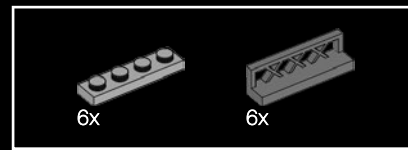
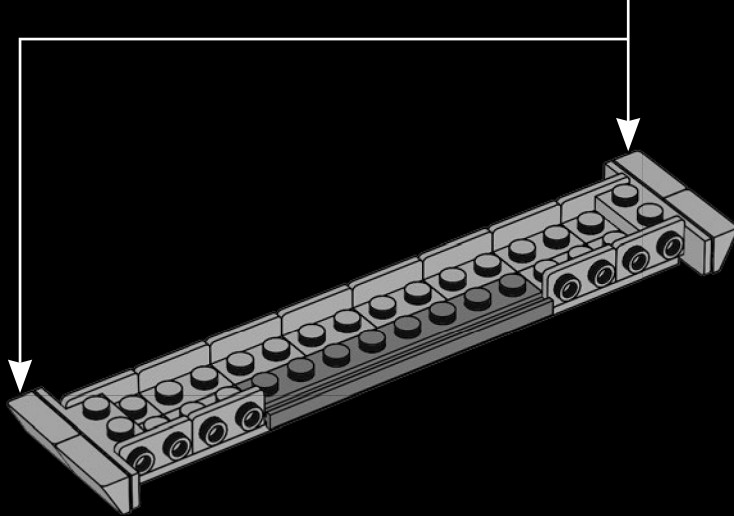
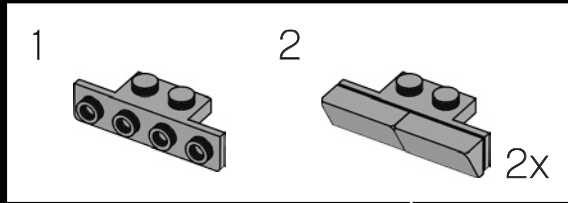

86

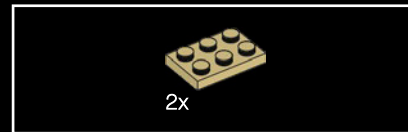
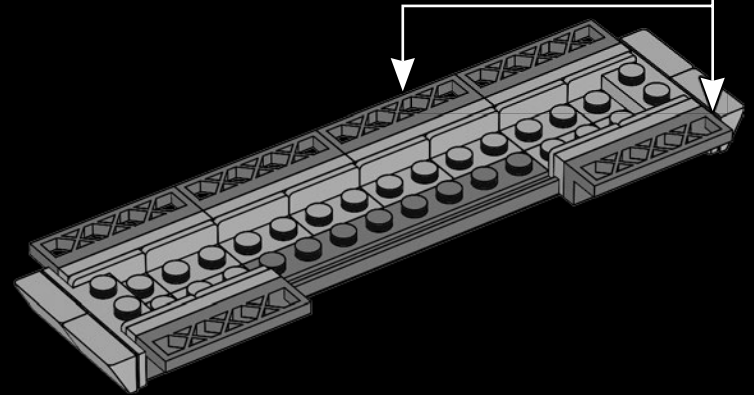
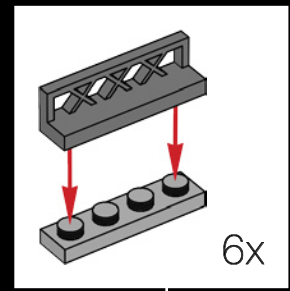

87

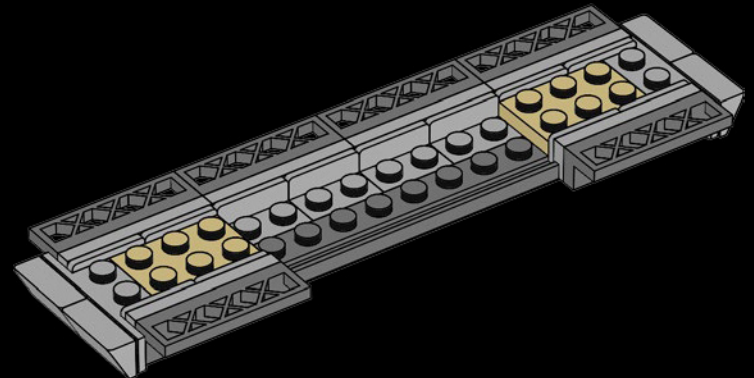

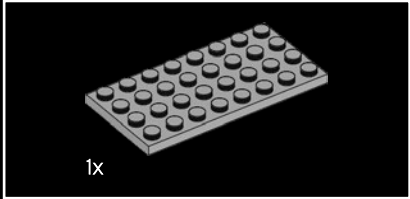
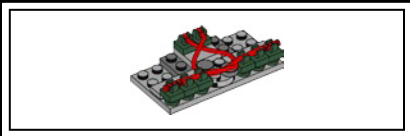

1x

88

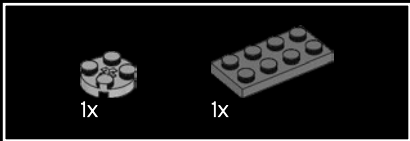
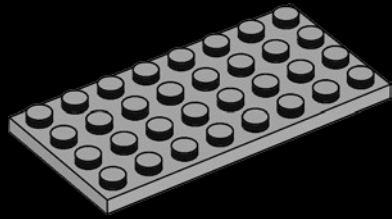

1x

1x

89

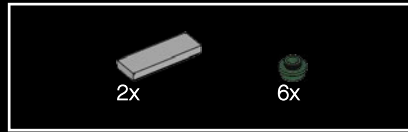
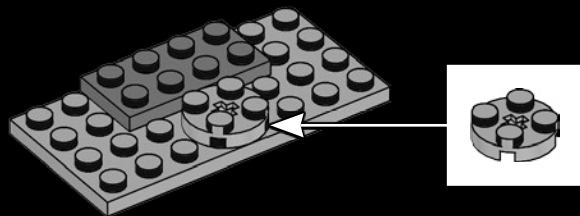

2x

6x

90

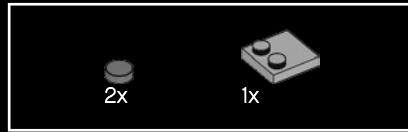
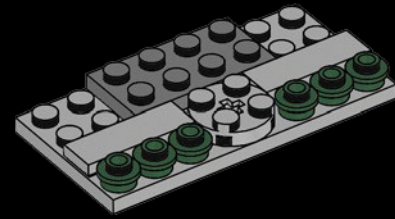

2x

1x

91

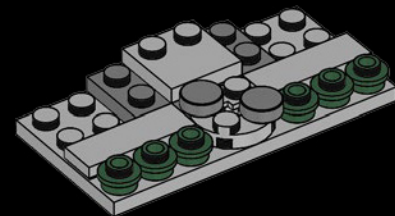



92

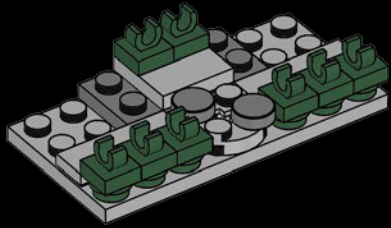

93

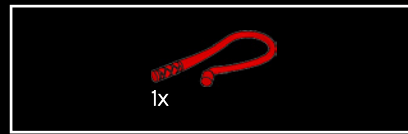
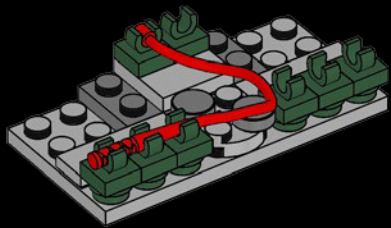

94

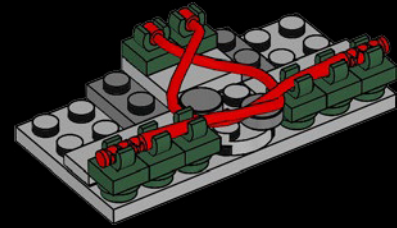

95

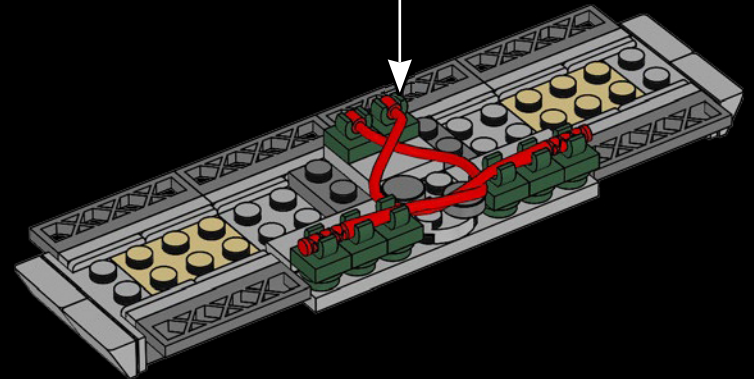

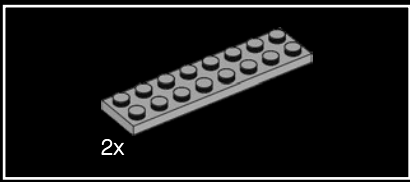

96

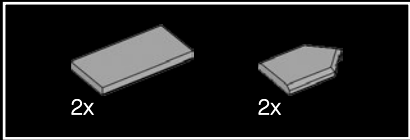
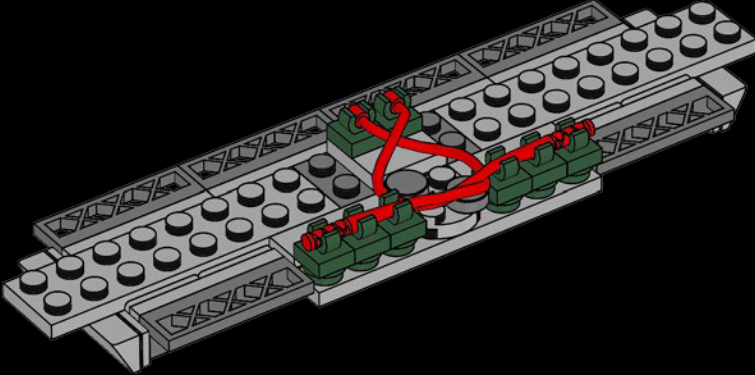

97

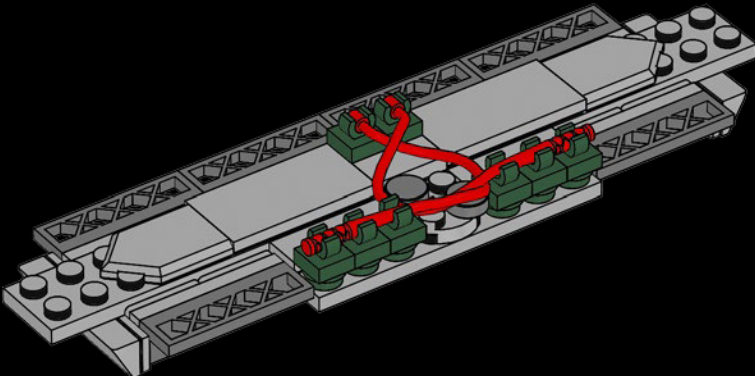

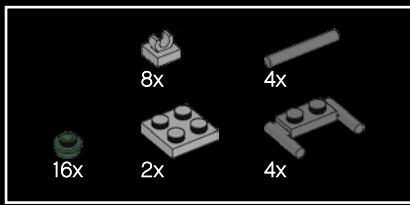

98

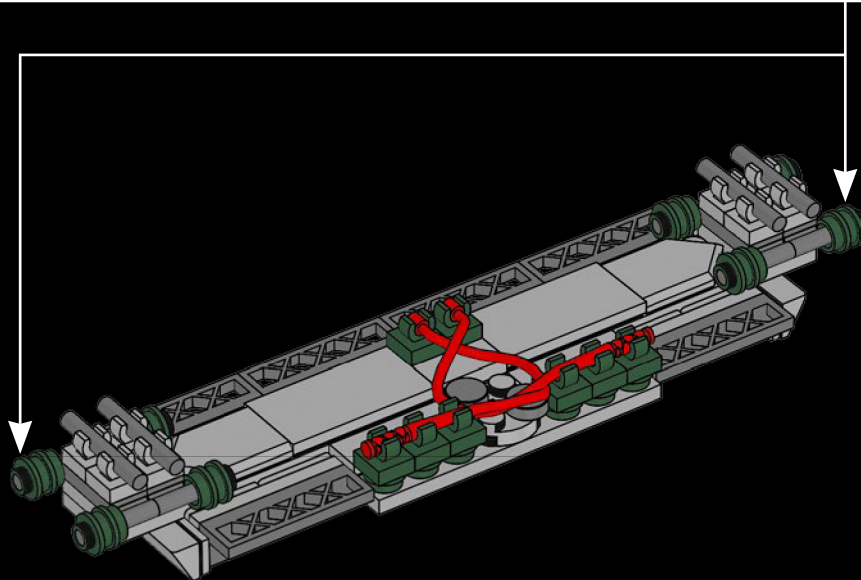
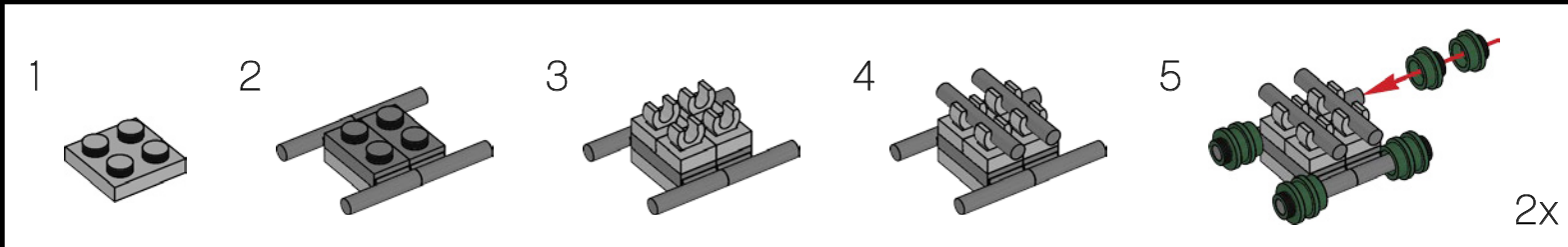

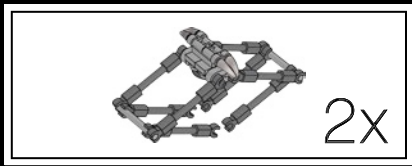

99

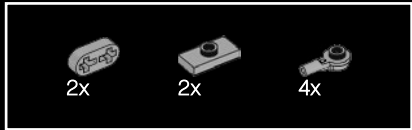

100

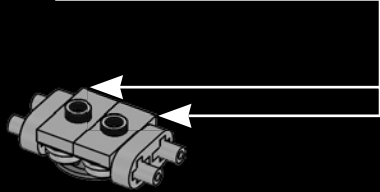
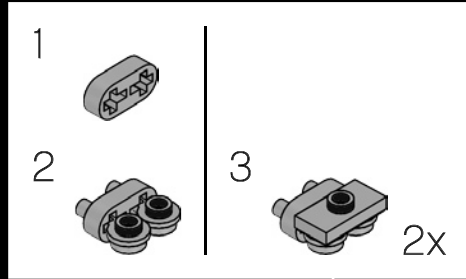

101



102

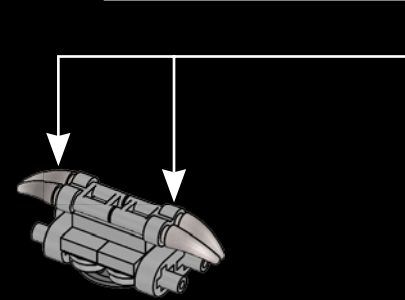
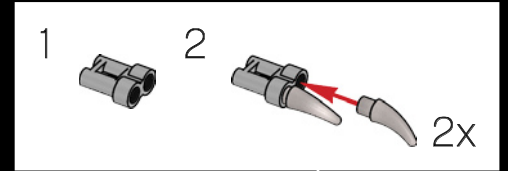



103

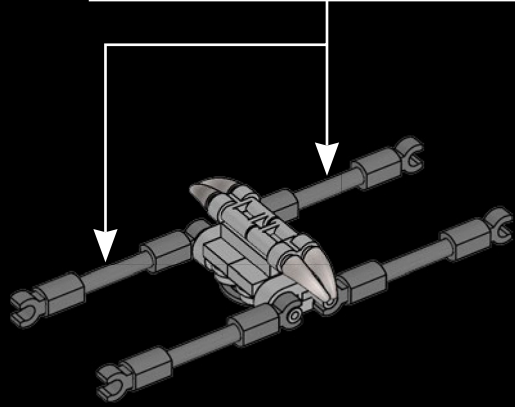
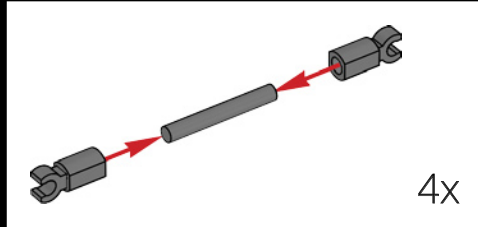

104

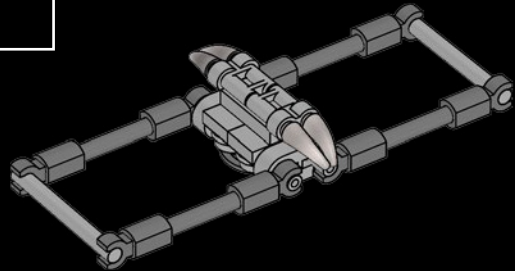

105

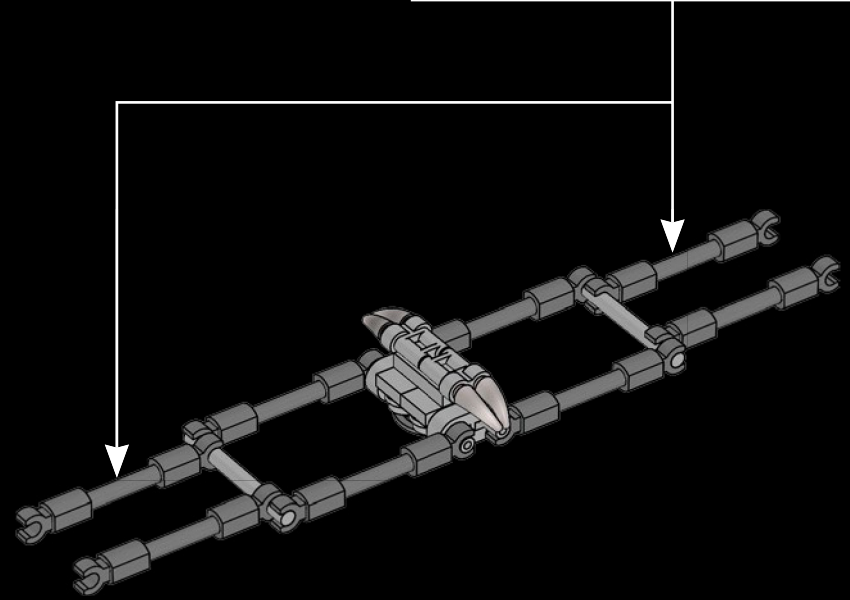
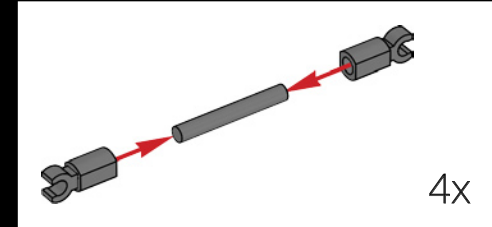

106

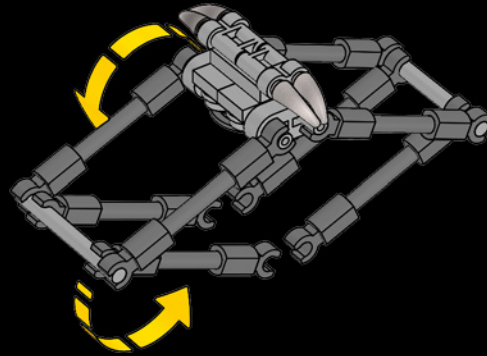

2x

107

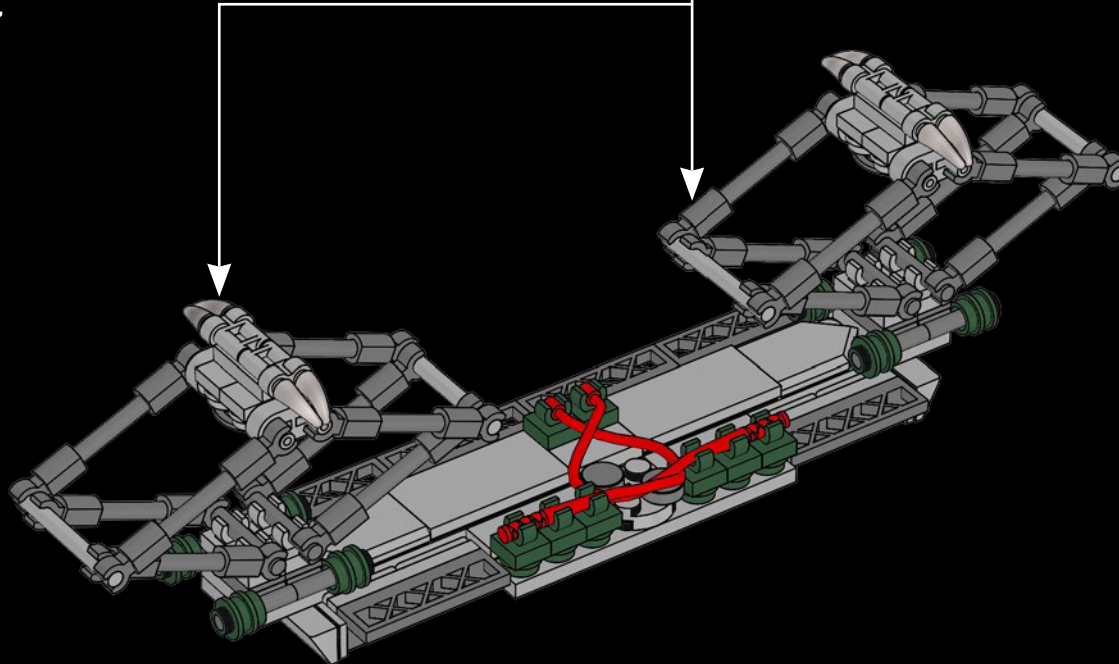

108

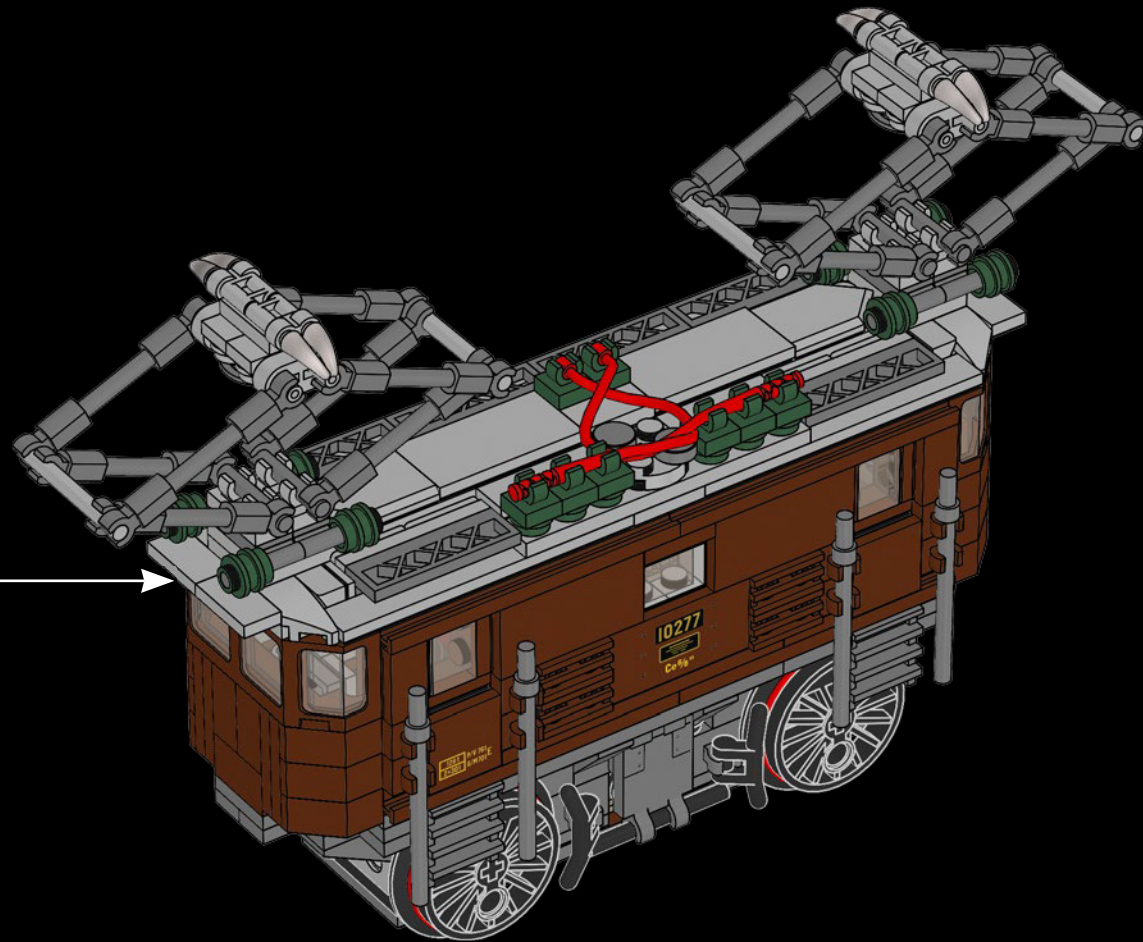

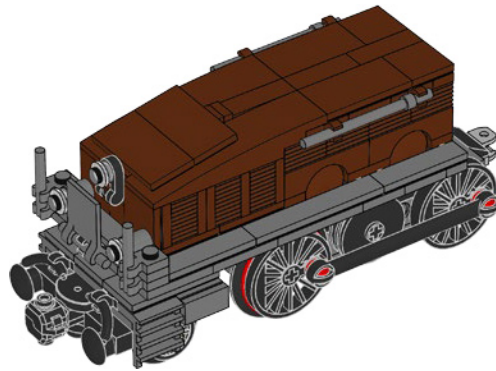
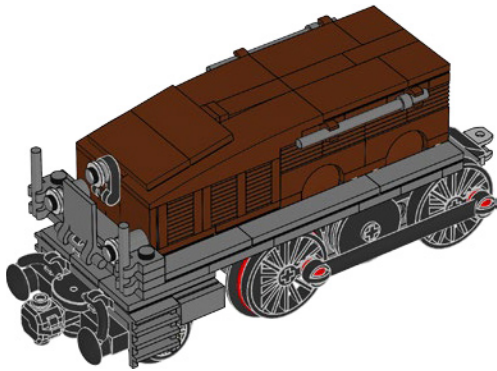
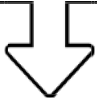

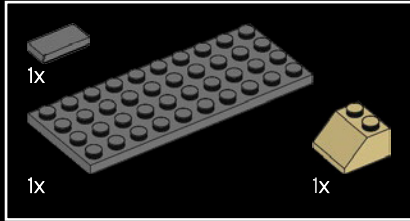
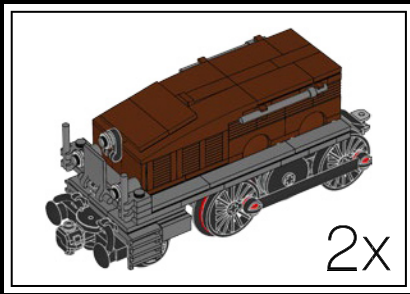

109

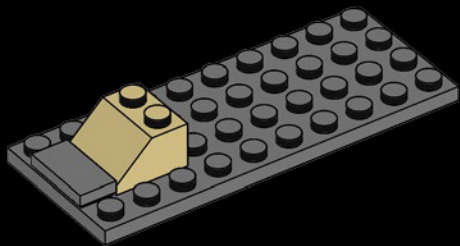

110

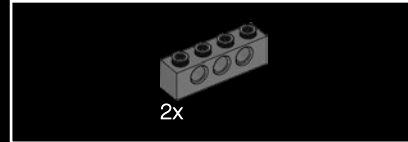
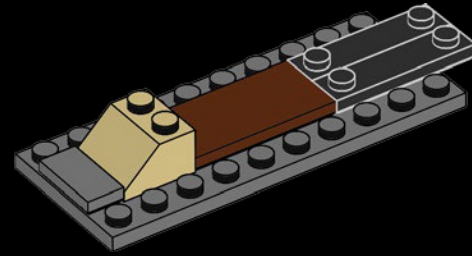

111

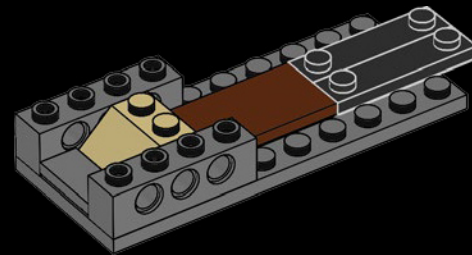

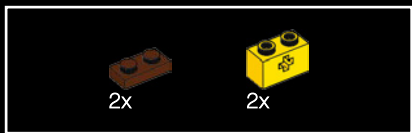

112

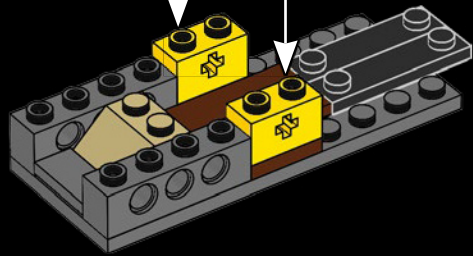
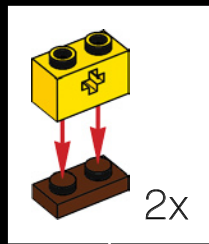

113

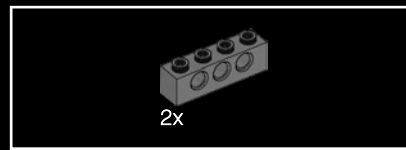
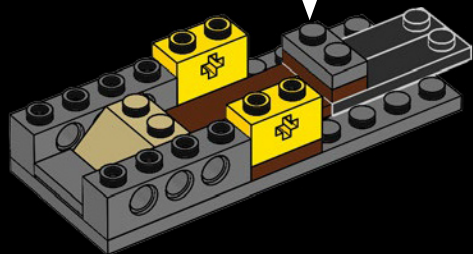
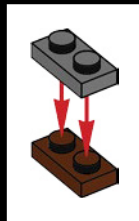

114

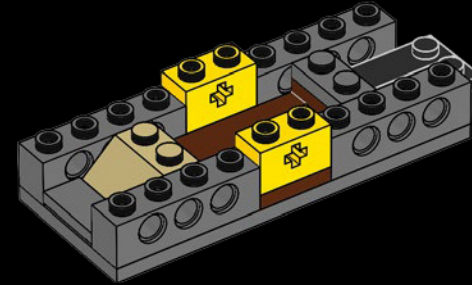

115

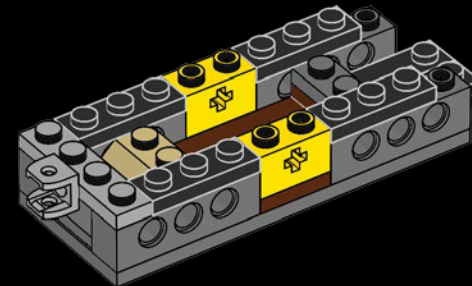

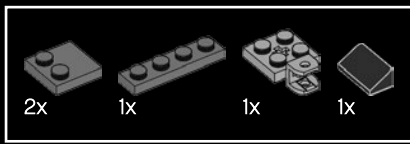

116

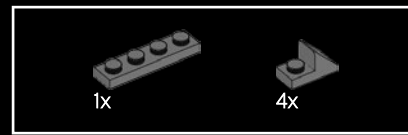
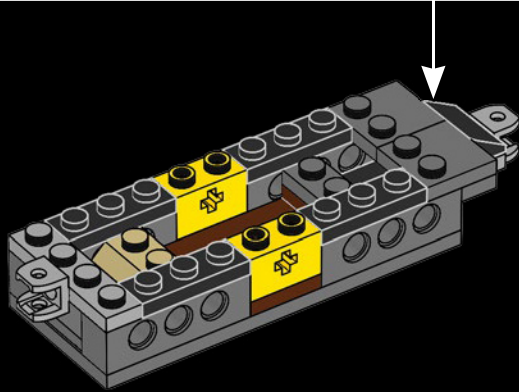
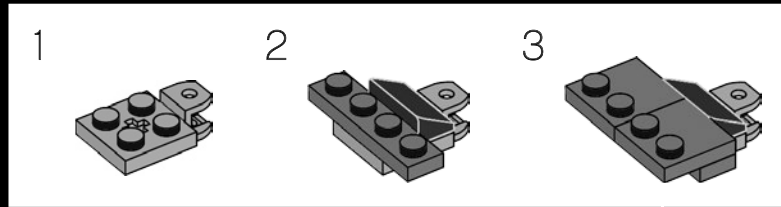

117

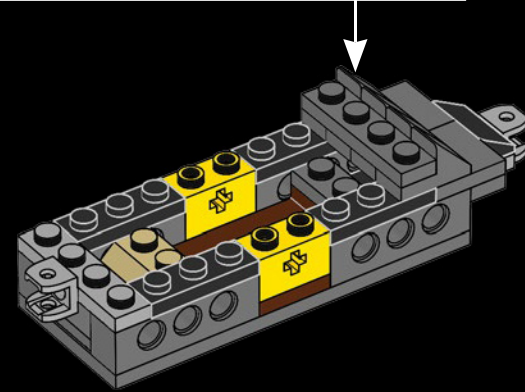
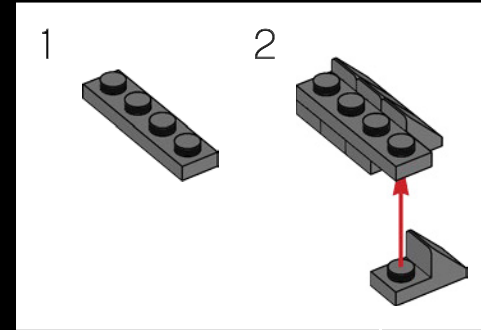

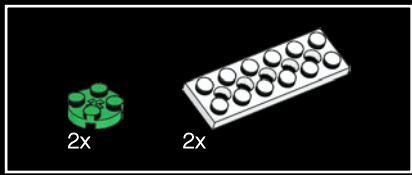

118

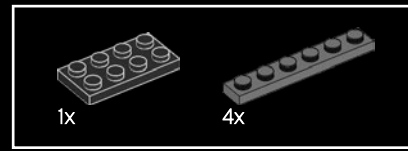
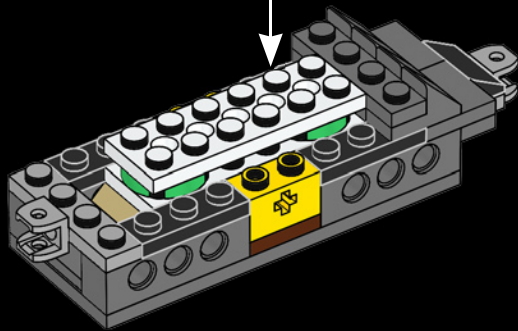
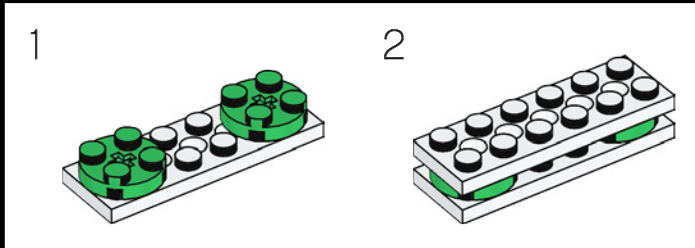

119

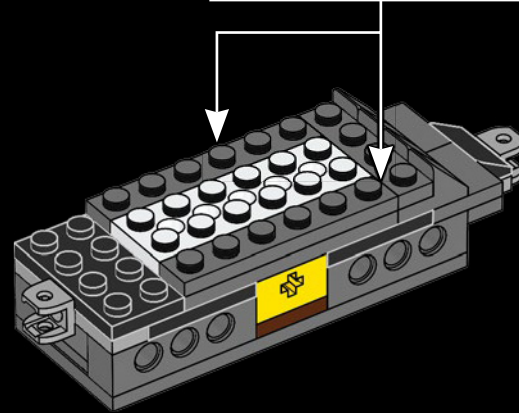
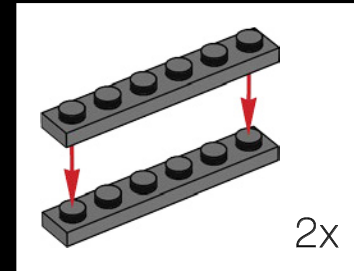



120

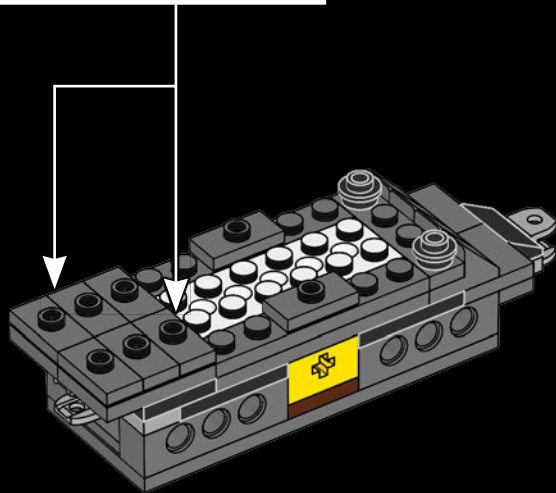
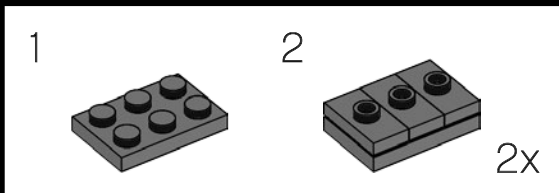

121

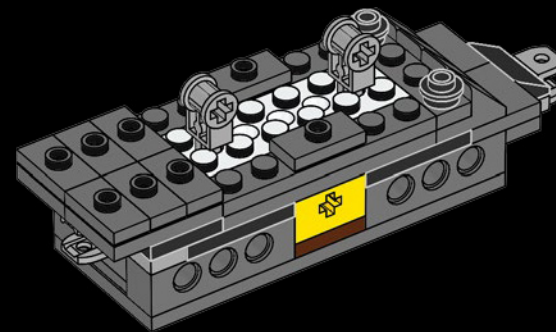



122

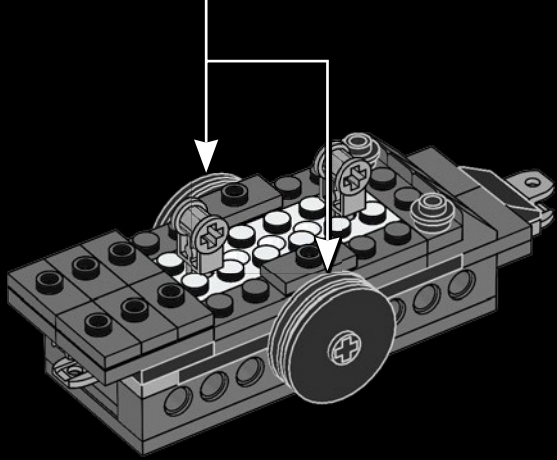
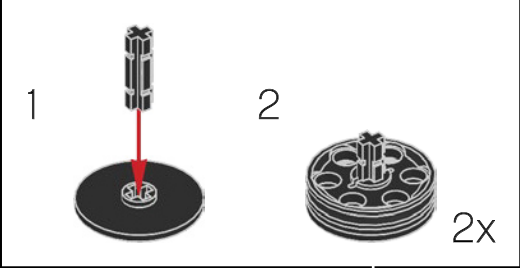

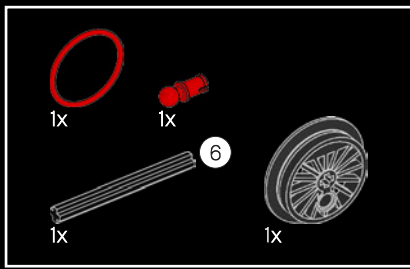

123

1

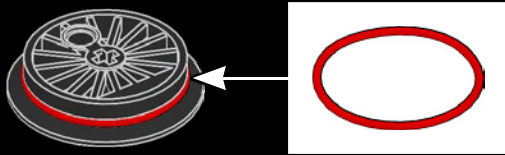

2



3

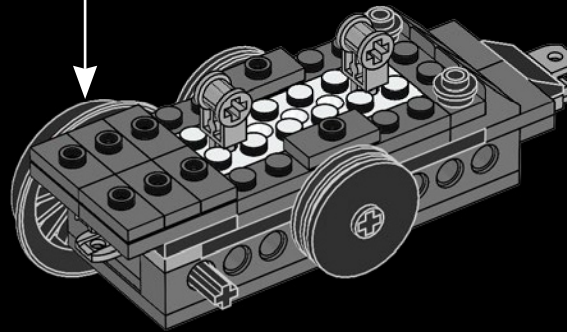
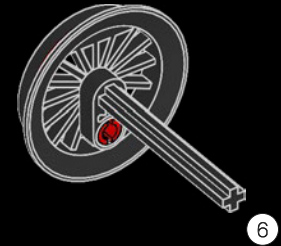
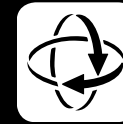

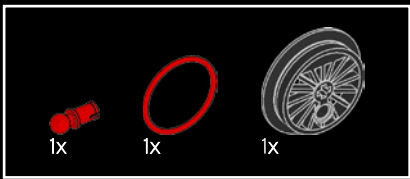

124

1

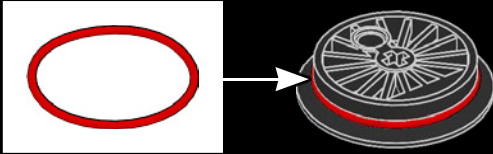

2

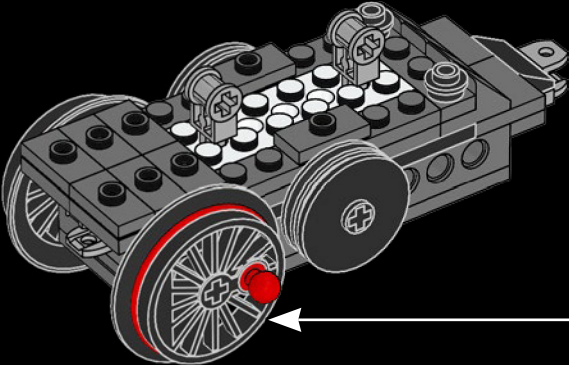

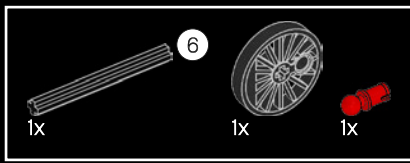

125

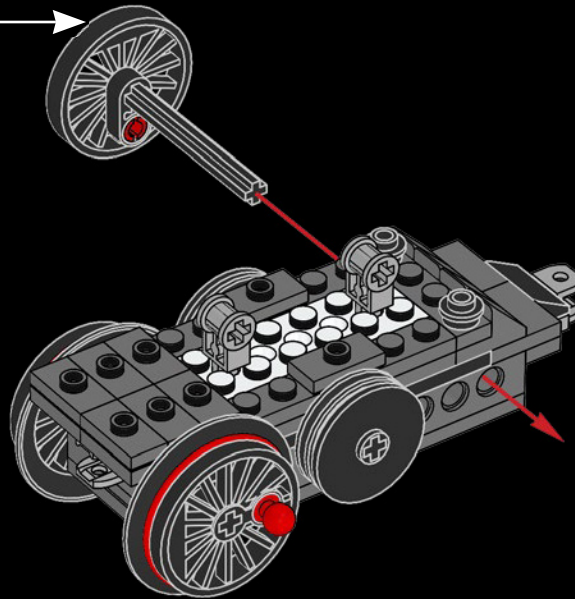
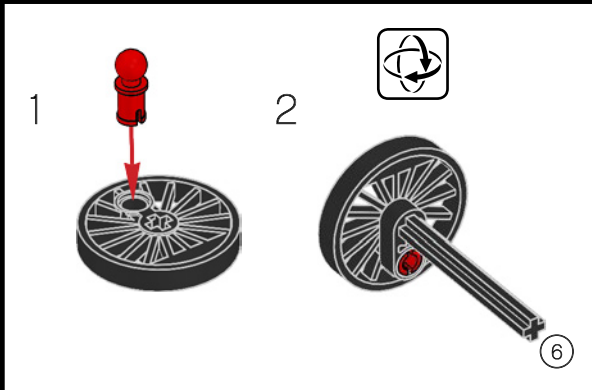

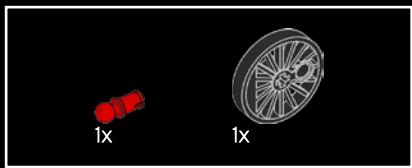

126

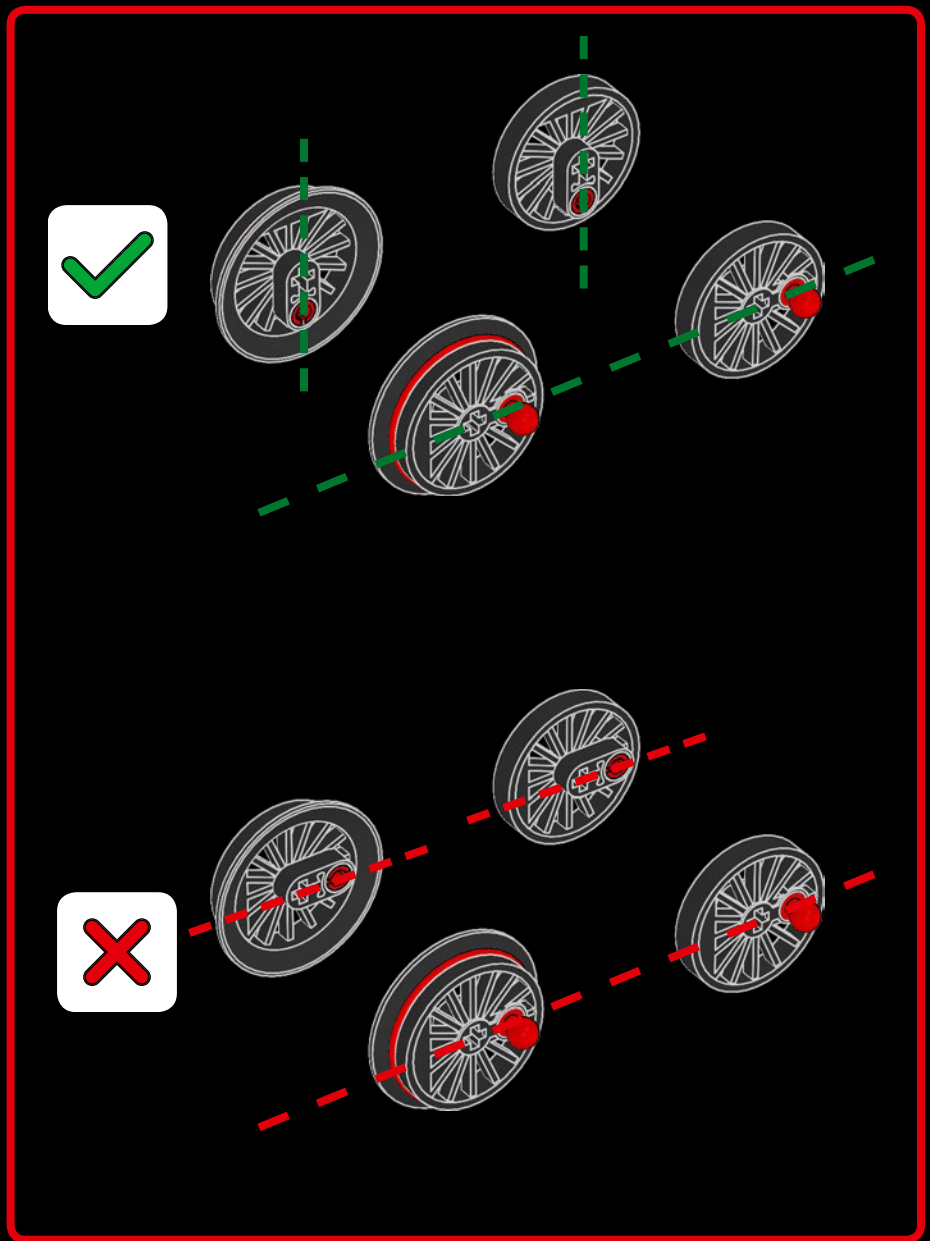
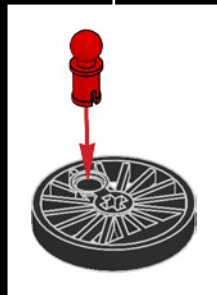
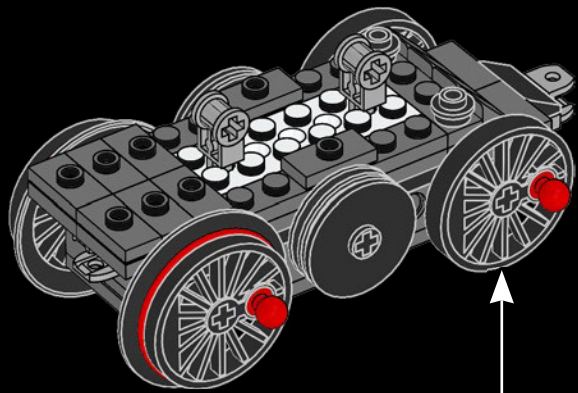

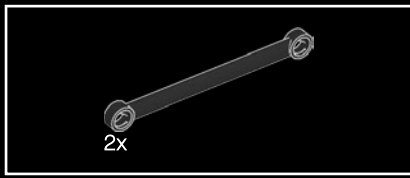

127

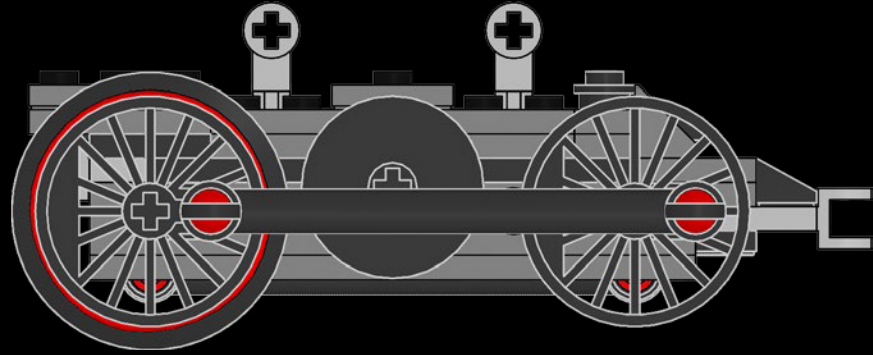
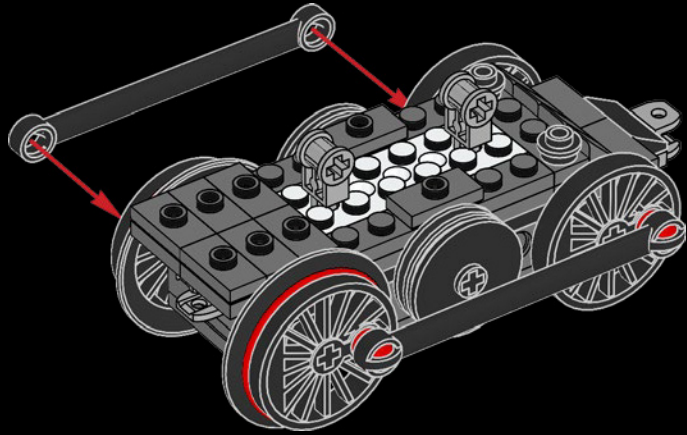

1:1

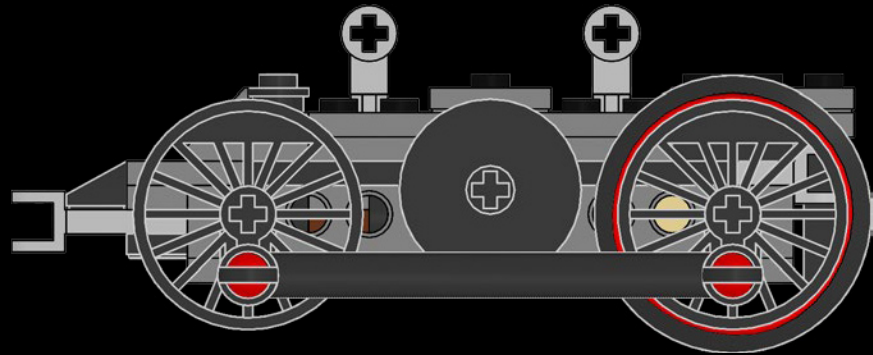

1:1

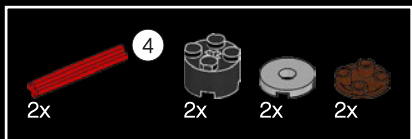

128

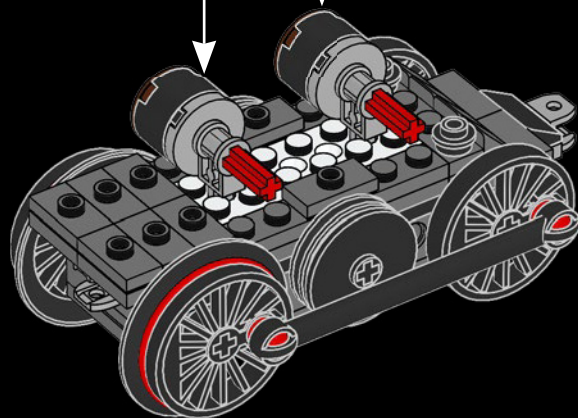
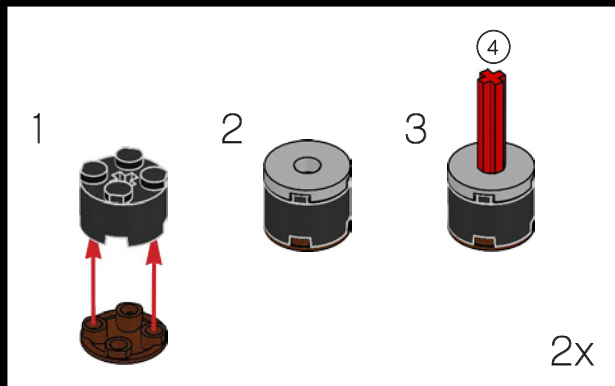



129

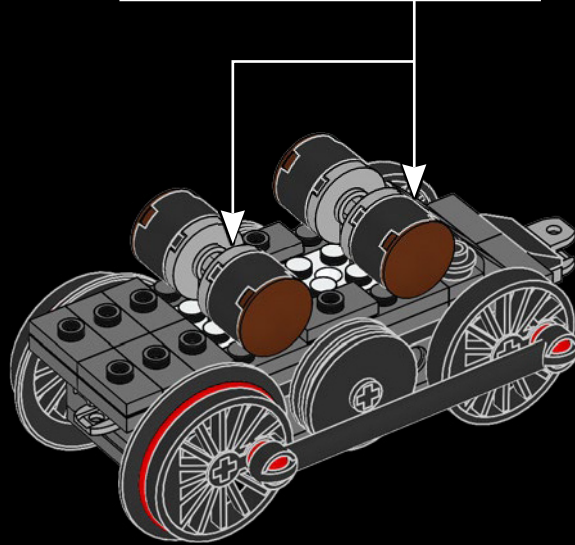
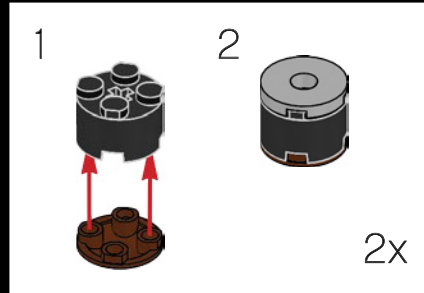

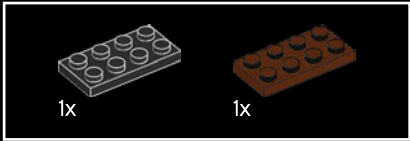
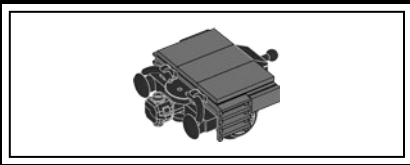

130

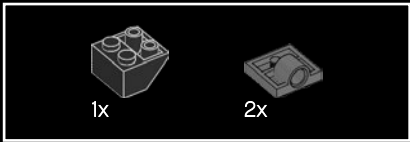
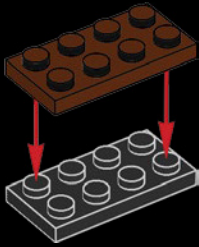

131

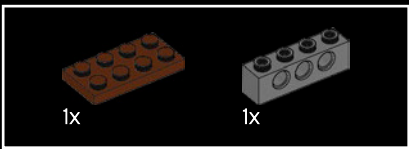
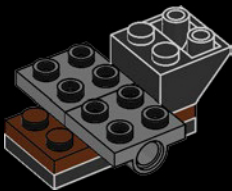

132

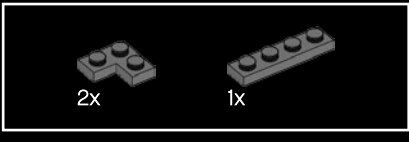
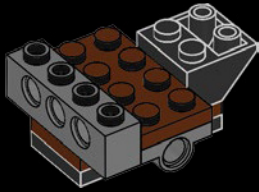

133

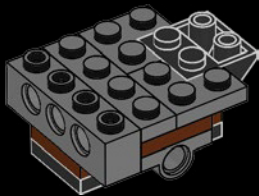

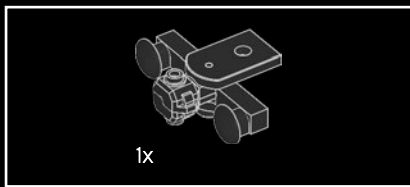

134

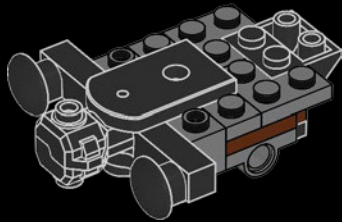

135

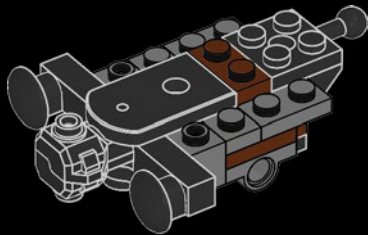

136

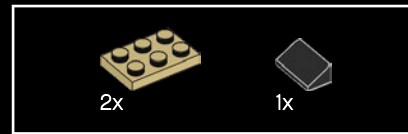
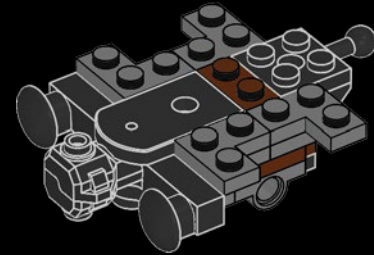

137

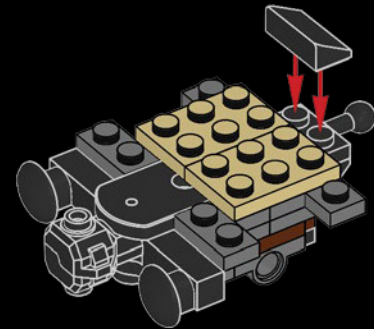

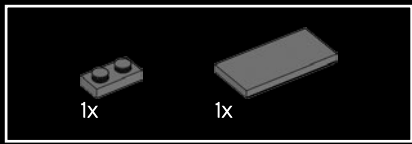

138

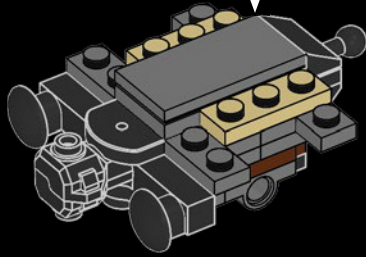
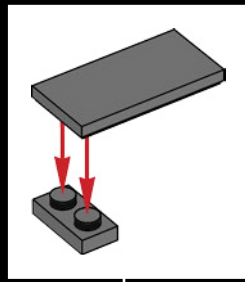

139

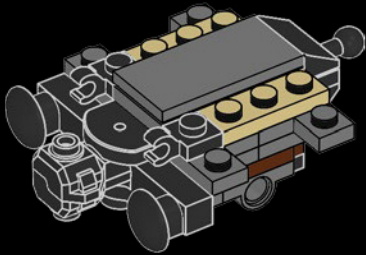

140

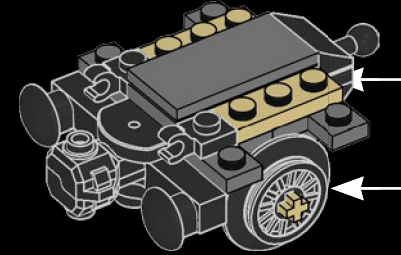
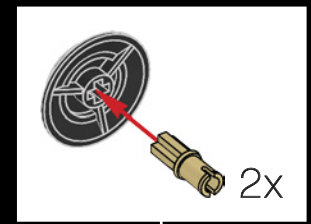

141

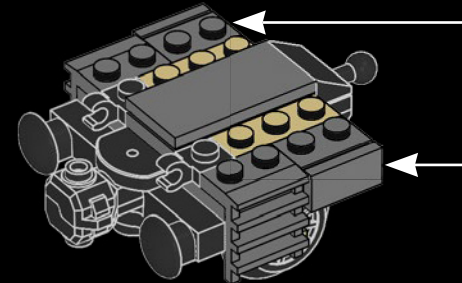
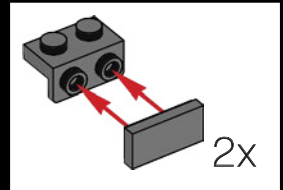

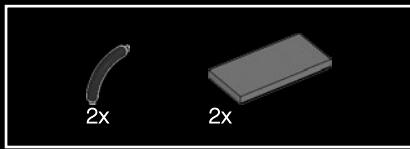

142

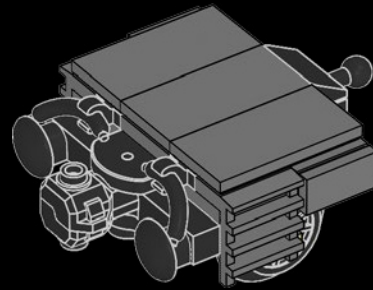

143

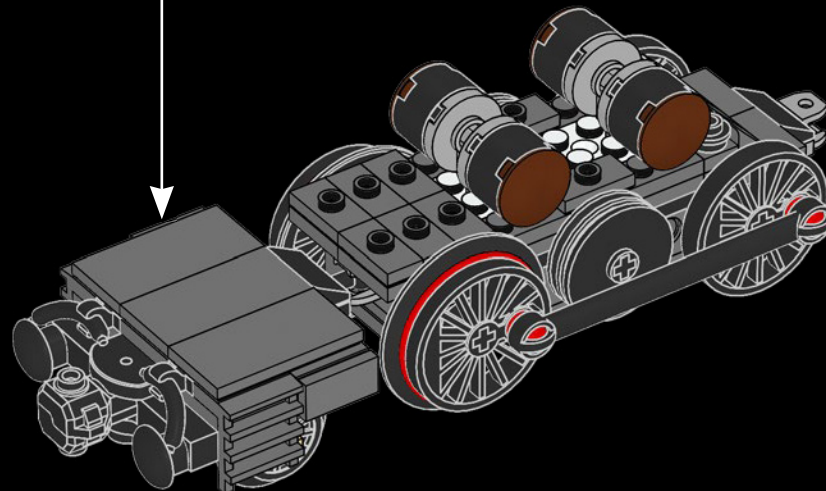

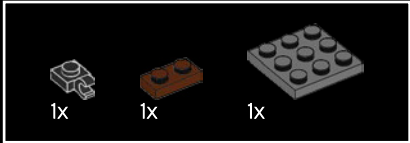
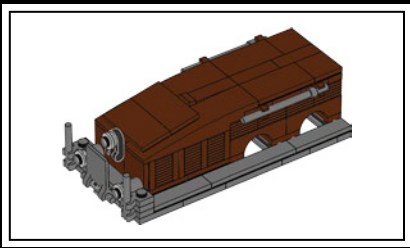

144

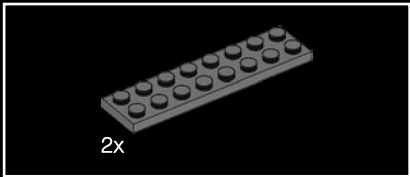
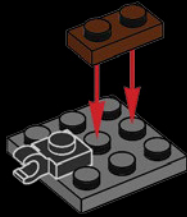

145

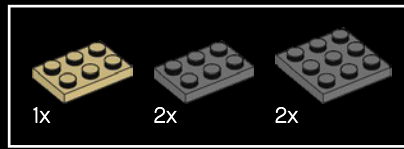
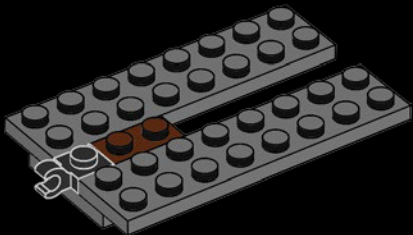

146

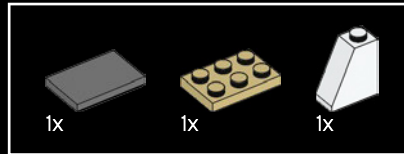
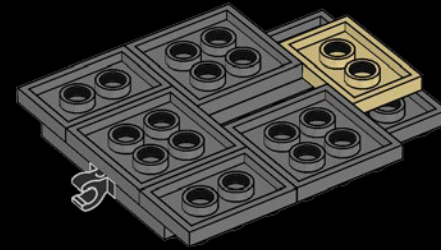

147

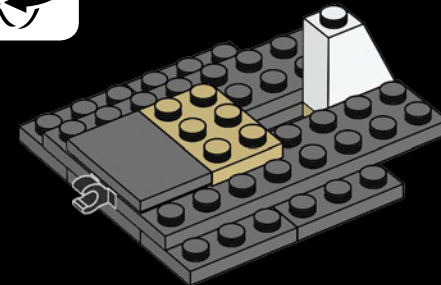

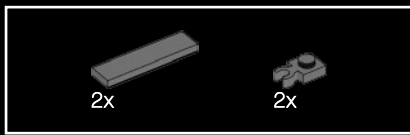

148

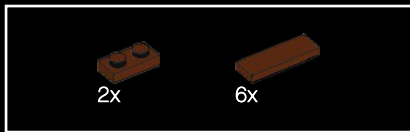
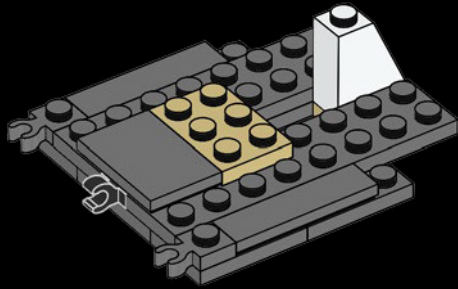

149

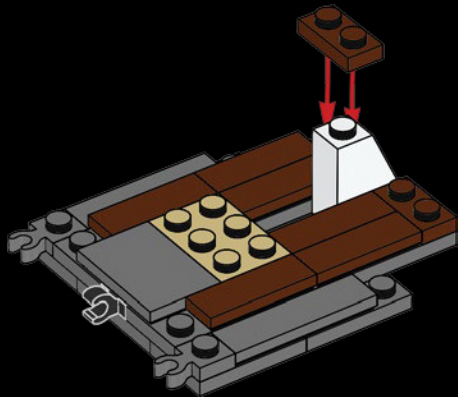

150

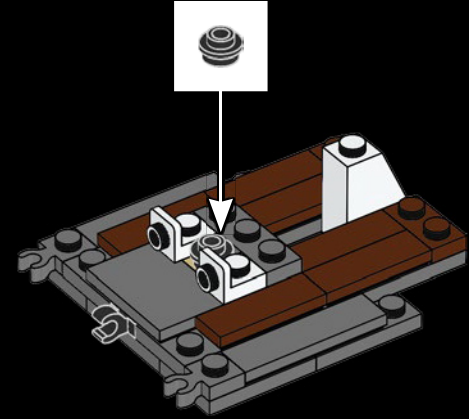

151

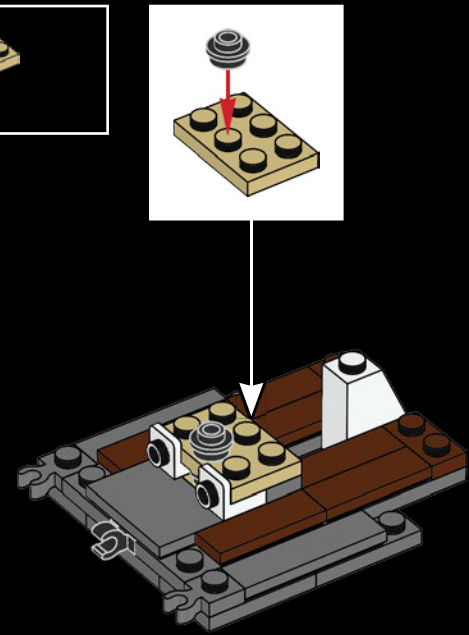

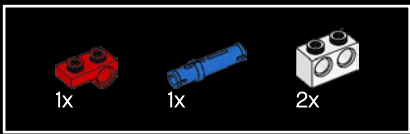

152

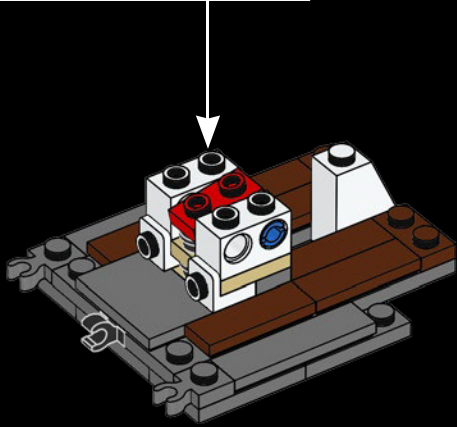
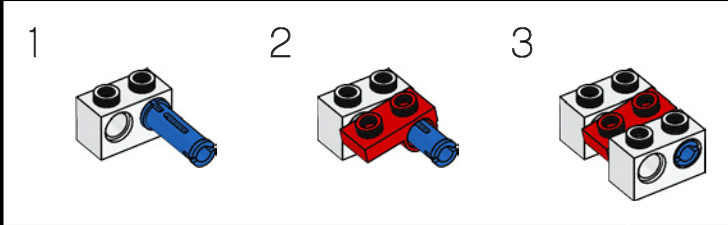

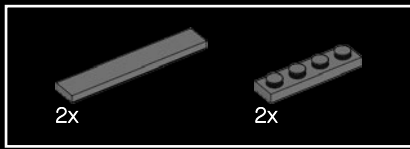

153

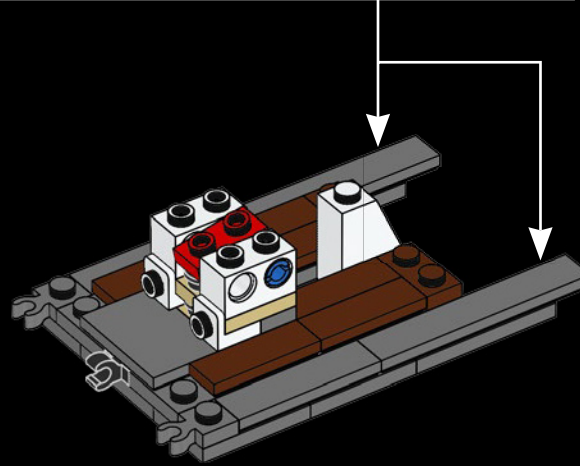
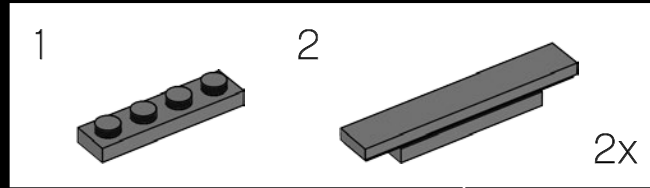



154

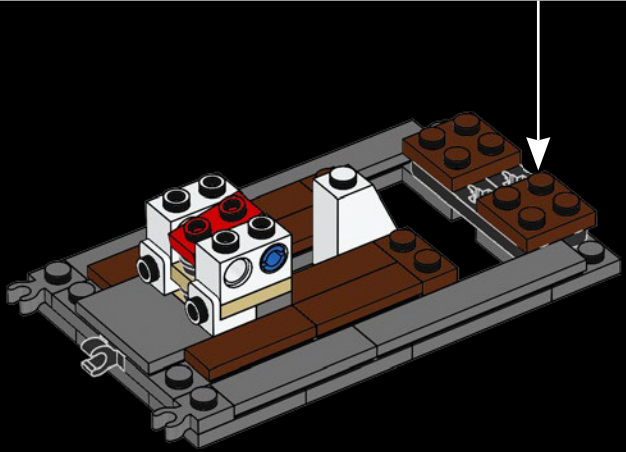
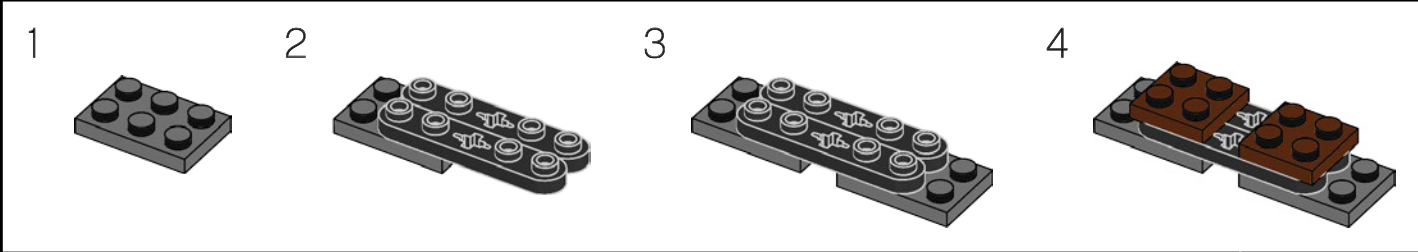

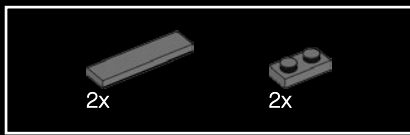

155

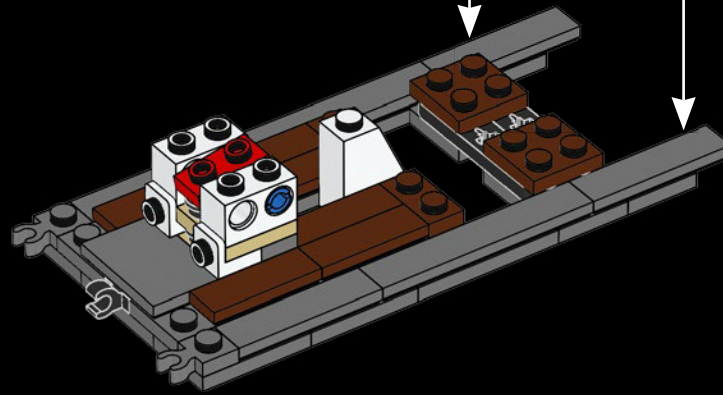
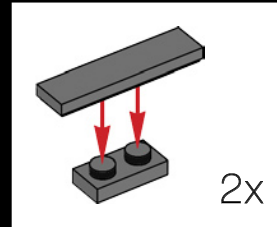

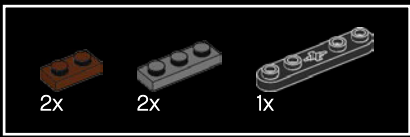

156

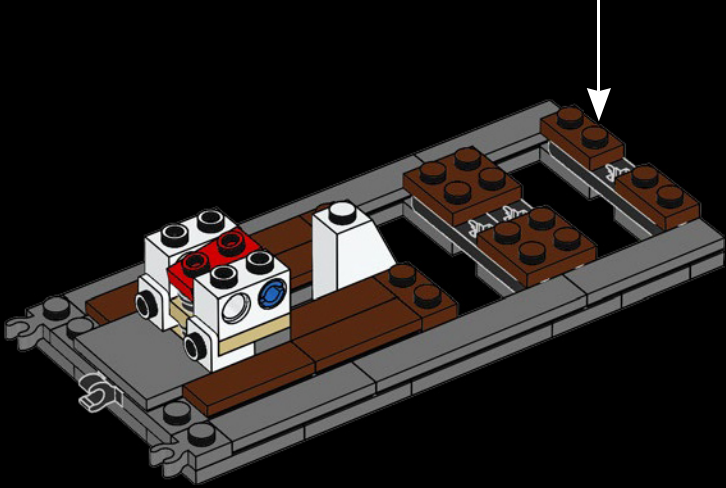
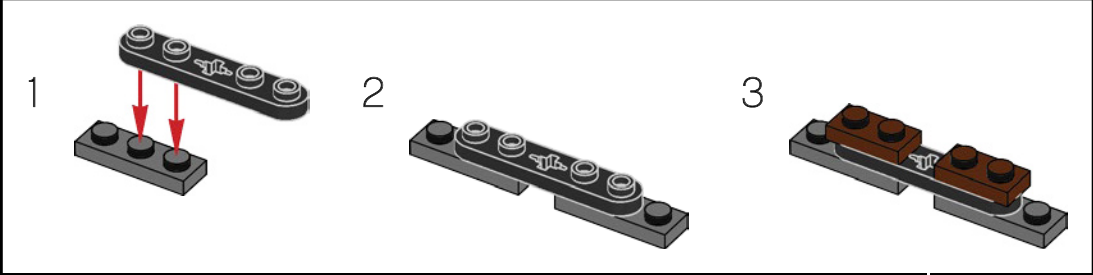

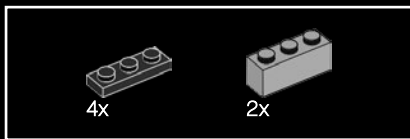

157

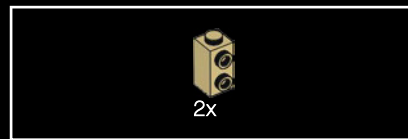
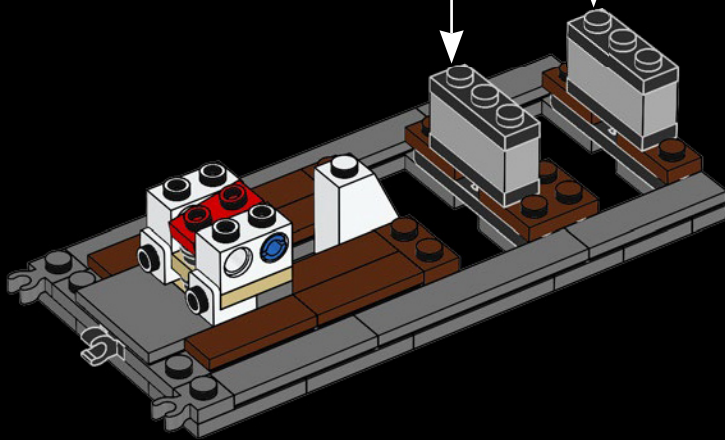
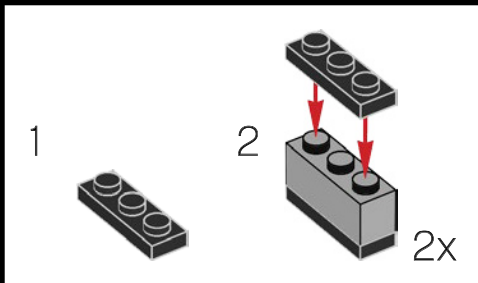

158

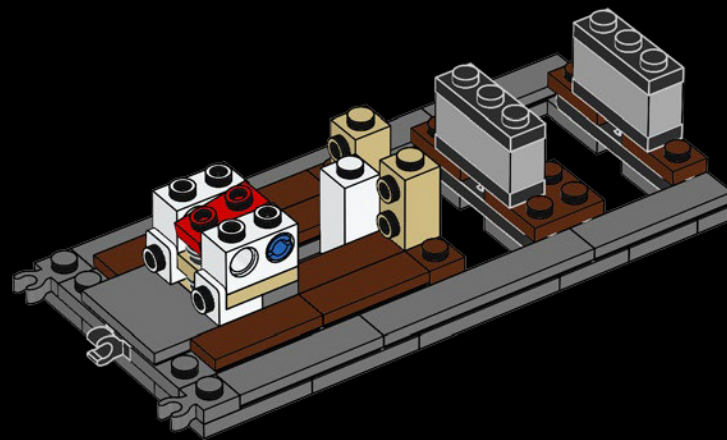

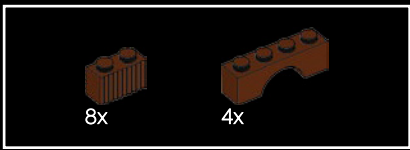

159

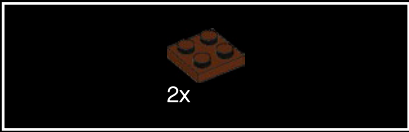
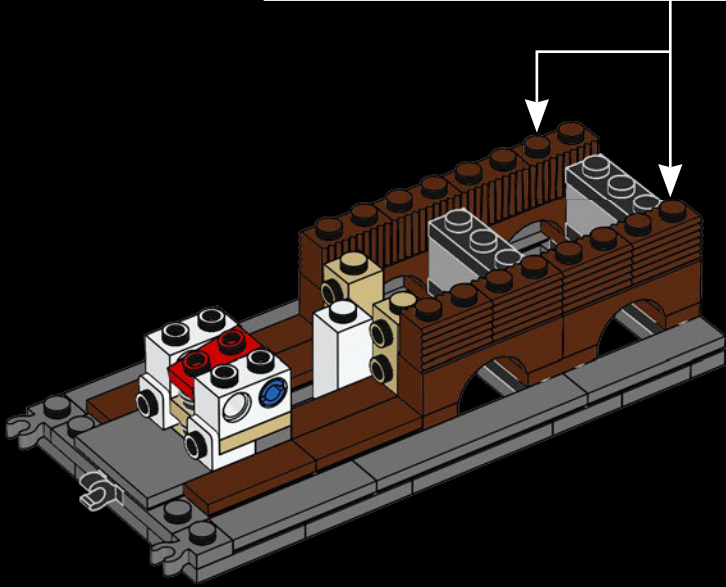
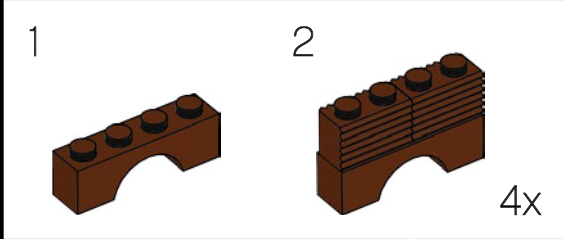

160

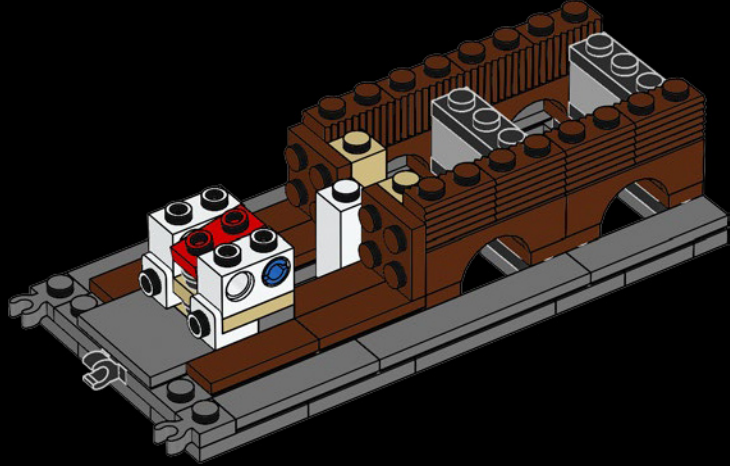

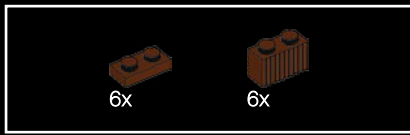

161

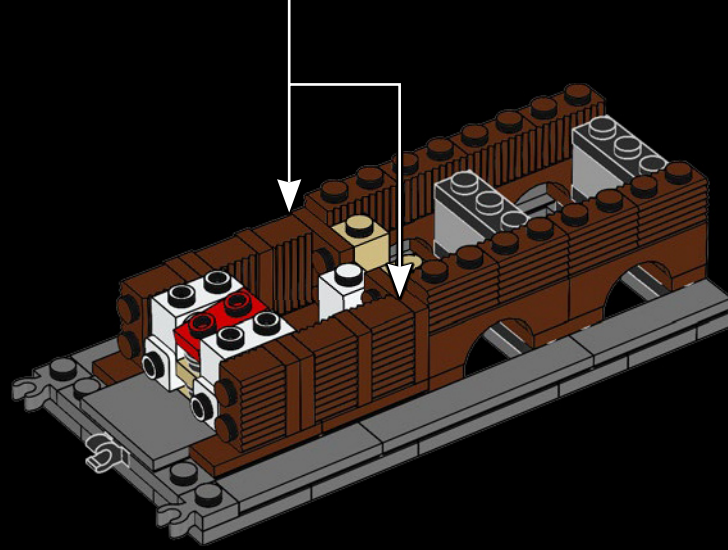
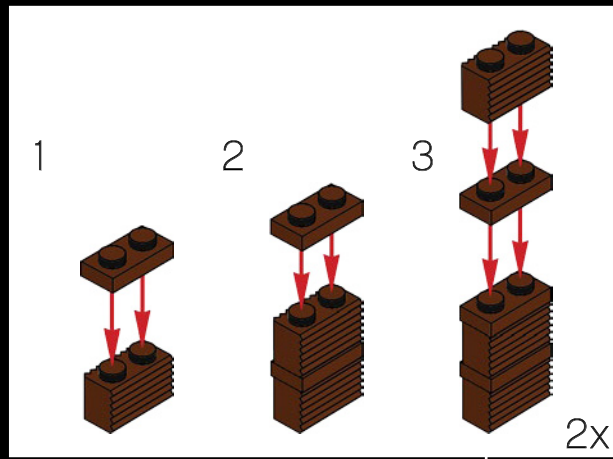

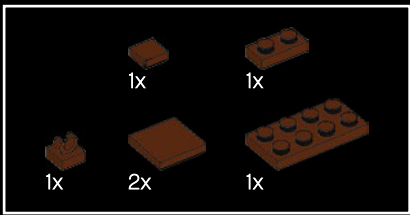

162

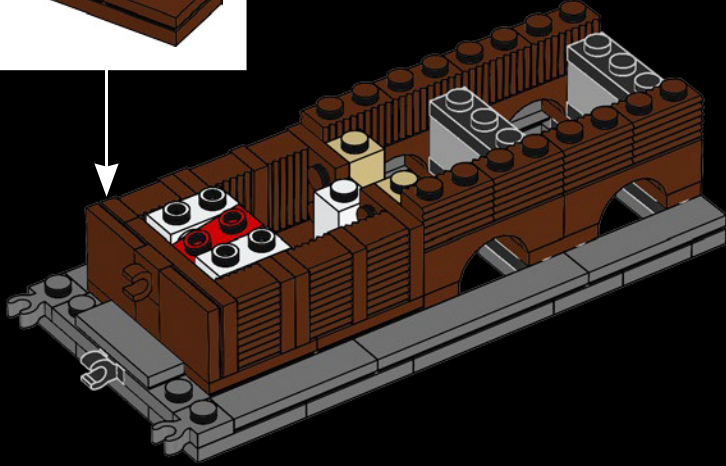
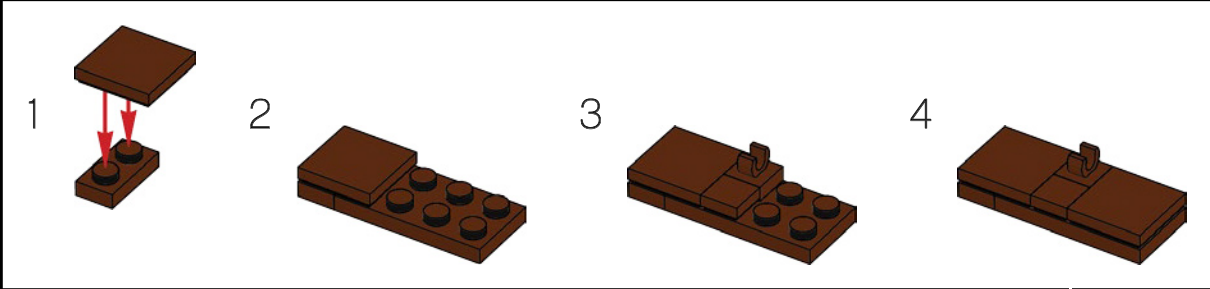



163

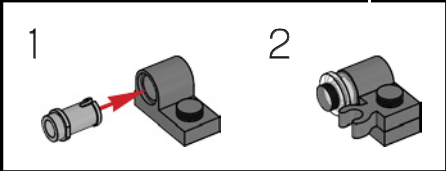
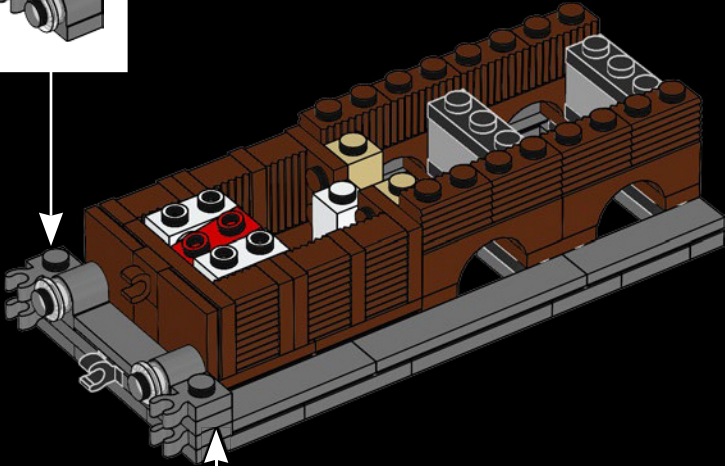
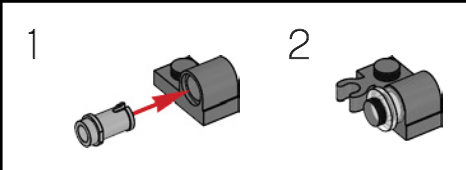

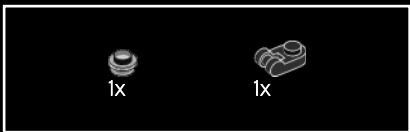

164

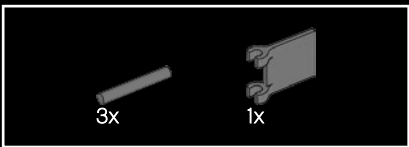
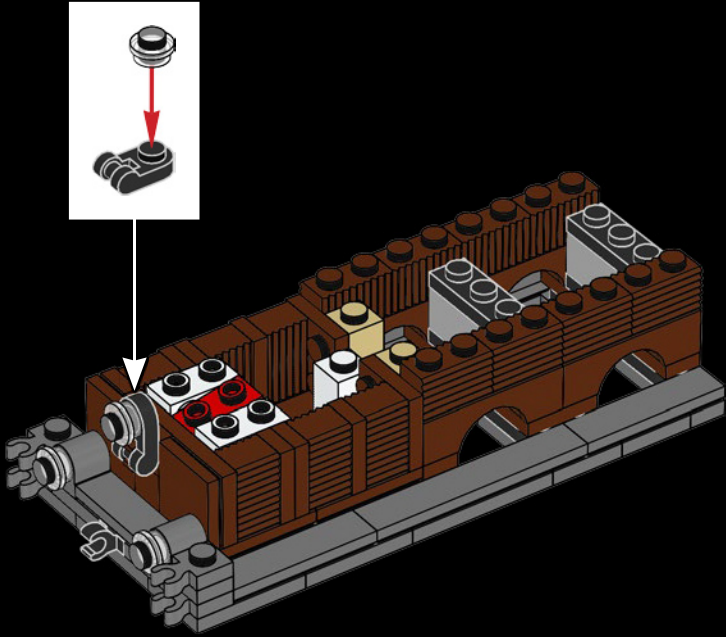

165

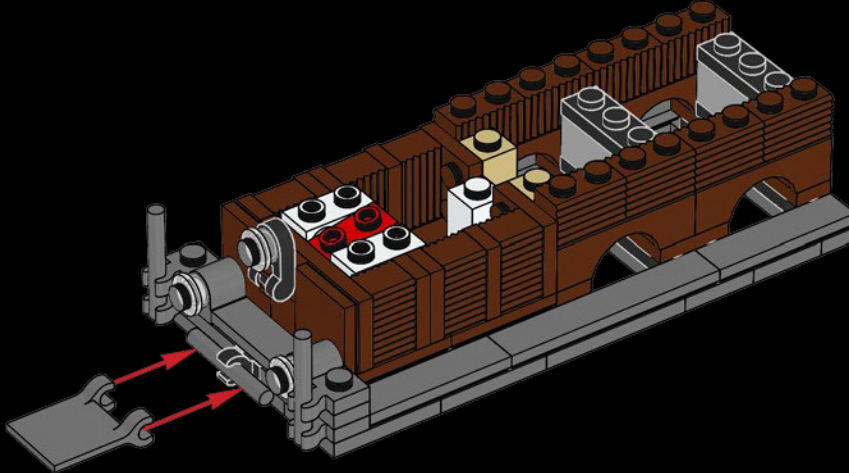

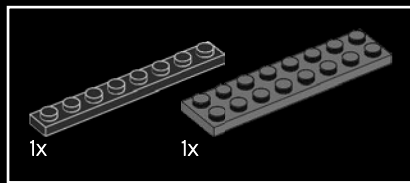

166

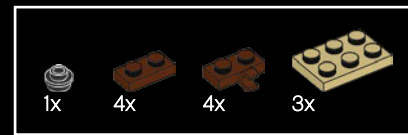
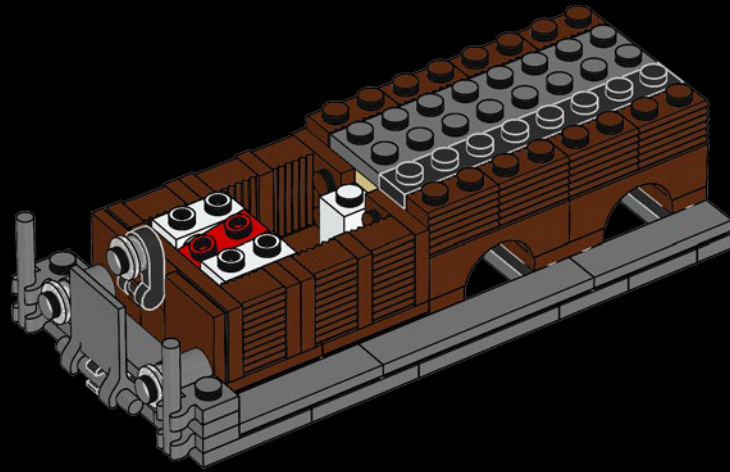

167

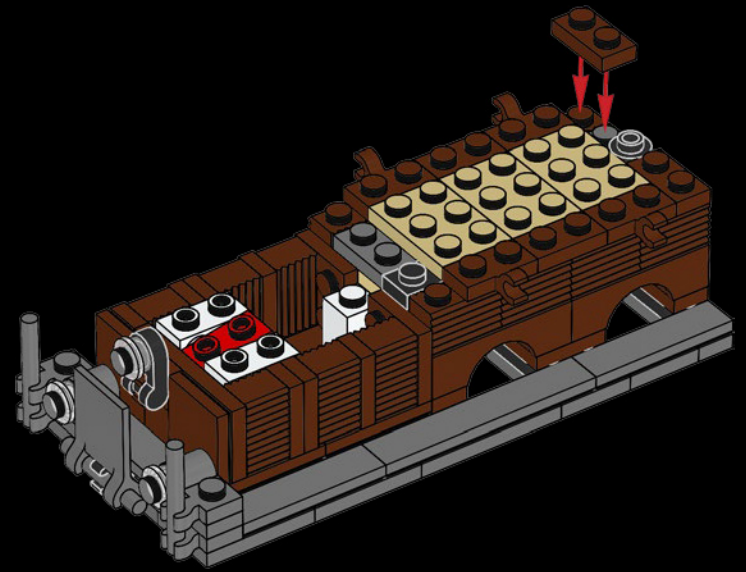

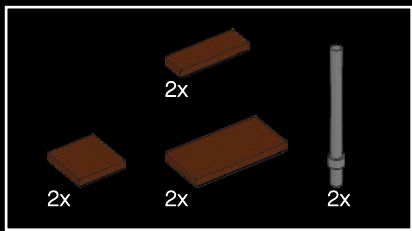

168

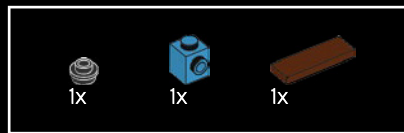
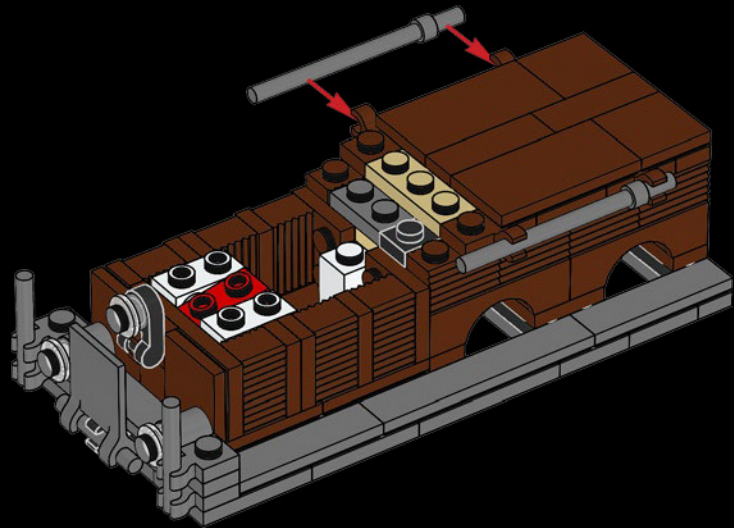

169

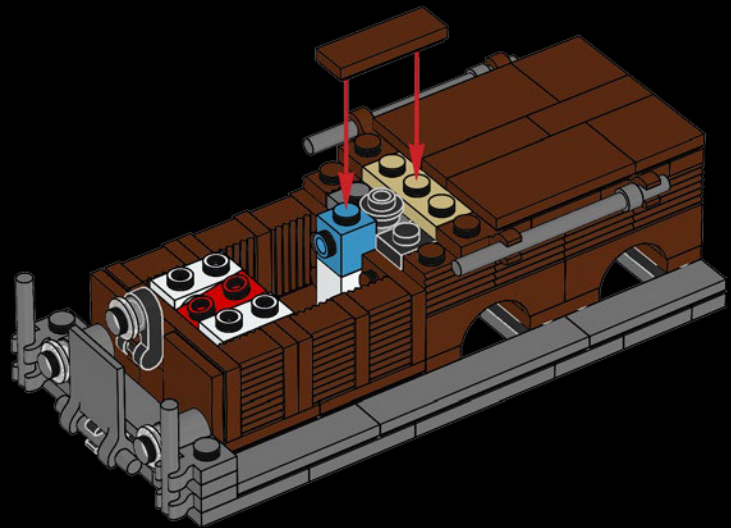

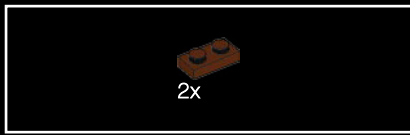

170

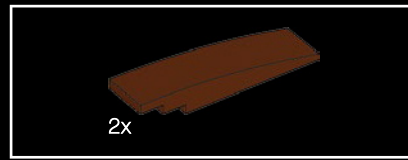
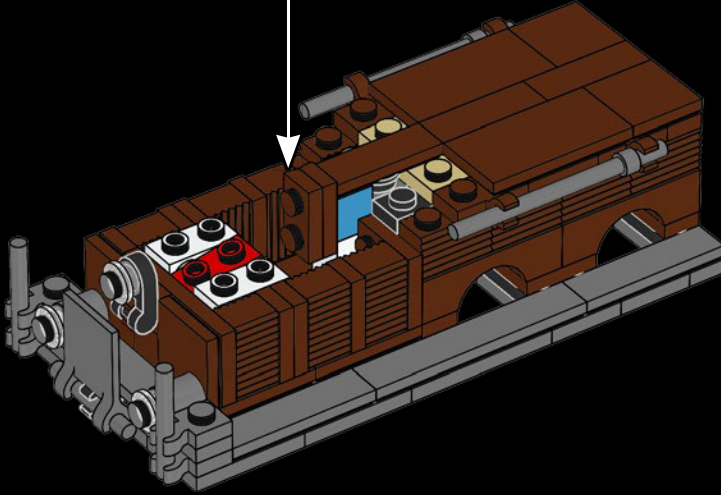
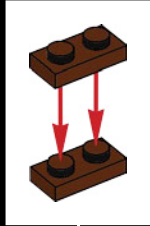

171

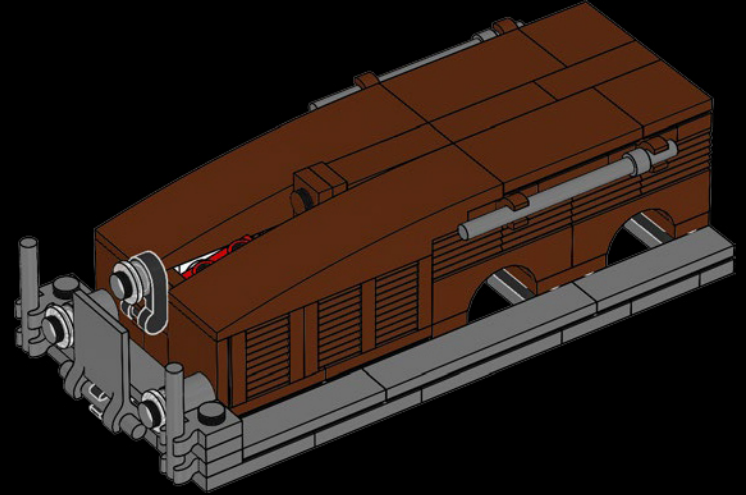

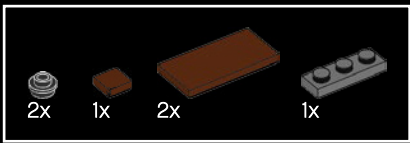

172

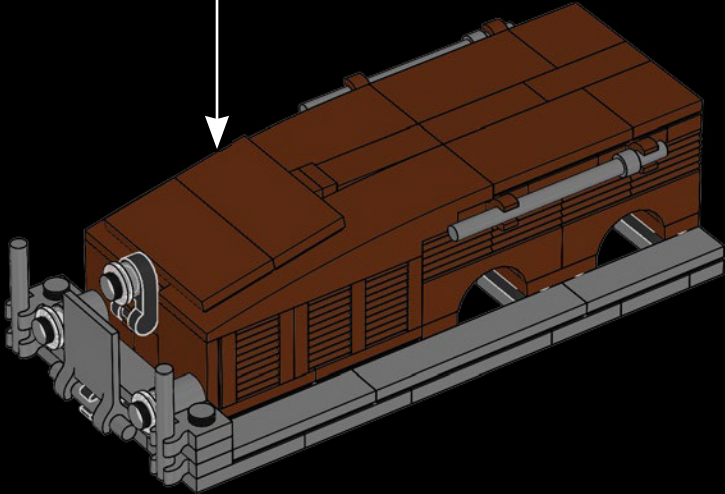
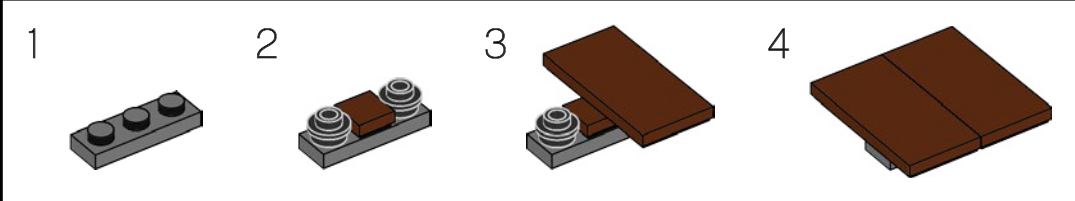

173

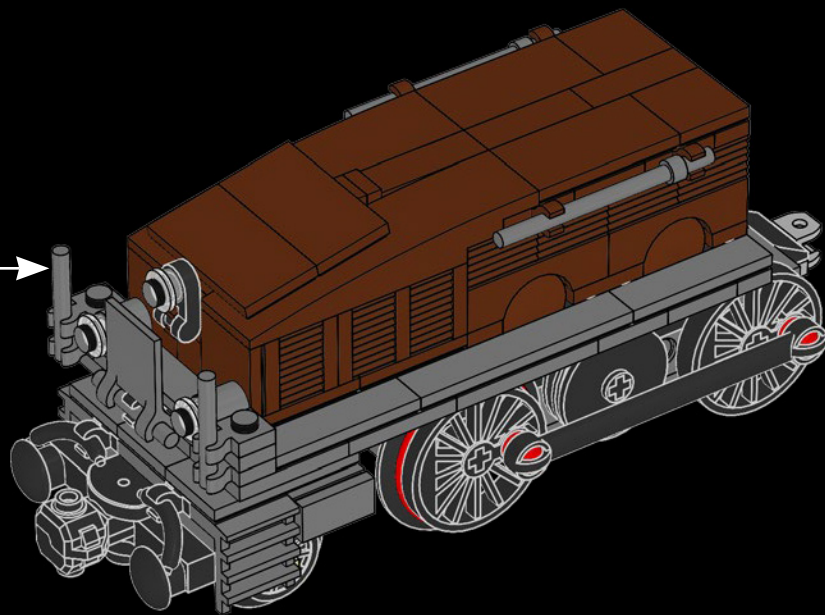

2x

174

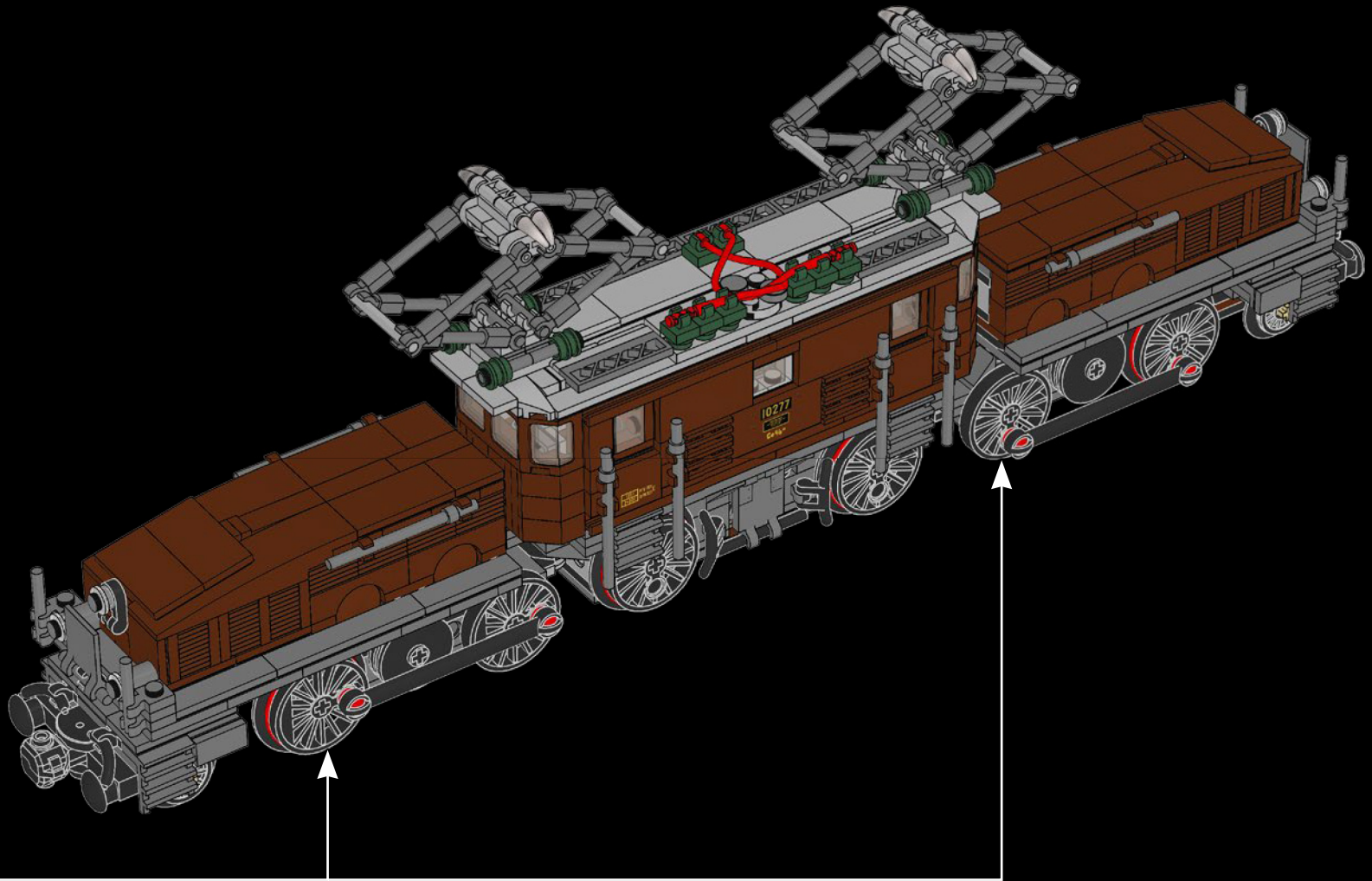

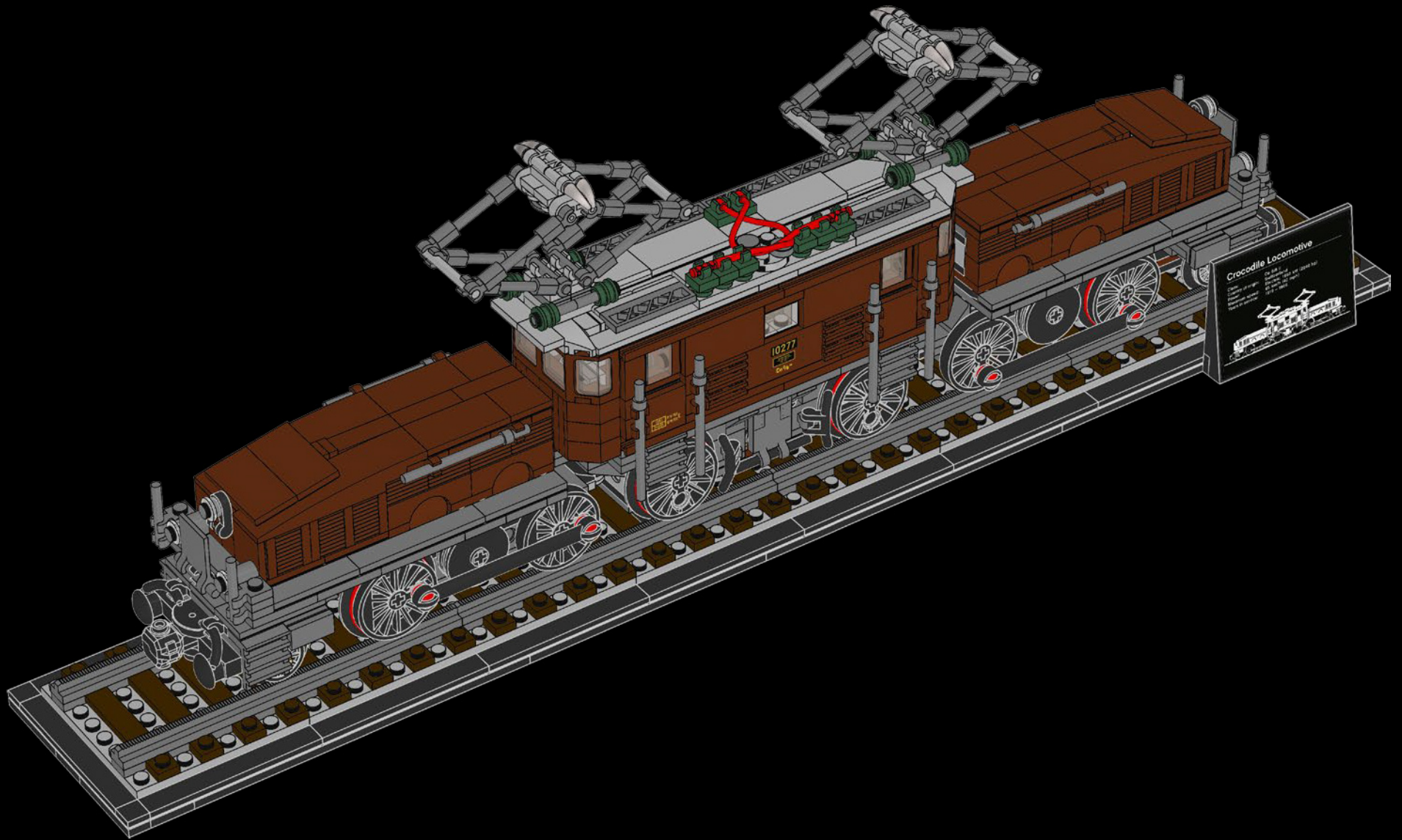

Crocodile Locomotive
Class: DE 102
Capacity: 1200 t
Power: 1200 kW
Year: 1960

Ready for Powered Up
Compatible avec Powered Up
Compatible con Powered Up



10277

+



88009

+



88013

+



=



DOWNLOAD FREE APP!
TÉLÉCHARGE L'APPLI GRATUITE !
¡DESCARGA GRATIS LA APP!

ELECTRIC MOTORS
MOTEURS ÉLECTRIQUES
MOTORES ELÉCTRICOS

SMART DEVICE REQUIRED BUT NOT INCLUDED
APPAREIL INTELLIGENT REQUIS, MAIS NON INCLUS
SE REQUIERE UN DISPOSITIVO INTELIGENTE
(NO INCLUIDO)

1

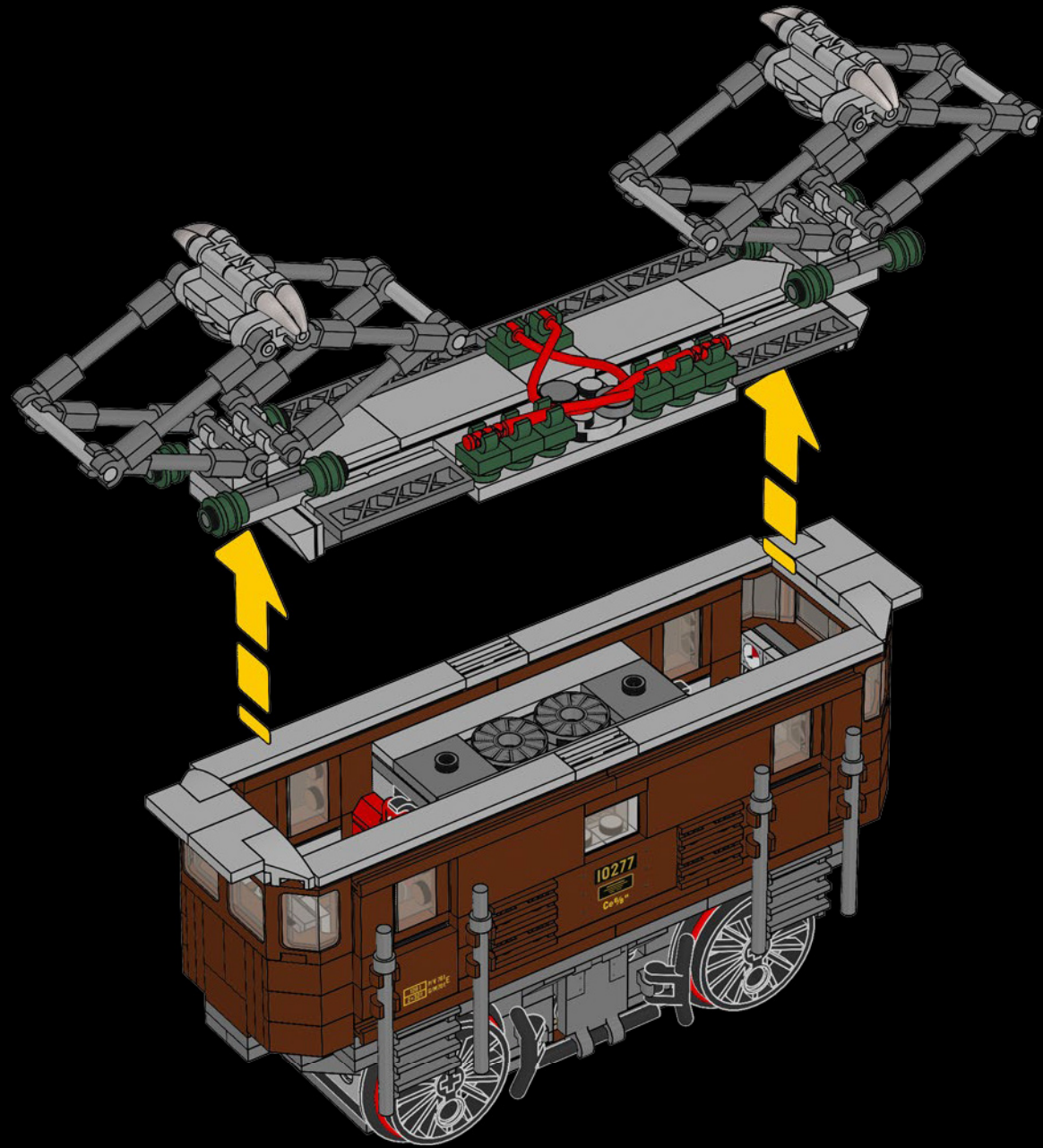

2

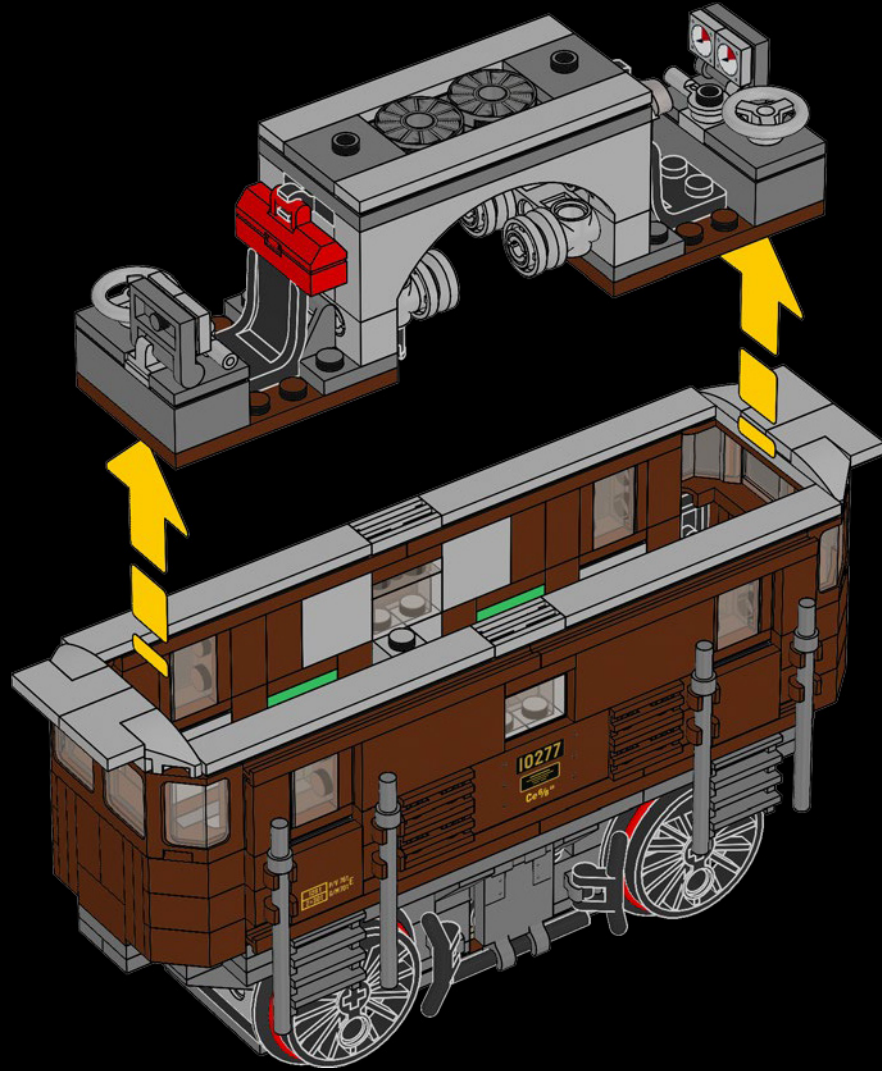

3

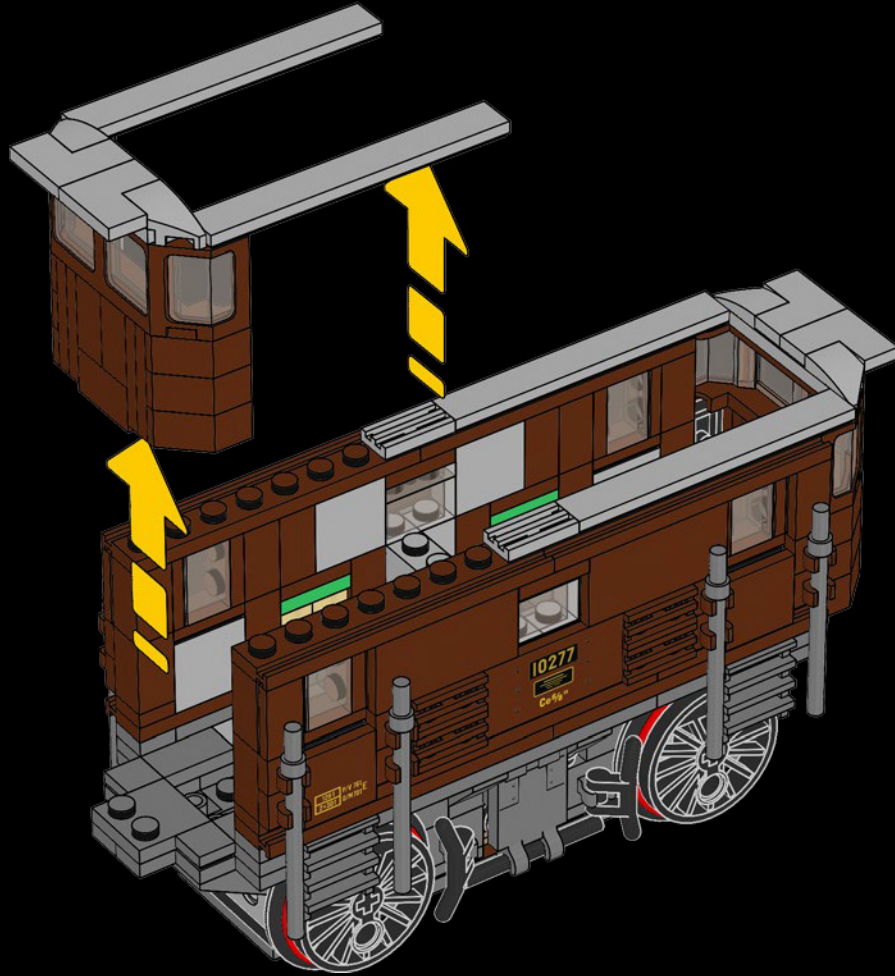

4

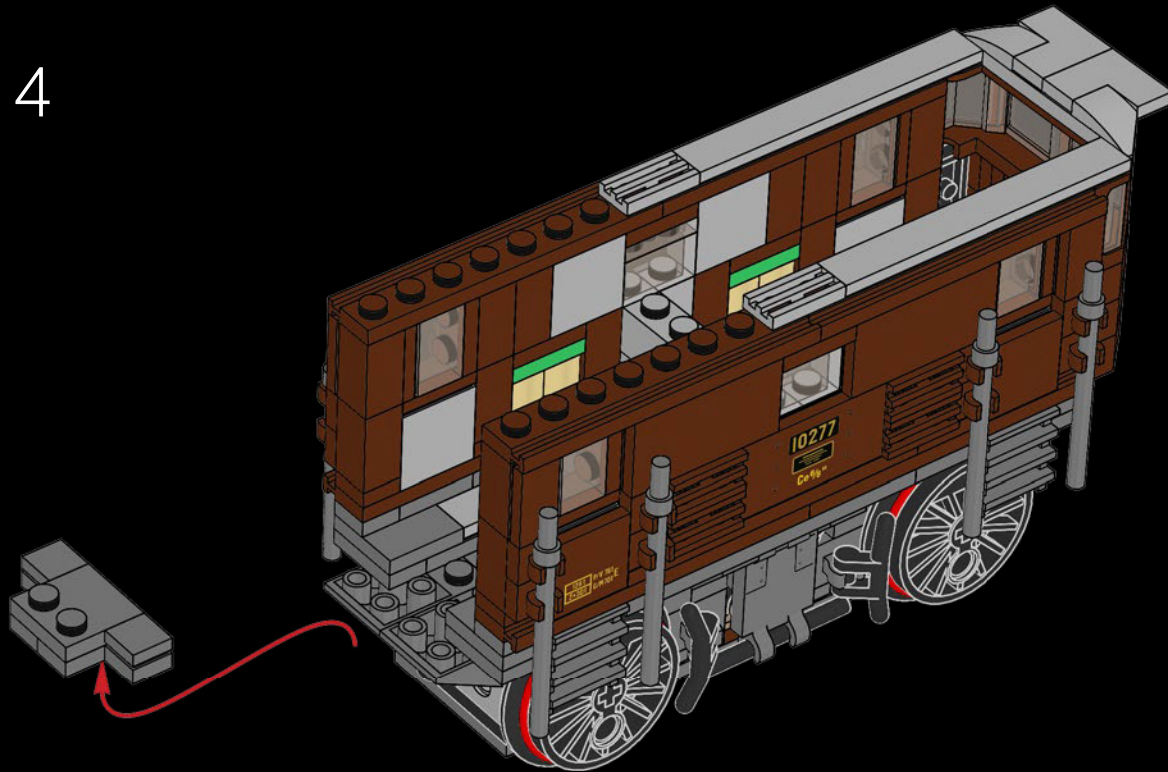

5

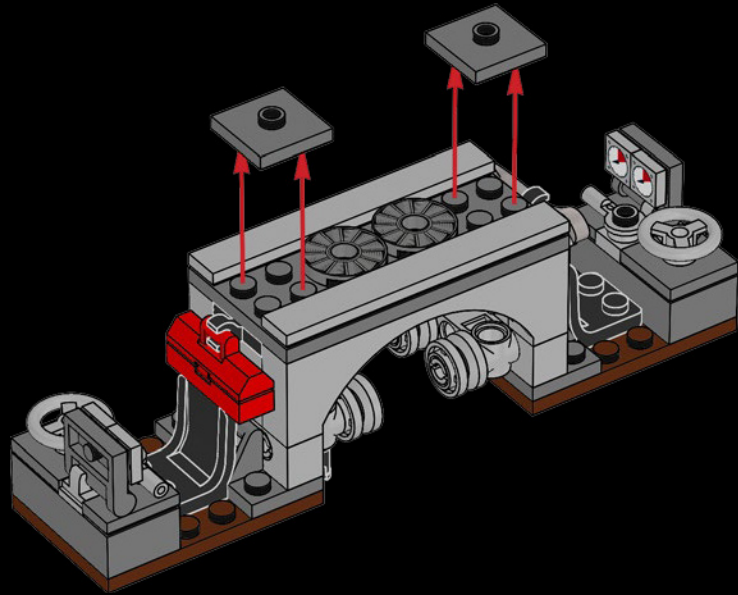

6

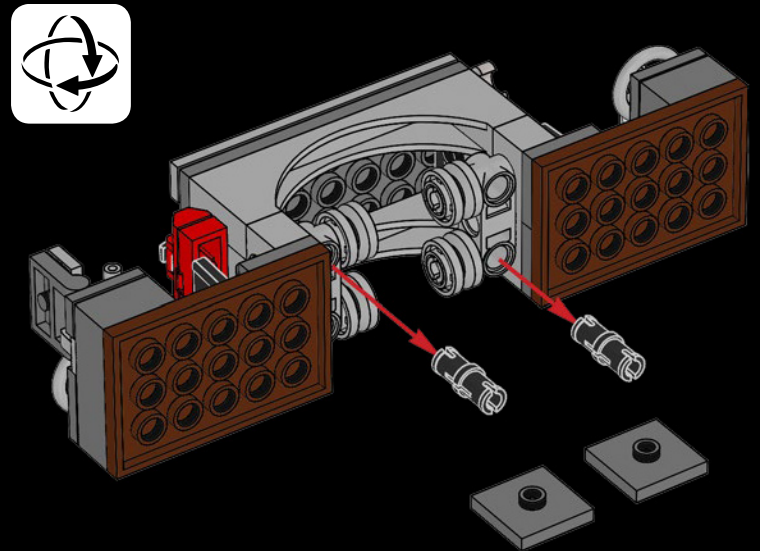

7

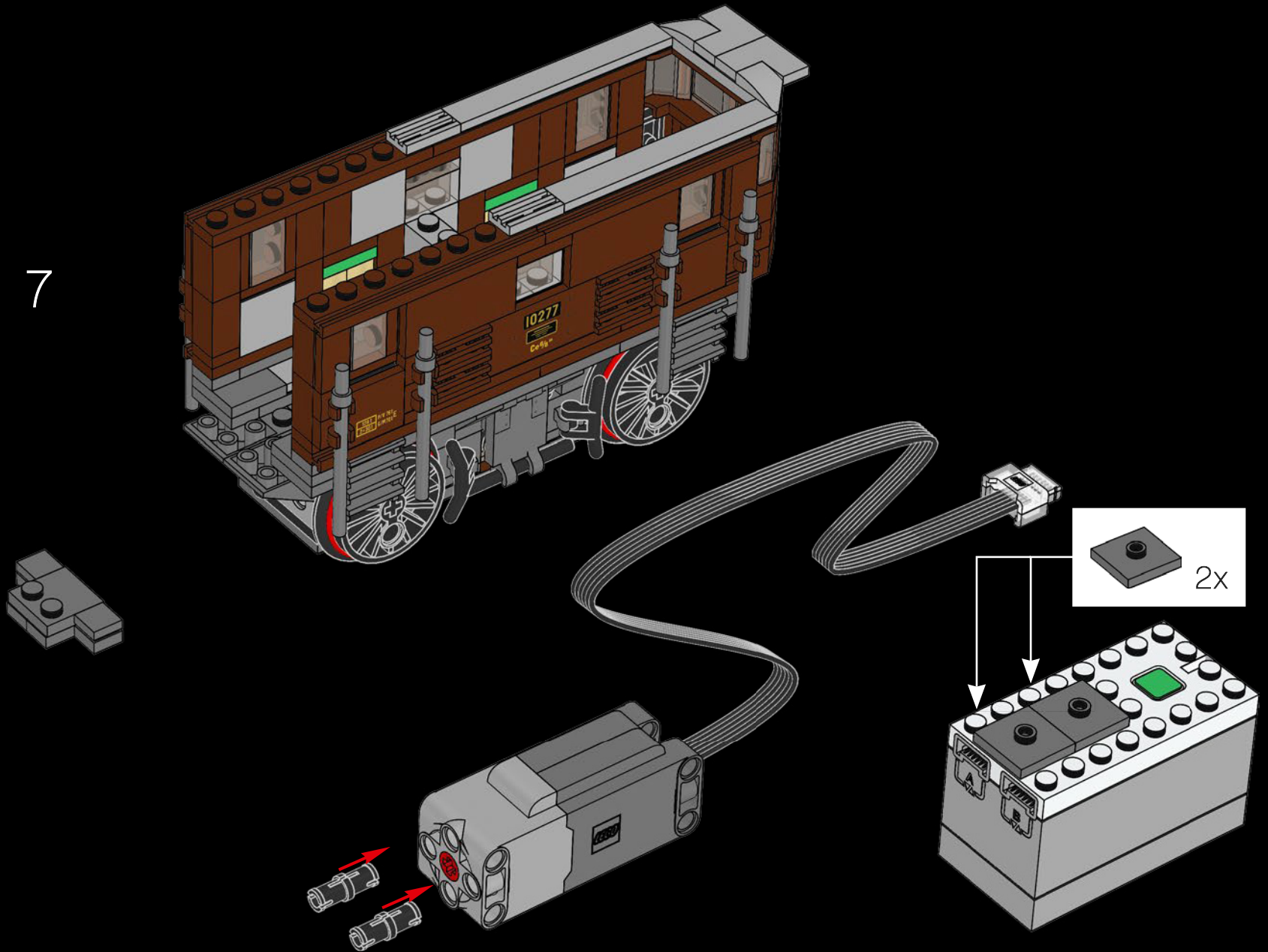

8

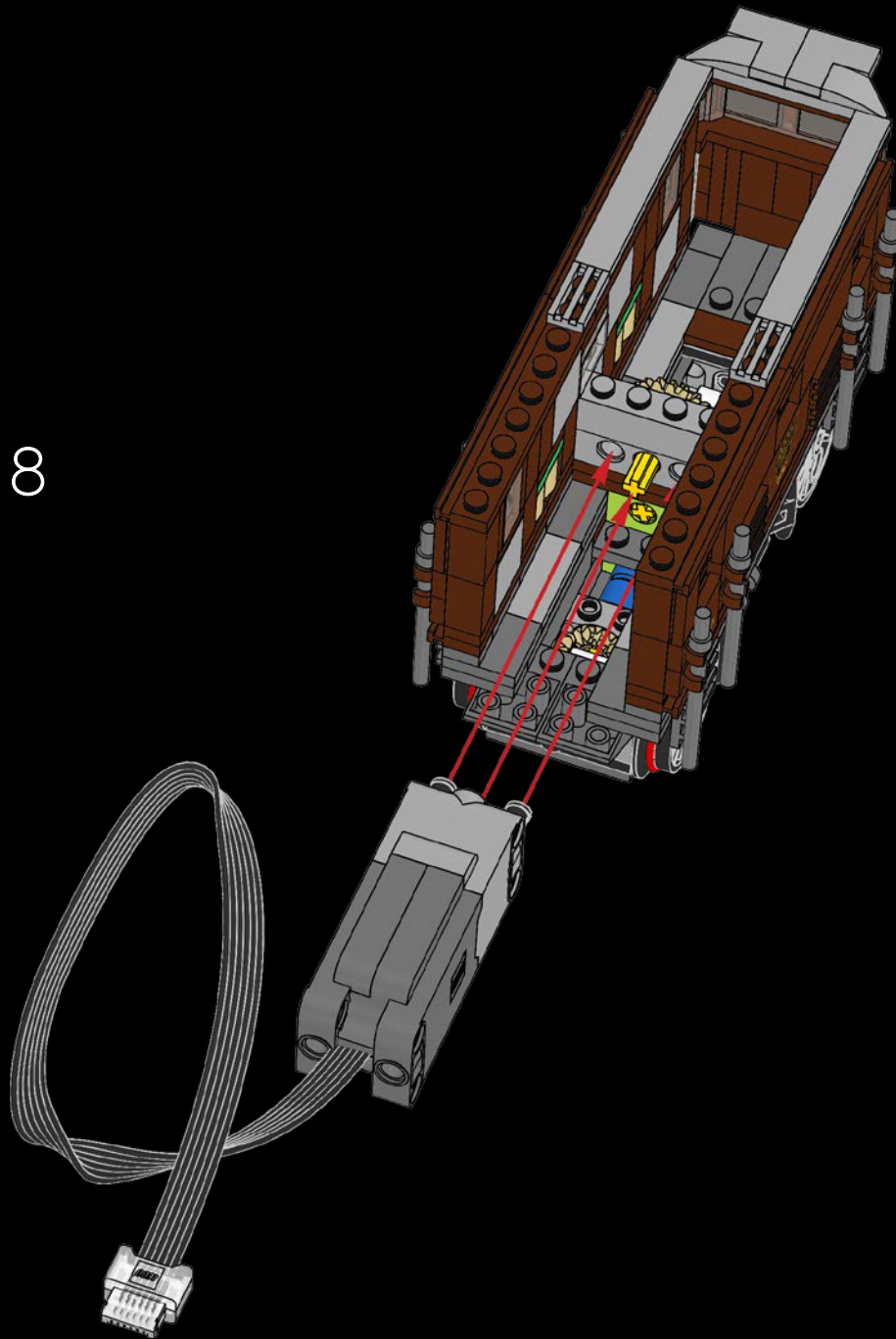

9

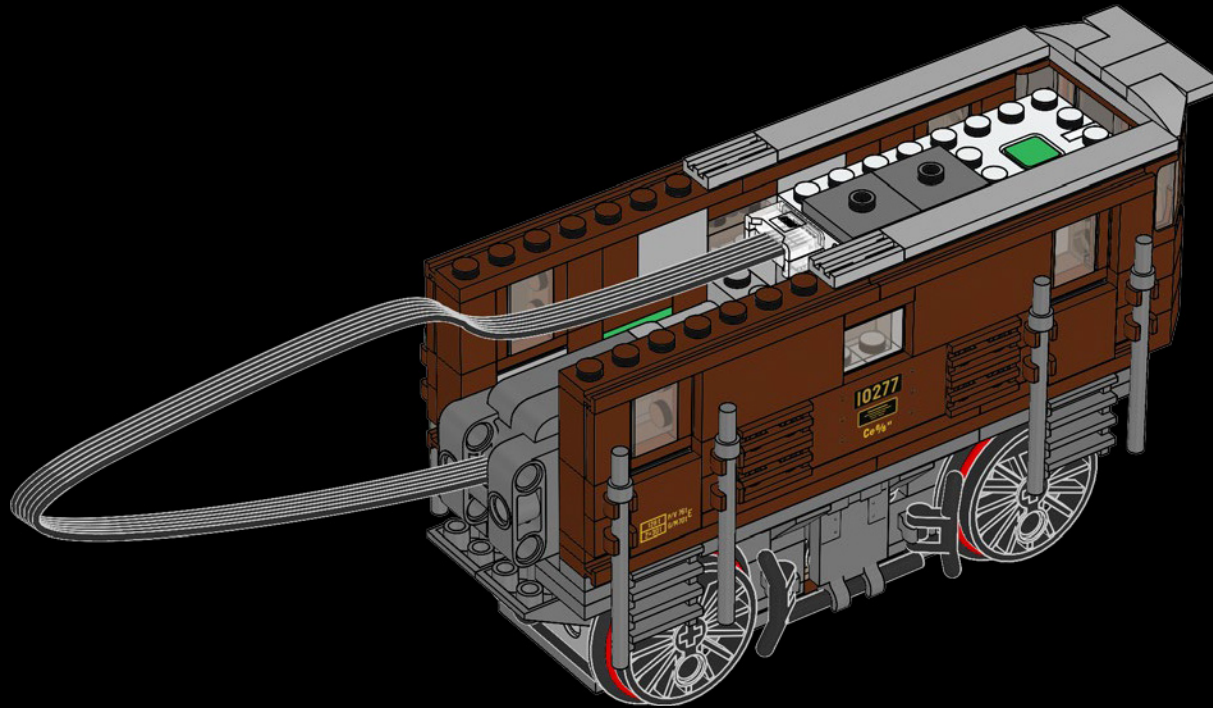

10

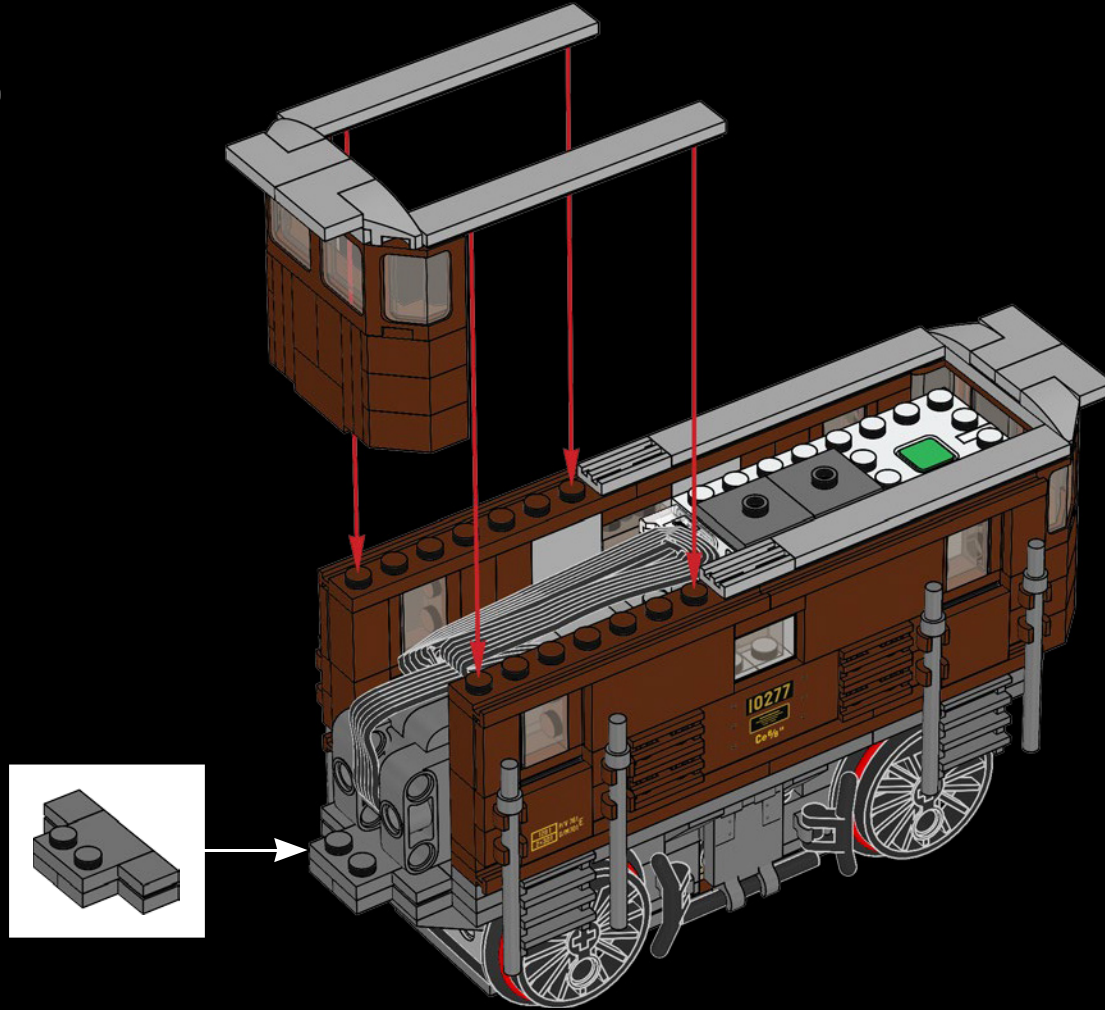

11

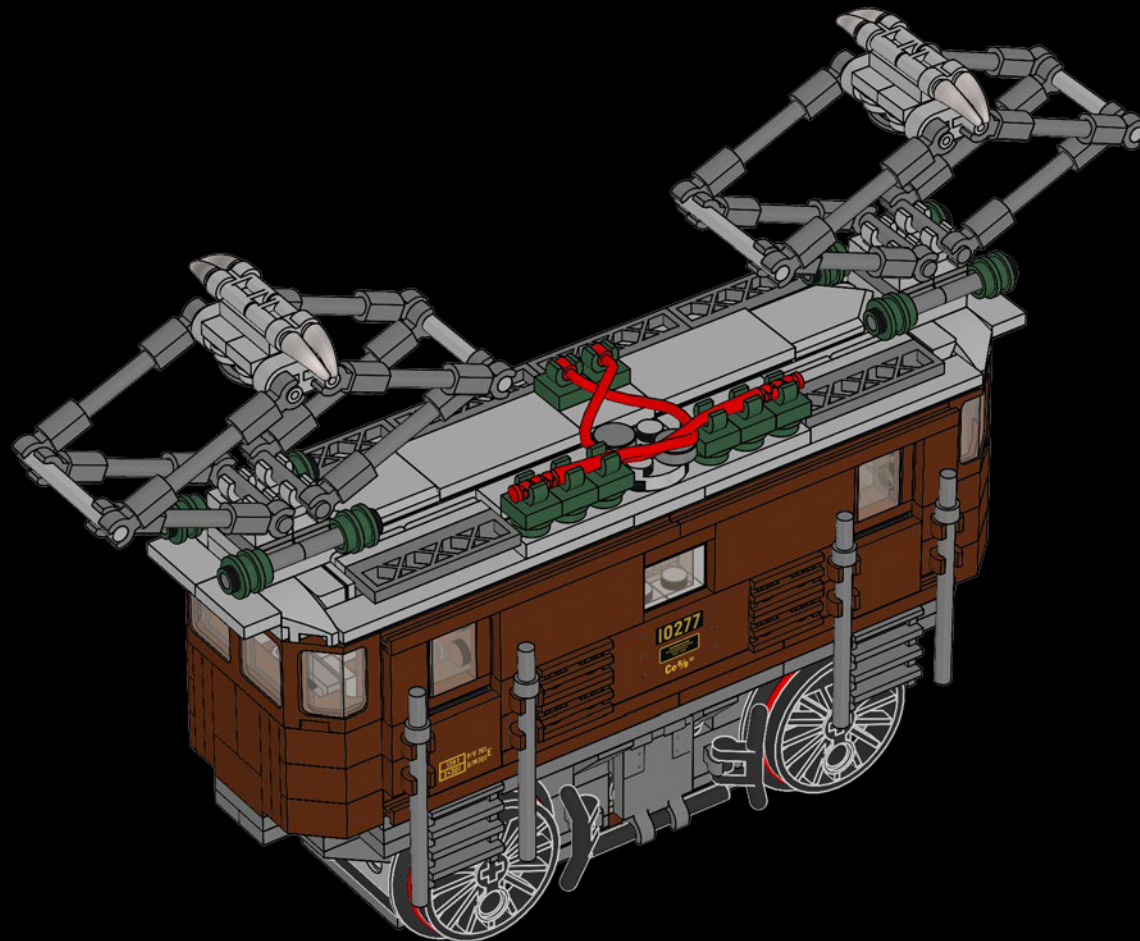

2x 6177114
 4x 6242241
 2x 4515370
 4x 3200001
 4x 4527947
 4x 6129995
 4x 6232135
 4x 4565452
 4x 4666579
 4x 4218749
 2x 6084724
 2x 4114322
 18x 4118790
 1x 6210497
 2x 4514553

8x 6254216
 1x 6173126
 2x 6168634
 8x 4544143
 1x 6060843
 4x 6129995
 2x 6310992
 1x 6270320
 1x 6205341
 4x 6206240
 2x 6130007
 1x 6130010
 2x 6313580
 1x 6310885
 2x 6047056

4

3

9

20x 6168646
 4x 307026
 4x 6156414
 6x 6308000
 1x 6290530
 1x 4177431
 2x 4184169
 4x 4161332
 2x 6157554
 4x 4160869
 4x 4109810
 4x 4548180
 8x 614326
 2x 4121715
 2x 6313116
 4x 3003126

4x 4218868
 4x 6192130
 2x 366026
 2x 407926
 2x 6051038
 22x 362326
 2x 6116604
 2x 302126
 1x 243126
 1x 4162443
 2x 301026
 4x 6254045
 4x 6280168
 6x 302026

6

6x 370626
 2x 6172149
 2x 6058118
 2x 346026
 17x 416226
 4x 6244698
 1x 4161067
 4x 6236464
 2x 244526
 6x 428226

4x 4221744
 4x 4211288
 18x 6071274
 28x 6201911
 8x 6037289
 12x 6248854
 8x 6185998
 2x 4211149
 50x 4211150
 13x 4211151
 8x 4224243
 4x 6117976
 4x 4645103
 2x 6312726
 10x 4271949

8x 4216695
 18x 6100769
 8x 4211152
 6x 4211190
 2x 6312725
 14x 4579690
 6x 4211186
 2x 6309055
 2x 4271874
 10x 6313736
 4x 6309010

28x 4223303
 8x 6177697
 2x 4211211
 10x 6055145
 4x 4211483
 4x 4255629
 8x 6308012
 2x 6225139
 2x 4211389
 4x 4211758
 4x 4550170
 10x 6227897
 2x 6225142
 1x 6212077

4x 4211741
 1x 4211475
 4x 4568637
 8x 6179186
 2x 6092956
 2x 4211350
 4x 6066097
 2x 4211398
 2x 4598526
 10x 6123809
 12x 6004990
 2x 4211397
 4x 6065824

- 2x 6273227
- 4x 4211536
- 2x 4225033
- 2x 6245254
- 4x 4211428
- 6x 4558169
- 2x 6168615
- 4x 6116608
- 8x 4211445
- 1x 4211407
- 2x 4166618
- 1x 4211486
- 3x 4598522
- 2x 6273218
- 3x 4211441
- 2x 4560183
- 1x 4211393
- 2x 4211640
- 6x 4211481
- 2x 6079722
- 2x 4211406
- 12x 6170420
- 32x 6015890
- 2x 6284596
- 4x 4210848
- 4x 4210719
- 8x 4211052
- 10x 4211063
- 4x 6214341
- 2x 6117972
- 2x 6310999
- 8x 6296892
- 2x 4278274
- 2x 6117346
- 4x 6127738
- 4x 6019987
- 16x 6092572
- 8x 6069164
- 2x 4211039
- 2x 6187008
- 12x 4211043
- 4x 4263176
- 4x 4211064
- 17x 4211001
- 2x 4543086
- 8x 6285244
- 2x 6146321
- 4x 6126083
- 13x 6309059
- 4x 6047417
- 22x 4210635
- 8x 4211133
- 10x 4213607
- 8x 4211053
- 6x 4219725
- 2x 6311122
- 6x 6039176
- 1x 4211065
- 6x 4210997
- 1x 4211061
- 2x 4211122
- 4x 6133611
- 8x 6313875
- 6x 4560184
- 2x 4211085
- 2x 4294180
- 4x 4210651
- 9x 4211056
- 14x 4210998
- 3x 4210967
- 26x 6310596
- 4x 4211103
- 8x 6257592
- 4x 403228
- 6x 302328
- 3x 6132372
- 2x 6273590
- 22x 6230571
- 8x 6310996
- 64x 6194729
- 32x 6313874
- 6x 6240030
- 6x 6244909
- 2x 6240219
- 2x 6299774
- 8x 6270108
- 1x 6167576
- 4x 6284110
- 2x 6004938
- 1x 6240515



Customer Service
Kundenservice
Service Consommateurs
Servicio Al Consumidor
LEGO.com/service or dial

00800 5346 5555 :        

1-800-422-5346 :  





FEEDBACK AND WIN



FEEDBACK AND WIN

Your feedback will help shape the future development of this product series.

Please visit:

FEEDBACK UND GEWINNEN

Dein Feedback trägt zur Weiterentwicklung dieser Produktreihe bei.

Geh auf:

COMMENTEZ ET GAGNEZ

Vos commentaires nous aideront à concevoir les futurs produits de cette gamme.

Rendez-vous sur :

COMENTA Y GANA

Tu opinión nos ayudará a dar forma al desarrollo de esta serie de productos en el futuro.

Visita:

反馈有奖

您的反馈将有助于我们在今后改进本系列产品。

请访问：

[LEGO.com/productfeedback](https://www.lego.com/productfeedback)

By completing, you will automatically enter a drawing to win a LEGO® set.

Terms & Conditions apply.

Durch Ausfüllen nimmst du automatisch an der Verlosung eines LEGO® Preises teil.

Es gelten die Teilnahmebedingungen.

En envoyant vos commentaires, vous serez automatiquement inscrit(e) à un tirage au sort qui vous permettra de remporter un prix LEGO®.

Offre soumise à conditions.

Al contestar, participarás automáticamente en el sorteo y podrás ganar un set LEGO®.

Sujeto a Términos y Condiciones.

完成我们的反馈调查，即可自动进入抽奖环节，赢取乐高®套装。

适用《条款和条件》。

