



# MONSTER FIGHTERS

9468



1

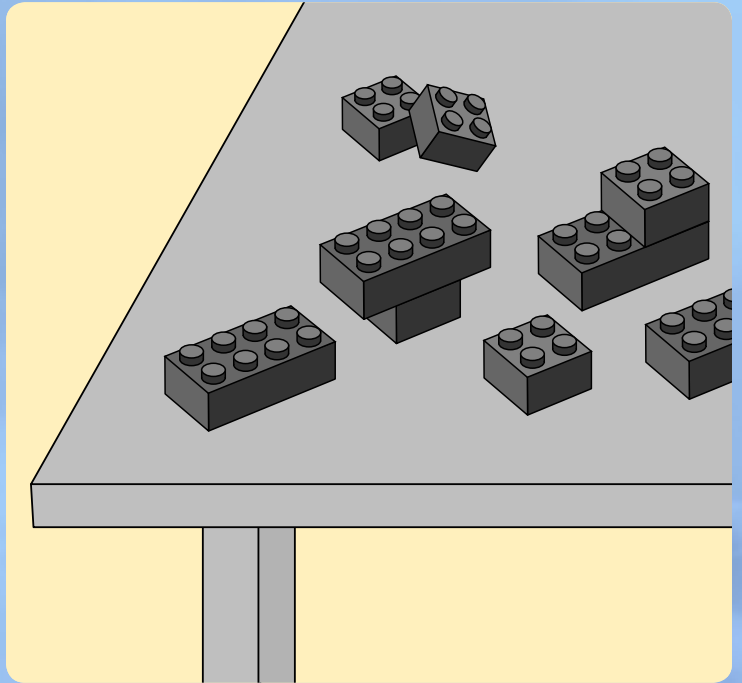
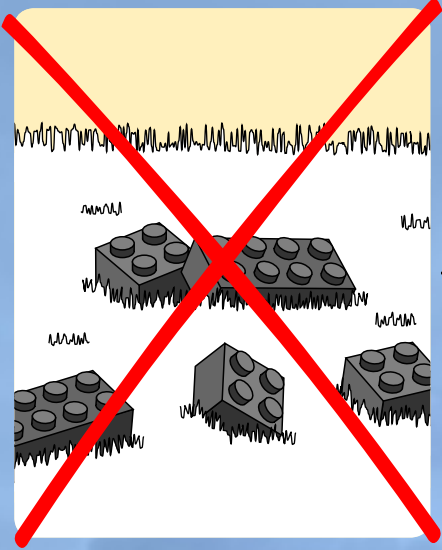

2



<http://lego.com/brickseparator>

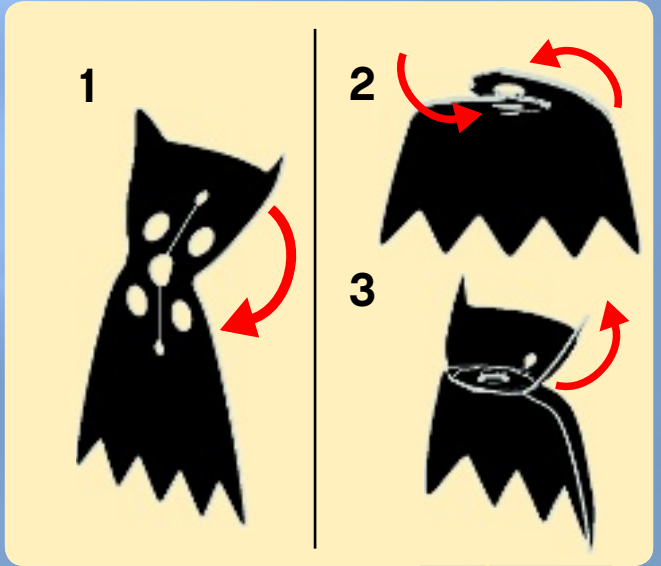
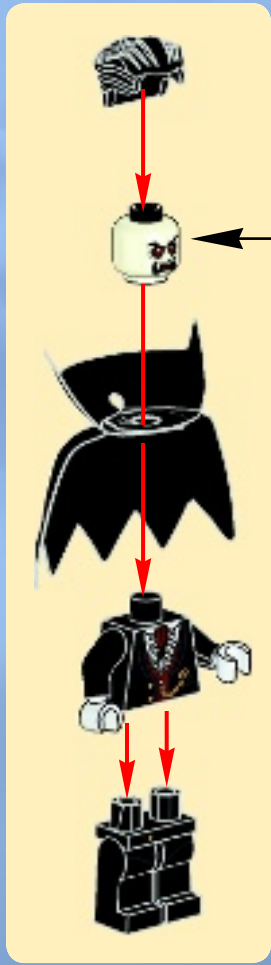
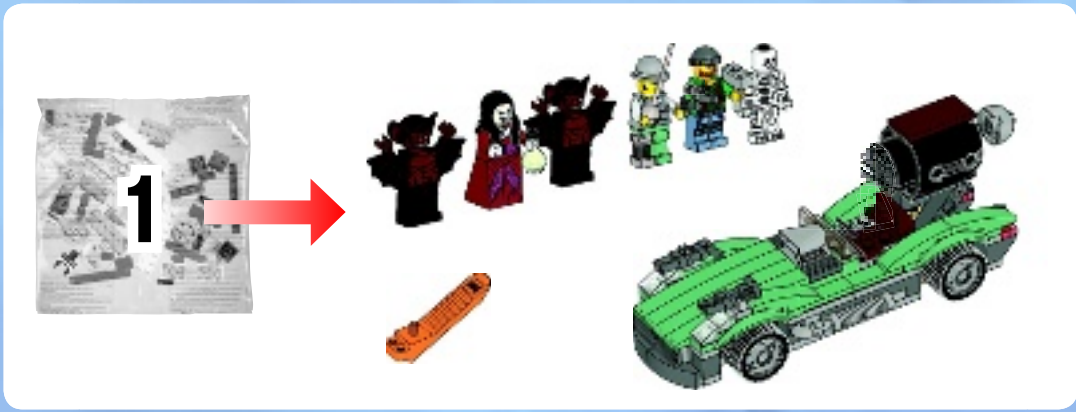

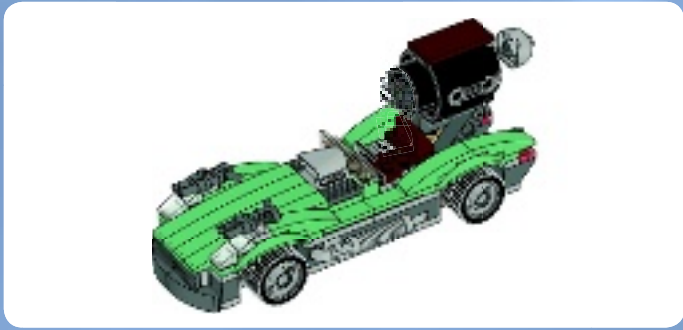
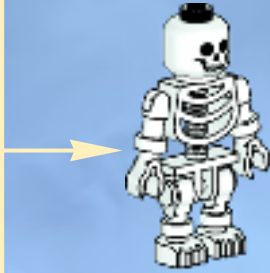
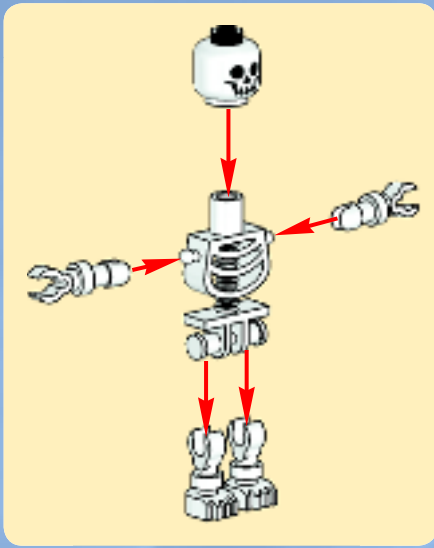

1

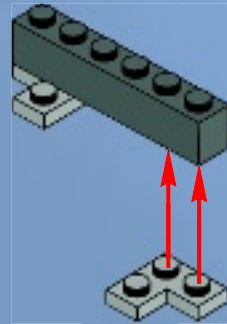



2

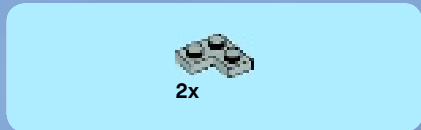
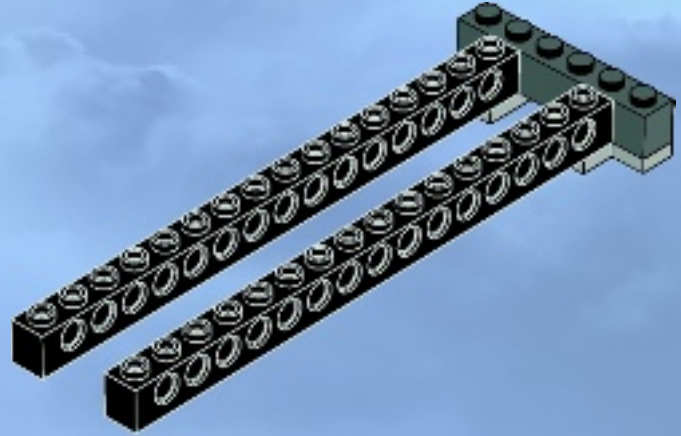

3

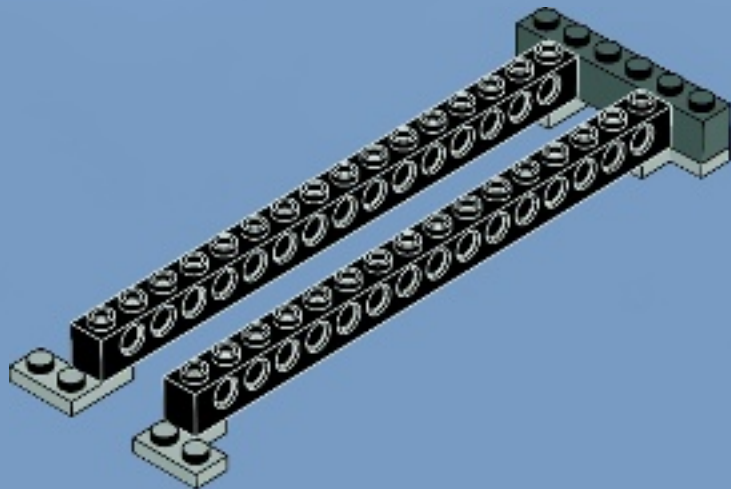



2x

4

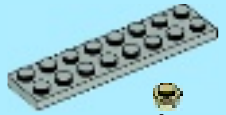
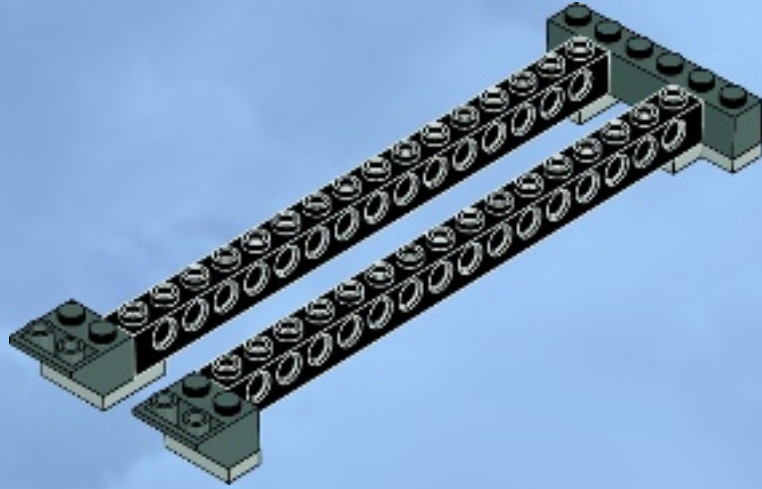

2x



4x



2x

5

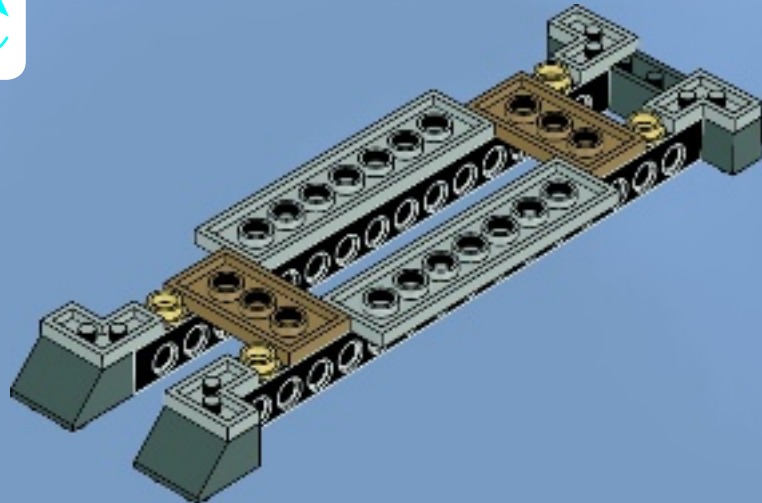

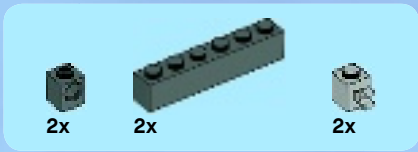

6

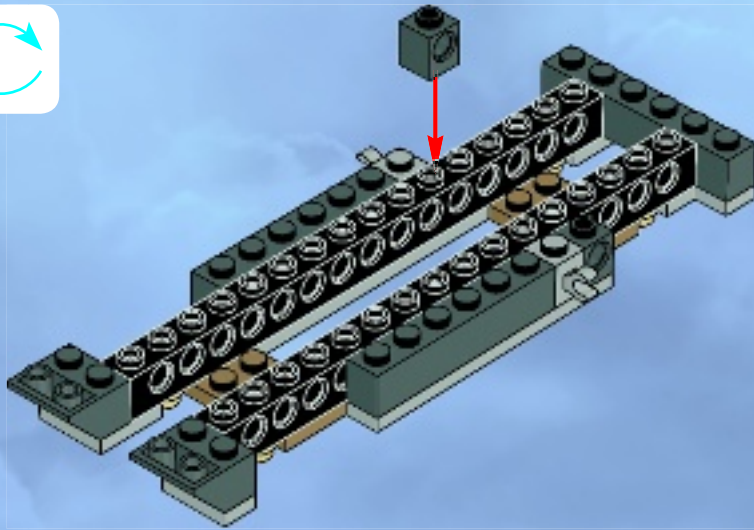

7

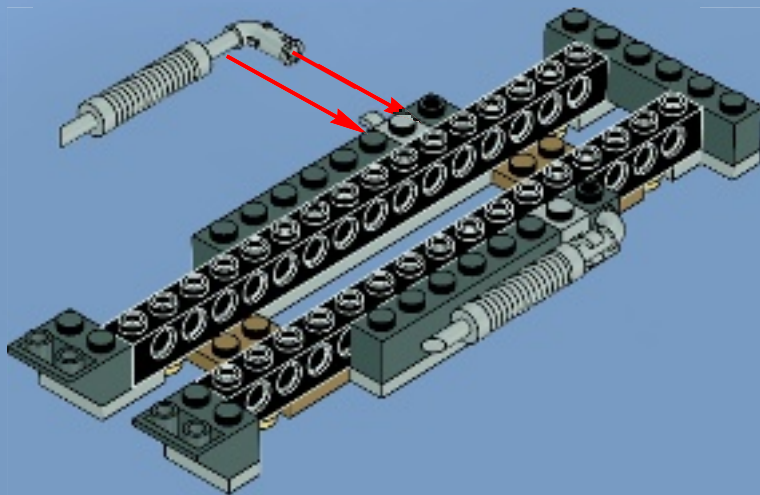



2x



2x

# 8

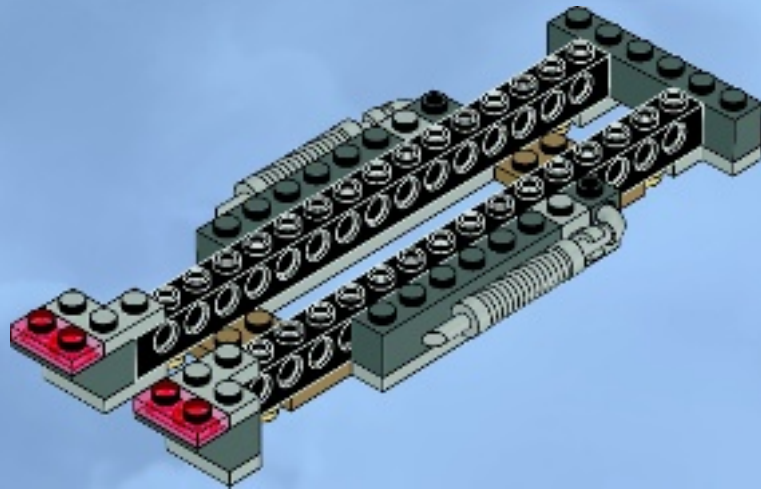

2x



1x

# 9

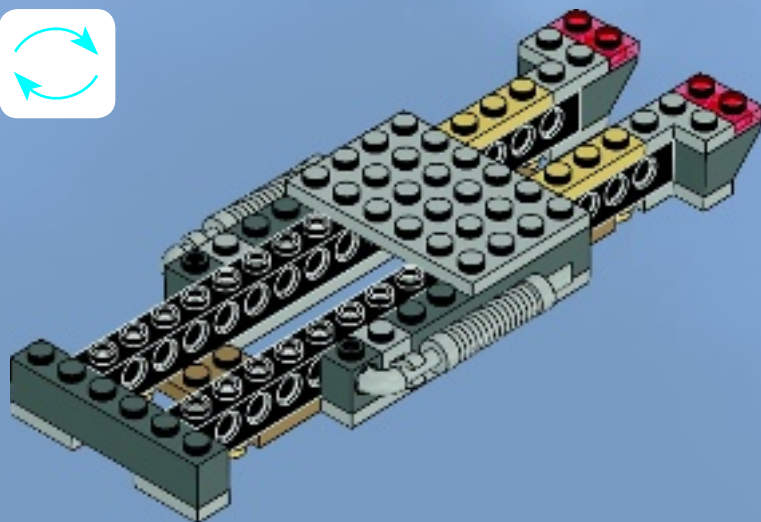





2x

# 10

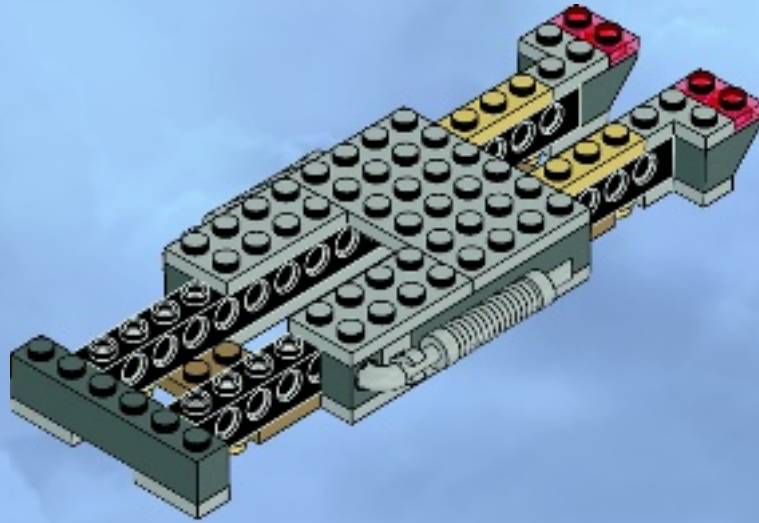

2x



1x

# 11

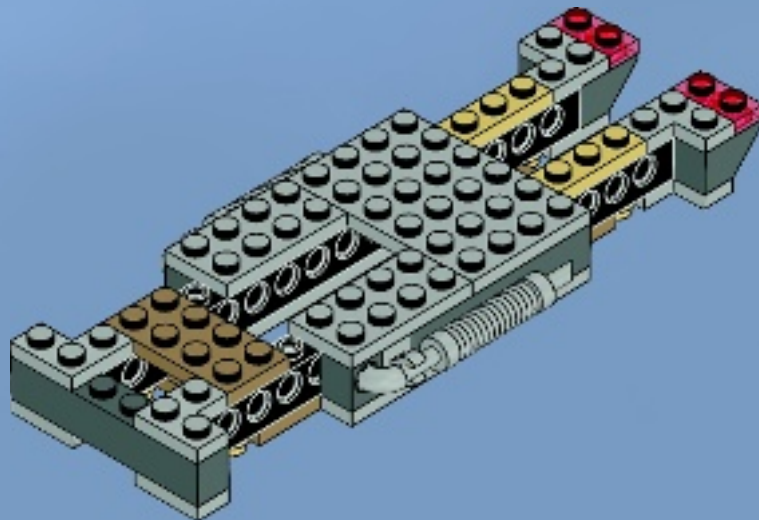

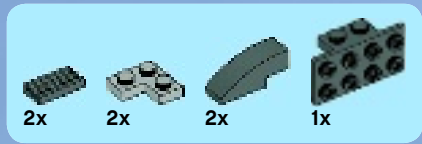

# 12

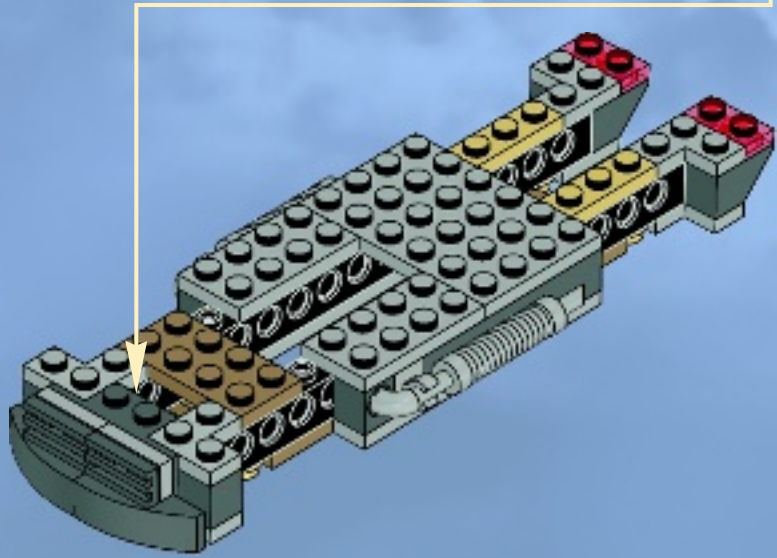
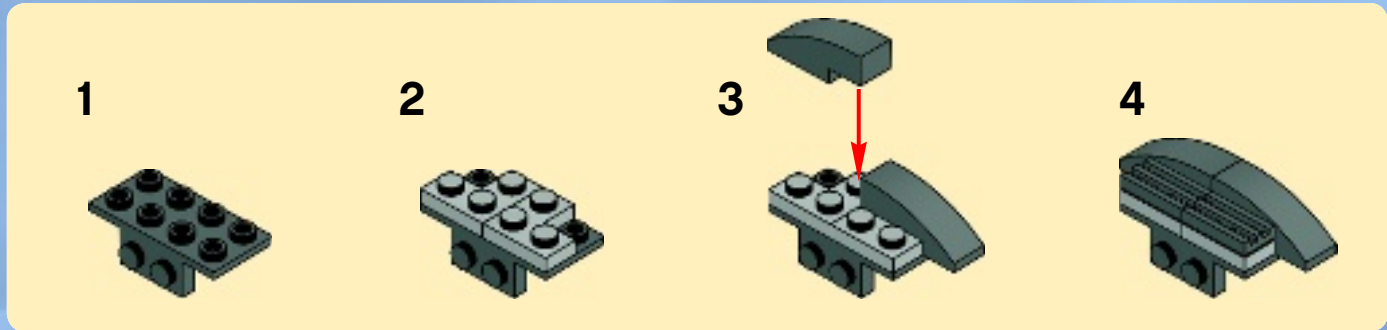



13

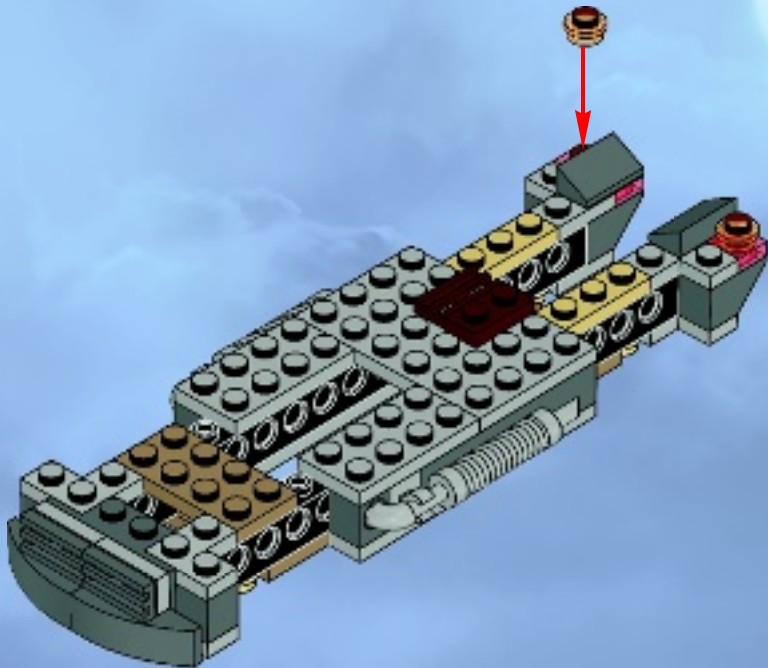

14

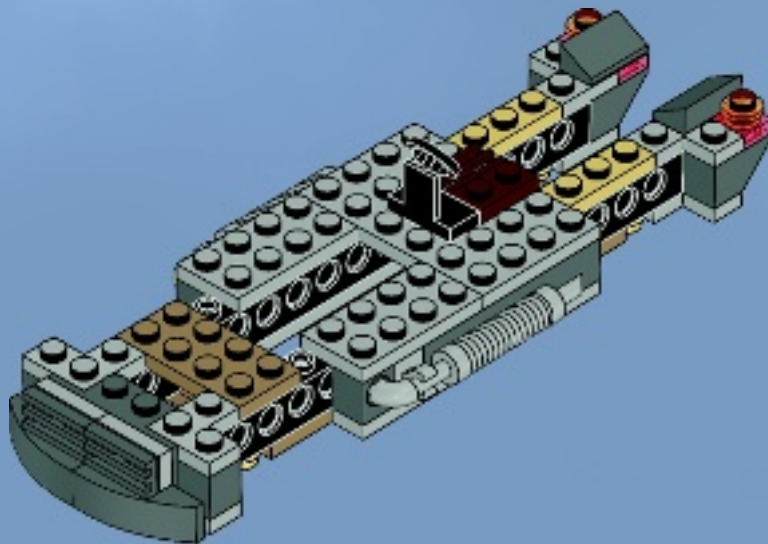



4x

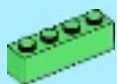

1x

# 15

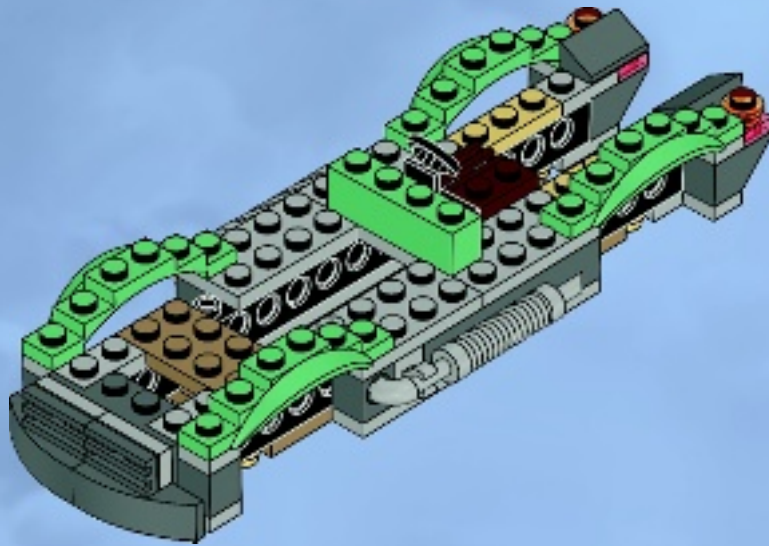

1x



4x

# 16

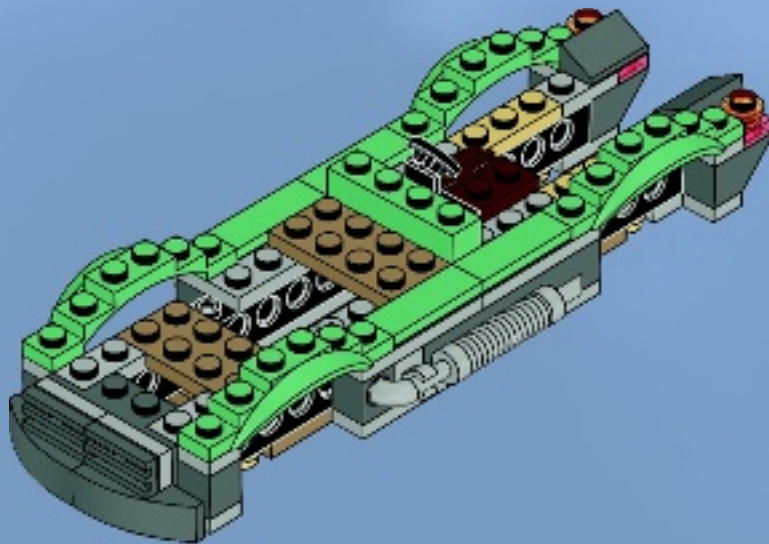



2x



4x

# 17

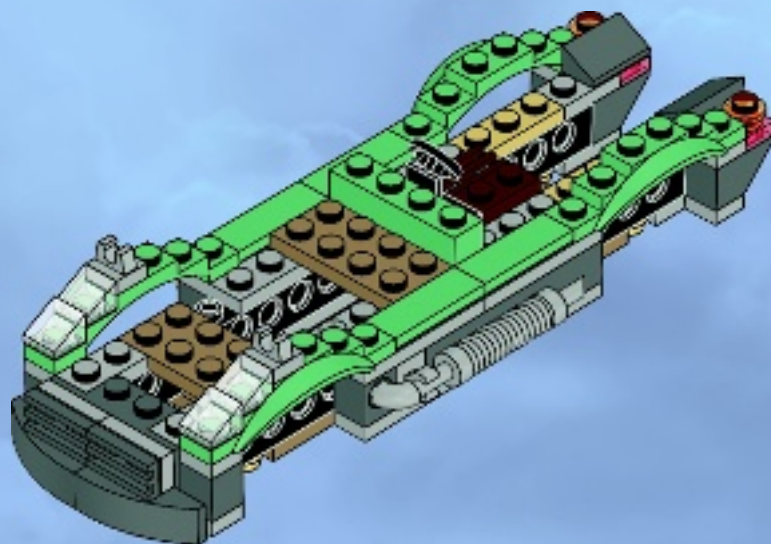

6x

# 18

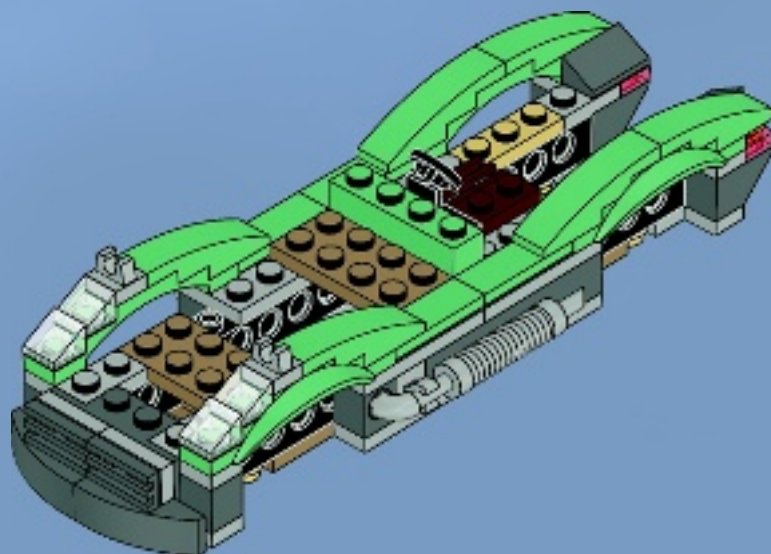

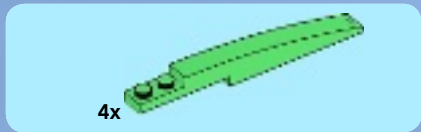

# 19

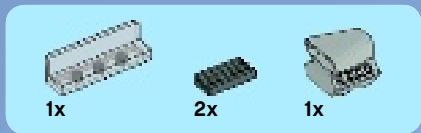
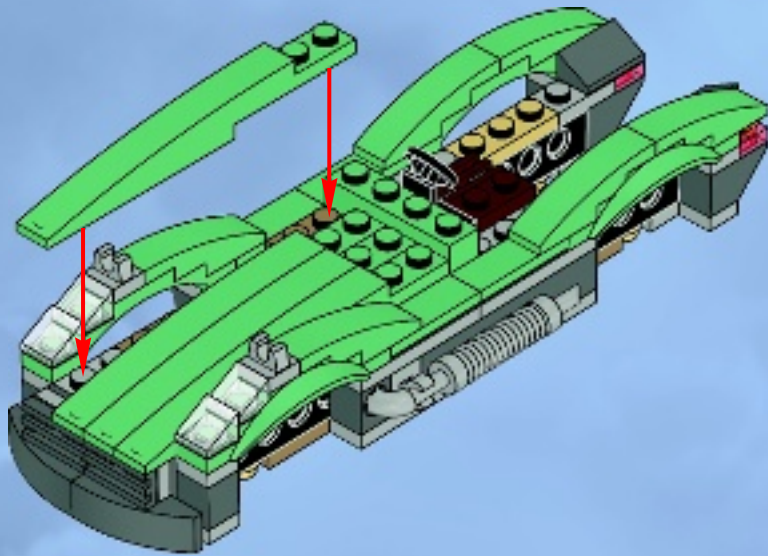

# 20

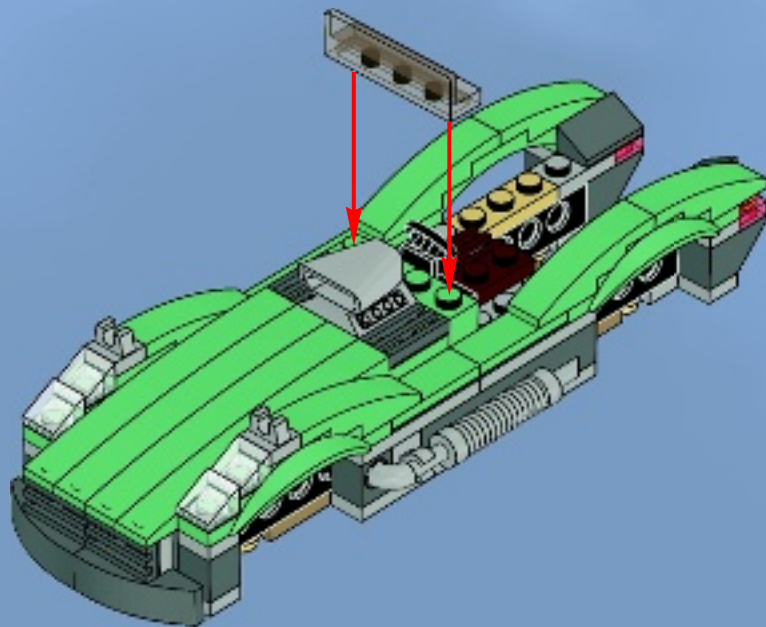

2x

2x

# 21

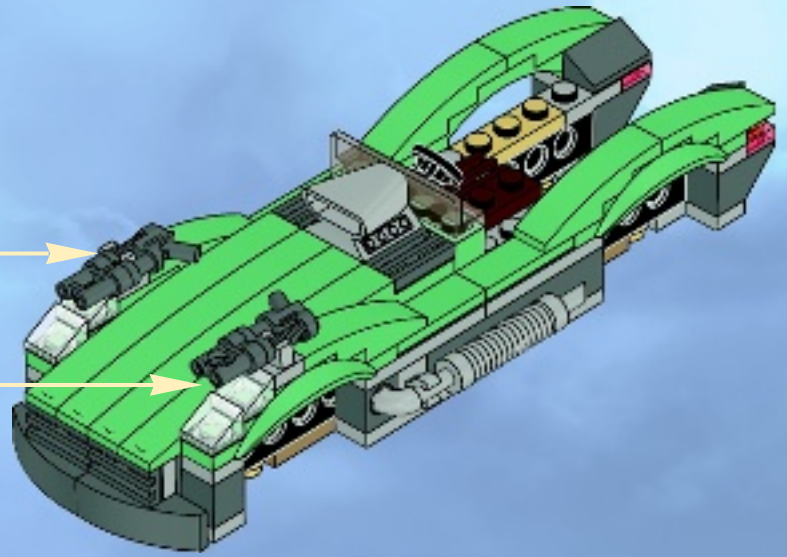
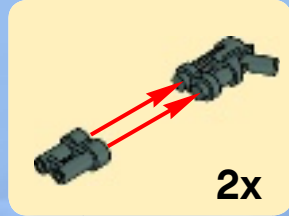

1x

1x

# 1

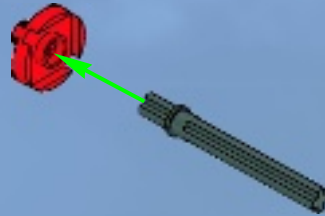

1x

# 2

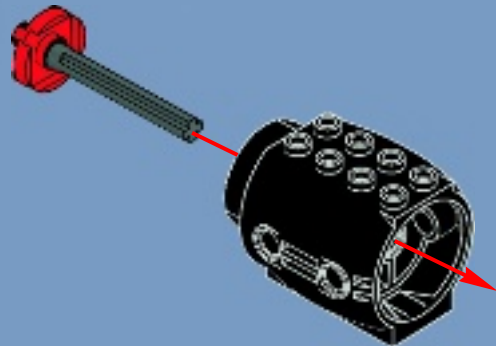



3

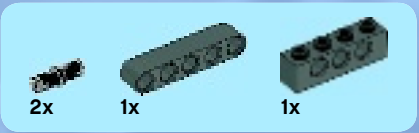
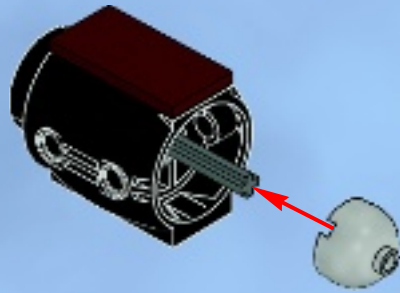

4

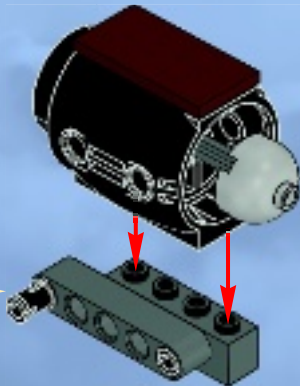
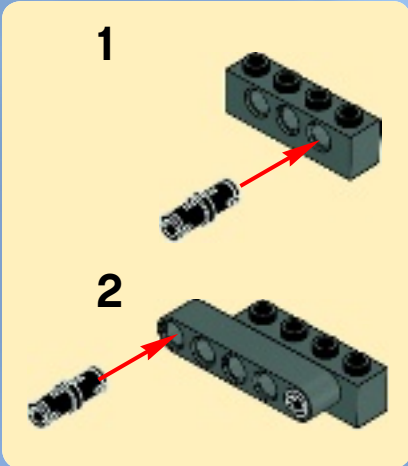

5

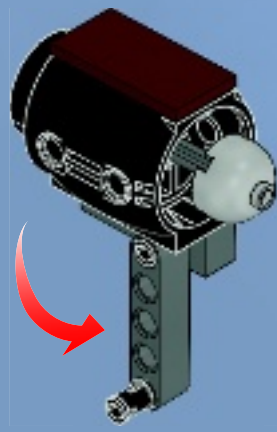



22

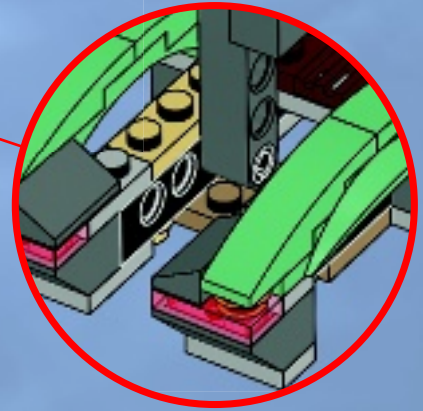
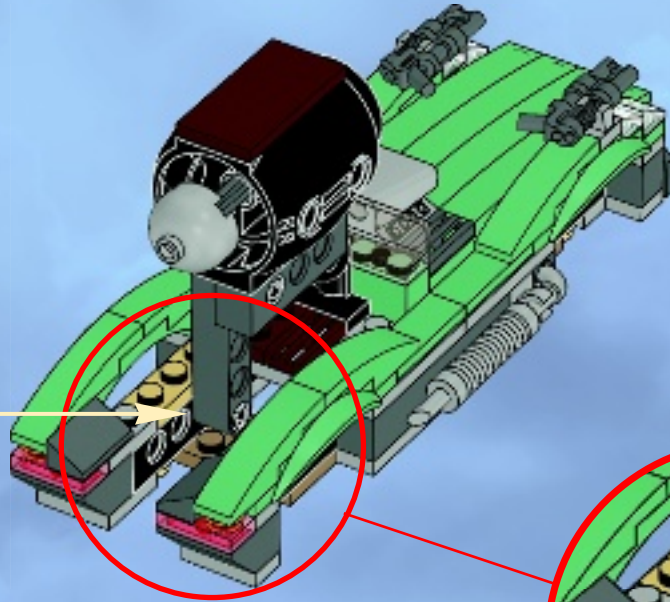

23

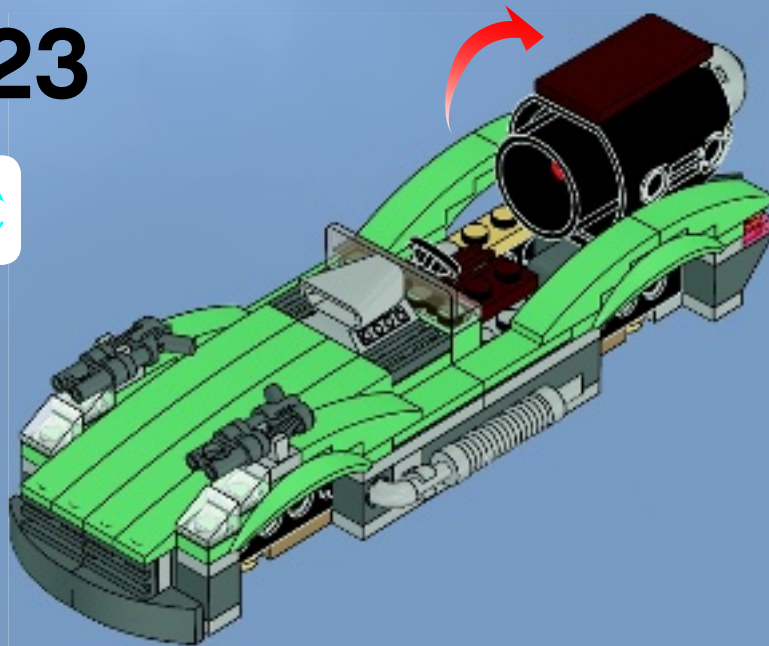



# 24

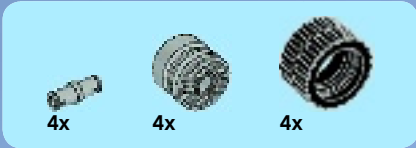
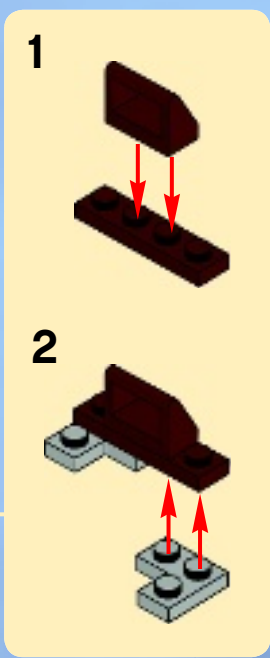
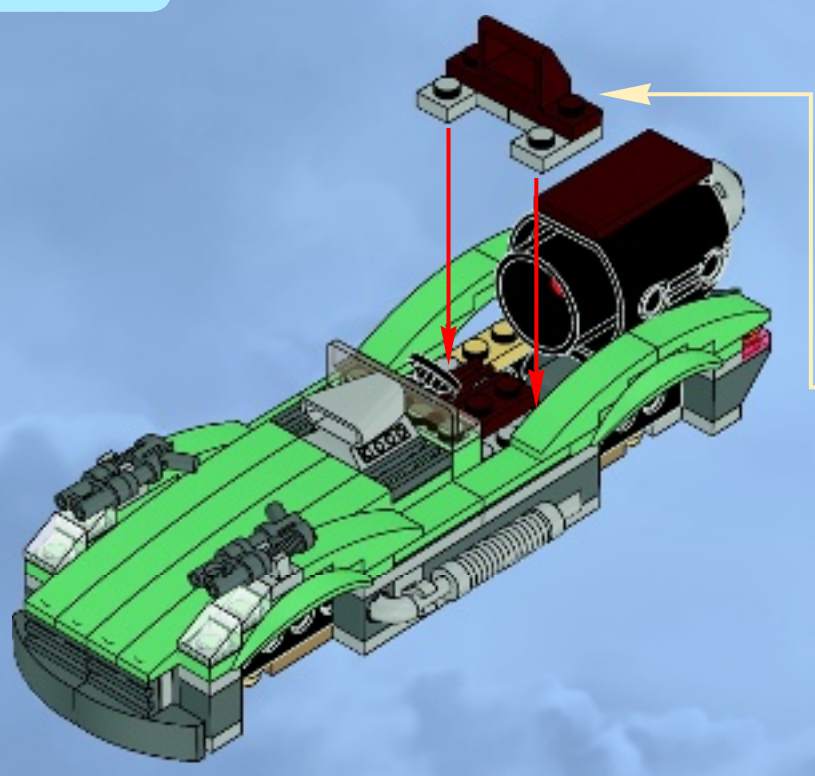

# 25

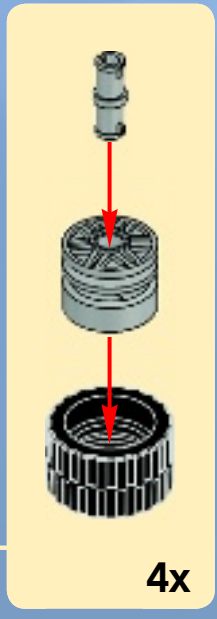
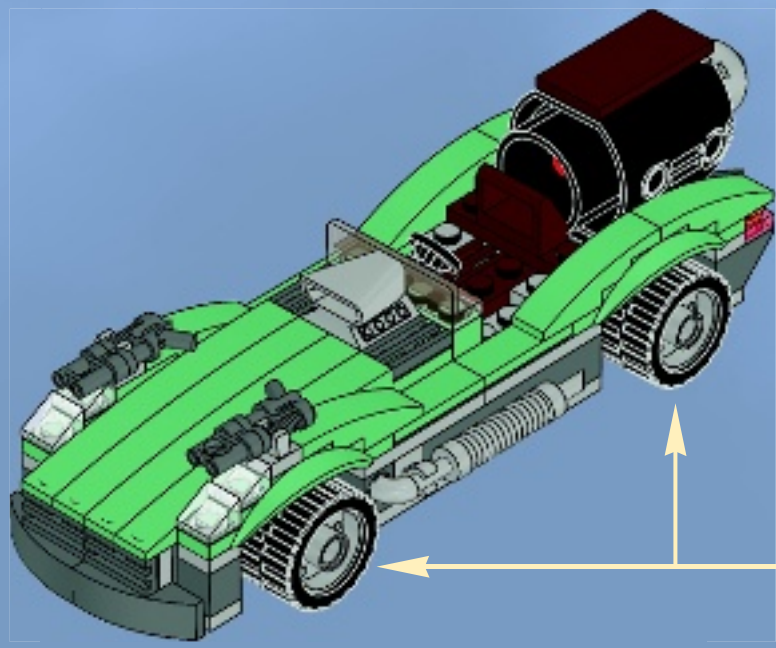

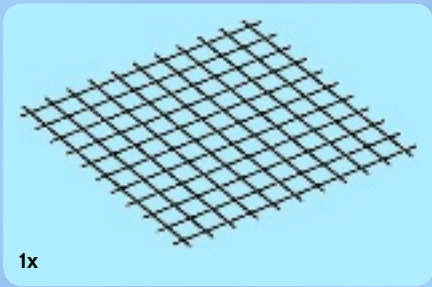

1x

# 26

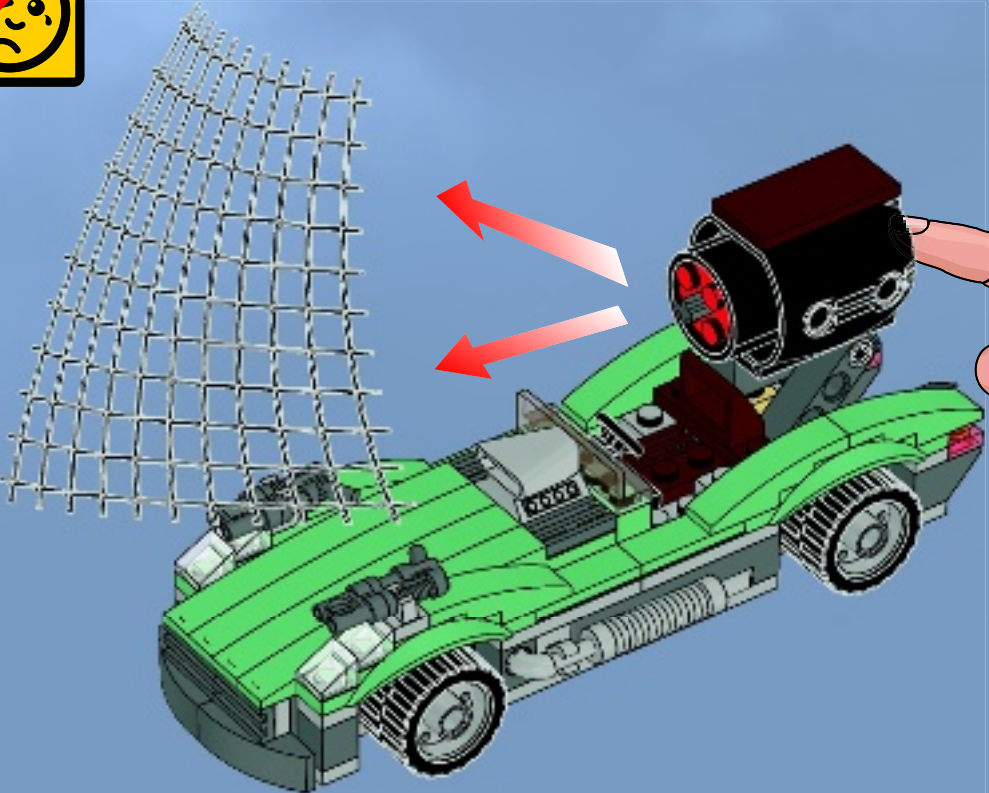
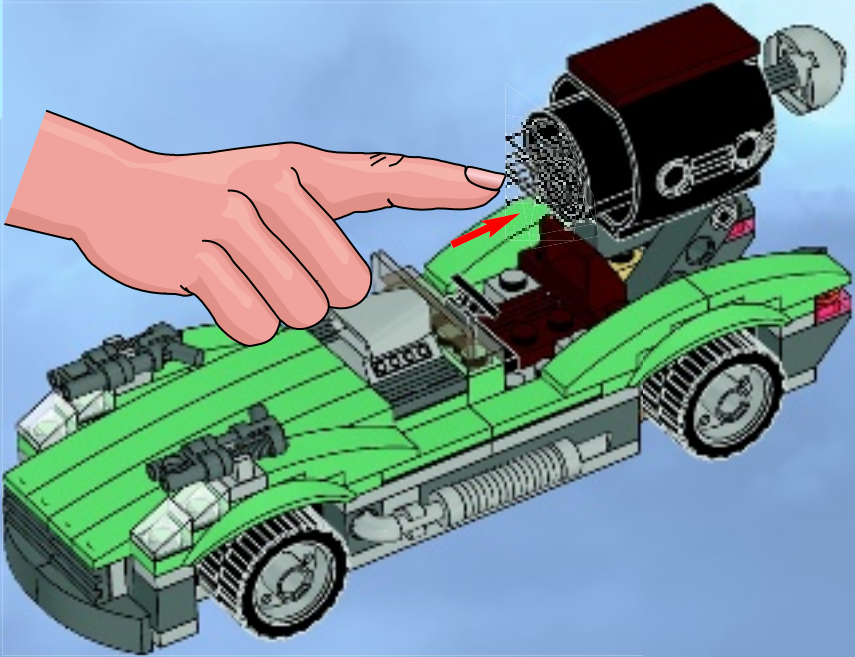

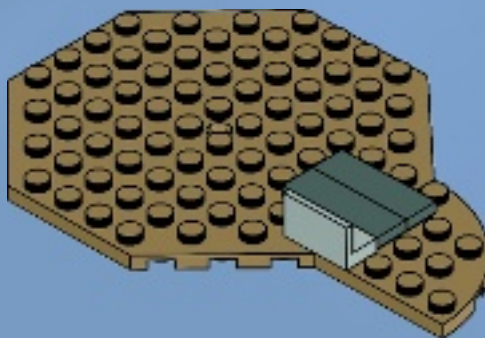
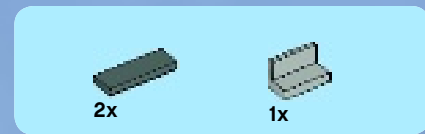
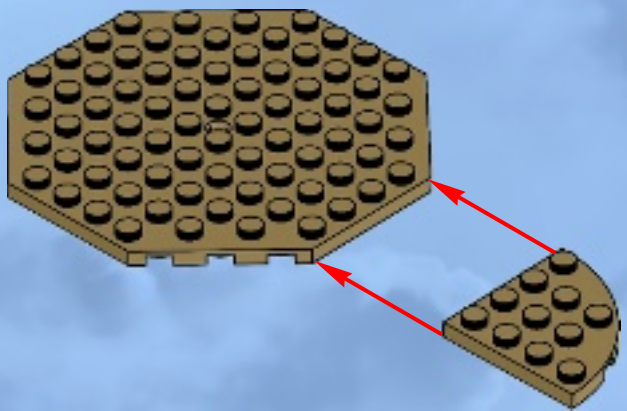
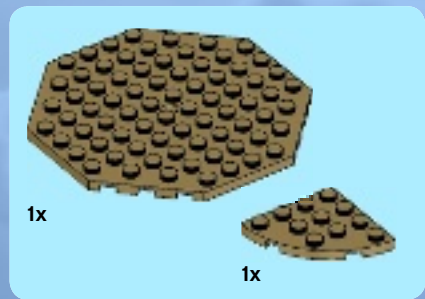
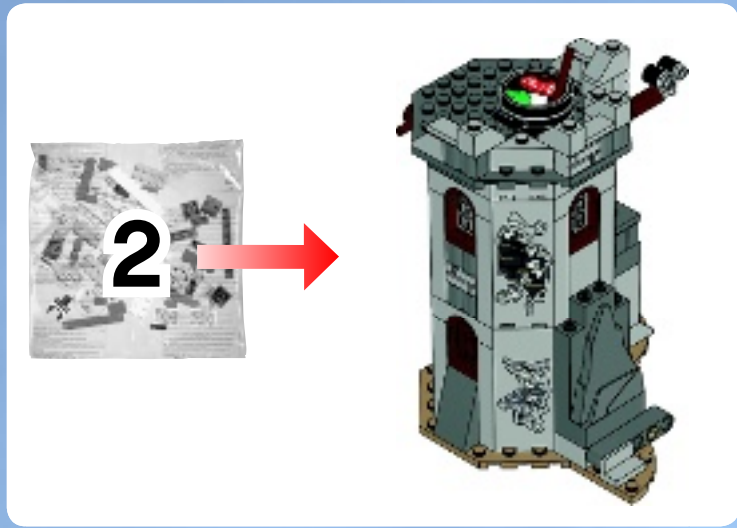



2x



1x

# 3

1

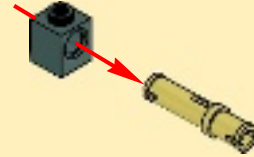

2

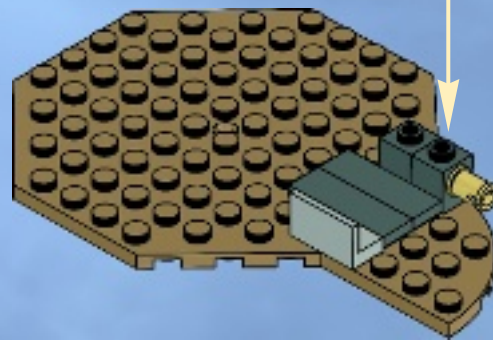
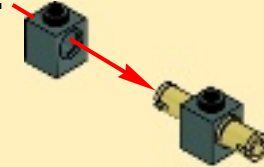

1x



1x

# 4

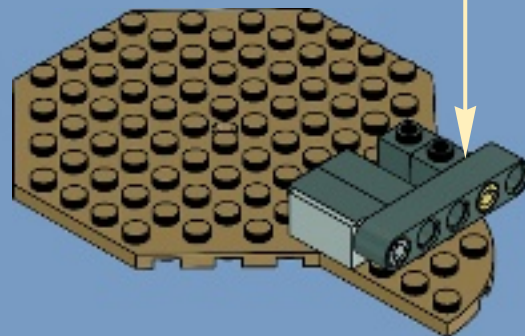
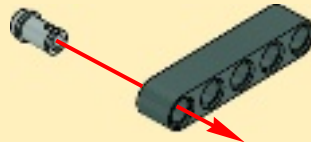



2x



1x

# 5

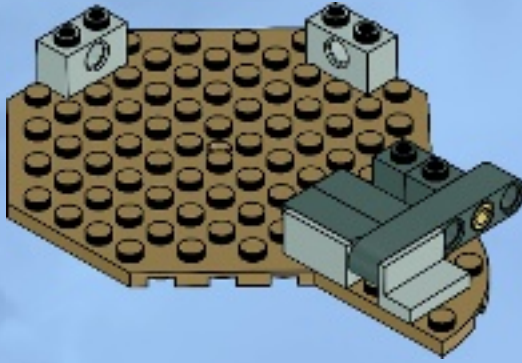

2x



1x



1x



1x

# 6

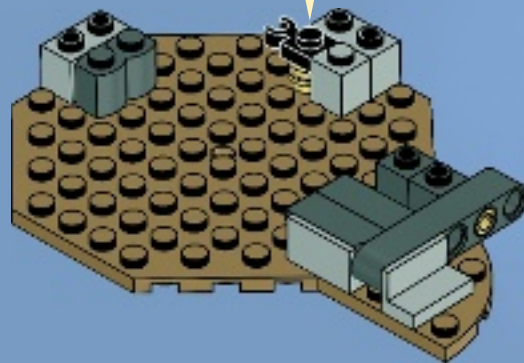



7

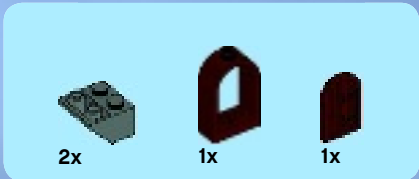
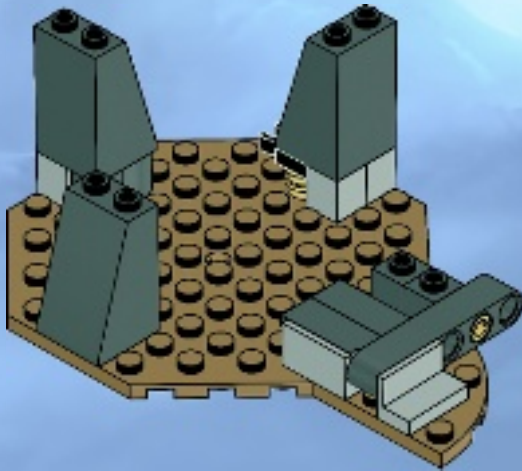

8

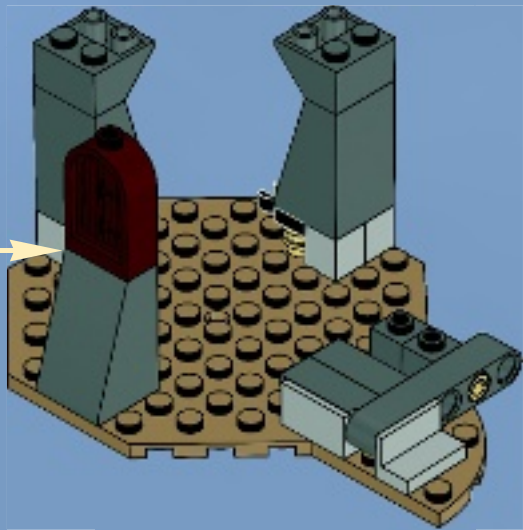
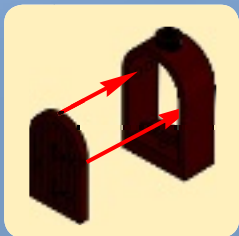



3x

# 9

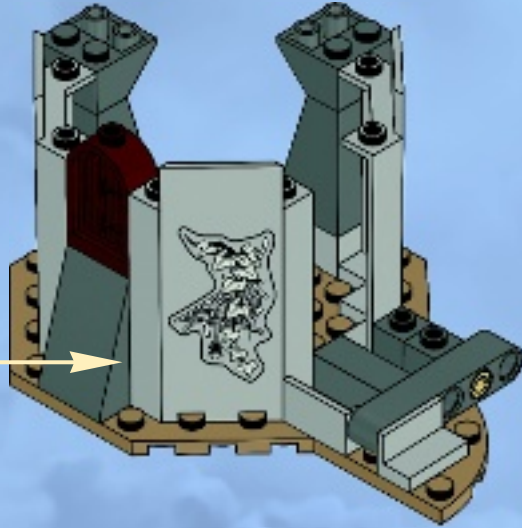
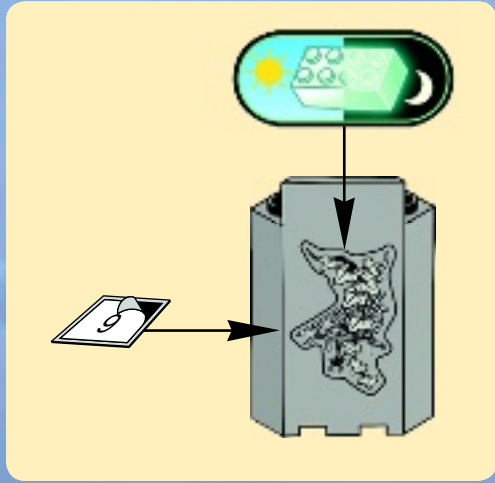

# 10

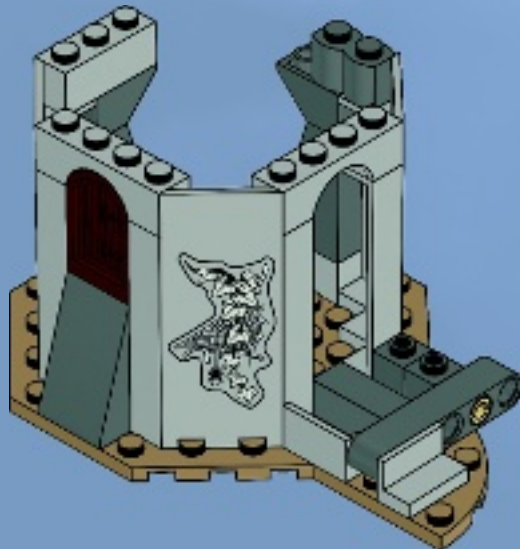





11

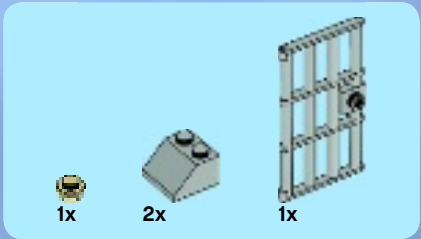
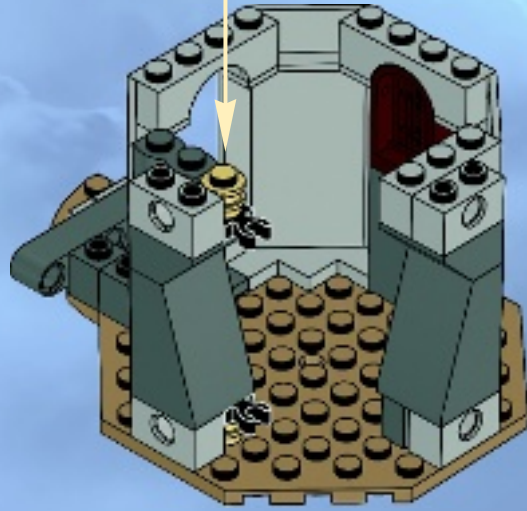

12

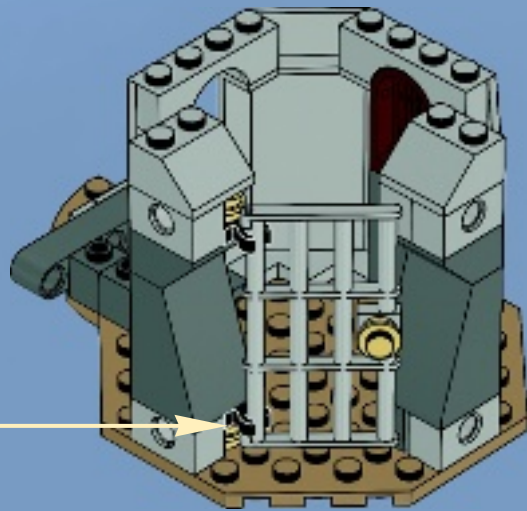
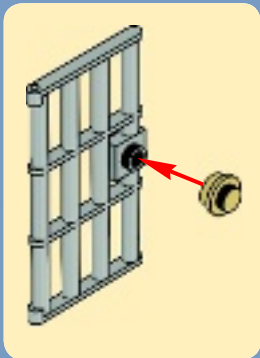

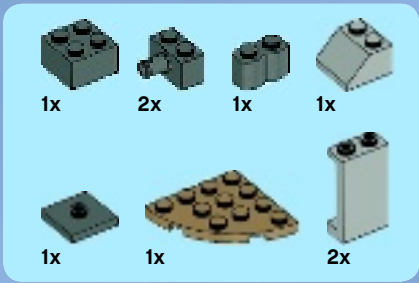

# 13

1



2



3

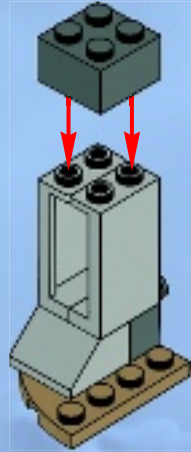

4

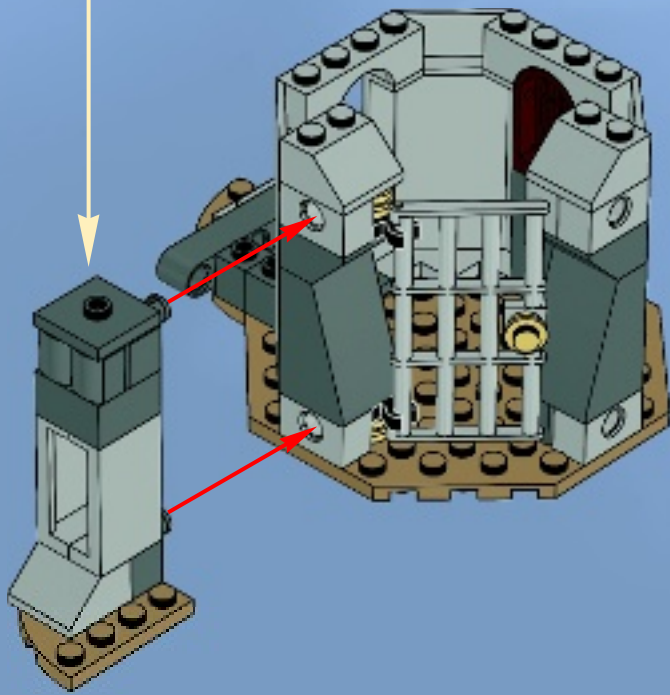

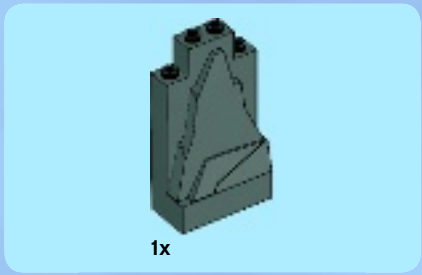

14

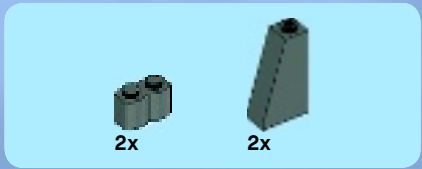
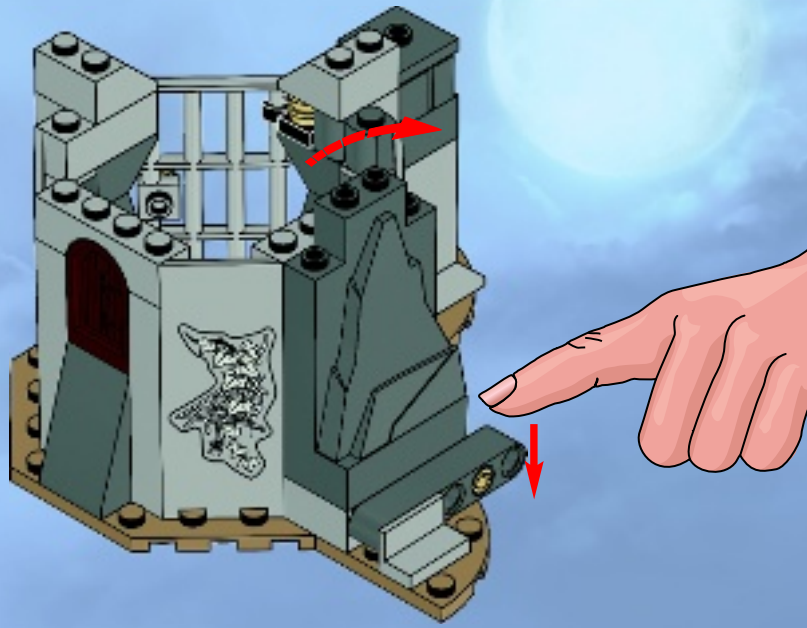

15

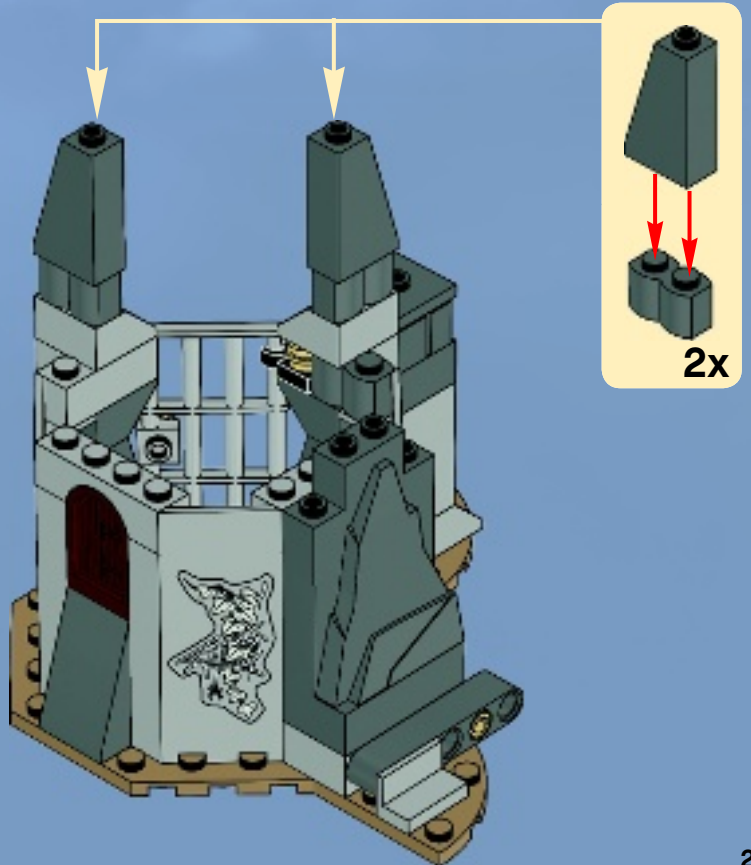



3x

# 16

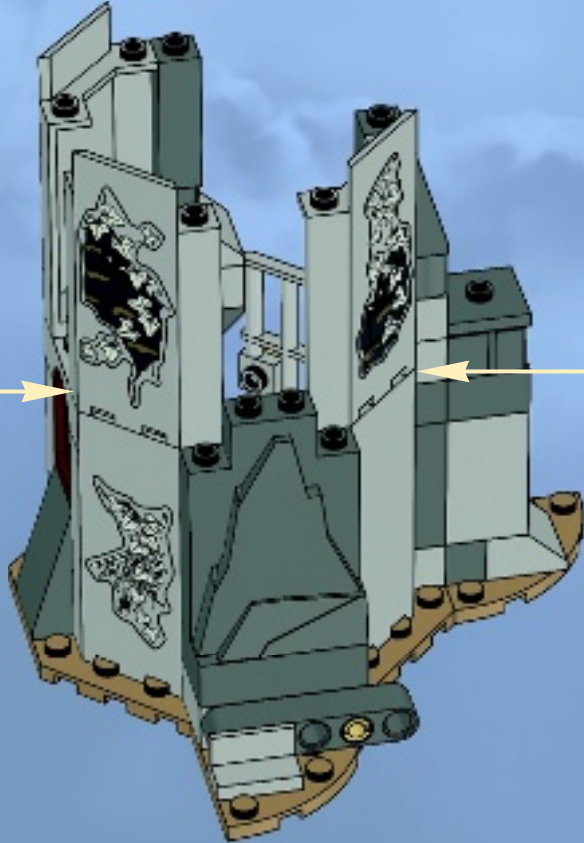
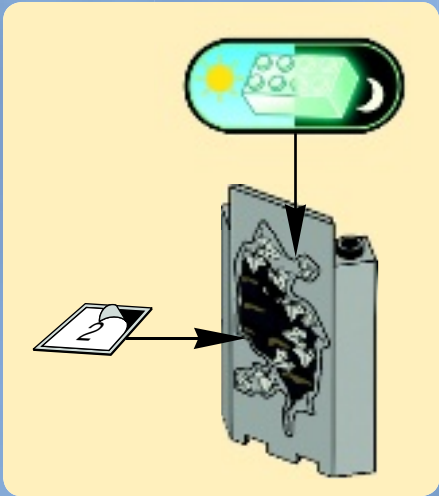
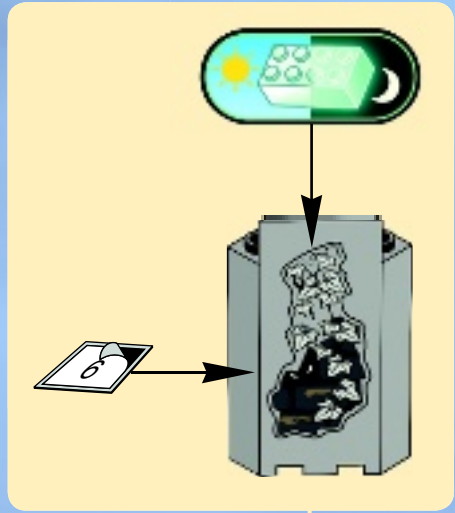

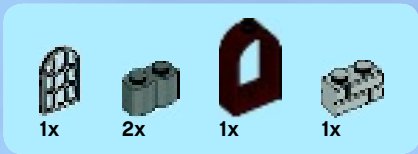

# 17

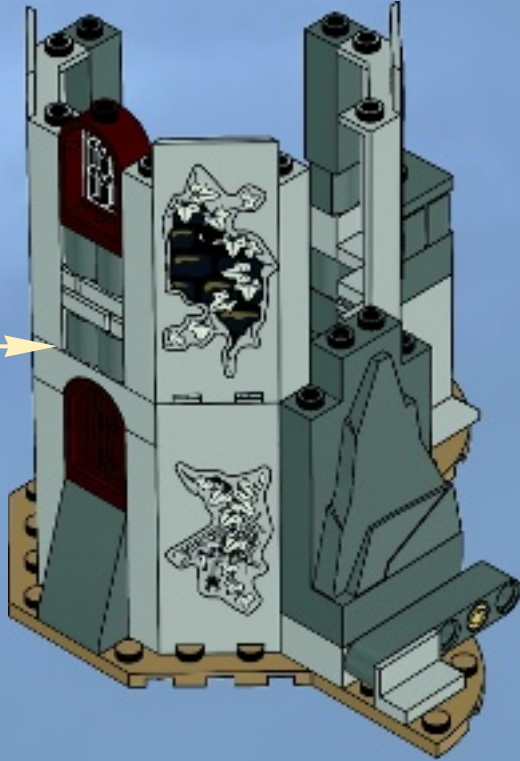
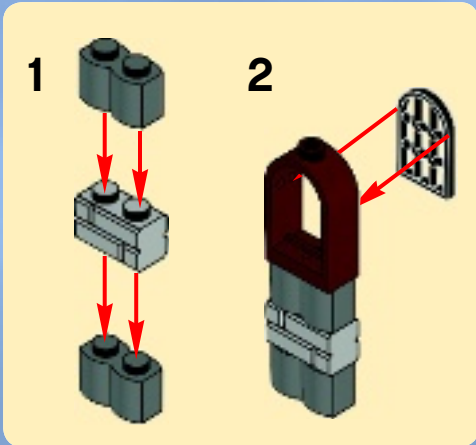

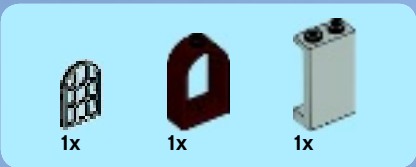

# 18

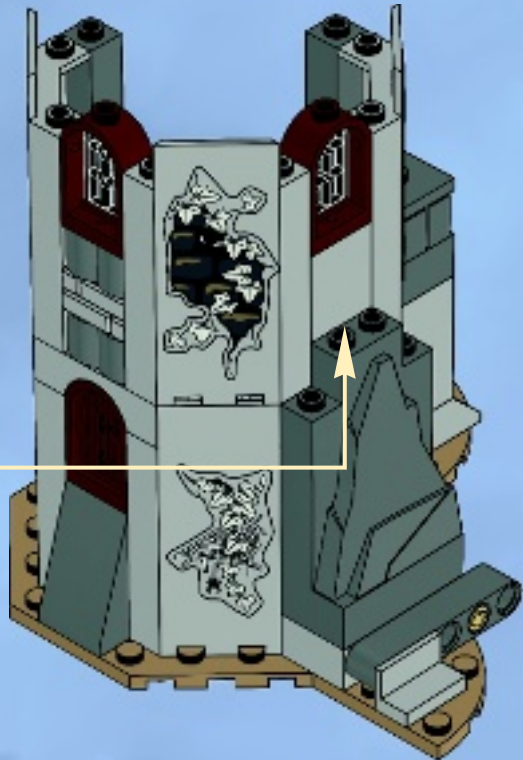
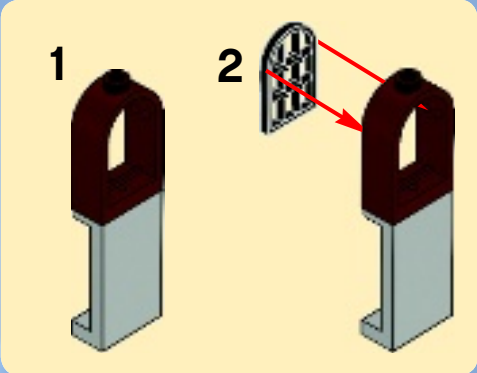

# 19



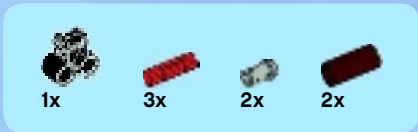

# 20

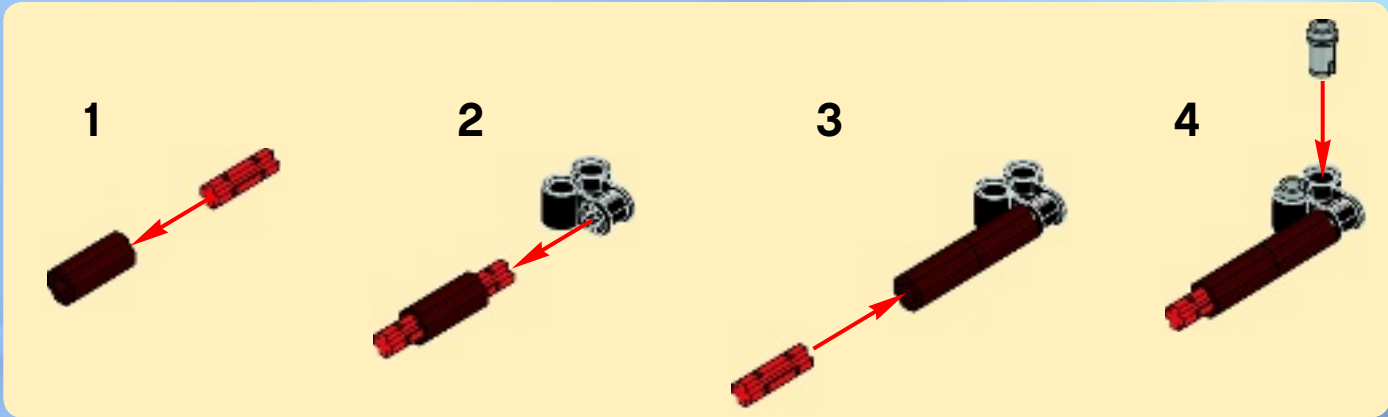



1x



1x

1



1x



1x

2

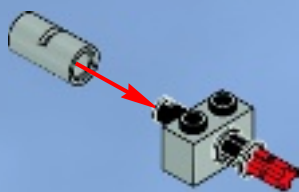

1x



1x

3

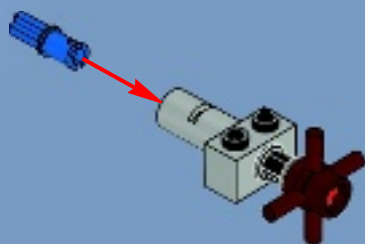

1x



1x

4

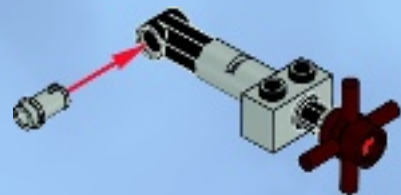

1x



1x



1x

5

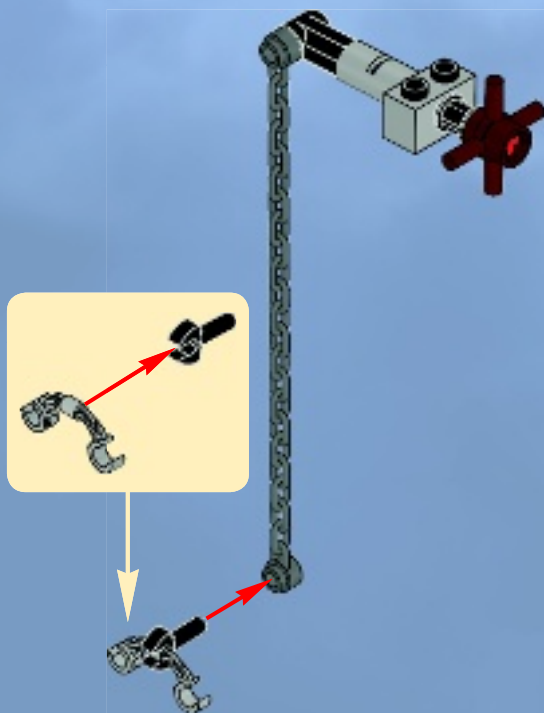



21





3x

# 22

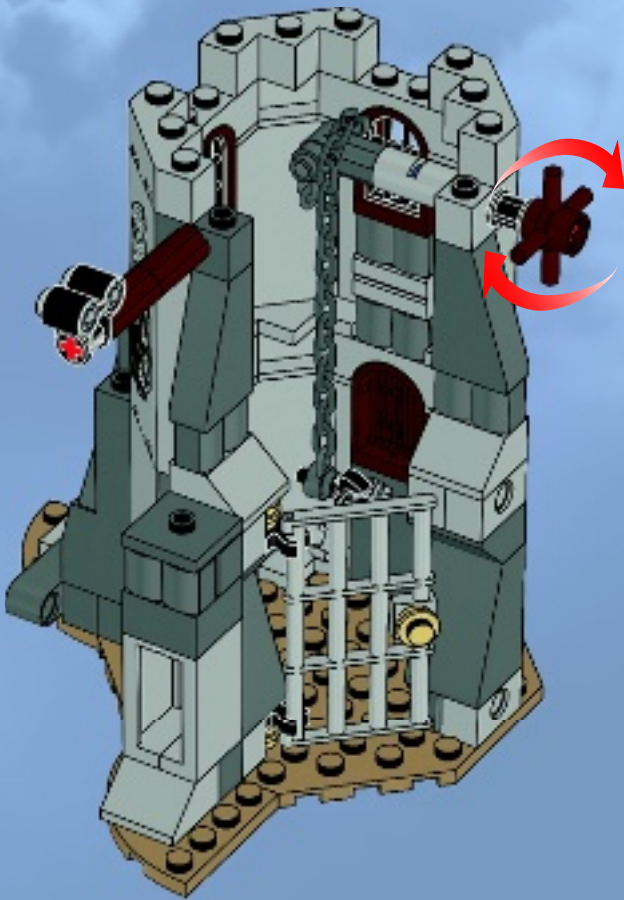

2x



2x

# 23





24

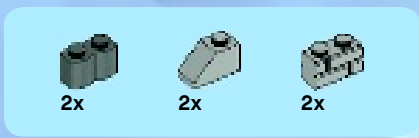

25





2x

# 26



3x



4x

# 27





28



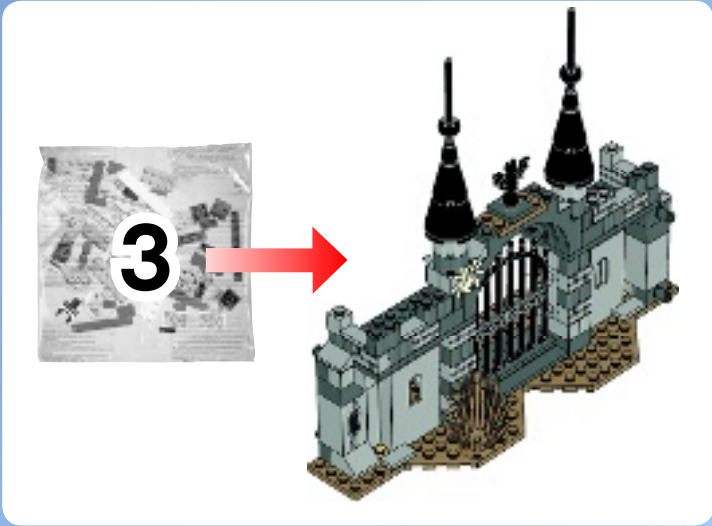

1

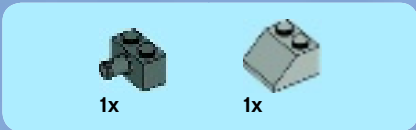
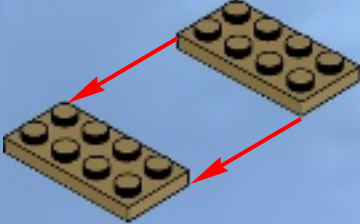

2

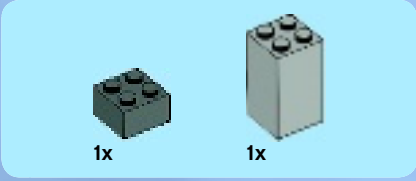
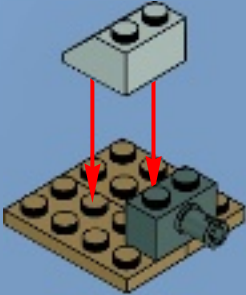

3

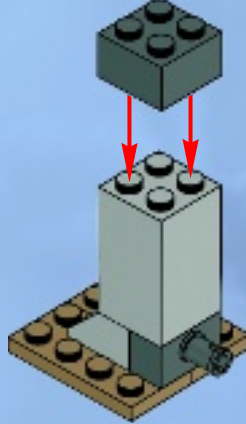

4

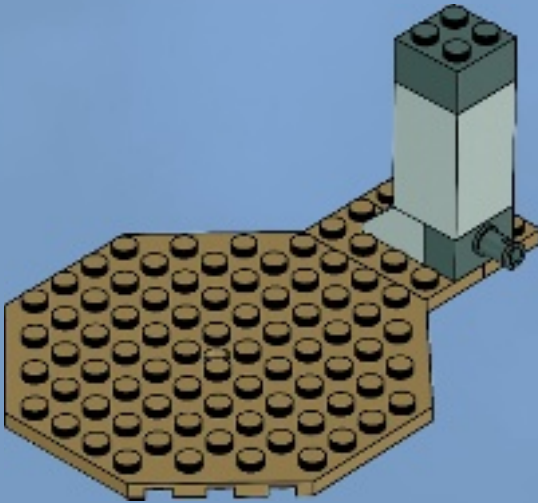

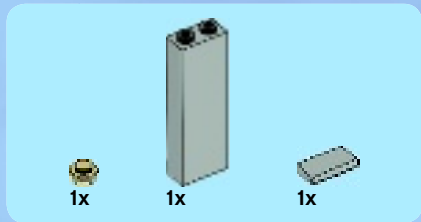

5

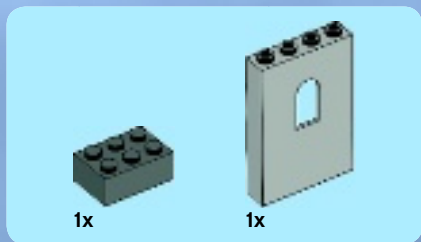
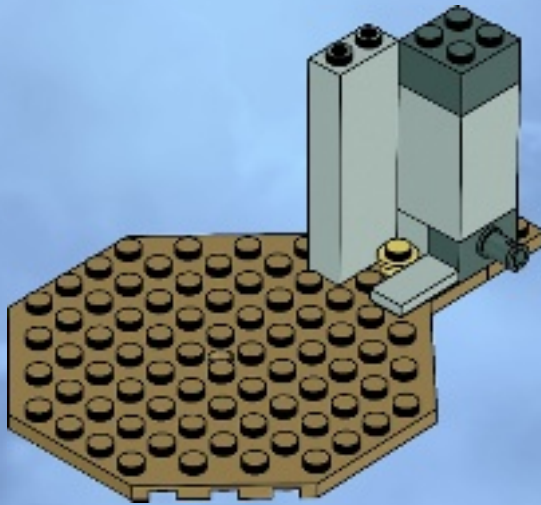

6

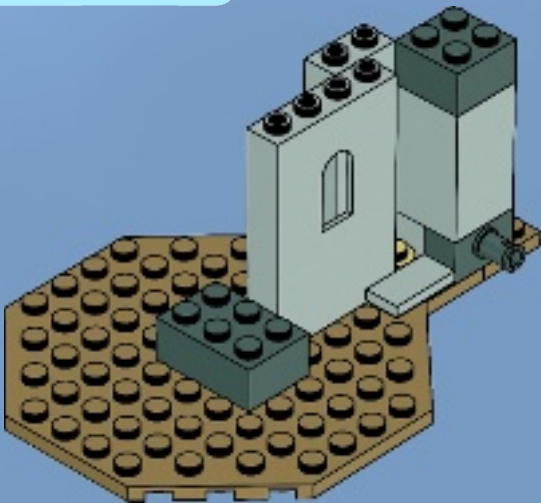

7





# 8

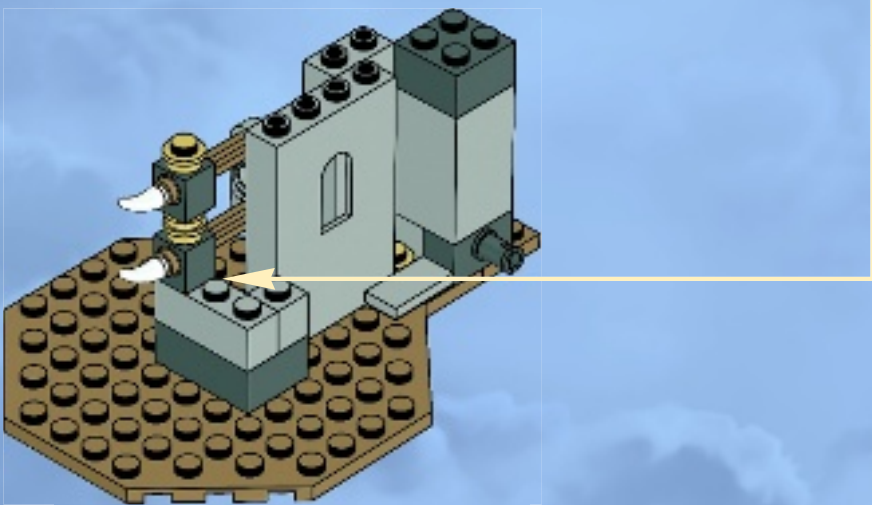
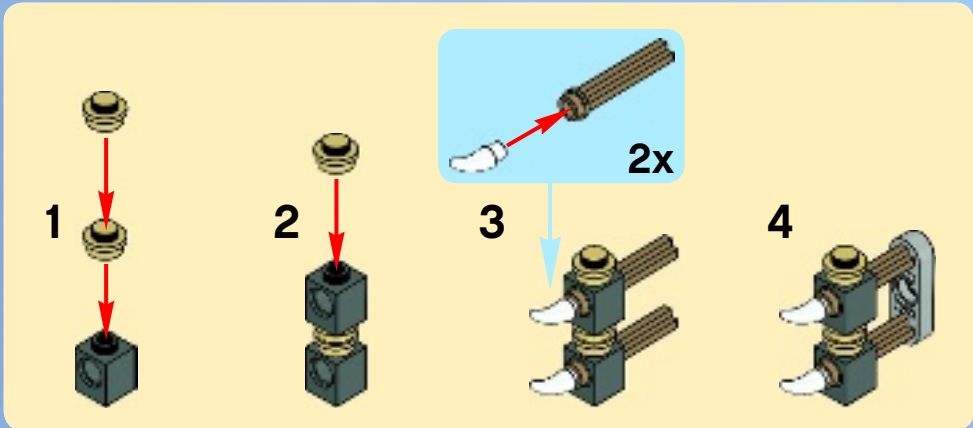

# 9

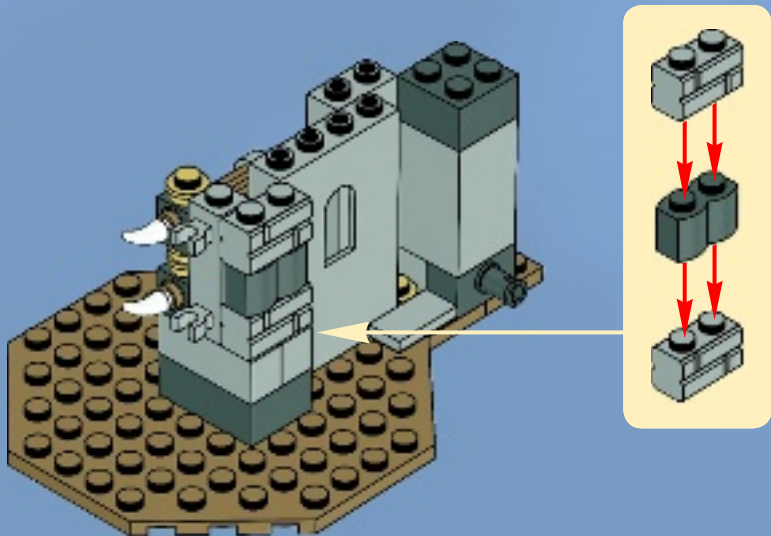



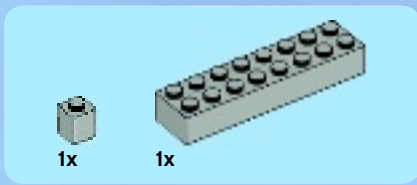

# 10

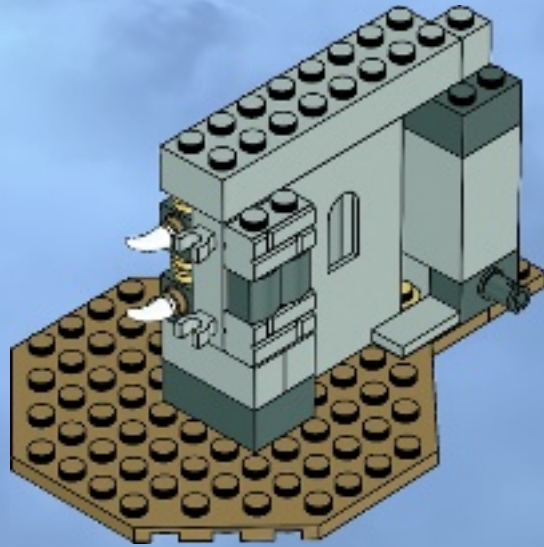

# 11

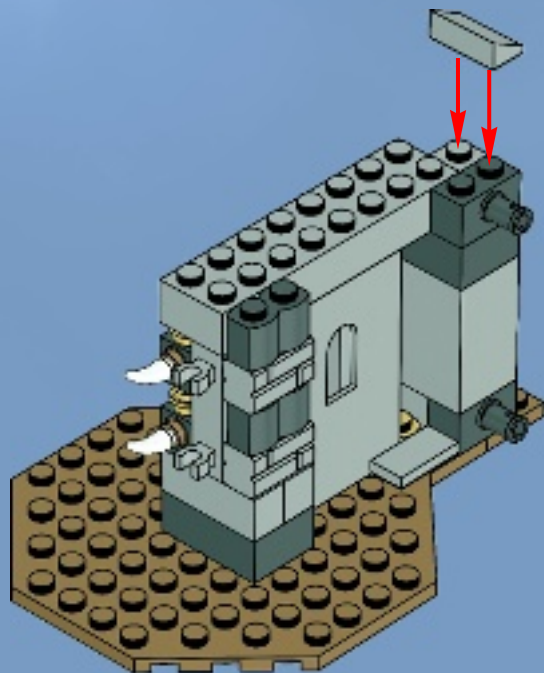



12

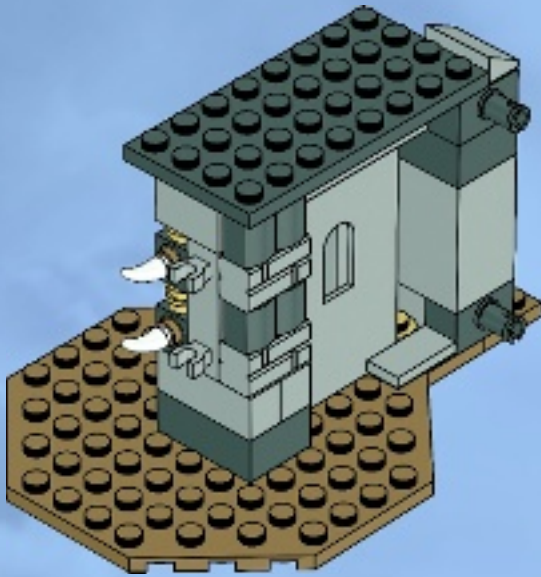

13





1x



1x



2x

# 14

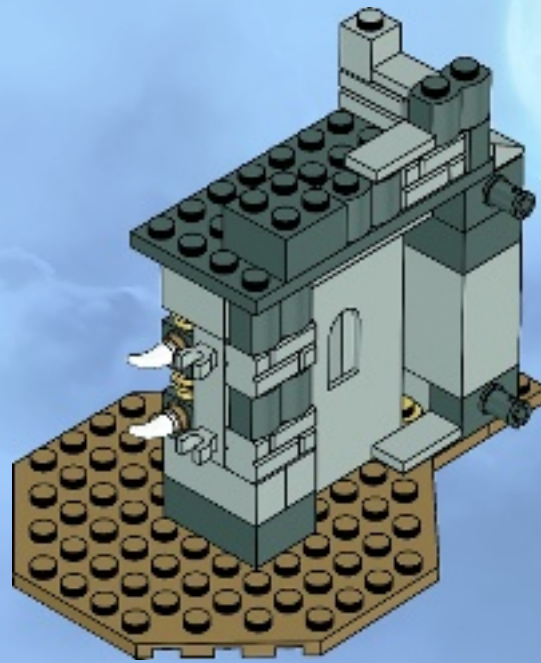

1x



1x



1x

# 15

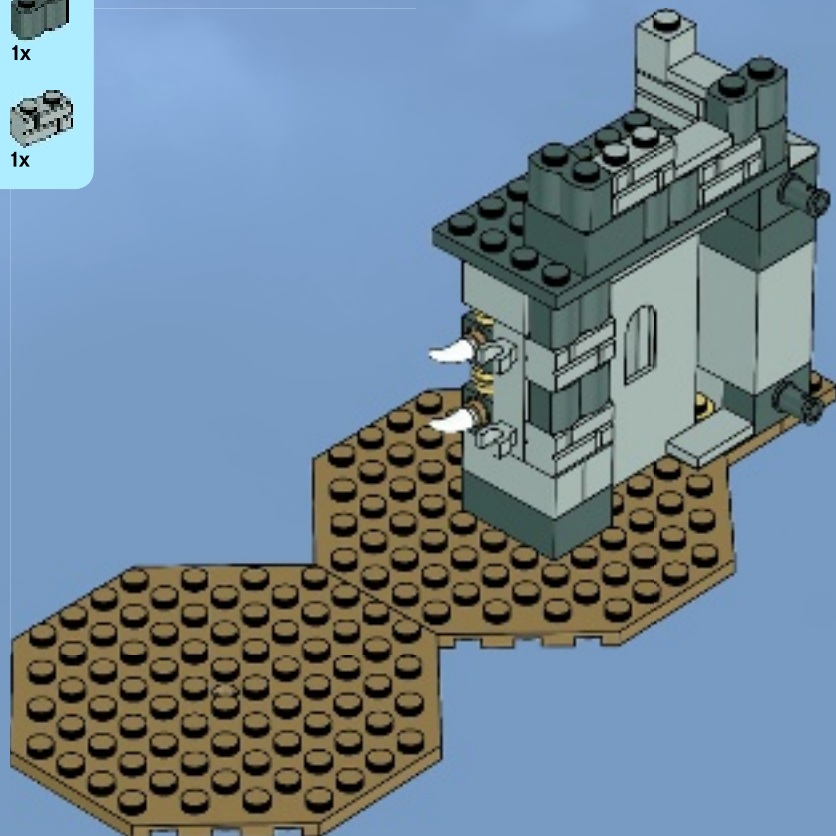

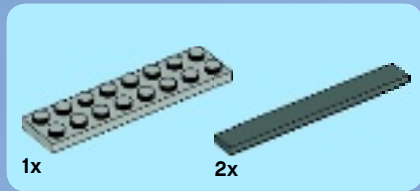

16

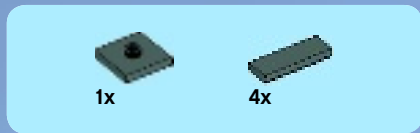
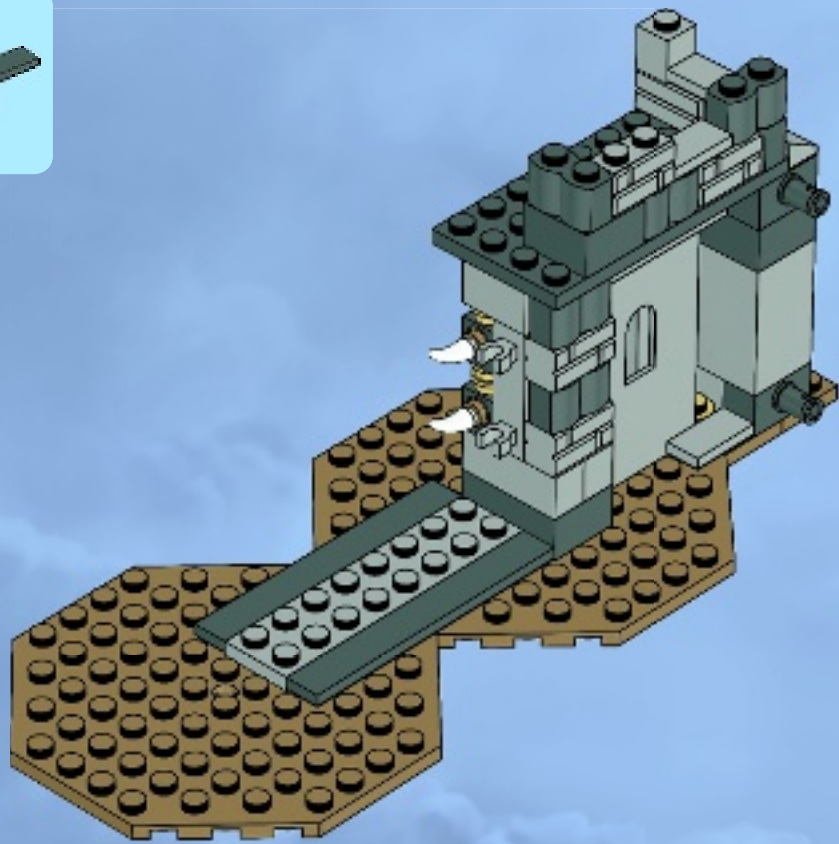

17

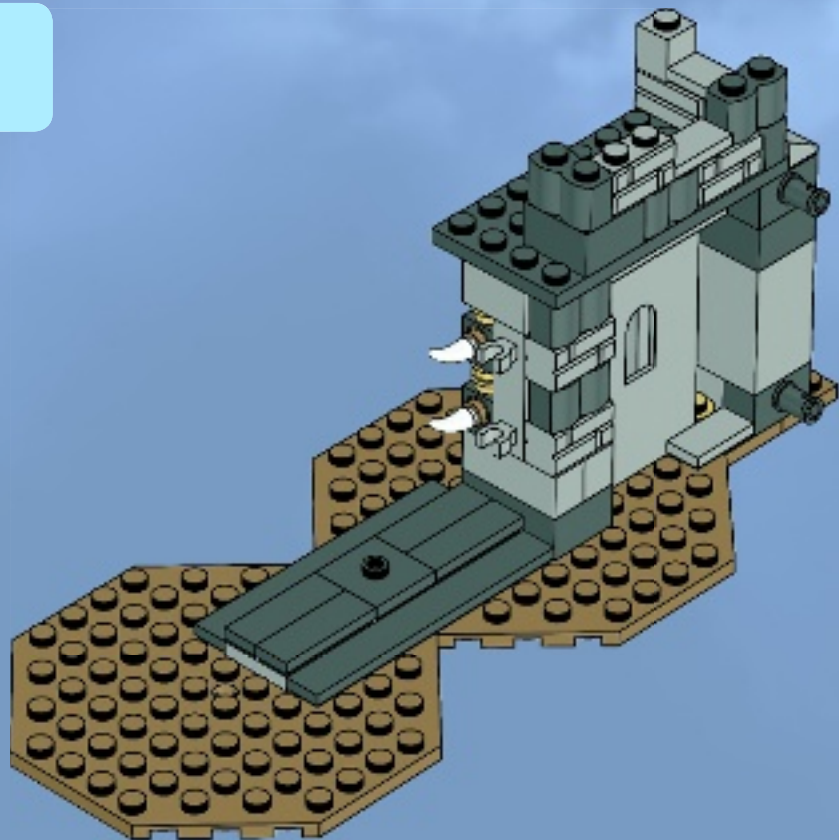



1x



1x



1x

# 18

1



2

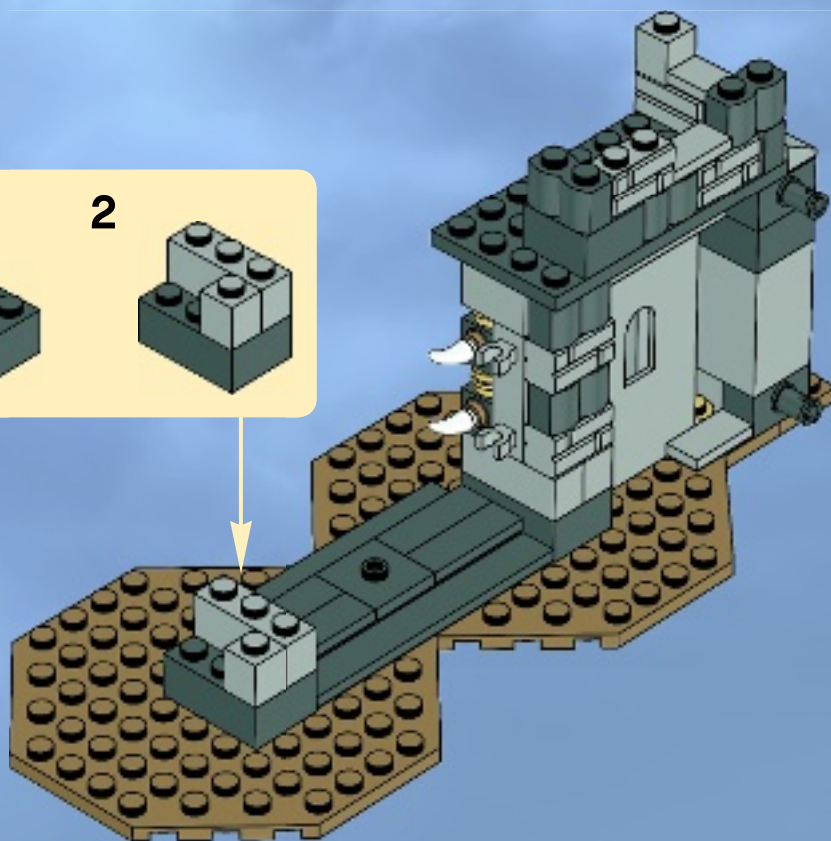
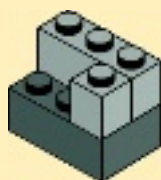

- 3x
- 2x
- 1x
- 2x
- 2x

# 19

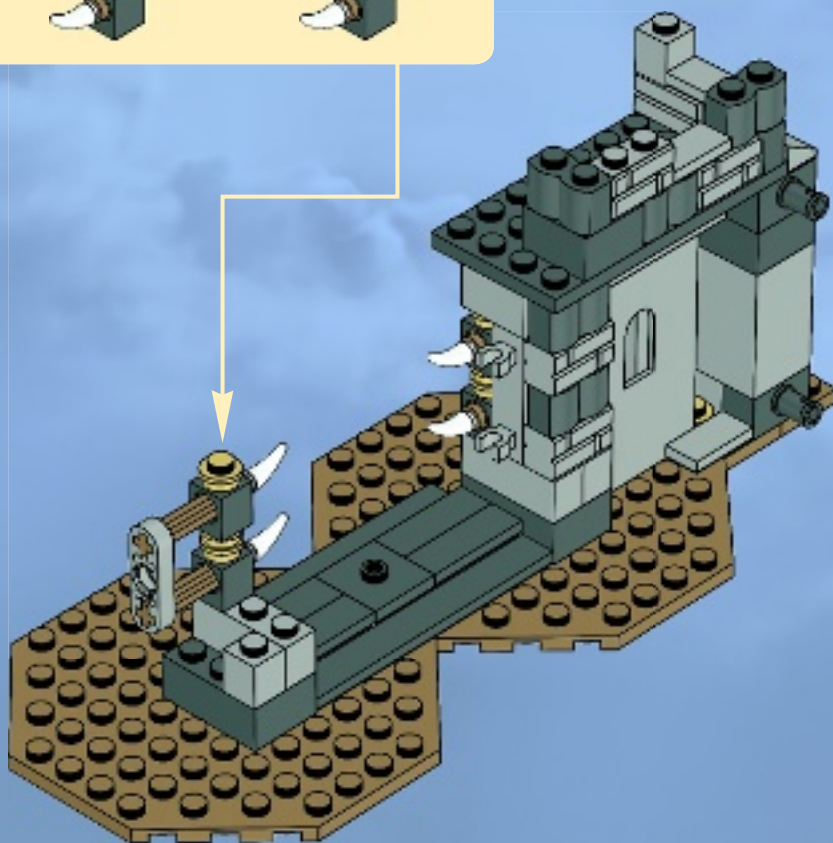
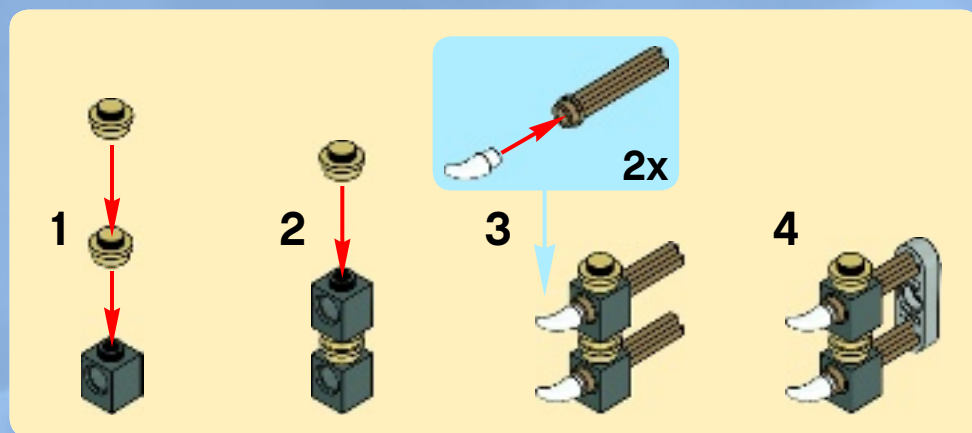



1x

# 20

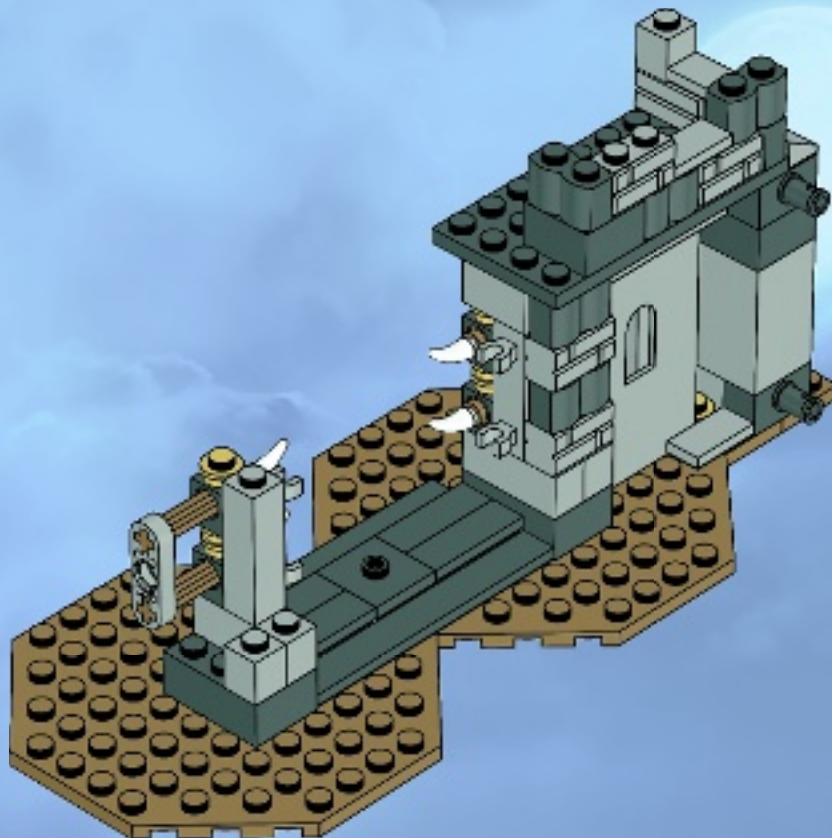

2x



2x

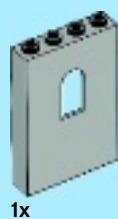

1x

# 21

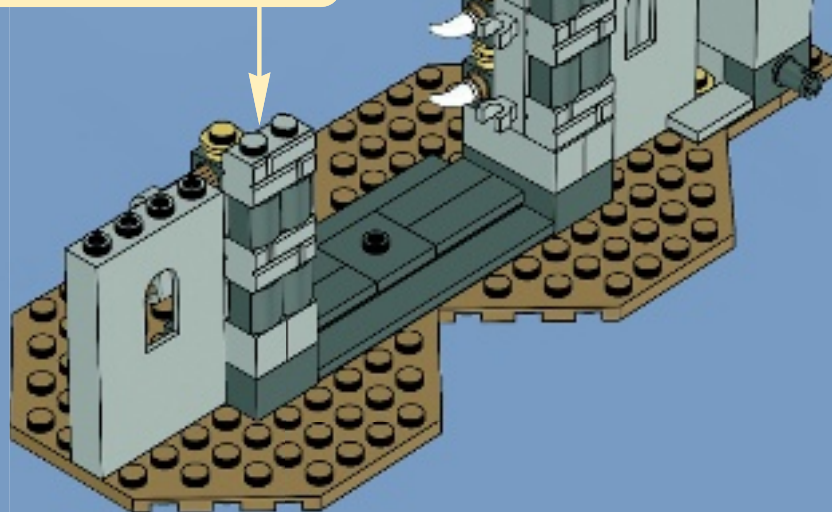
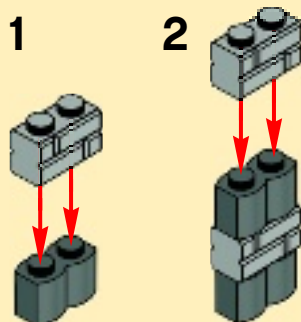

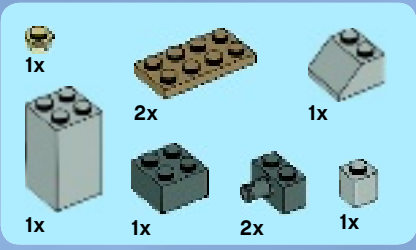

# 22

1

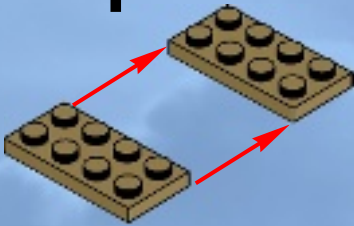

2



3

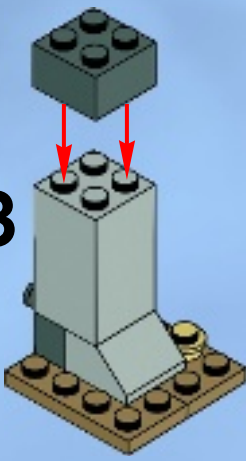

4

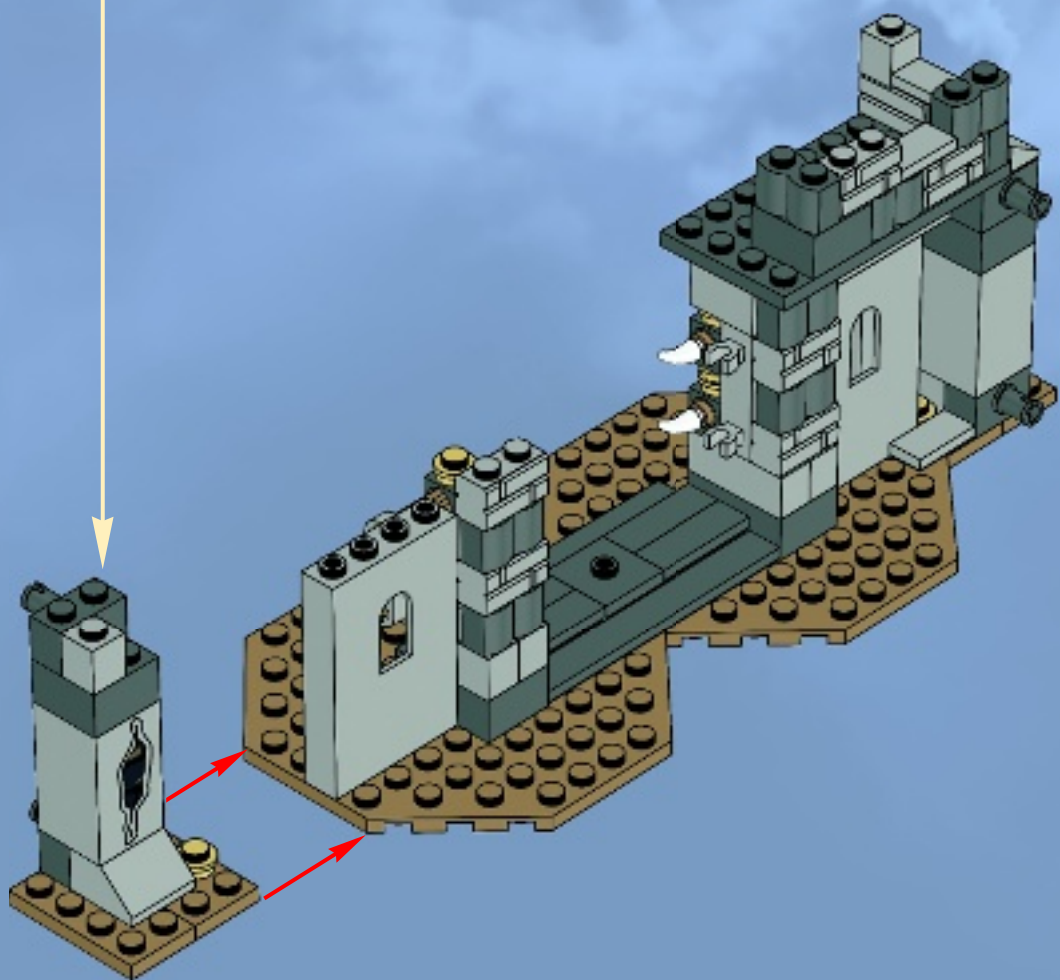
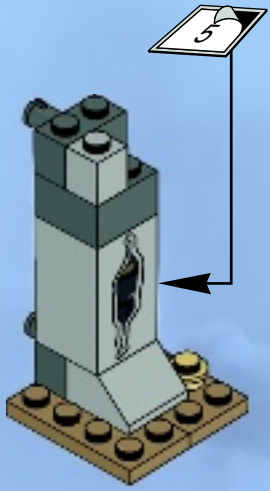



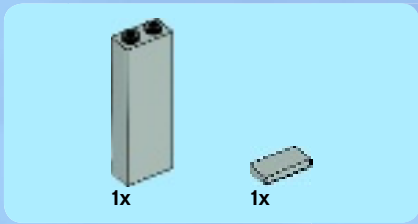

23

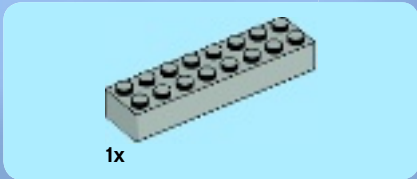
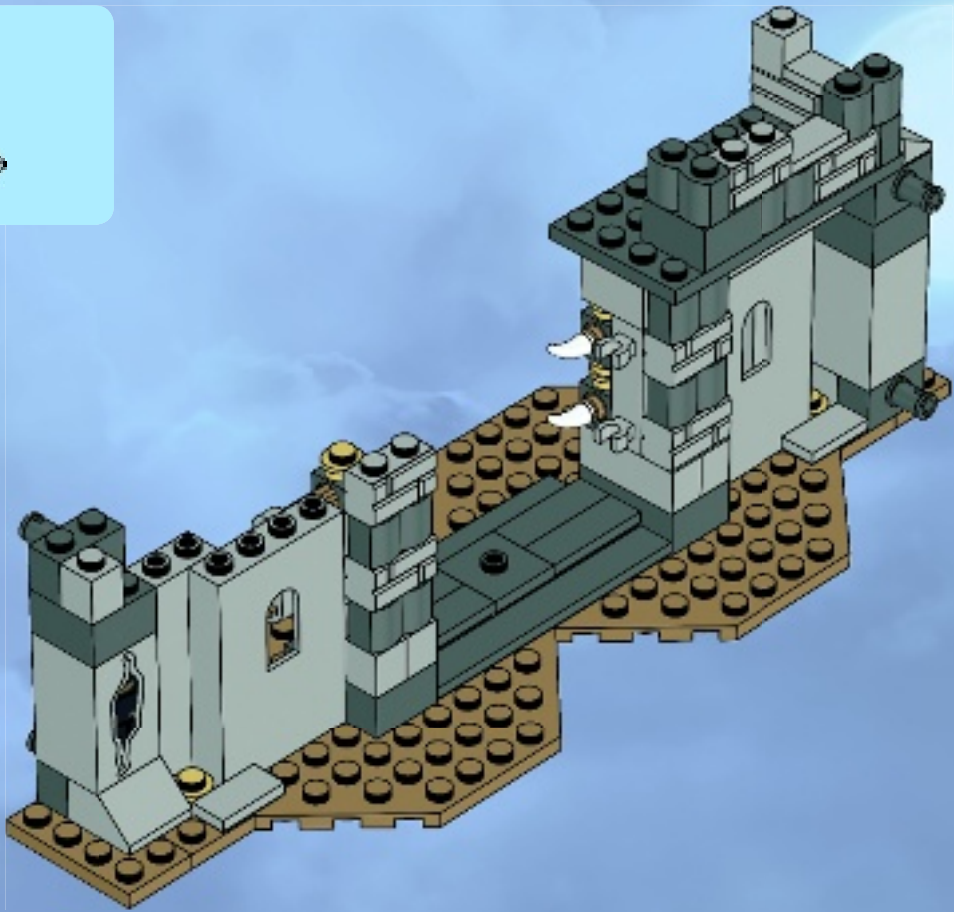

24

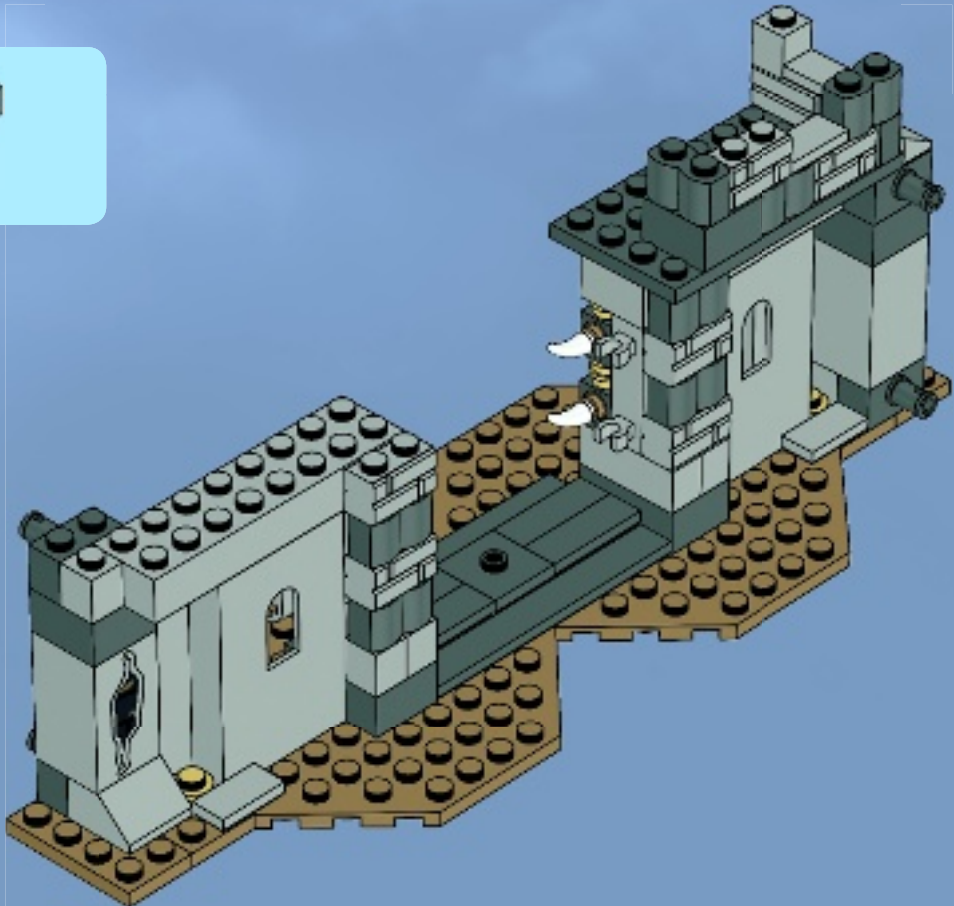



25

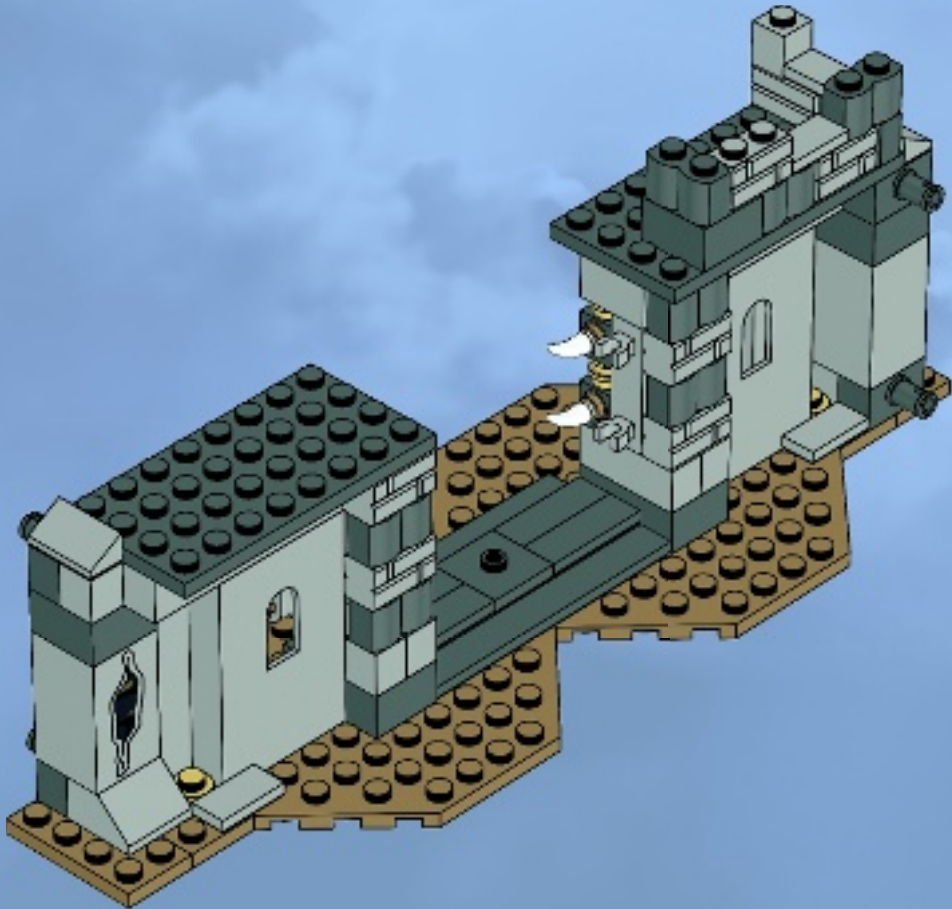



1x



2x



2x

# 26

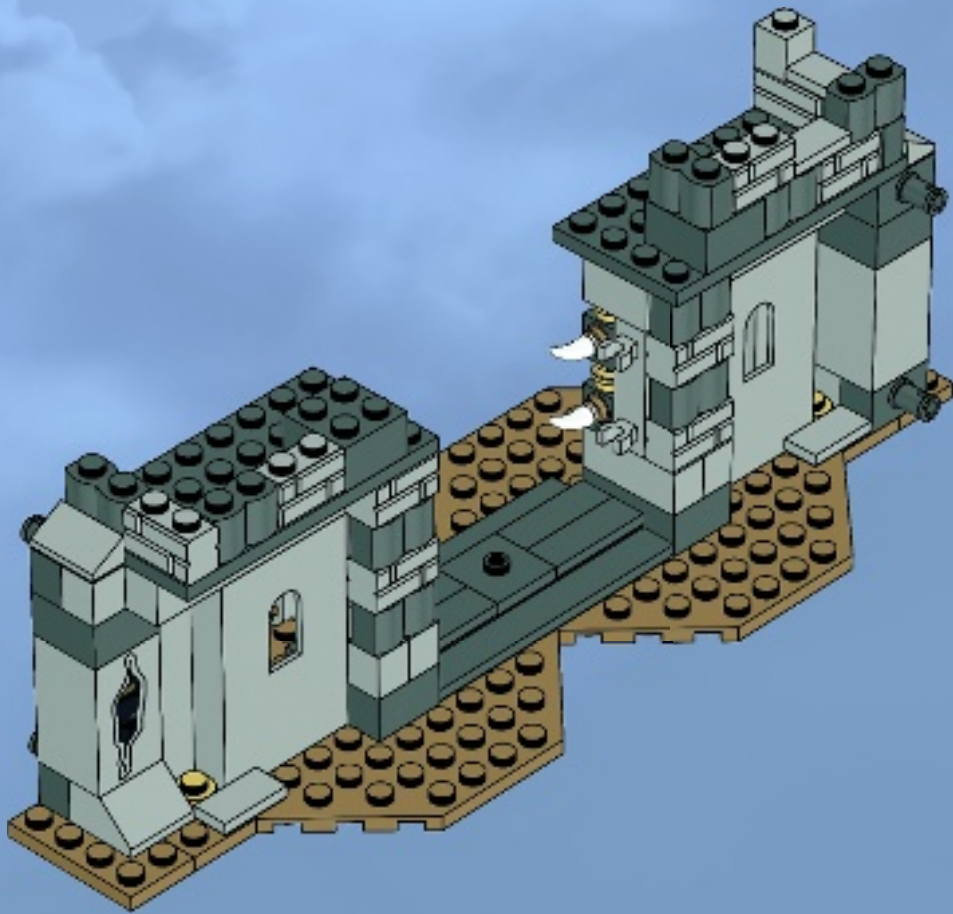



3x



1x



2x

# 27

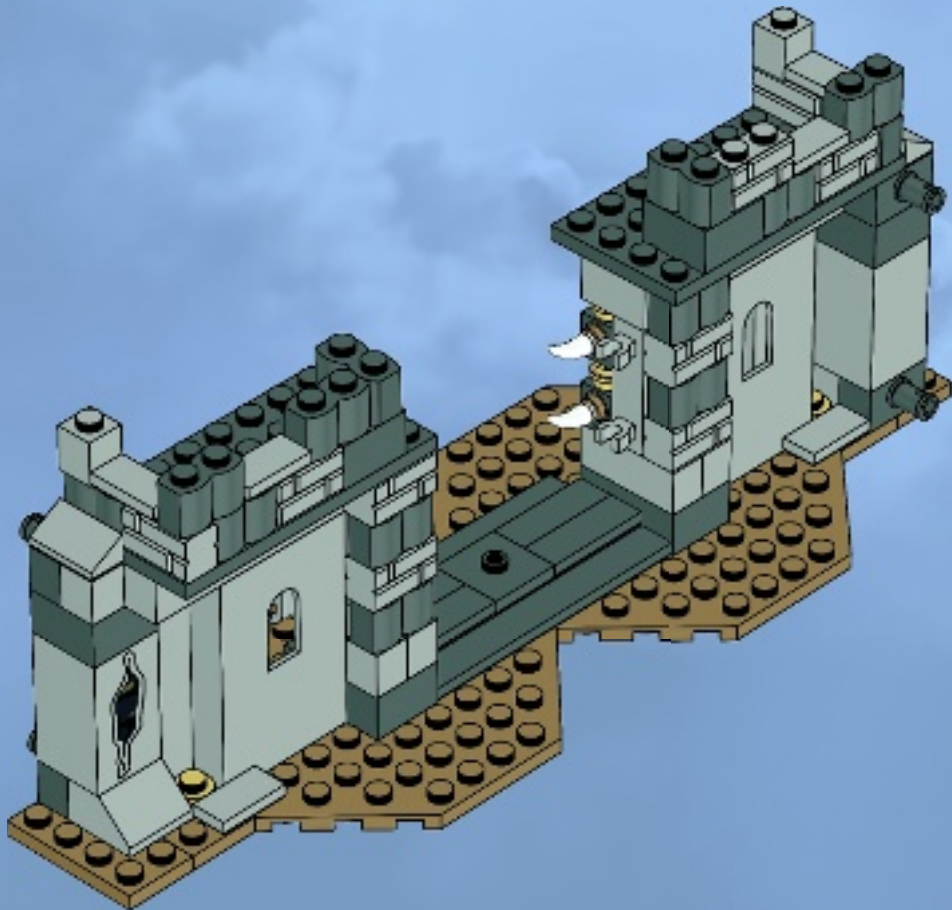

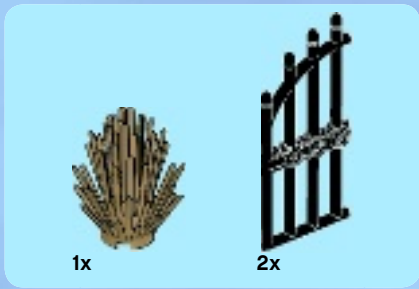

28

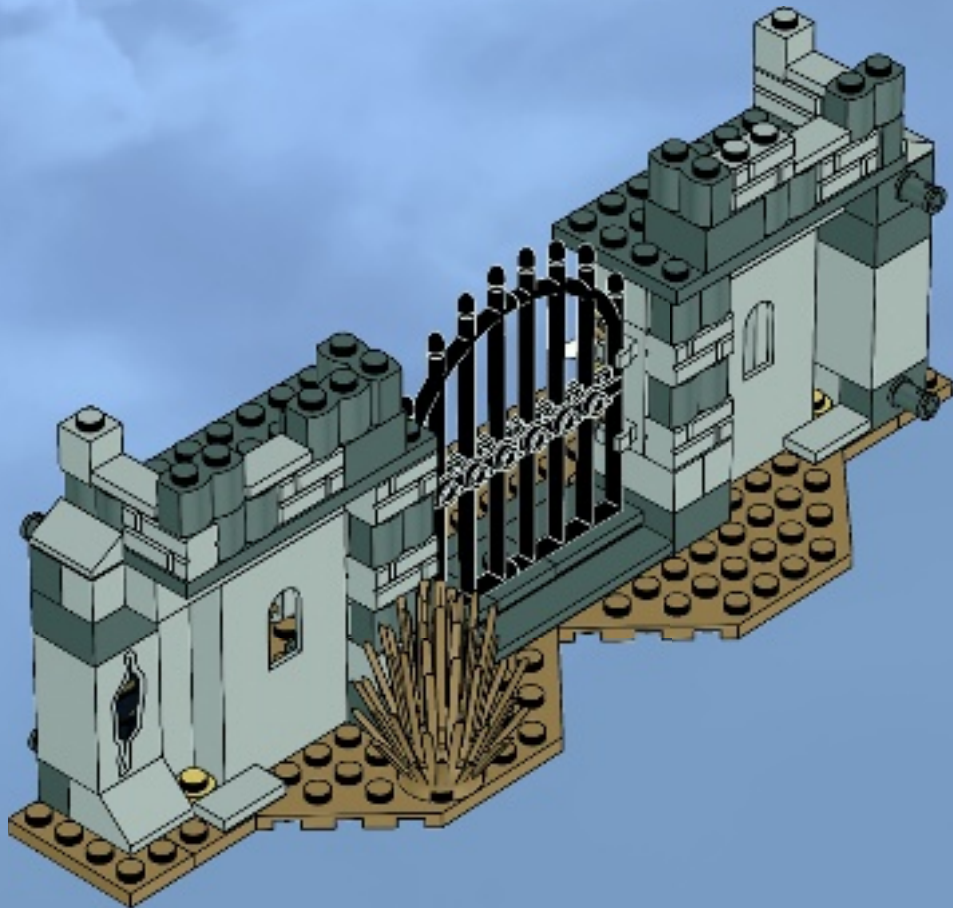

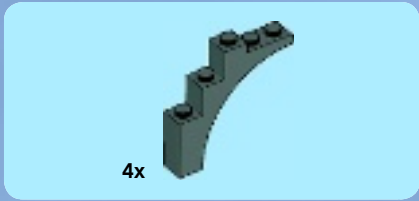

29

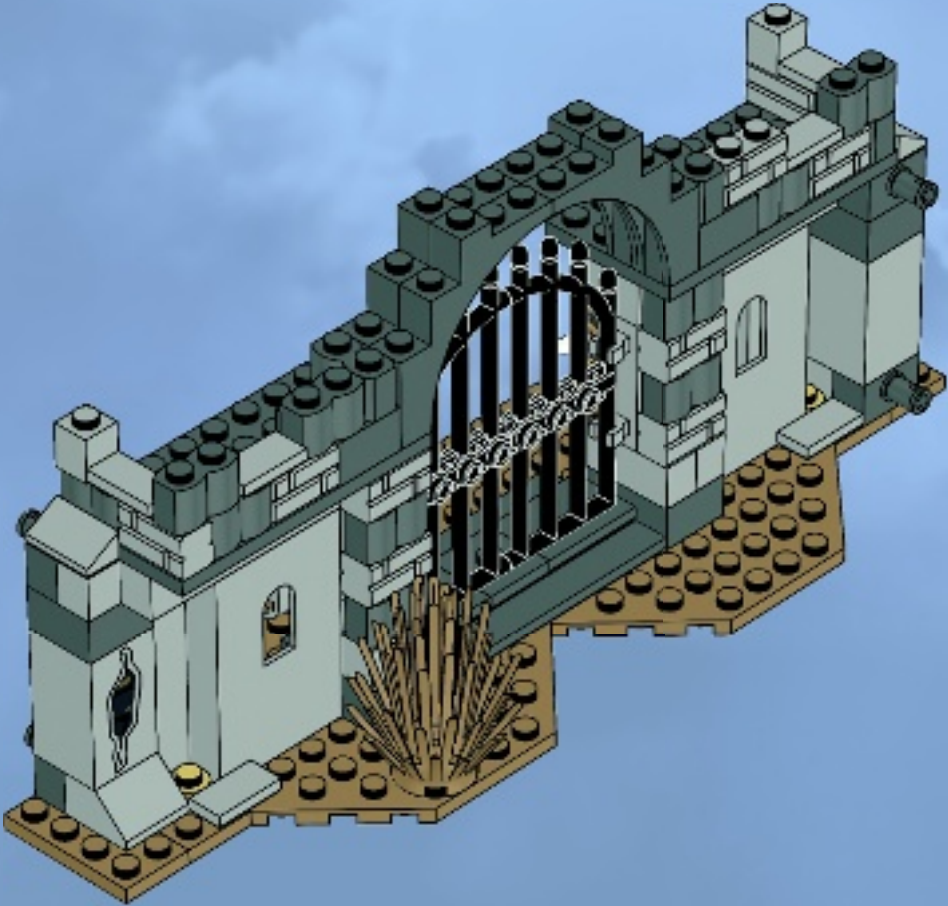



1x



2x

# 30

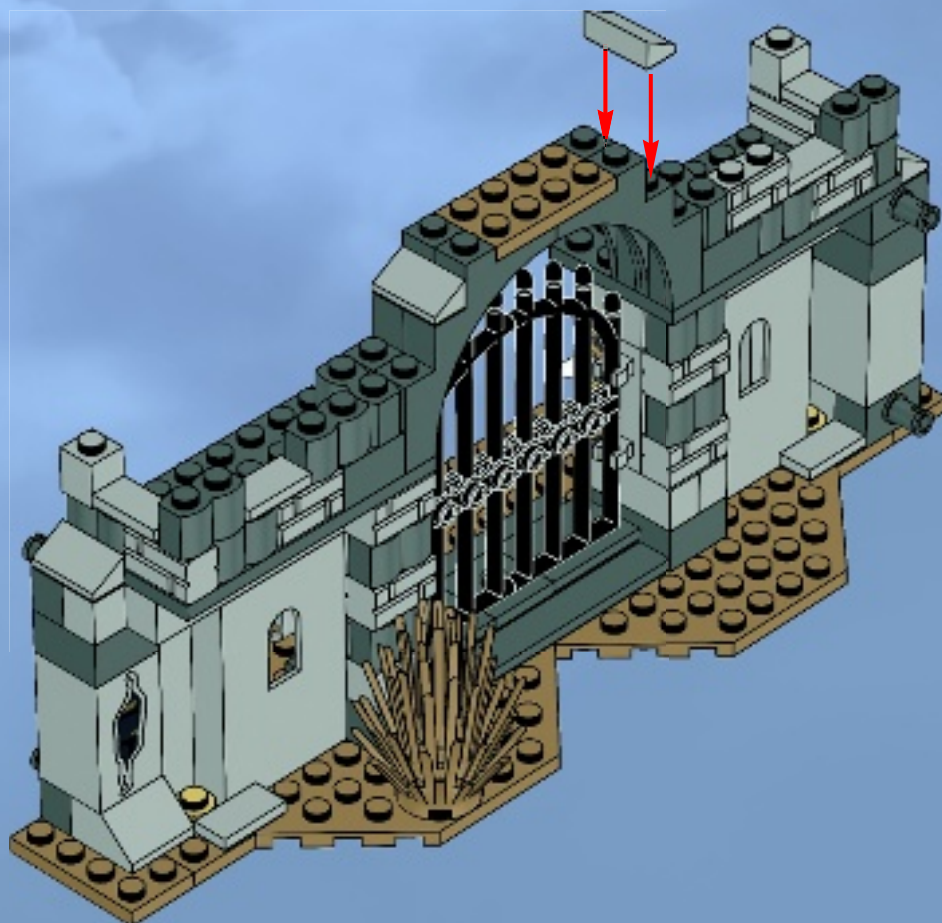



2x

# 31

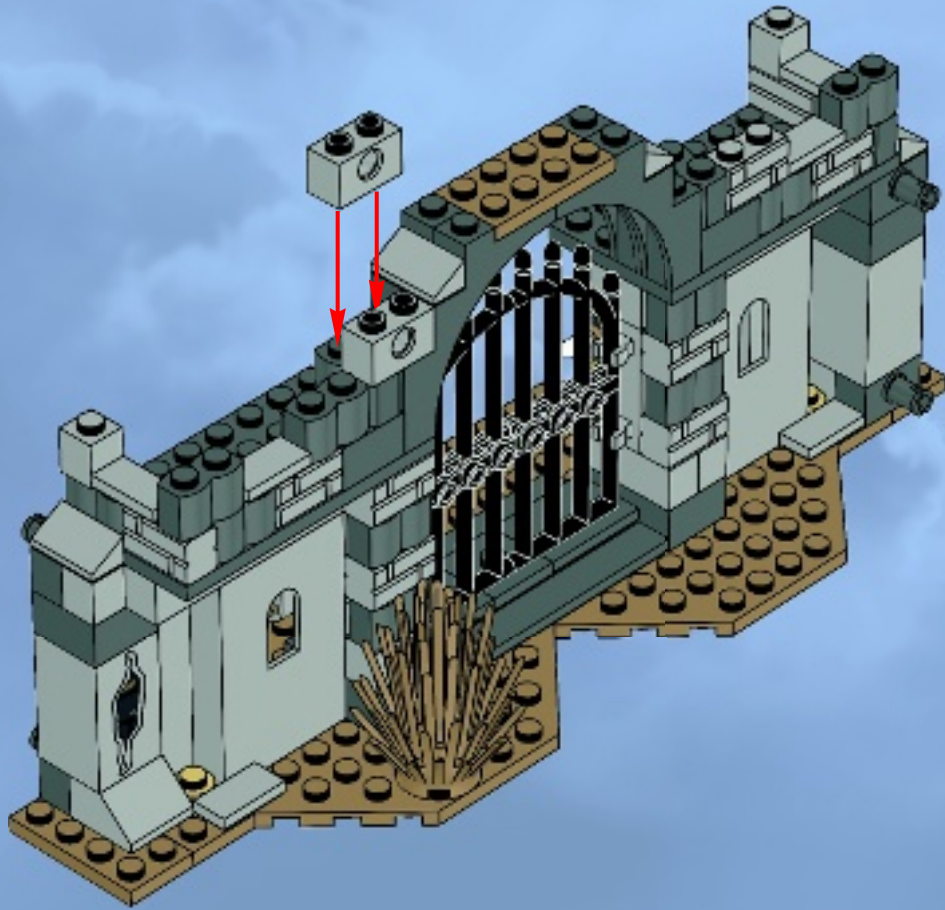





1x



1x

1

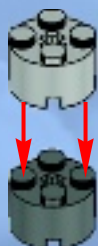

1x



1x

2

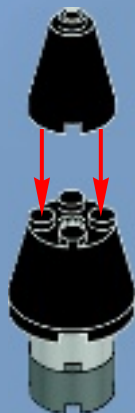

1x



1x

3



1x

4



2x

32

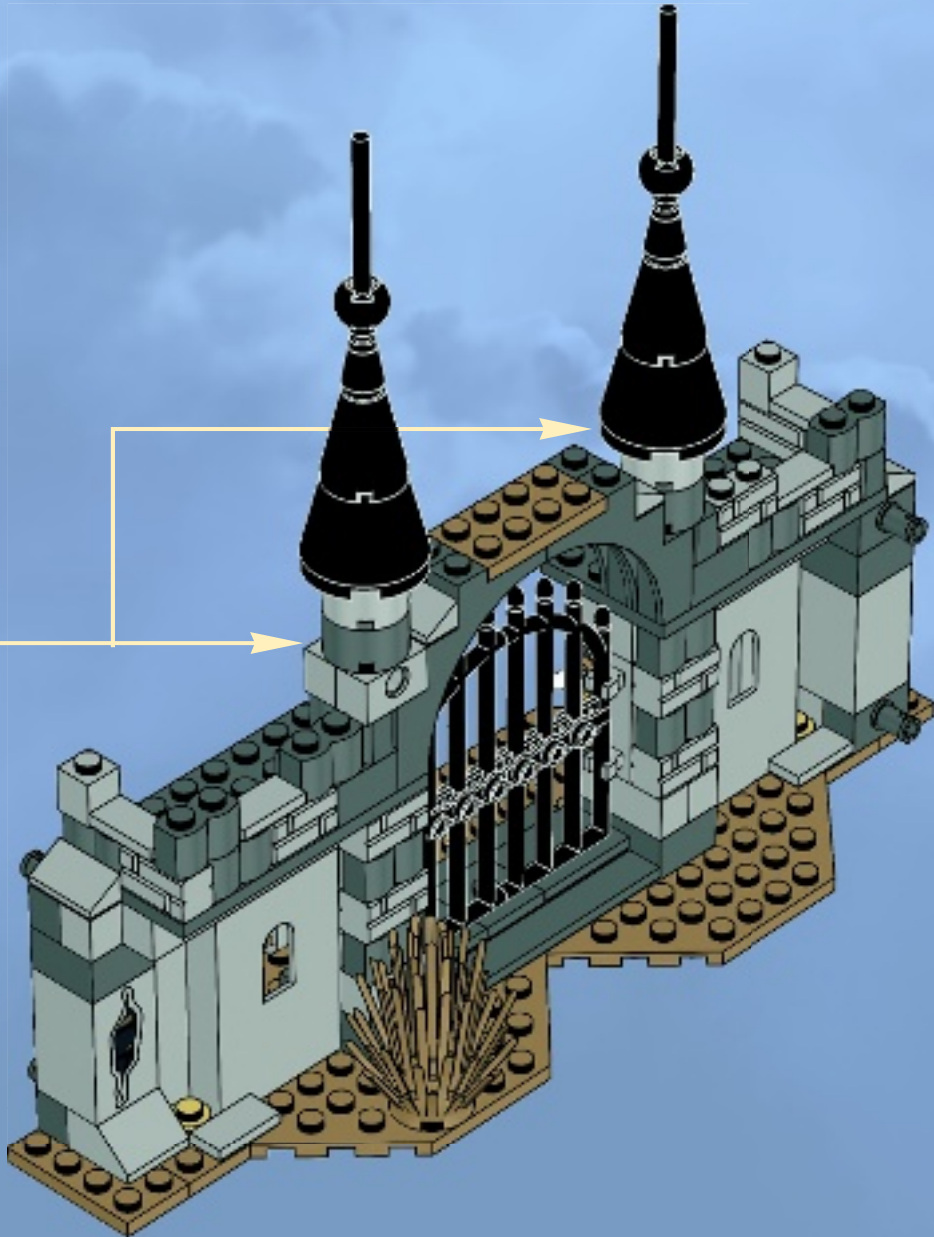



1x





1x

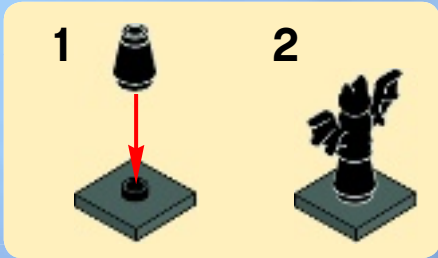

1x

# 33



- 1x 
- 1x 

# 34

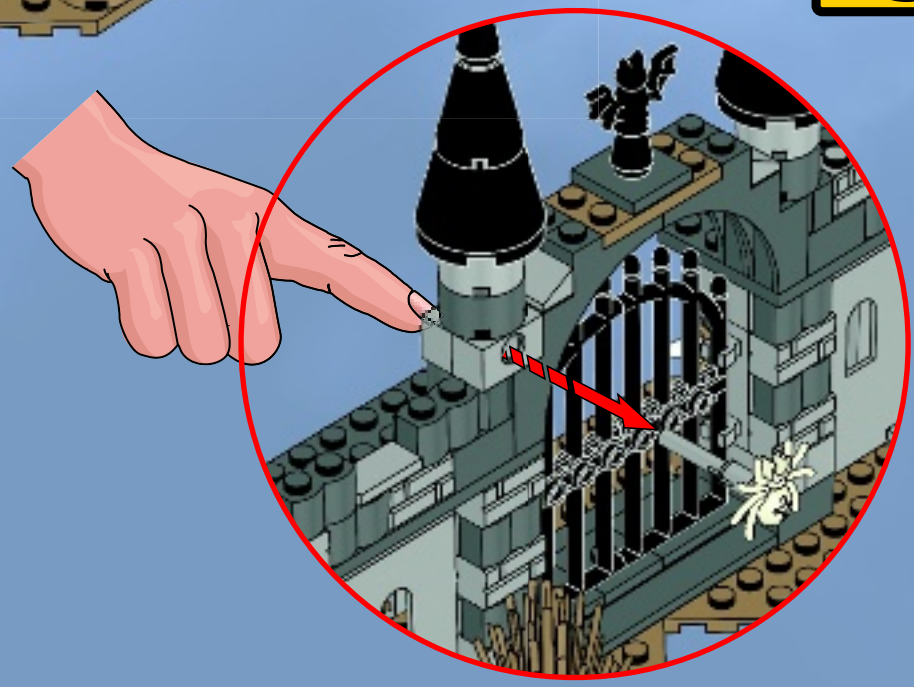
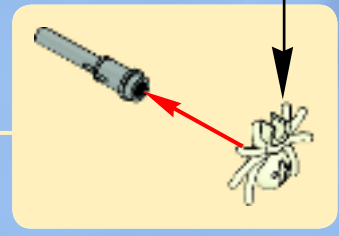
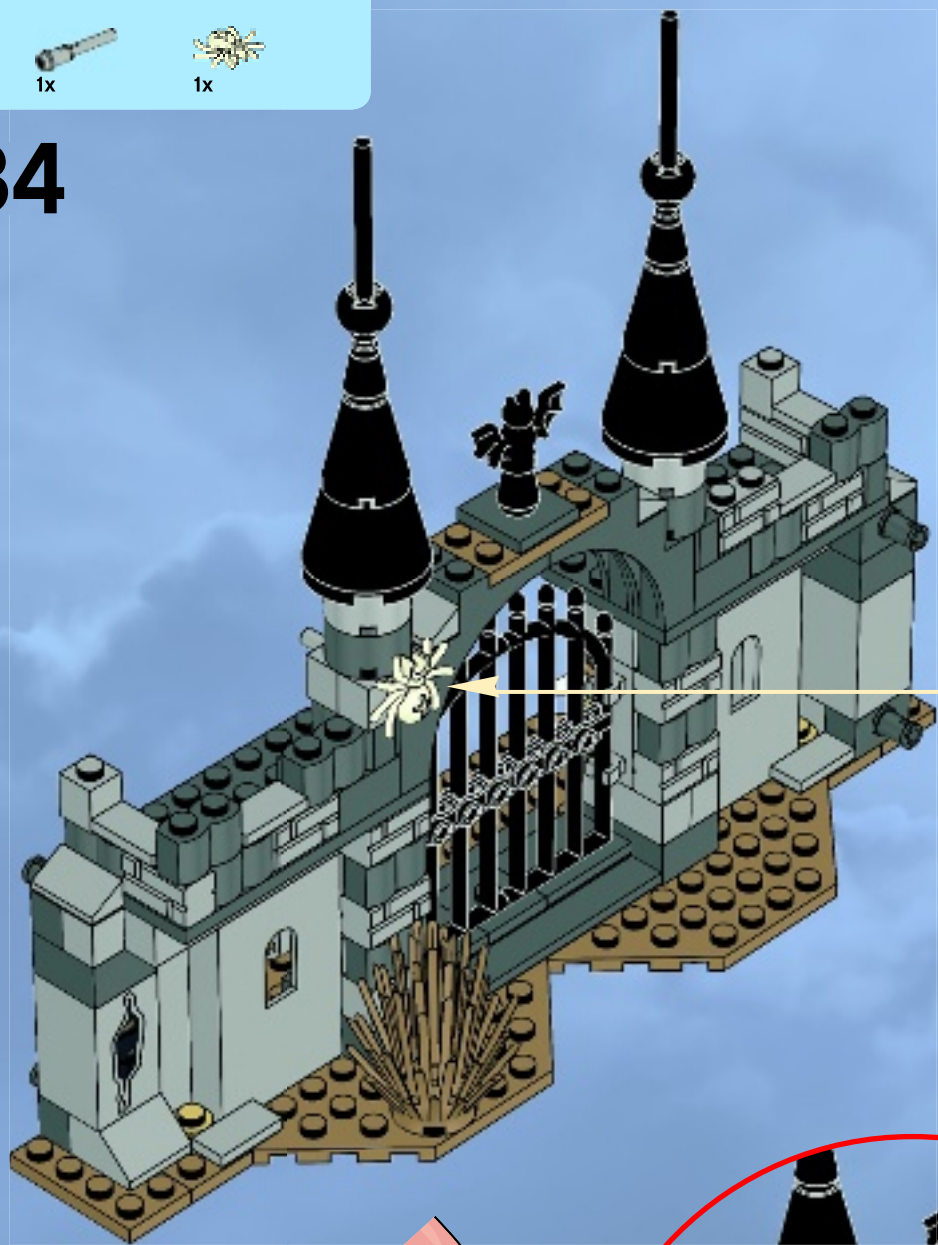

35



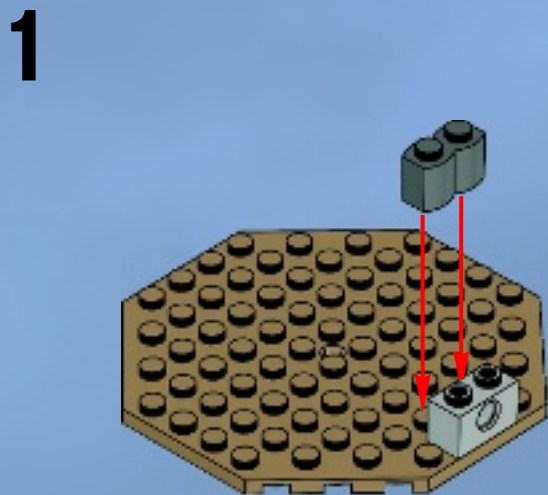
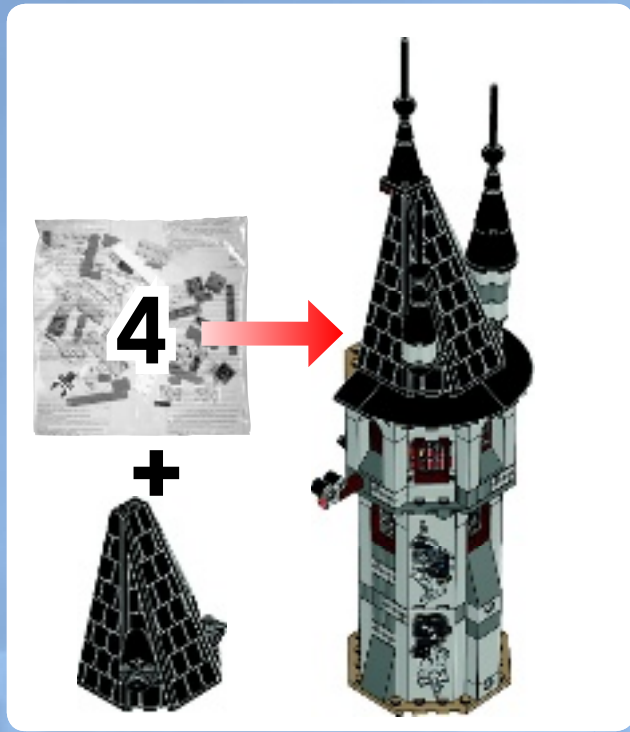

2

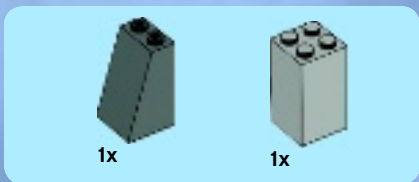

3





1x



1x



1x

# 4

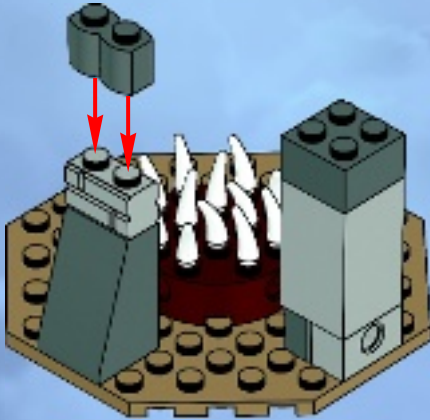

3x



1x

# 6

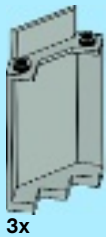
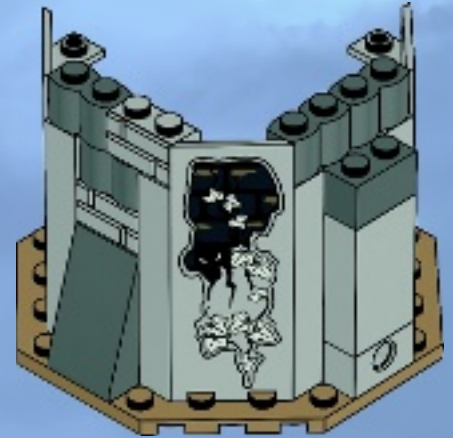

3x

# 5

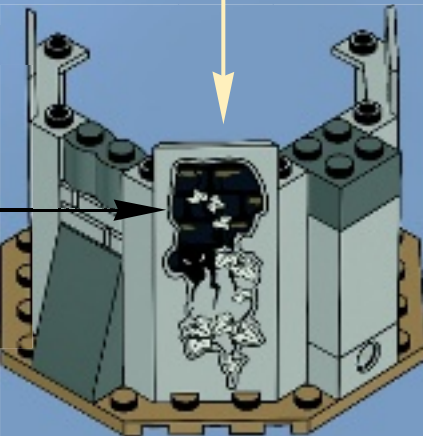
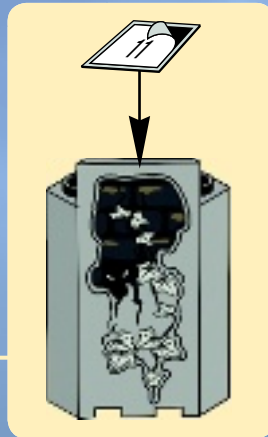

1x



1x



1x

# 7

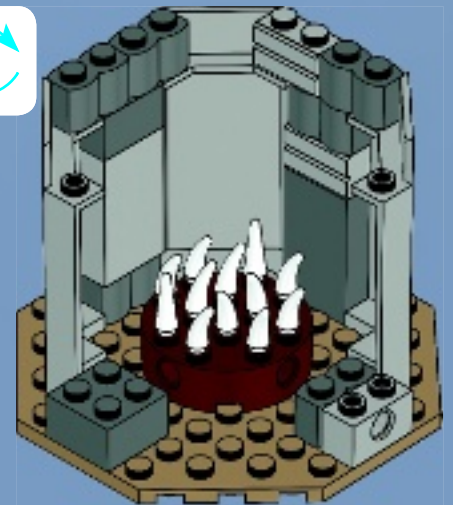



2x

# 8

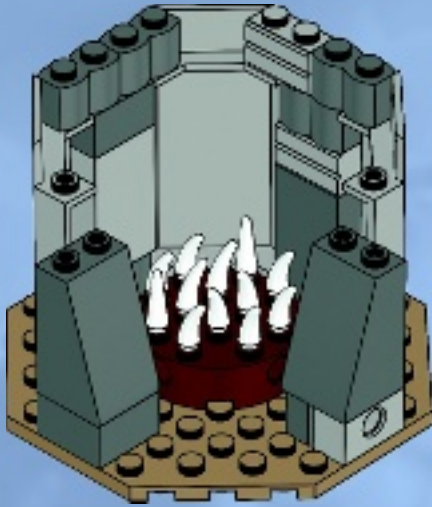

1x



1x

# 9

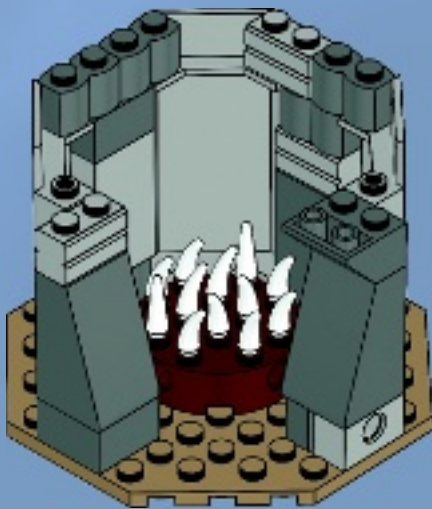

1x



1x

# 10

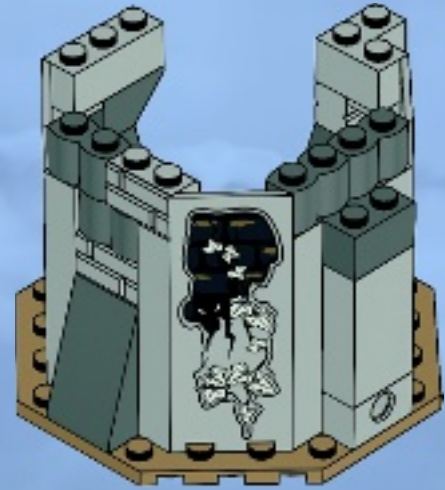





2x

# 11

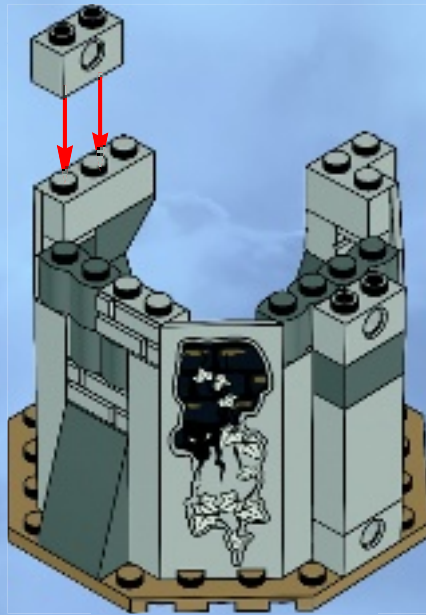

1x



1x



1x

# 12

1

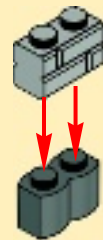

2

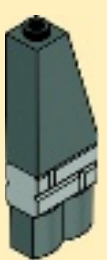



# 13

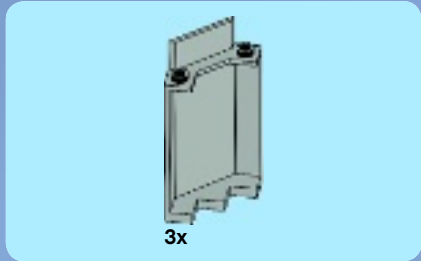
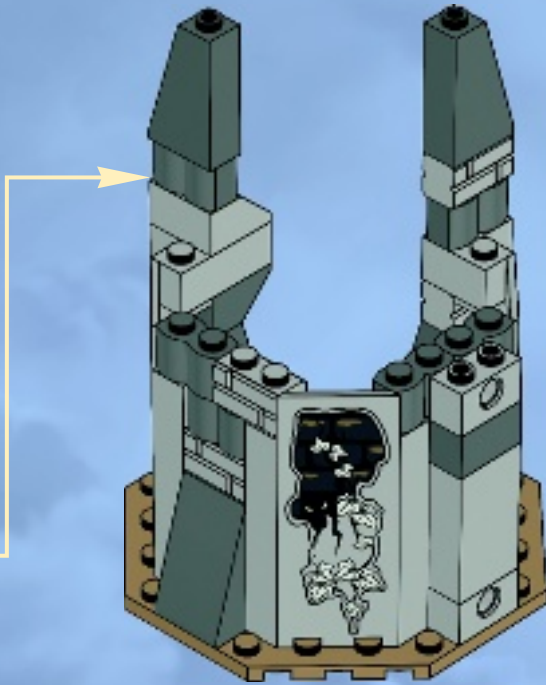
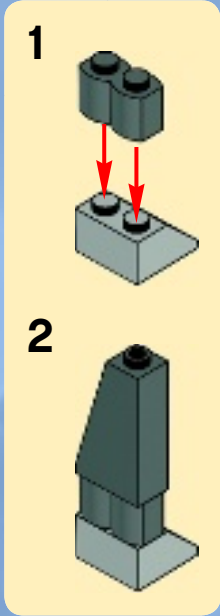

# 14

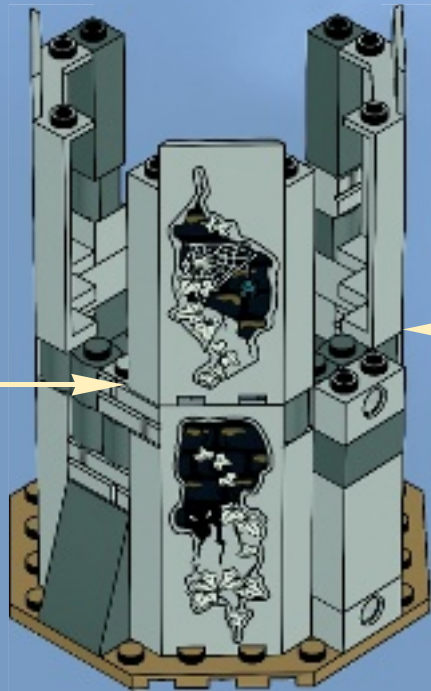
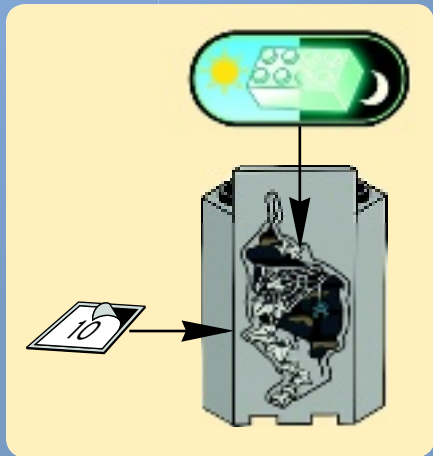

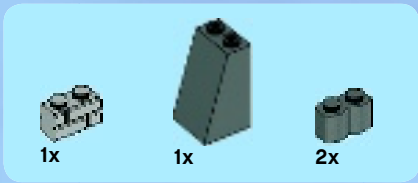

15

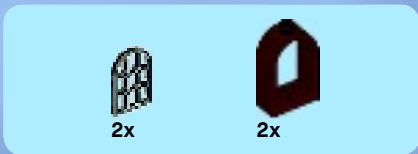
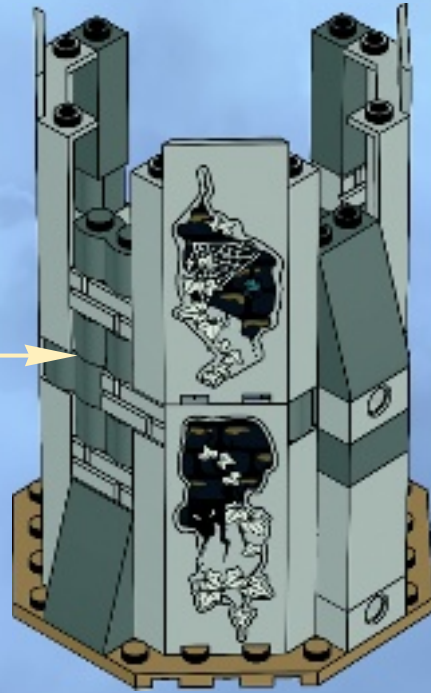
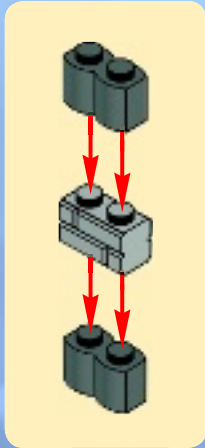

16

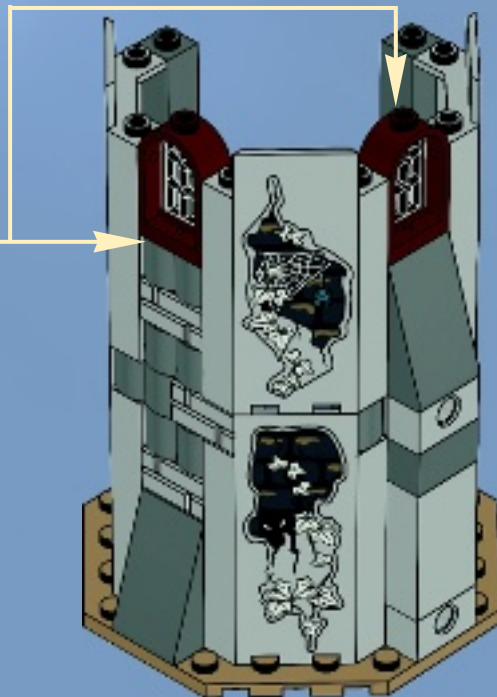
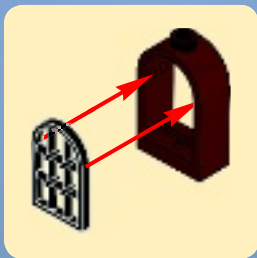

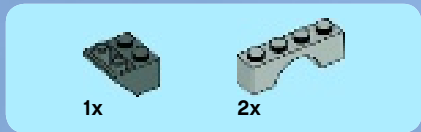

# 17

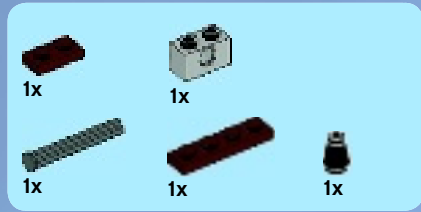
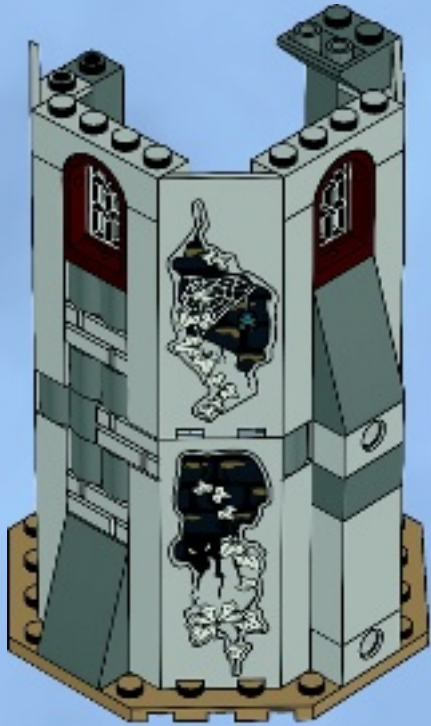

# 18

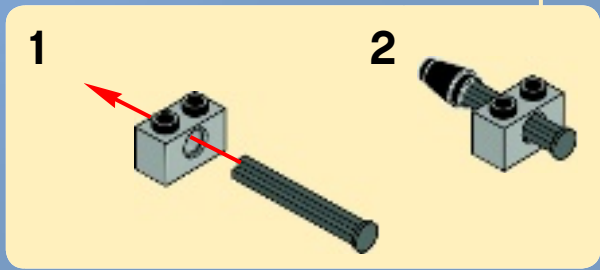
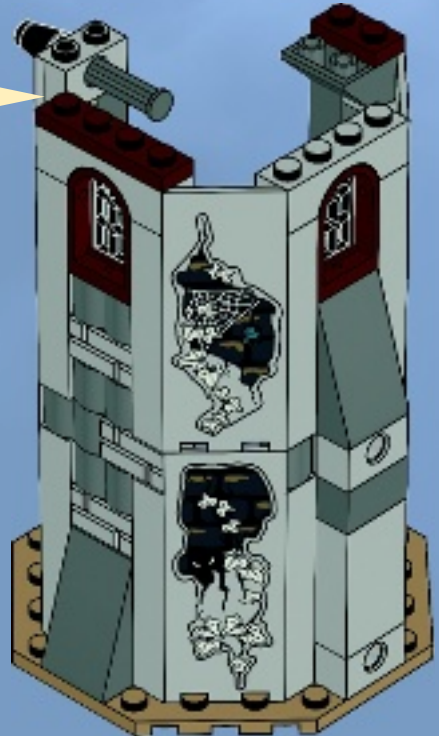

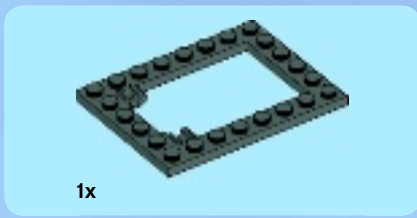

19

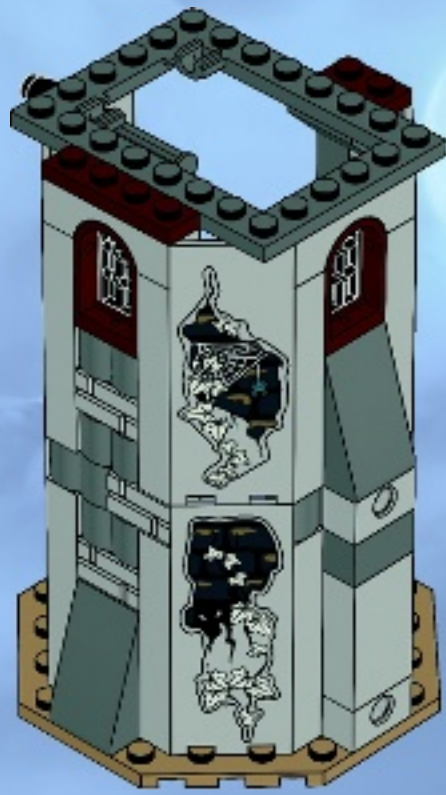

20

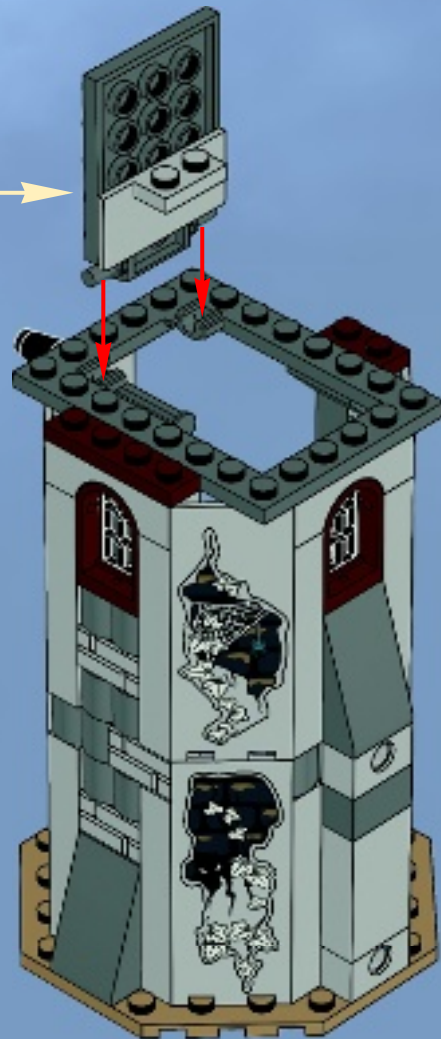
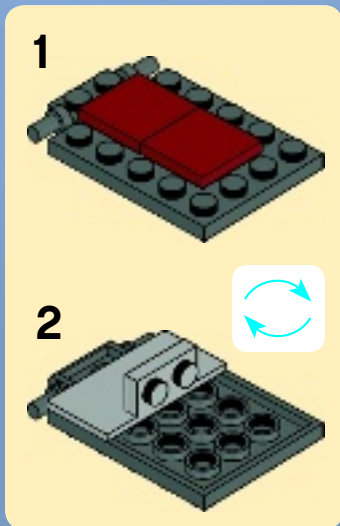



# 21

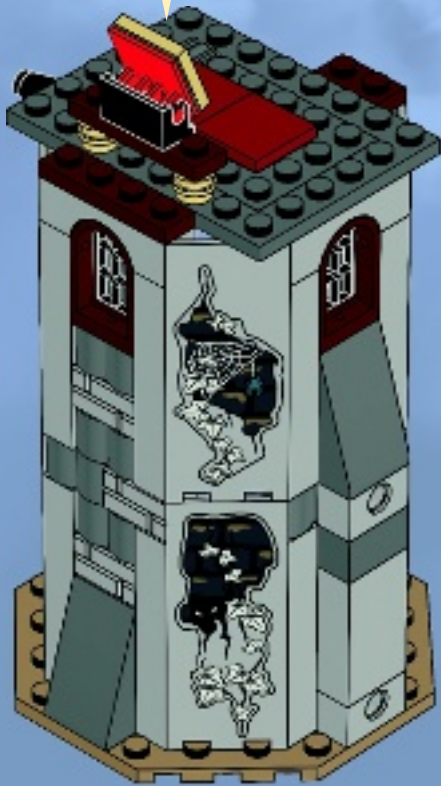
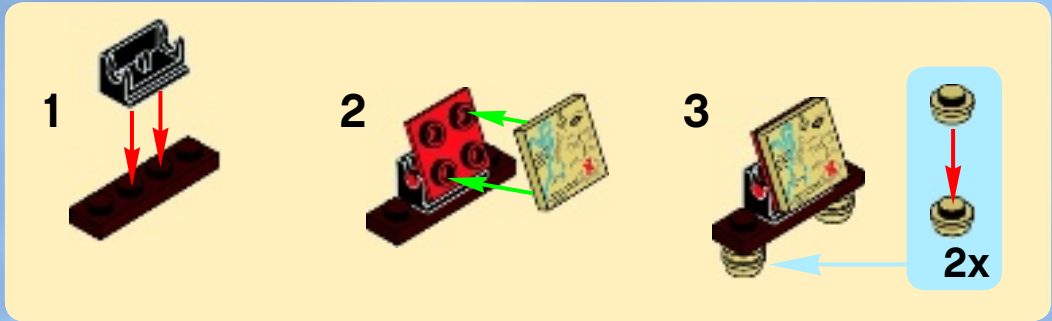

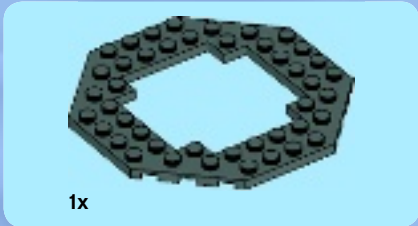

1x

# 1

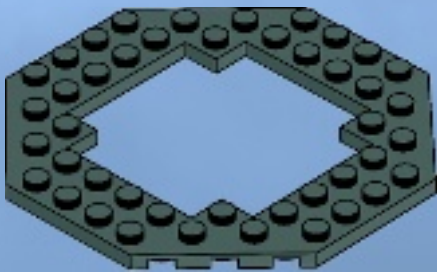

# 2

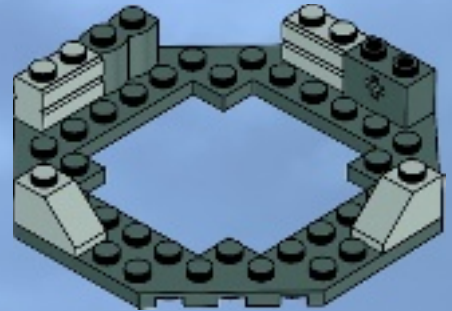

# 3

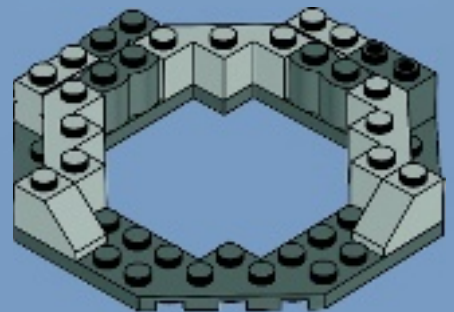

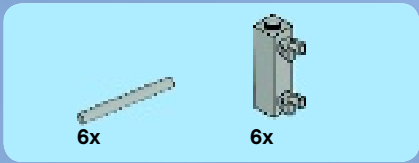

4

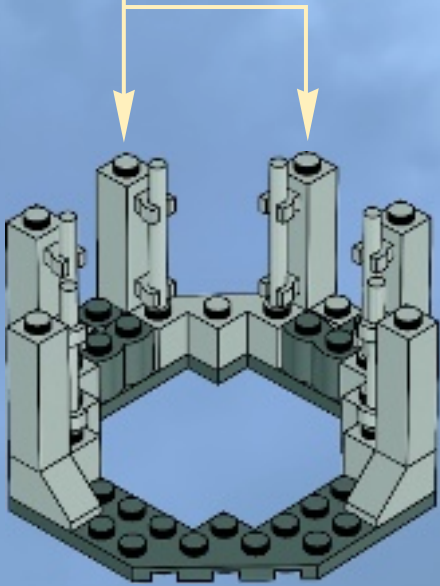
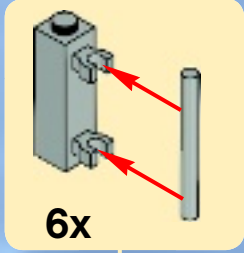

5

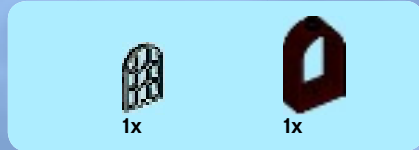
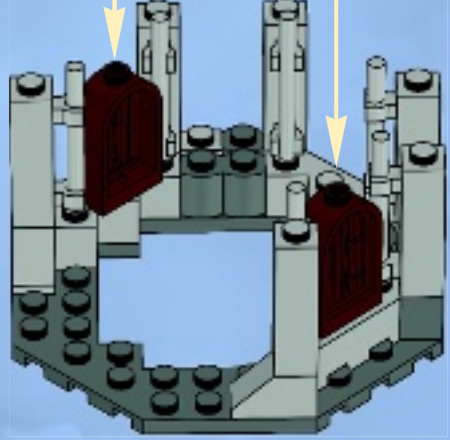
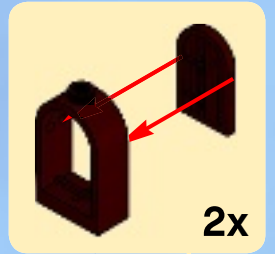

6

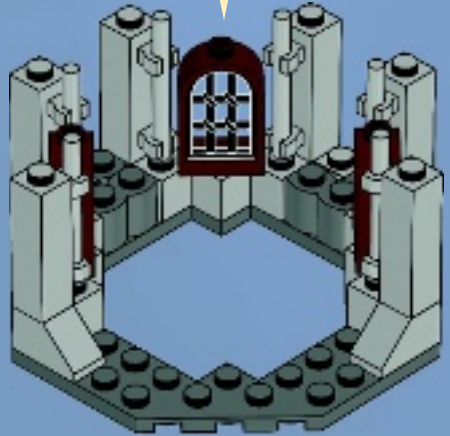
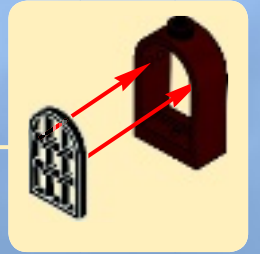





7

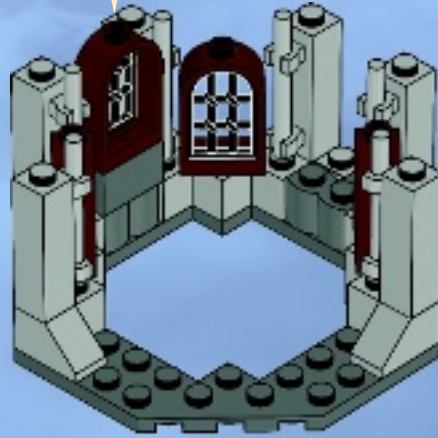
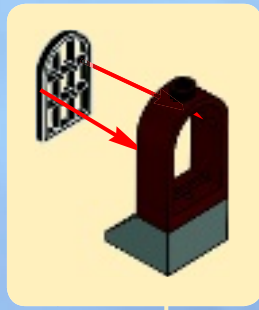

8

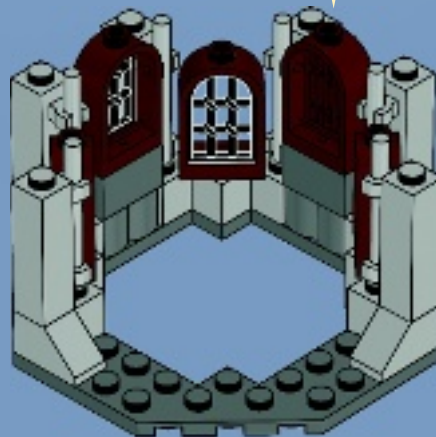
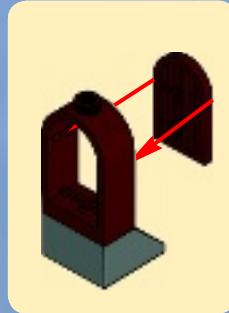



3x

9

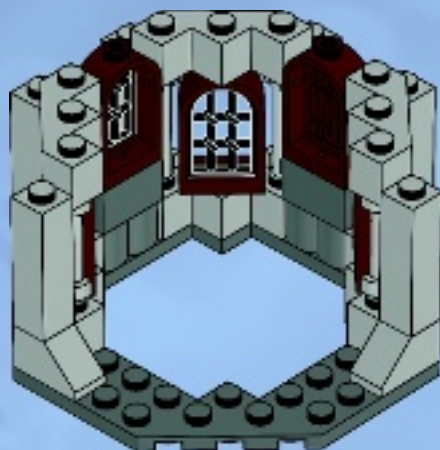

2x



2x

10

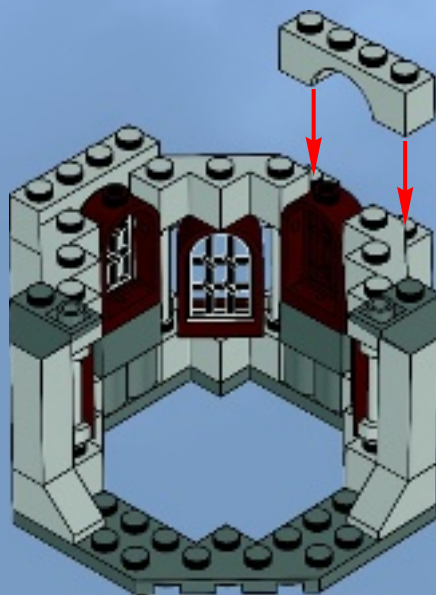



2x



2x



3x

# 11

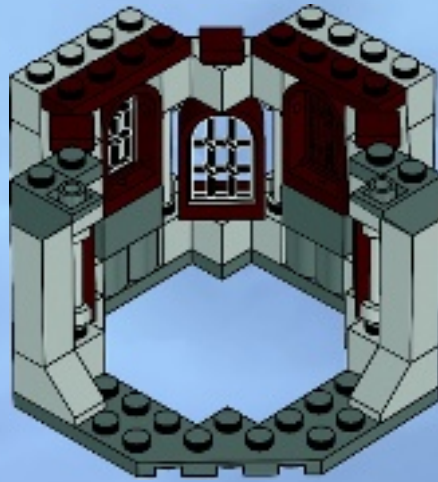

1x

# 12

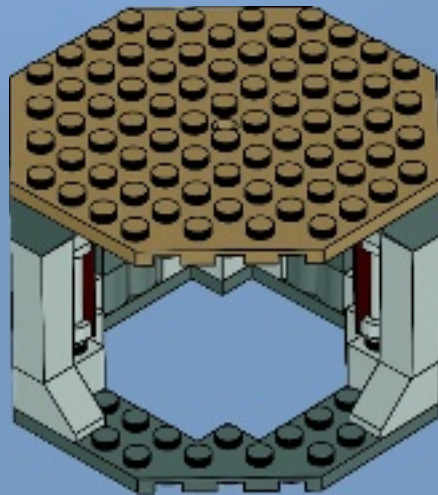

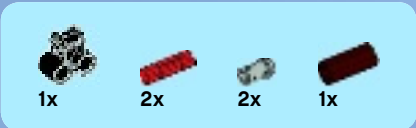

# 13

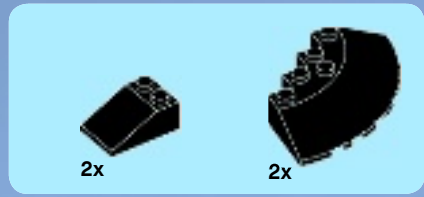
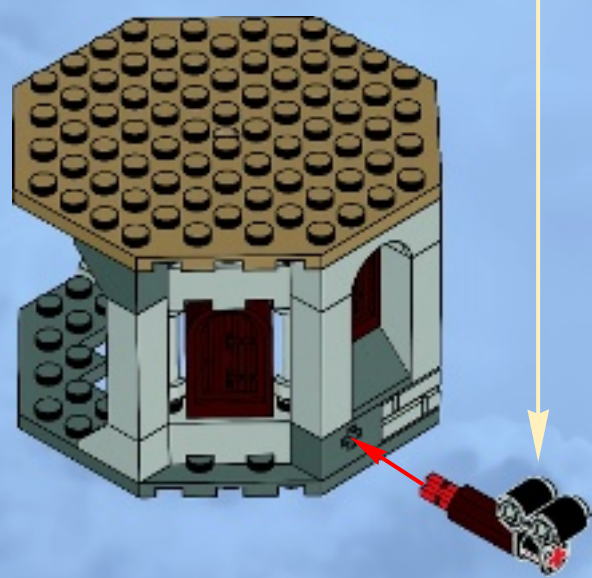
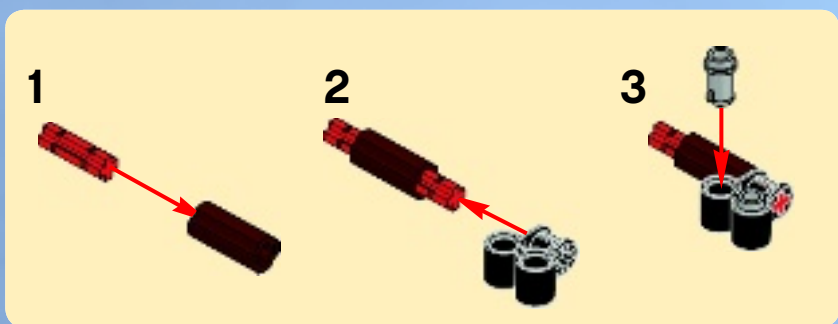

# 14

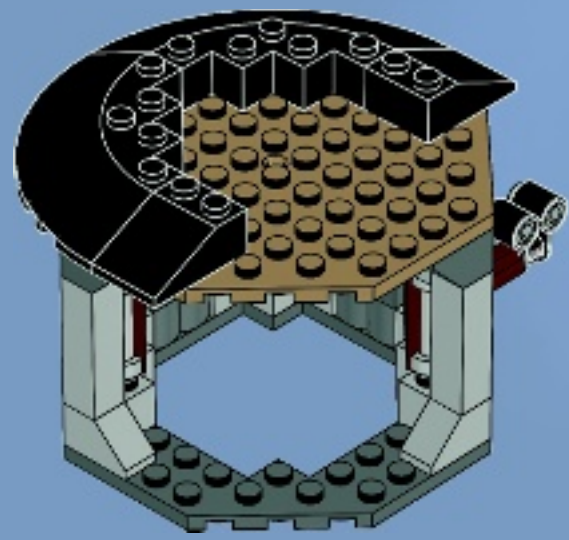

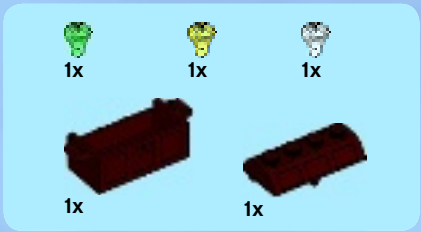

# 15

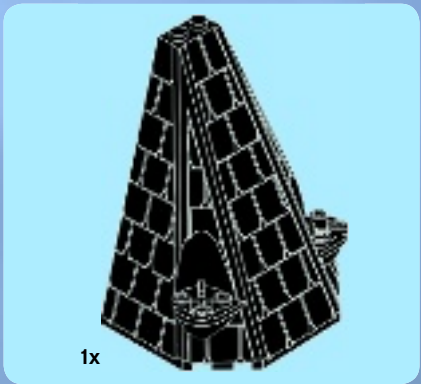
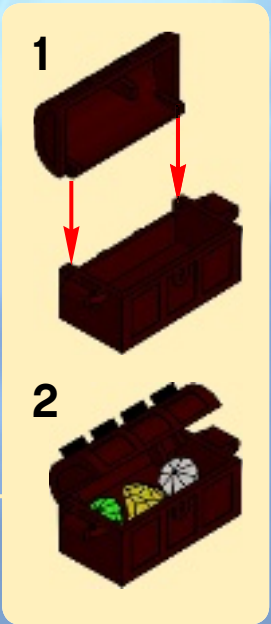
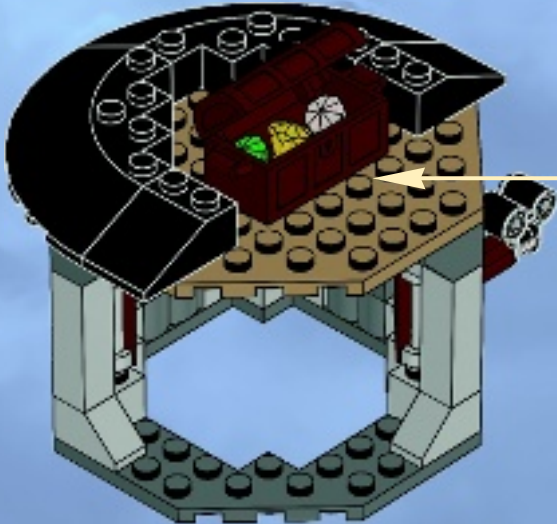

# 16

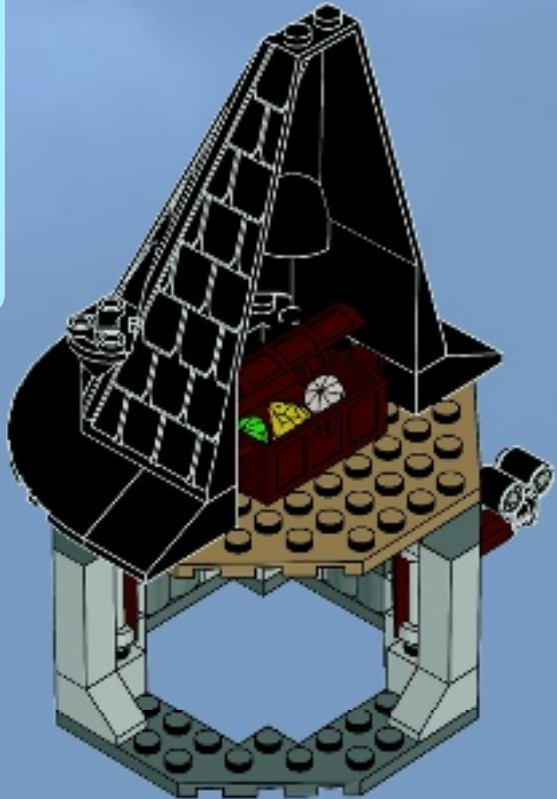

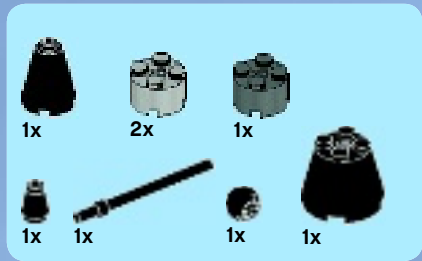

17

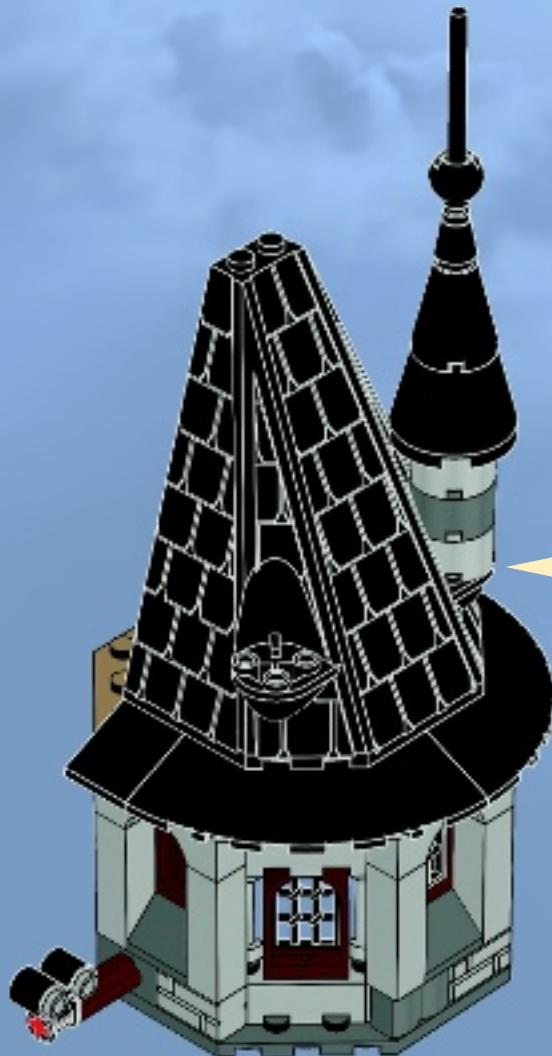
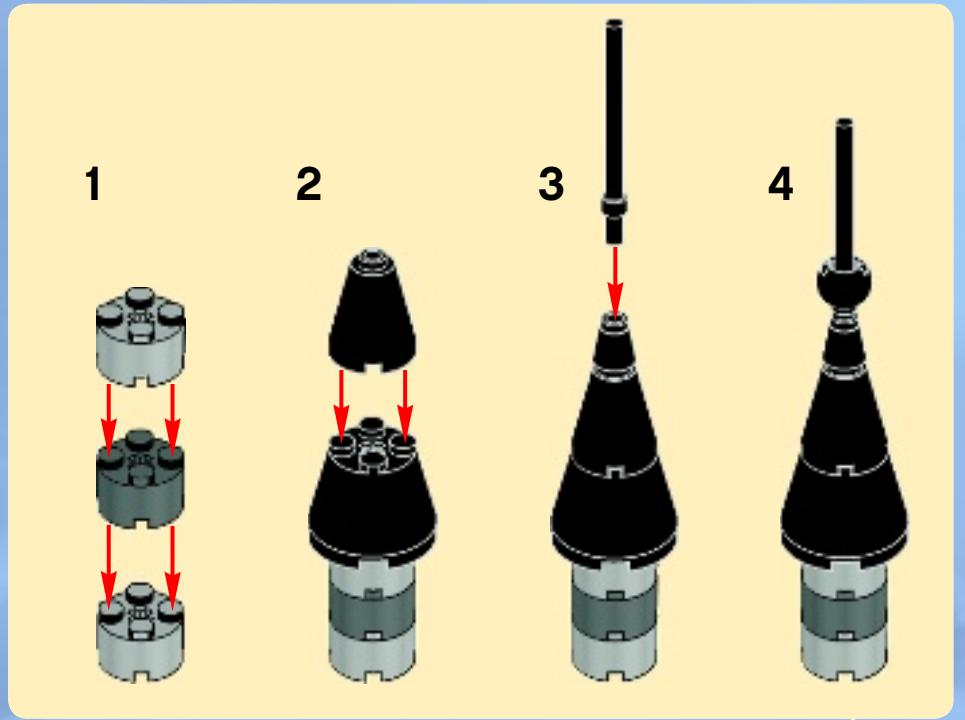



18

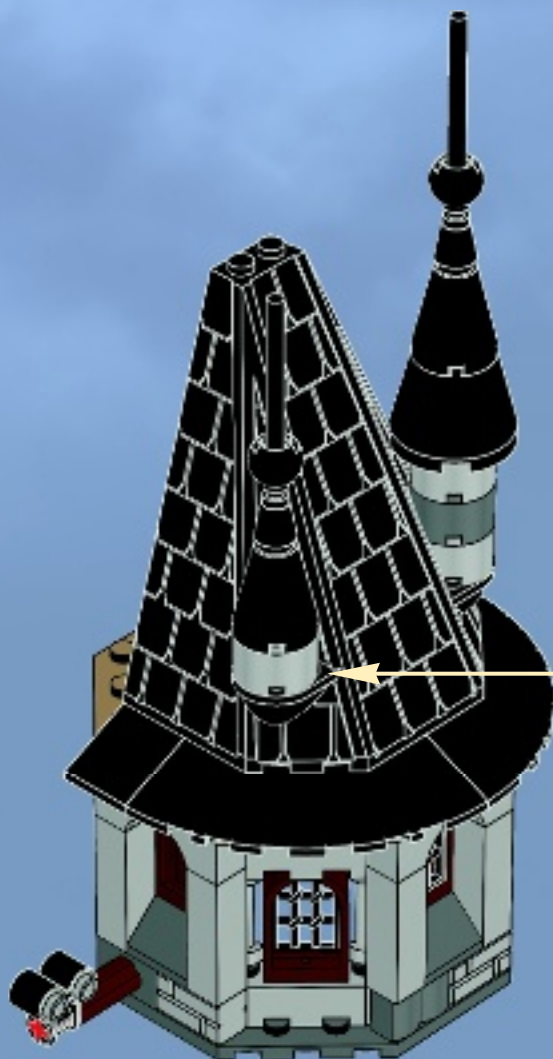
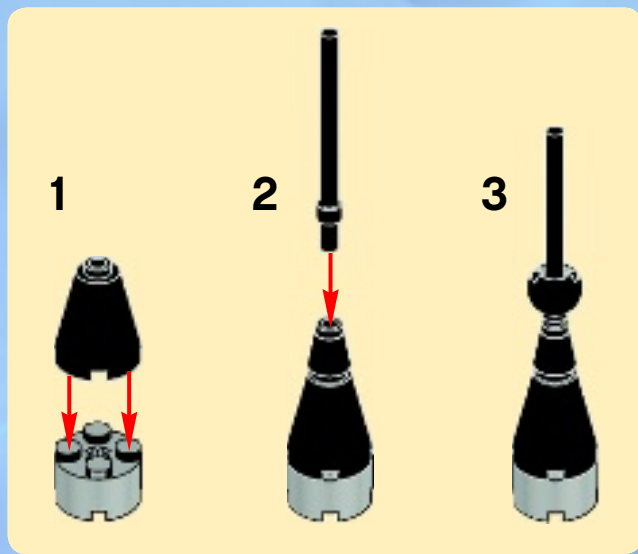



19

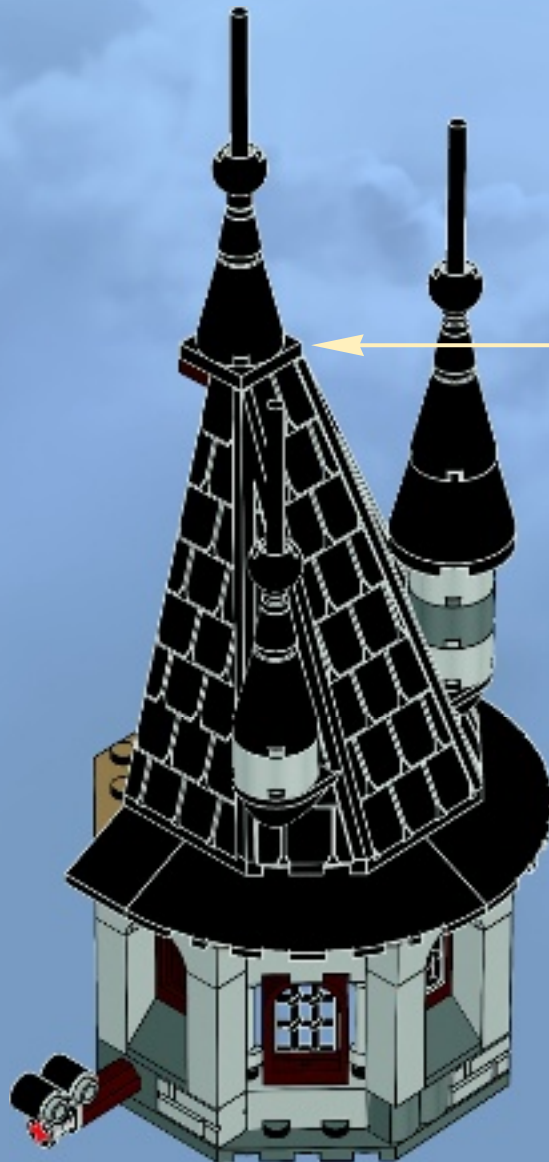
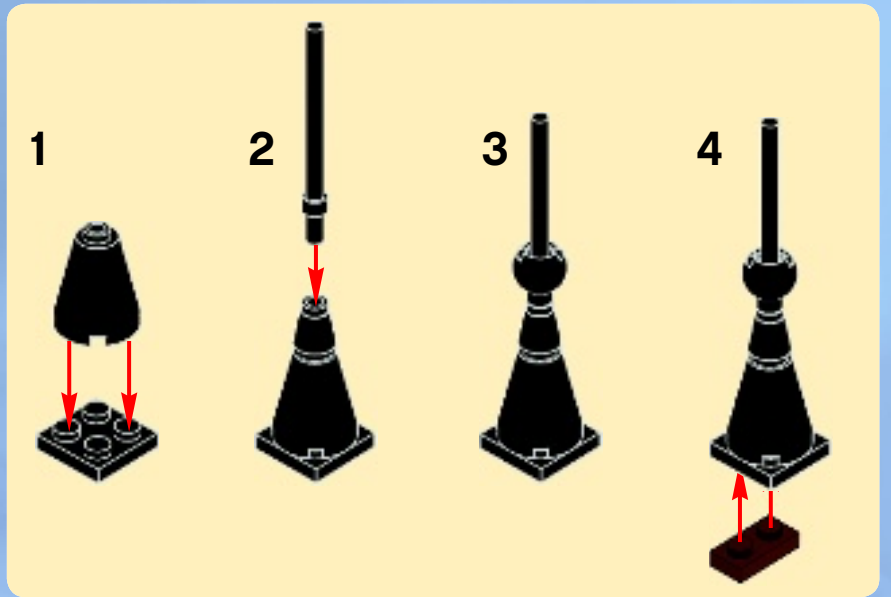



20





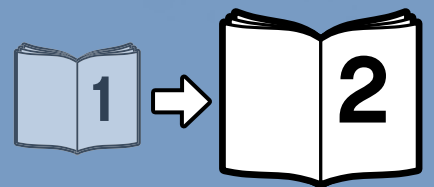



# MONSTER FIGHTERS



LEGO and the LEGO logo are trademarks of the/son des marques de commerce de/son marcas registradas de LEGO Group. ©2012 The LEGO Group.

6029693 / 6029694



www.LEGO.com