



# RACERS

8197



# FOLD OUT RACE TRACK



1.



2.



3.



4.



5.



6.



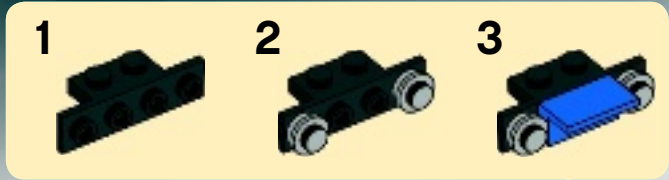

4



5

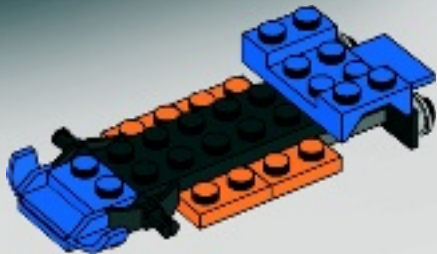

6

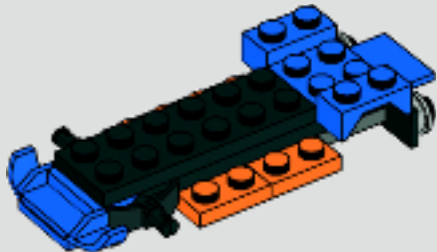

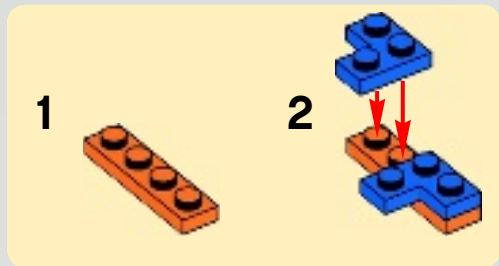

7

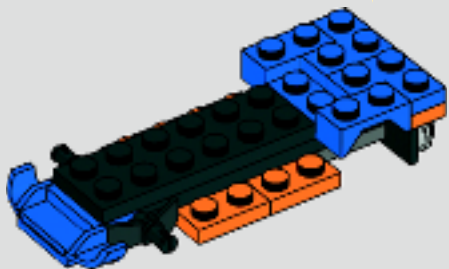

8

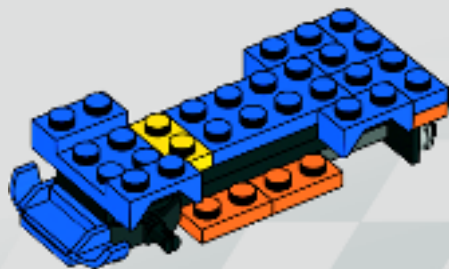

9

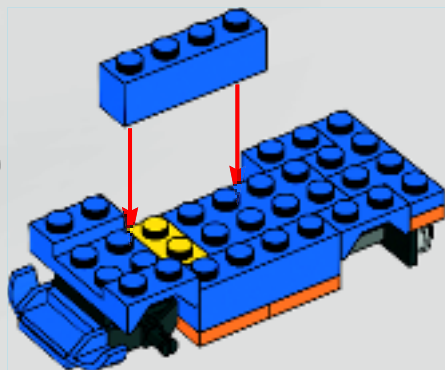

6

1

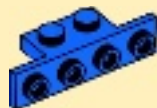

2

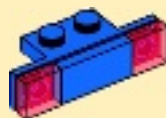

3

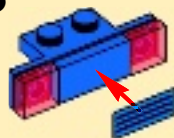

10

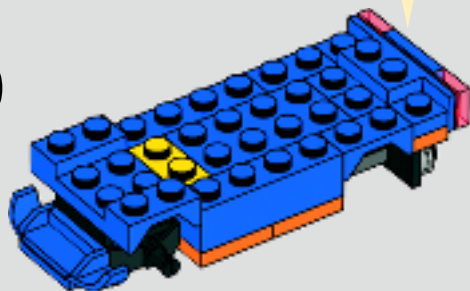

11

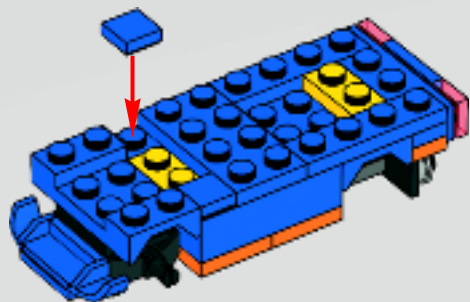

12

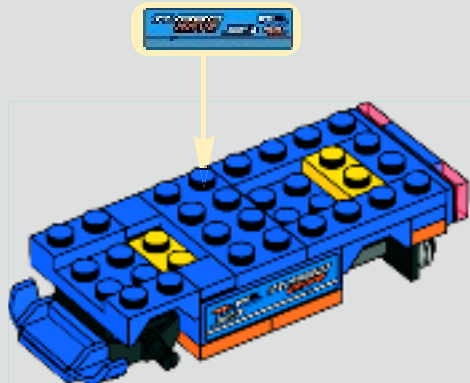

1



2



3

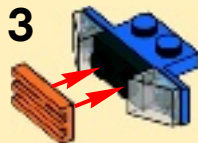

13





14

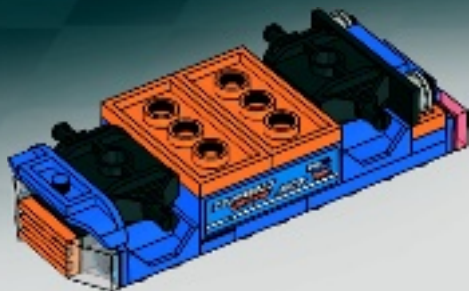

15

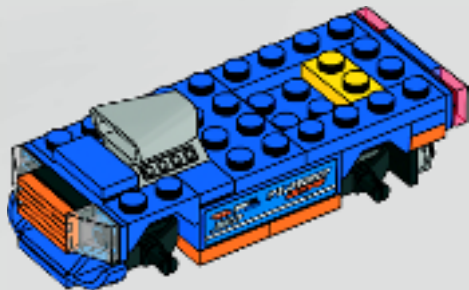

16

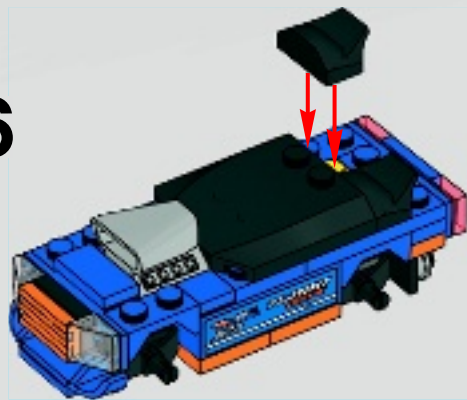



17

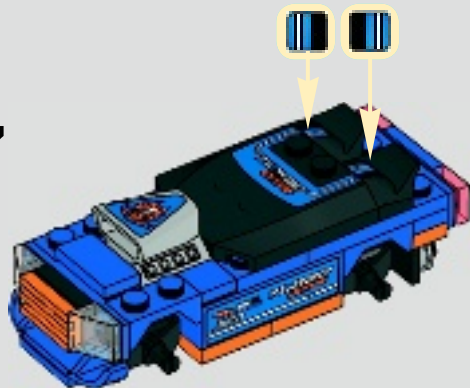

2



18



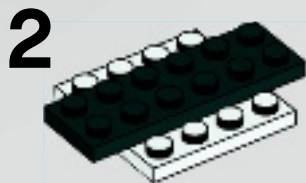

**3**

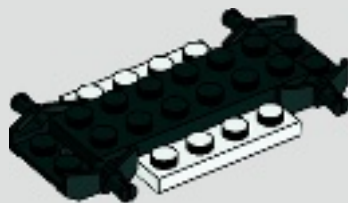

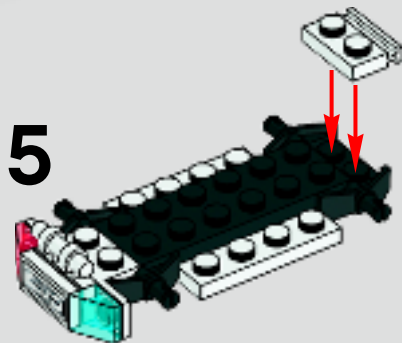
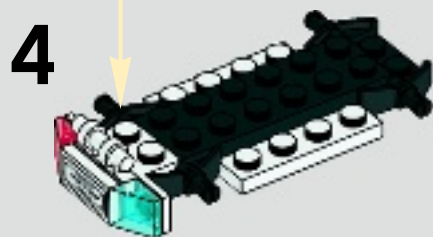
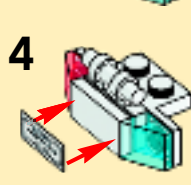
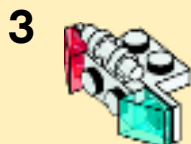
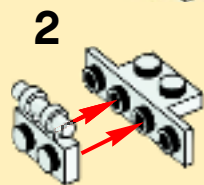

7



8

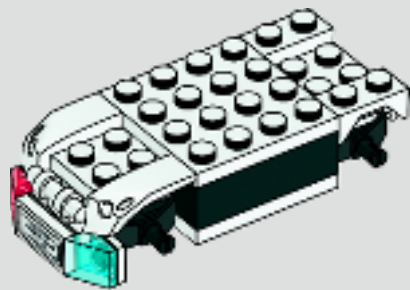

9



10

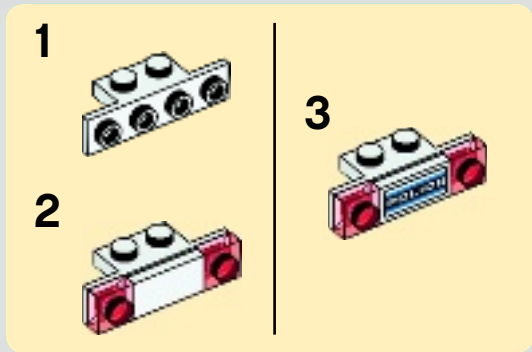

11

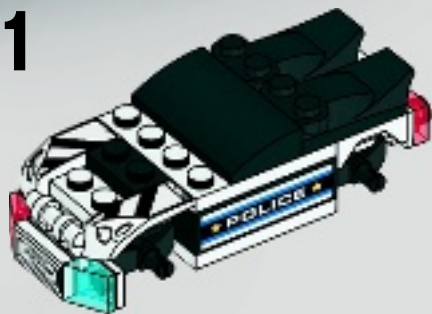

12

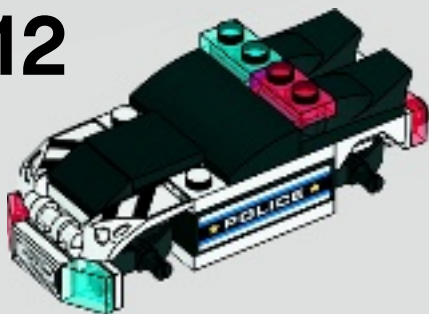



13



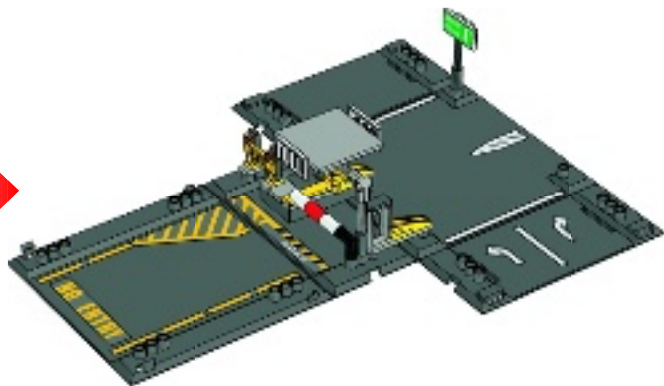



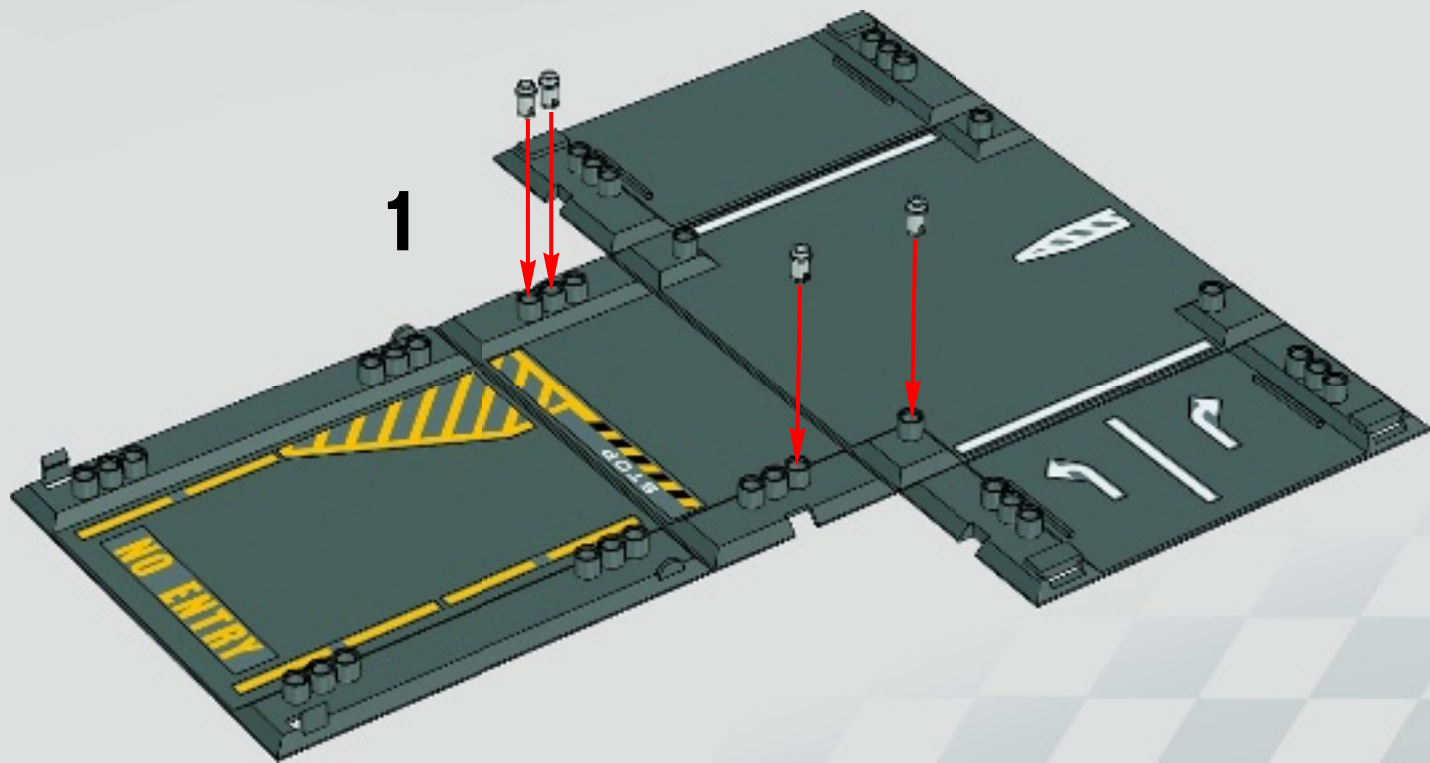

1



2



3



4



5



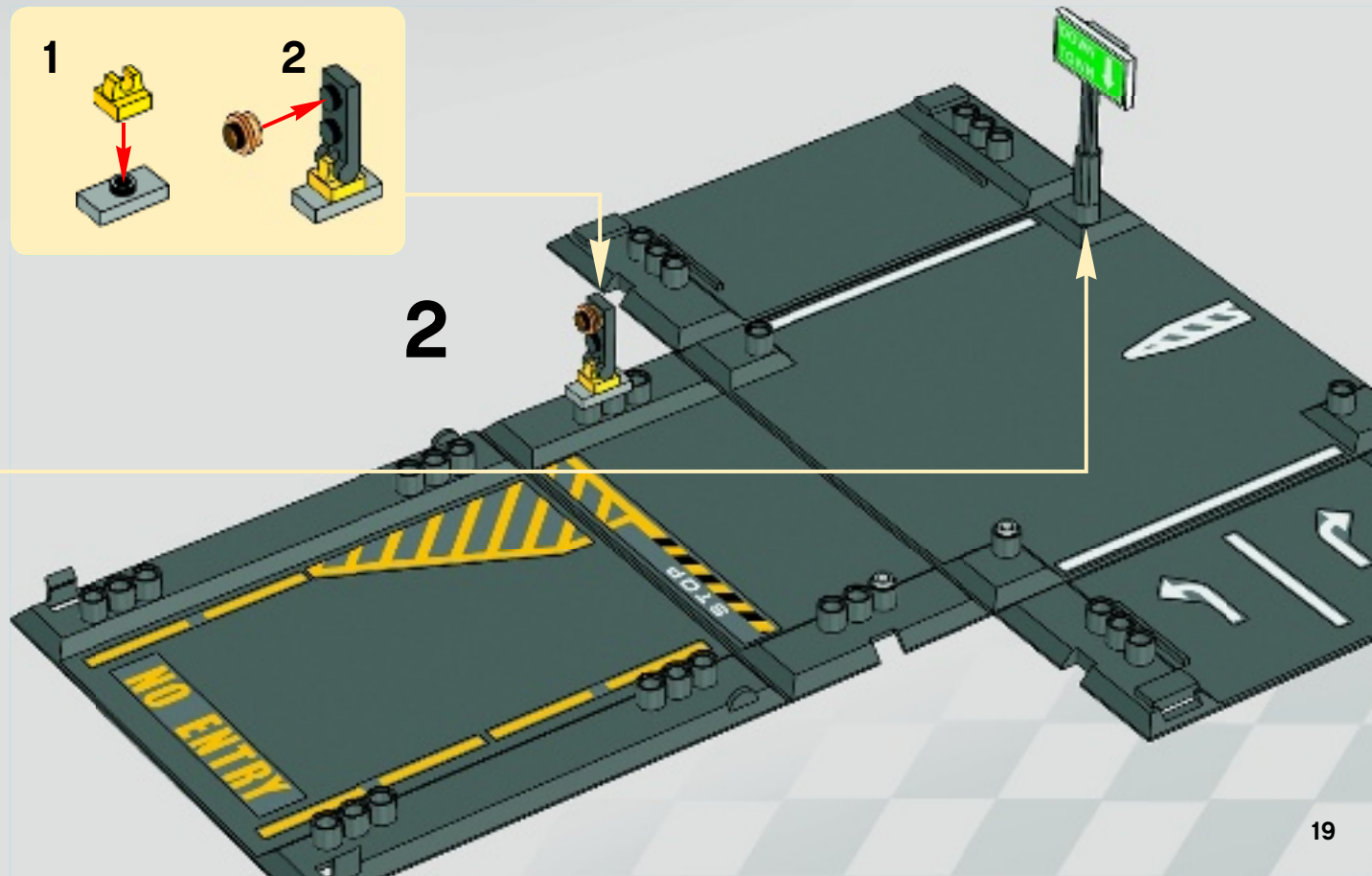
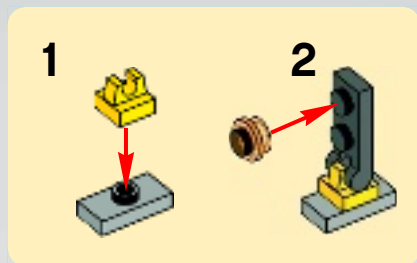

1



2

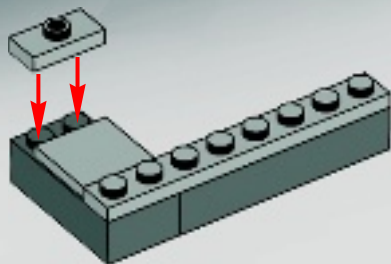

3

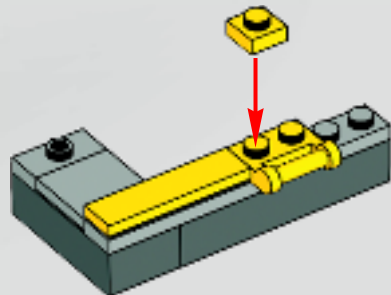

4

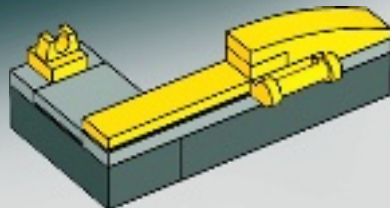

5

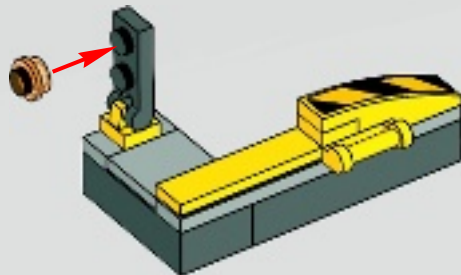

6

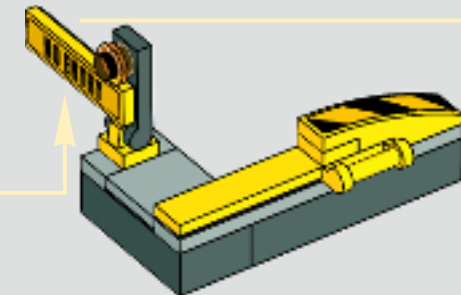
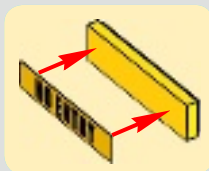

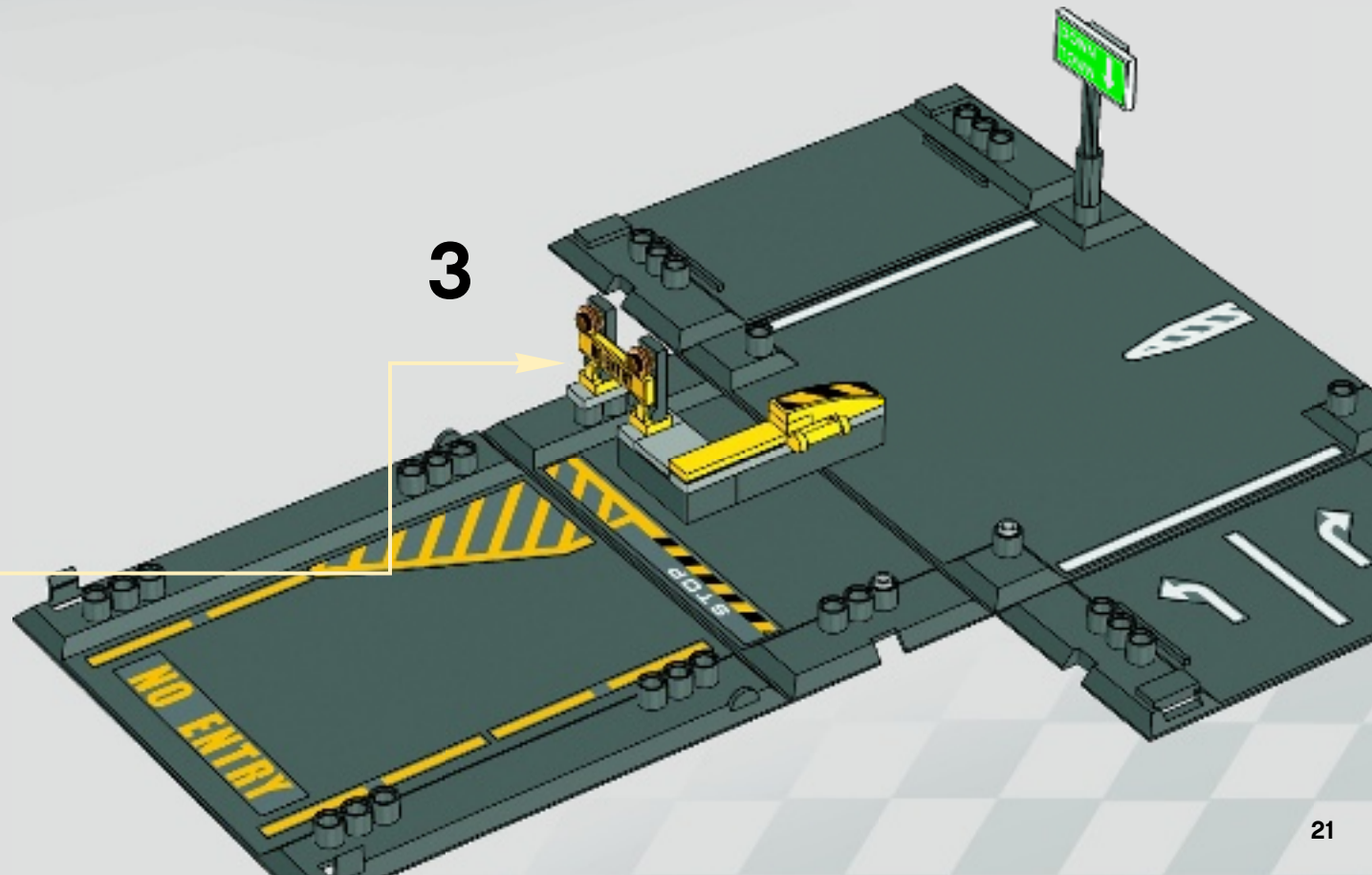

1



2

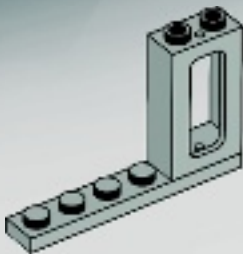

3

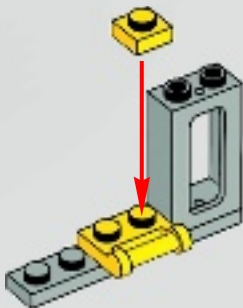

4

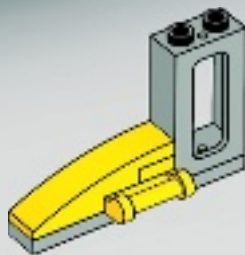

5

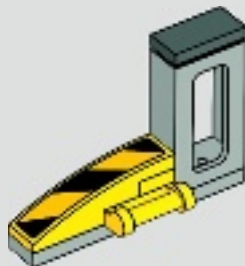

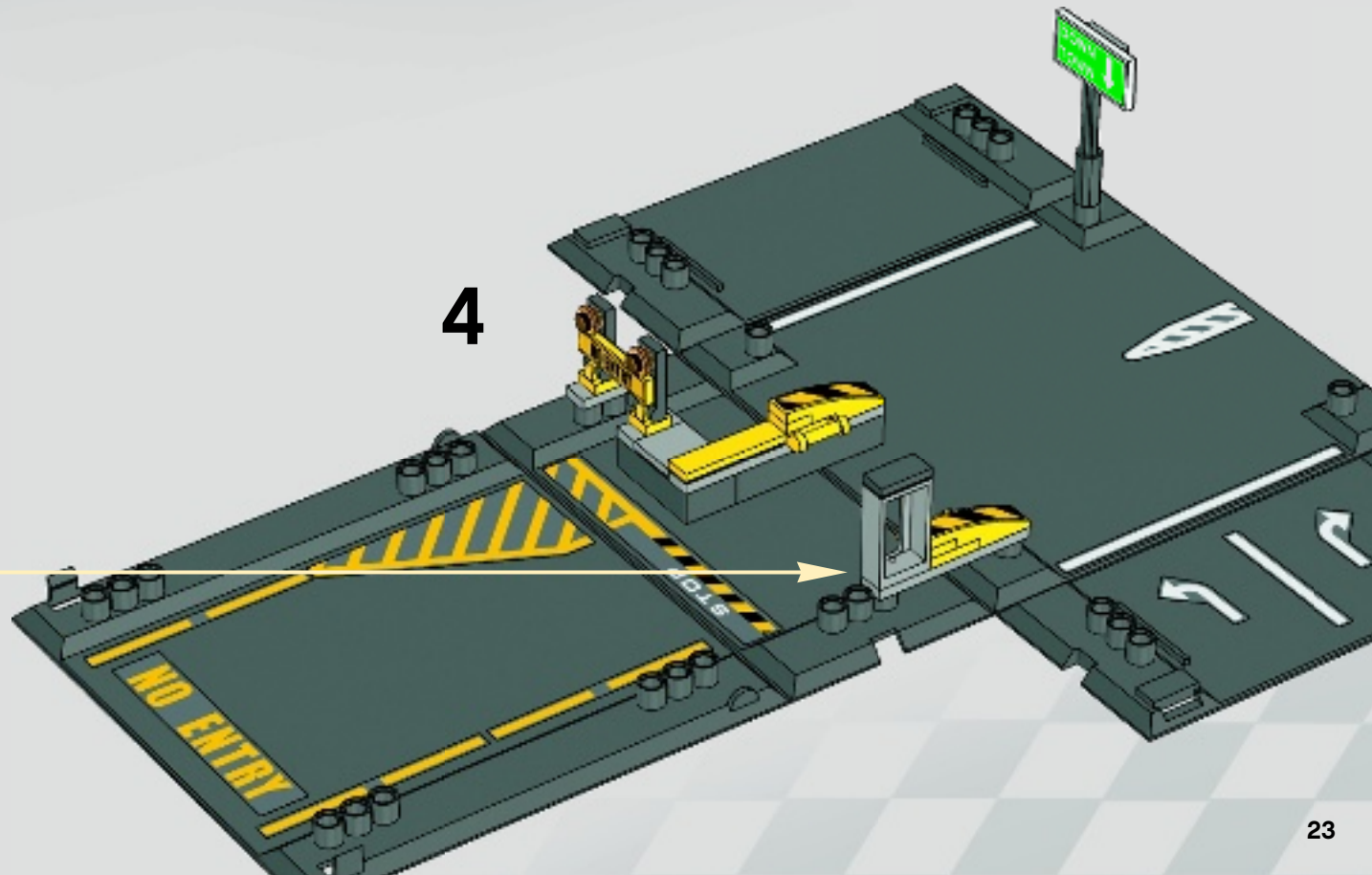



1



2



3

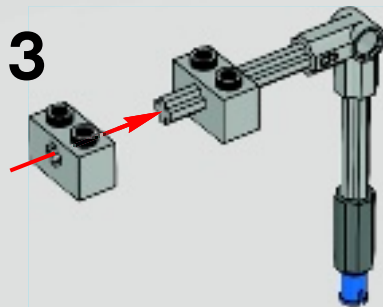



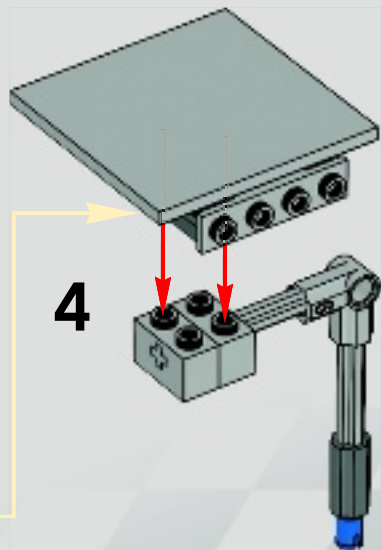
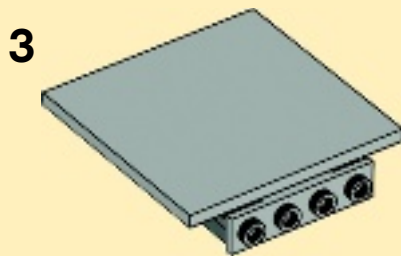
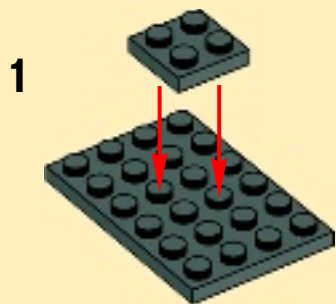

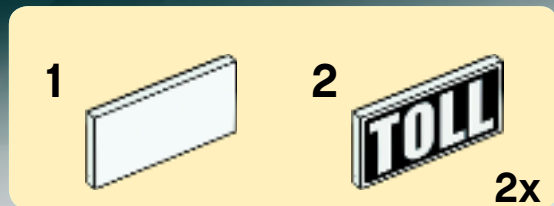

5

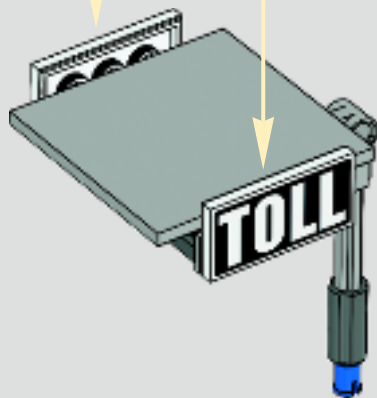

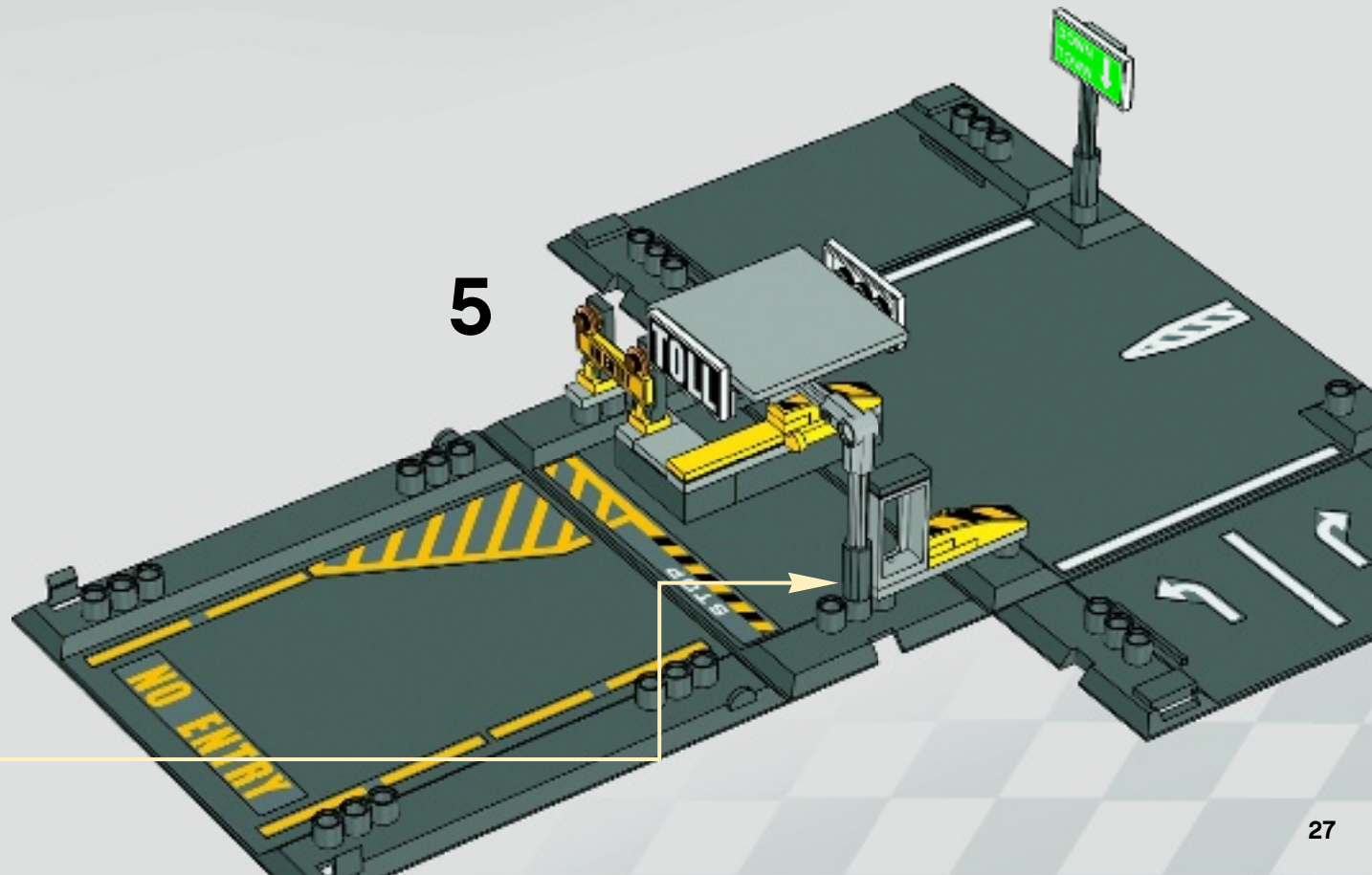

1



2

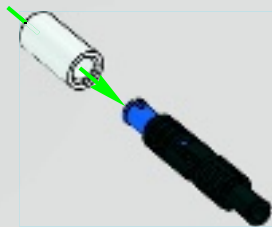

3



4



6

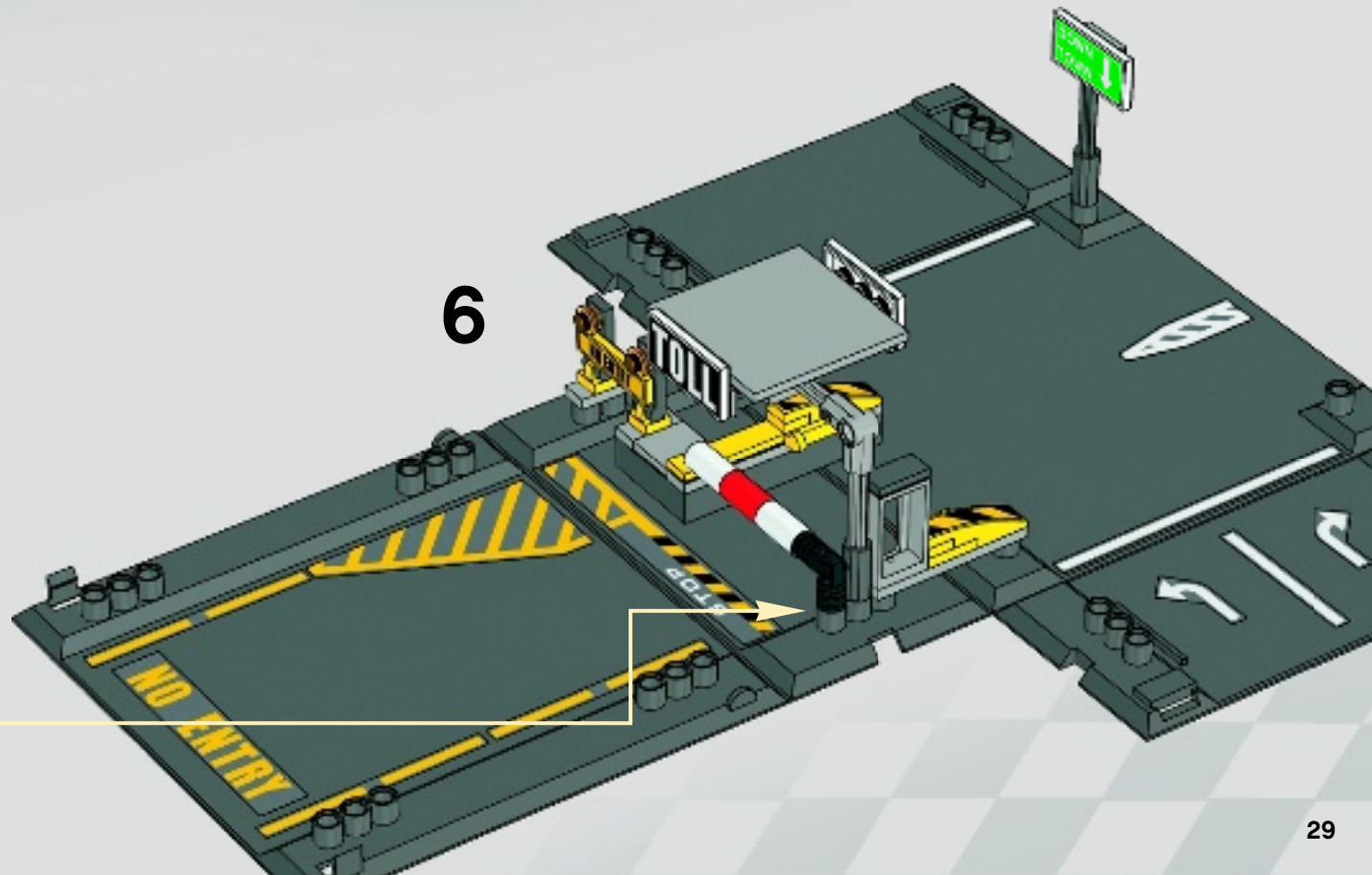

2x  
4522035

2x  
243124

2x  
302424

2x  
4164060

2x  
302324

2x  
4501232

30

1x  
4548119

1x  
4211413

1x  
4211406

1x  
4211425

1x  
4211438

2x  
4211639

4x  
4211483

1x  
4233652

2x  
4282740

2x  
4211451

1x  
4509886

3x  
4233493

1x  
4259422

2x  
4211525

1x  
4526984

2x  
3003941

2x  
3000841

1x  
4201019

1x  
4244363

1x  
4118782

2x  
4158355

1x  
4125254

1x  
4211100

1x  
4211085

1x  
4508553

2x  
4516546

1x  
4211052

2x  
4521187

1x  
4211115

2x  
4211094

2x  
4222960

2x  
4244368

1x  
4260426

1x  
4244366



2x  
4243812



1x  
4140583



3x  
4560178



2x  
4282737



1x  
4297330



1x  
4249563



1x  
4289272



2x  
306901



2x  
4526981



3x  
4206482



2x  
242023



2x  
4206330



2x  
306923



1x  
486523



1x  
4527976



3x  
302023



2x  
4500520



2x  
371023



2x  
4282744



2x  
301023



1x  
4282746



4x  
615726



2x  
301026



1x  
306826



1x  
4548180



1x  
4143372



2x  
4121715



2x  
4218581



2x  
4285883



1x  
4516431



8x  
4248538



3x  
379526



1x  
4191191



1x  
4159335



2x  
302326



8x  
4246901

**Customer Service**

**Kundenservice**

**Service Consommateurs**

**Servicio Al Consumidor**

**www.lego.com/service or dial**



**: 00800 5346 5555**

**: 1-800-422-5346**





# WIN!

Go to [www.nielsen.com/LEGO](http://www.nielsen.com/LEGO)  
to fill out a survey for a chance  
to win a cool LEGO® Product.

No purchase necessary.

Open to all residents where not prohibited.



[www.LEGO.com](http://www.LEGO.com)

## [www.nielsen.com/LEGO](http://www.nielsen.com/LEGO)

### GEWINNE!

Nimm an der Umfrage auf  
[www.nielsen.com/LEGO](http://www.nielsen.com/LEGO)  
teil und hab die Chance ein cooles  
LEGO® Produkt zu gewinnen!

Die Teilnahme am Gewinnspiel führt zu keinerlei  
Kaufverpflichtungen. Teilnahme in allen nicht  
ausgeschlossenen Ländern möglich.

### WIN!

Ga naar [www.nielsen.com/LEGO](http://www.nielsen.com/LEGO),  
vul een enquêteformulier in en  
maak kans op een  
cool LEGO® product.

Geen aankoopverplichting.  
Iedereen mag deelnemen, uitgezonderd  
ingezetenden  
van landen waar een enquêteverbod geldt.

### GAGNE!

Visite [www.nielsen.com/LEGO](http://www.nielsen.com/LEGO)  
pour répondre à un questionnaire  
et avoir une chance de gagner  
un produit LEGO® très cool!

Aucune obligation d'achat.  
Ouvert à tous les résidents des pays  
autorisés.

### 当てよう!

[www.nielsen.com/LEGO](http://www.nielsen.com/LEGO)  
にアクセスして、  
アンケートにご記入ください。  
当選者にはレゴ®製品を  
差し上げます。

お買い上げの必要はありません。  
禁止されていない限り、すべての皆様にご利用いただけます。