

LEGO

POWER MINERS

8188



WARNING: CHOKING HAZARD.
Toy contains small parts and a small ball.
Not for children under 3 years.



1

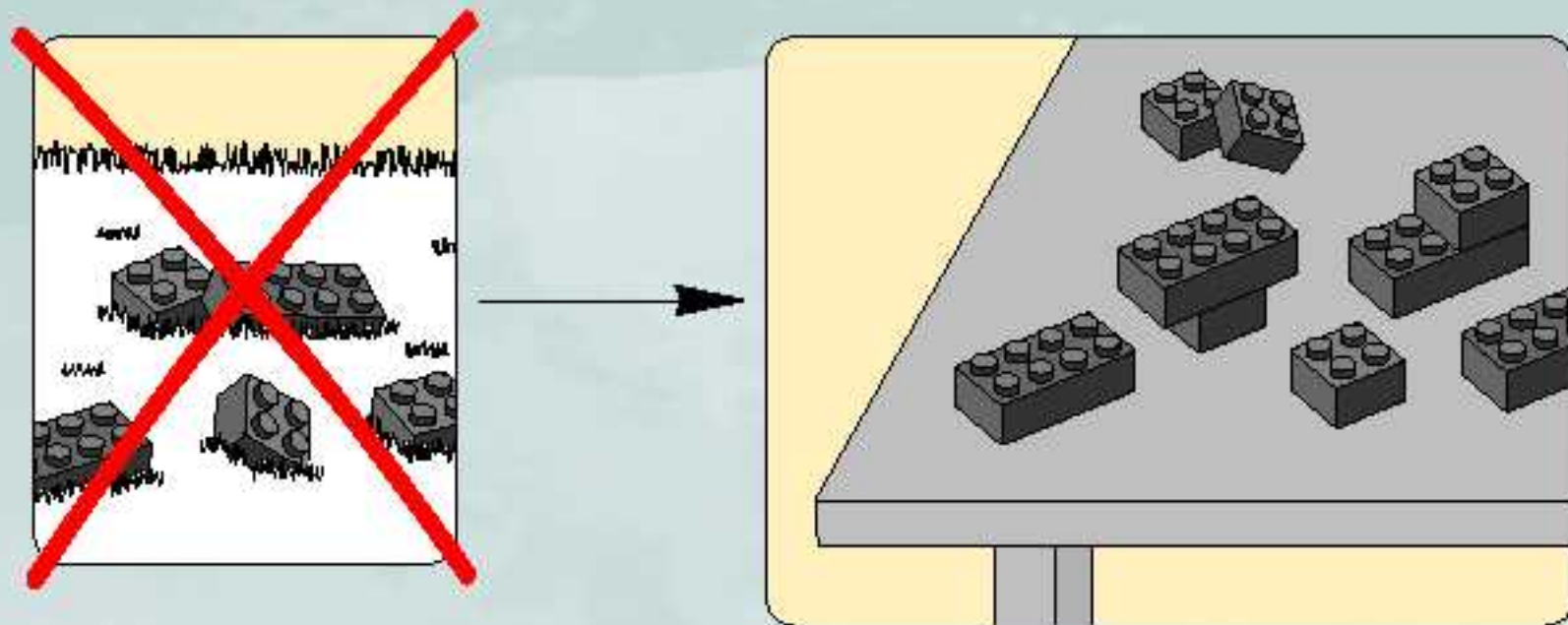

2

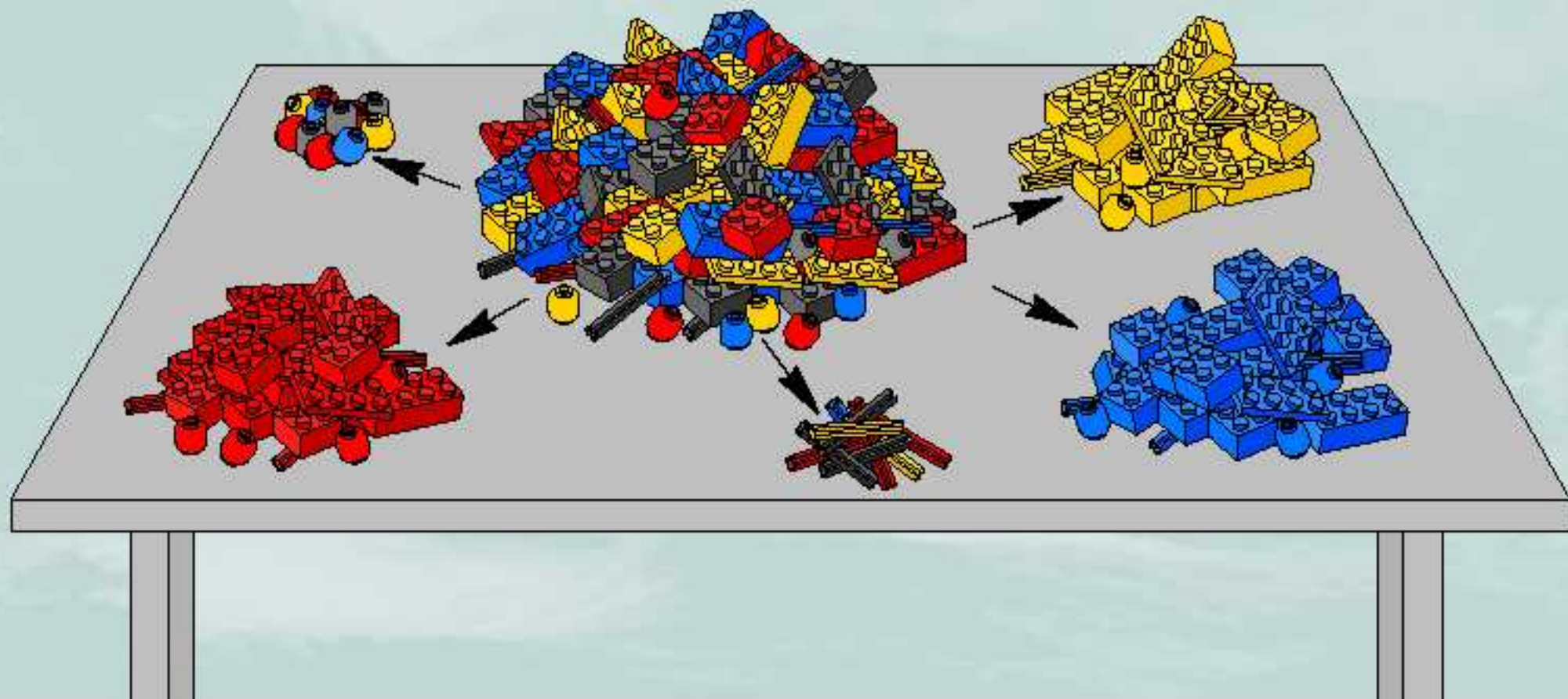

2

3

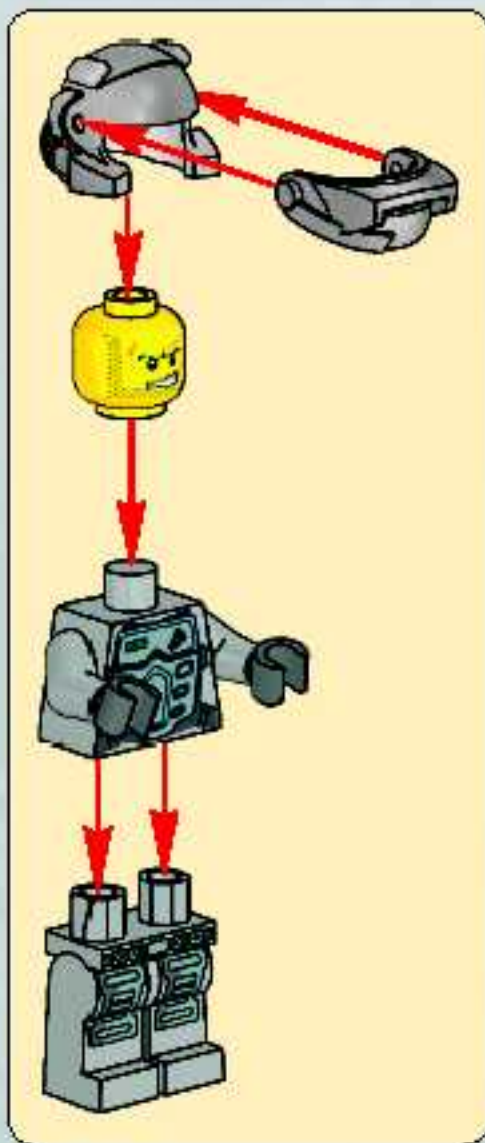

AVERTISSEMENT : RISQUE D'ÉTOUFFEMENT.
Le jouet contient des petites pièces ainsi qu'une petite boule.
Il ne convient pas aux enfants de moins de 3 ans.



ADVERTENCIA: PELIGRO DE ASFIXIA.
Juguete que contiene partes pequeñas y una pelota pequeña.
No recomendado para niños menores de 3 años.

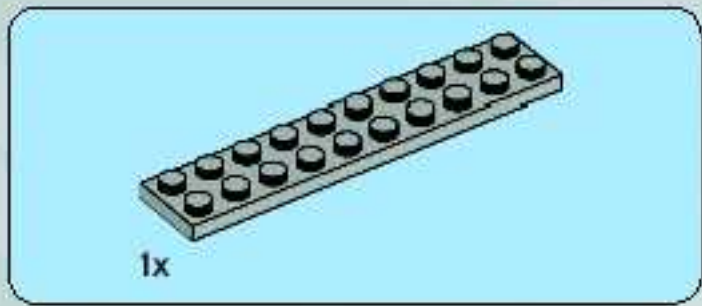

1

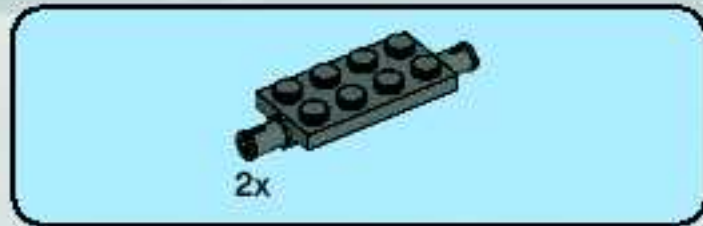
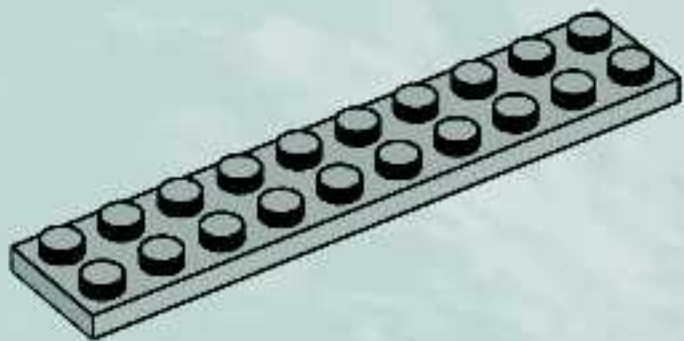

2

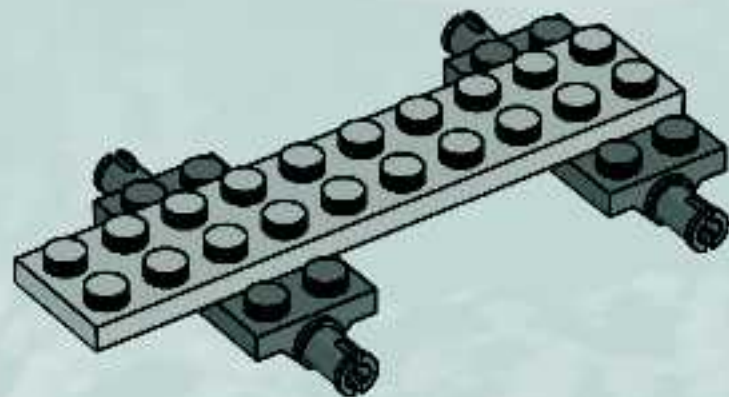



3

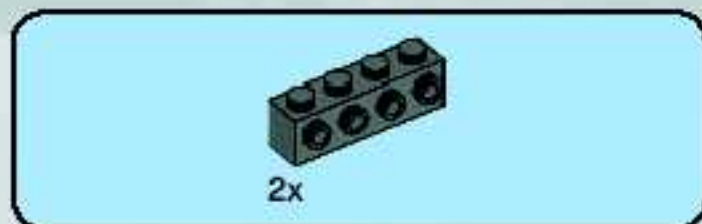
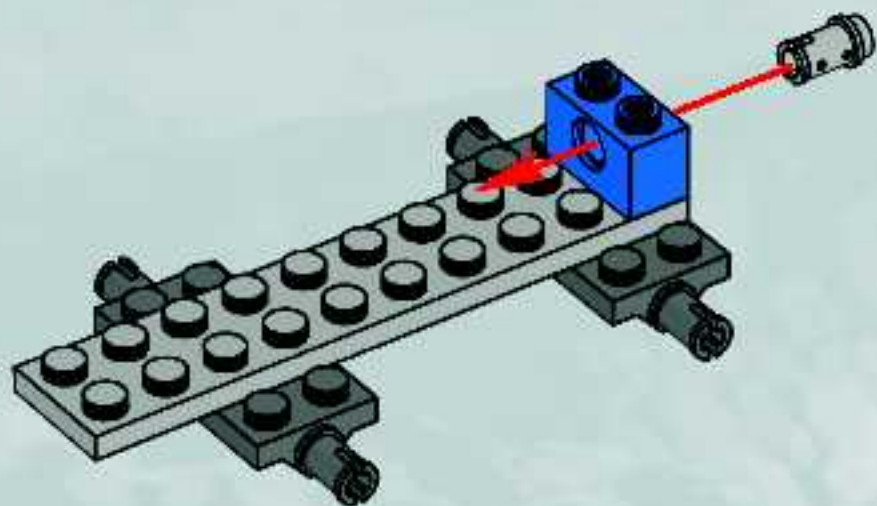

4

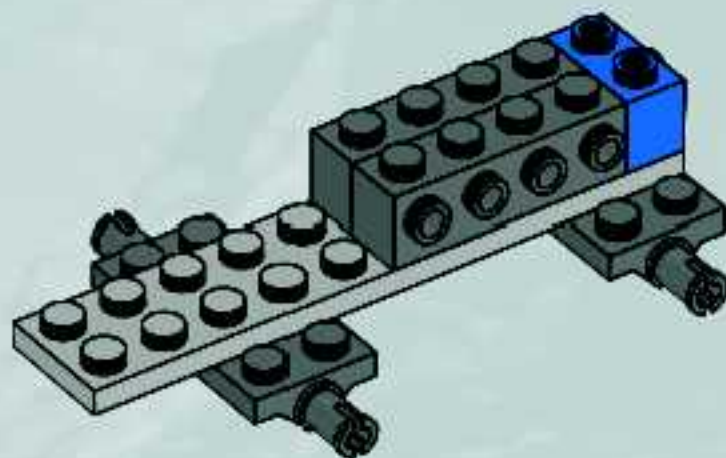

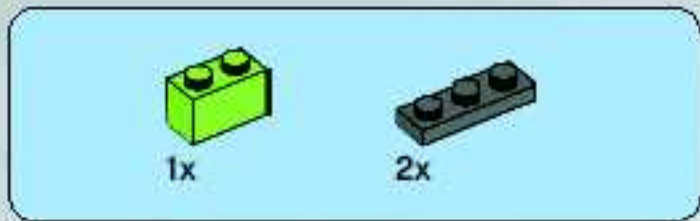

5

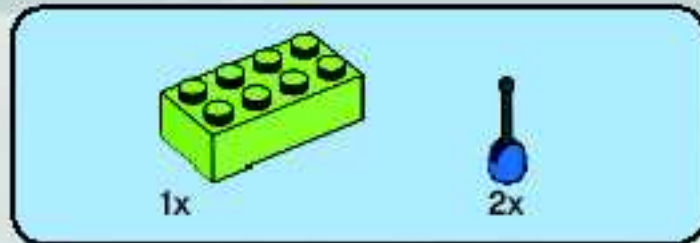
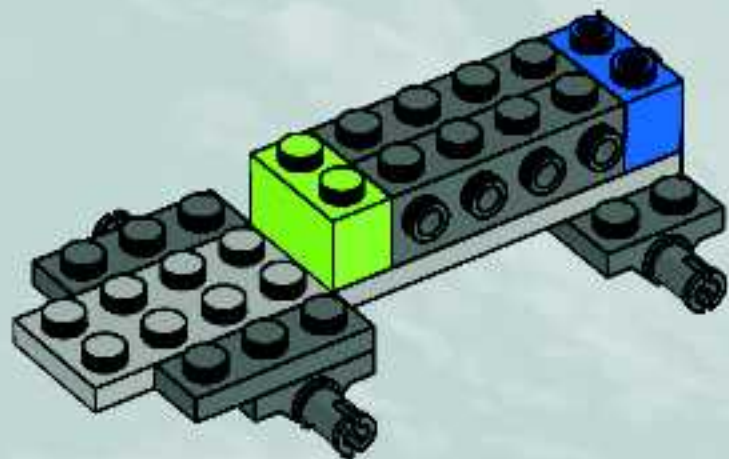

6

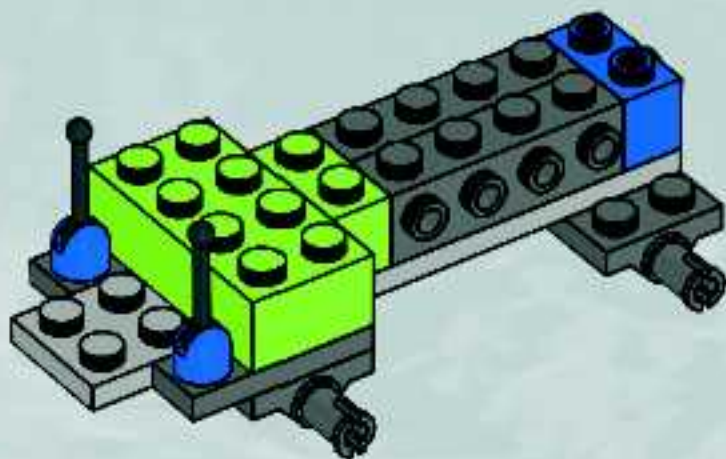



7

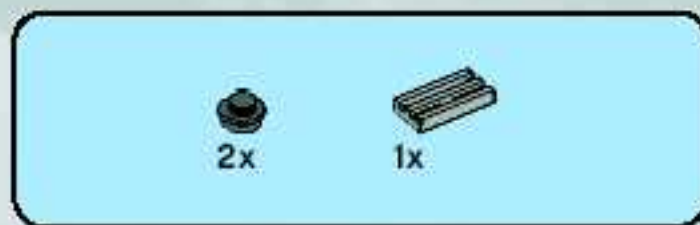
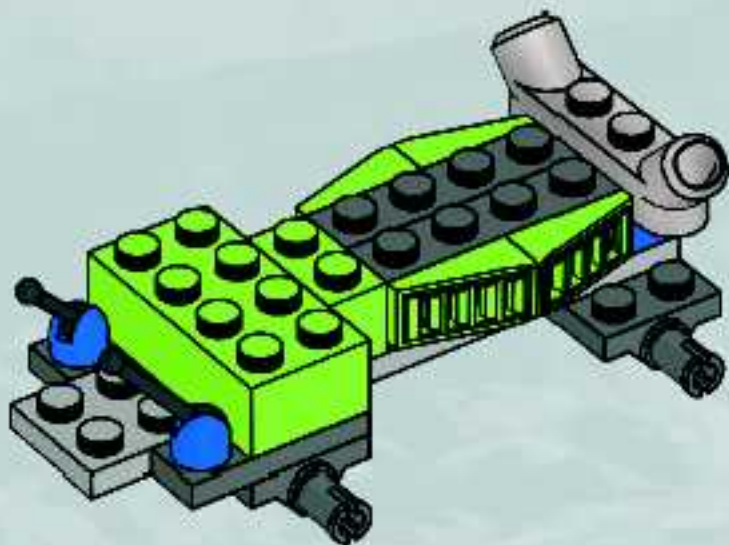

8

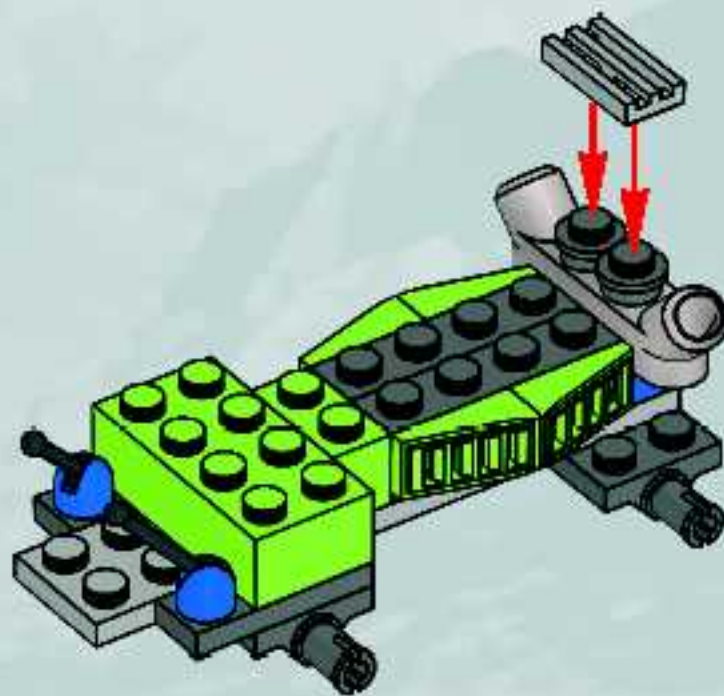



9

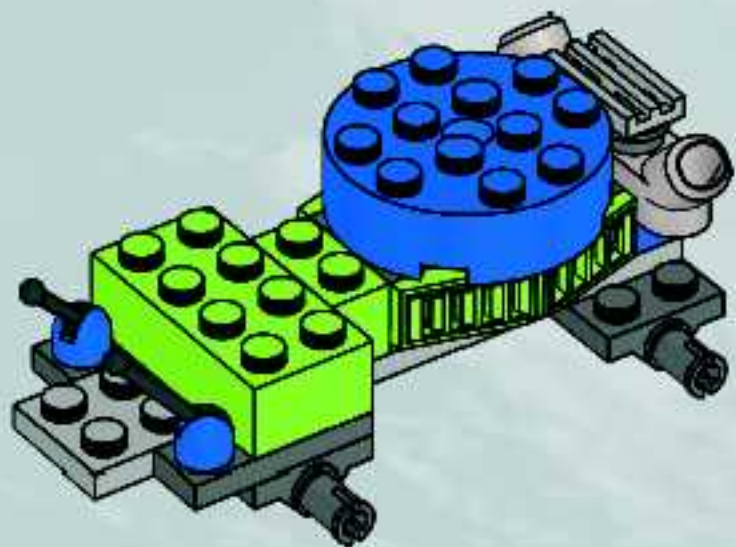

10

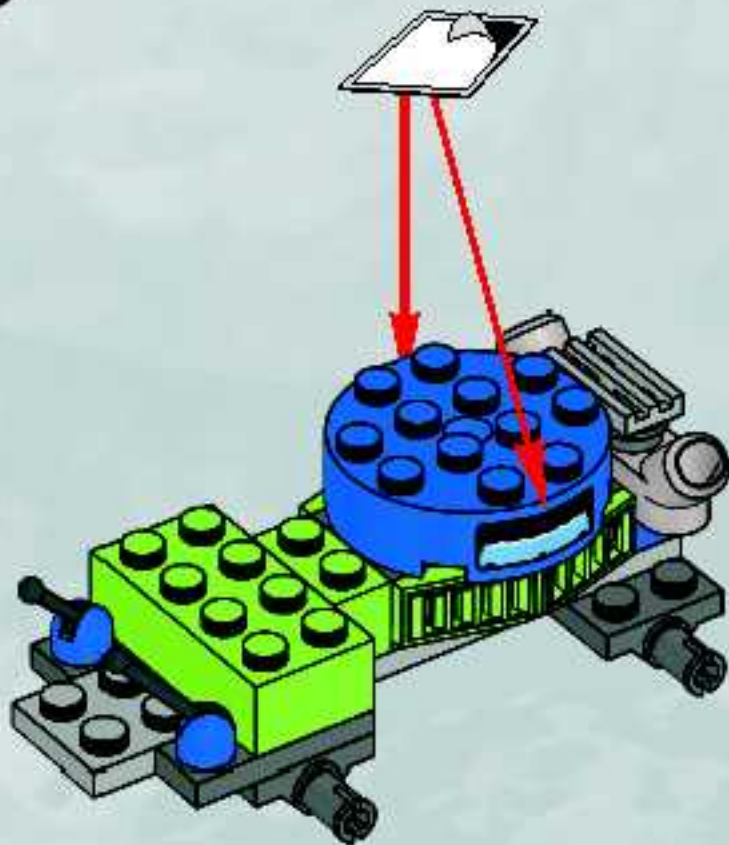

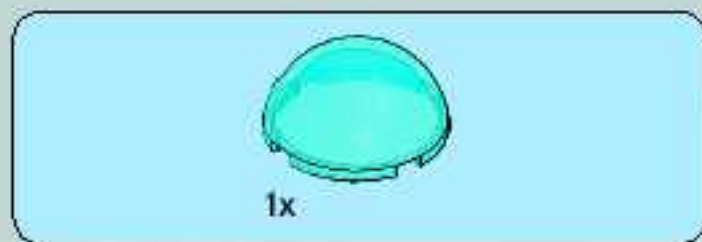

11

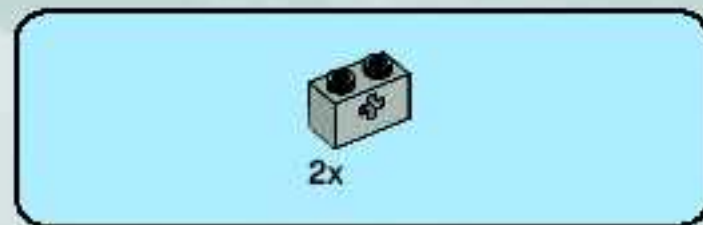
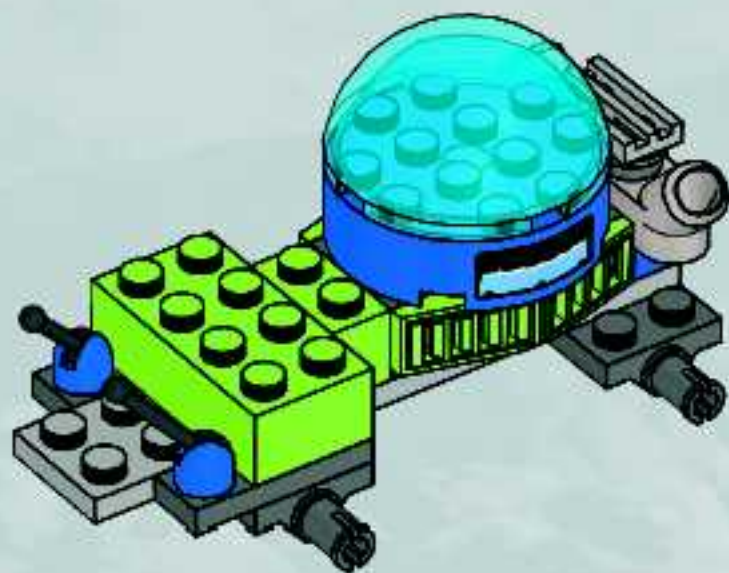

12

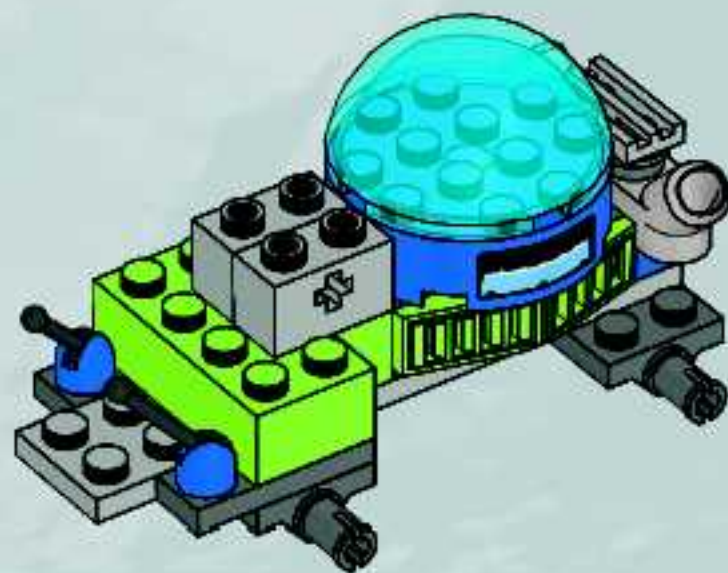

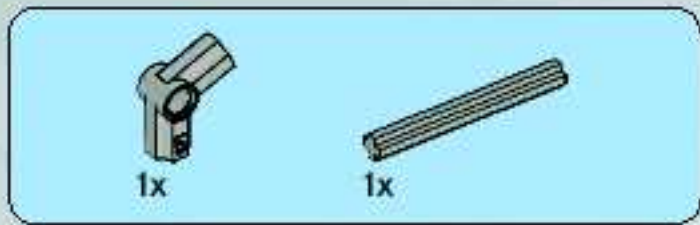

13

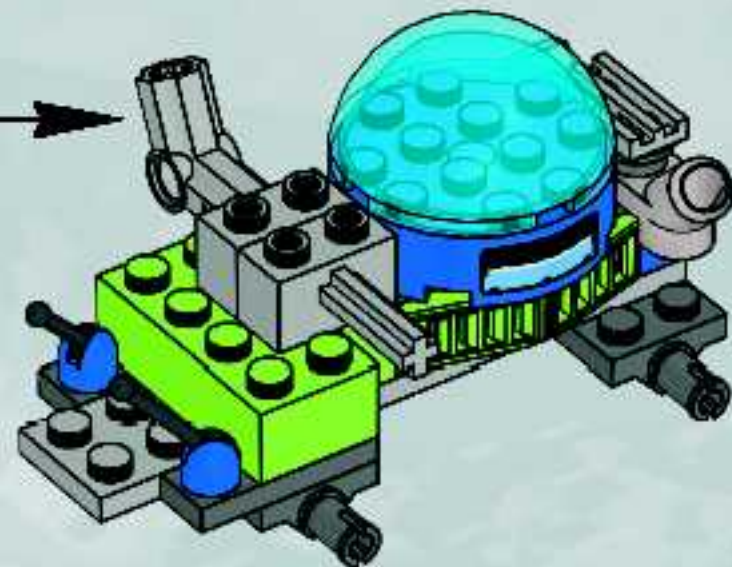
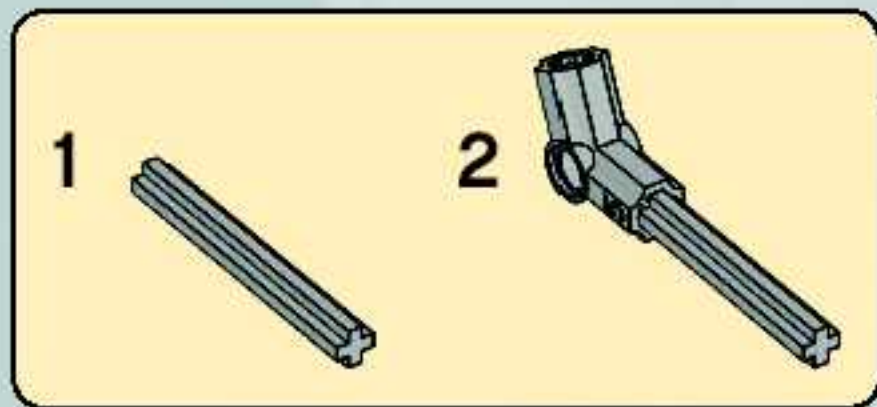



1x

14

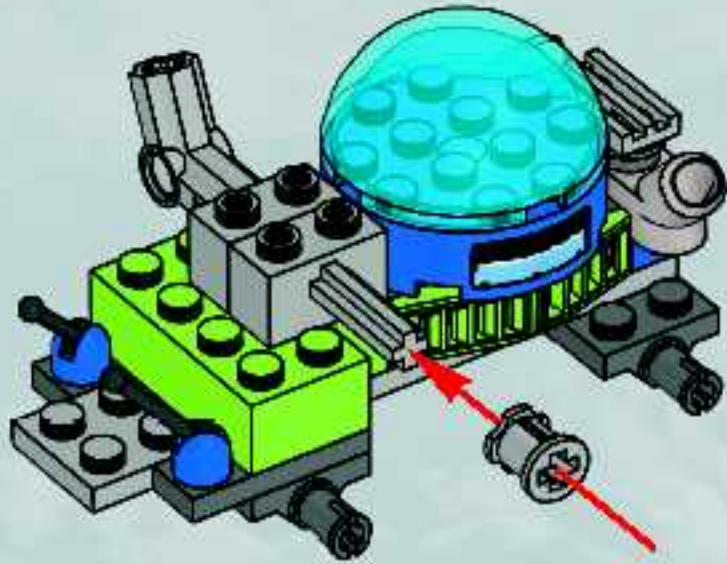

1x

15

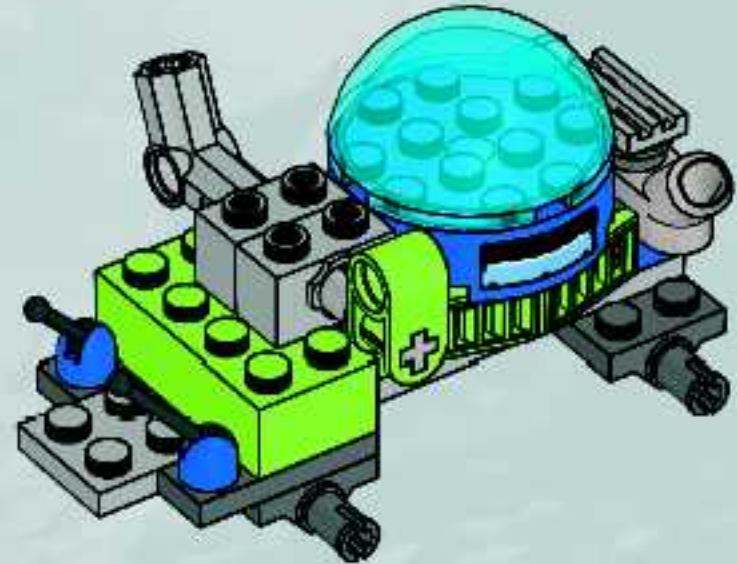

16

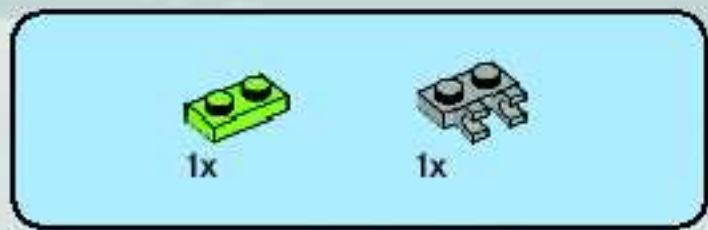
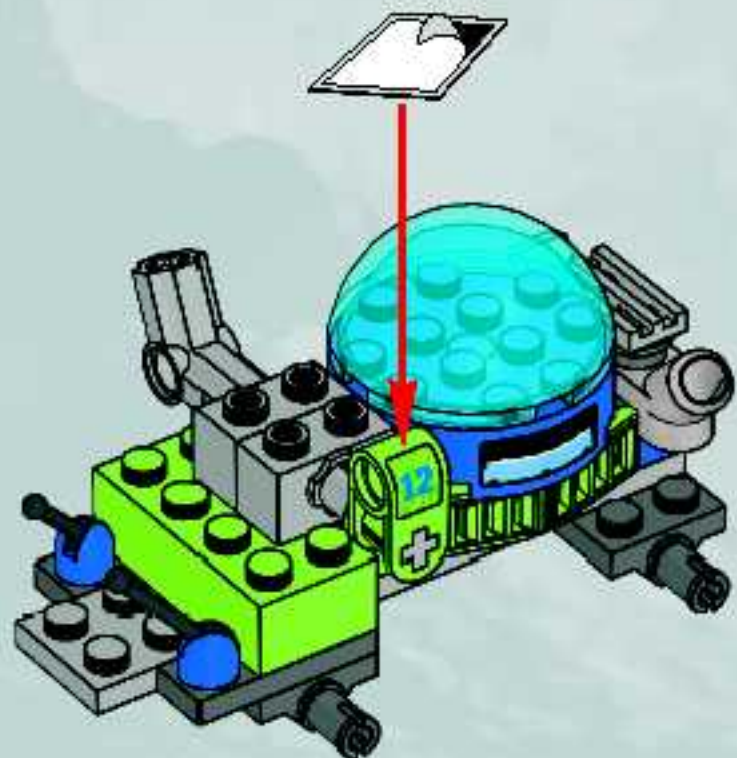

17

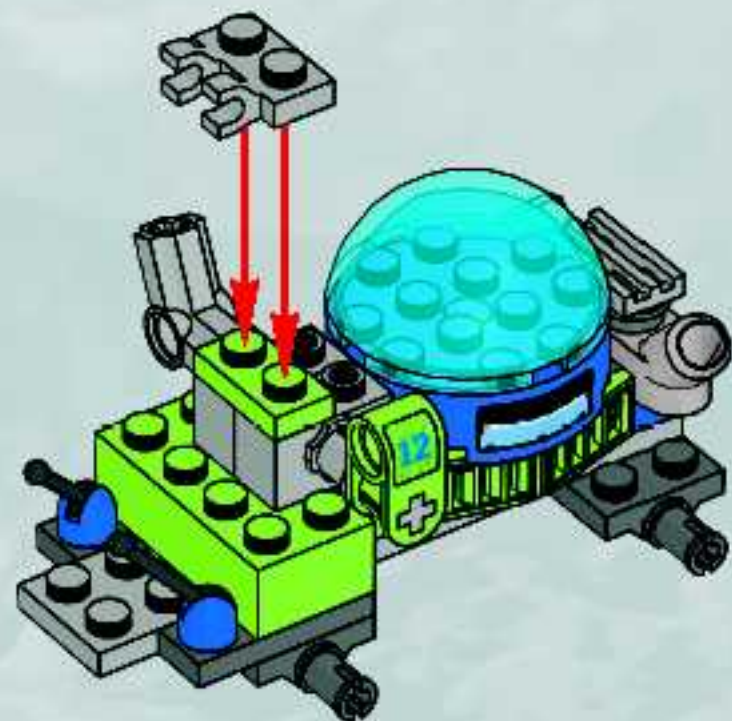



18

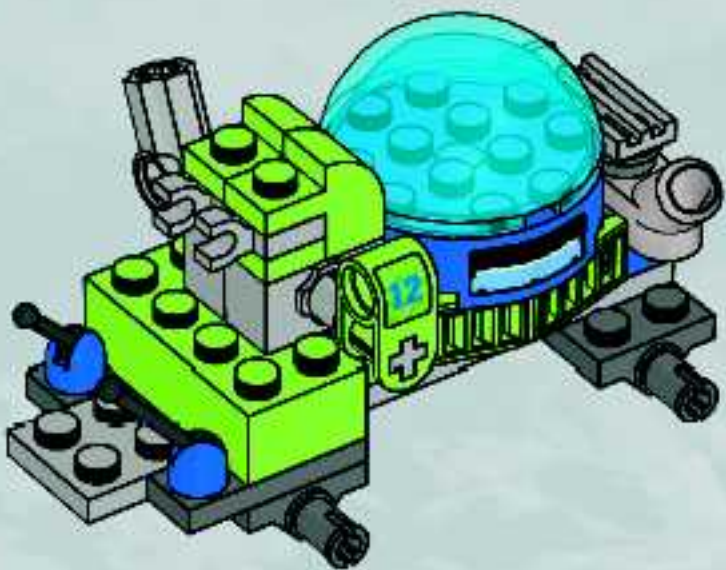

19



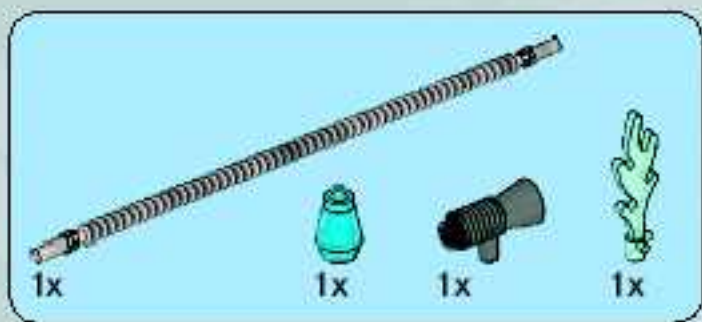

20

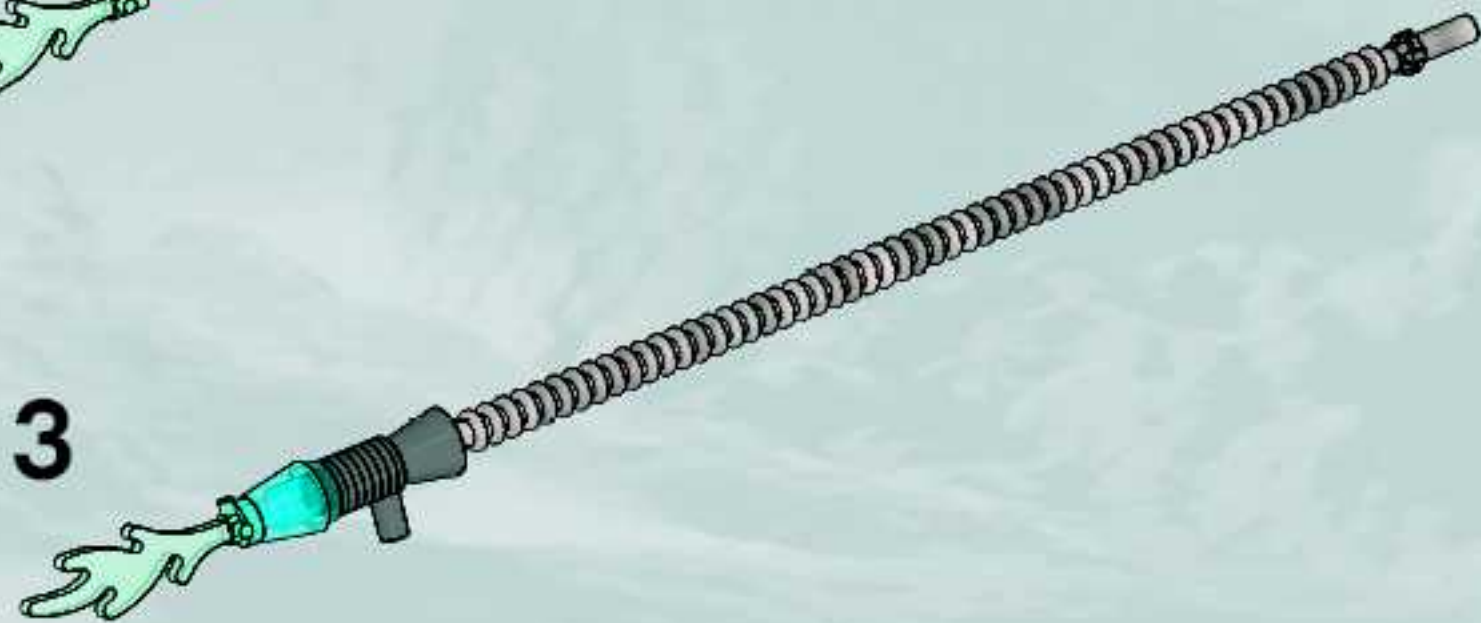
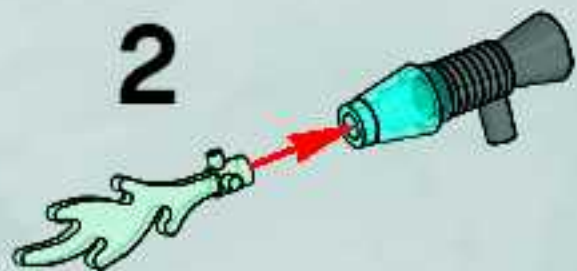

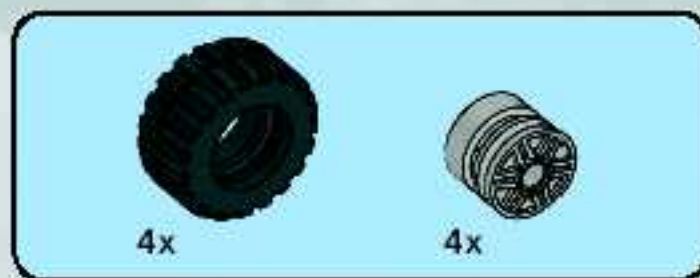
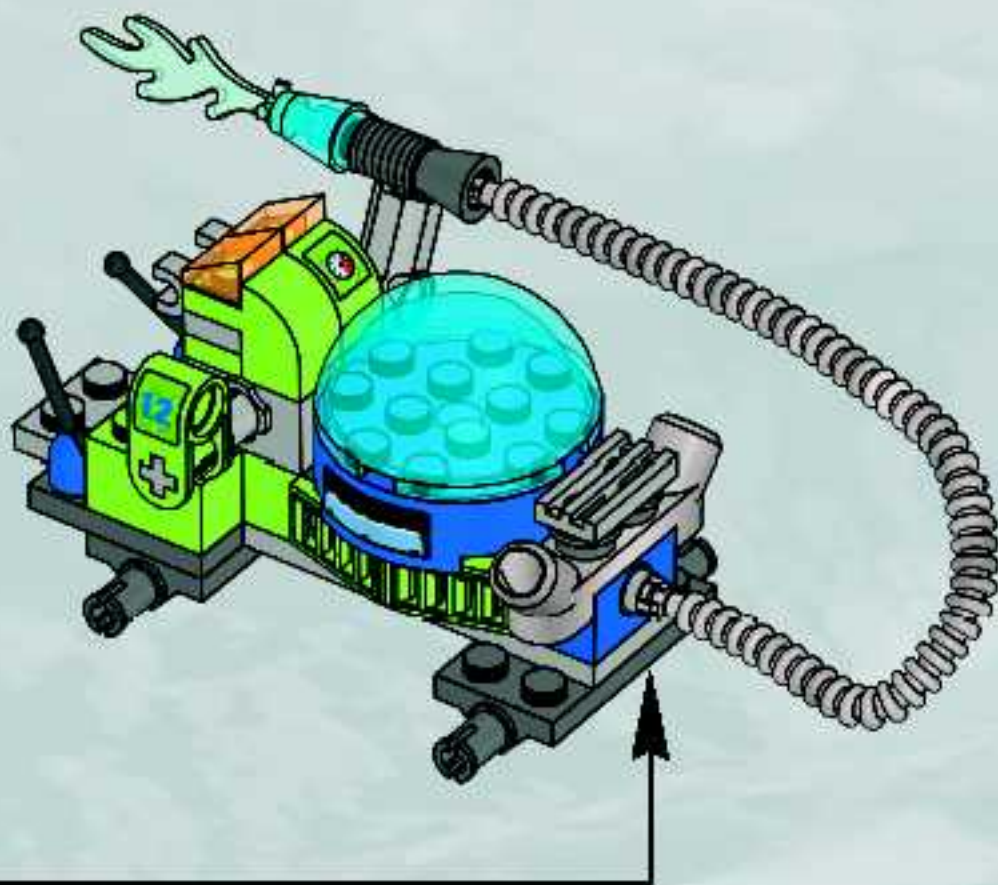

21

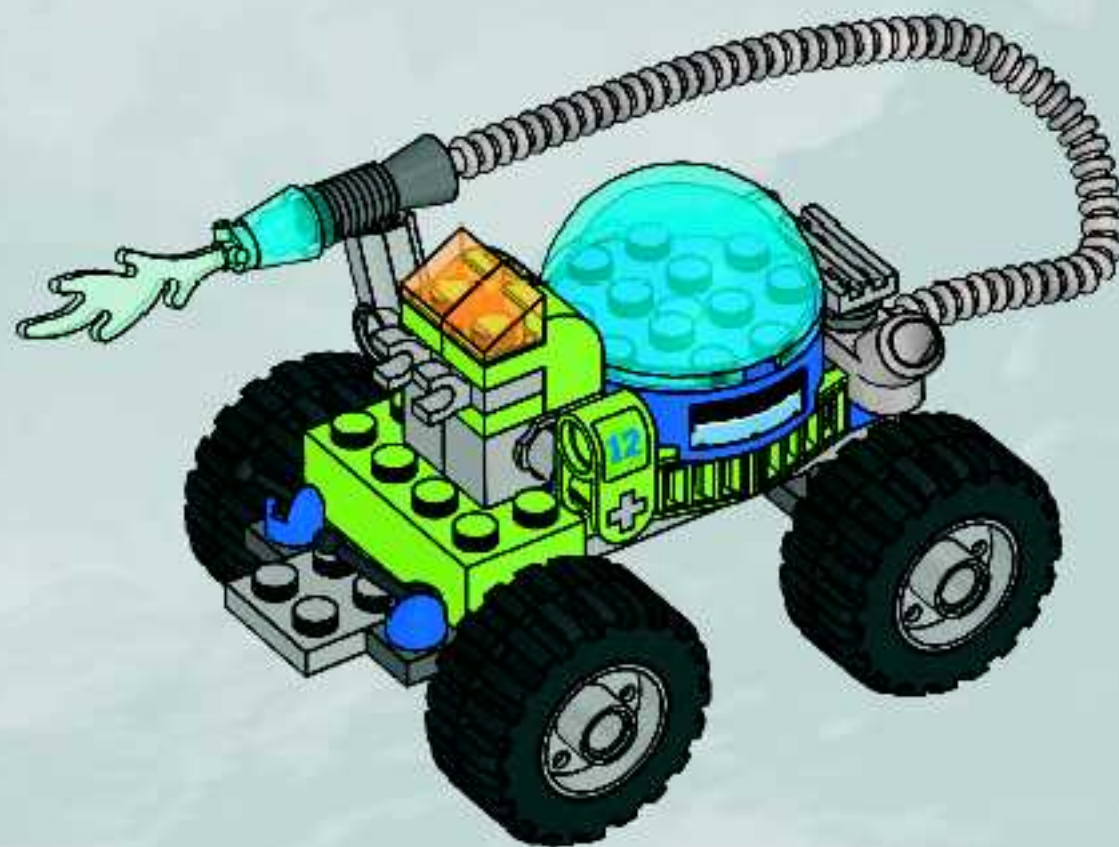

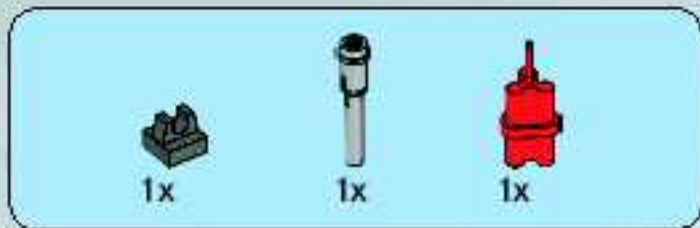

22

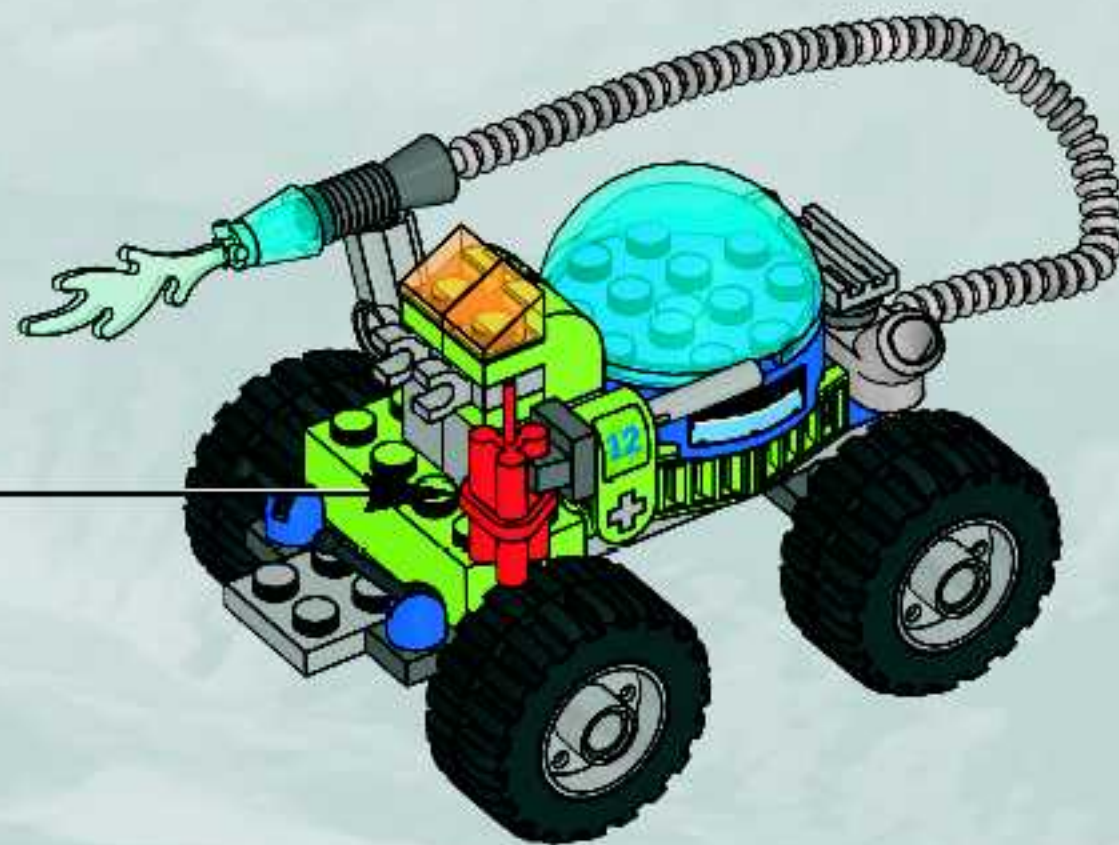
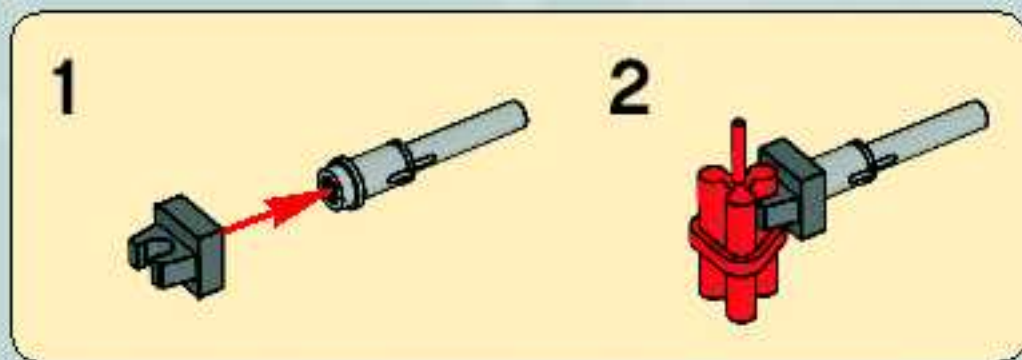



1



2





3

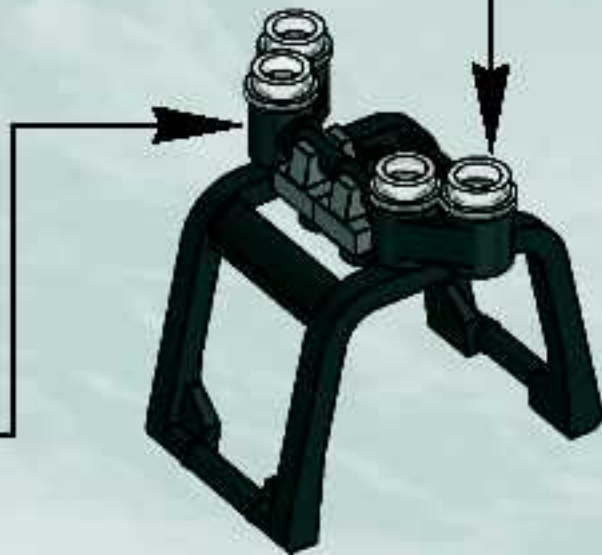
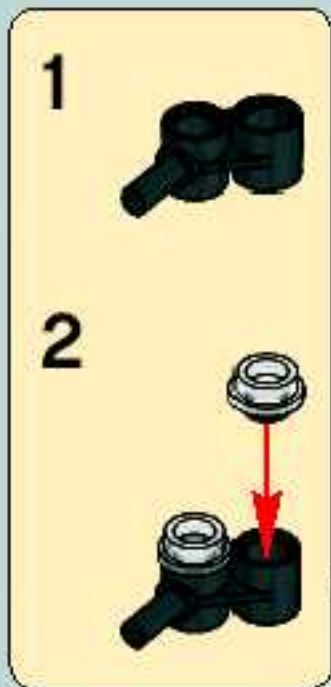
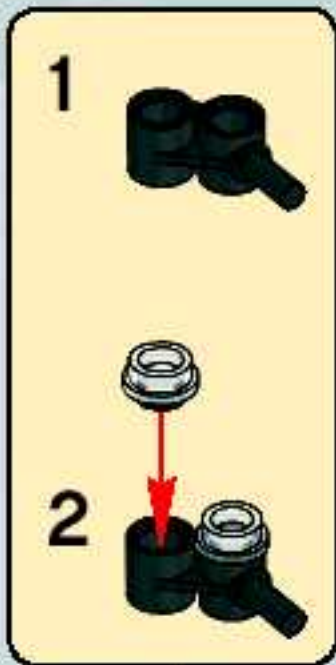

23

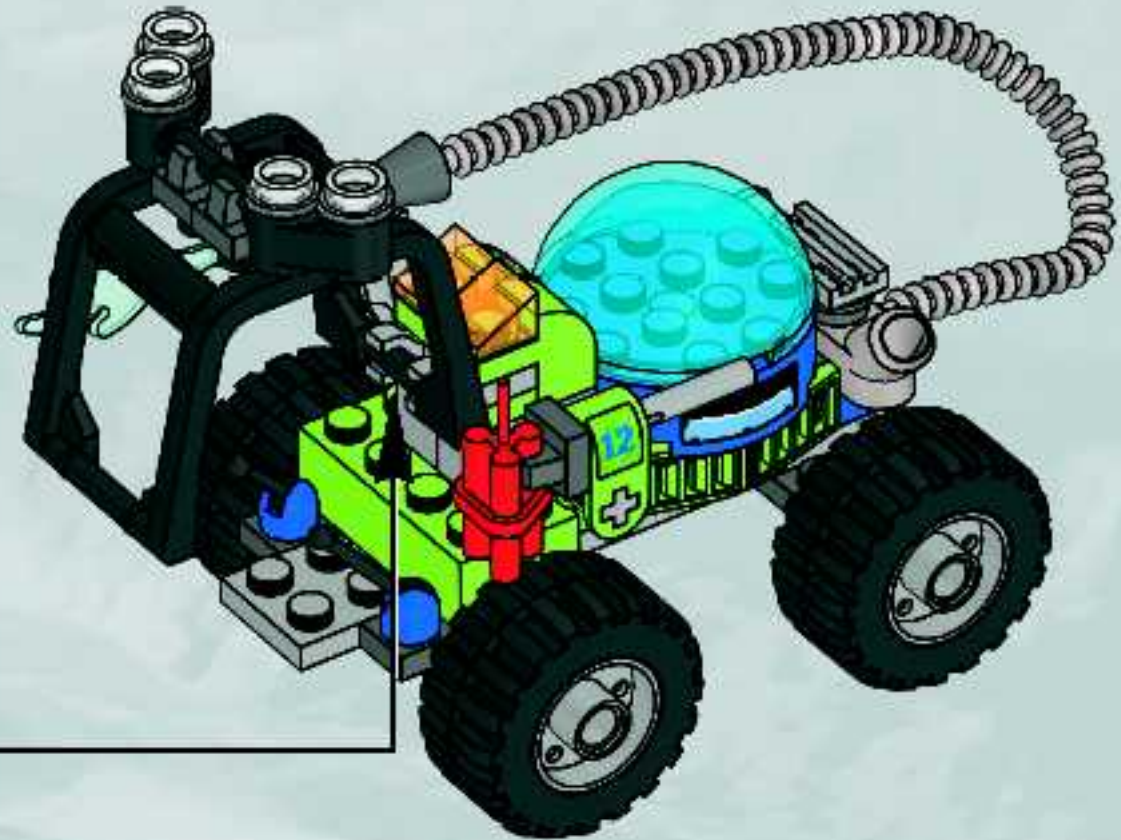

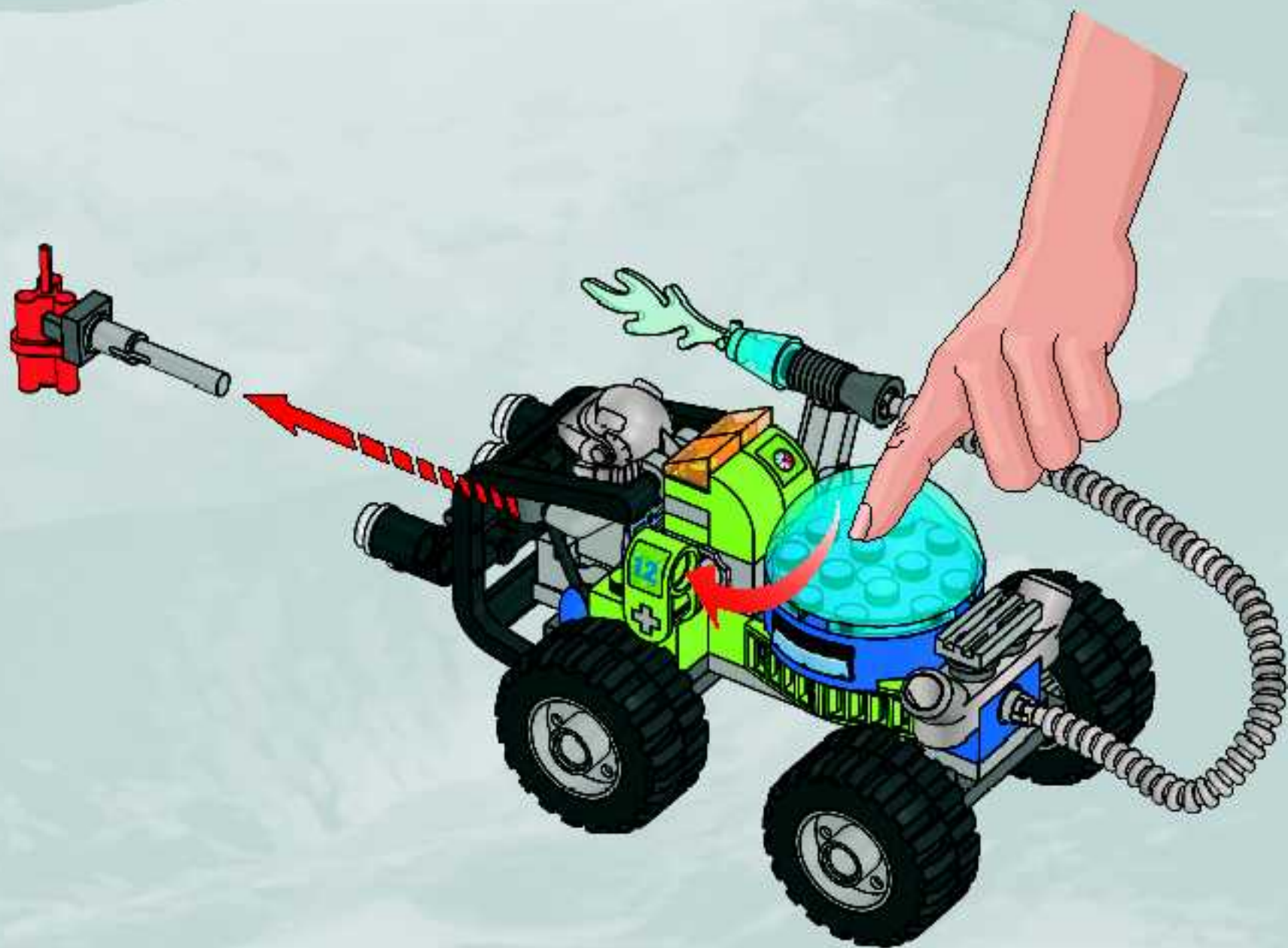



1x
4538780



2x
4562148



1x
4155537



1x
4164022

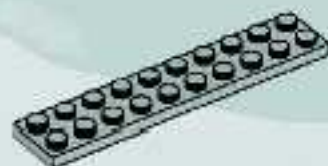

1x
4211462



1x
4561465



1x
4567527



4x
4140670



1x
4567331



1x
4165967



1x
4520320



4x
4299119



2x
4210725



1x
370023



1x
4539385



1x
4567520



4x
4540385



1x
4571223



1x
4211350



2x
4211133



2x
4296152



1x
4539385



1x
4569353



2x
4212446



1x
4571238



1x
4556157



3x
4211069



4x
3005740



2x
4244369



1x
4569374



1x
4164037



1x
4211622



1x
4211551



2x
4509884



1x
4578028



1x
4261453



2x
4233493



1x
4542169



2x
4210633



1x
4578028



1x
4518406



1x
4211639



1x
4540417



1x
4210698



Customer Service

Kundenservice

Service Consommateurs

Servicio Al Consumidor

www.lego.com/service or dial



00800 5346 5555 :



1-800-422-5346 :





POWER MINERS

powerminers.LEGO.COM



Infernox



Combustix



Firax



Eruptorr



8189





THE ADVENTURES OF CLUTCH POWERS



FIRST LEGO® DVD MOVIE!
SPRING 2010

Premier film LEGO® en DVD ! Printemps 2010 - ¡La 1ª Pelicula de LEGO® en DVD! Primavera 2010

LEGO and the LEGO logo are trademarks of The LEGO Group. © 2009 The LEGO Group. © 2009 The LEGO Group. All Rights Reserved. © 2009 Universal Studios. All Rights Reserved.





WIN!

Go to www.nielsen.com/LEGO
to fill out a survey for a chance
to win a cool LEGO® Product.
No purchase necessary.
Open to all residents where not prohibited.



www.nielsen.com/LEGO

GEWINNE!

Nimm an der Umfrage auf
[www.nielsen.com/](http://www.nielsen.com/LEGO)
LEGO teil und hab die Chance ein cooles
LEGO® Produkt zu gewinnen!

Die Teilnahme am Gewinnspiel führt zu keinerlei
Kaufverpflichtungen. Teilnahme in allen nicht
ausgeschlossenen Ländern möglich.

WIN!

Ga naar www.nielsen.com/LEGO,
vul een enquêteformulier in en
maak kans op een
cool LEGO® product.

Geen aankoopverplichting.
Iedereen mag deelnemen, uitgezonderd
Ingezetenden
van landen waar een enquêteverbod geldt.

GAGNE!

Visite www.nielsen.com/LEGO
pour répondre à un questionnaire
et avoir une chance de gagner
un produit LEGO® très cool!

Aucune obligation d'achat.
Ouvert à tous les résidents des pays
autorisés.

当てよう!

www.nielsen.com/LEGO
にアクセスして、
アンケートにご記入ください。
当選者にはレゴ製品を
差し上げます。

お買い上げの必要はありません。
禁止されていない限り、すべての店舗にご利用いただけます。