



LEGENDS OF

CHIMA

TM

70146





3

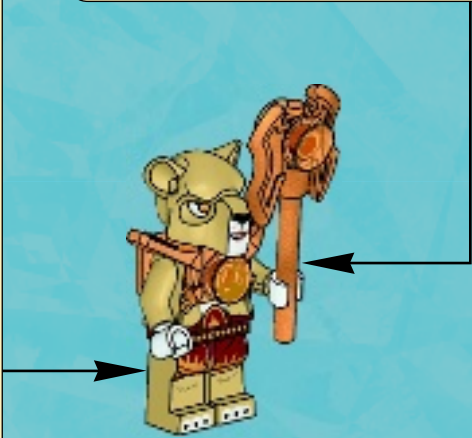
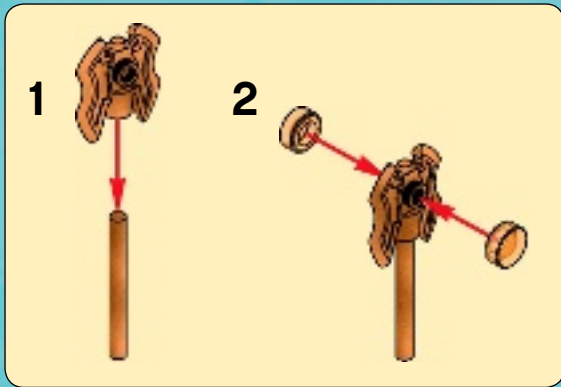
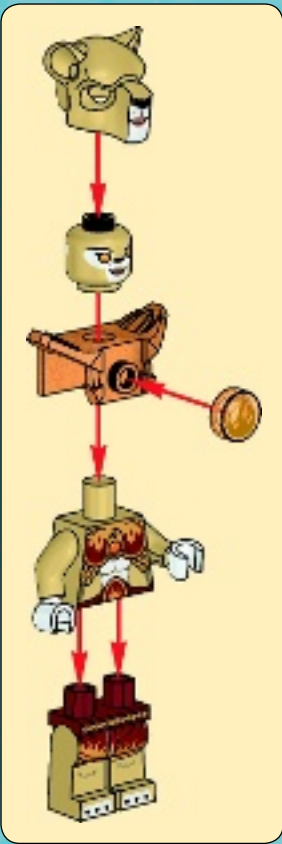

1



2



3

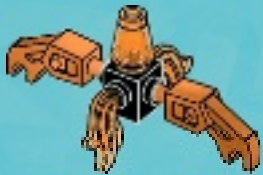

4



5



6



1



3



2



1

2

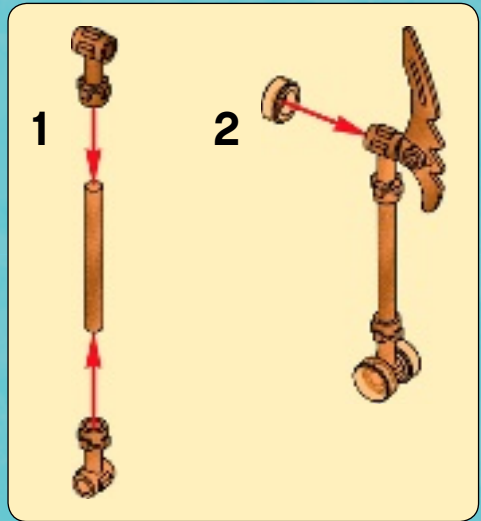

4



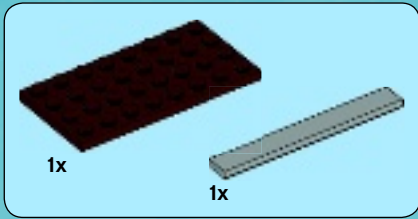

1



2

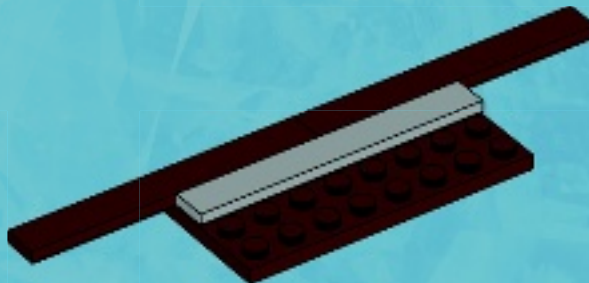

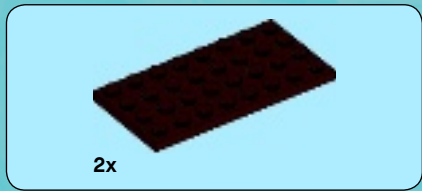

3

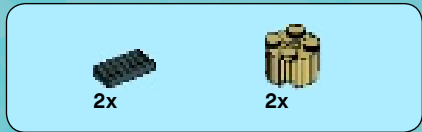
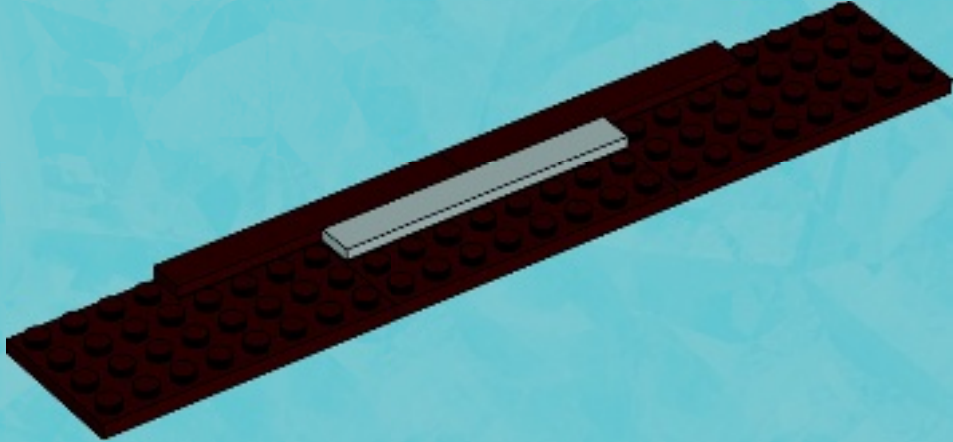

4

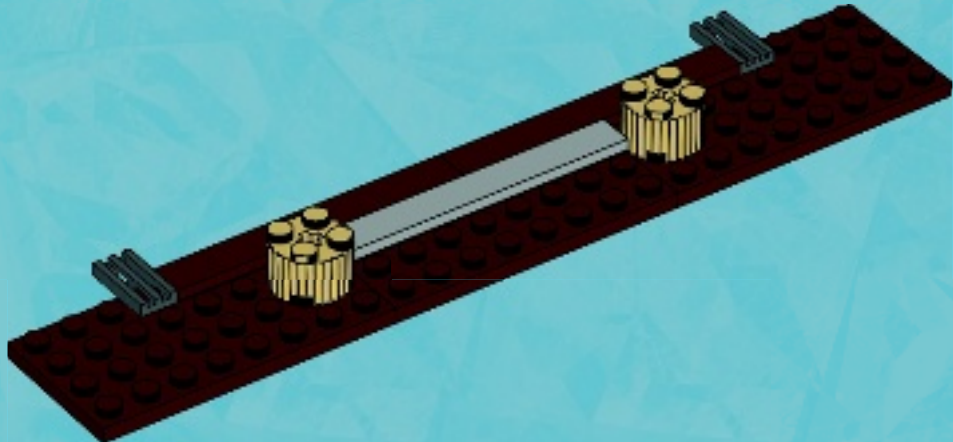



5

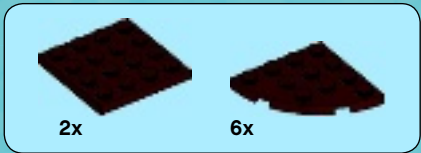
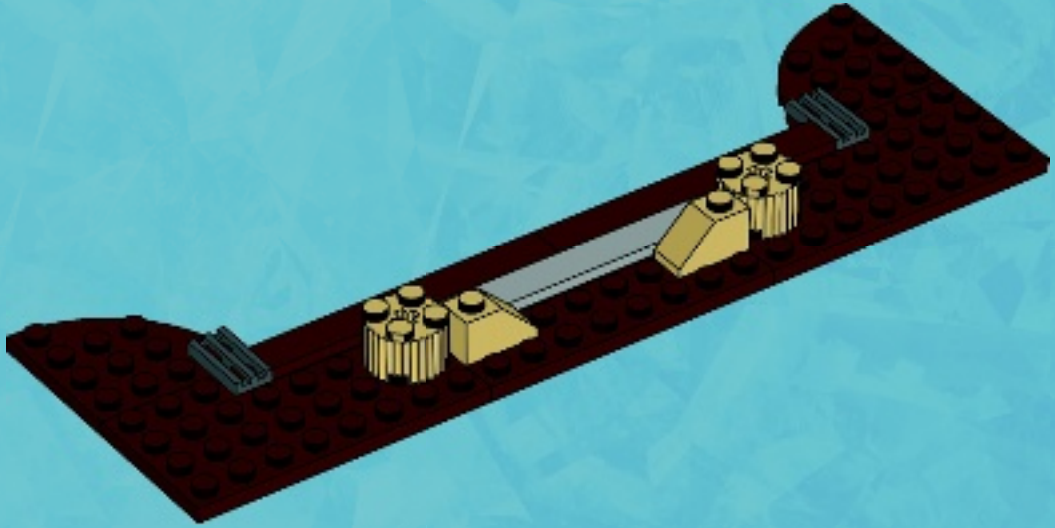

6

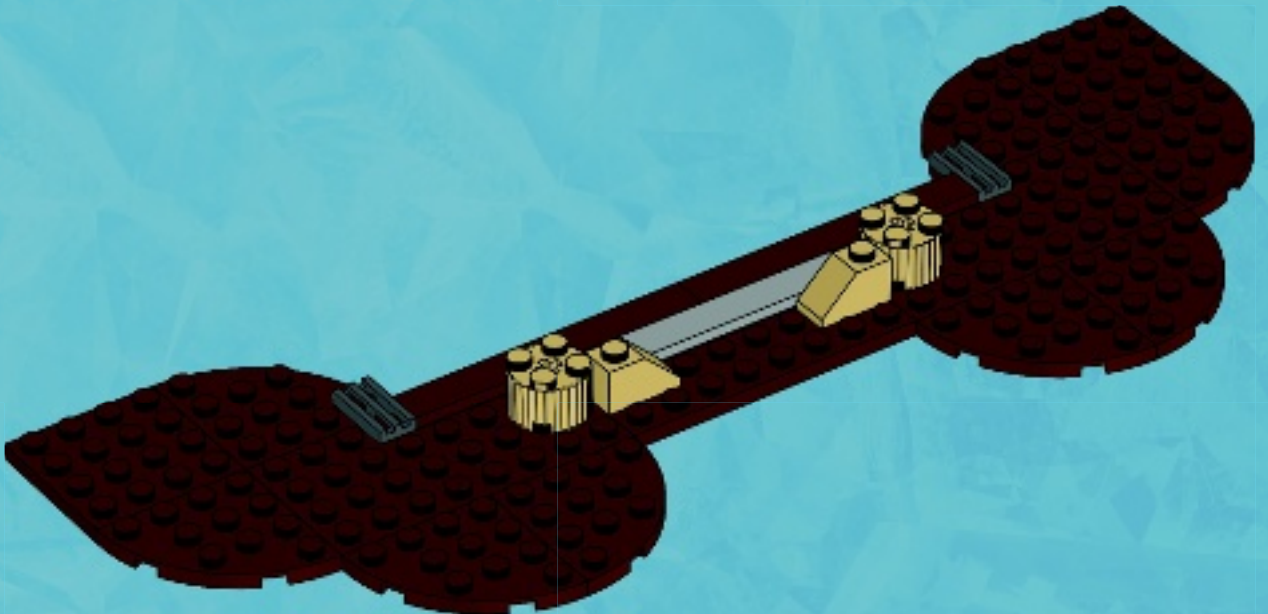



4x

7

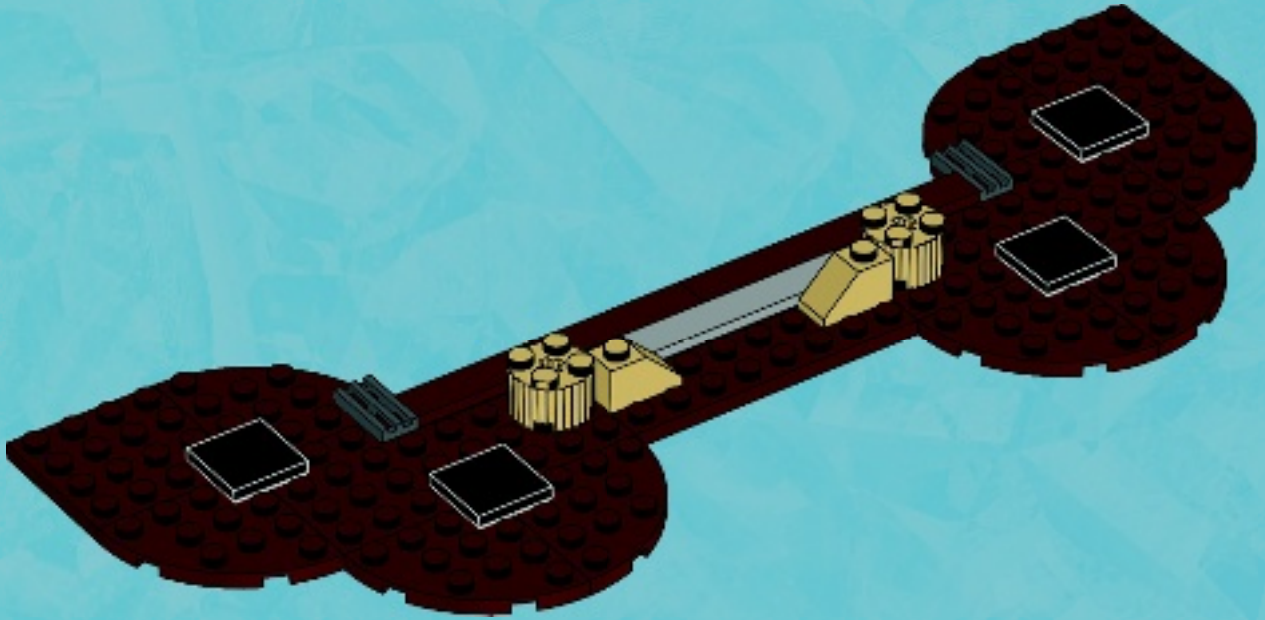

2x



4x

8

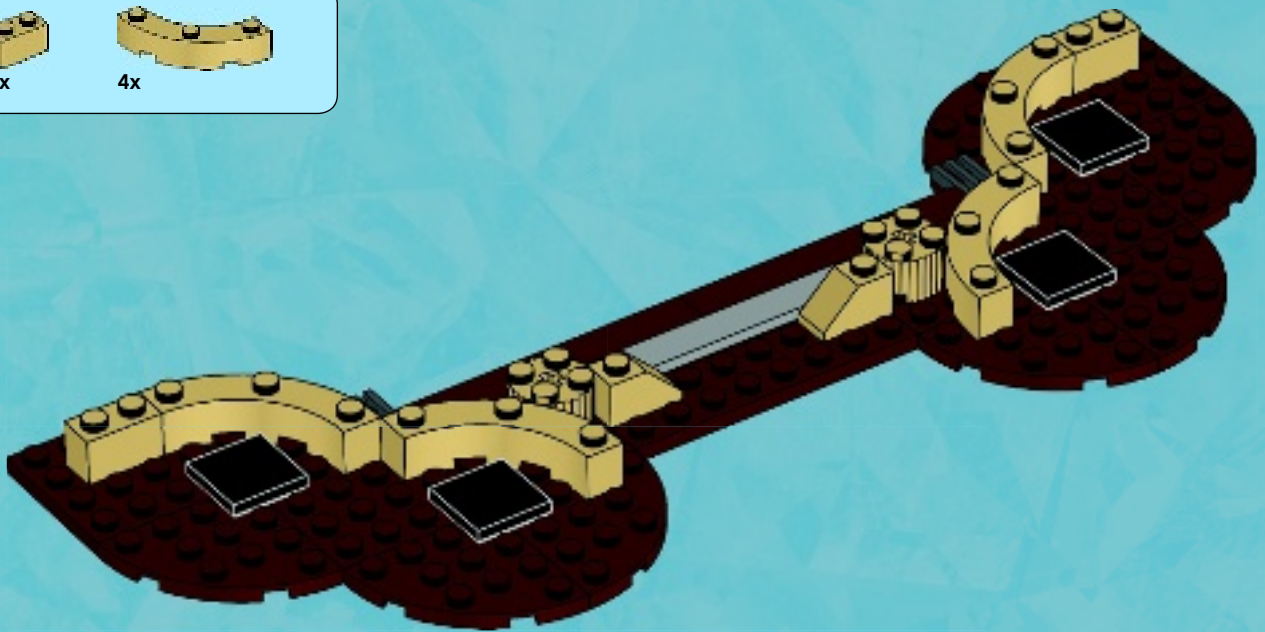



2x



2x



4x

9

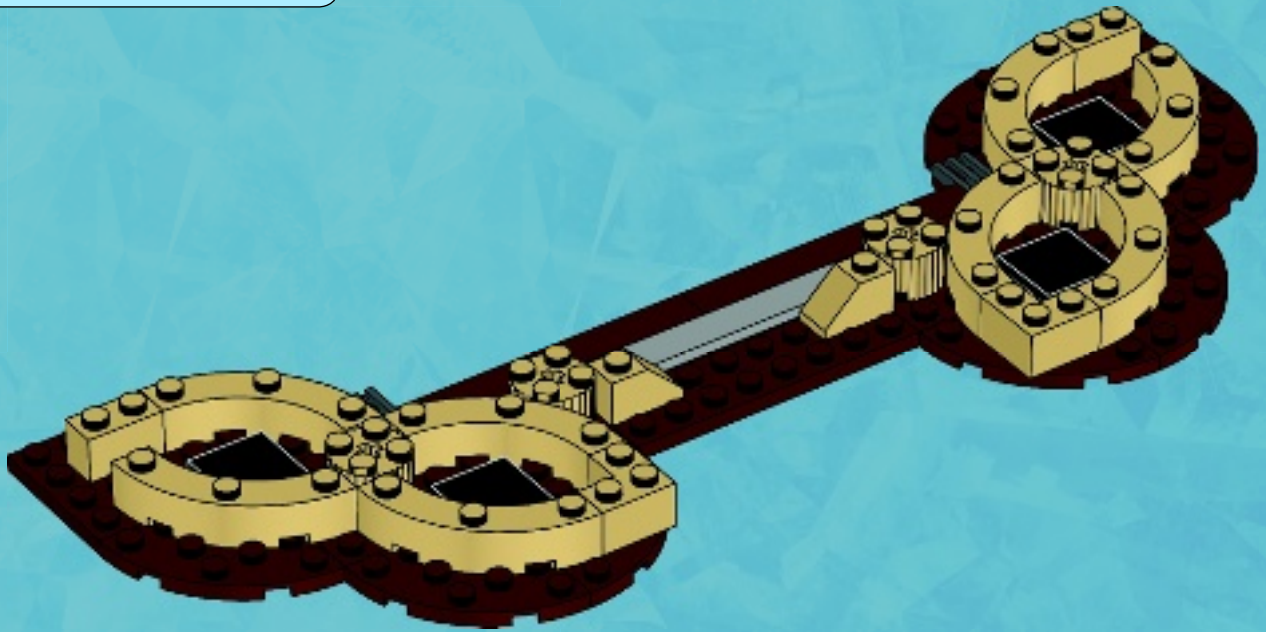

2x



2x



2x



4x

10

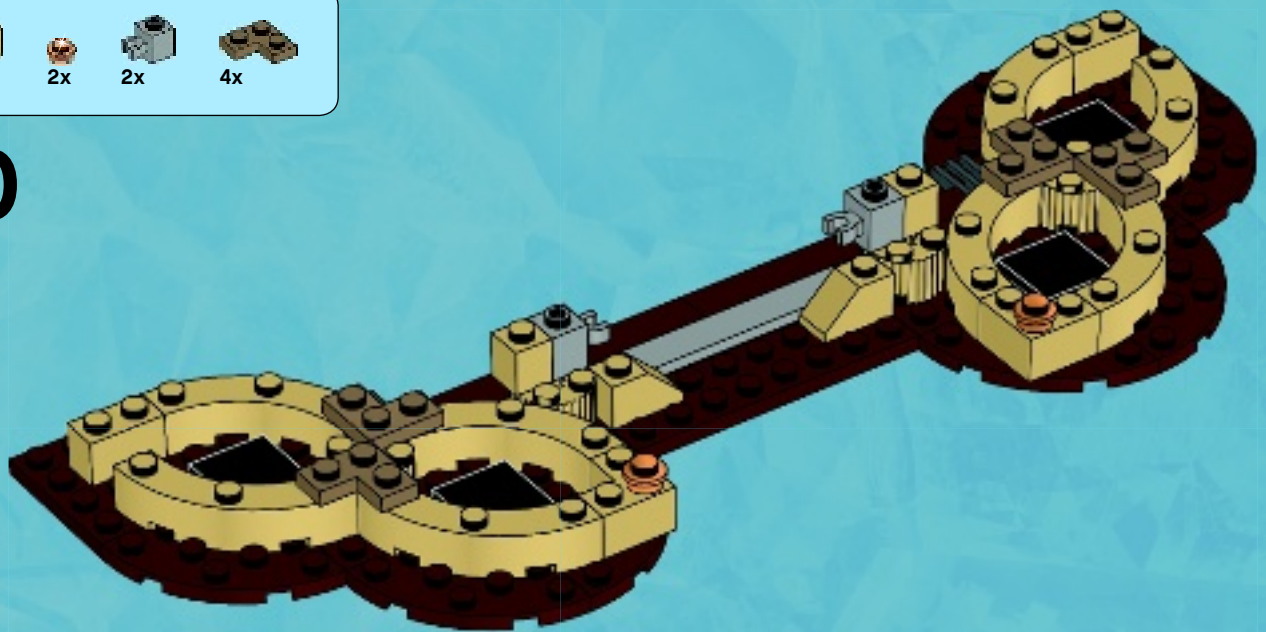

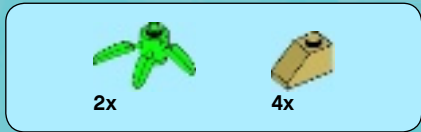

11

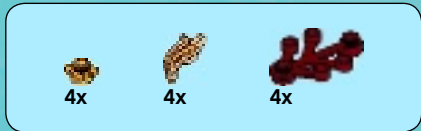

12

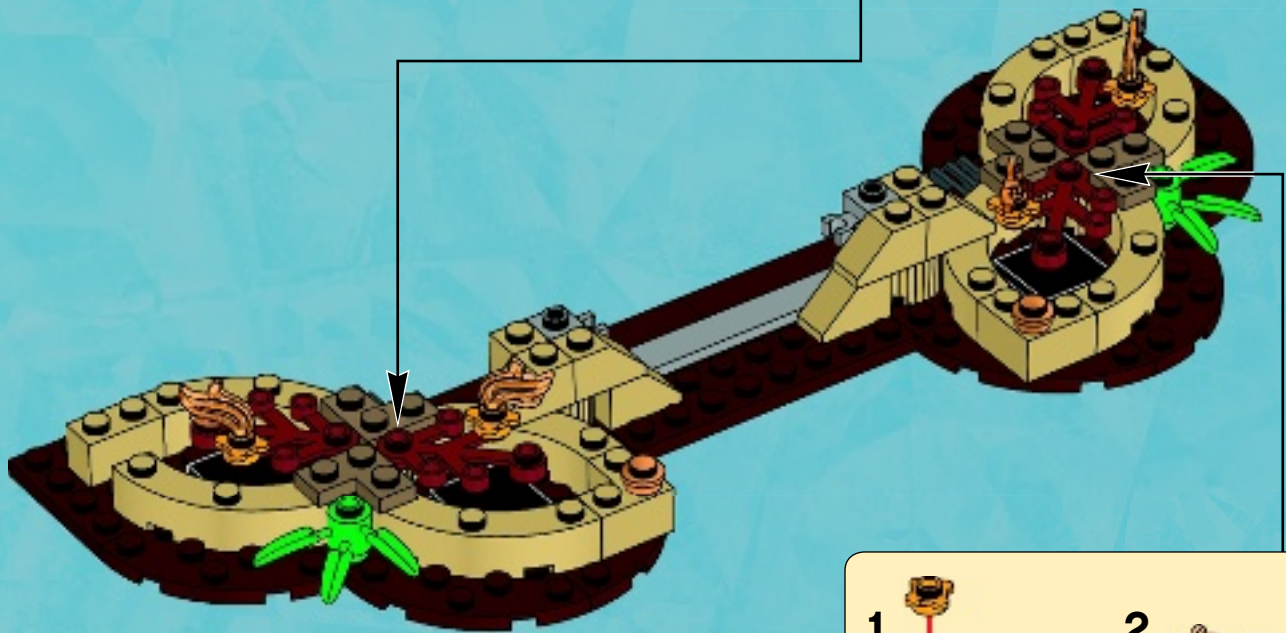



2x

13

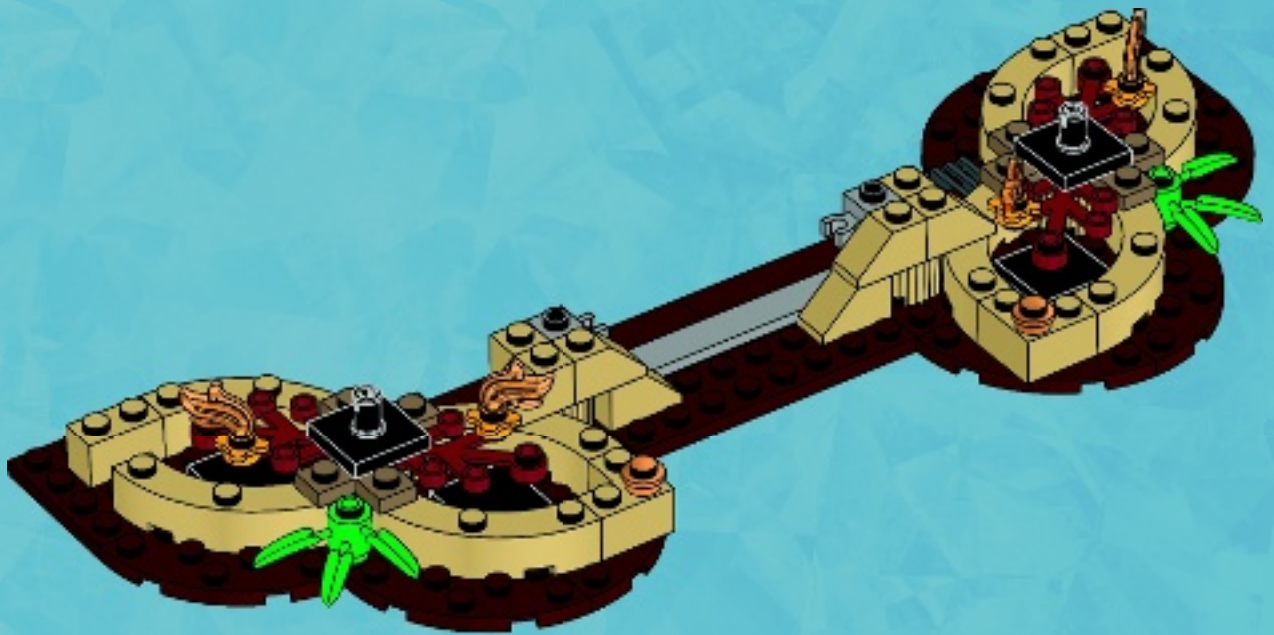

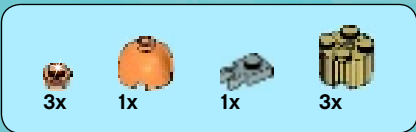

14

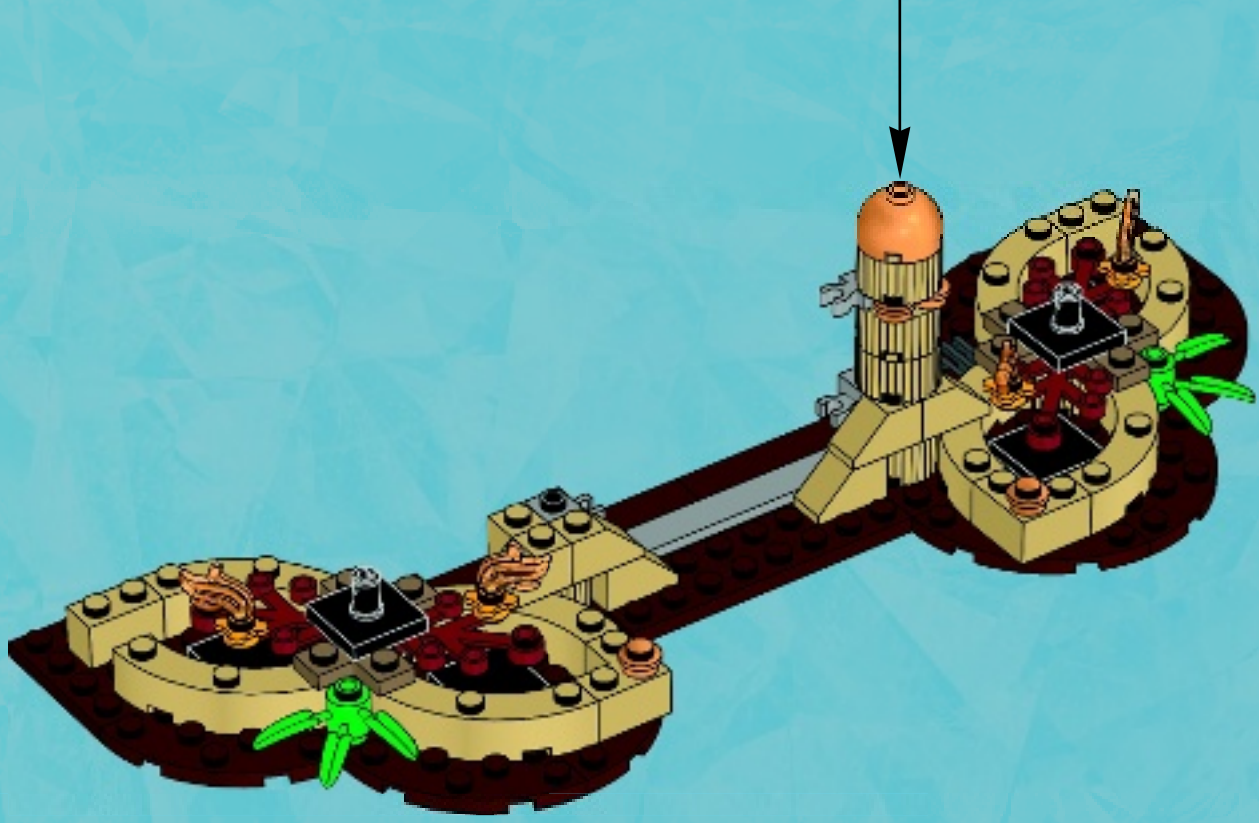

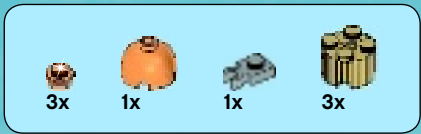

15

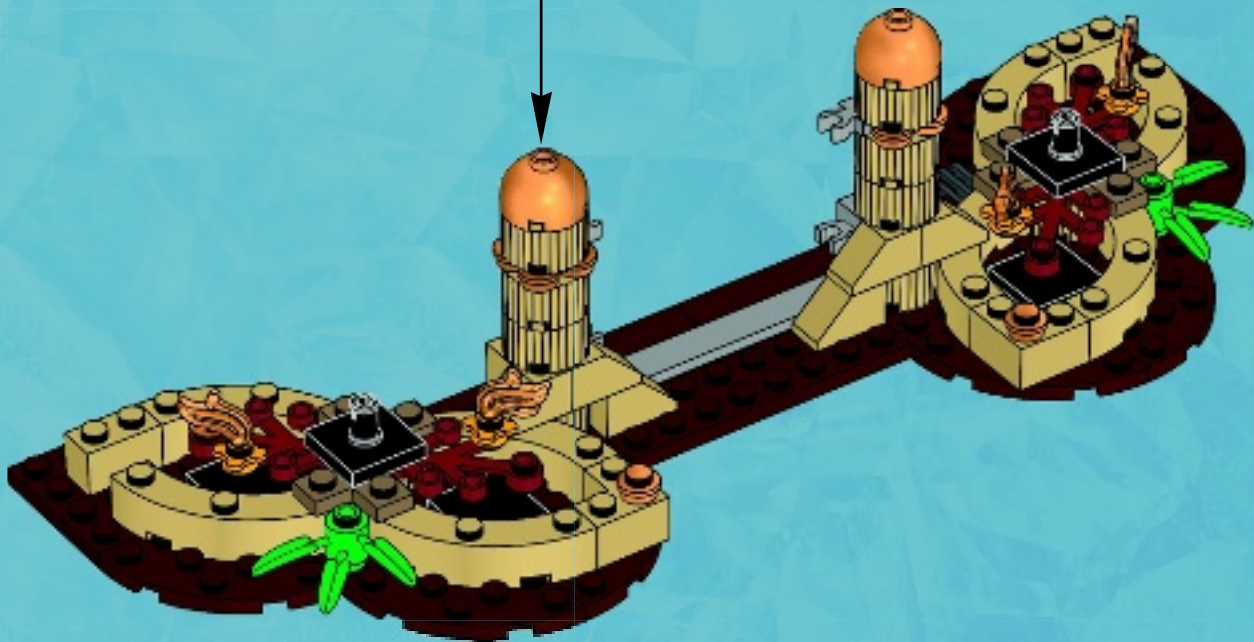
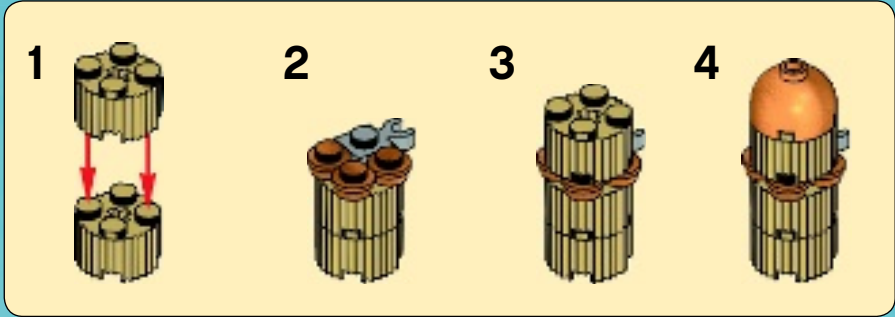

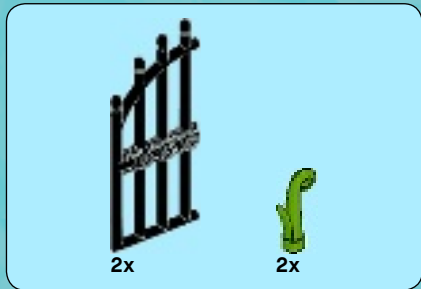

16

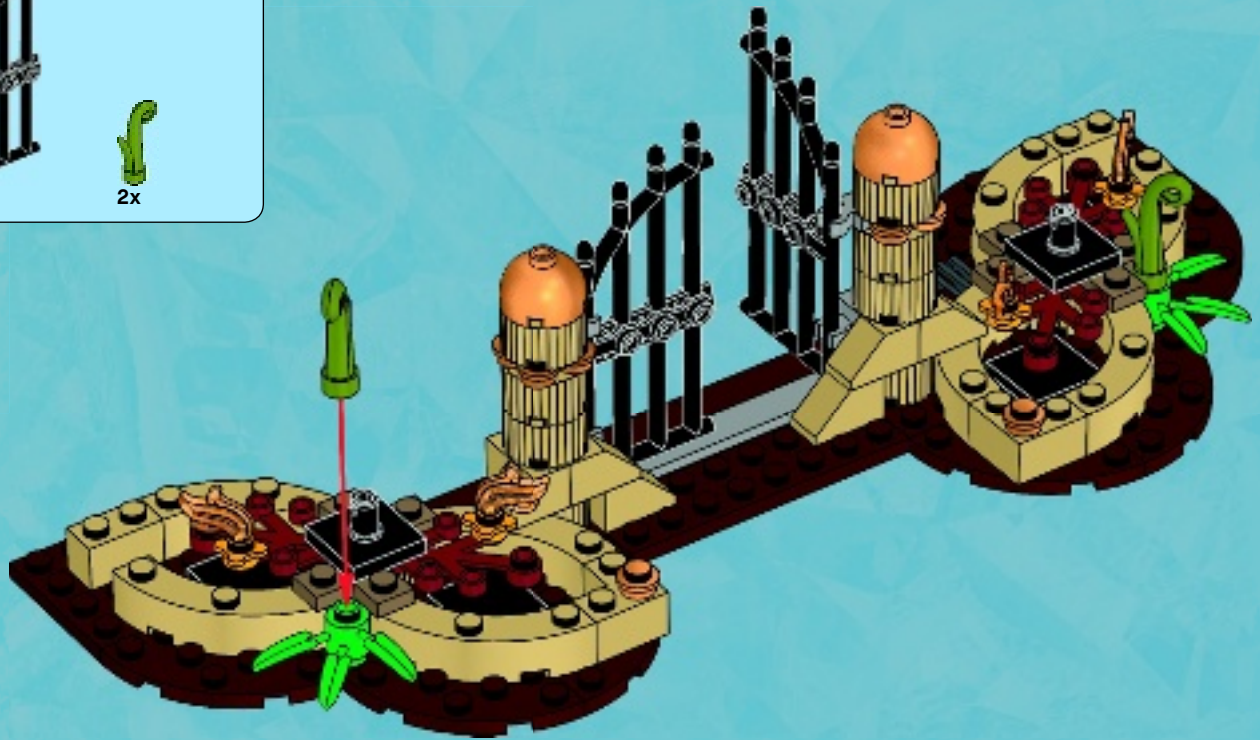

17

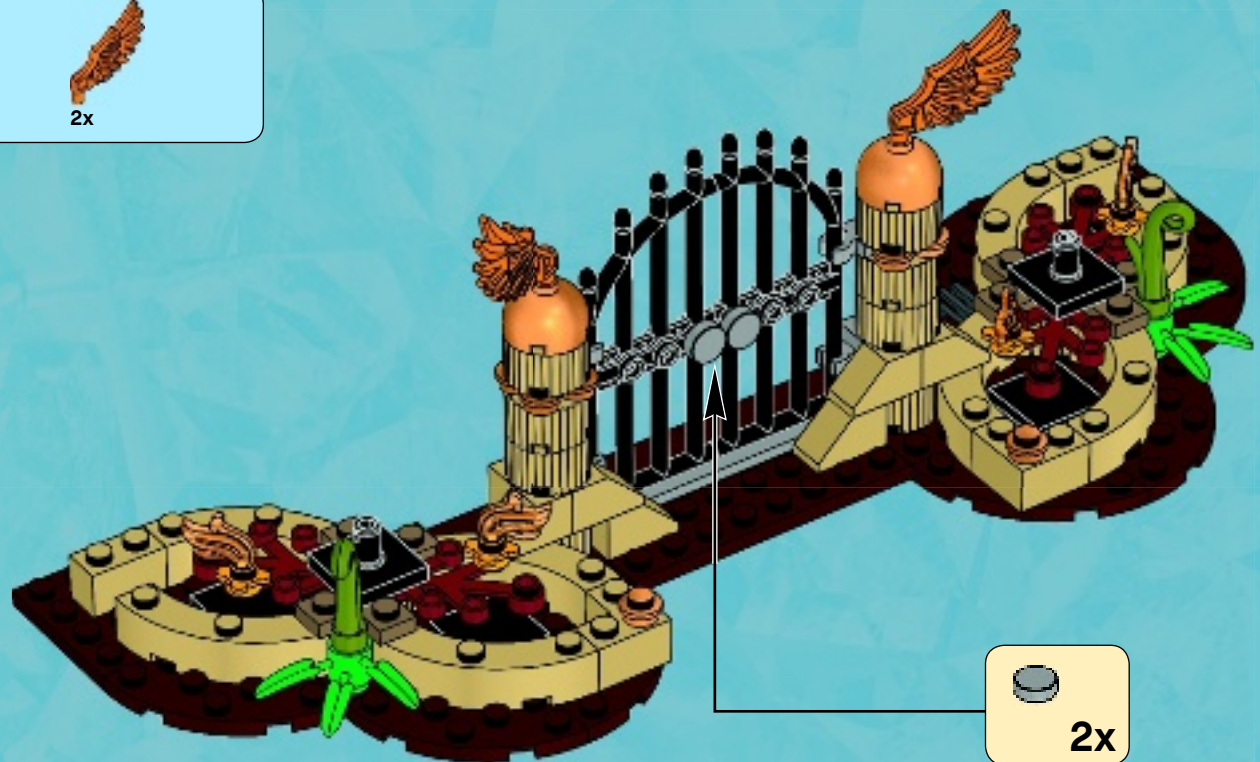



18

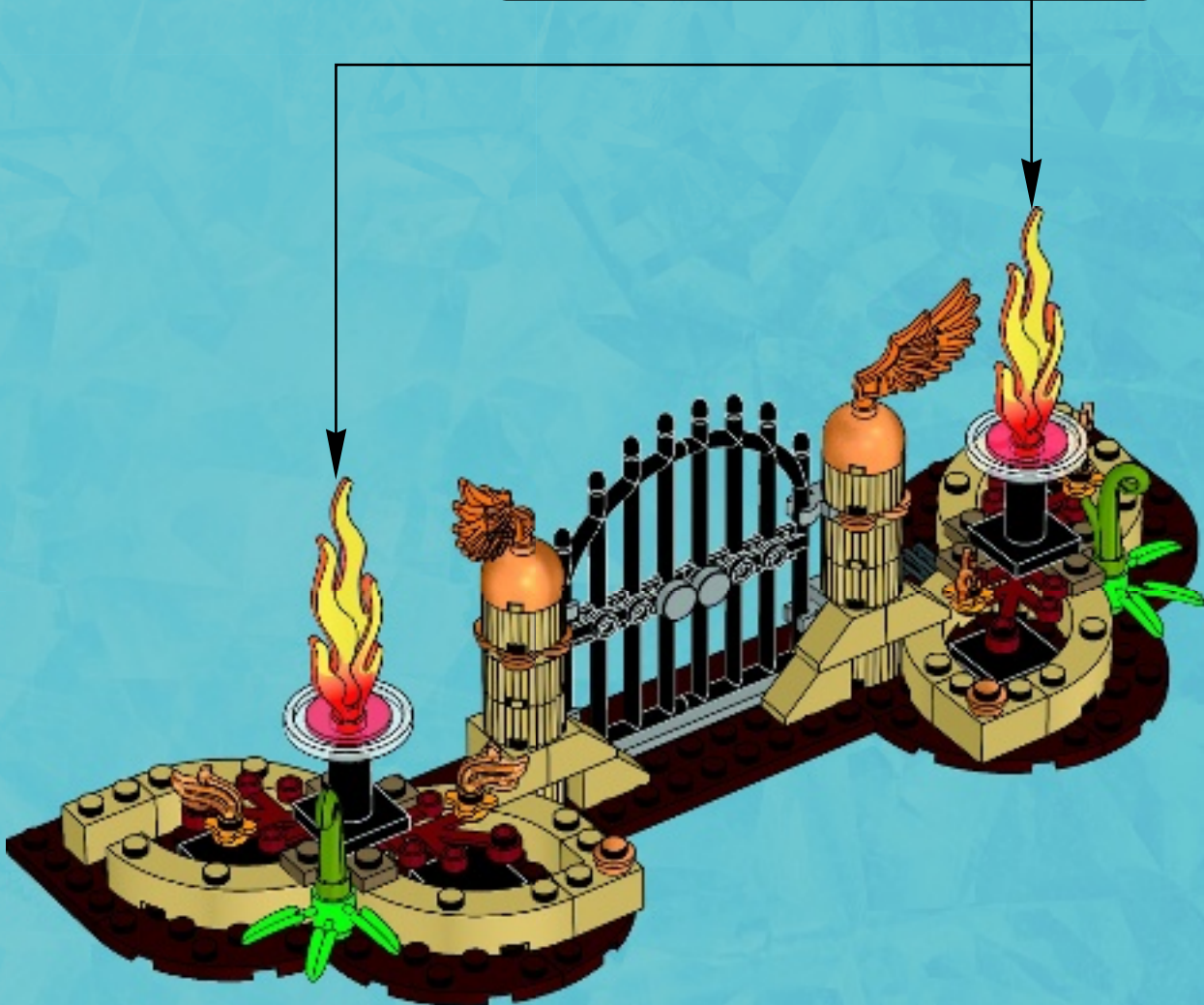
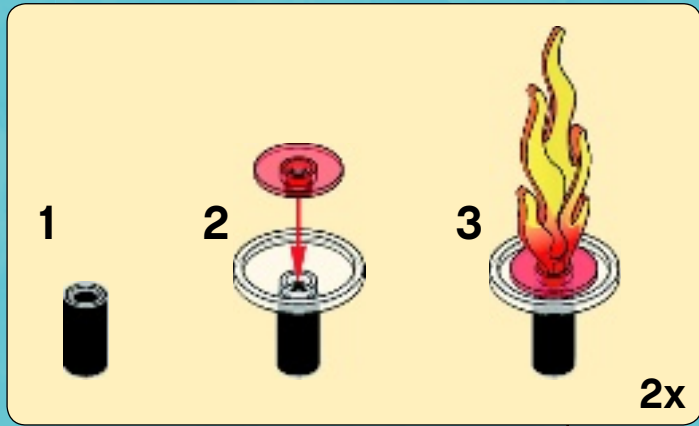

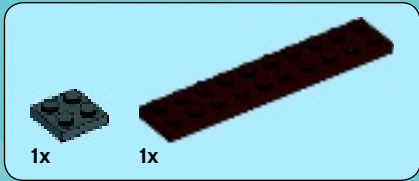
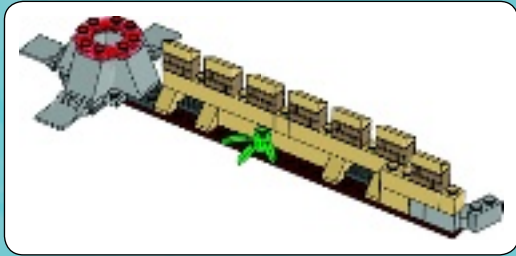

1

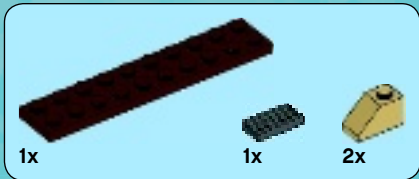

2

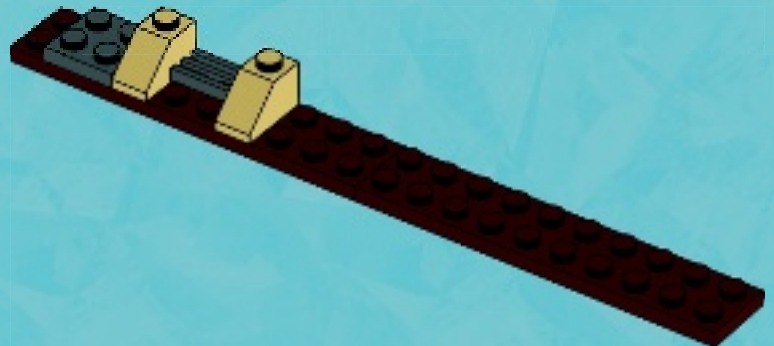

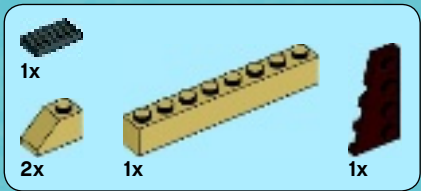

3

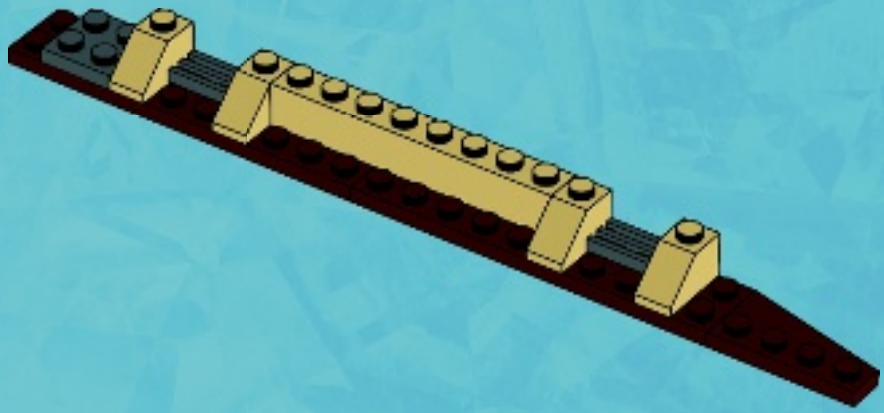

4

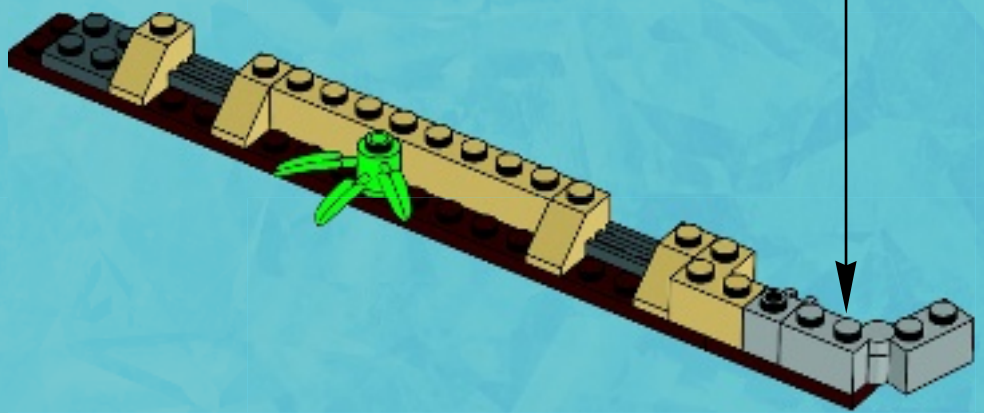
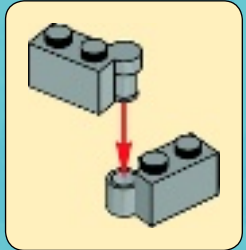

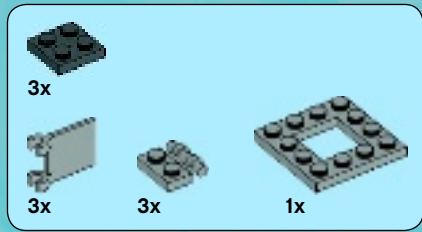

5

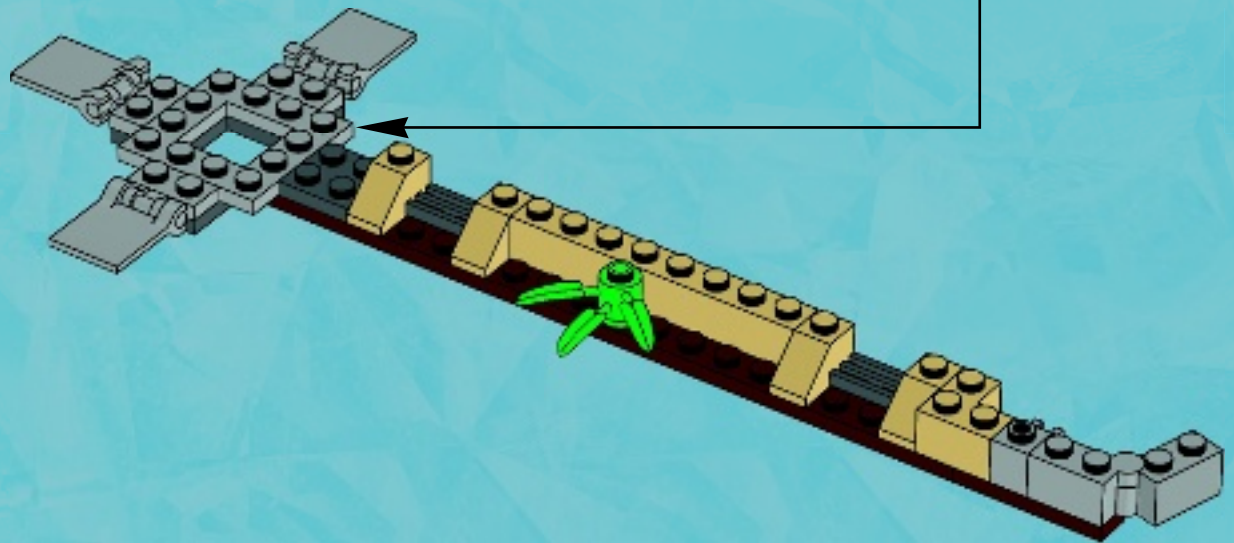
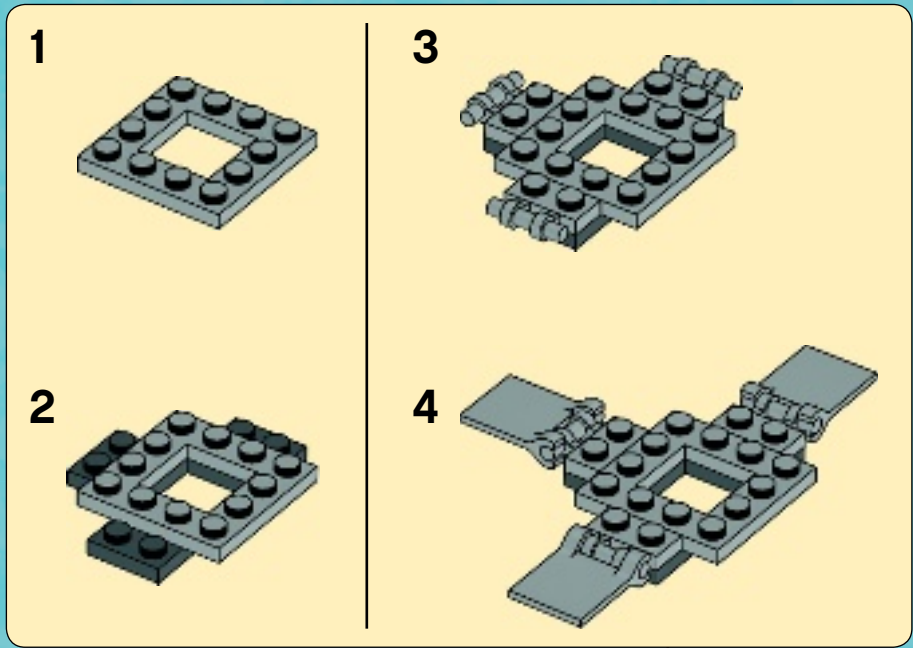



4x

6

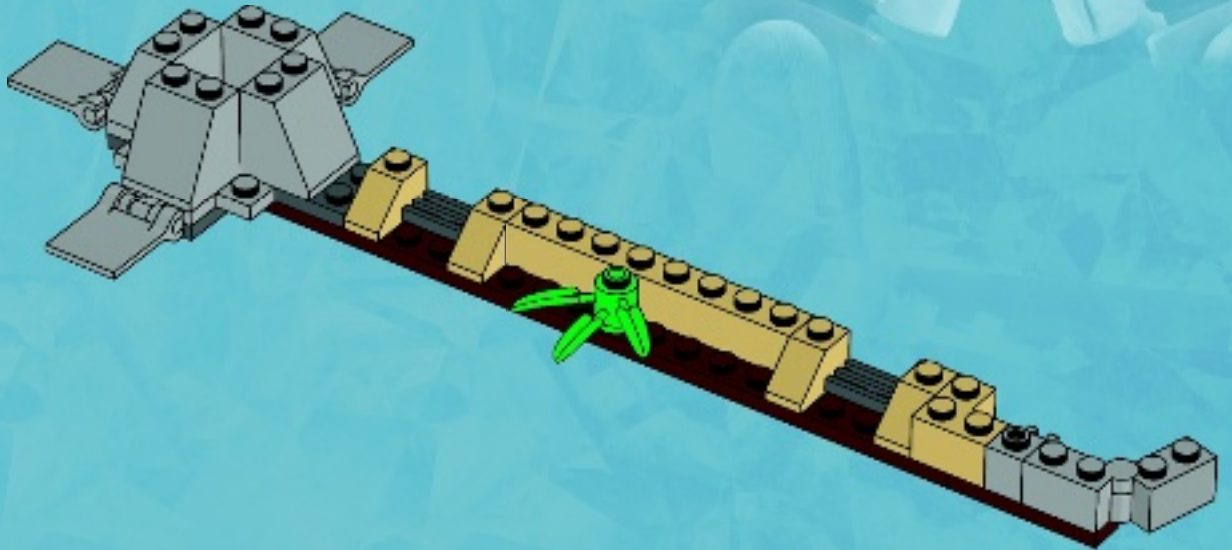

1x



2x

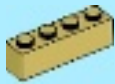

1x



2x

7

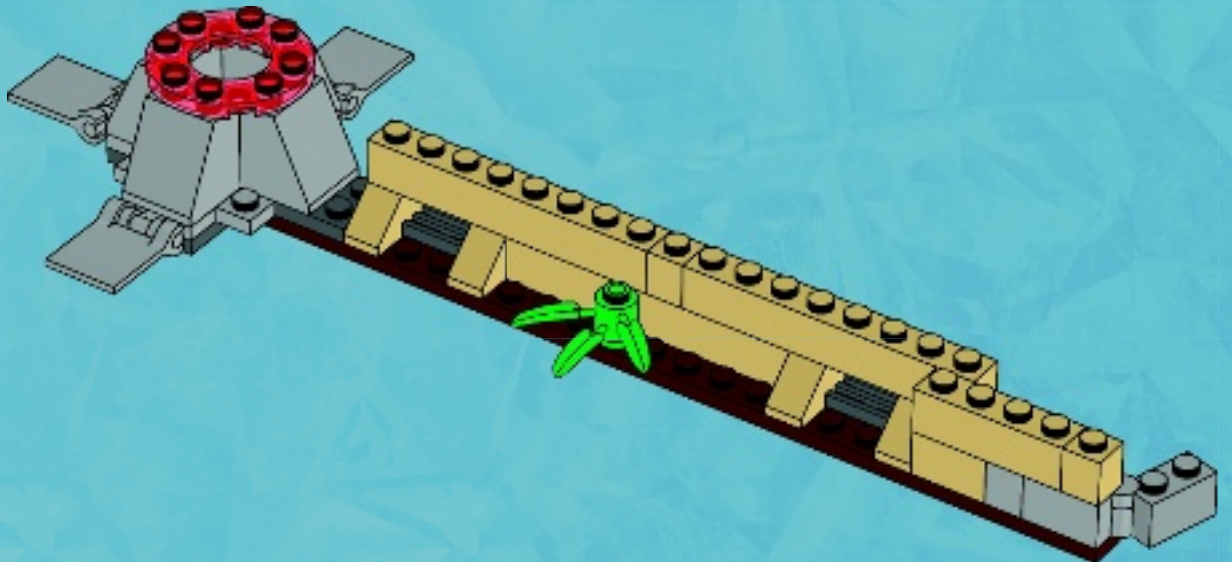

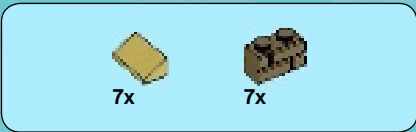

8

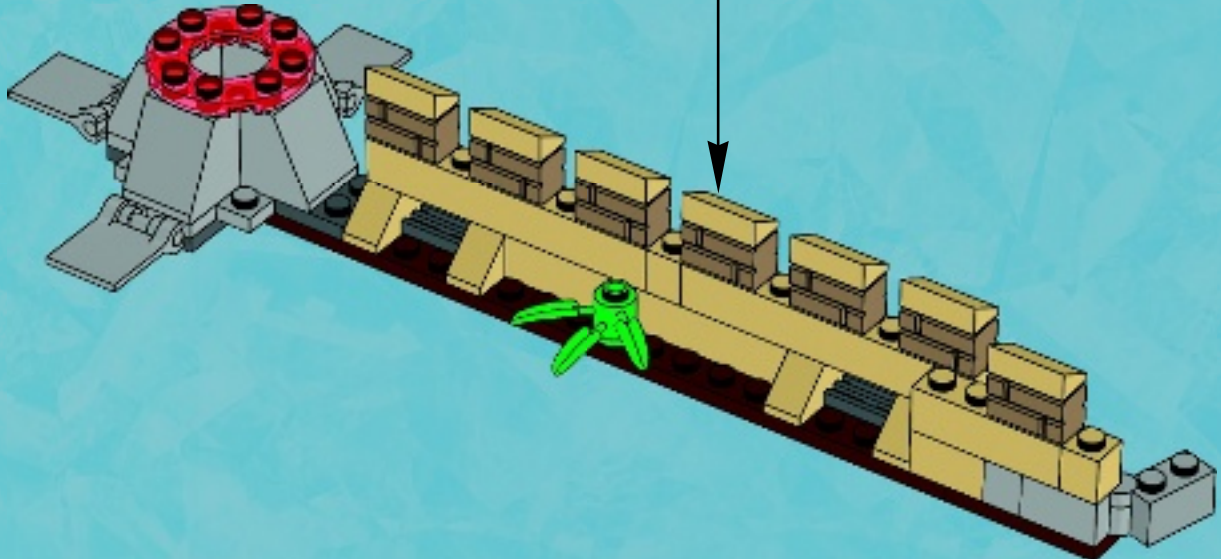
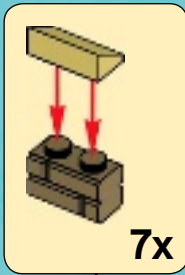

19

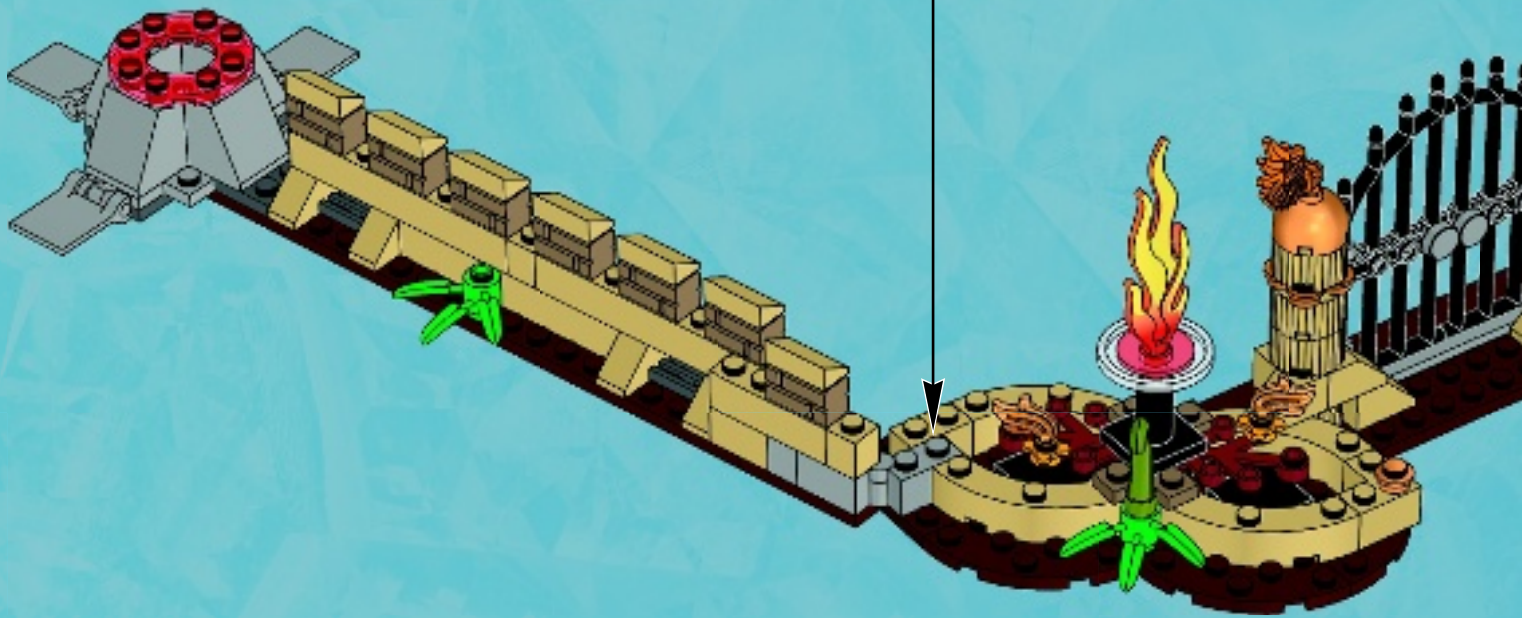



1x



1x

20

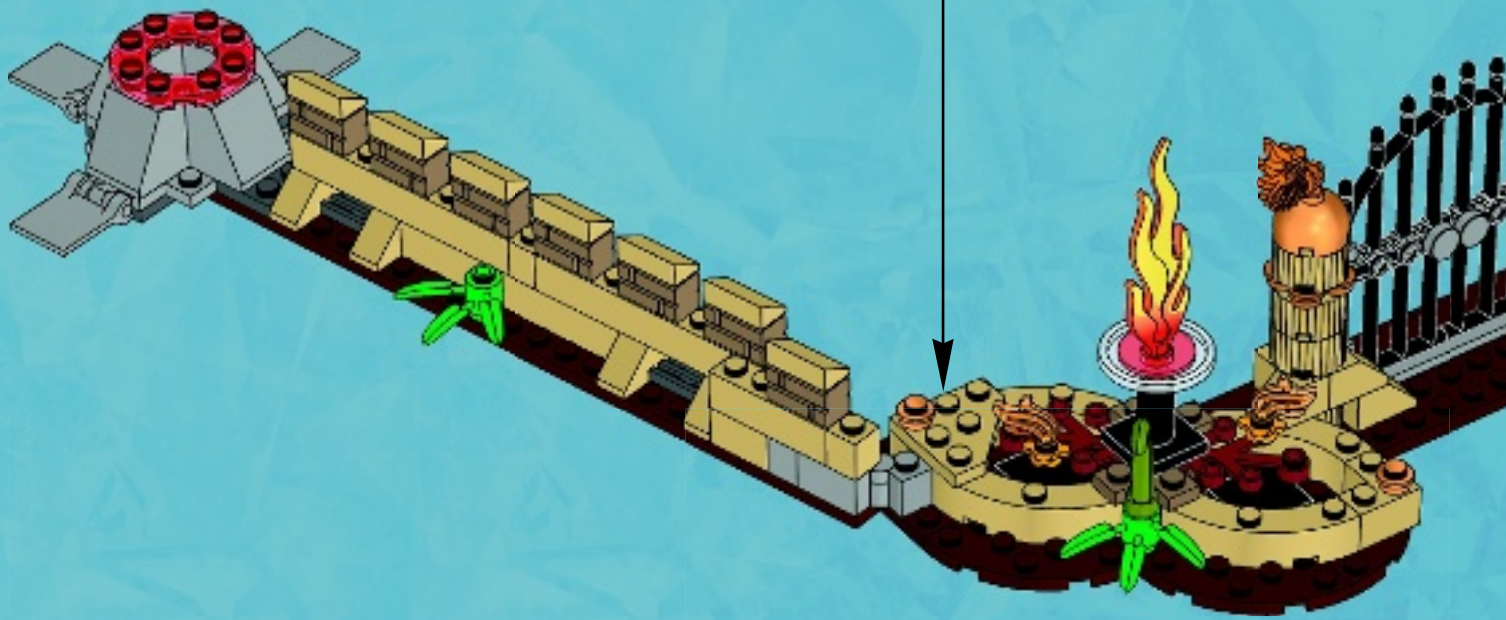

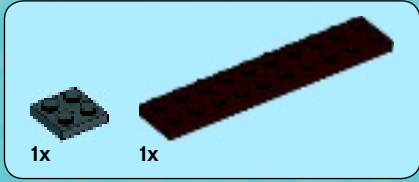
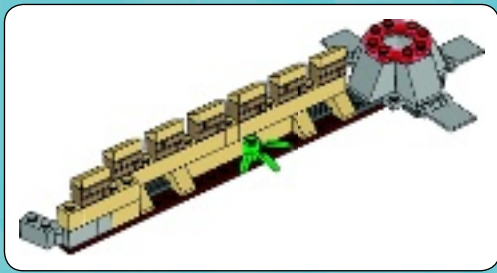

1

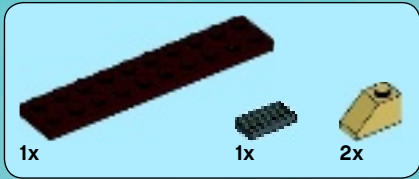

2

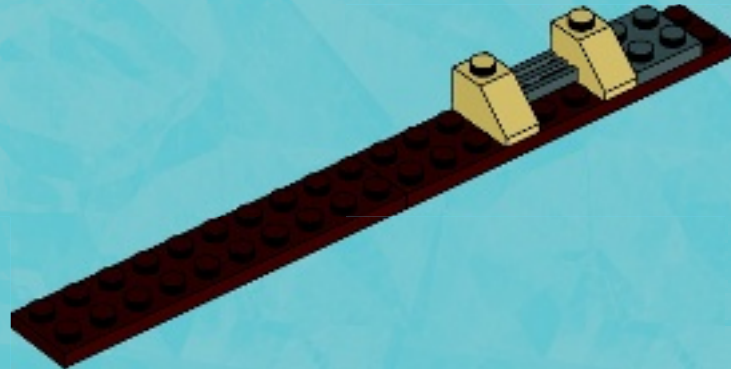

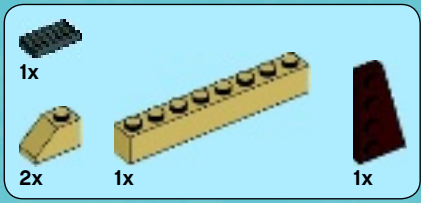

3

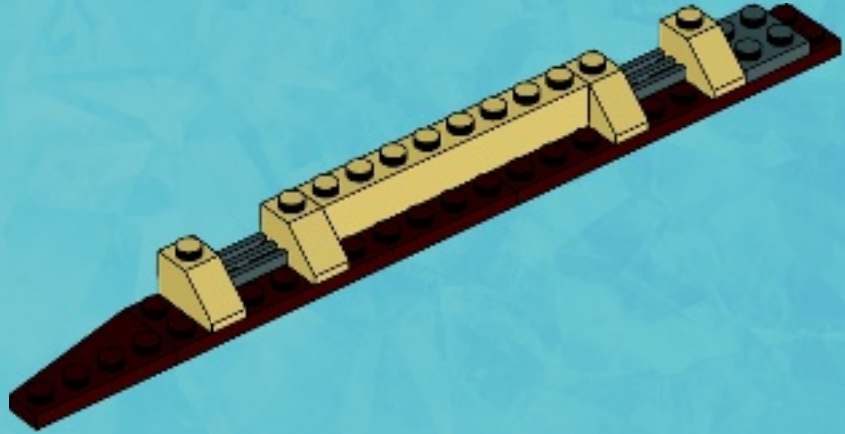

4

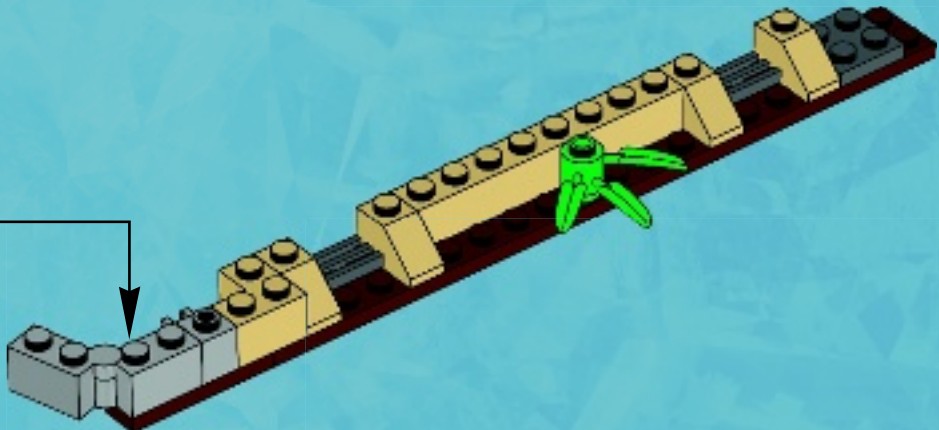
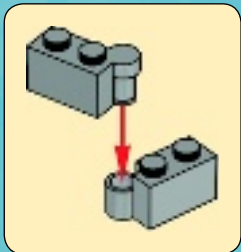

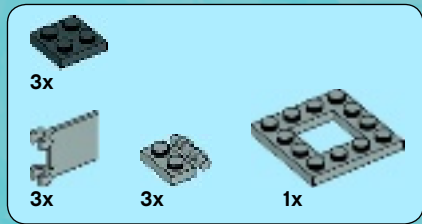

5

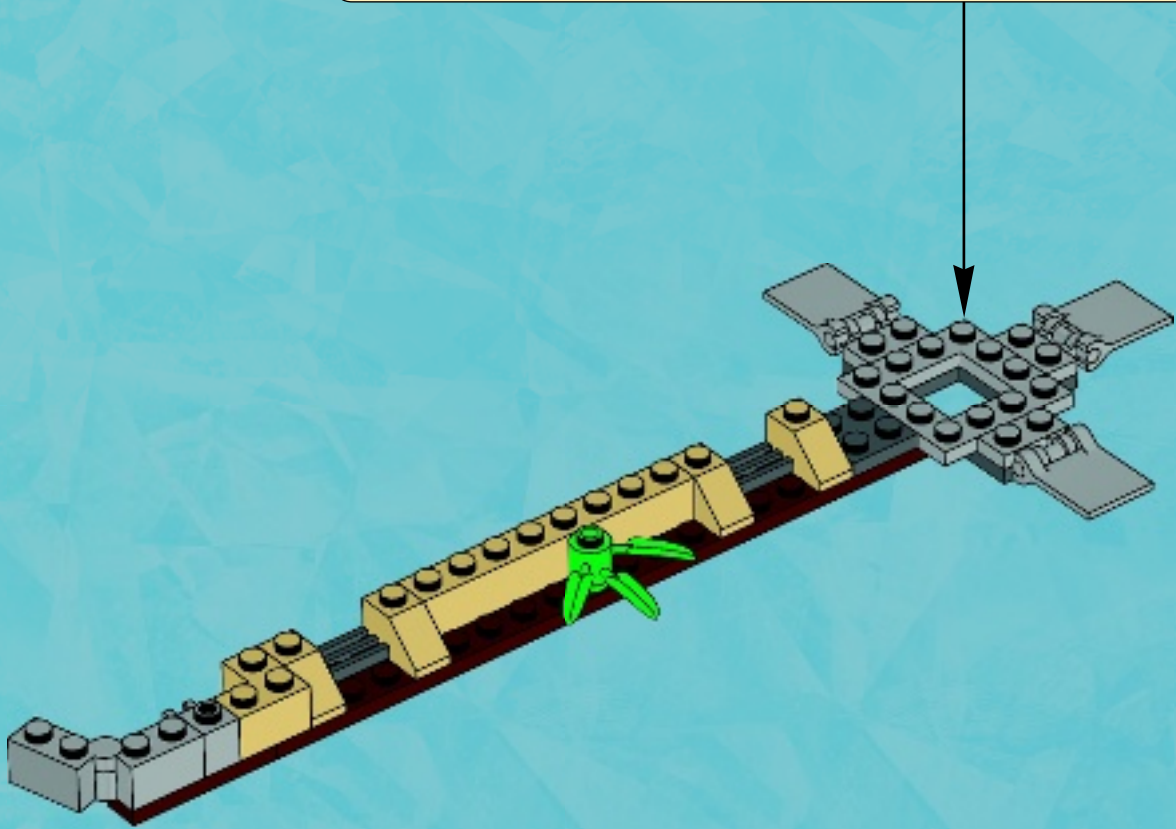
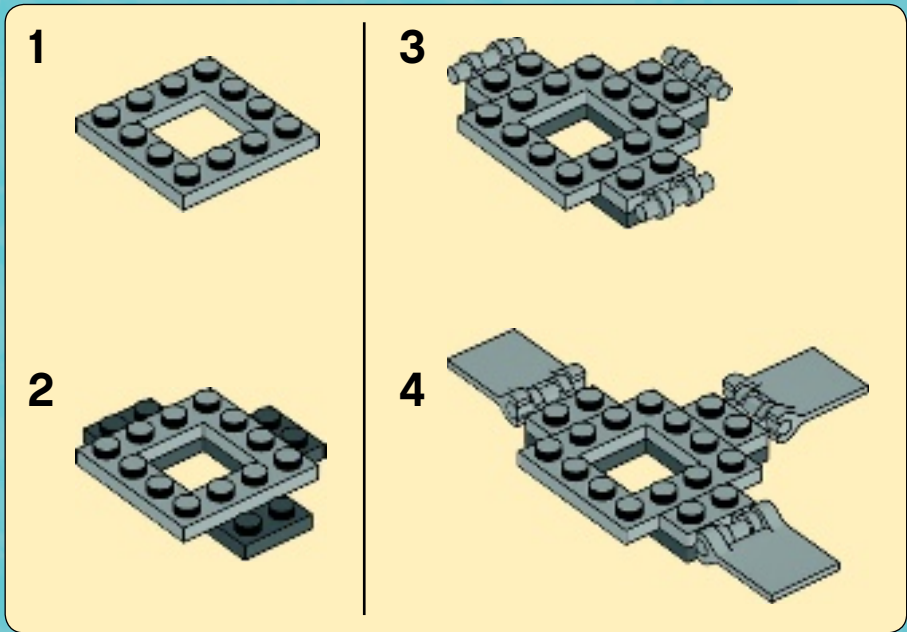



4x

6

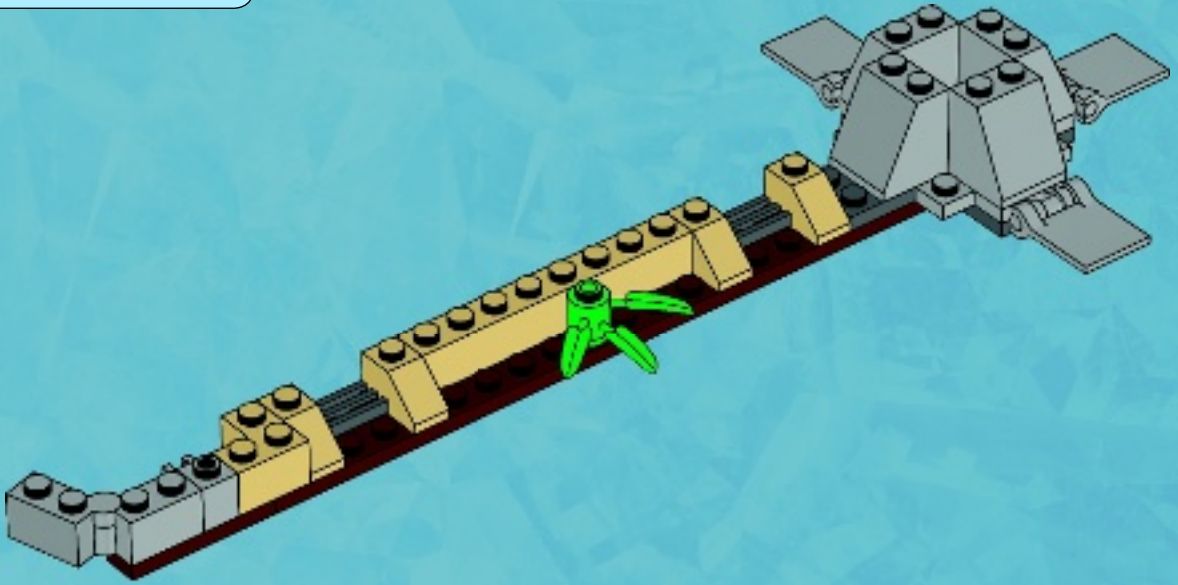

1x



2x



1x

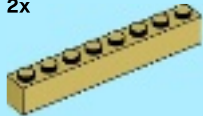

2x

7

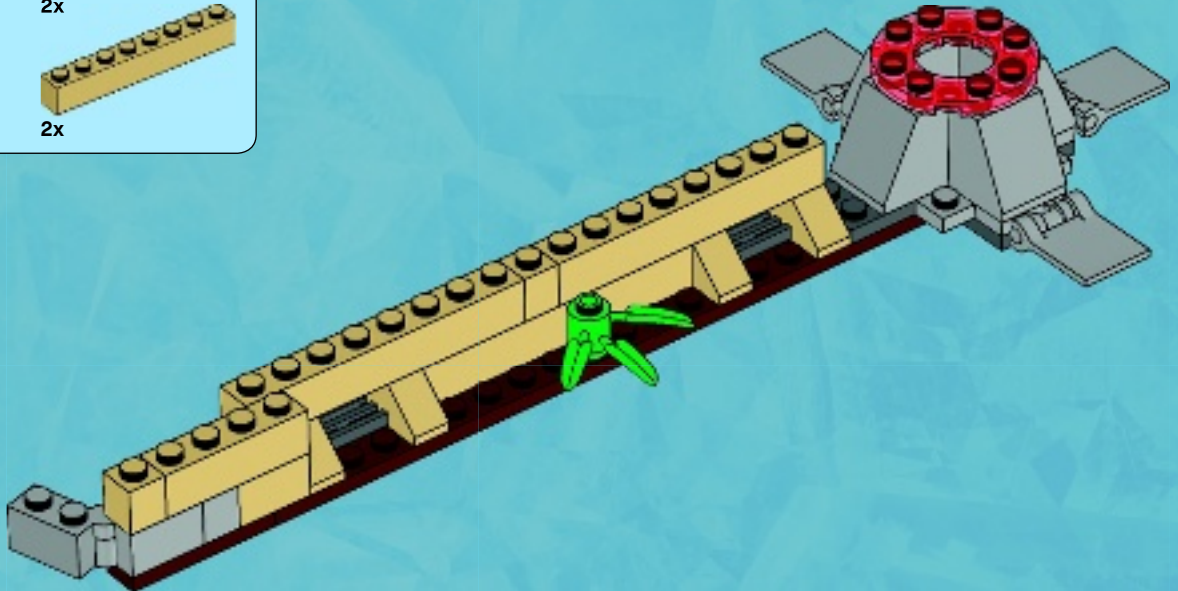

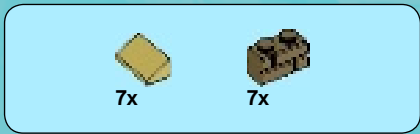

8

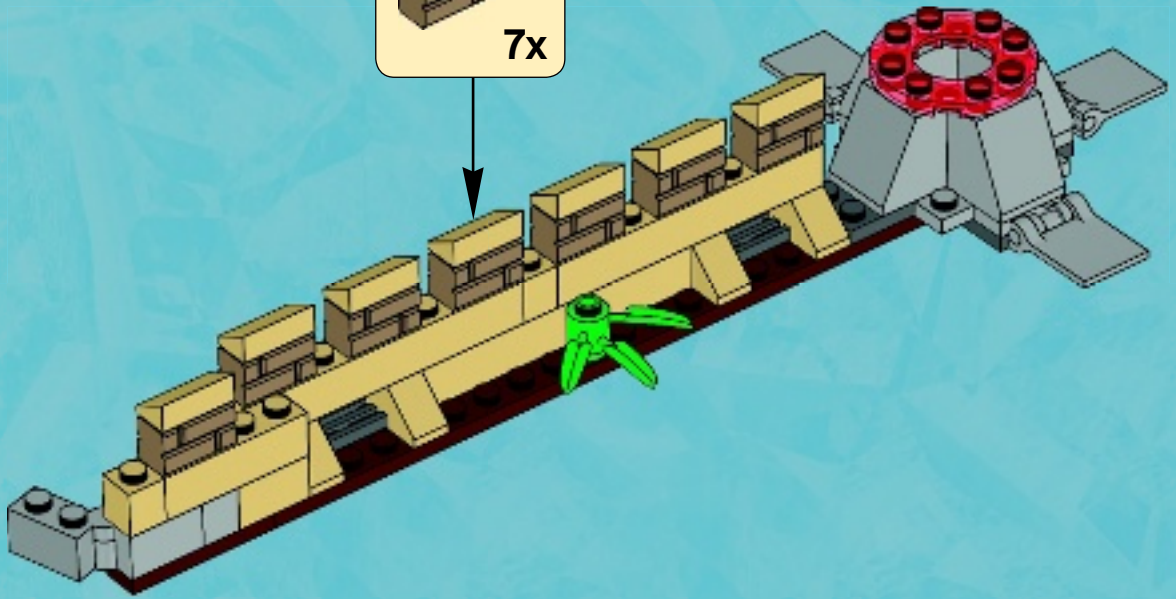
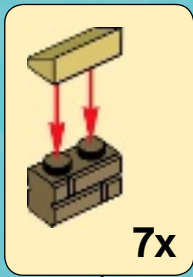

21

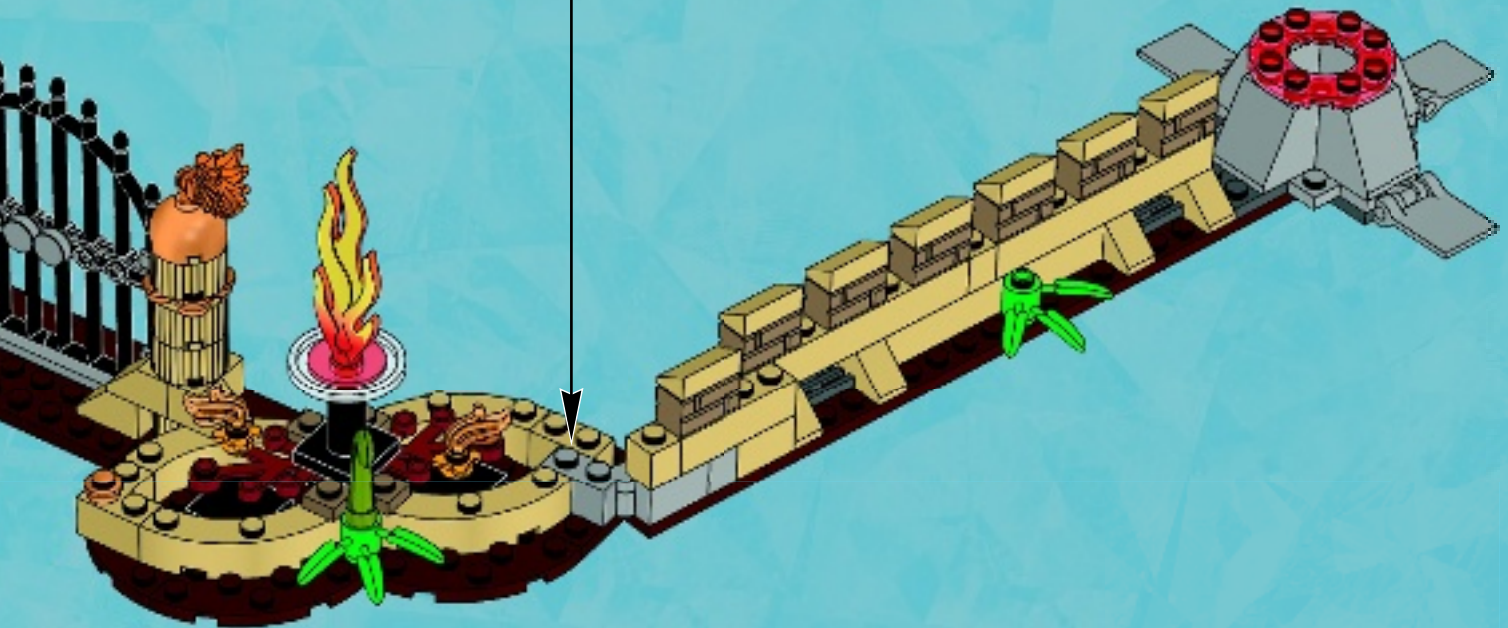
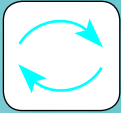



1x



1x

22

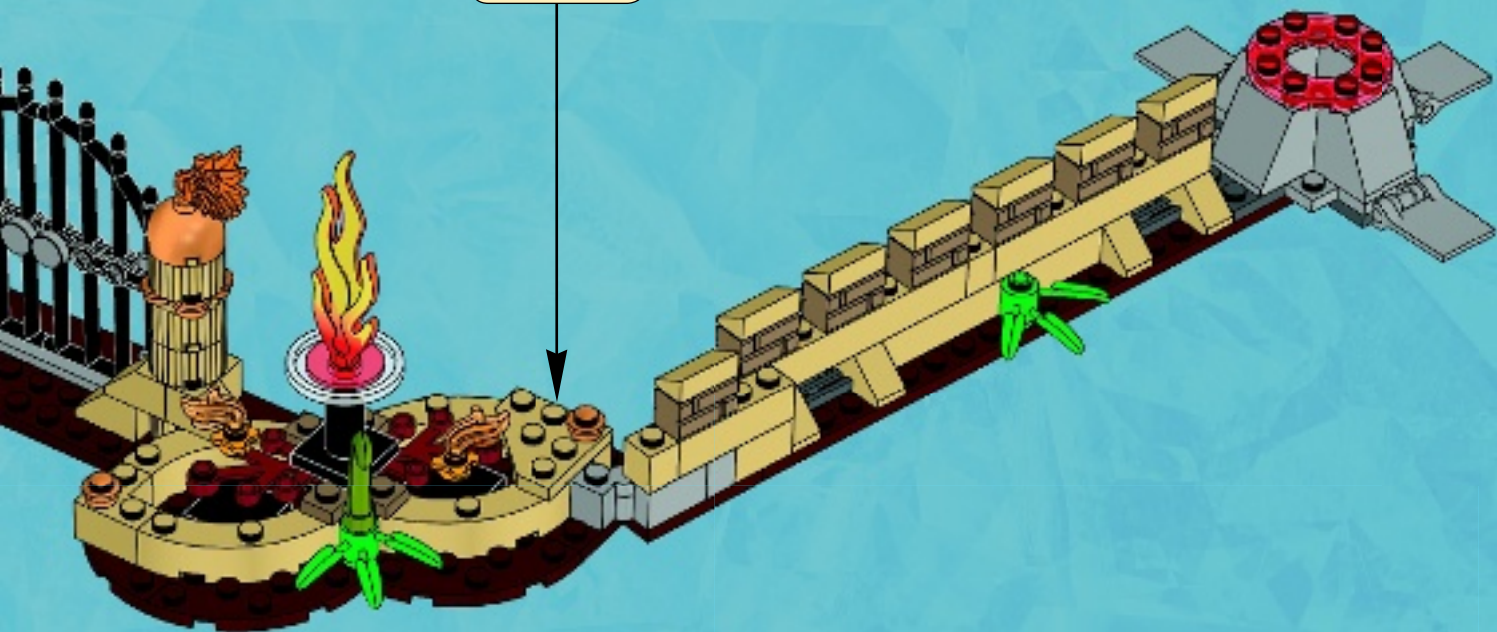

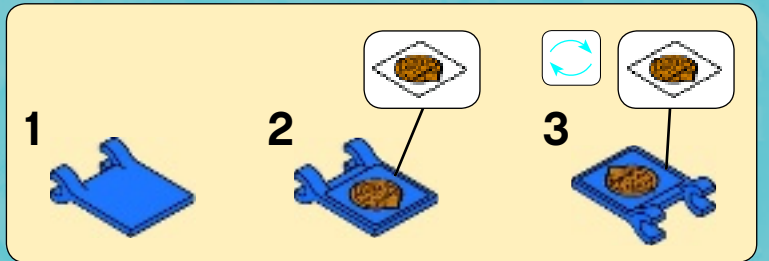
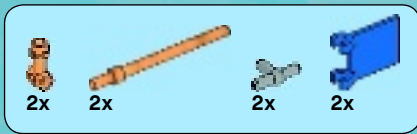

23



2x

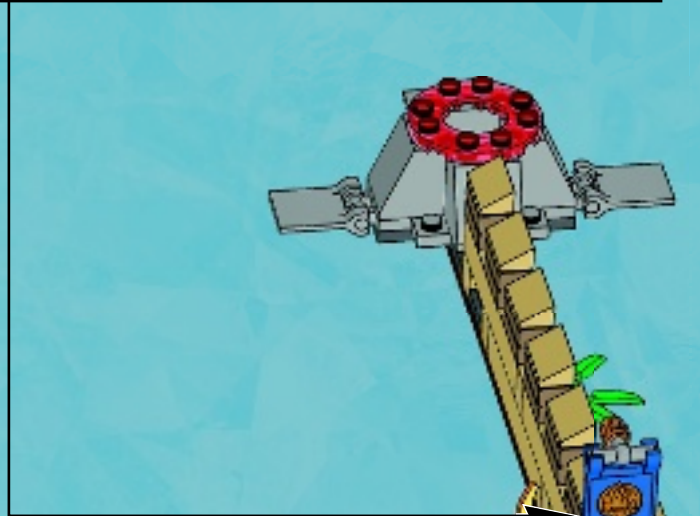
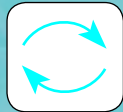

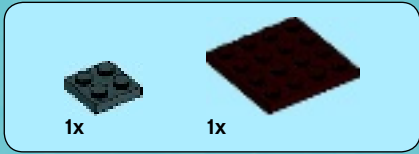

1



2



3

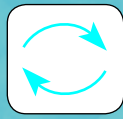



4x

4



4x



4x

5



4x



7x

6



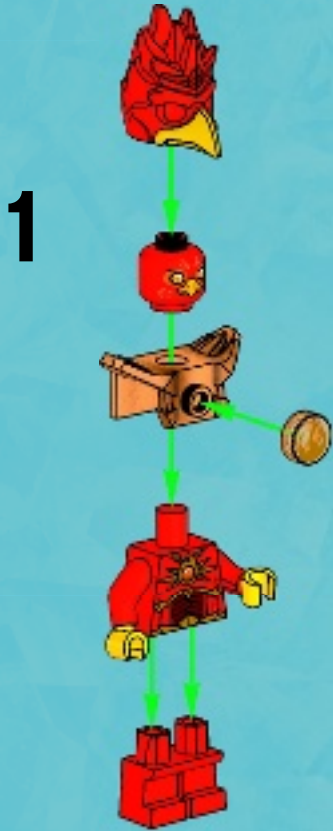

1

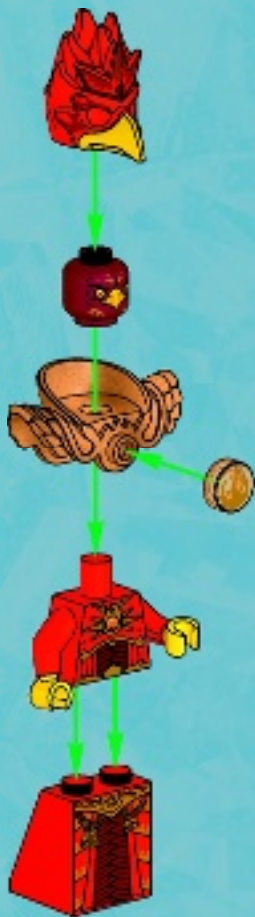

3



2

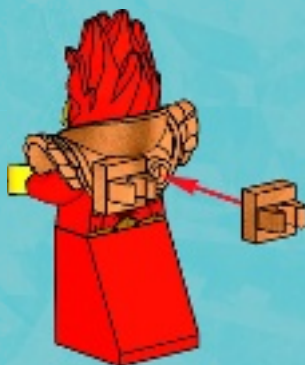

1

2

3

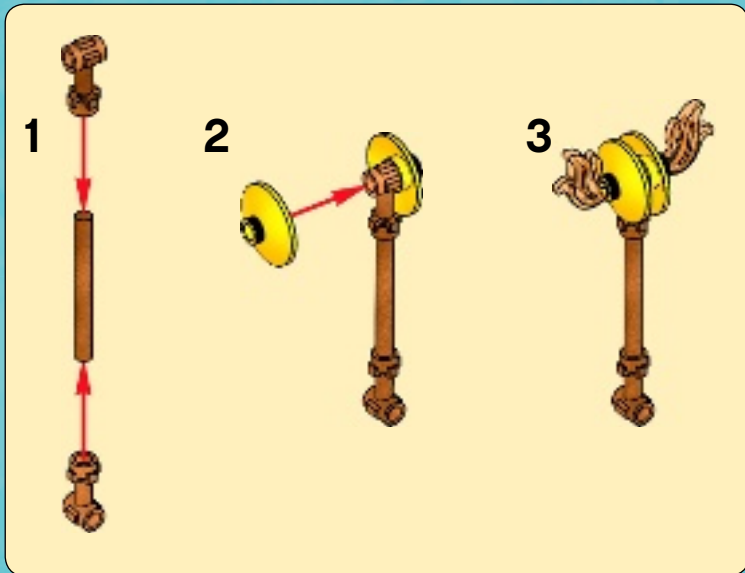

4



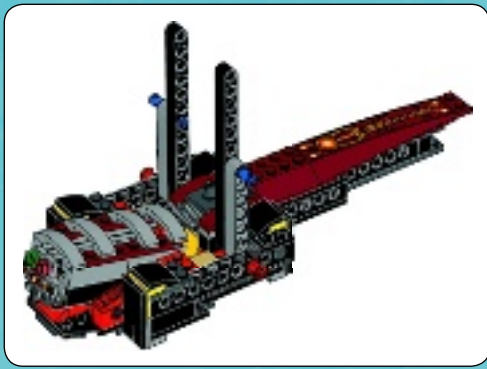

1

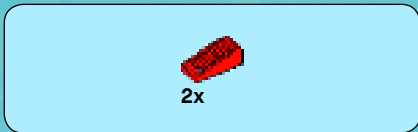

2

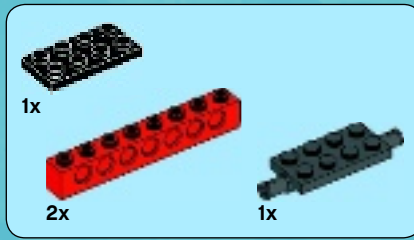

3

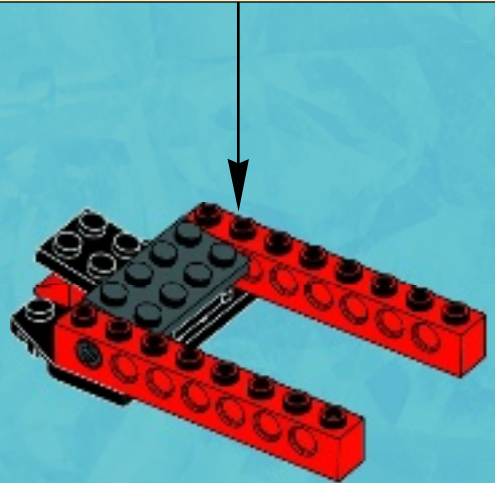
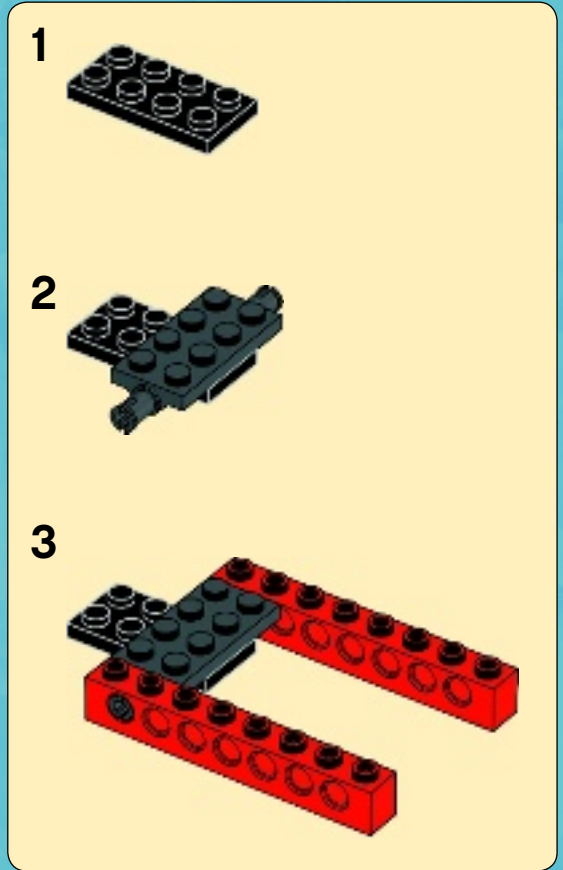



1x

4

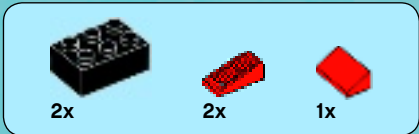
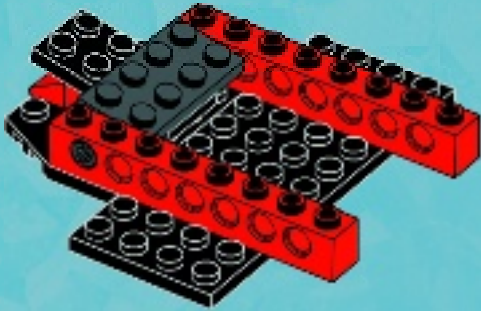

2x

2x

1x

5

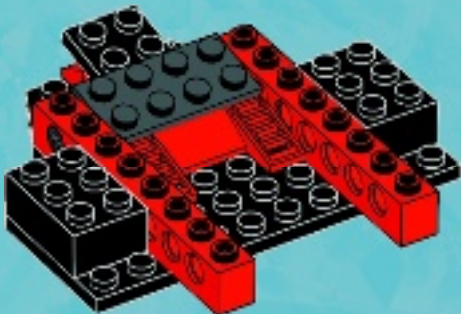

2x

6

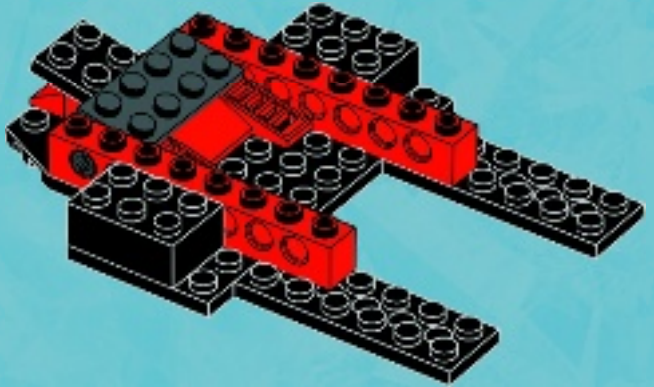

6x

2x

7

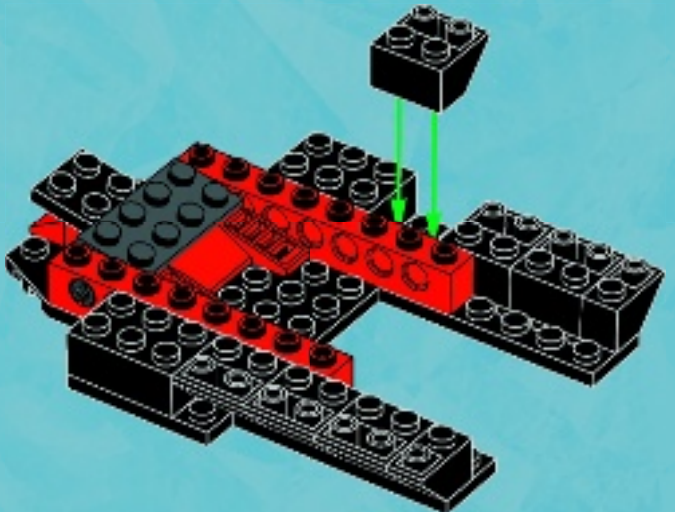



8

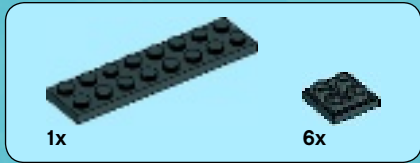
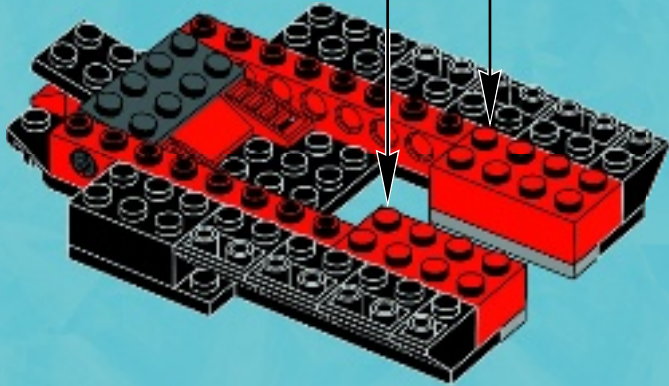
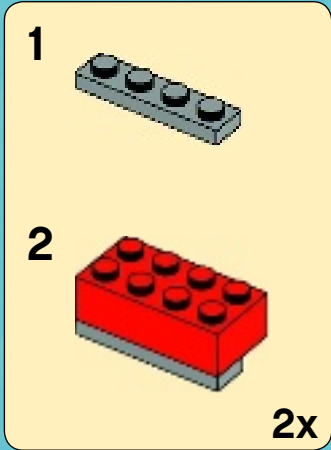

9

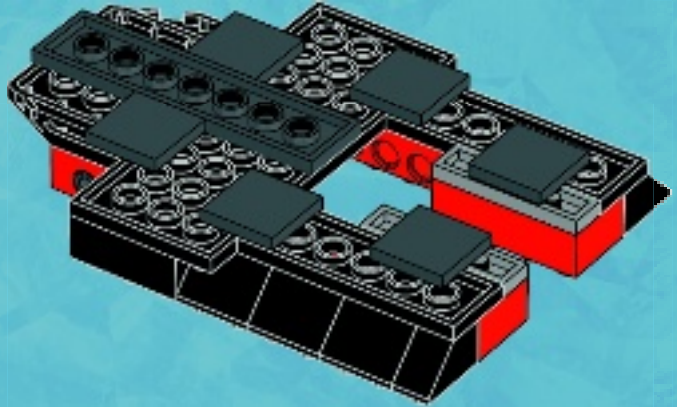

10

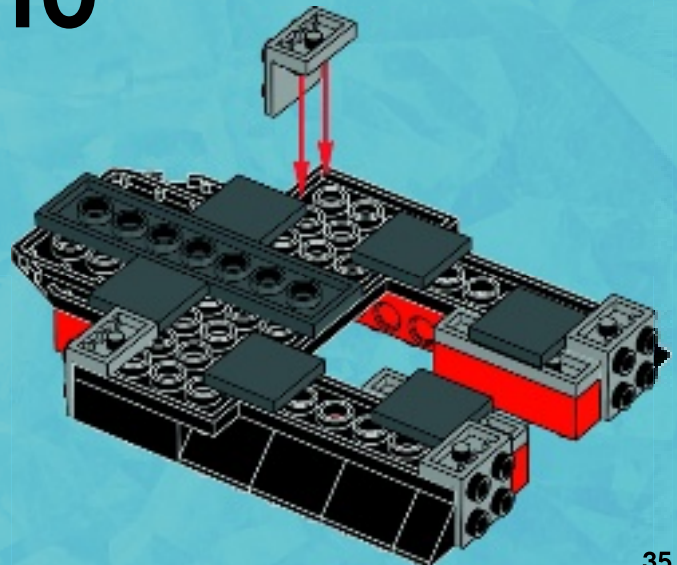



2x



2x

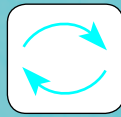

11

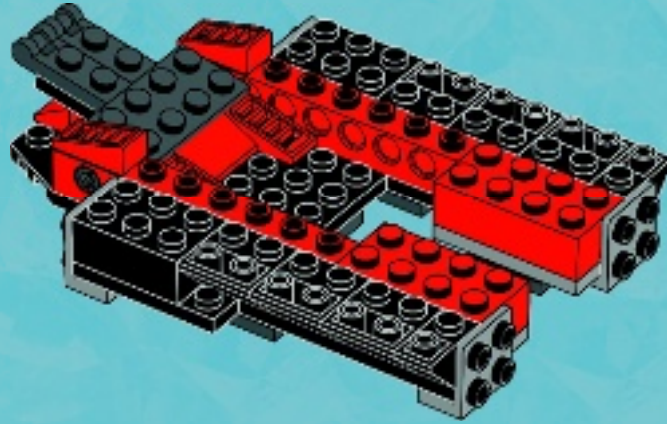

2x



2x



4x

12

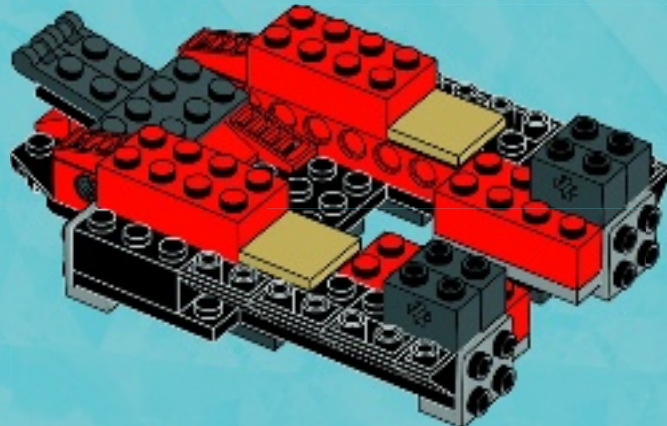

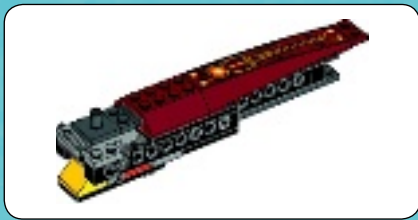

1



2

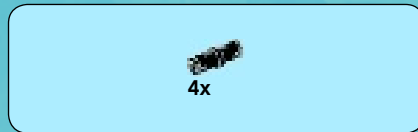

3

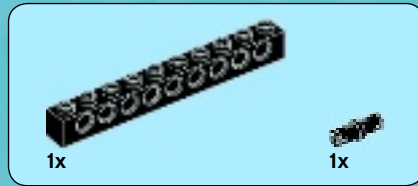

4

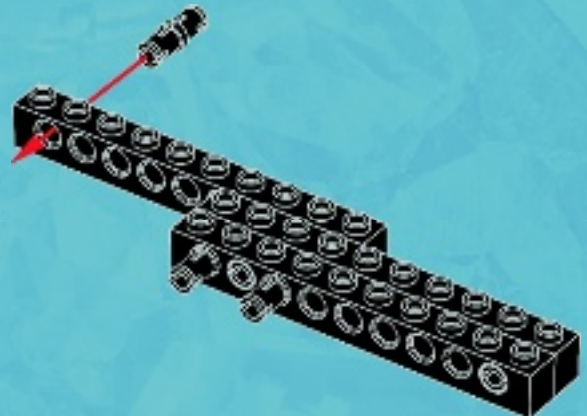

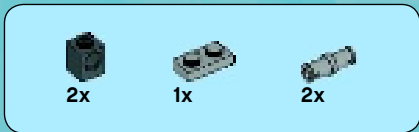

5

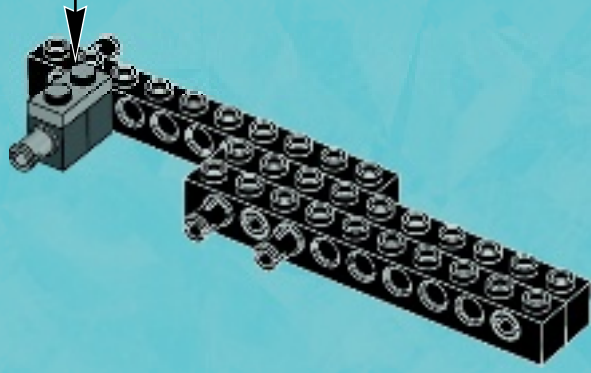
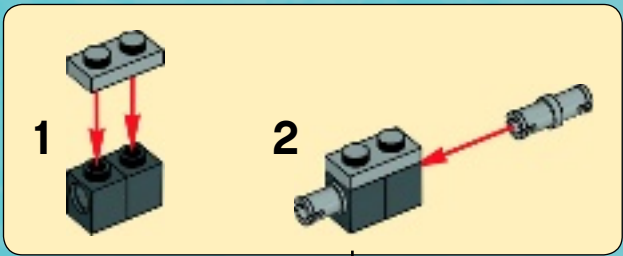

6

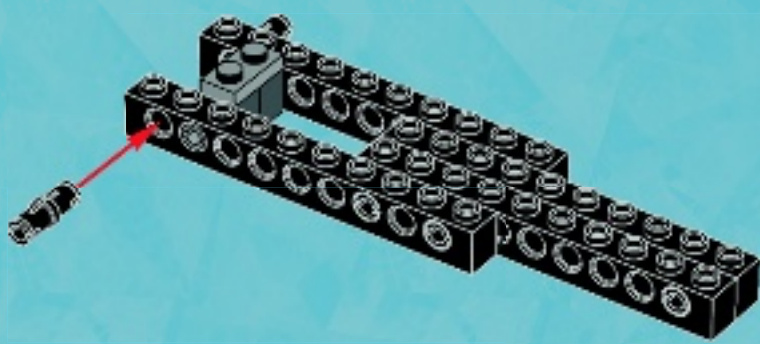

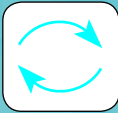
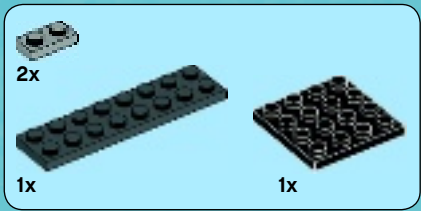

7

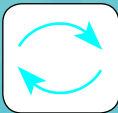
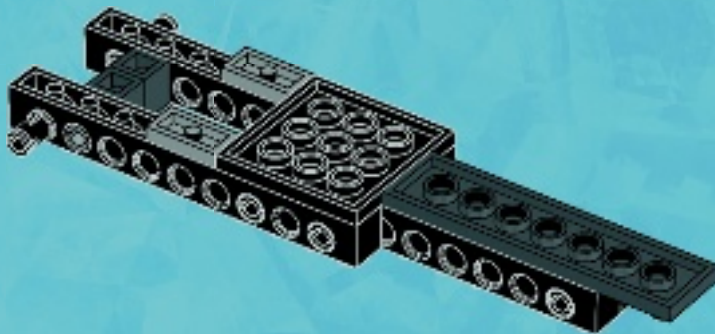

8

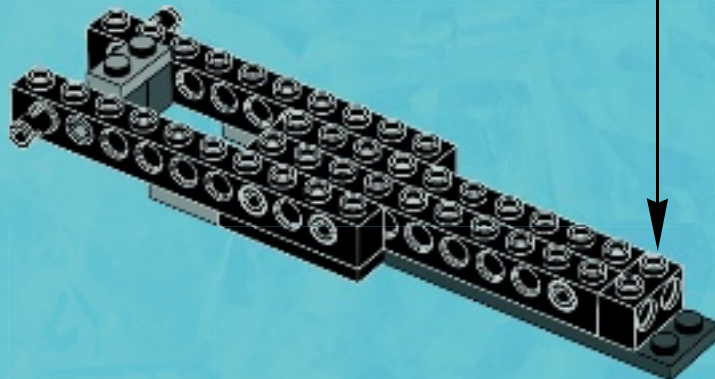

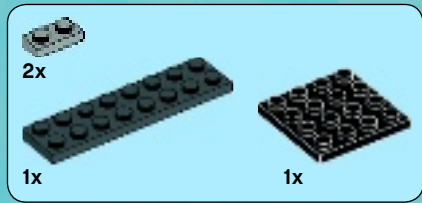

9

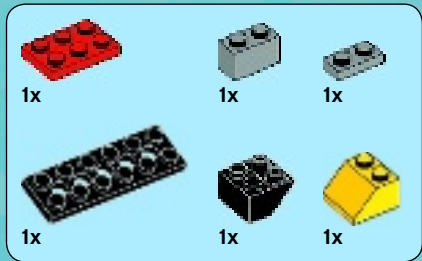
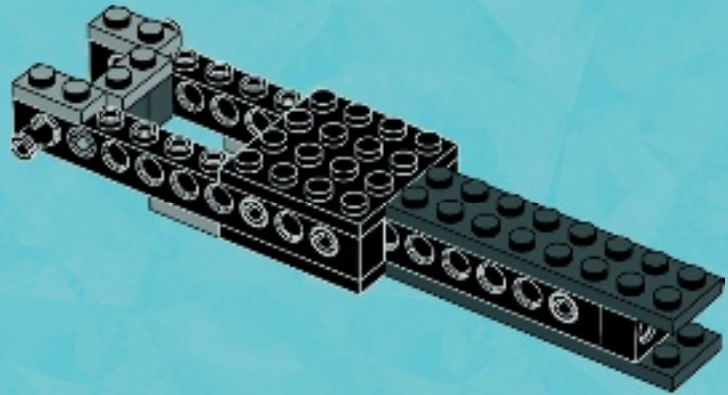

10

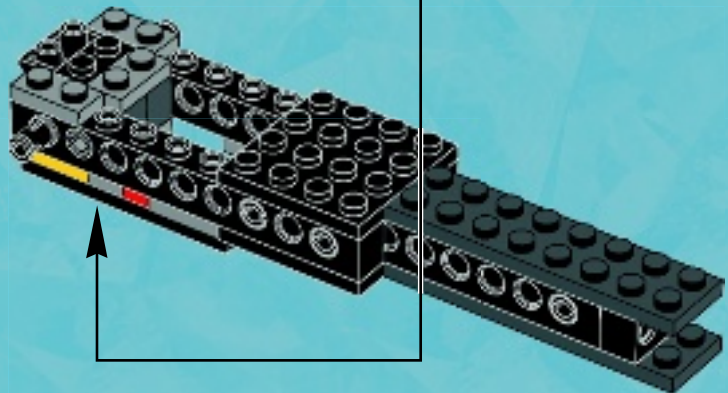
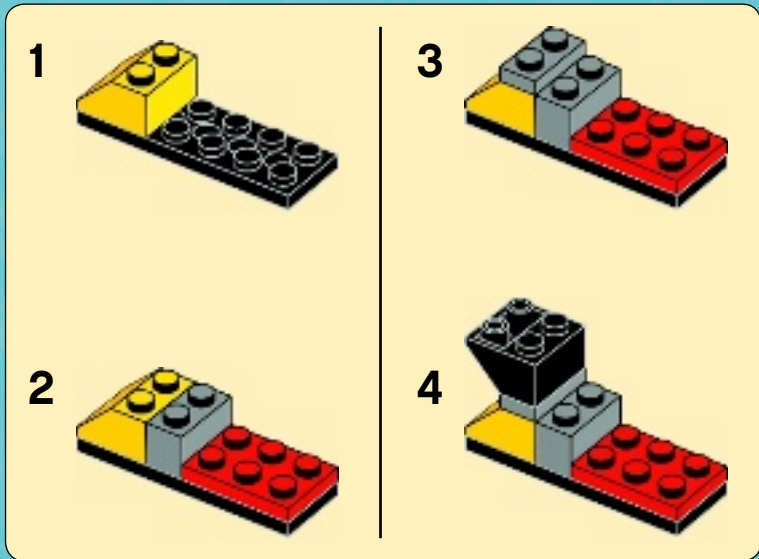

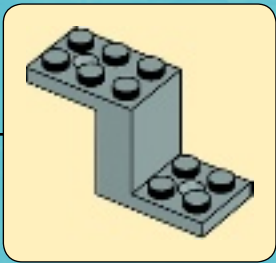
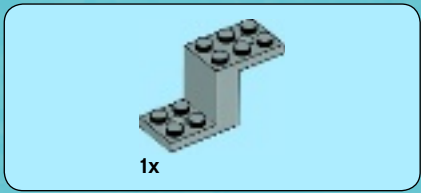

11

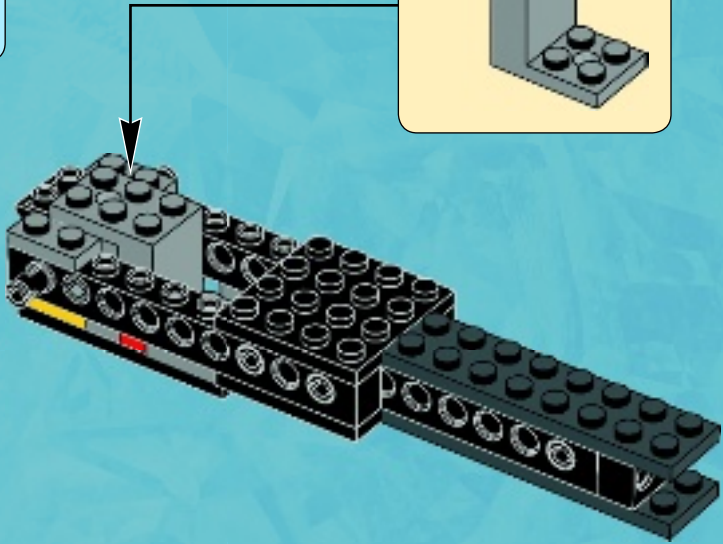

12

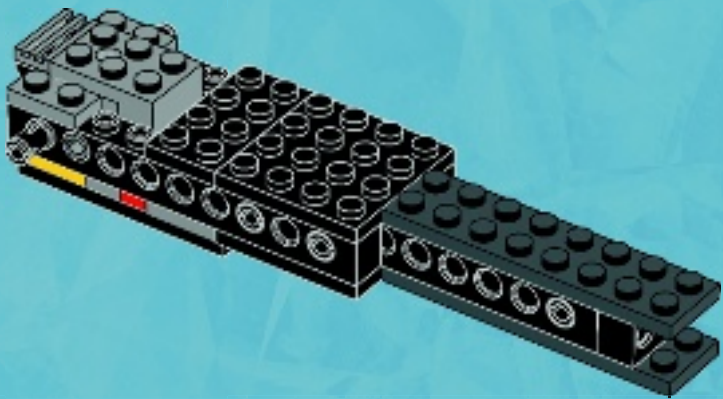

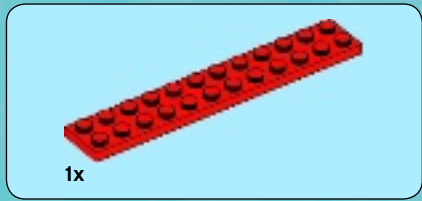

13

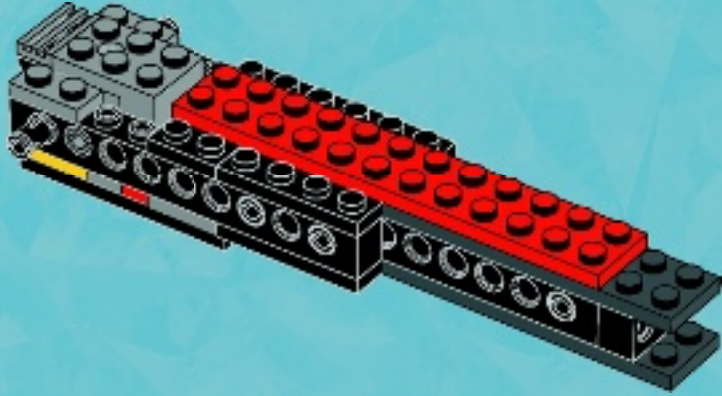

14

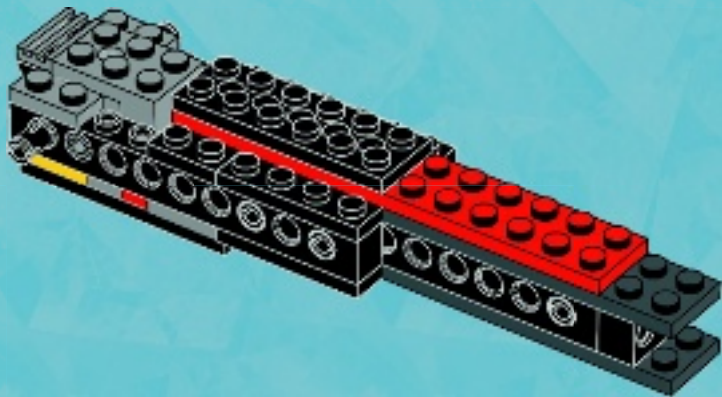

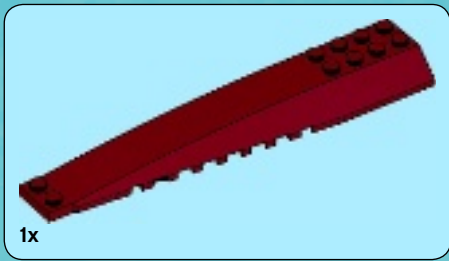

15

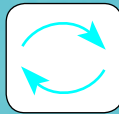
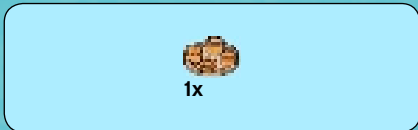
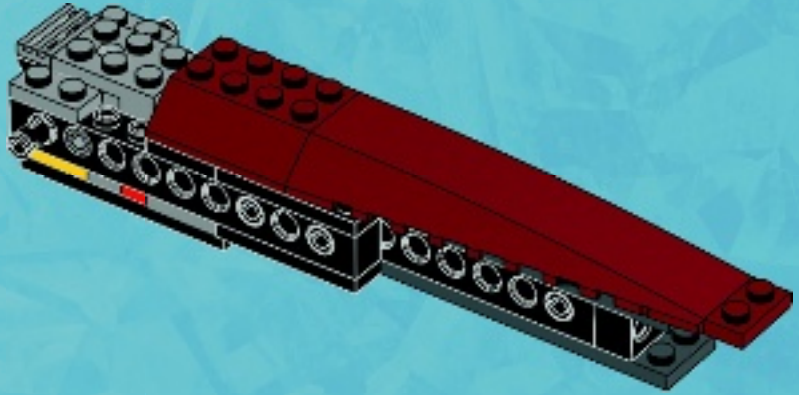

16

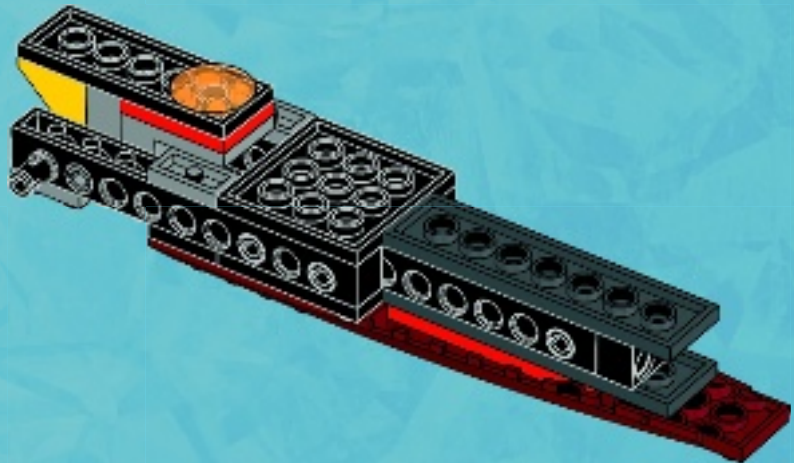



17

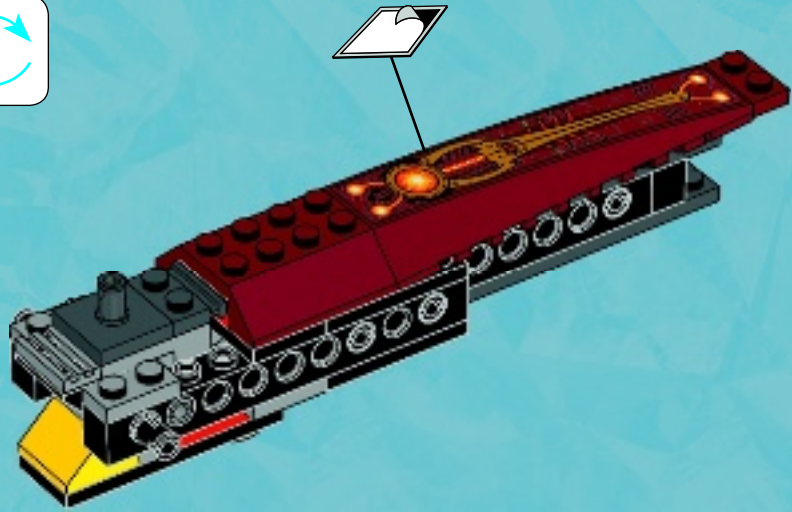

18

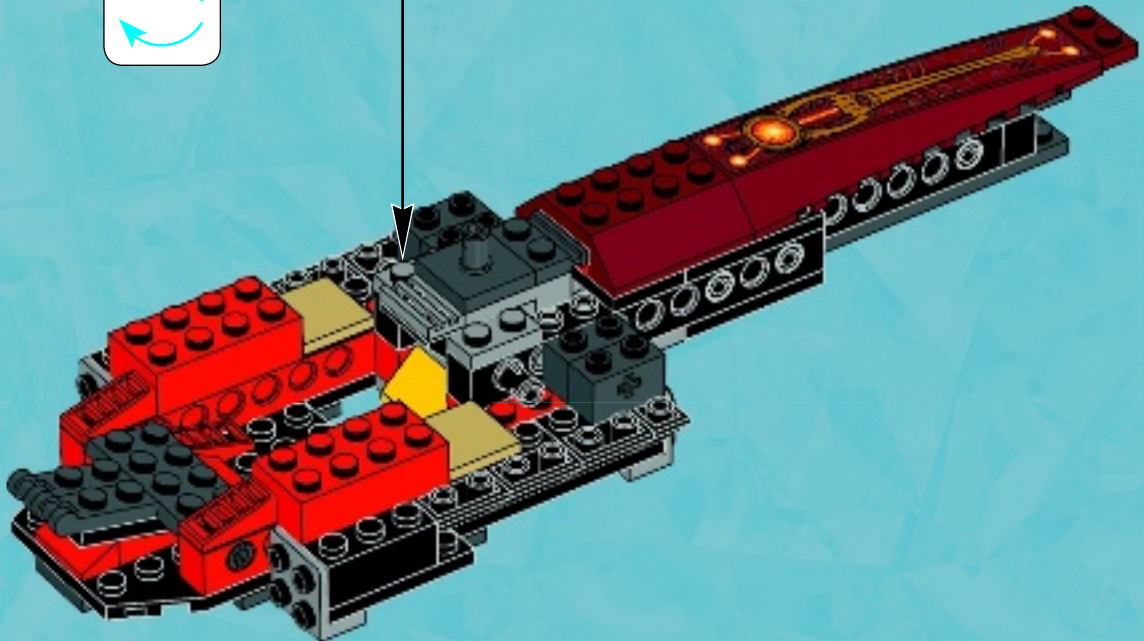

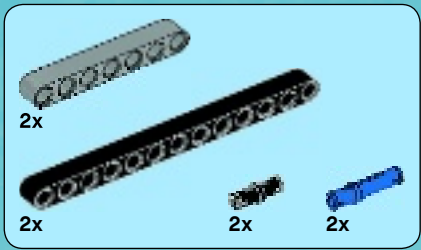

19

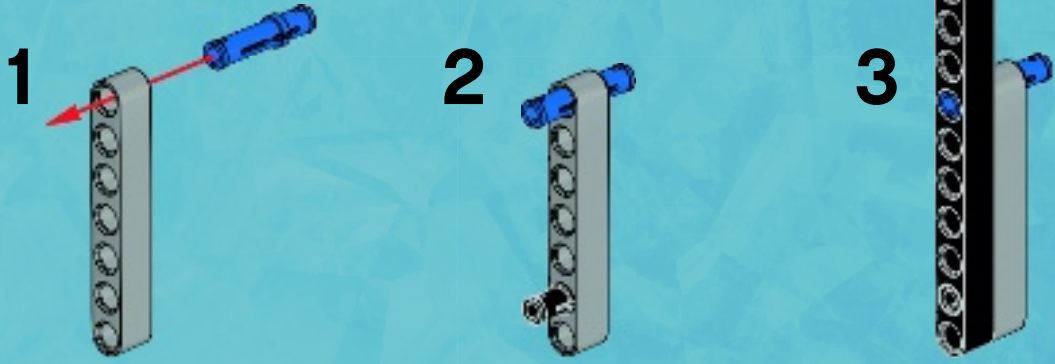

2x

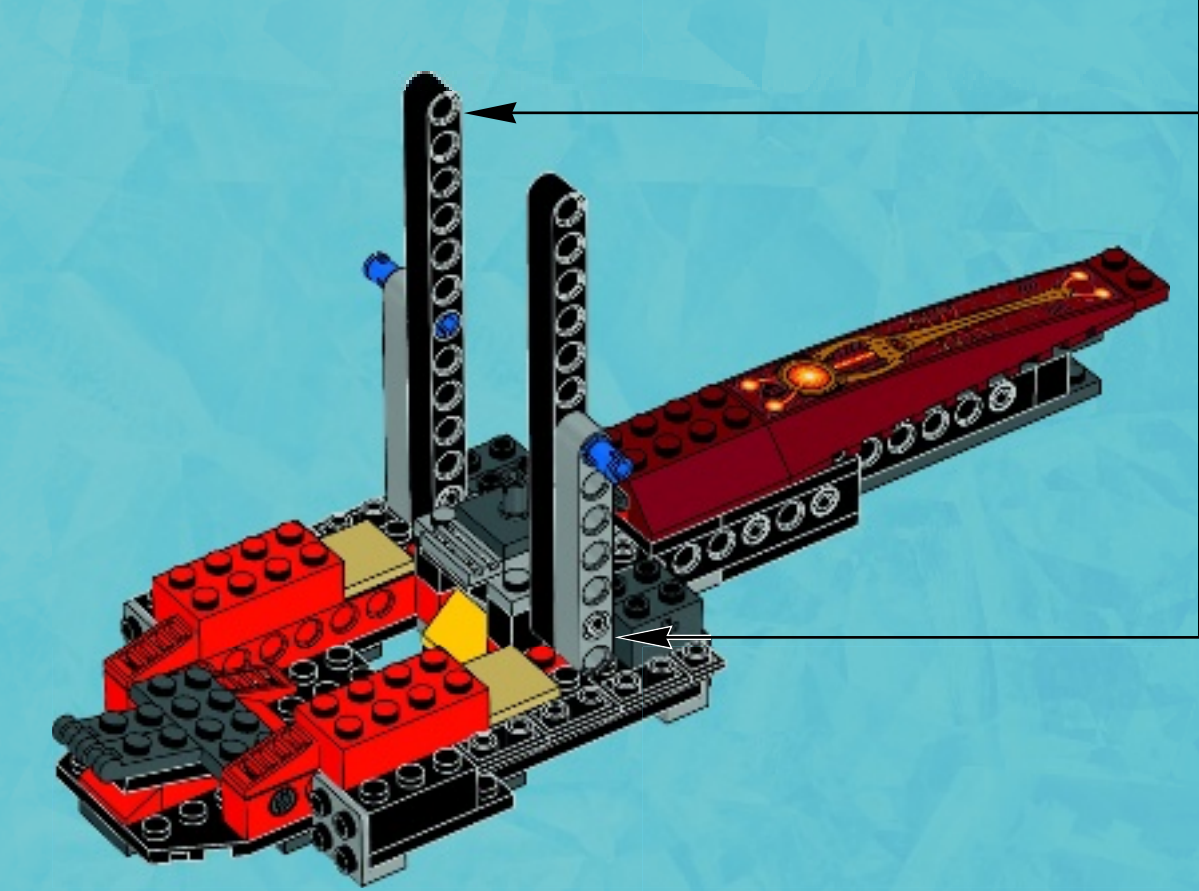



20

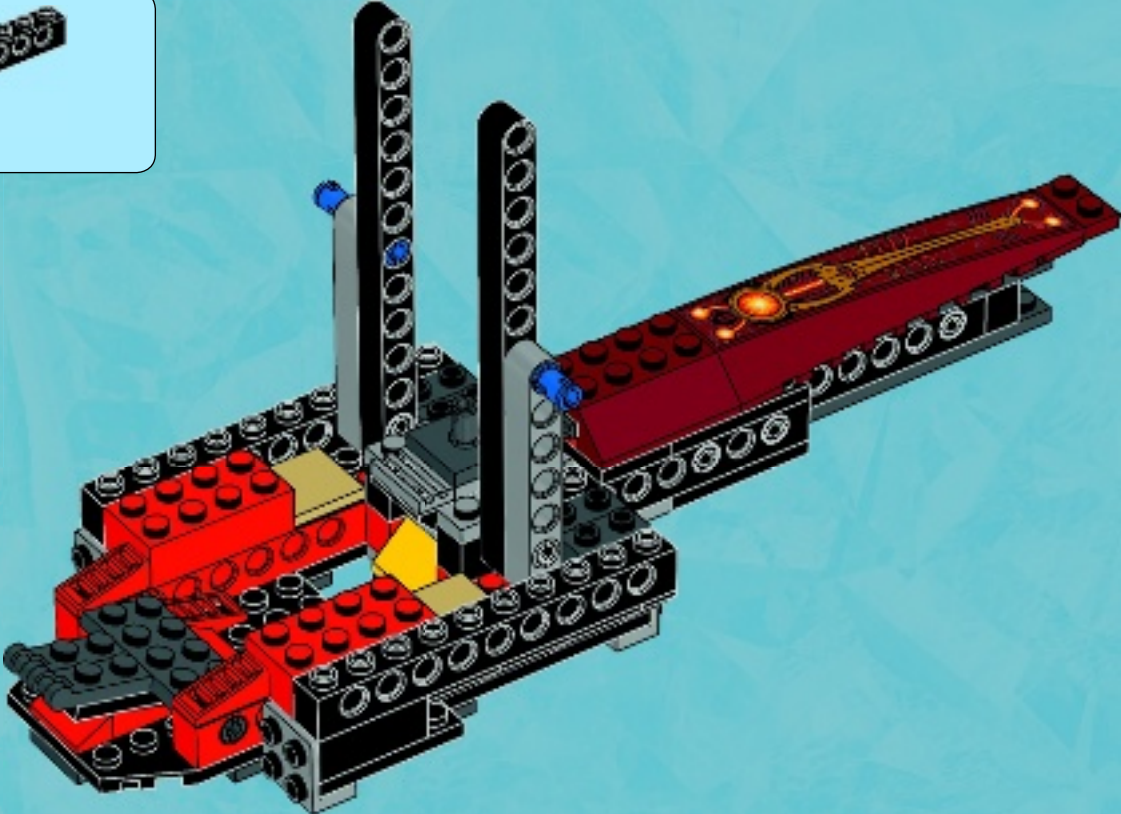

21

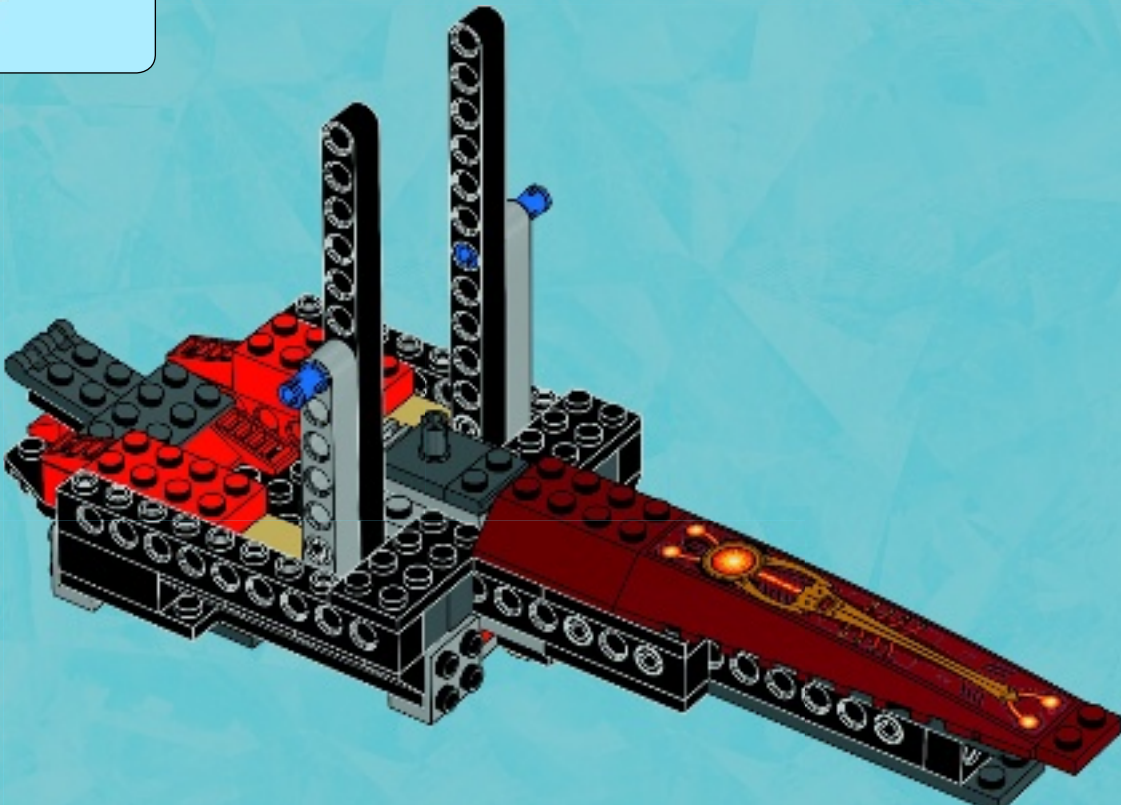
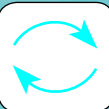

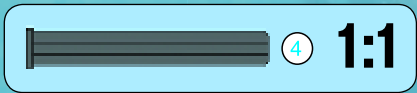
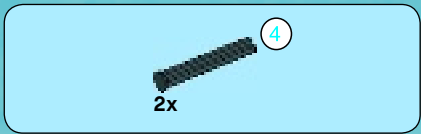

22

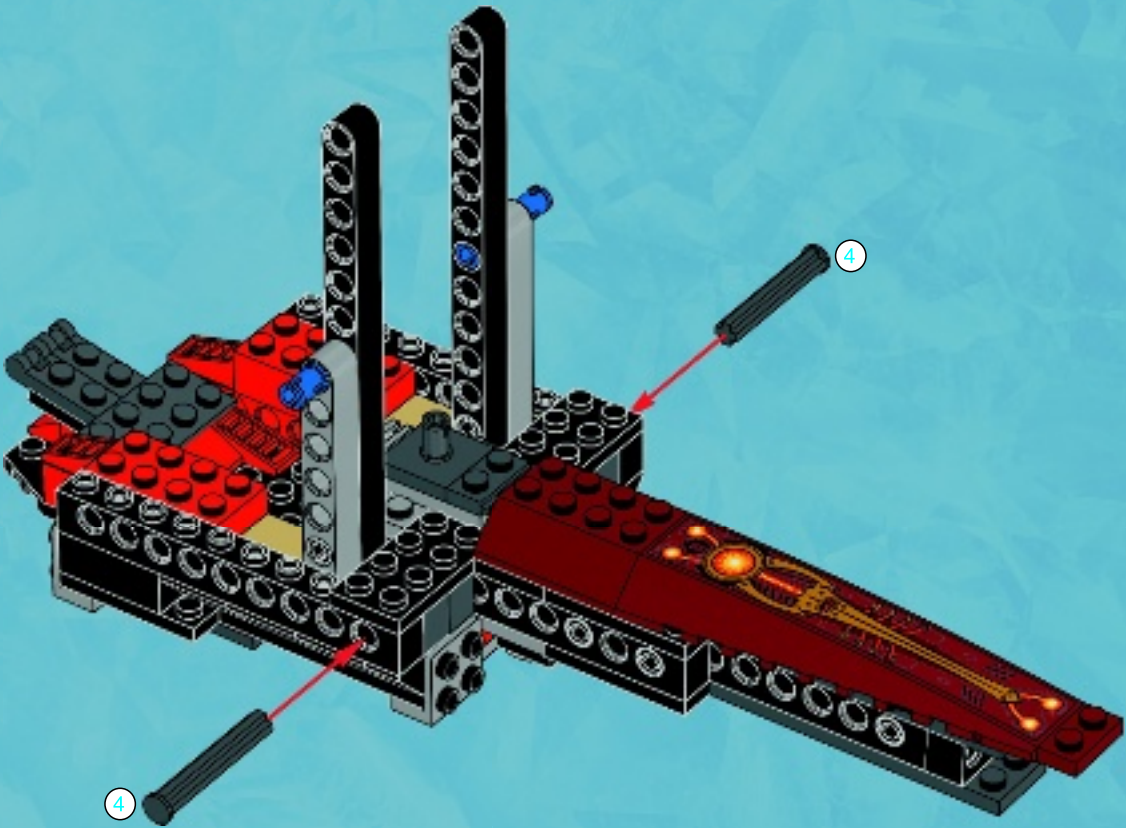



2x

23

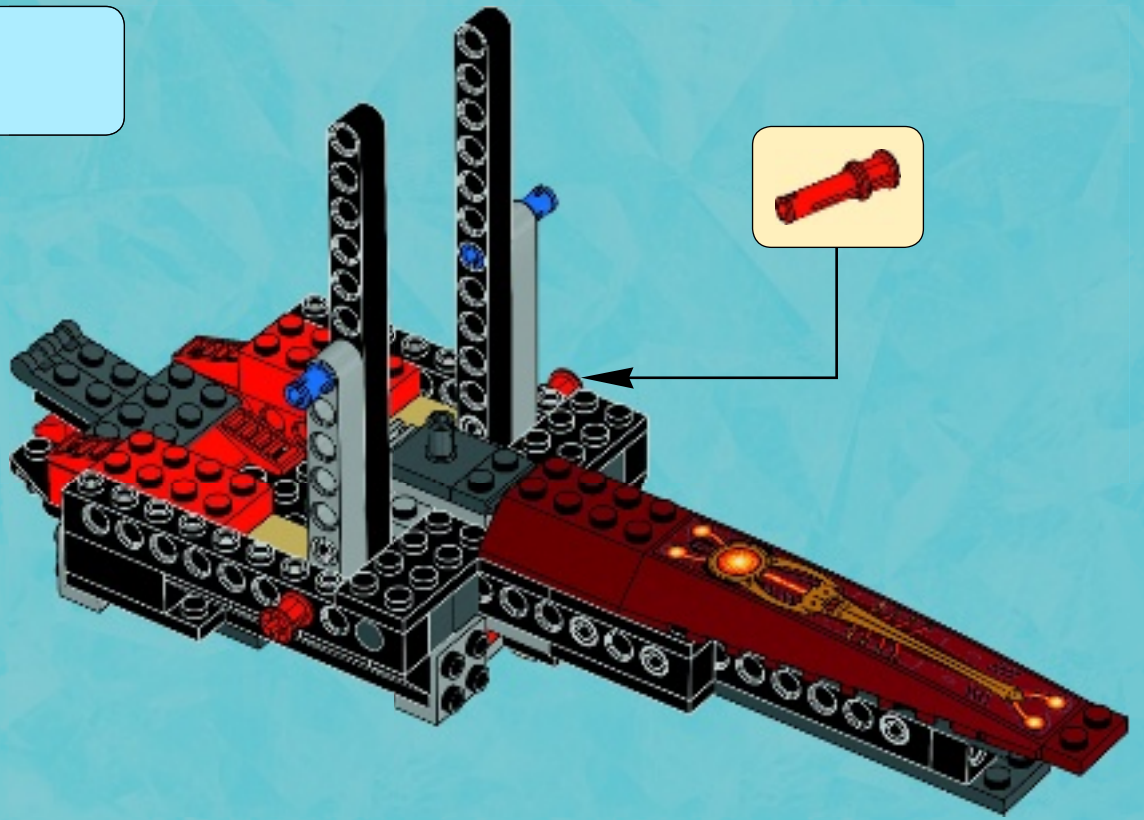

2x



2x



2x

24

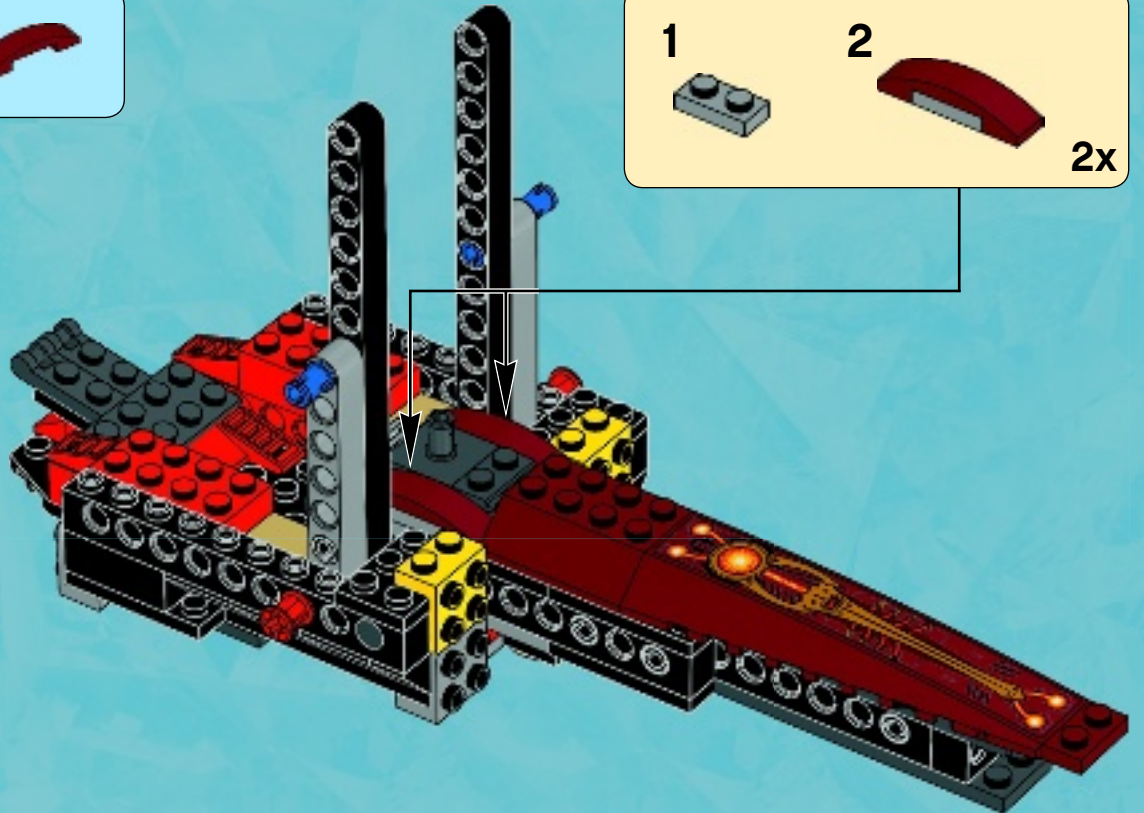

1

2

2x



4x



2x

25

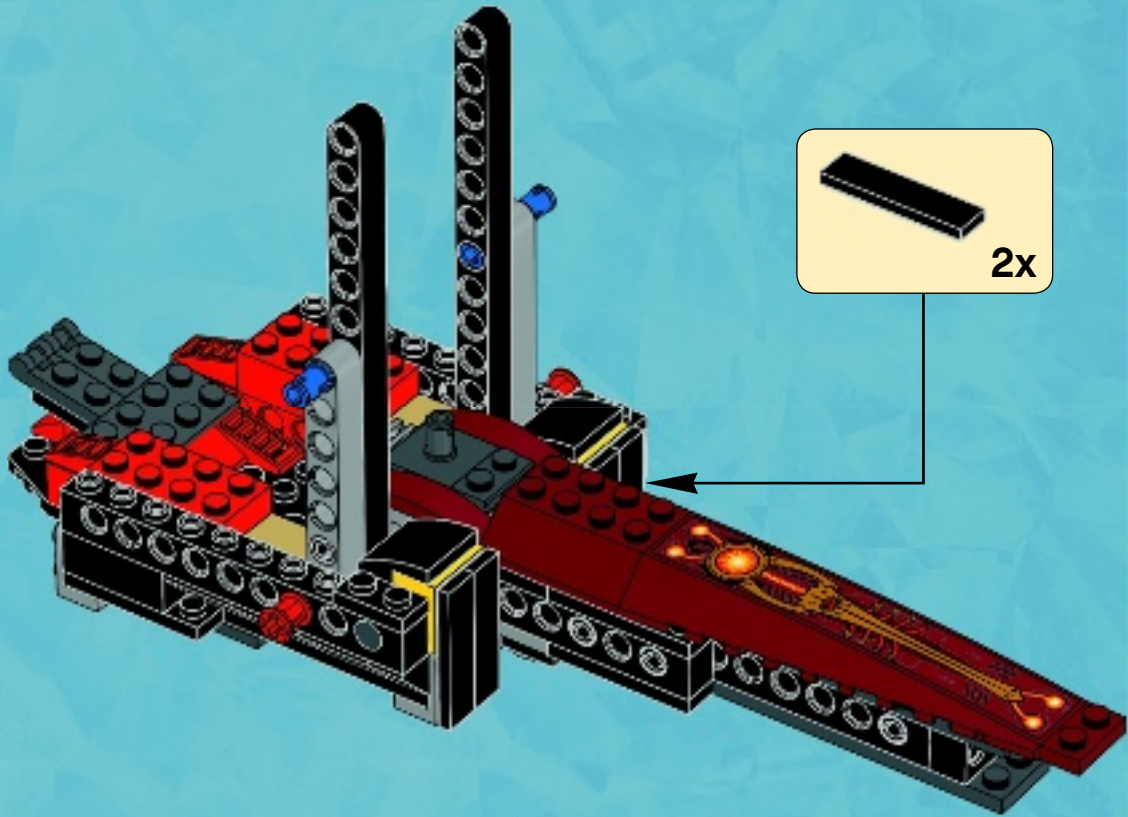

2x



2x

26

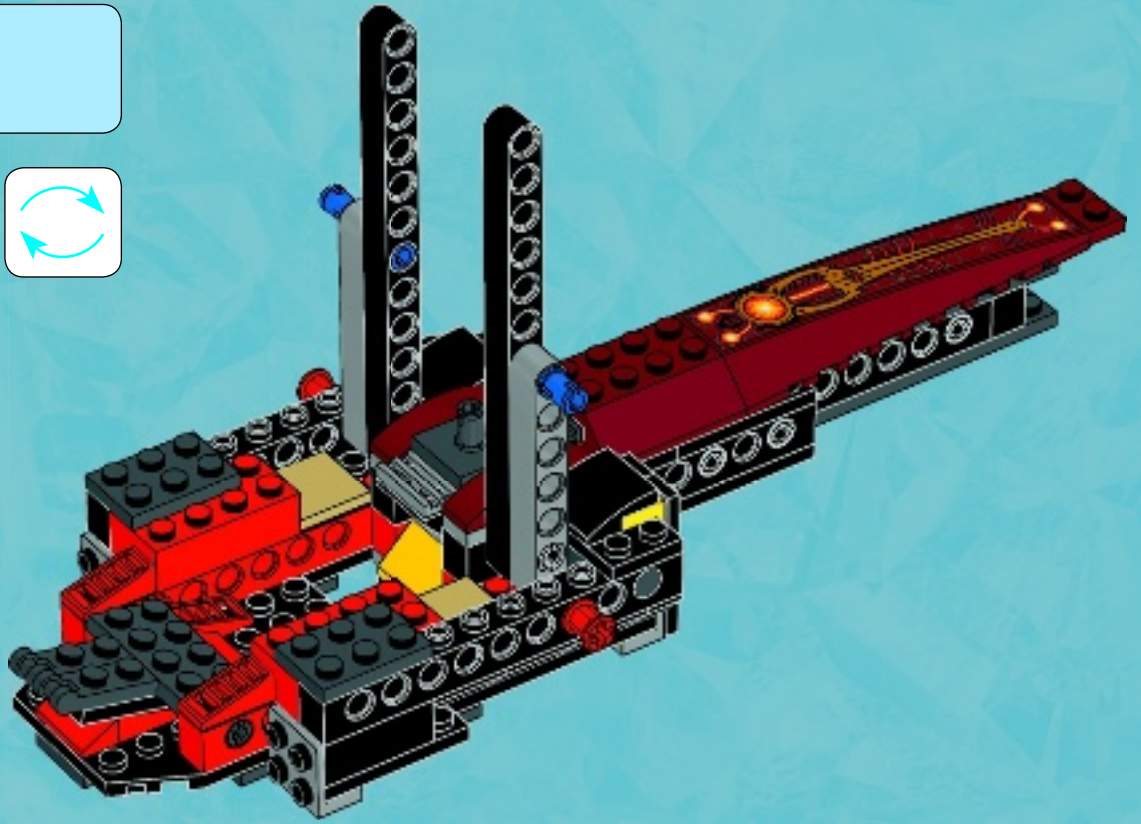

2x

27

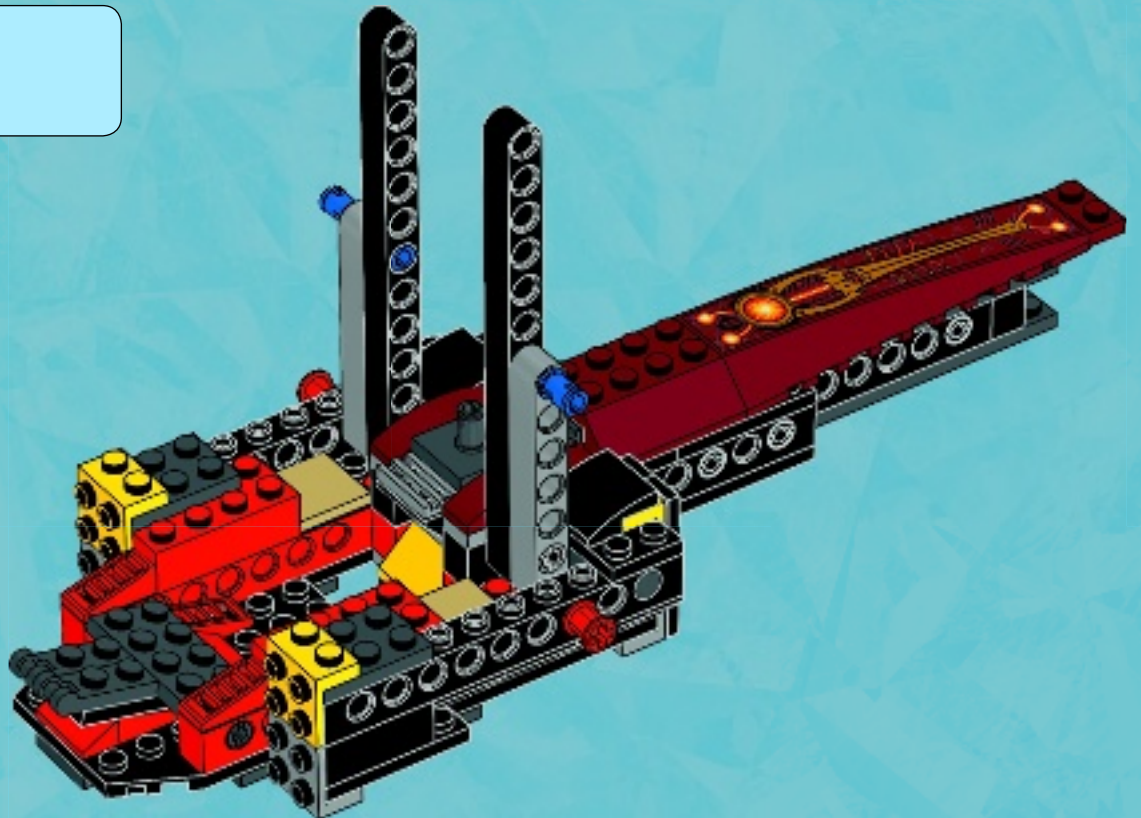



28

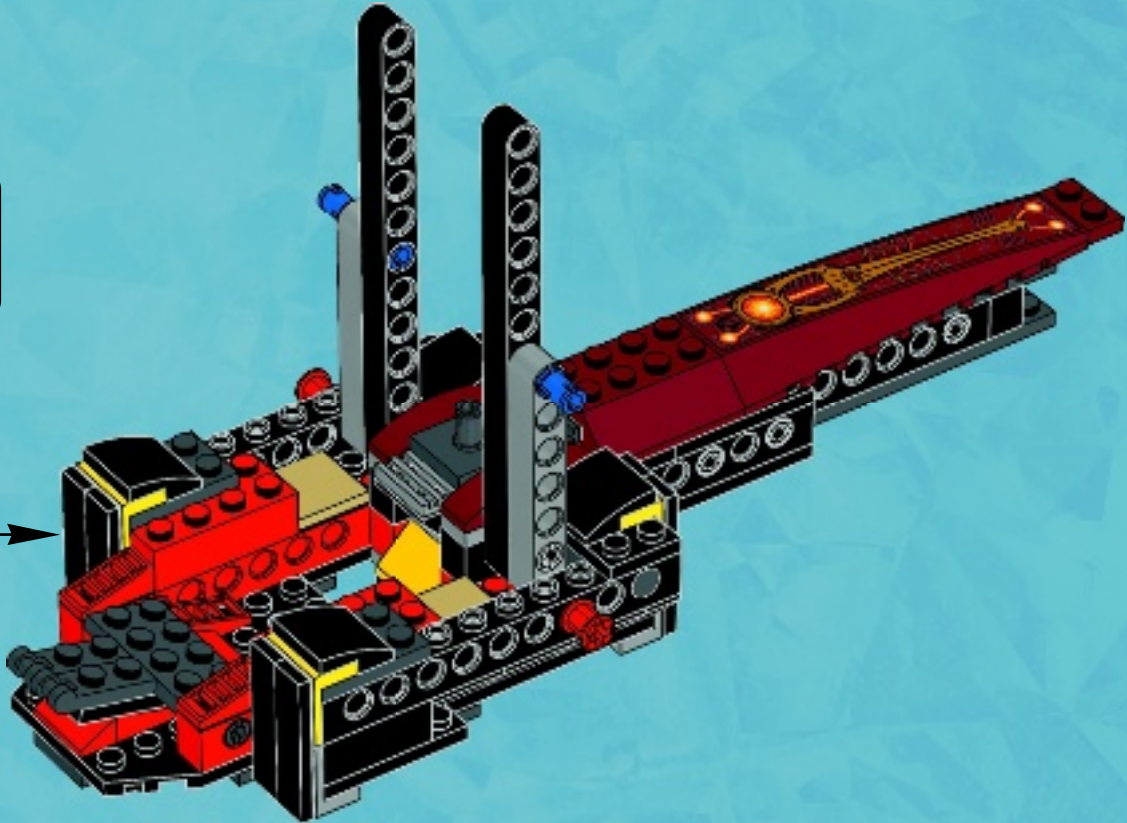
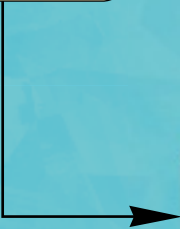
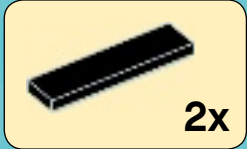

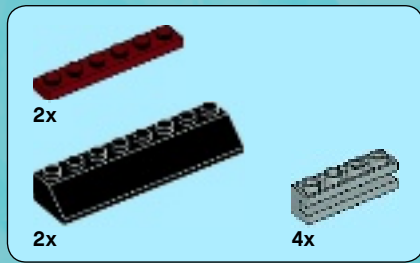

29

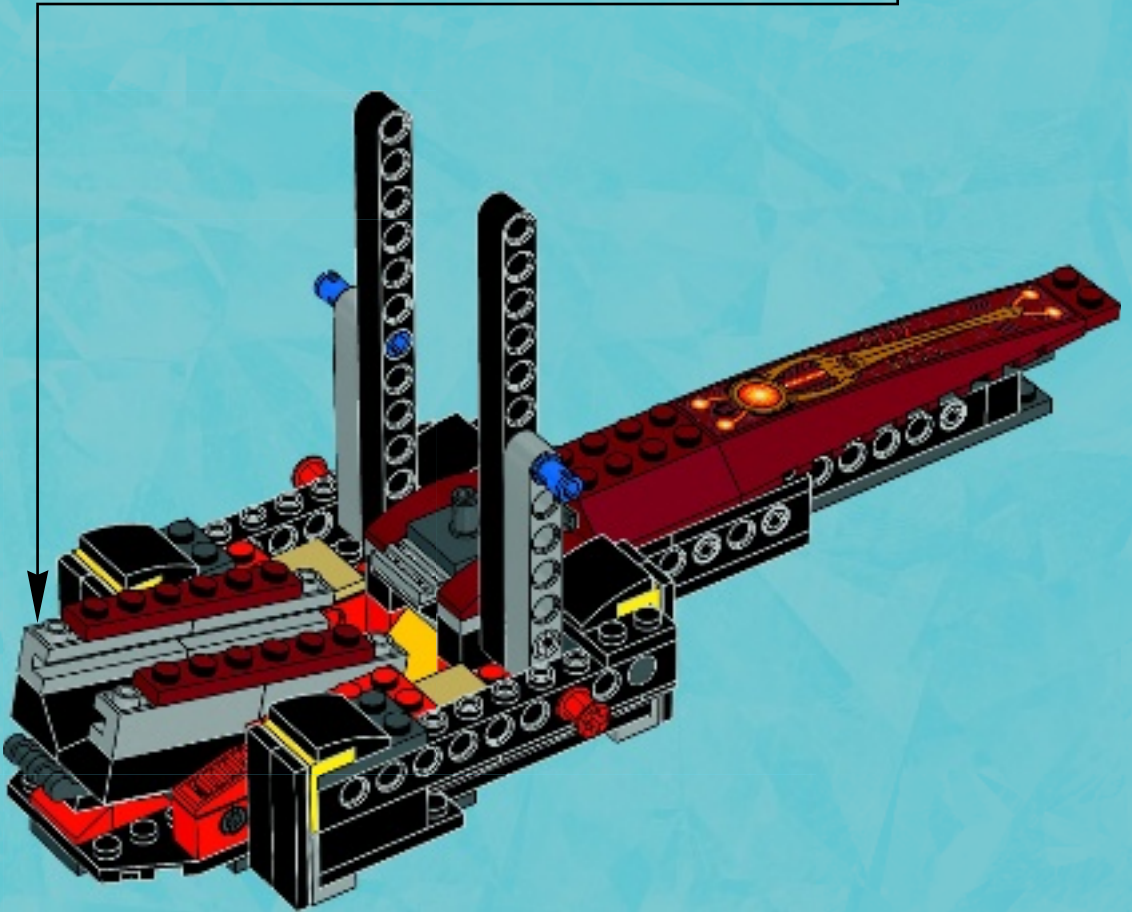
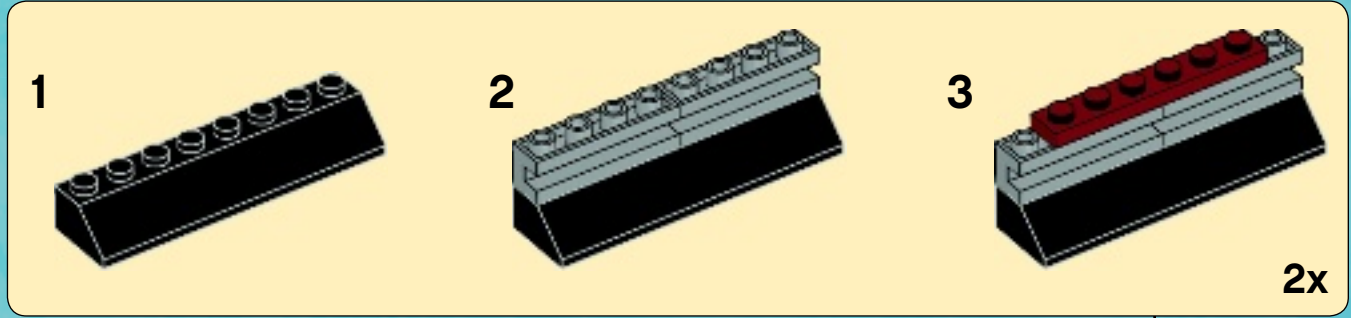



2x



1x

30

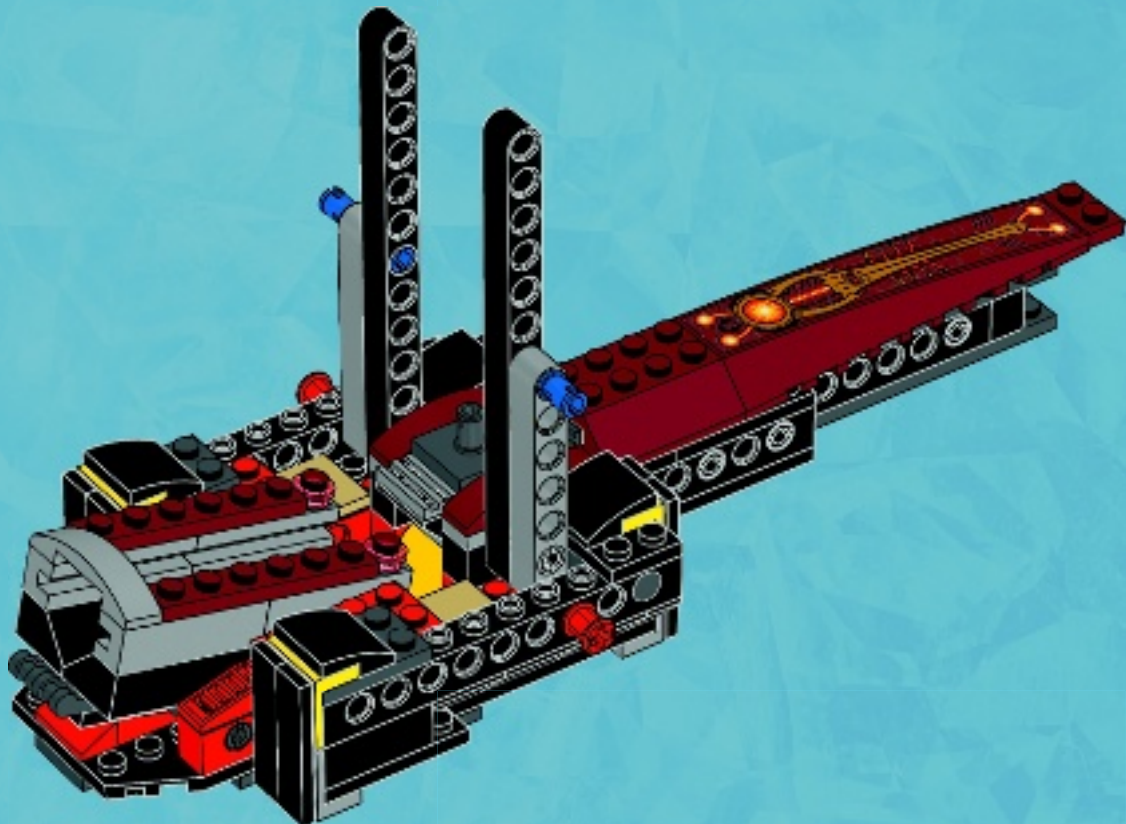



31

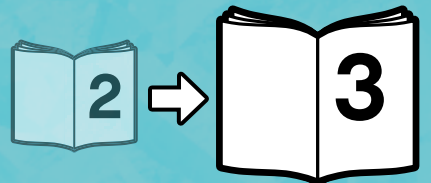
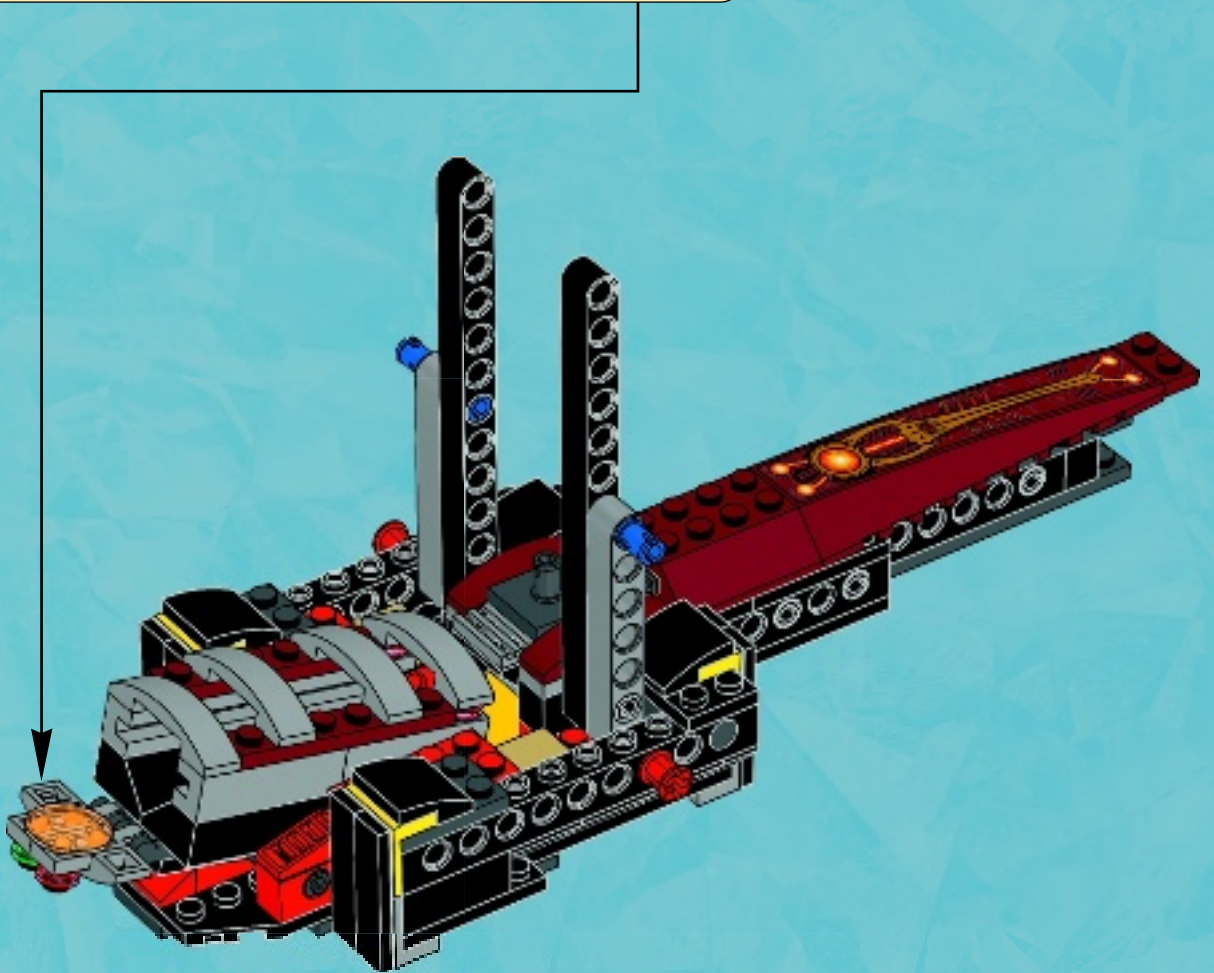



LEGENDS OF CHIMA™

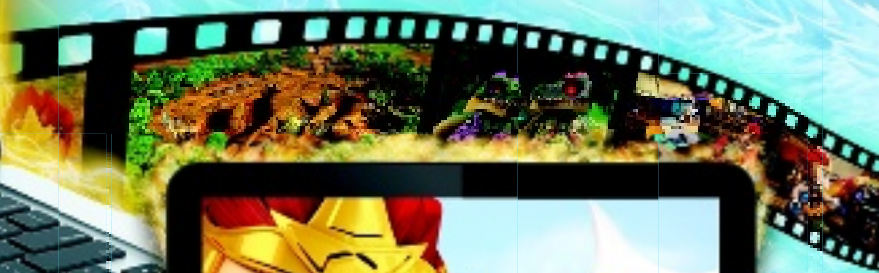

LEGO.COM/CHIMA

...Or visit: - Ou visitez : - O visita:



Apple, the Apple logo, iPad, iPhone and iPod touch are trademarks of Apple Inc., registered in the U.S. and other countries. App Store is a service mark of Apple Inc./Apple, le logo Apple, iPad, iPhone et iPod touch sont des marques de commerce d'Apple Inc., déposées aux États-Unis et dans d'autres pays. App Store est une marque de service d'Apple Inc./Apple, el logotipo de Apple, iPad, iPhone e iPod touch son marcas comerciales de Apple Inc. registradas en EE. UU. y otros países. App Store es una marca de servicio de Apple Inc.
Google Play is a trademark of Google Inc./Google Play est une marque de commerce de Google Inc./Google Play es una marca comercial de Google Inc.

NEW APP!
DOWNLOAD
NOW!

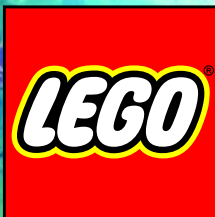

LEGENDS OF CHIMA ONLINE™

NOUVELLE APP!
TÉLÉCHARGER
MAINTENANT!



CHIMAONLINE.COM

© 2014 The LEGO Group.™ & © WBEI. (s14)
Only supported in US and Canada. Playable on iPad 2 and up, iPad mini, iPhone 4S and up and iPod touch 5th generation and up. Apple, the Apple logo and iPad are trademarks of Apple Inc., registered in the U.S. and other countries. App Store is a service mark of Apple Inc. All other trademarks and copyrights are the property of their respective owners.

Offert uniquement aux États-Unis et au Canada. Fonctionne sur iPad 2 et supérieur, iPad mini, iPhone 4S et supérieur et iPod touch 5e génération et supérieur. Apple, le logo Apple, et iPad sont des marques de commerce d'Apple Inc., déposées aux États-Unis et dans d'autres pays. App Store est une marque de service d'Apple Inc. Toutes les autres marques de commerce et copyrights appartiennent à leurs propriétaires respectifs.

Sólo válido en EE.UU. y Canada. Compatible con iPad 2 y modelos posteriores, iPad mini, iPhone 4S y modelos posteriores, e iPod touch de 5a generación y modelos posteriores. Apple, el logotipo de Apple e iPad son marcas comerciales de Apple Inc., registradas en EE.UU. y otros países. App Store es una marca de servicio de Apple Inc. El resto de marcas comerciales y derechos de autor son propiedad de sus respectivos propietarios.