

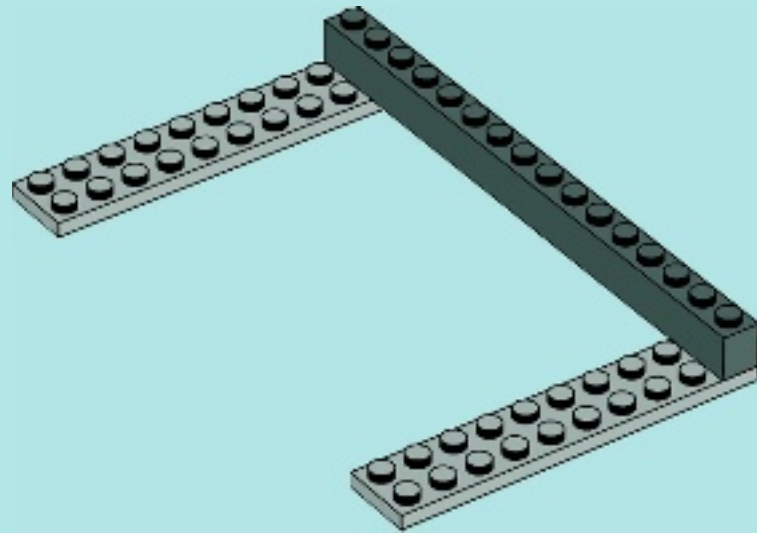

LEGENDS OF CHIMA™

70010

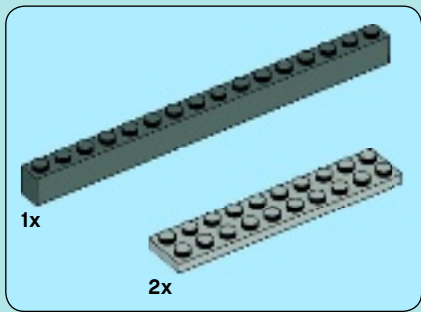

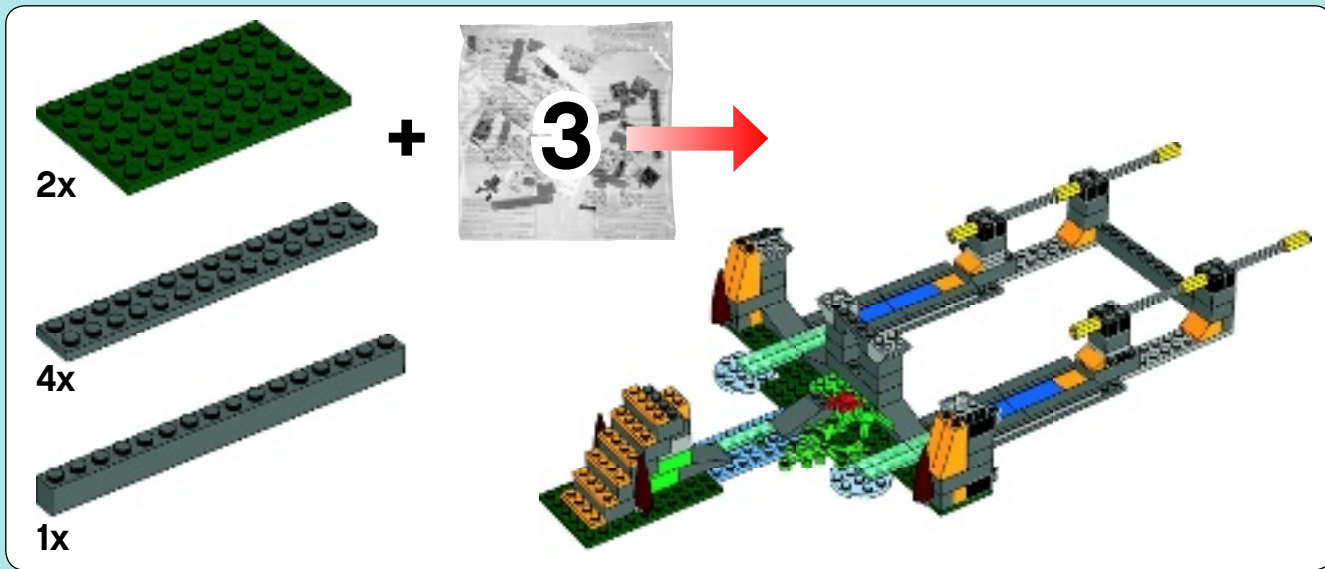



2

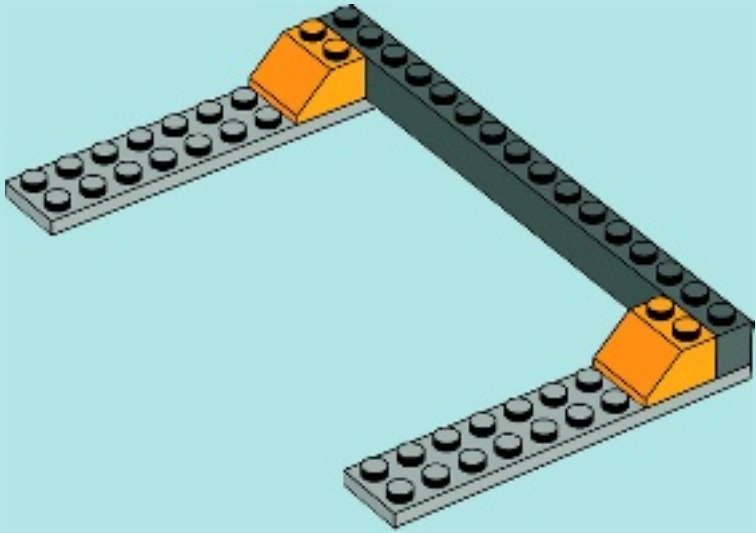

3

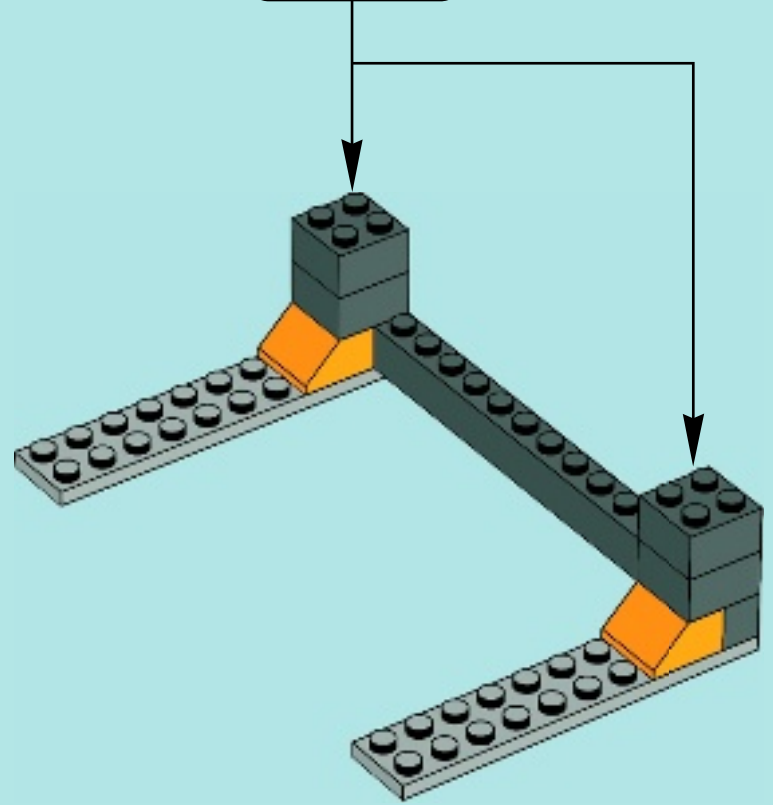
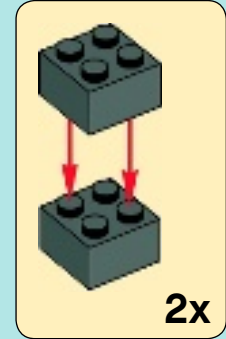

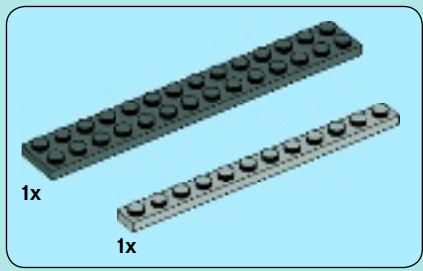

1

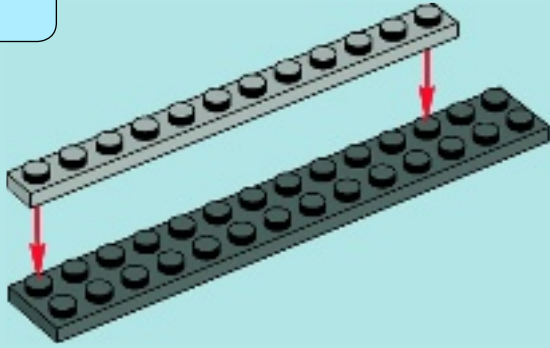

2

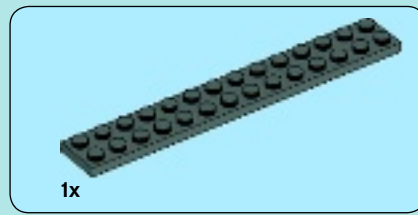
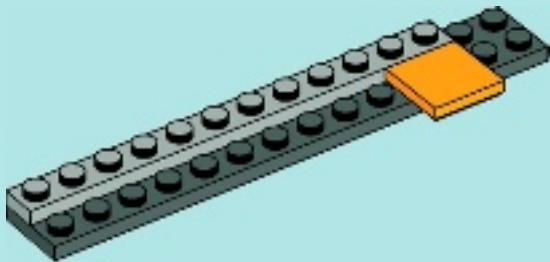

3

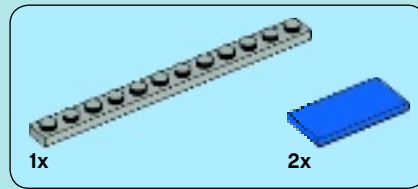
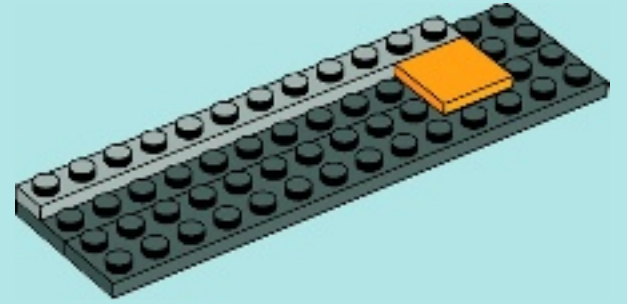

4

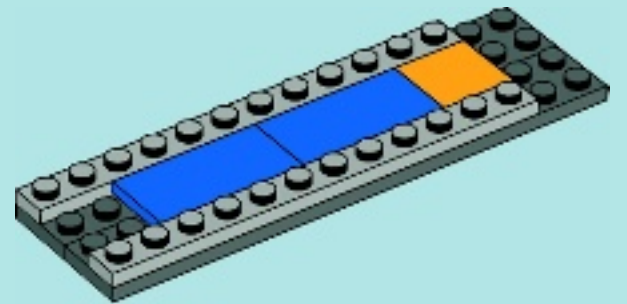

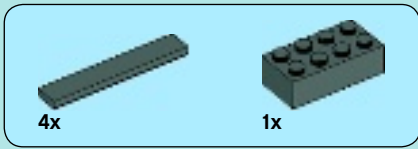

5

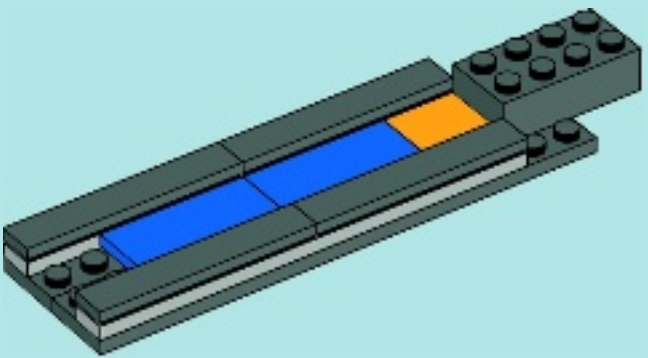

6

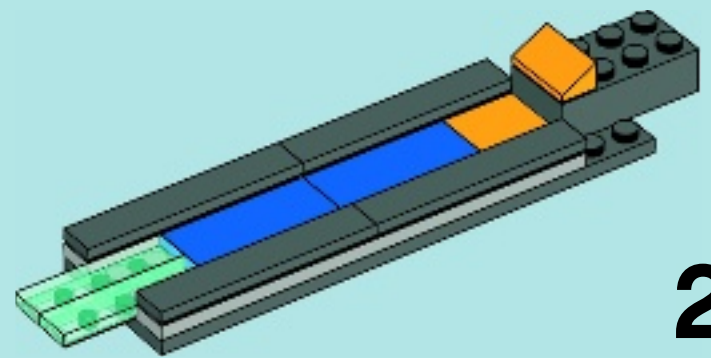

2x

4

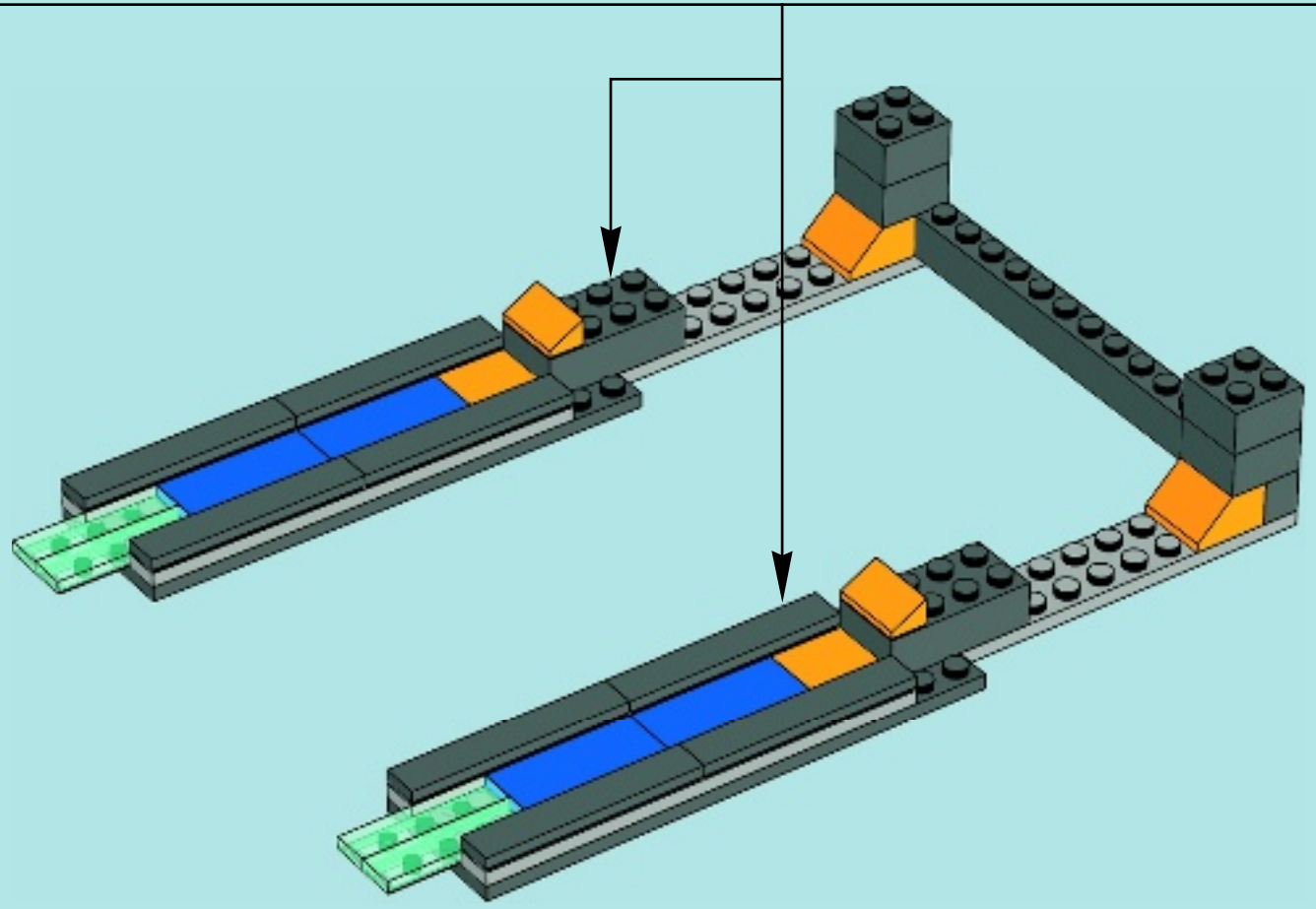



5

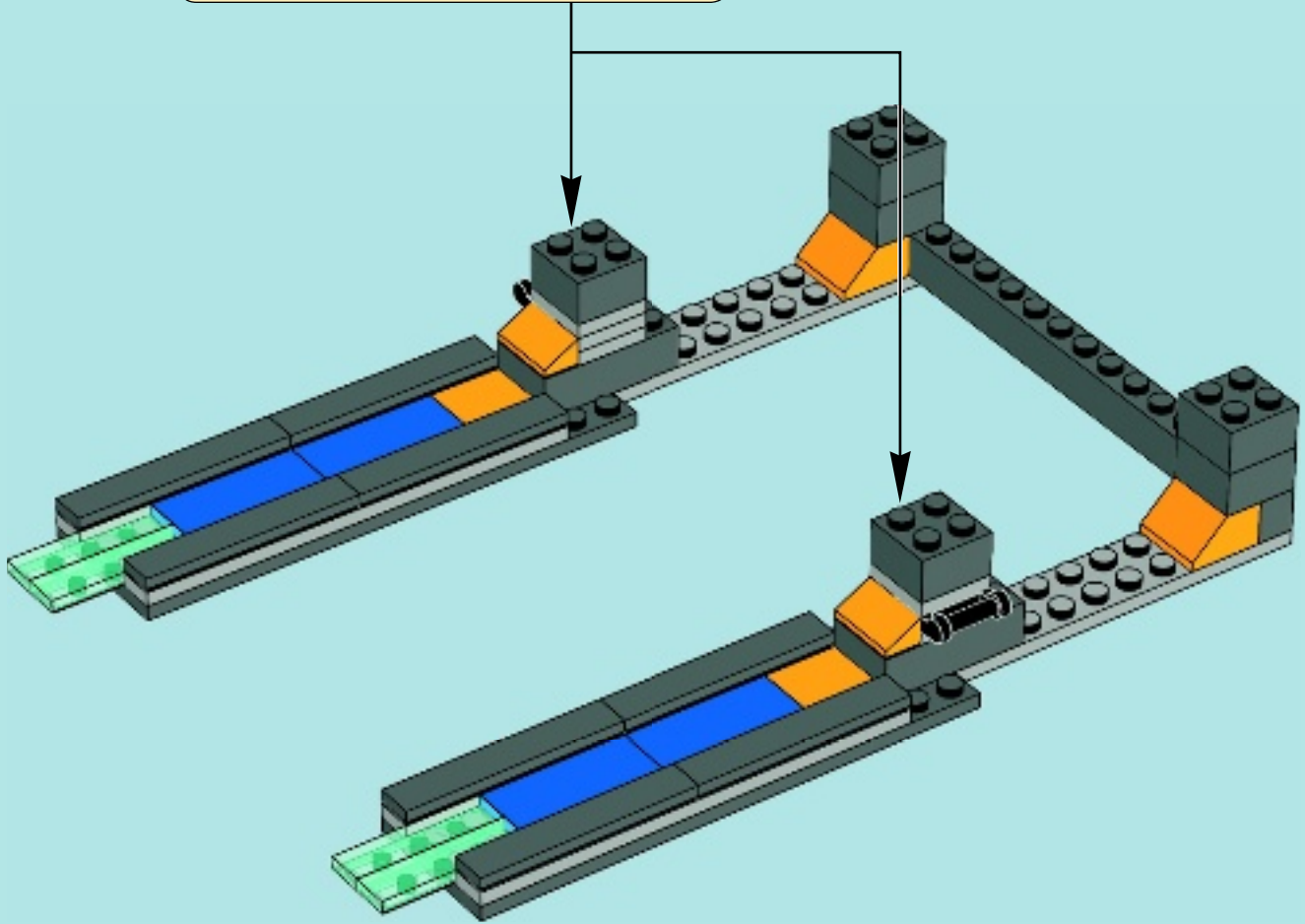
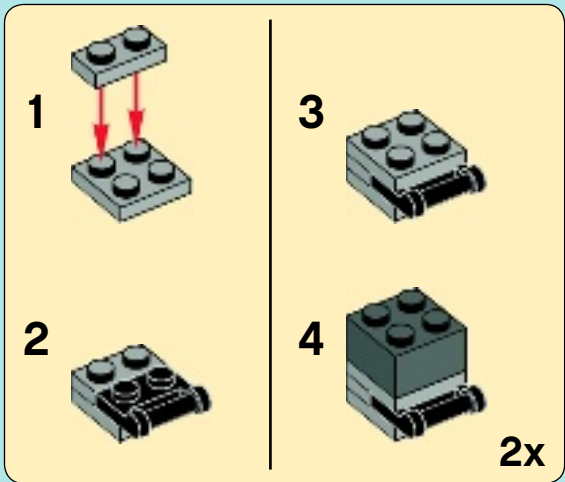



8x

6

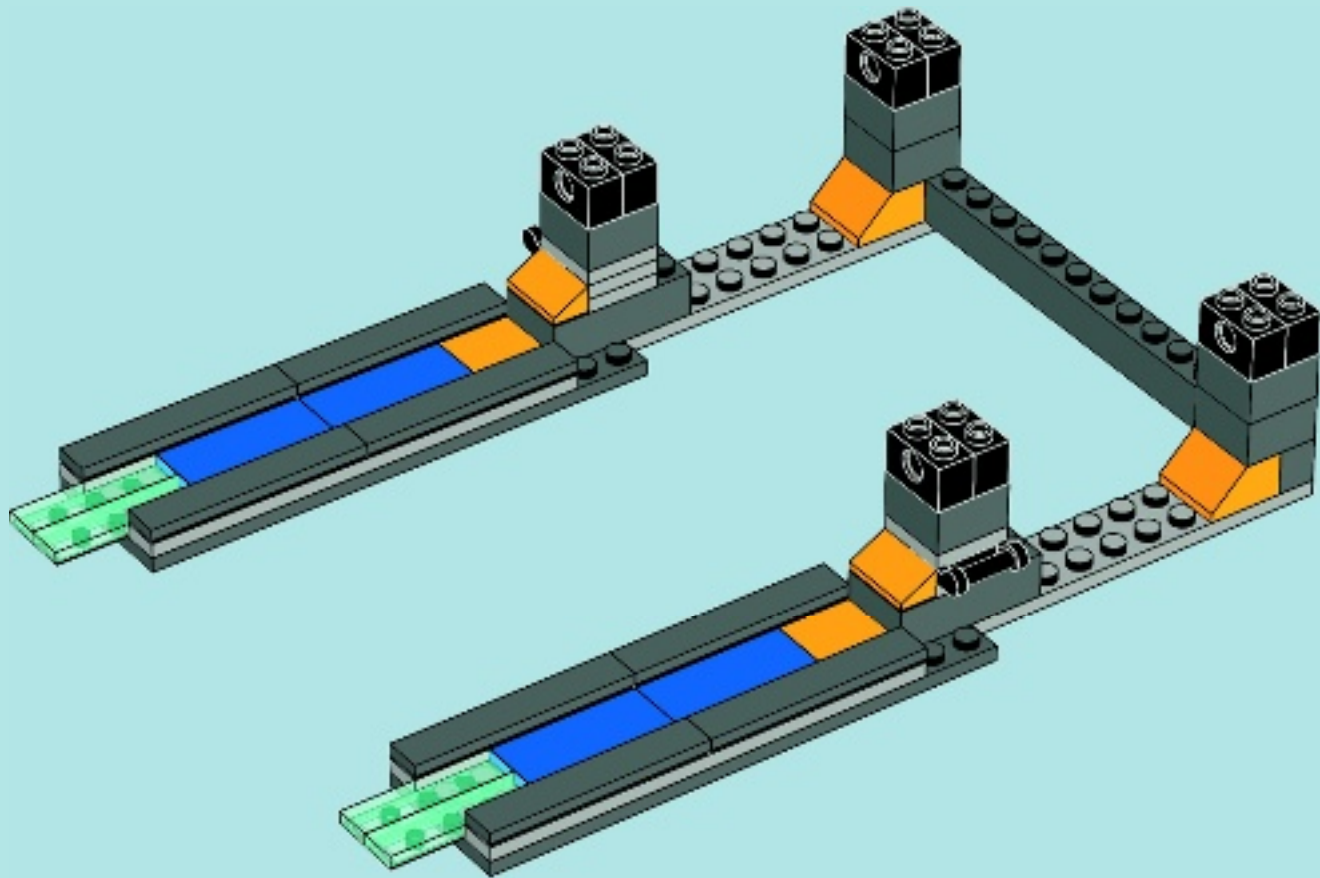

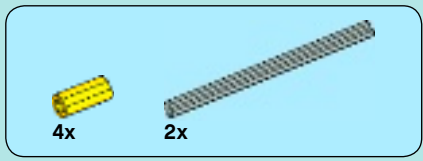

7

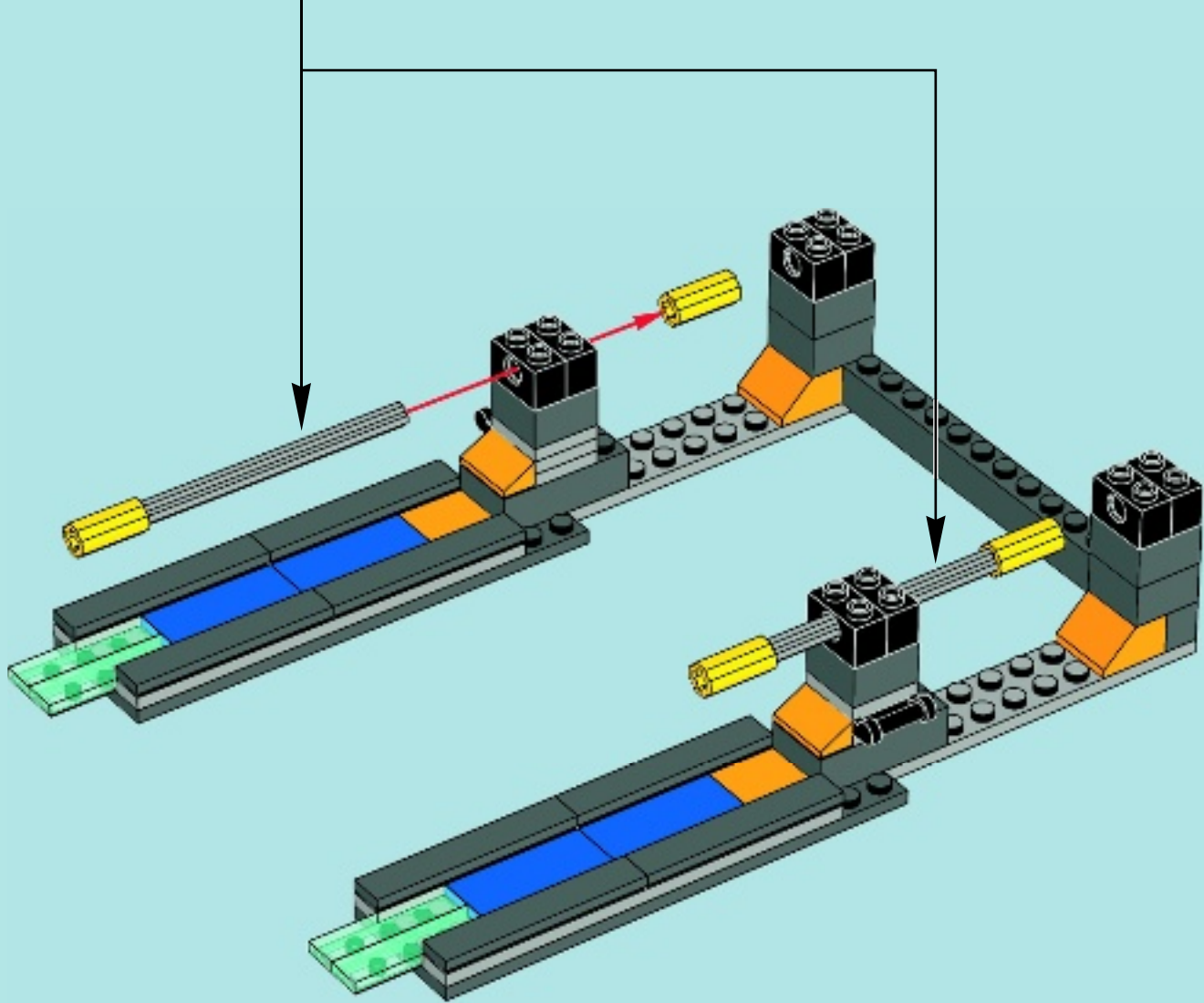
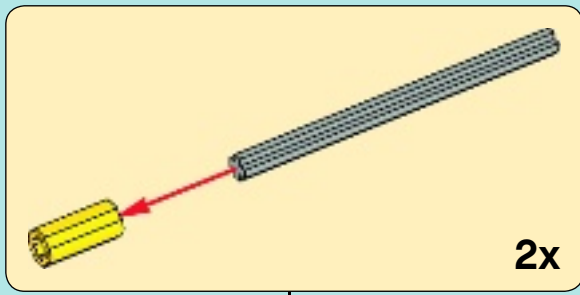

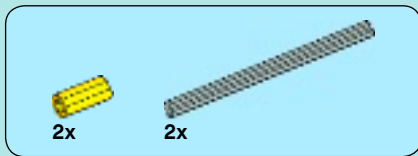

8

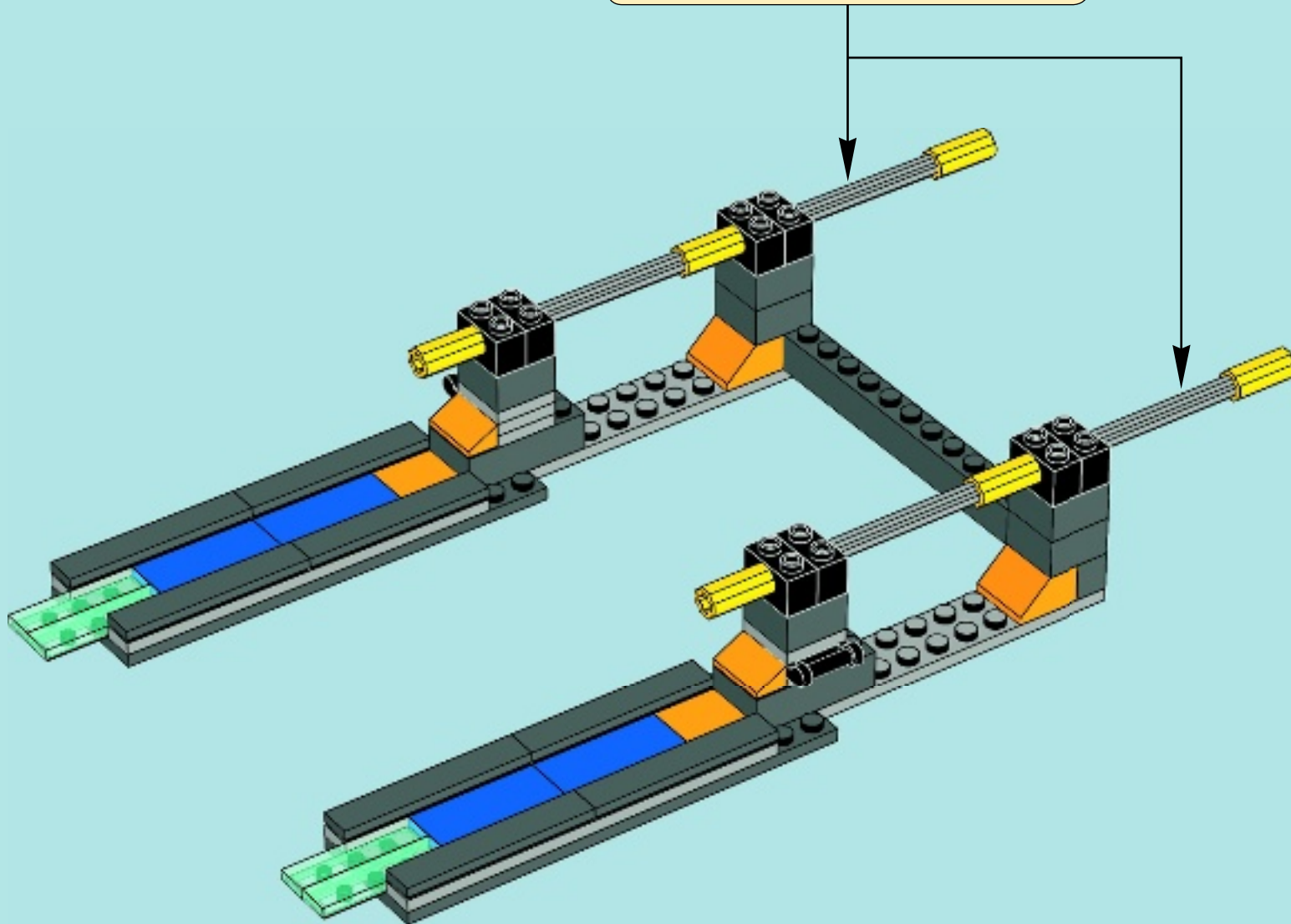
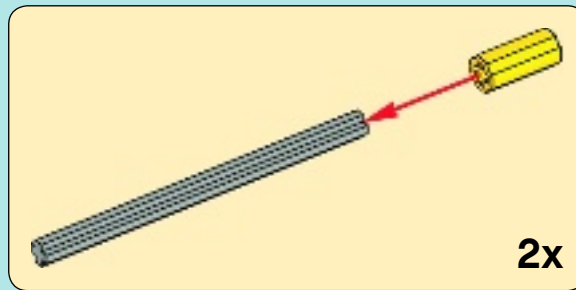

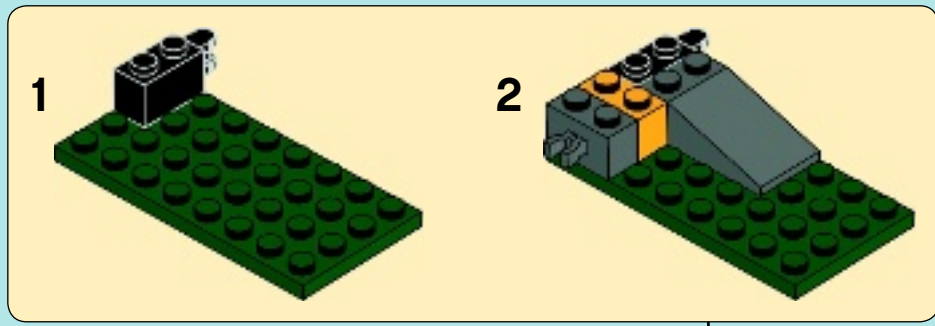
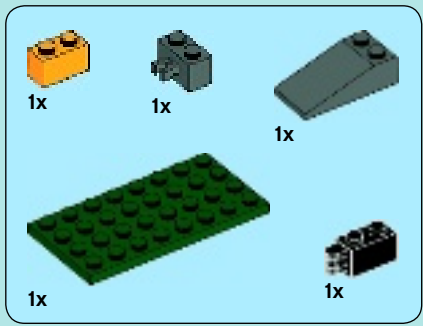

9

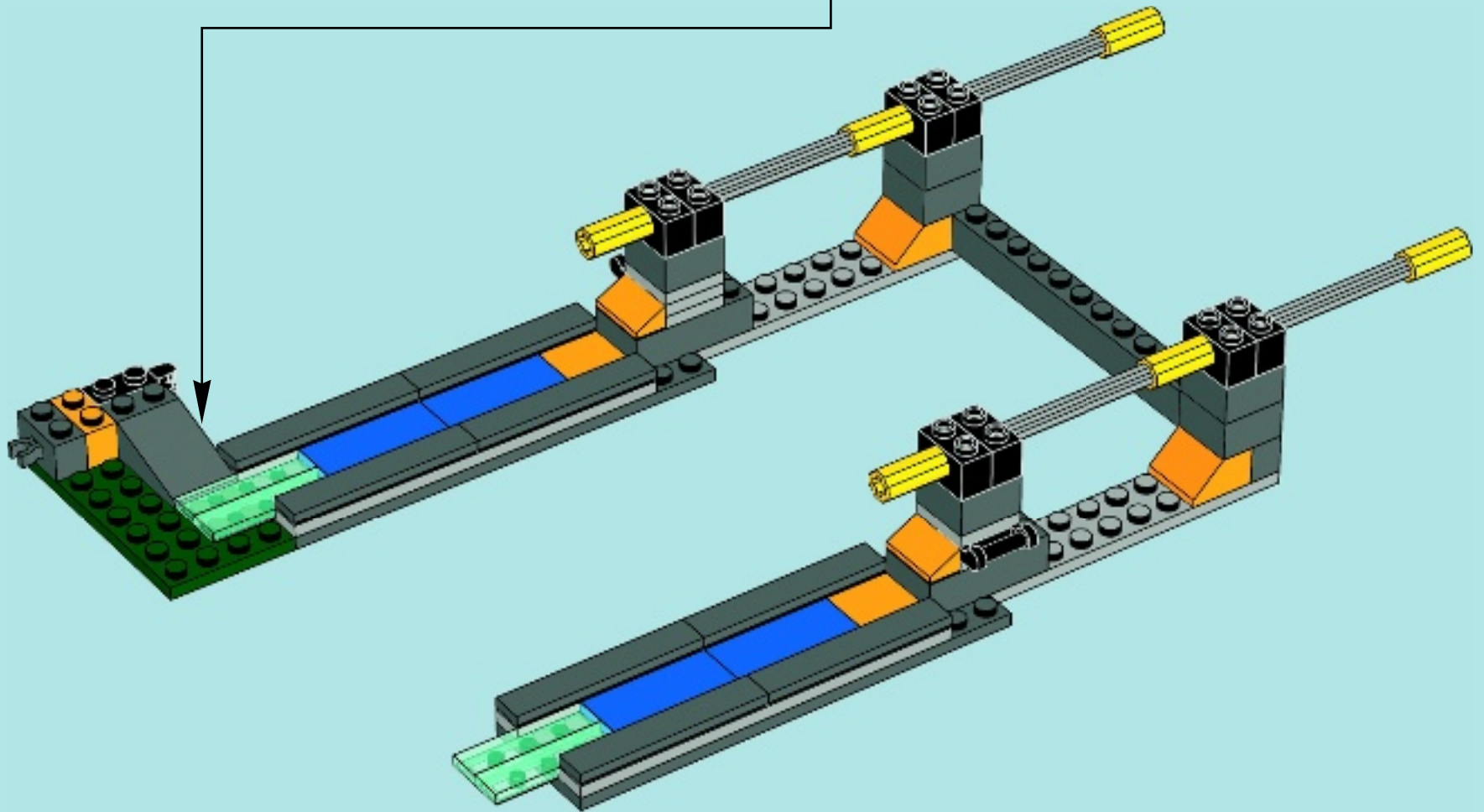

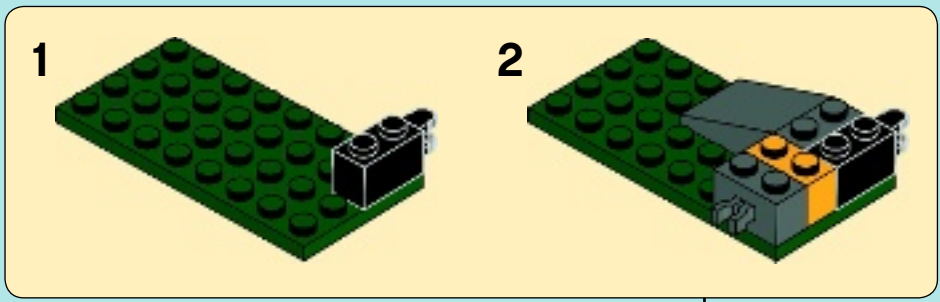
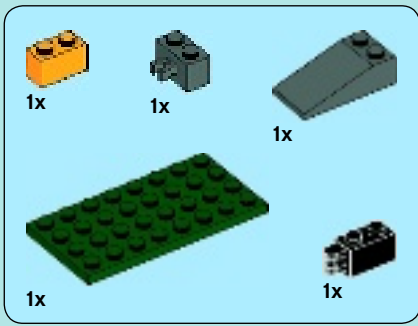

10

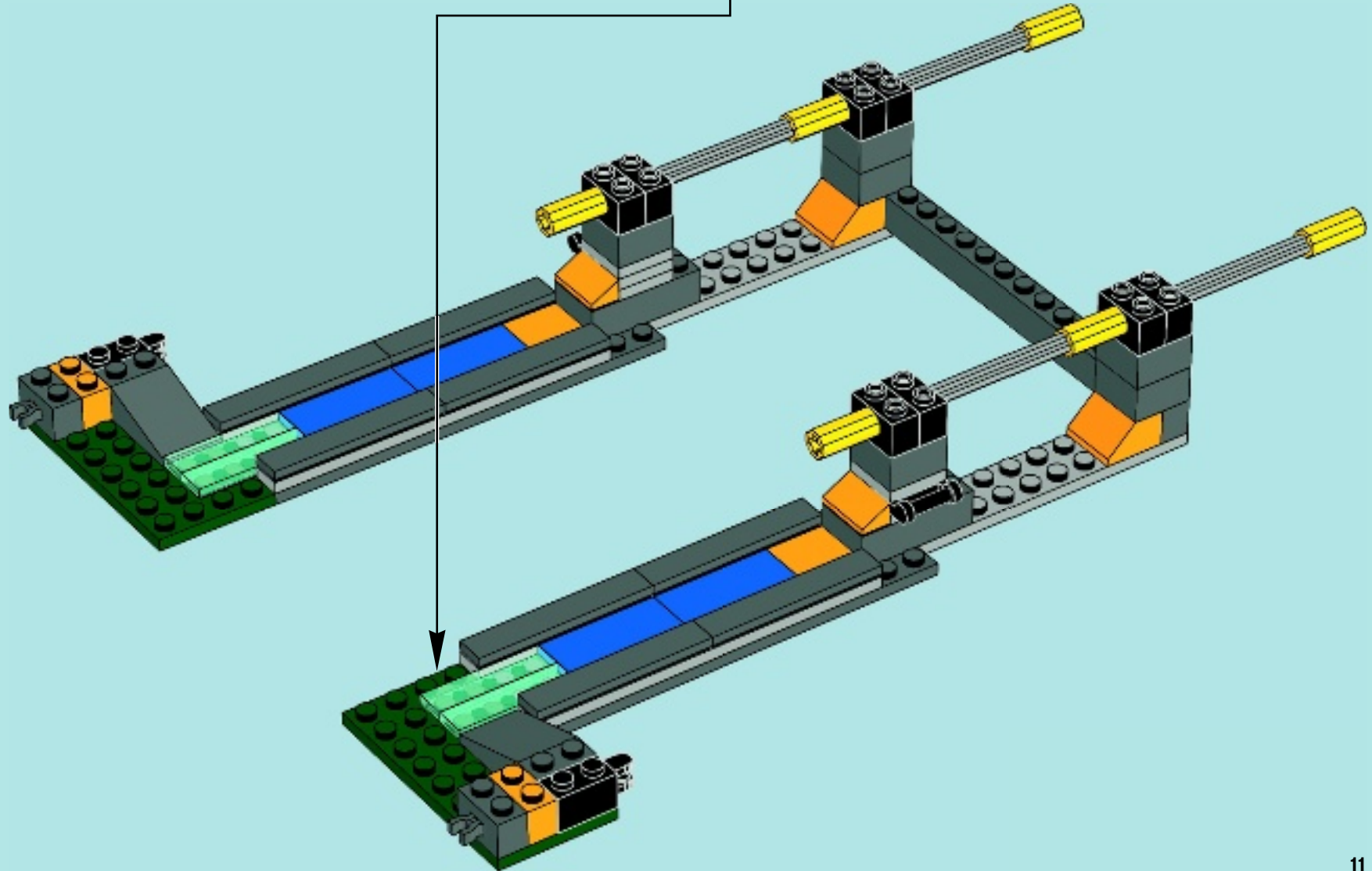

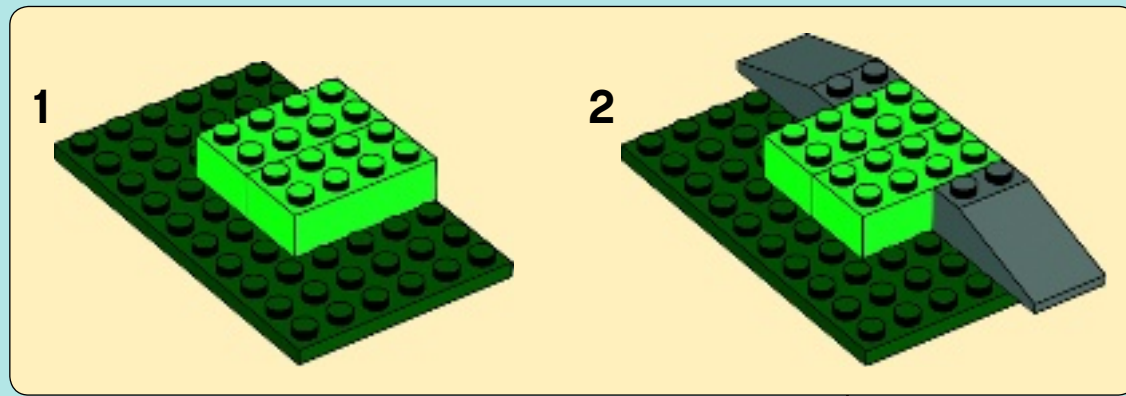
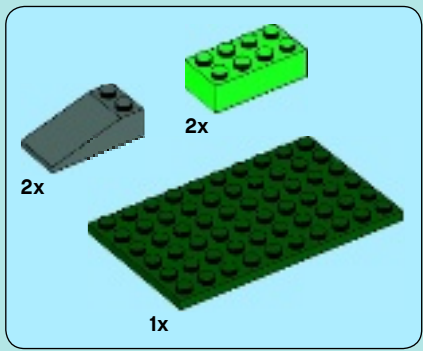

11

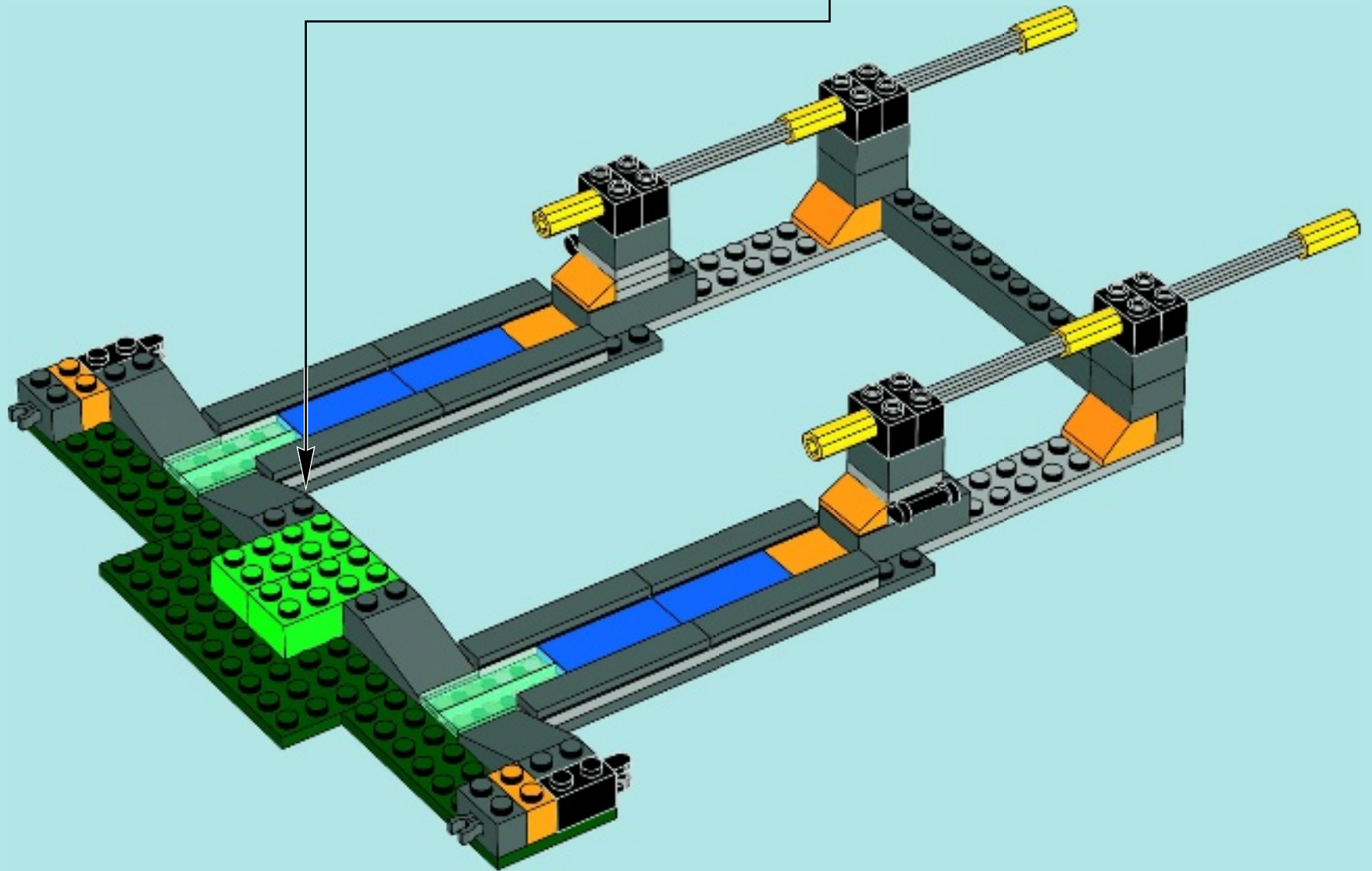

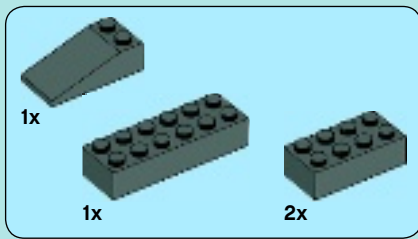

12

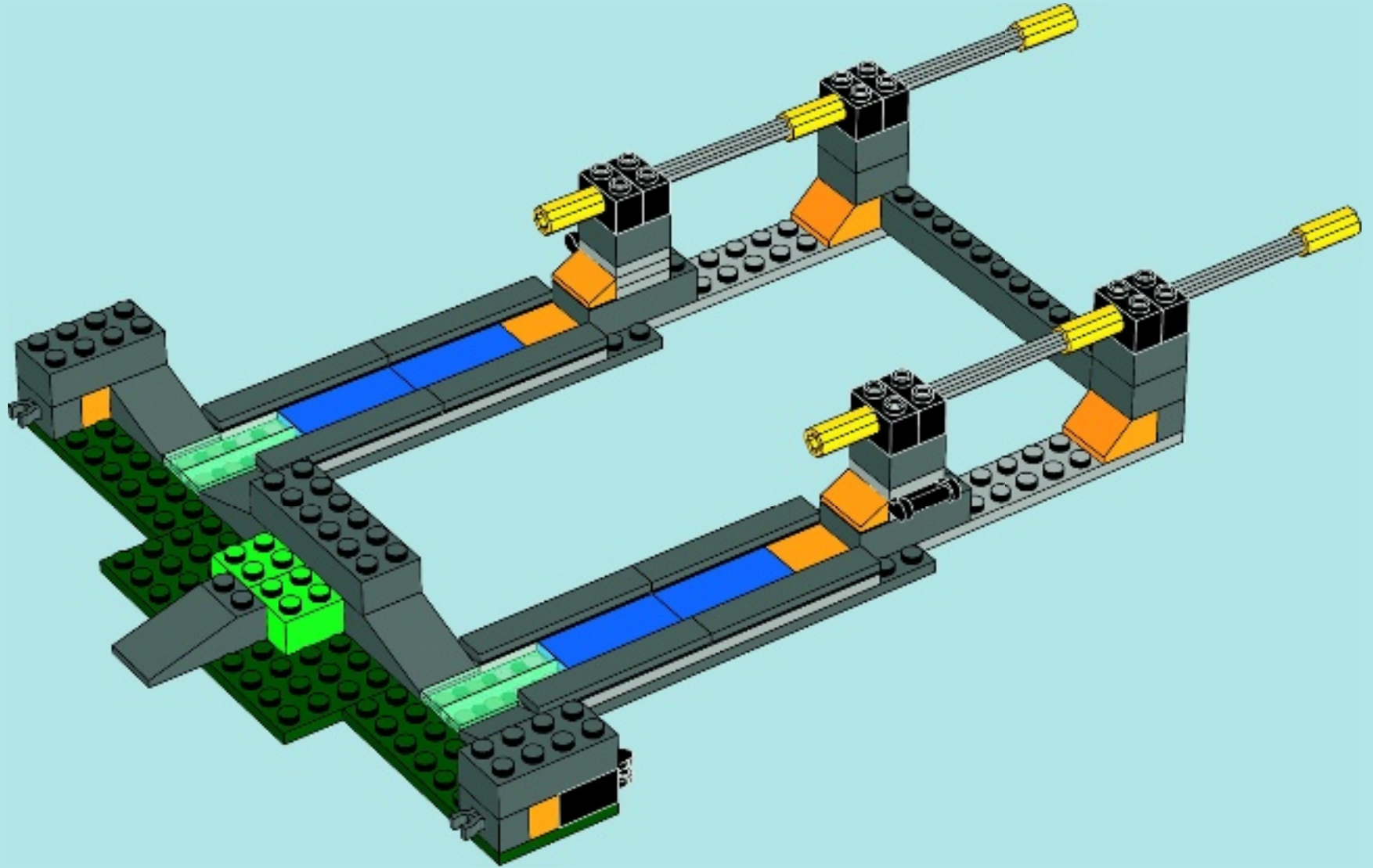

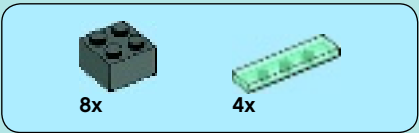

13

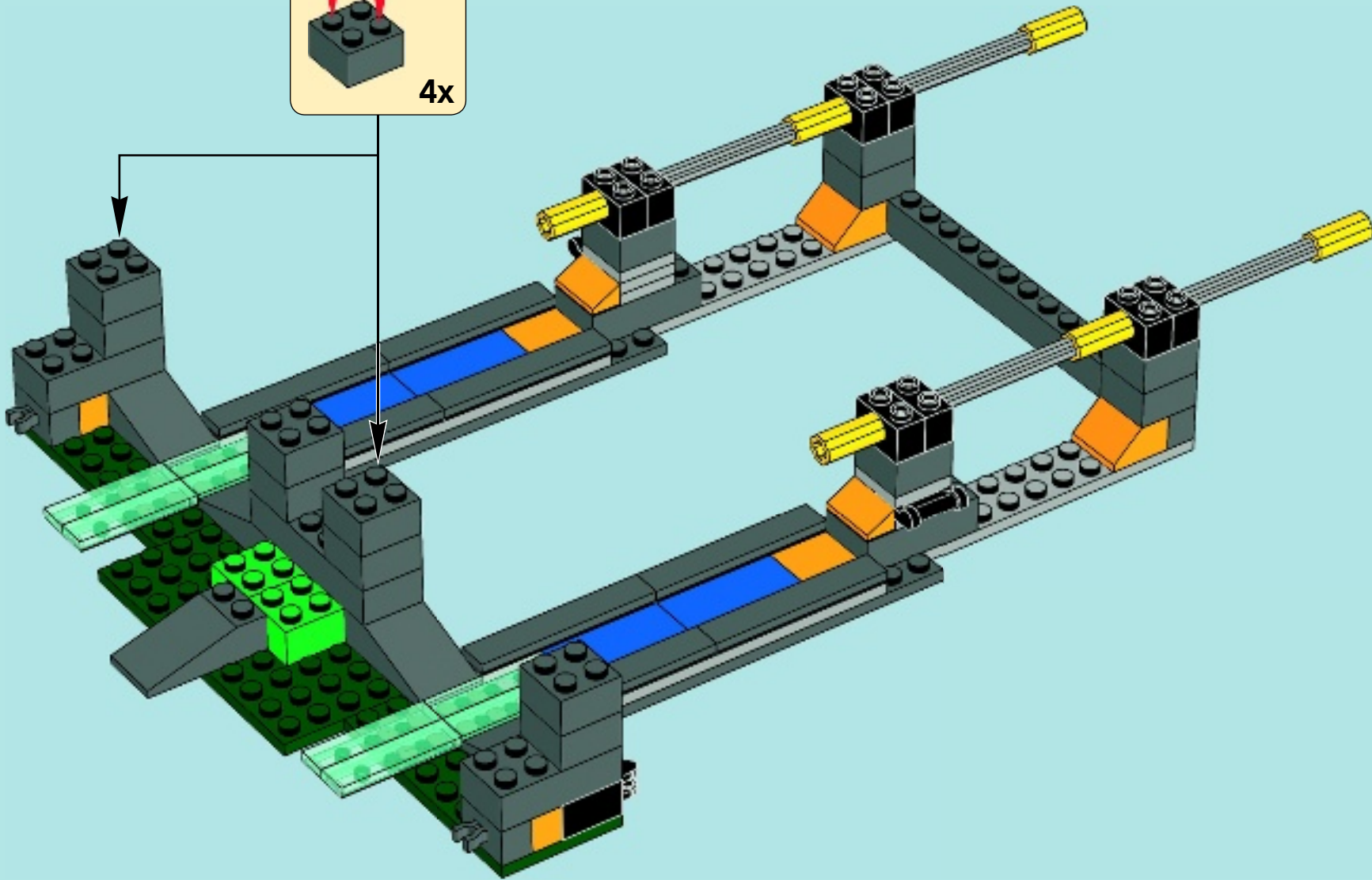
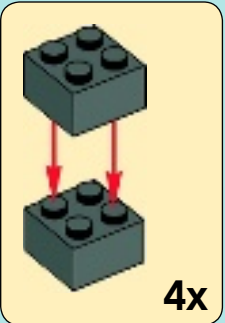

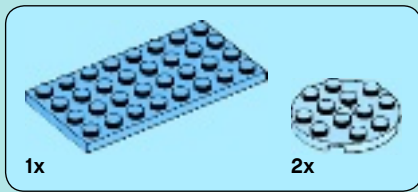

14

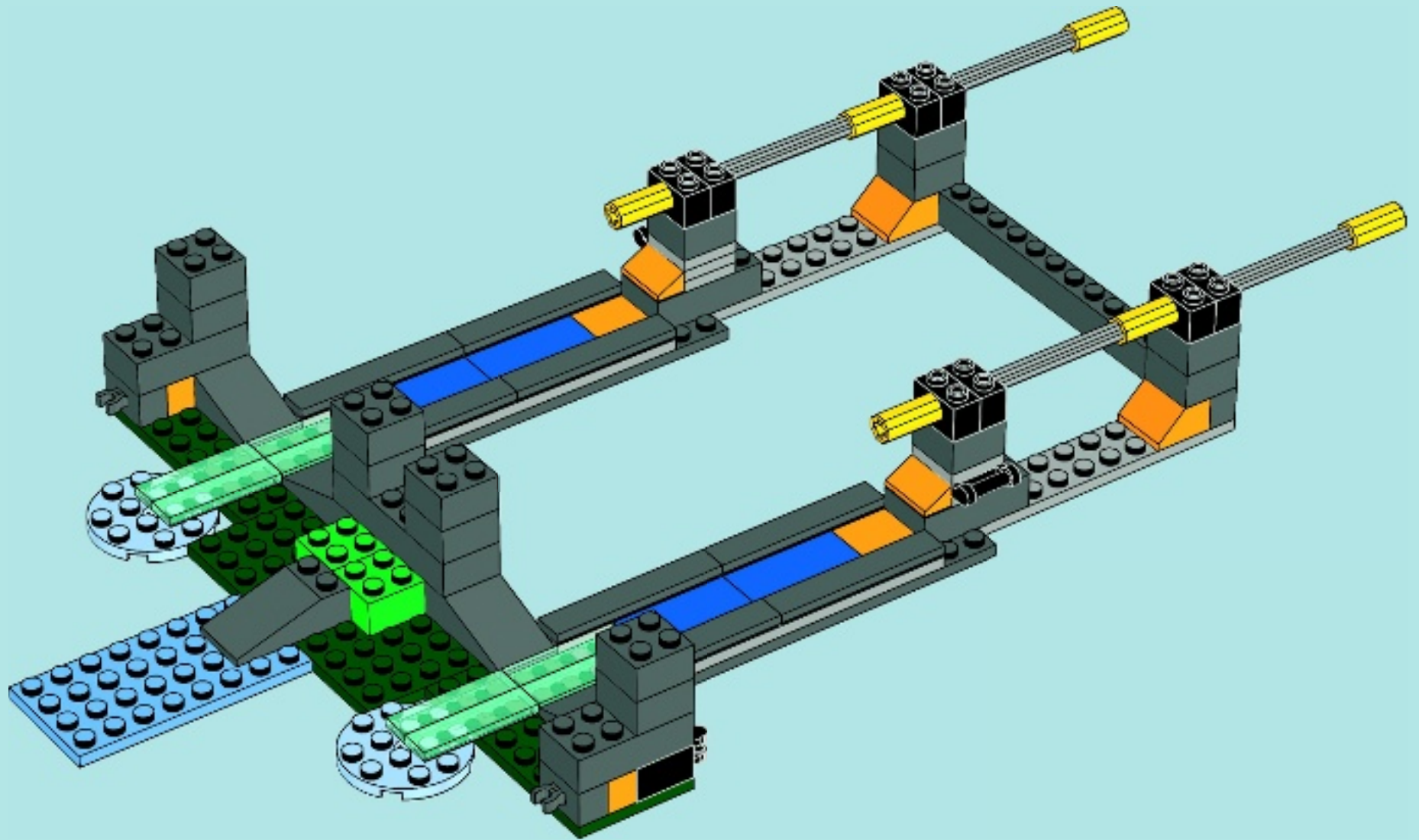

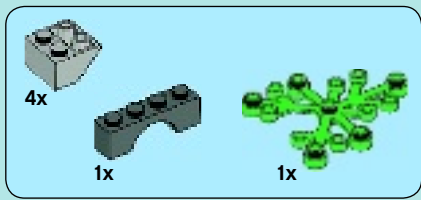

15

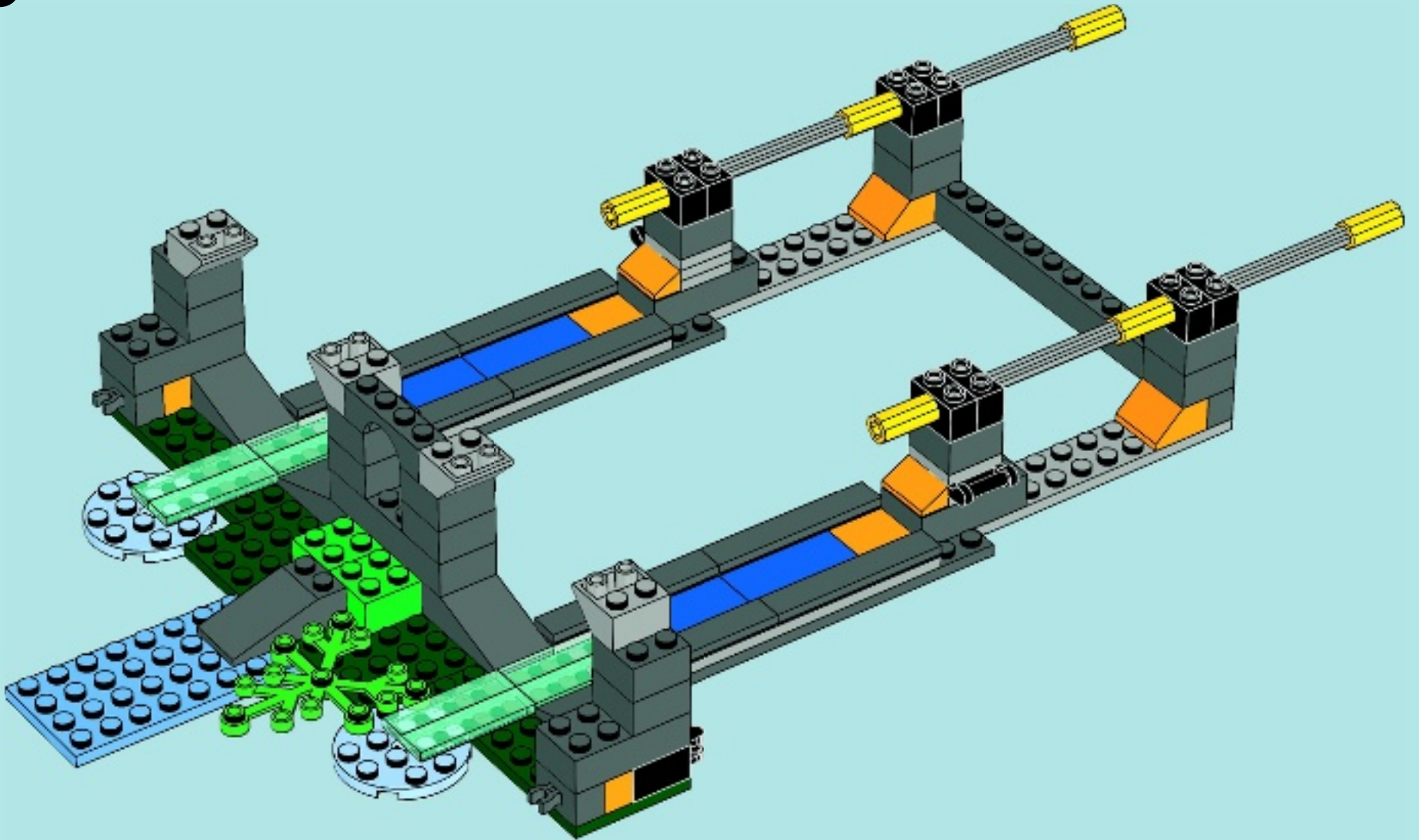

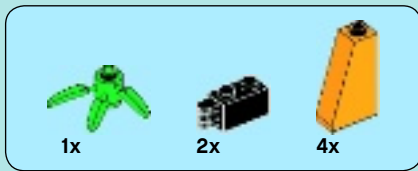

16

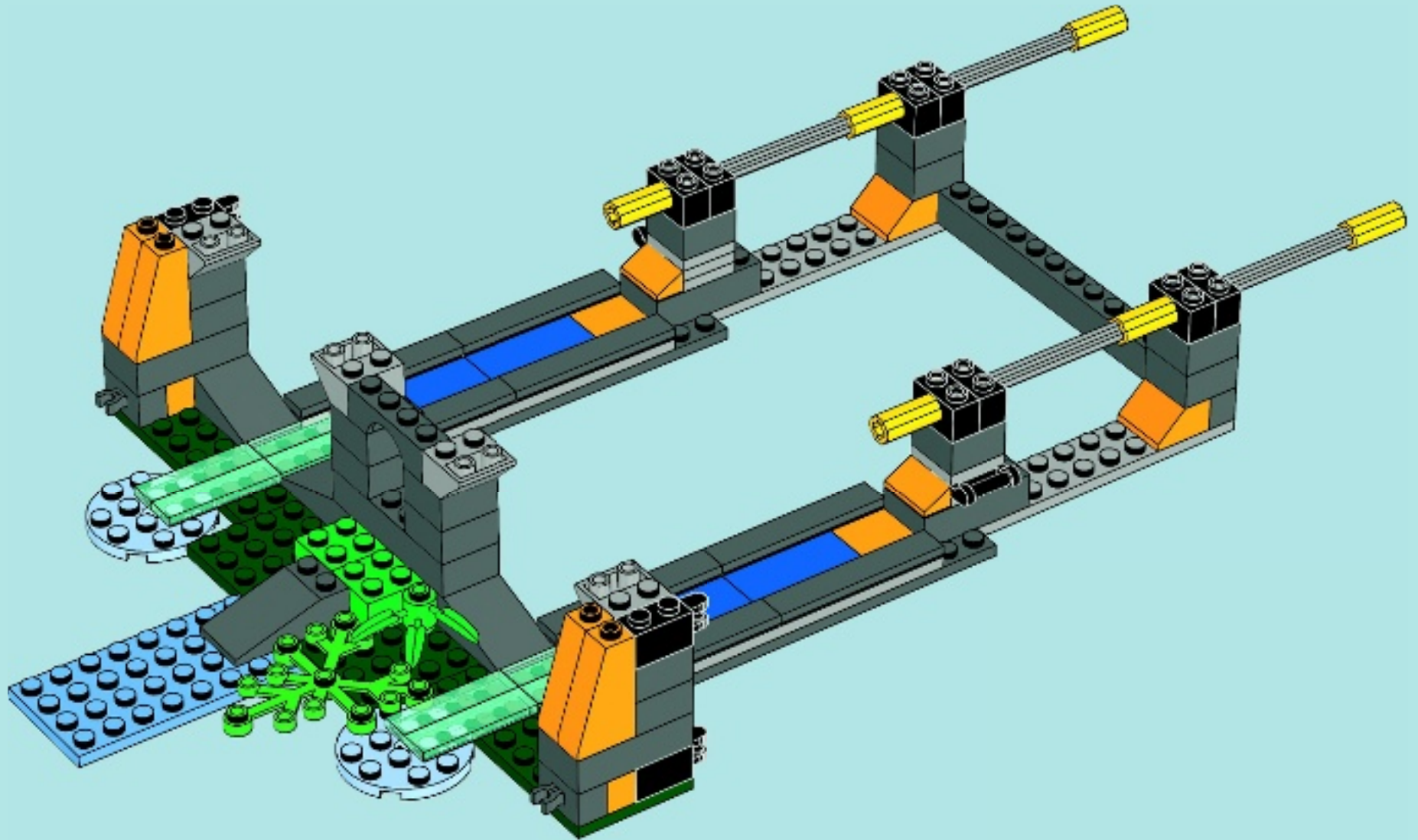

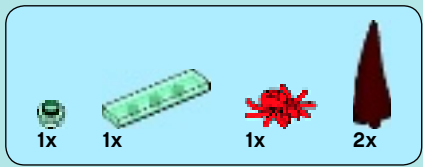

17

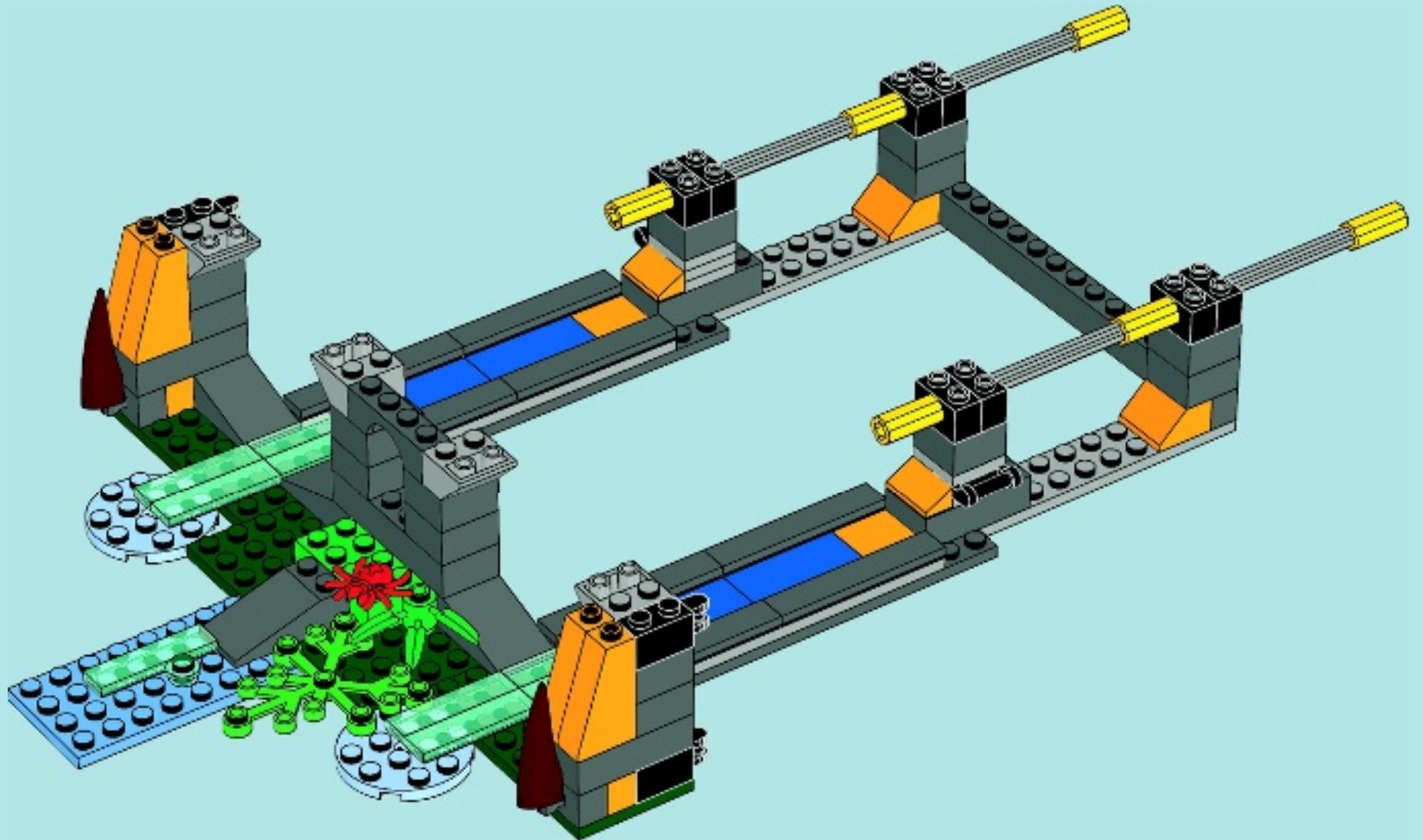

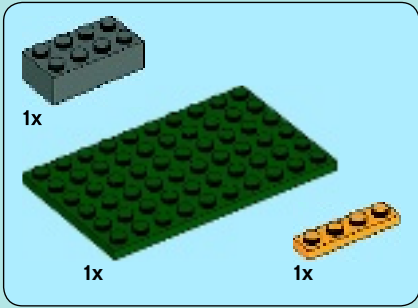
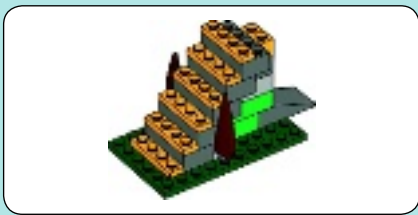

1

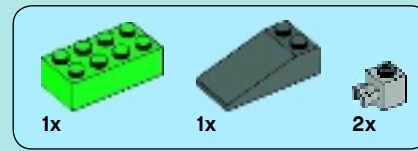
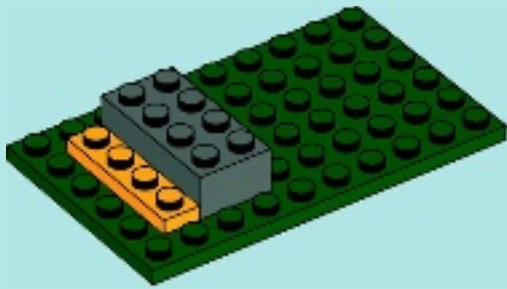

2

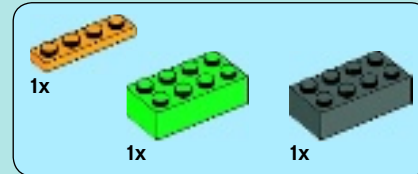
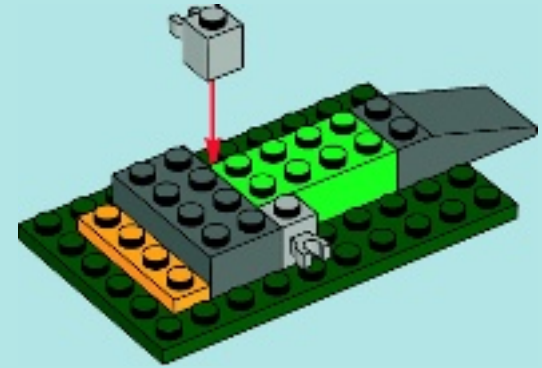

3

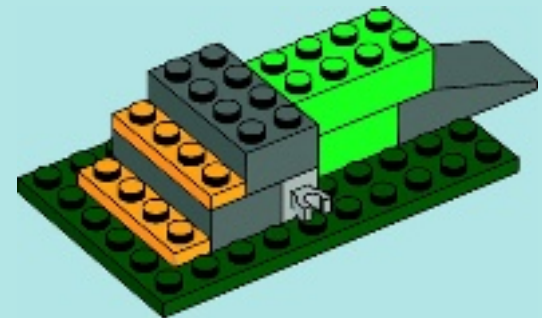

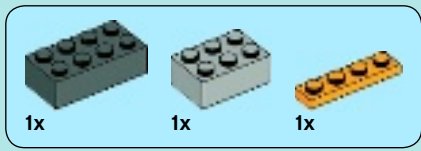

4

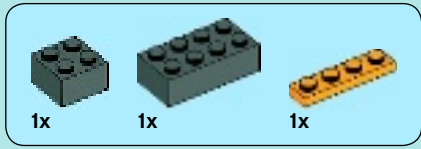
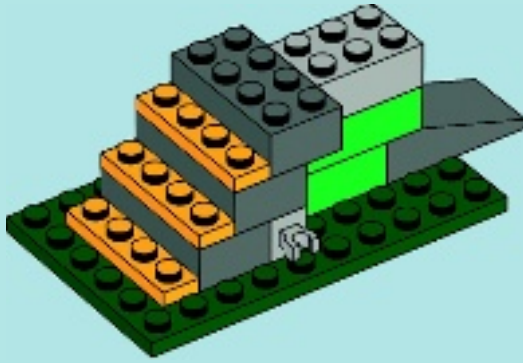

5

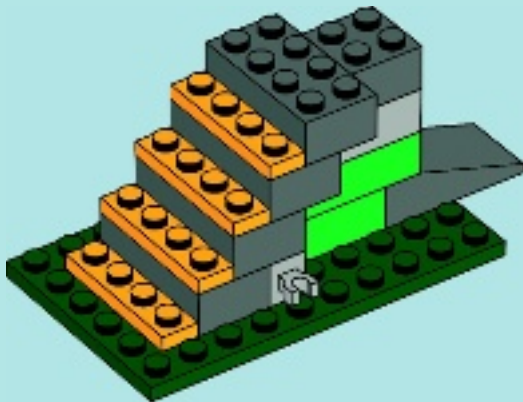

6

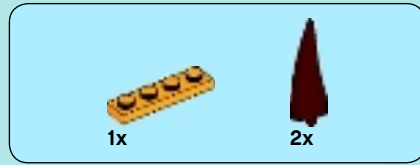
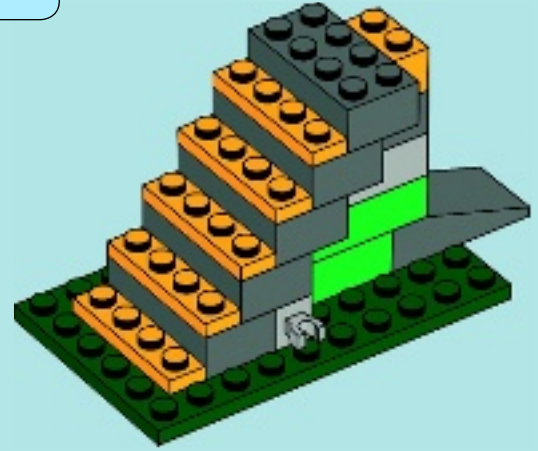

7



18

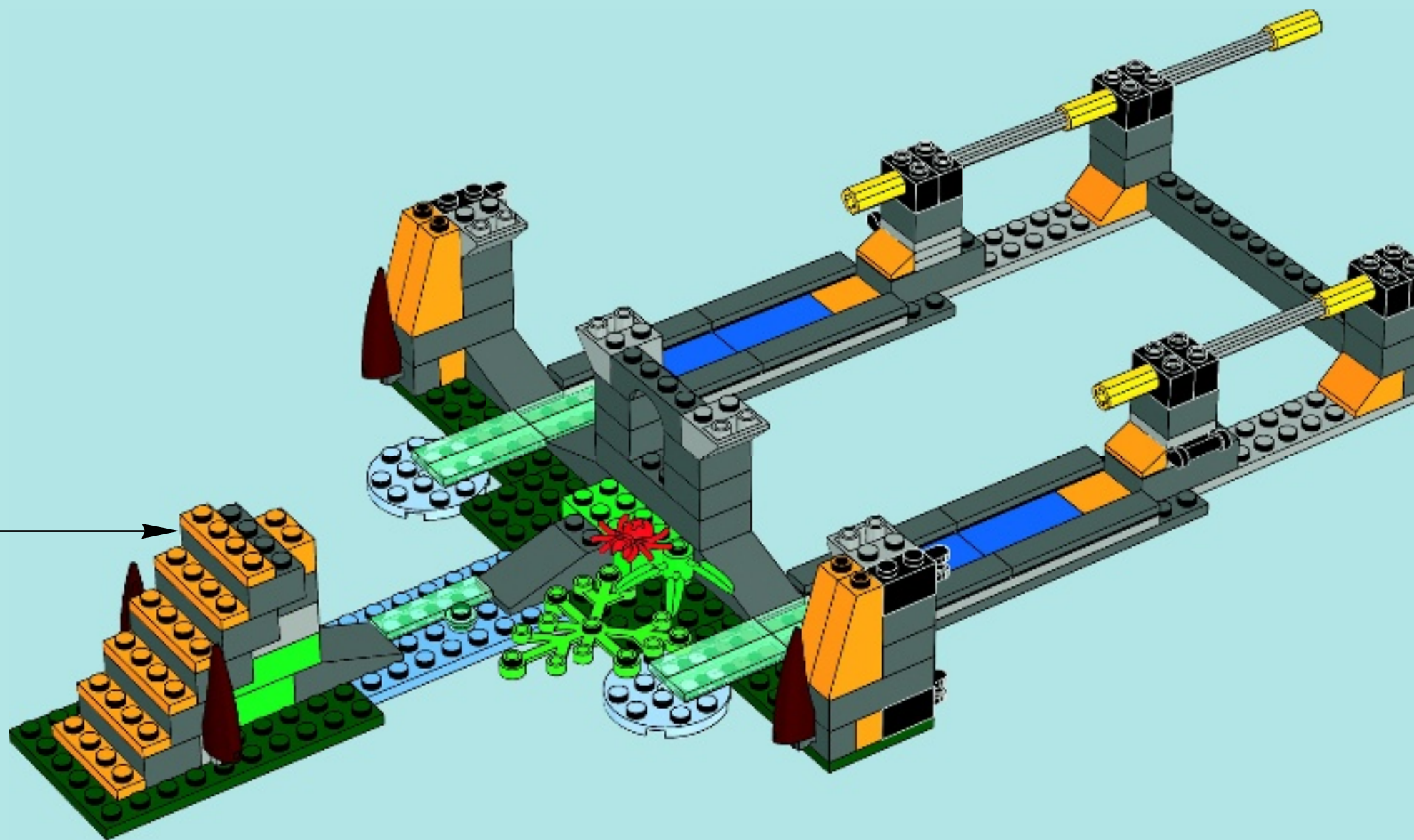

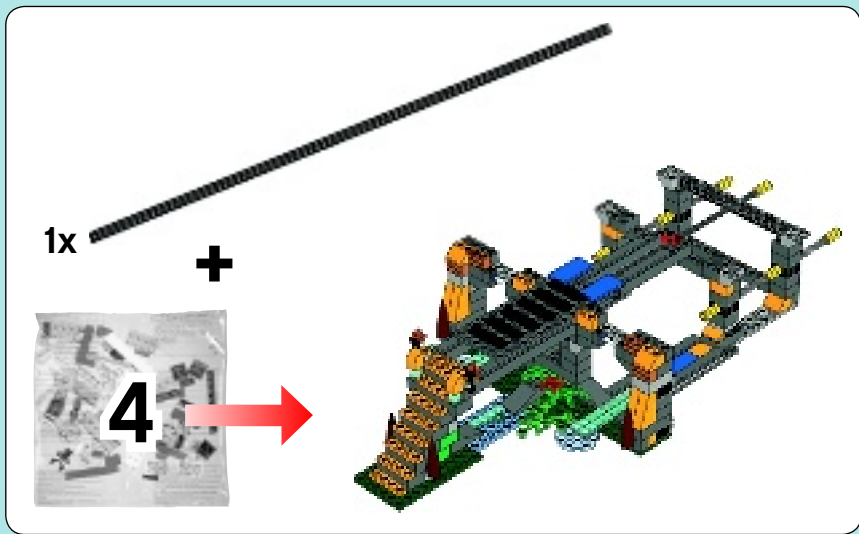

19

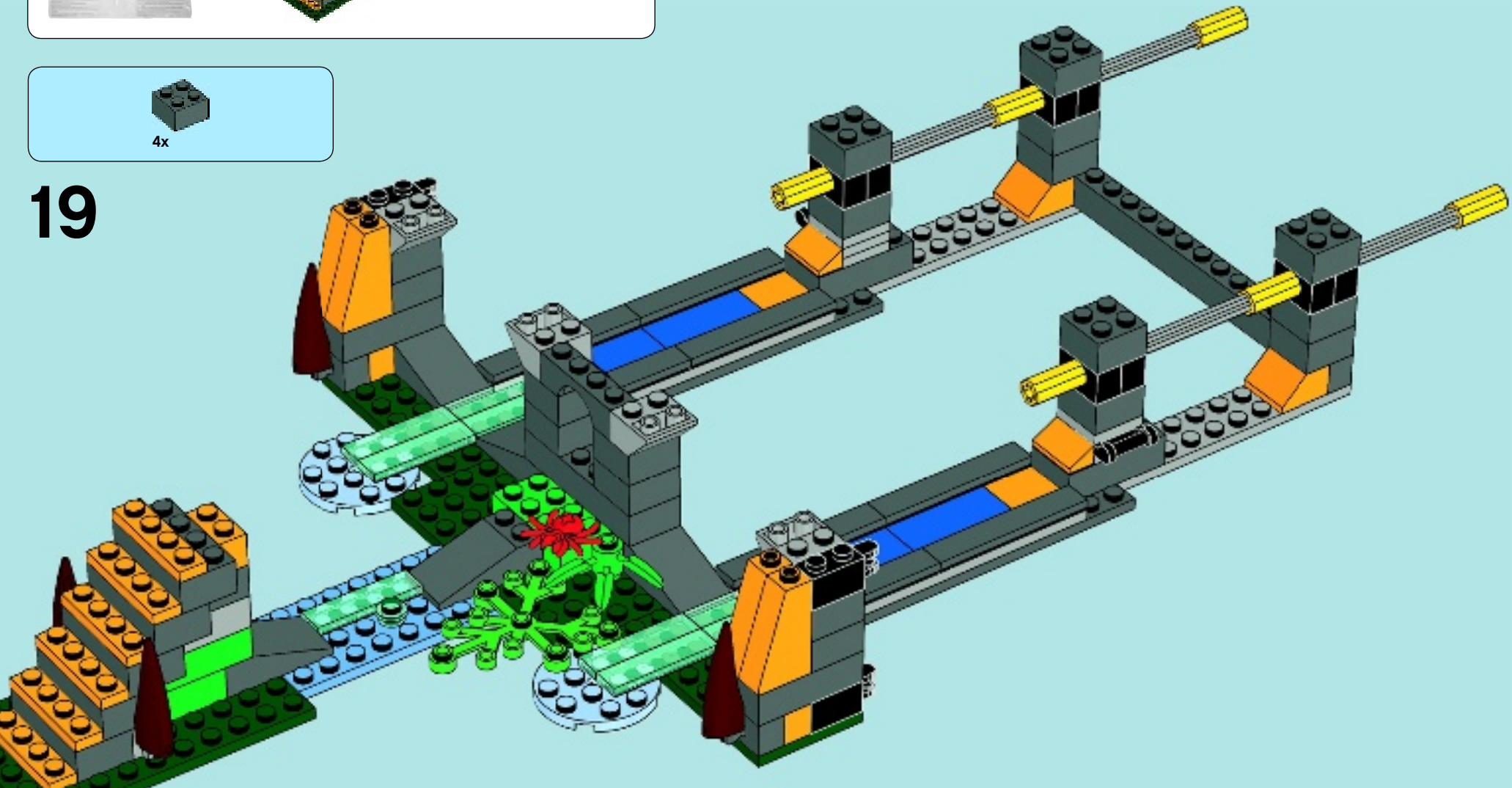

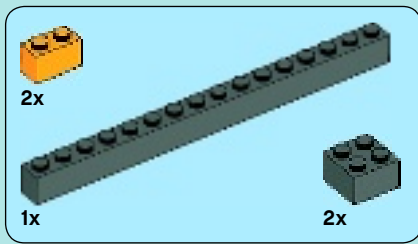

20

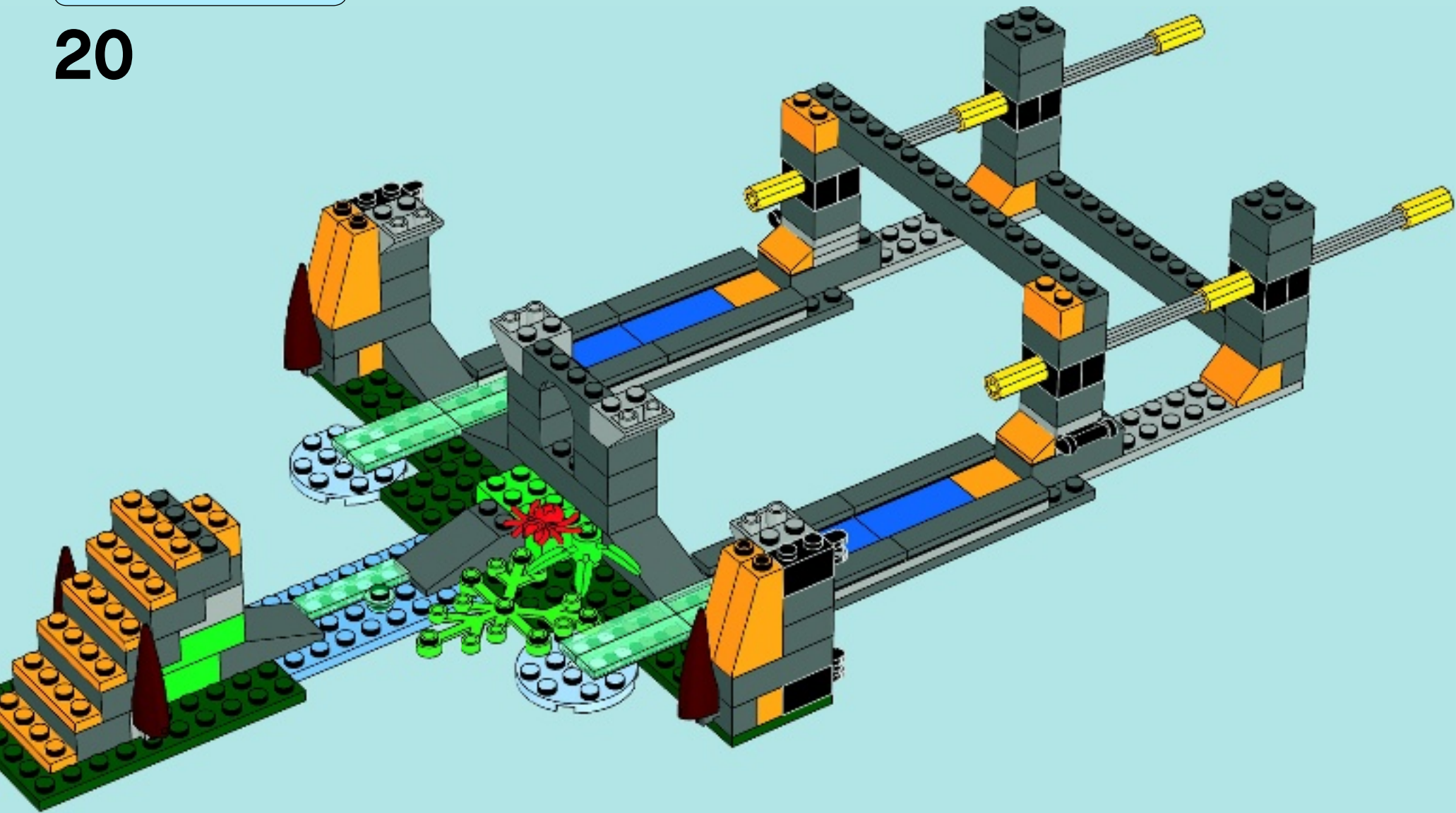

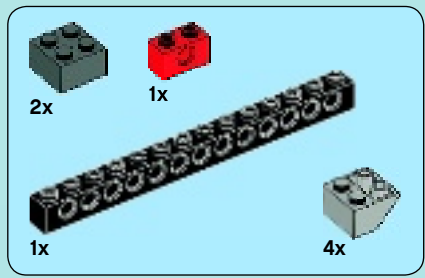

21

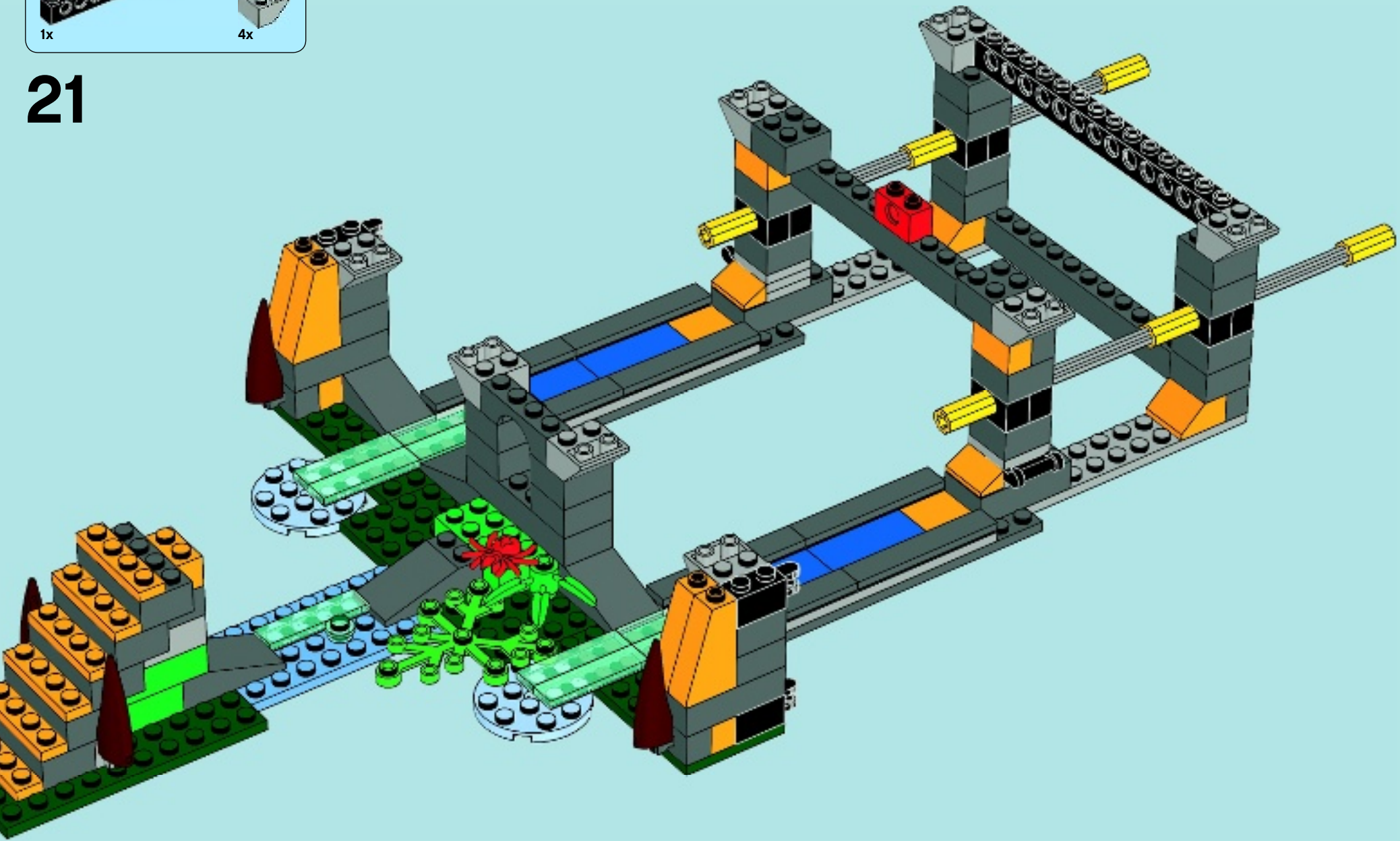

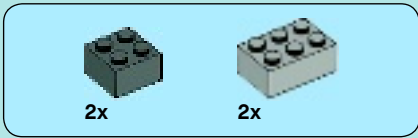

22

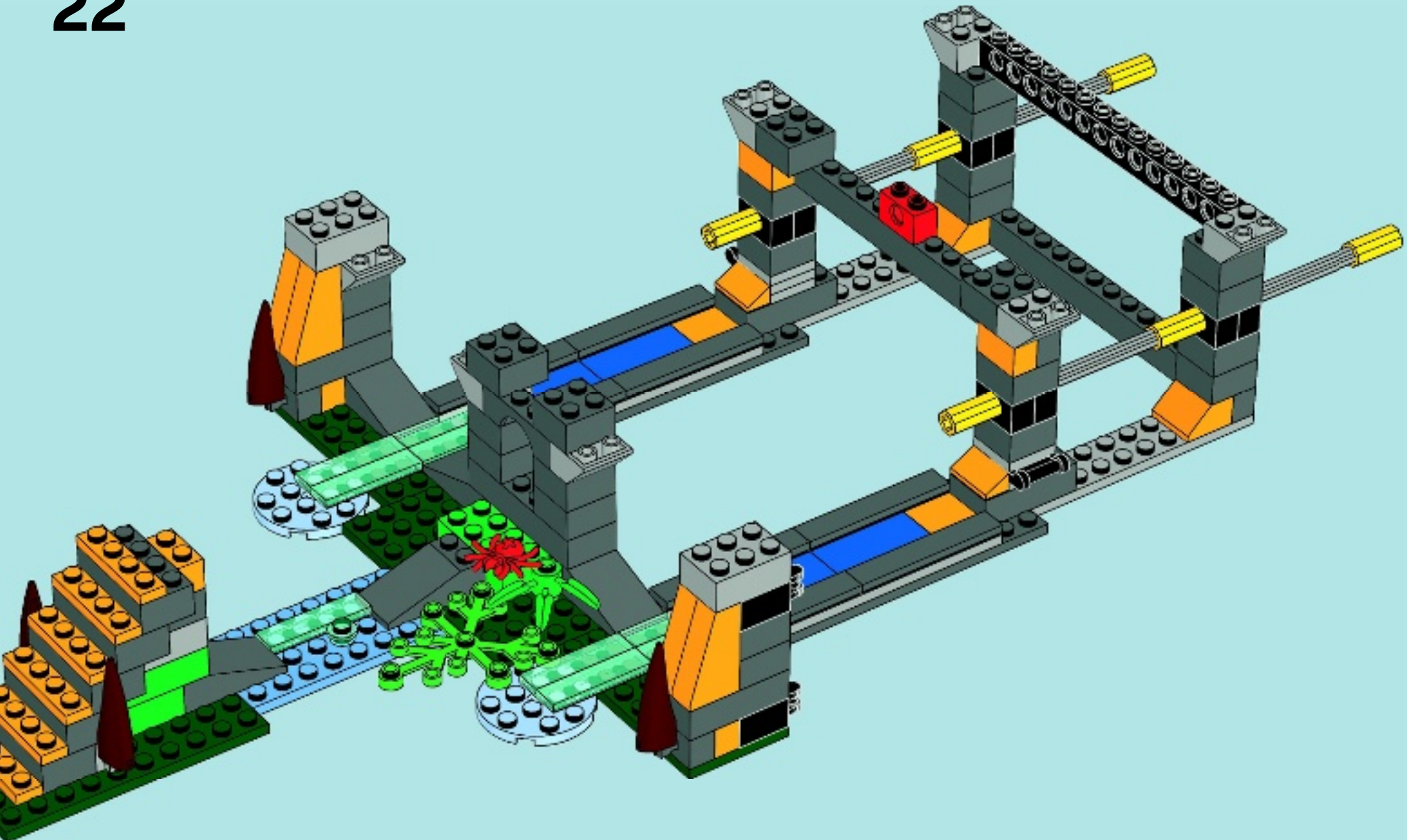

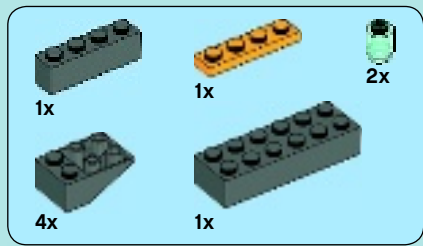

23

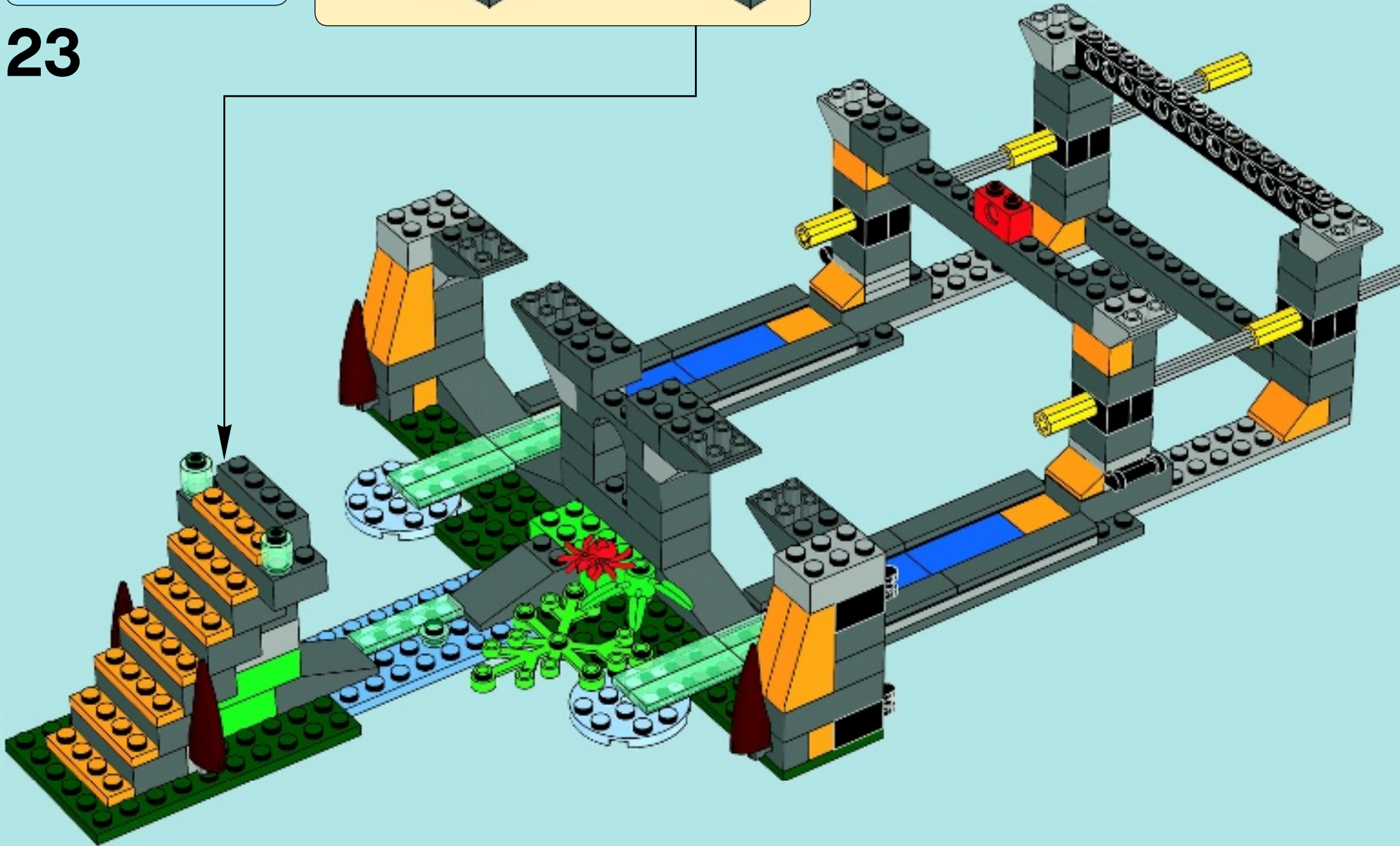

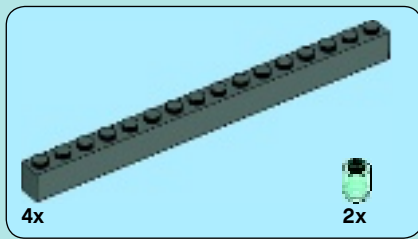

24

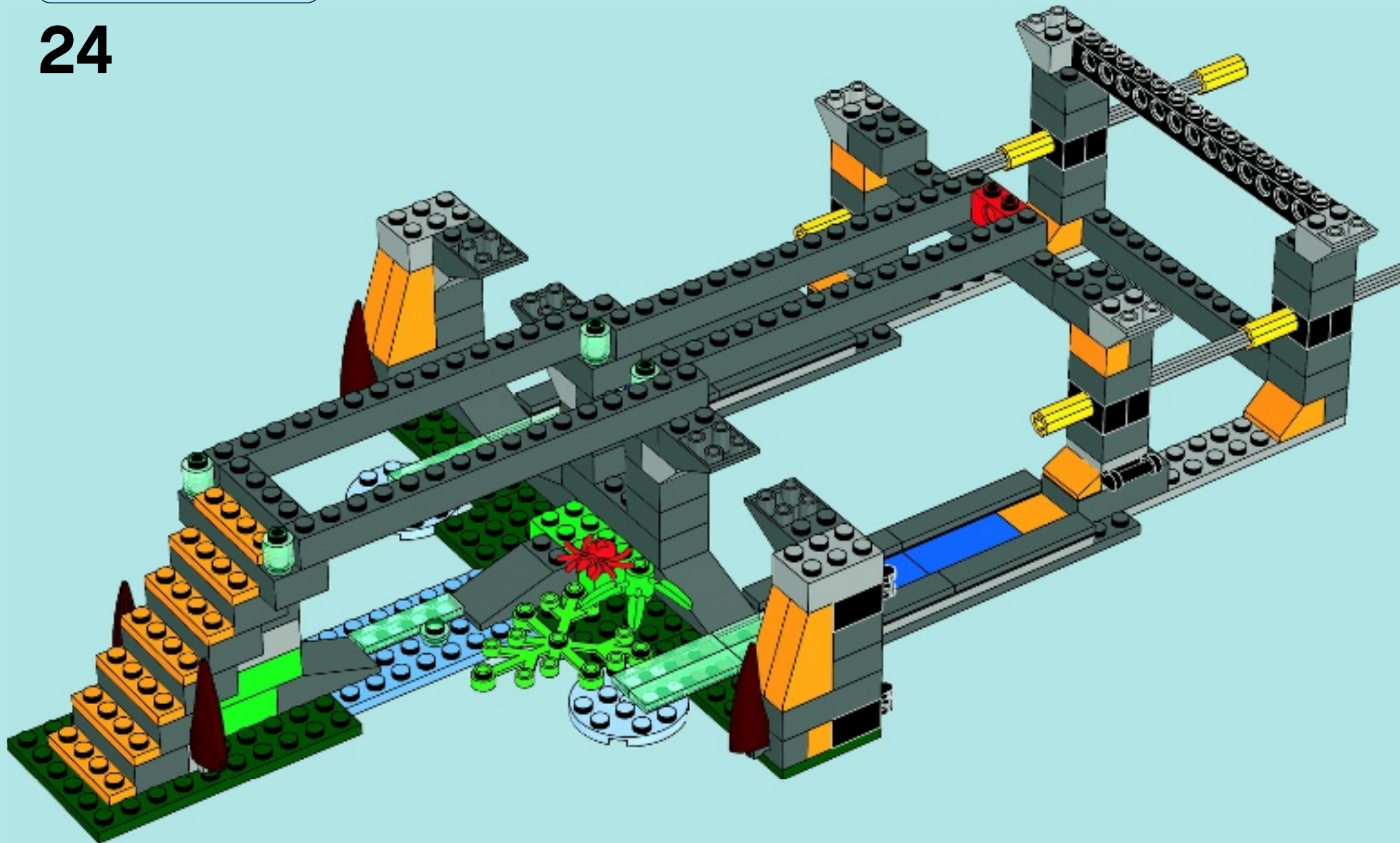

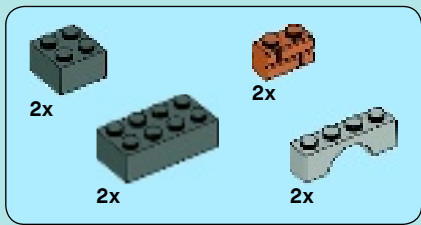

25

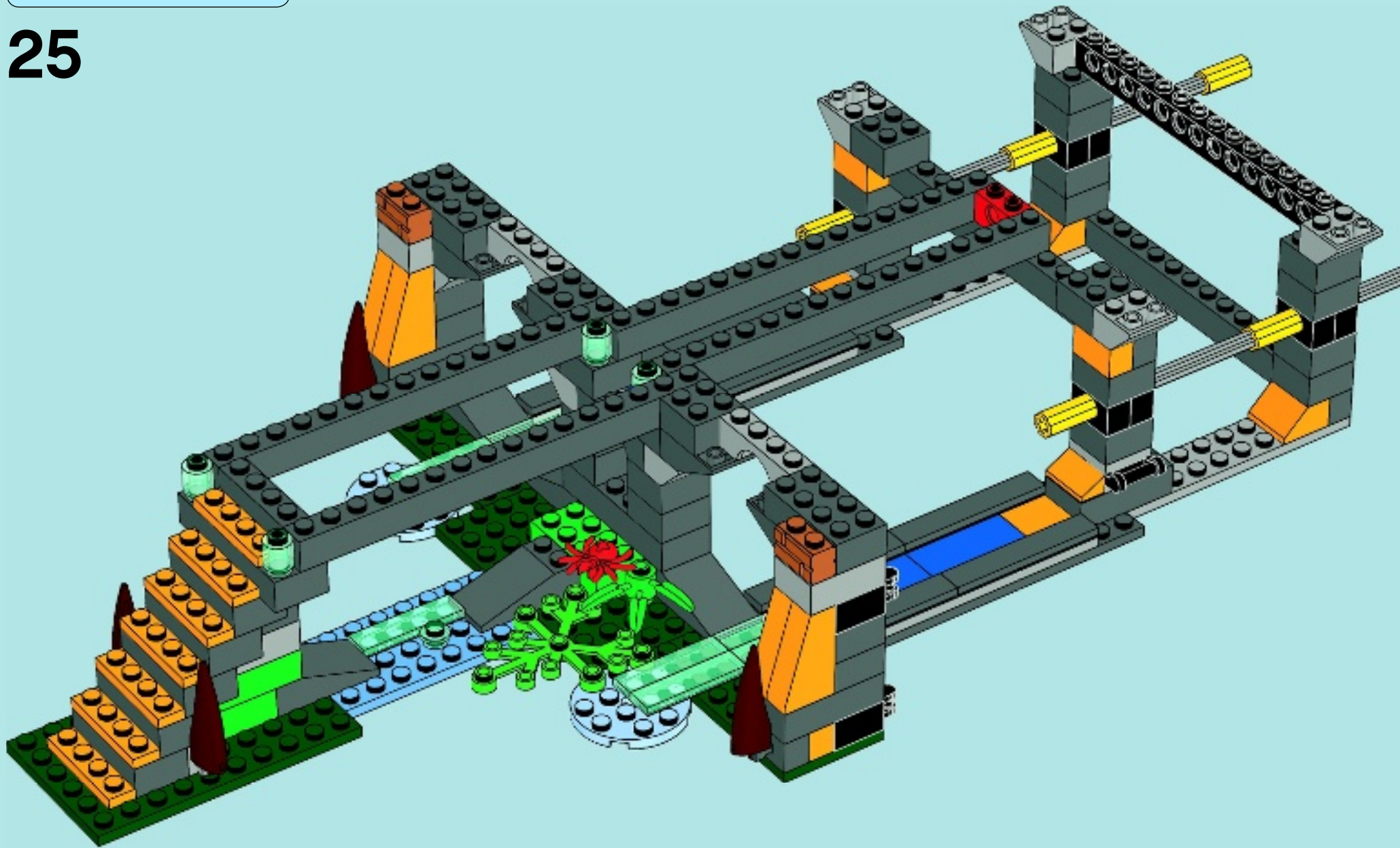

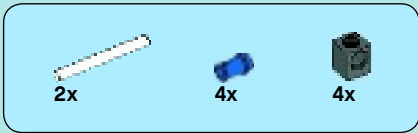

26

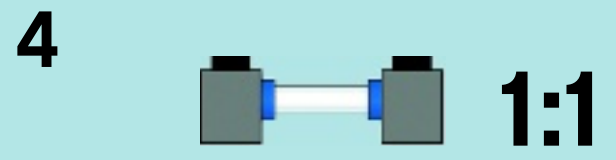
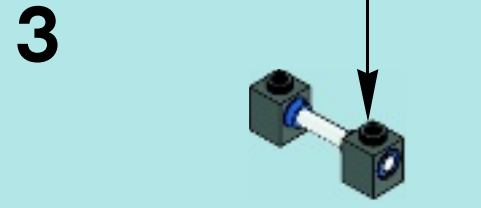
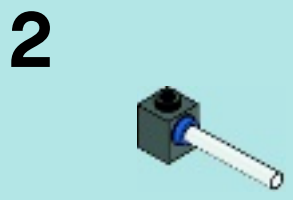
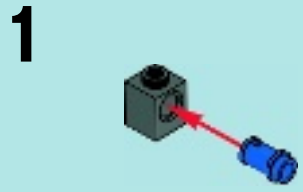

2x

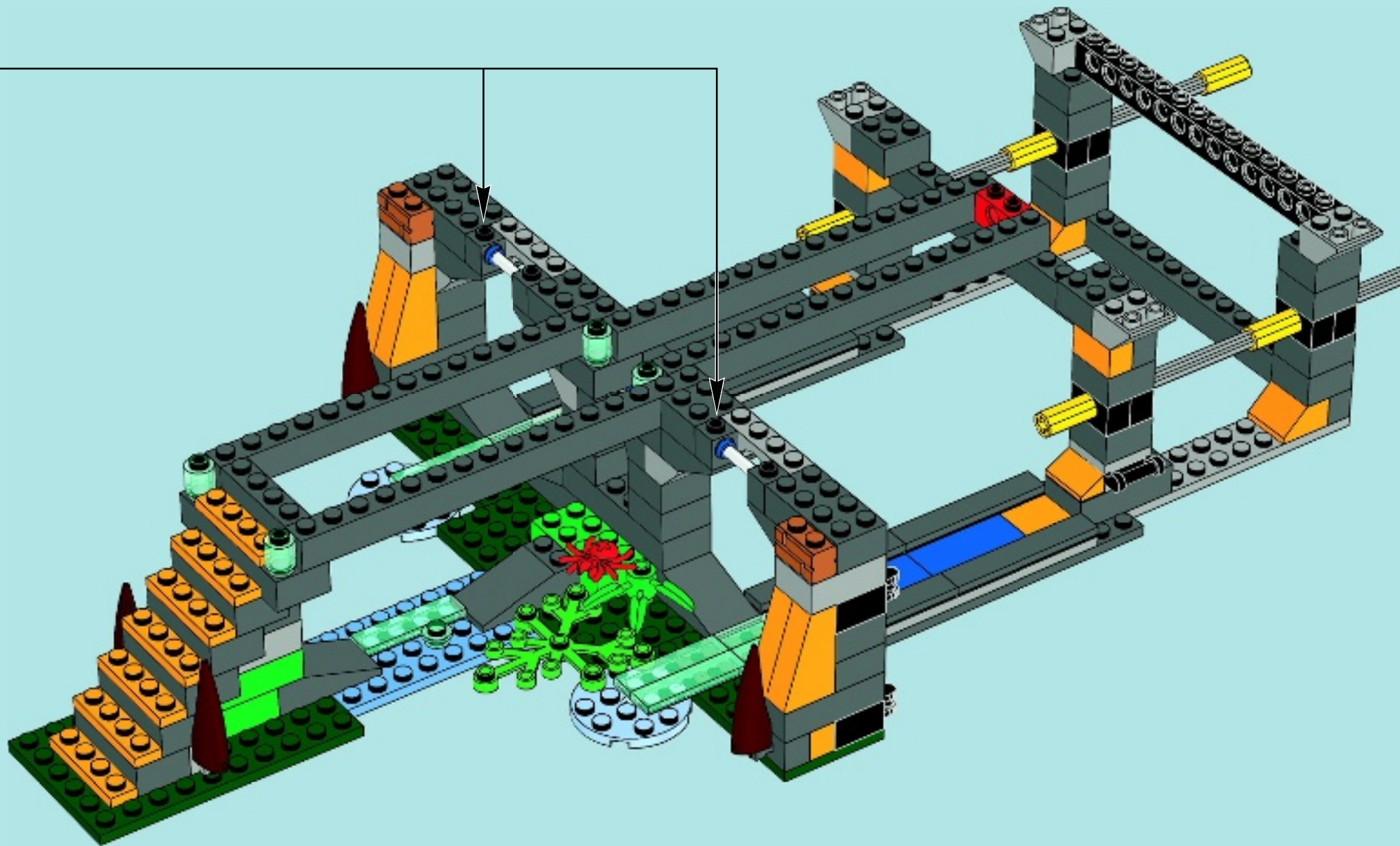

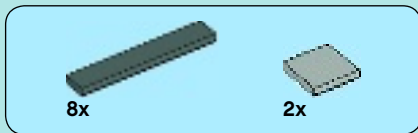

27

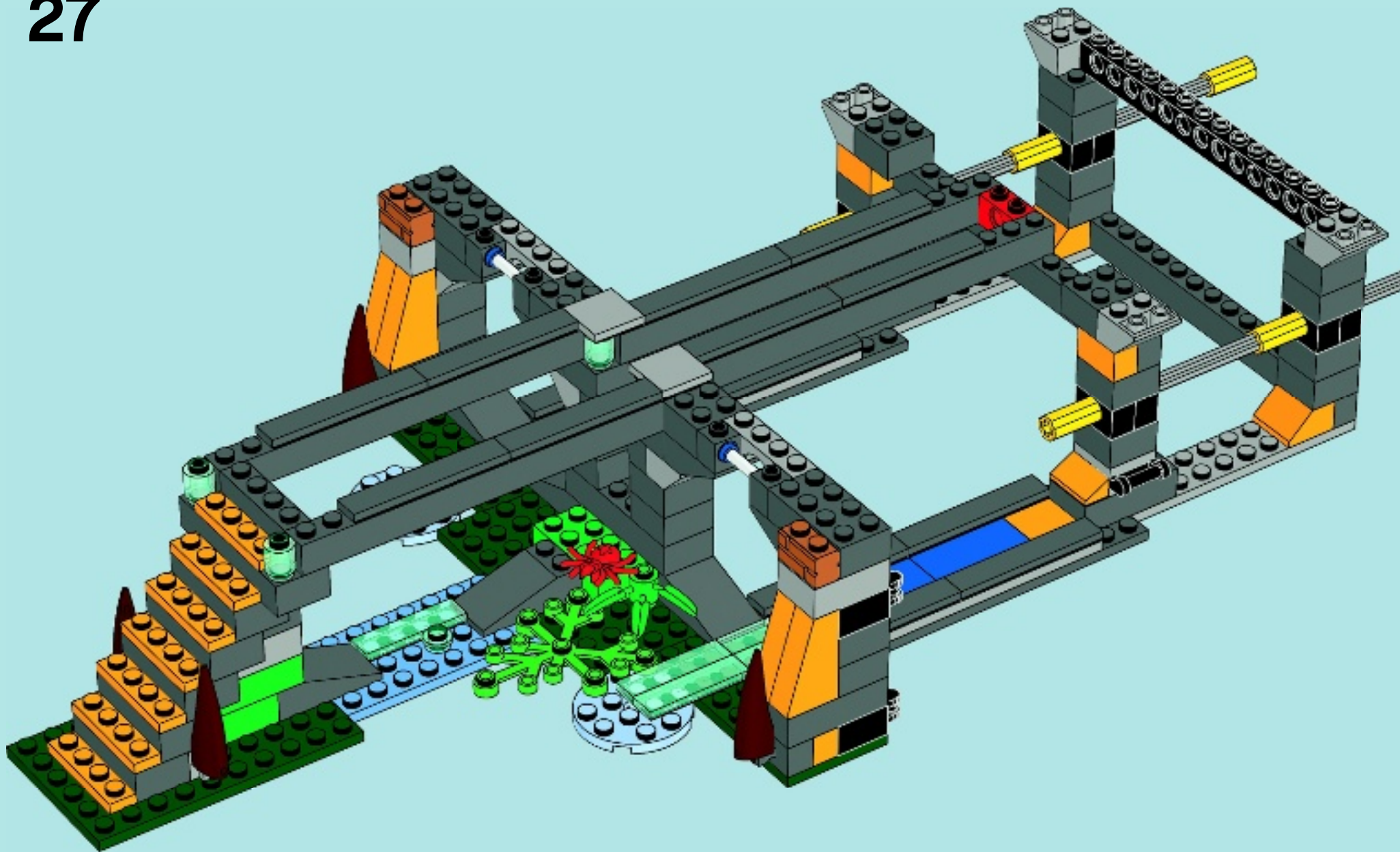

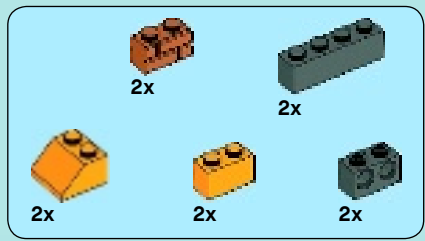

28

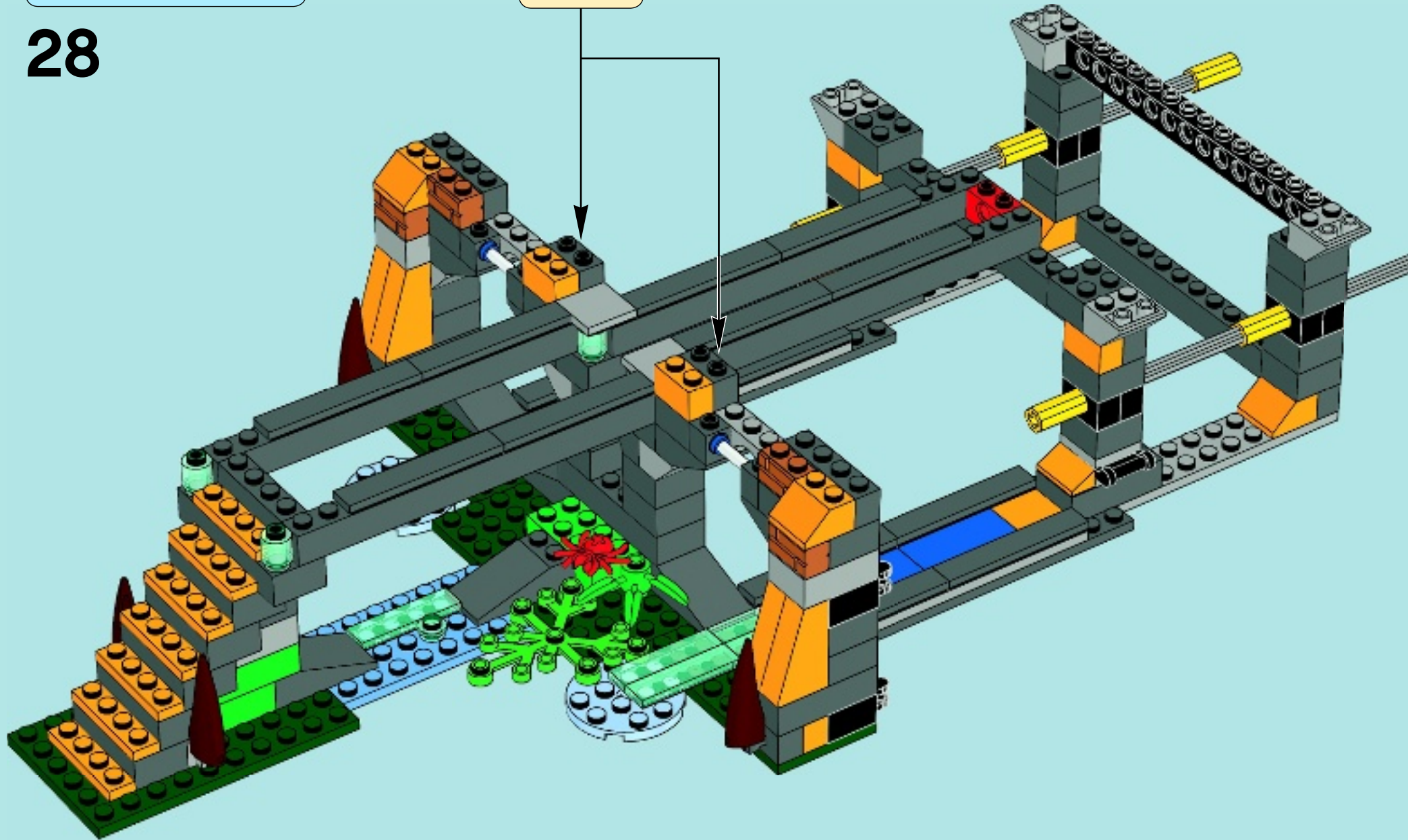
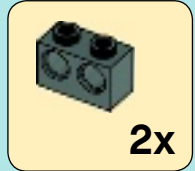

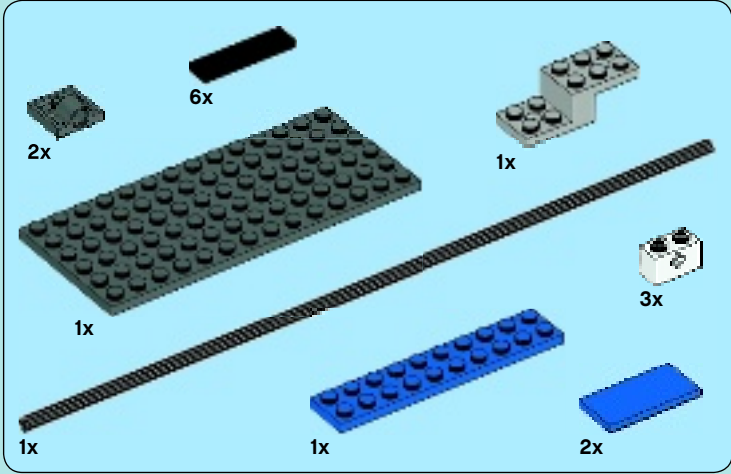
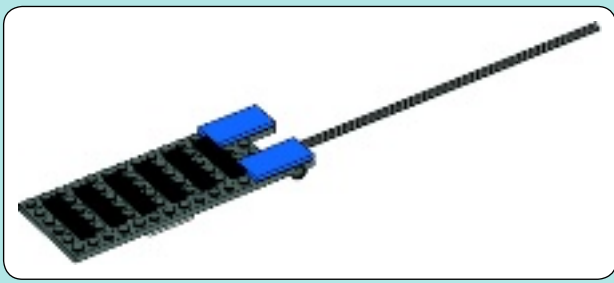

29

1

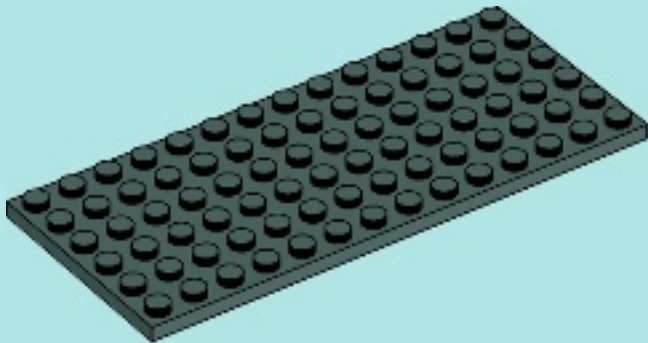

2

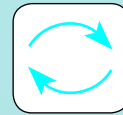
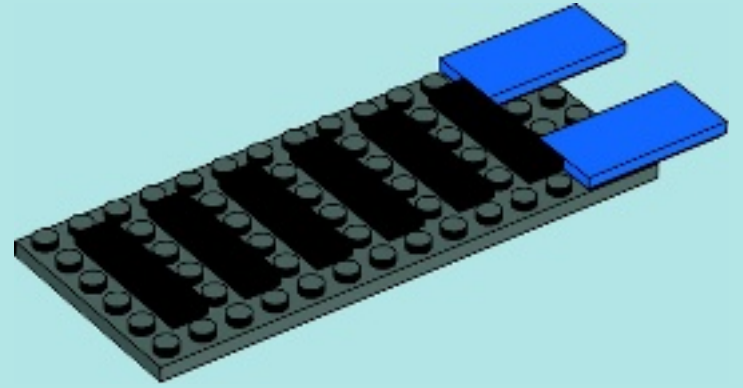

3

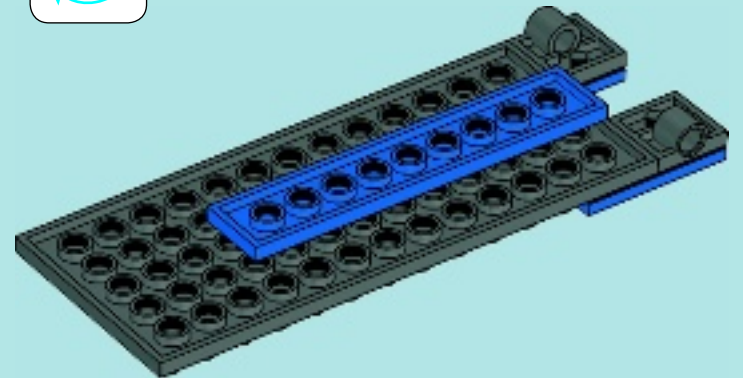

4

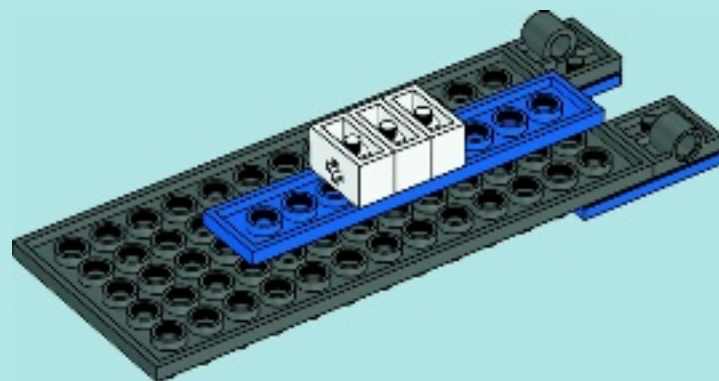

5

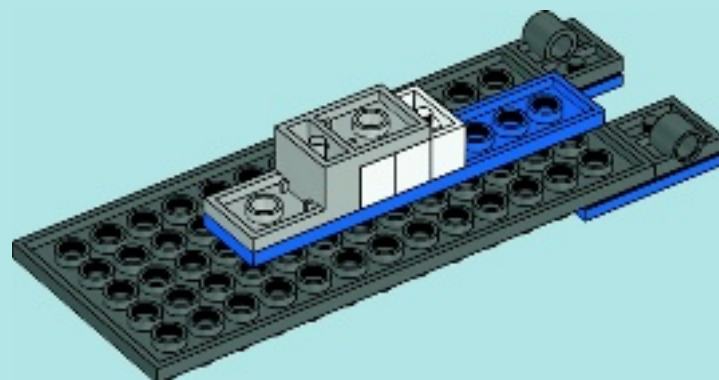

6

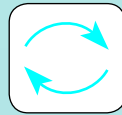
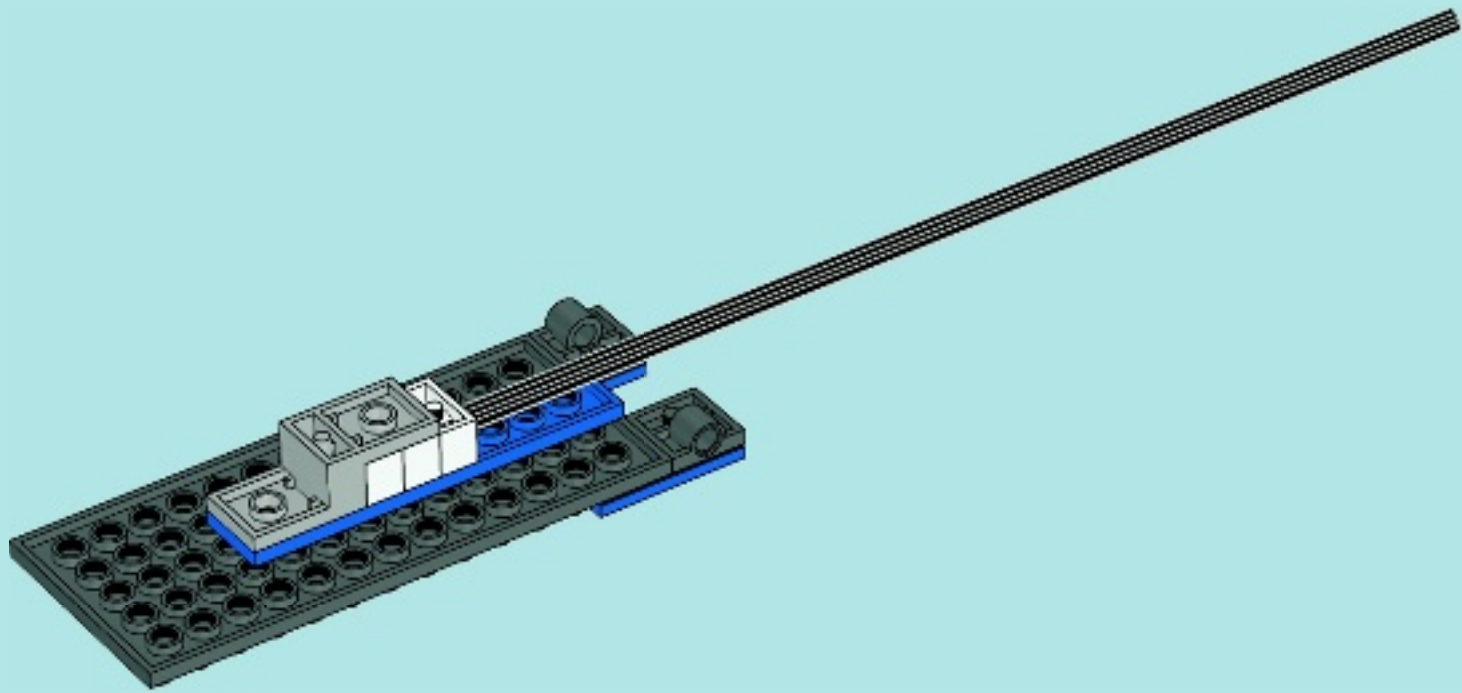

7

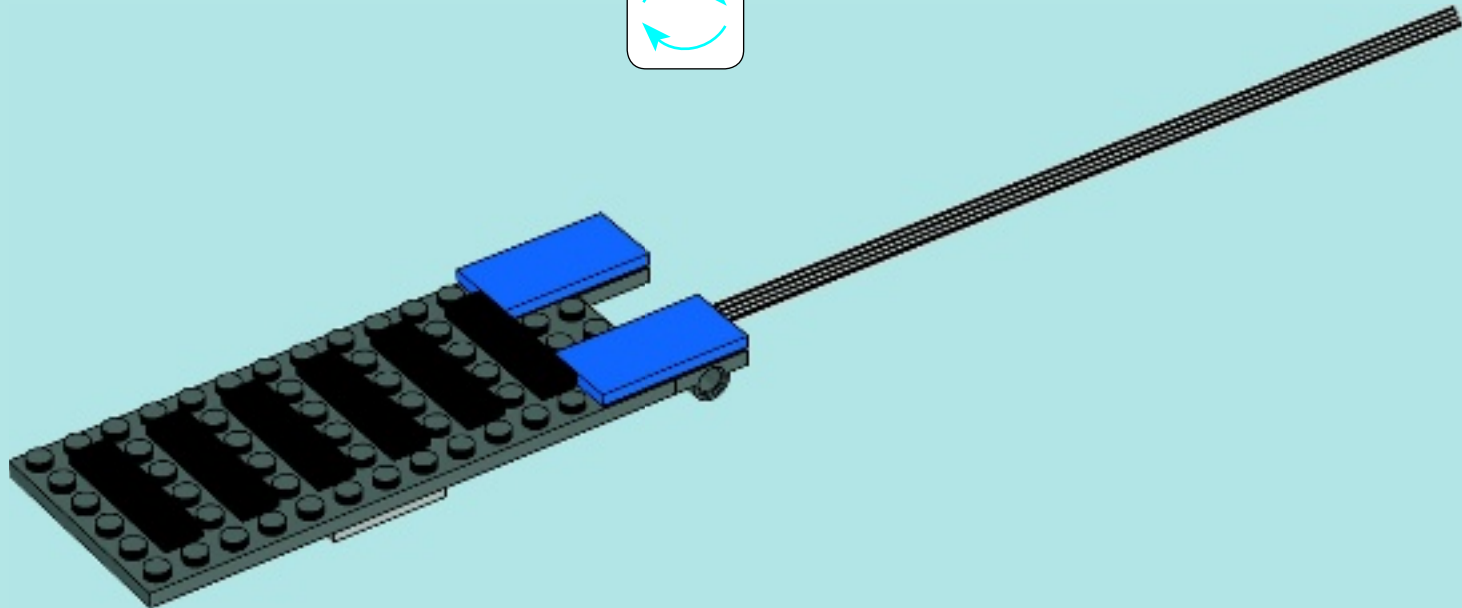

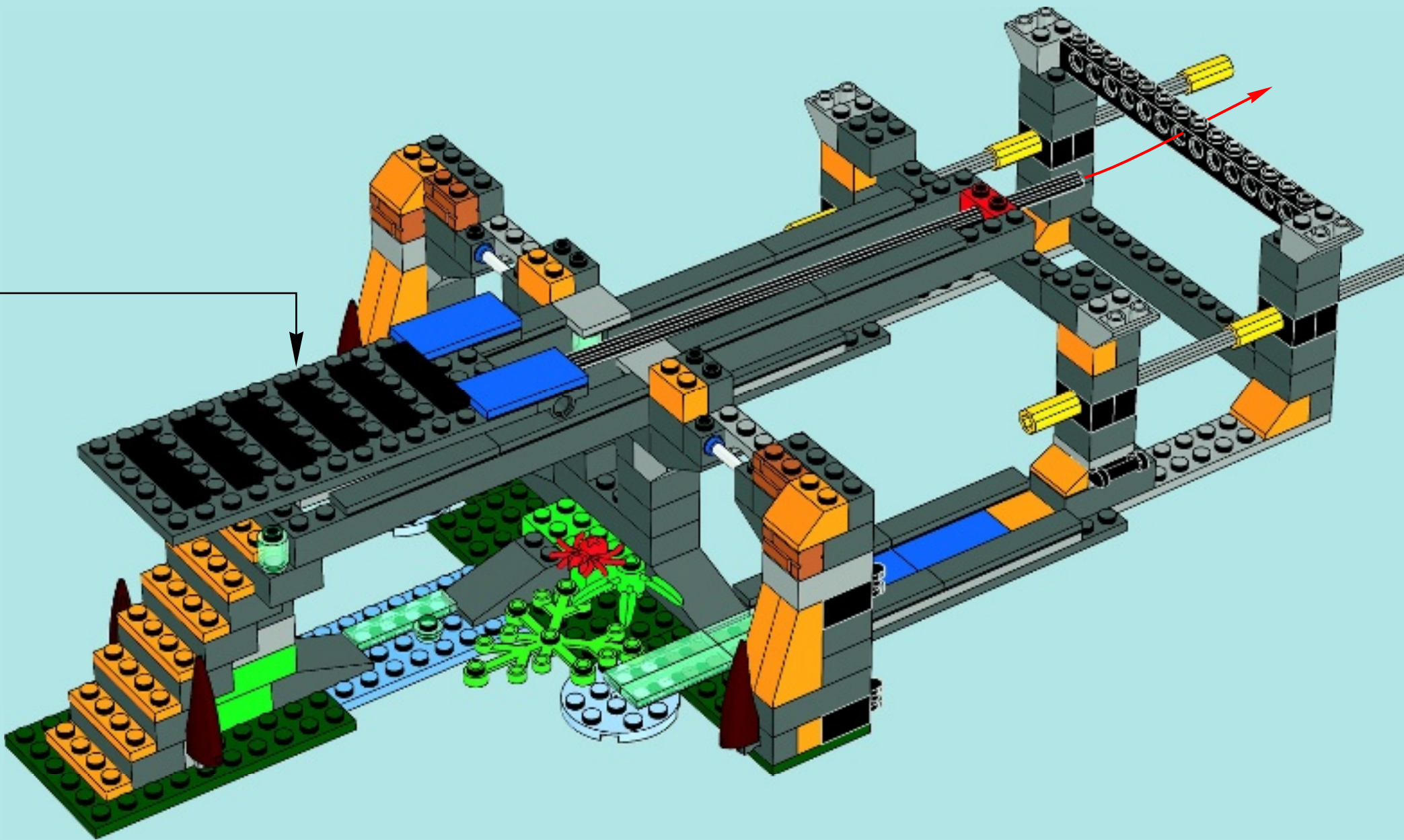



1x

30

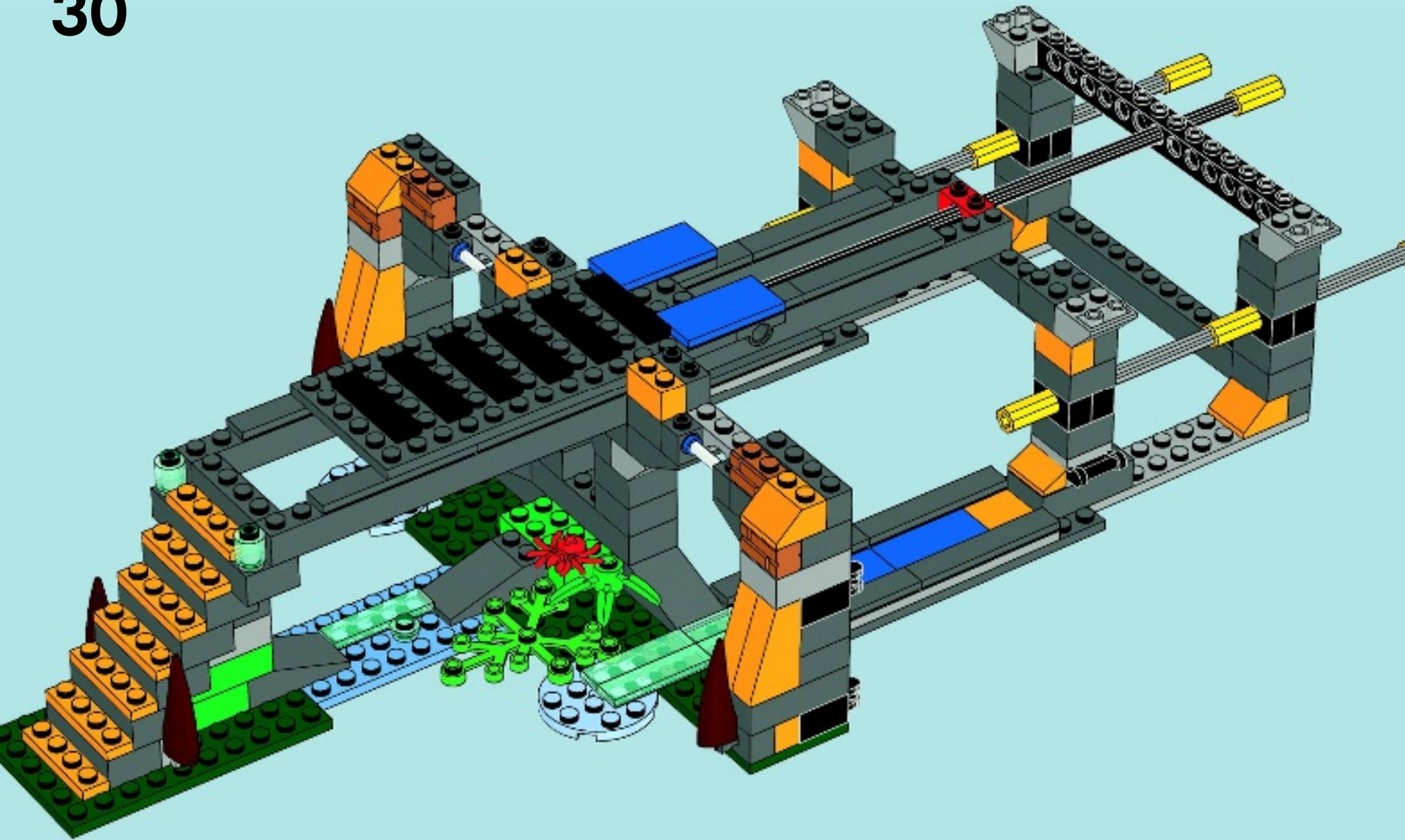

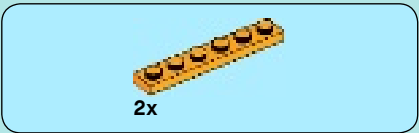

31

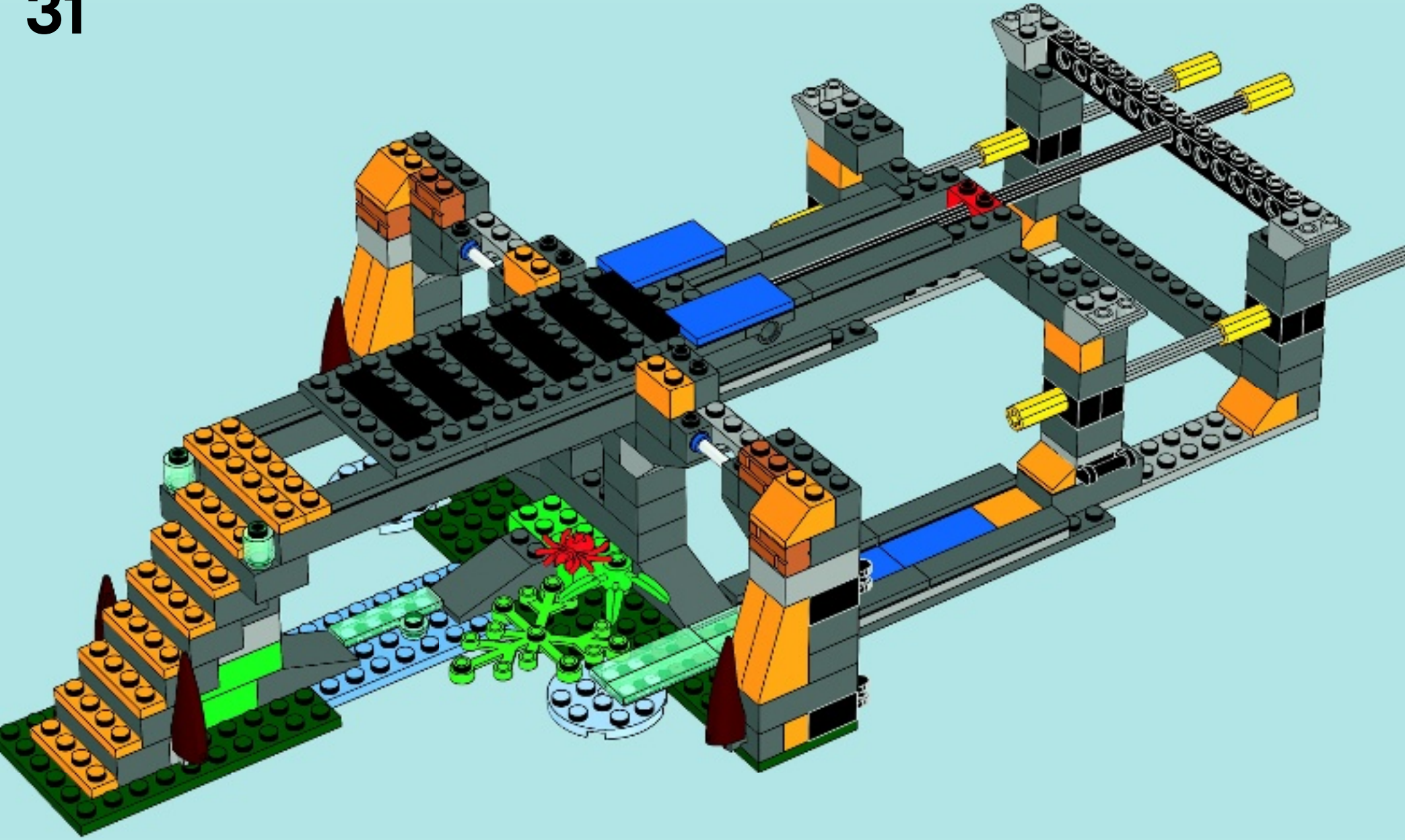



2x



2x

32

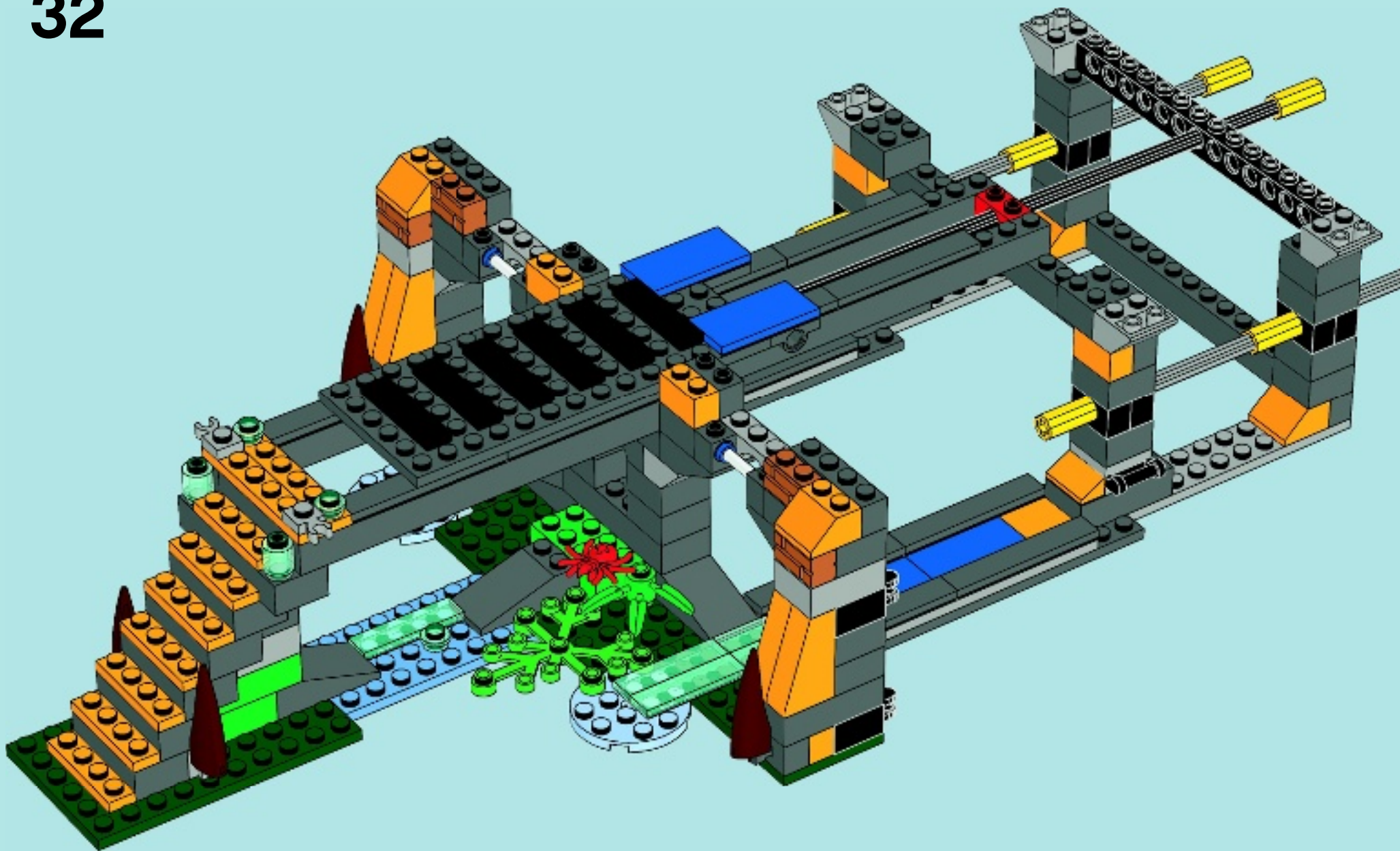

		
2x	2x	2x

33



2x

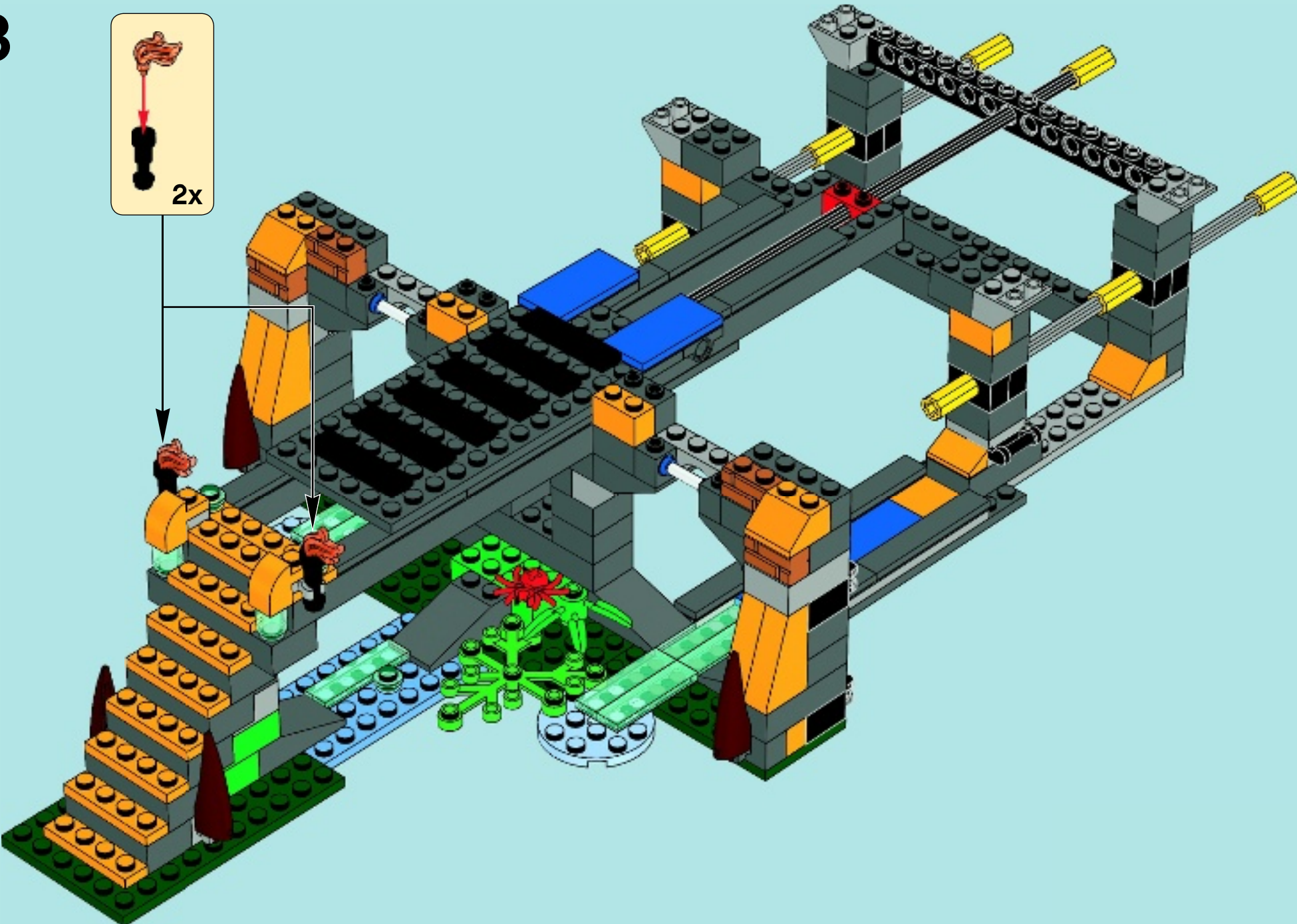

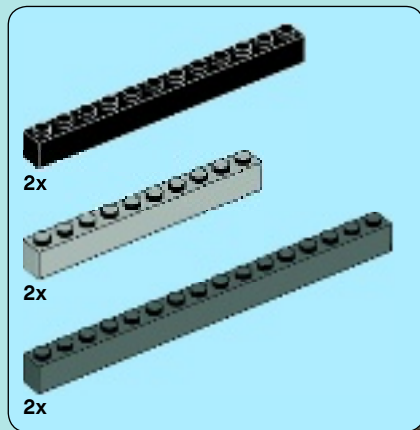
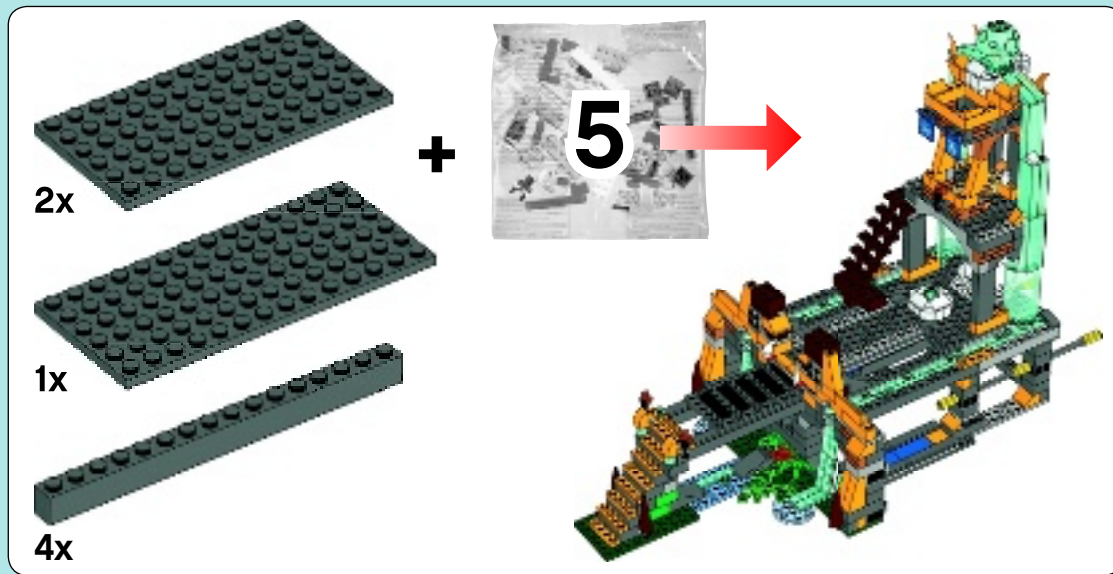

34

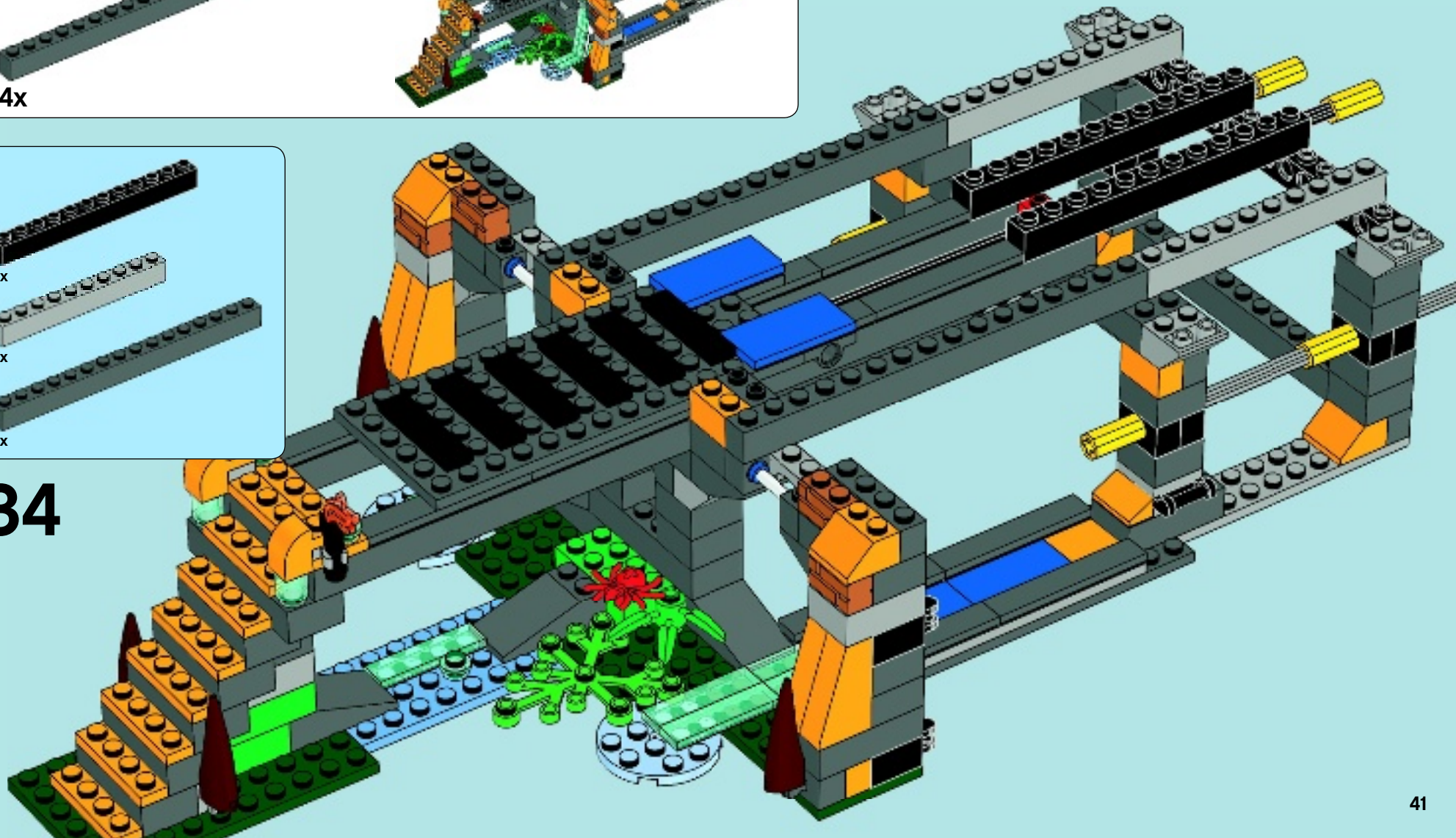

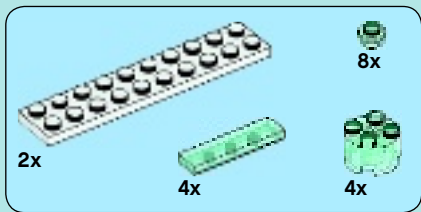

35

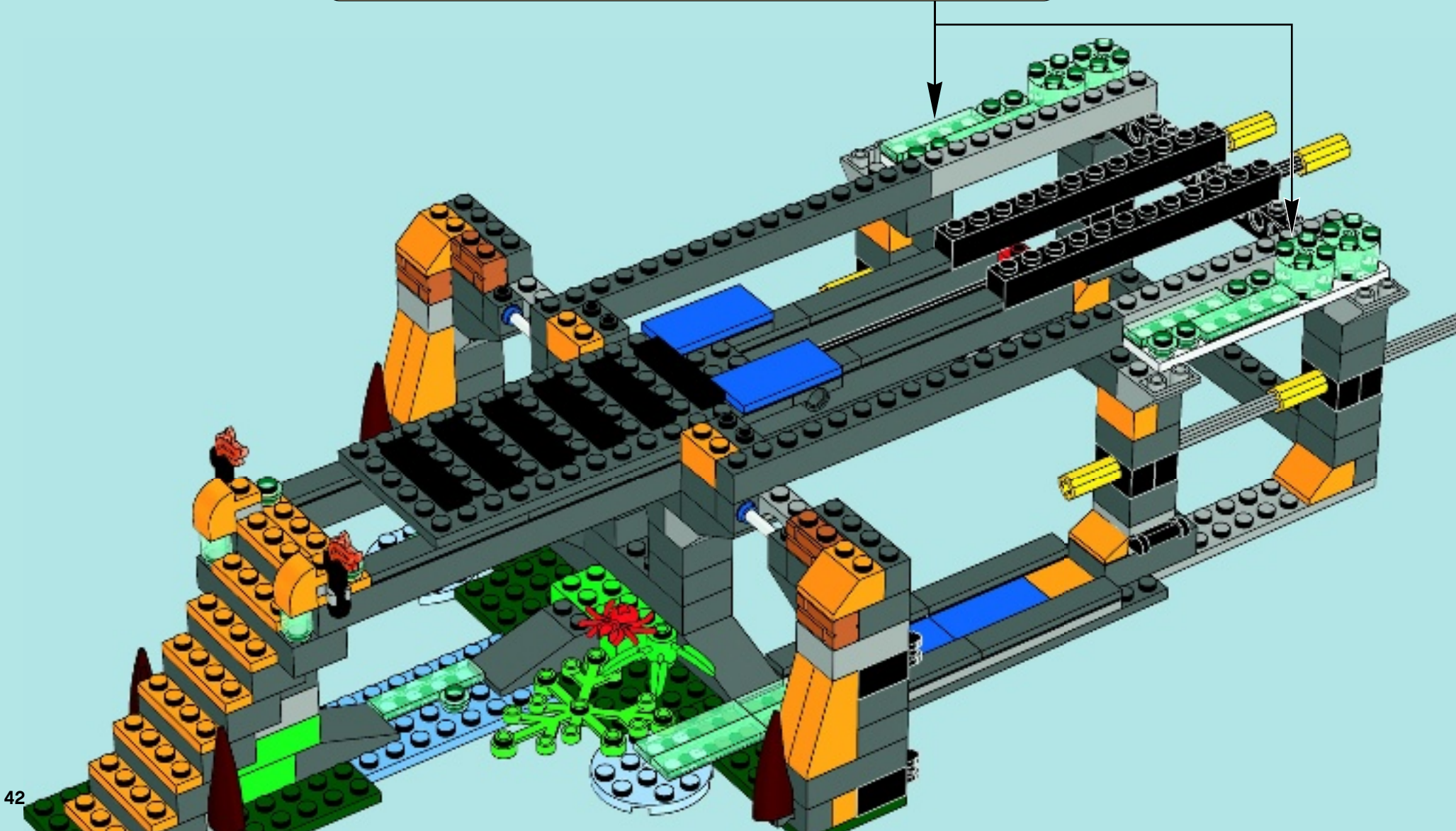
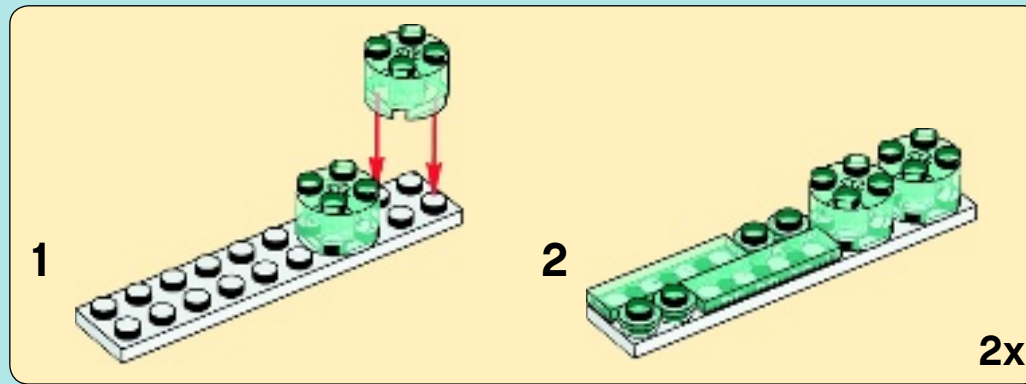

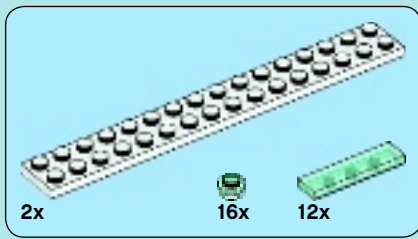

36

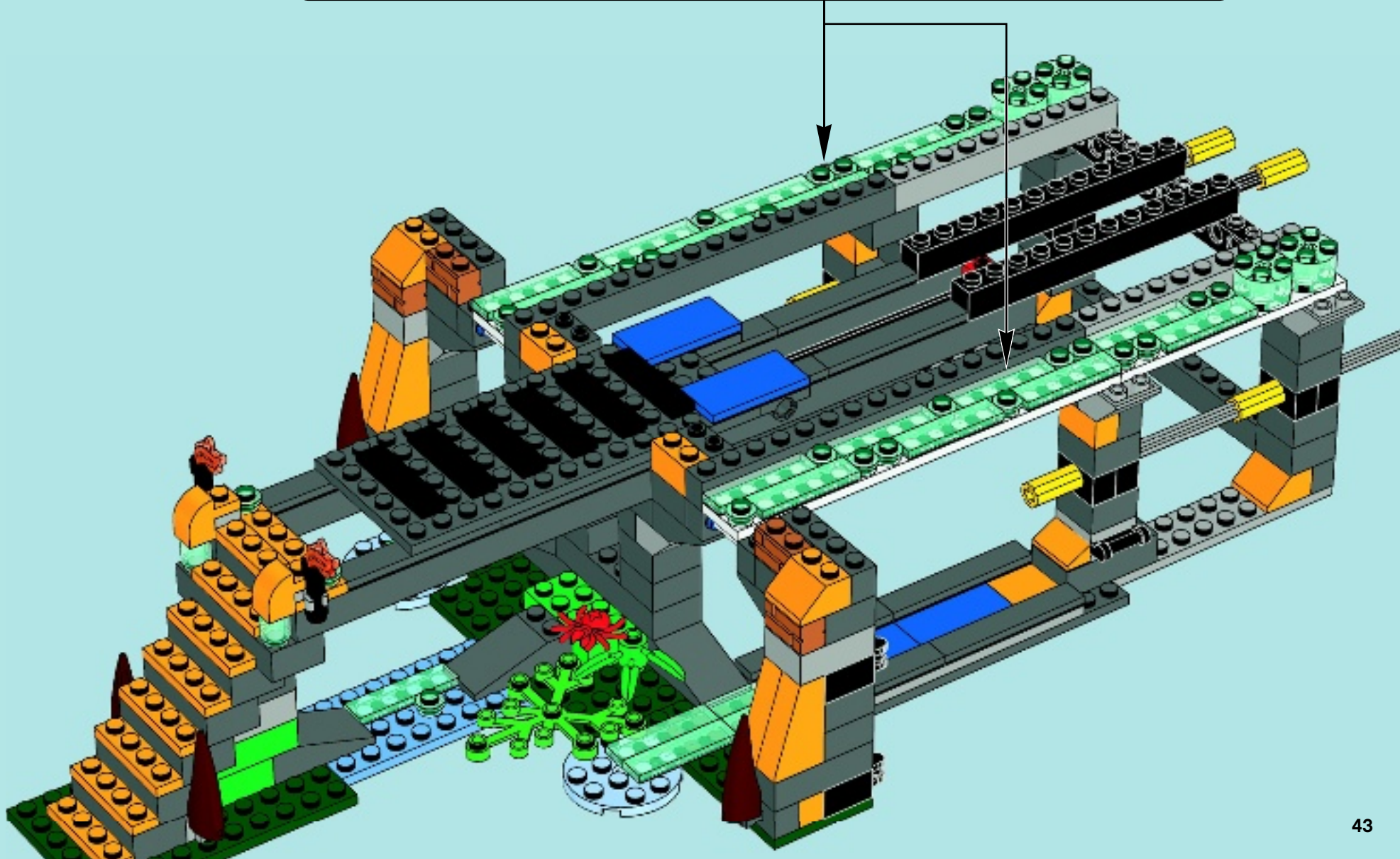
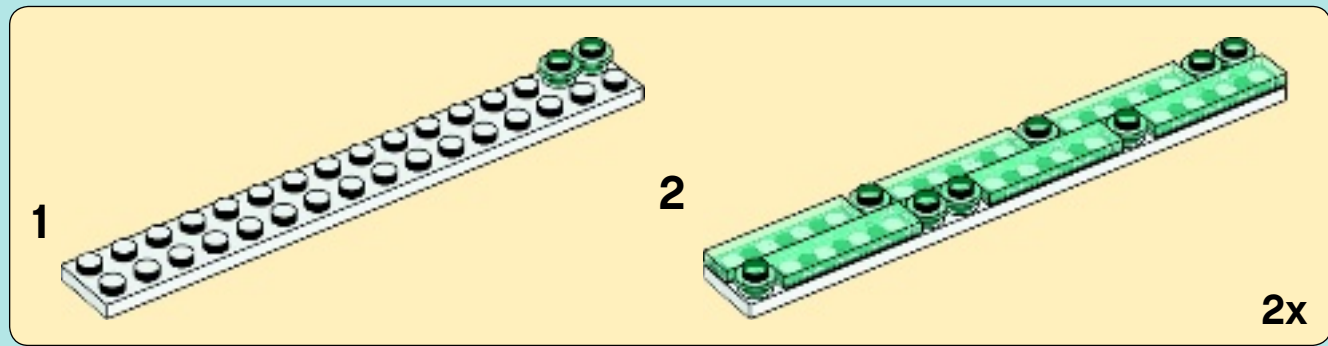

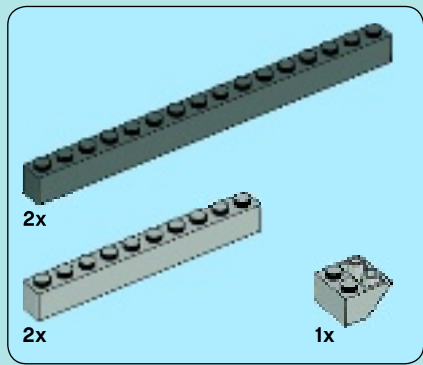

37

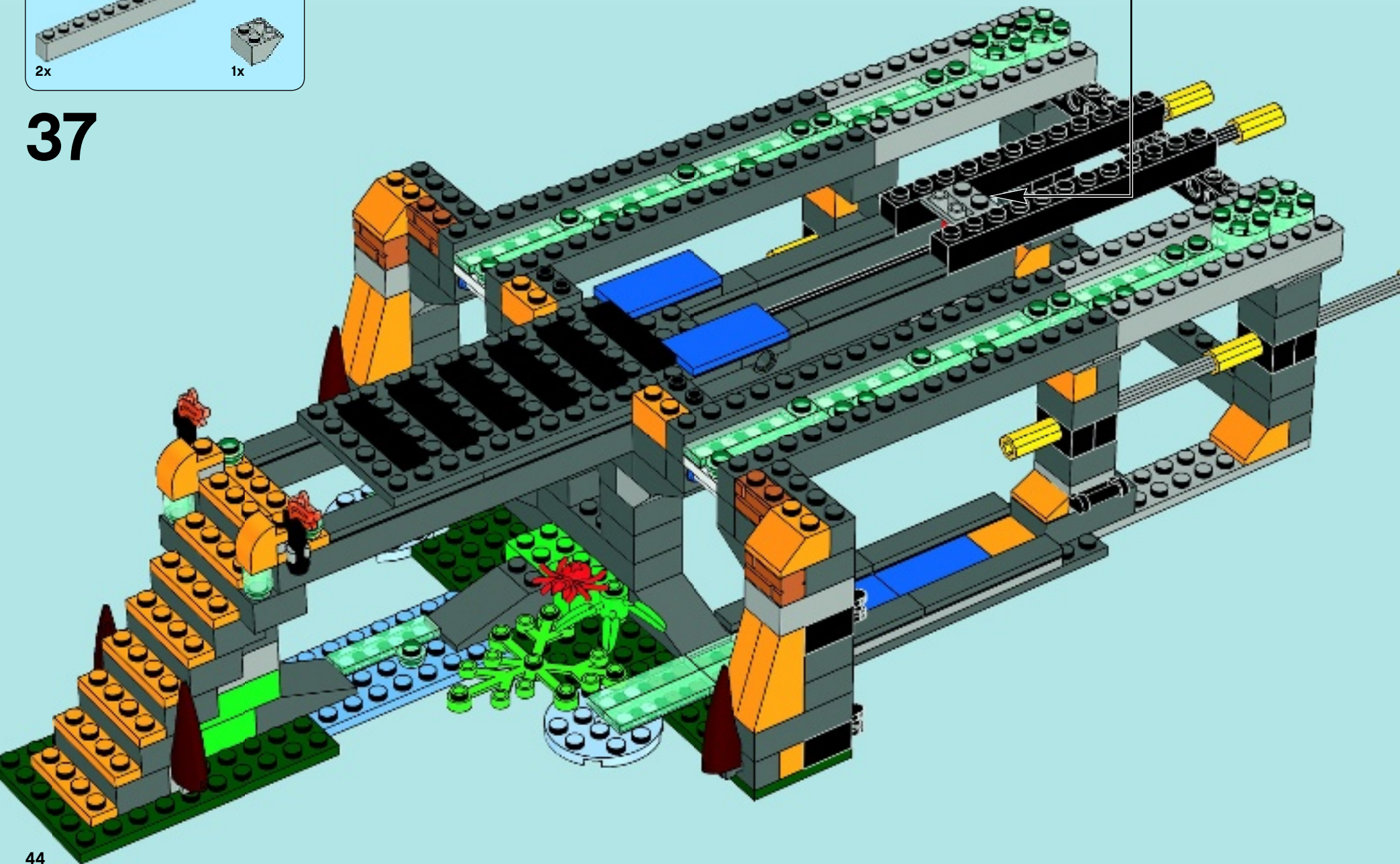
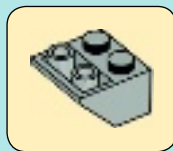

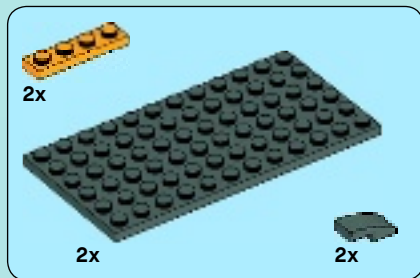

38

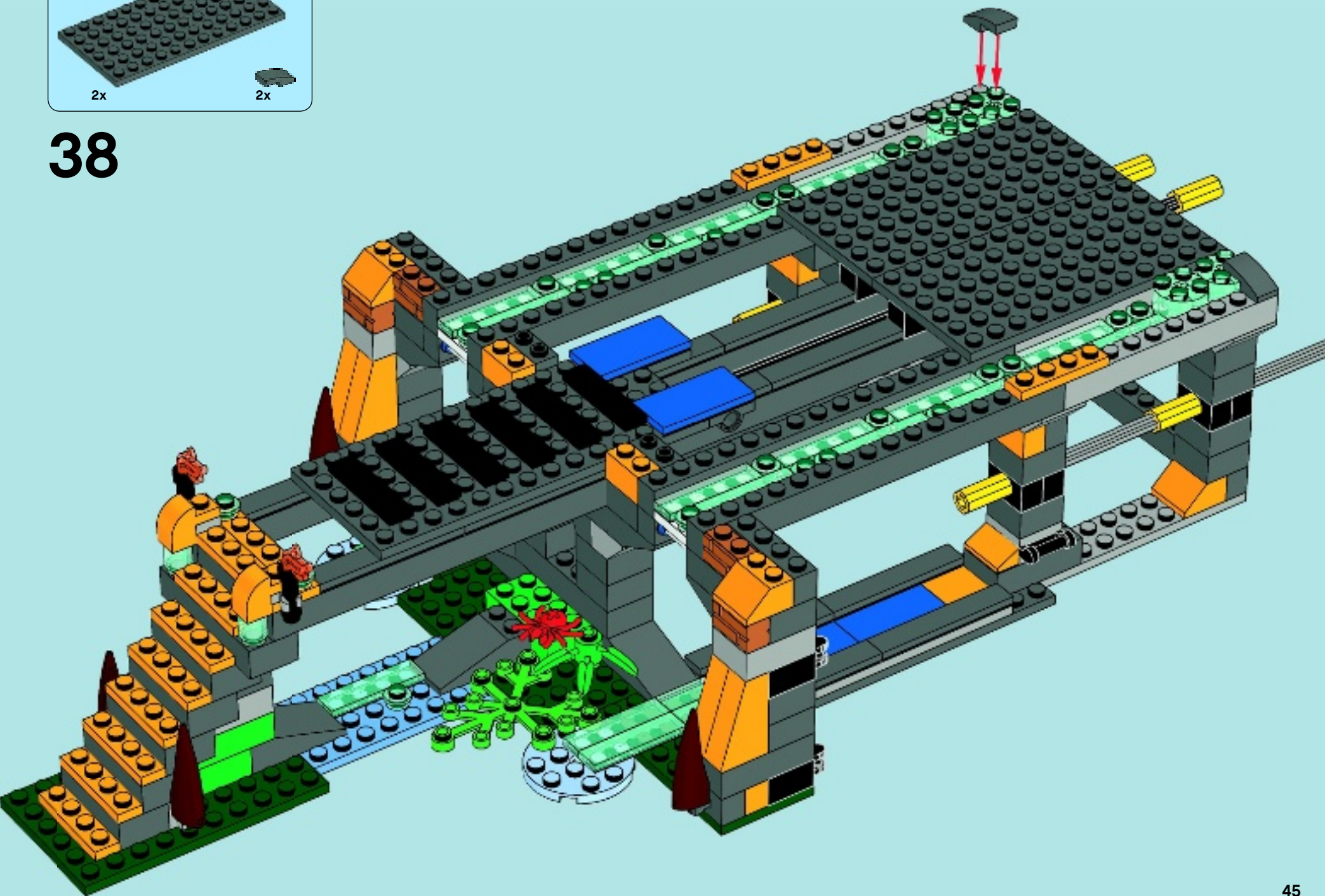

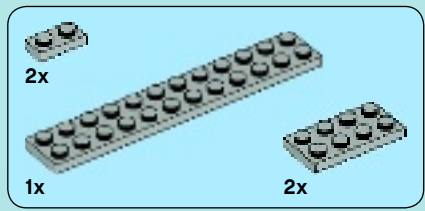

39

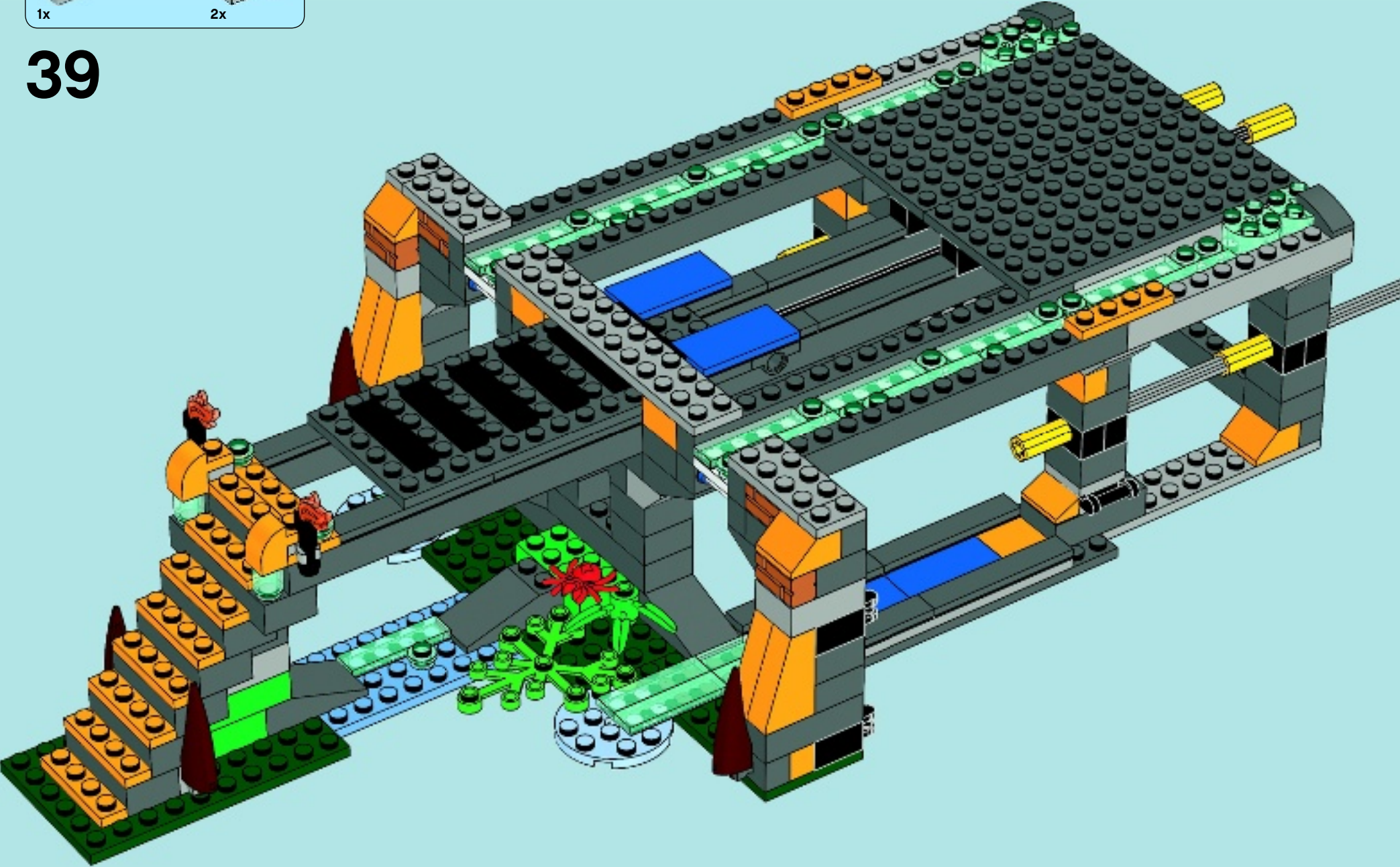



40

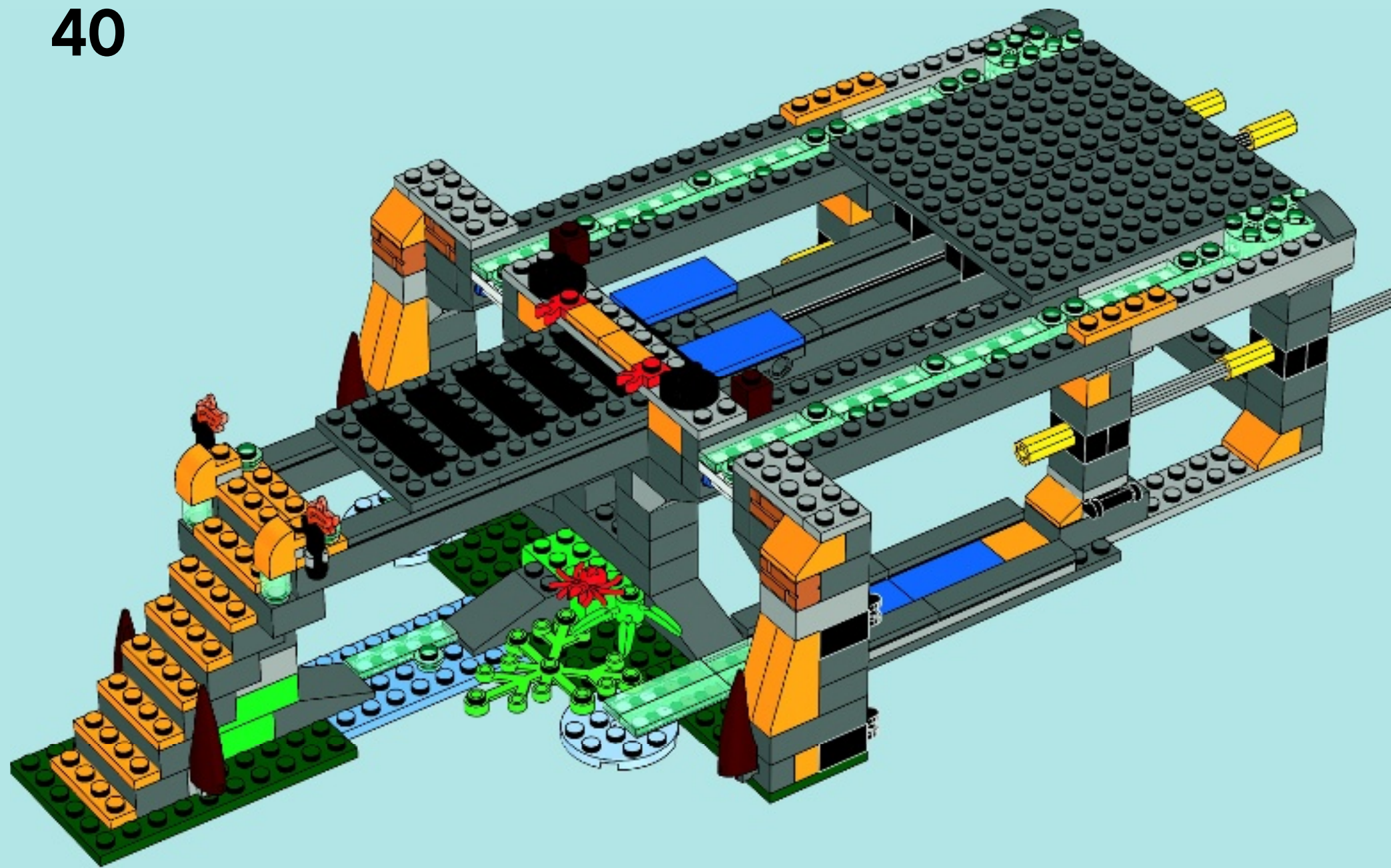

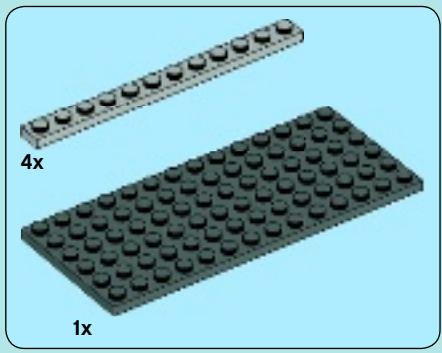

41

1

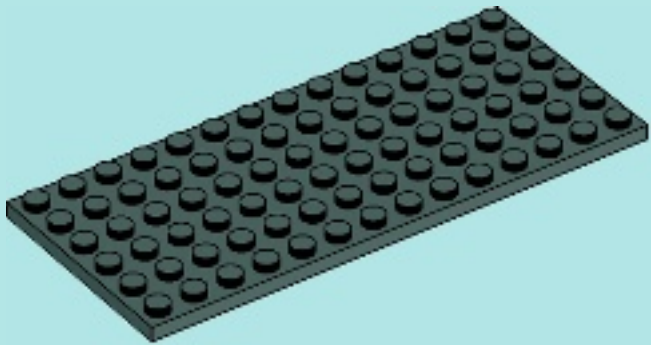

2

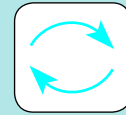
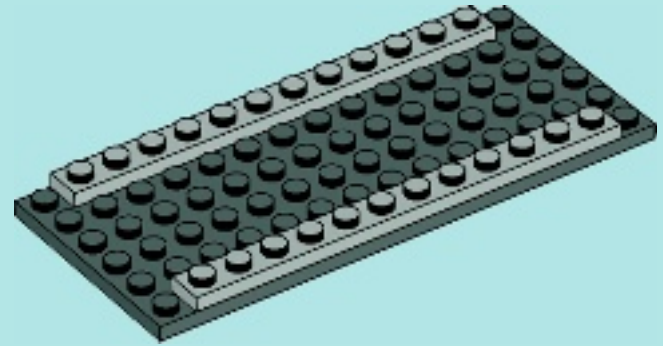

3

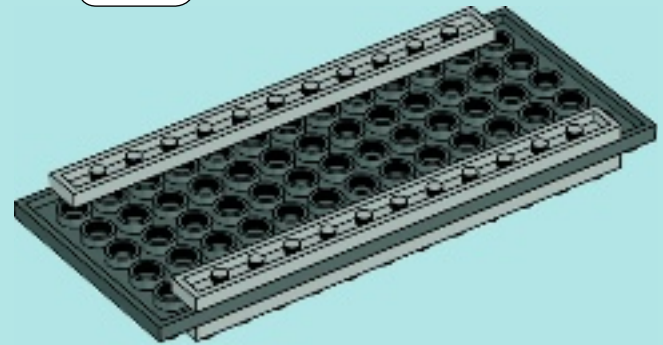

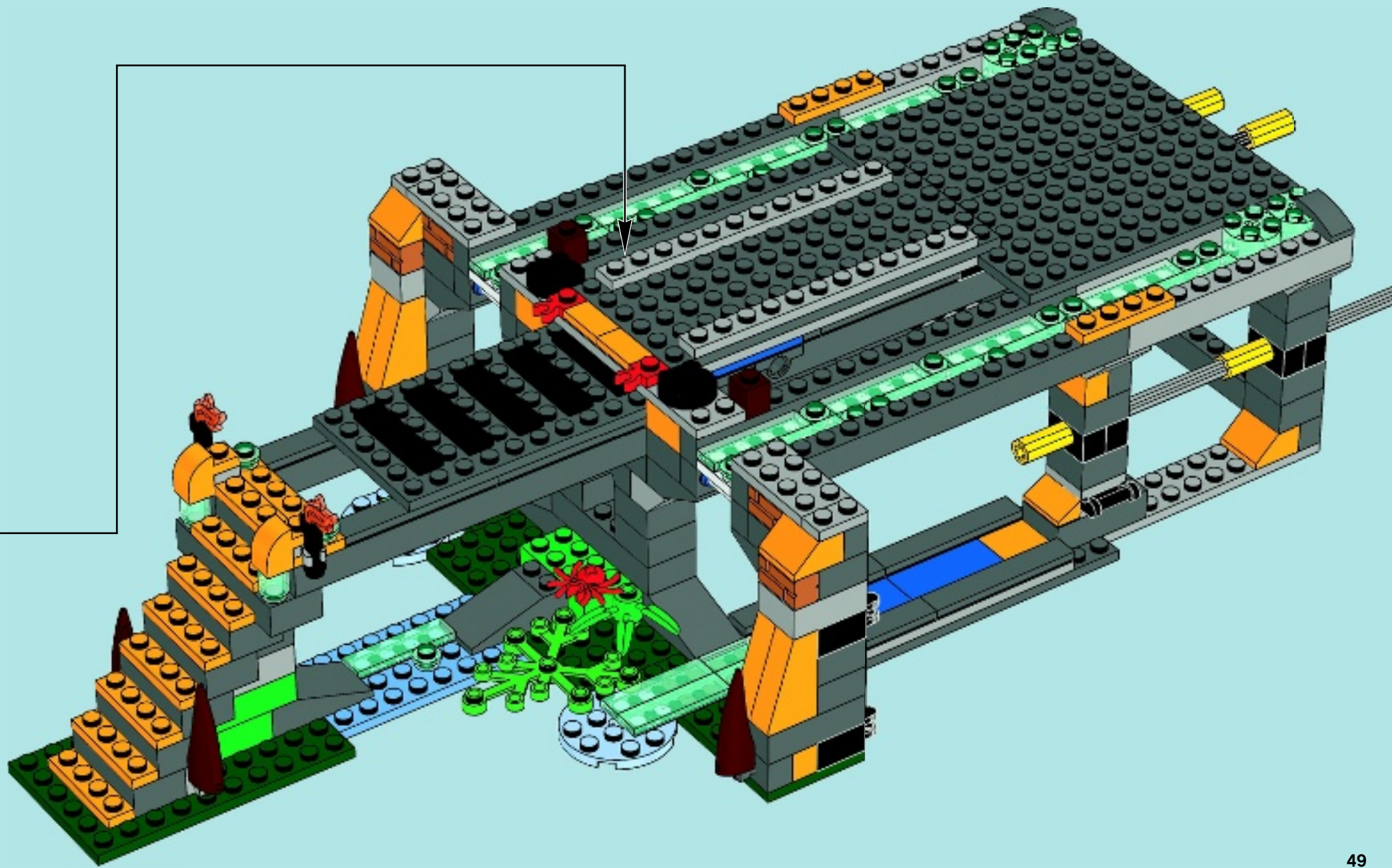

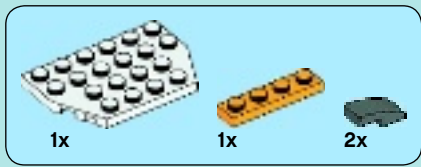

42

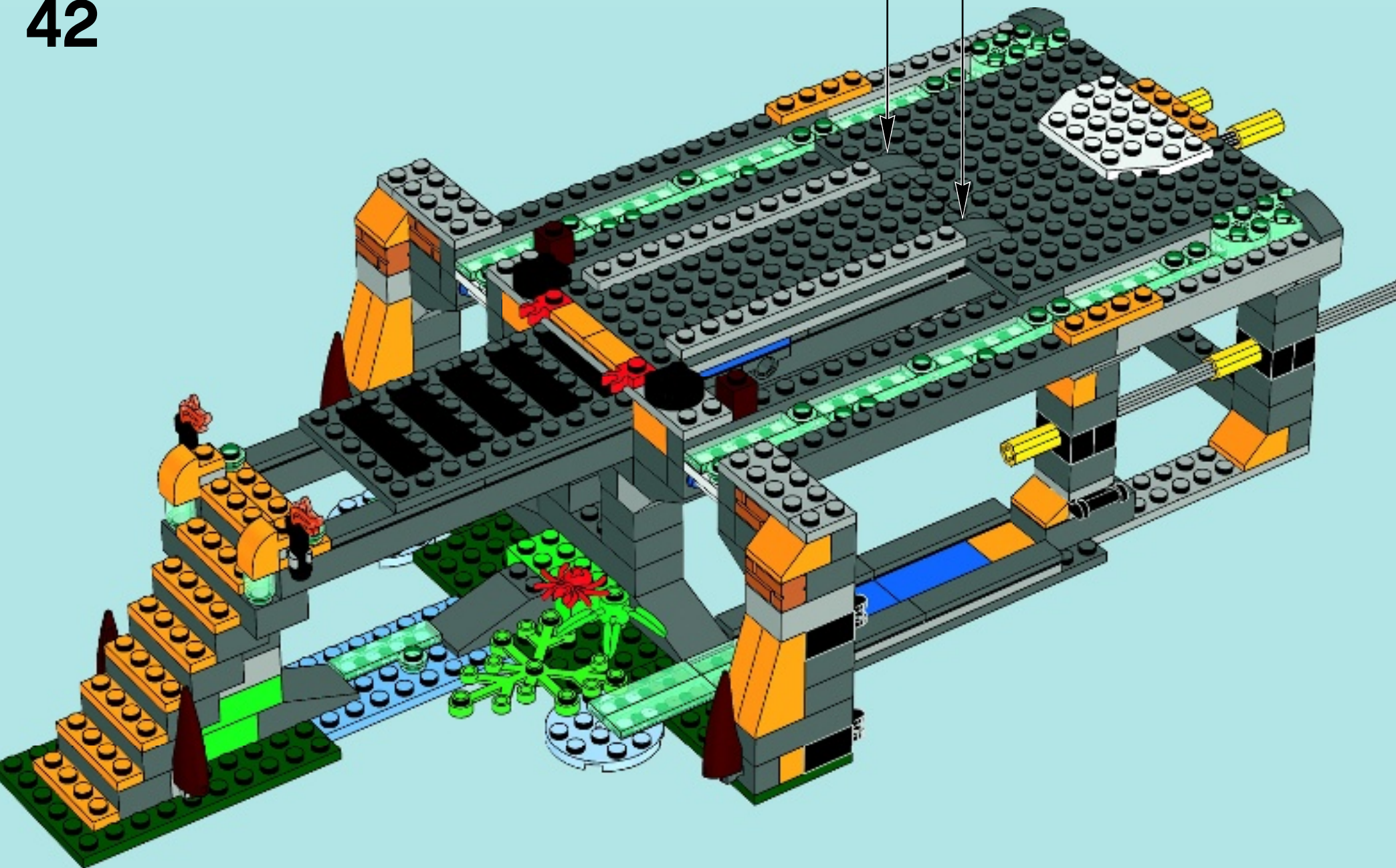

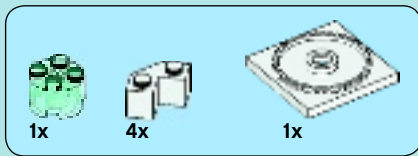

43

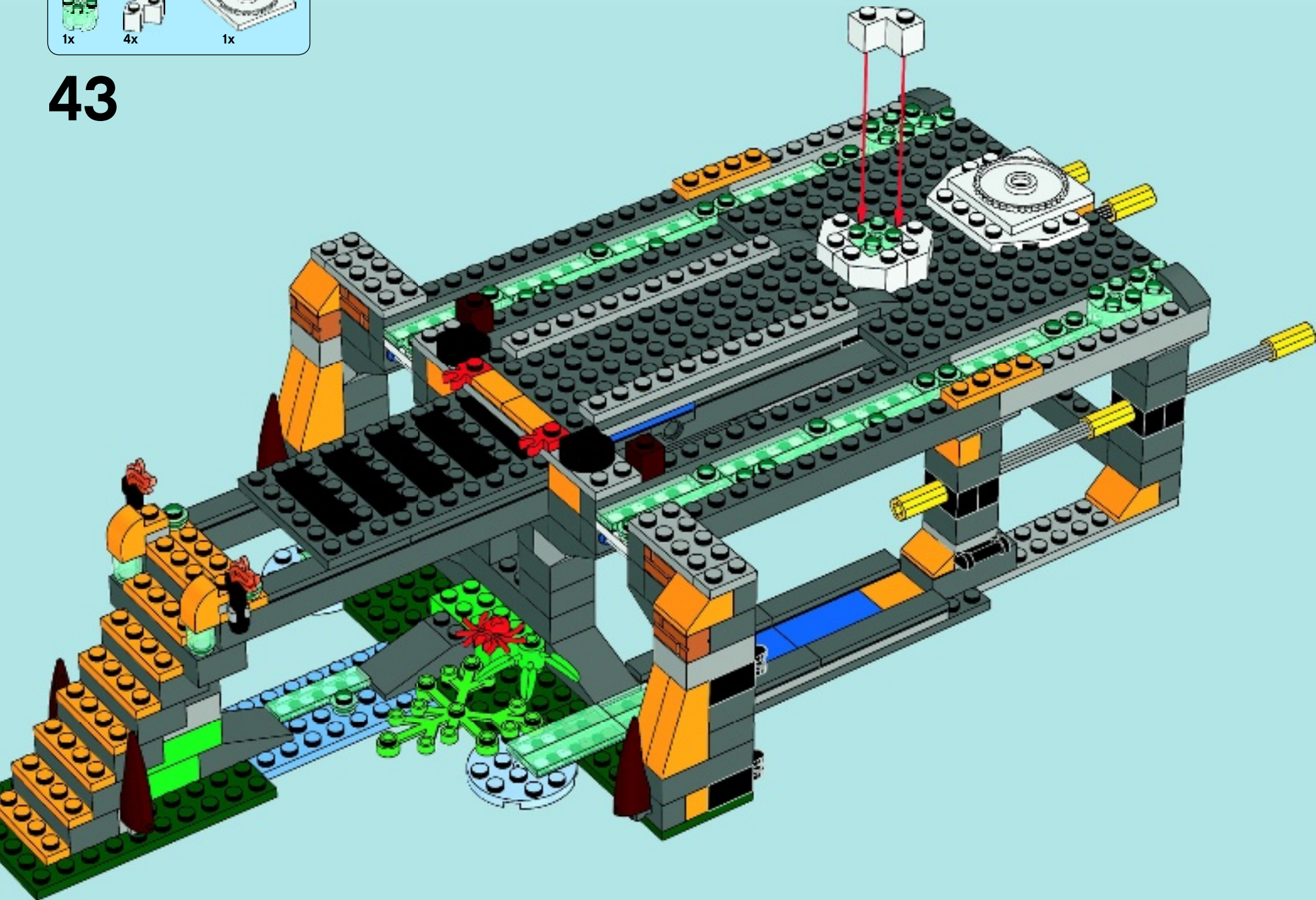

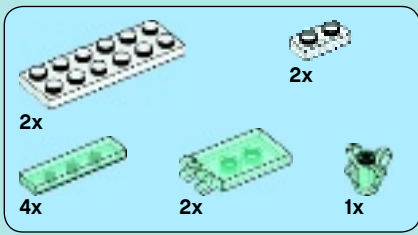

45

1



2

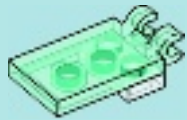

3

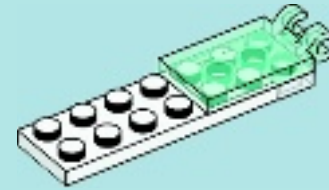

4

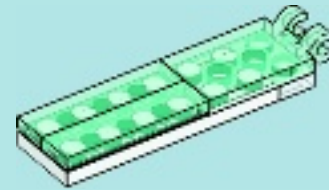

2x

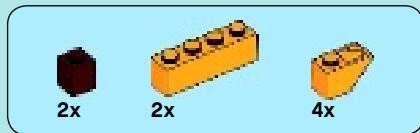

46

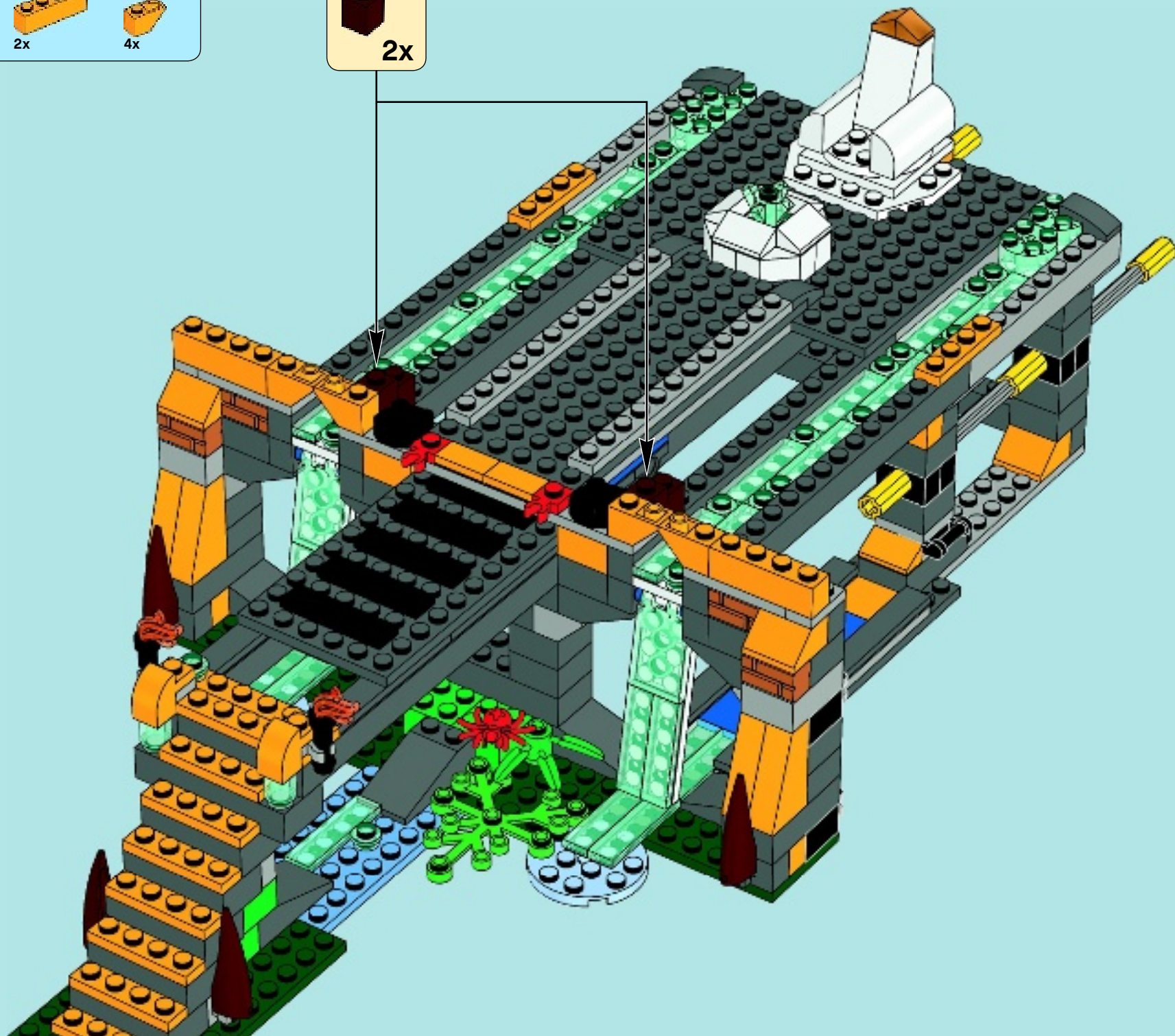

2x 2x 4x

47

2x

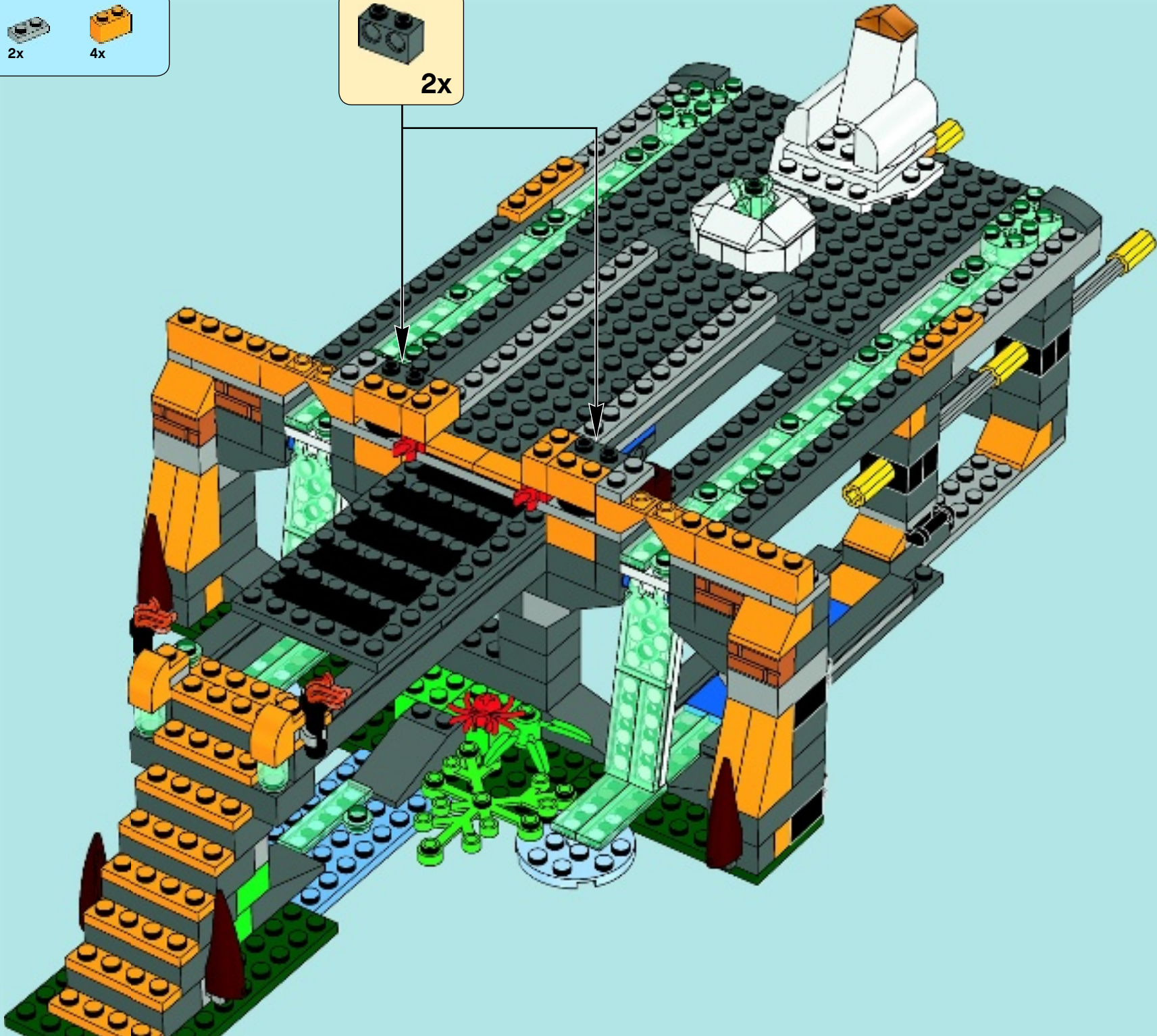



48

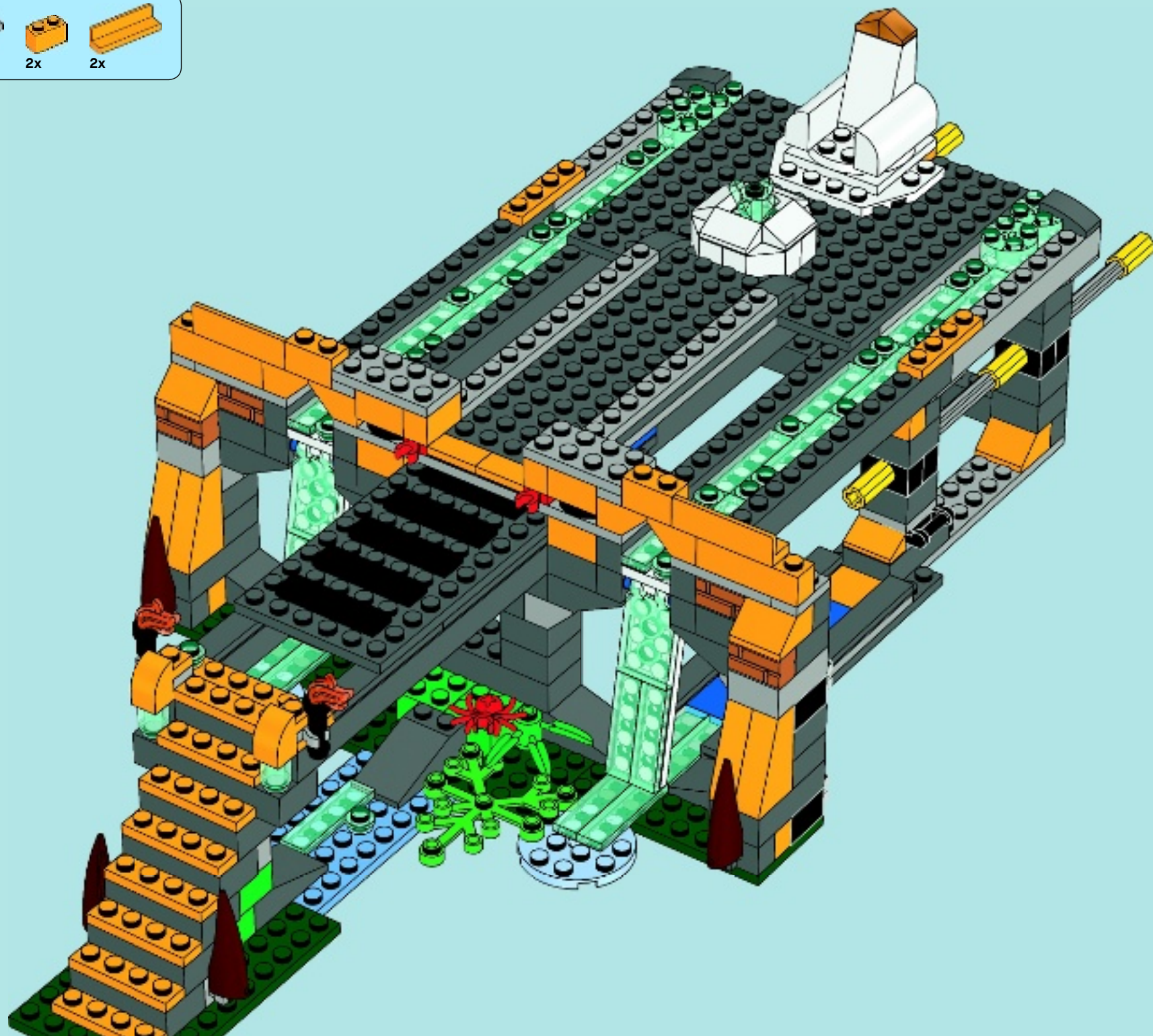

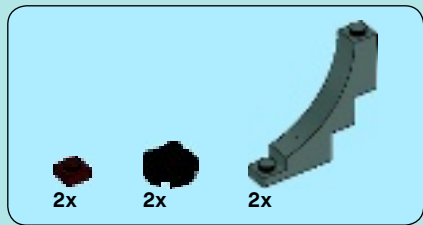

49

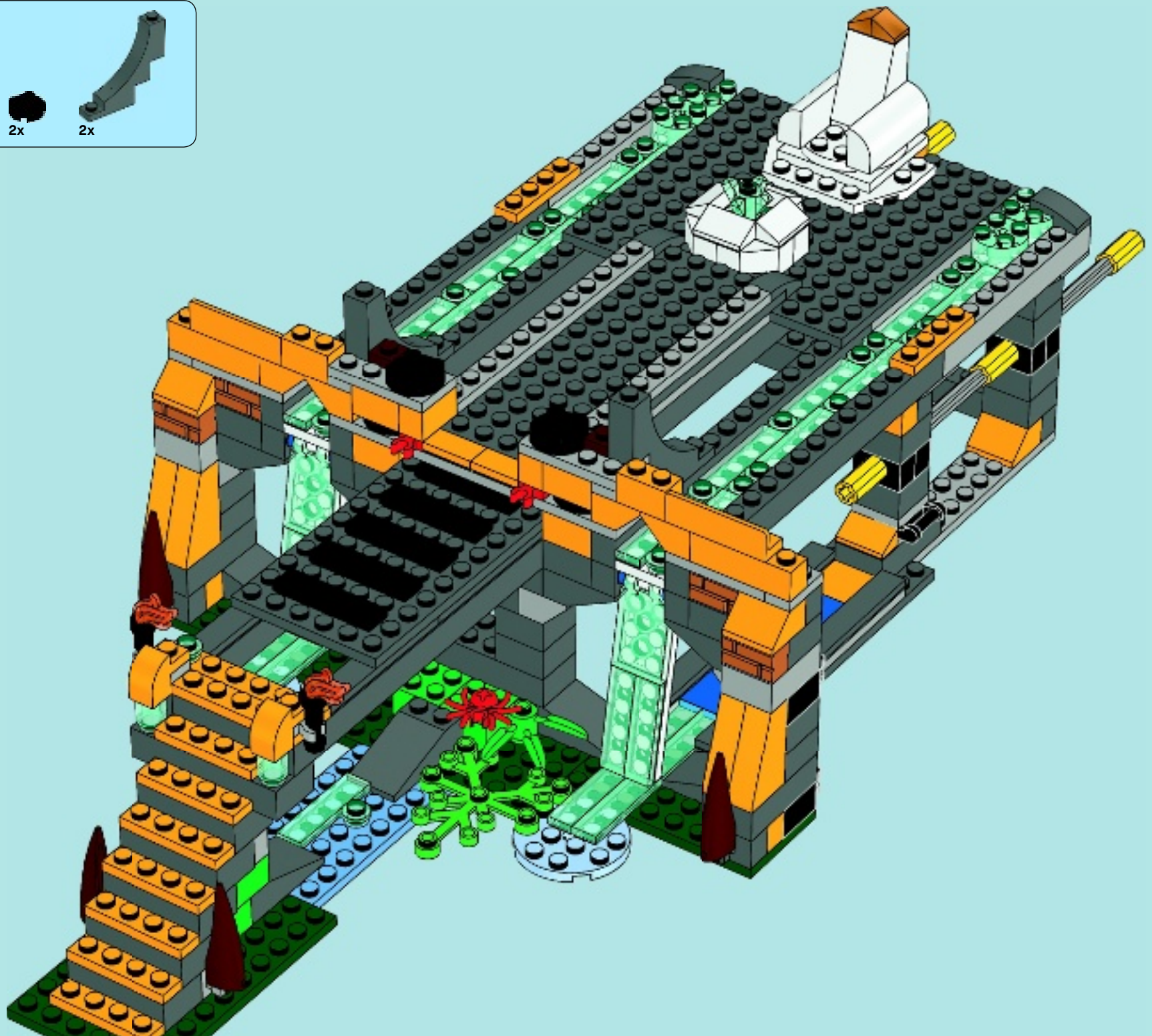

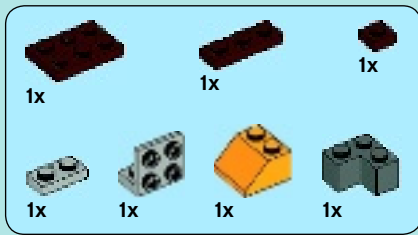

50

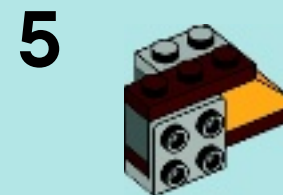
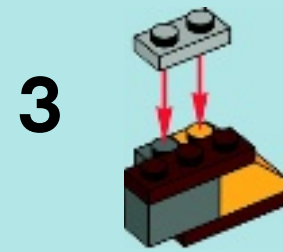
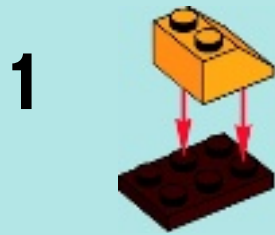

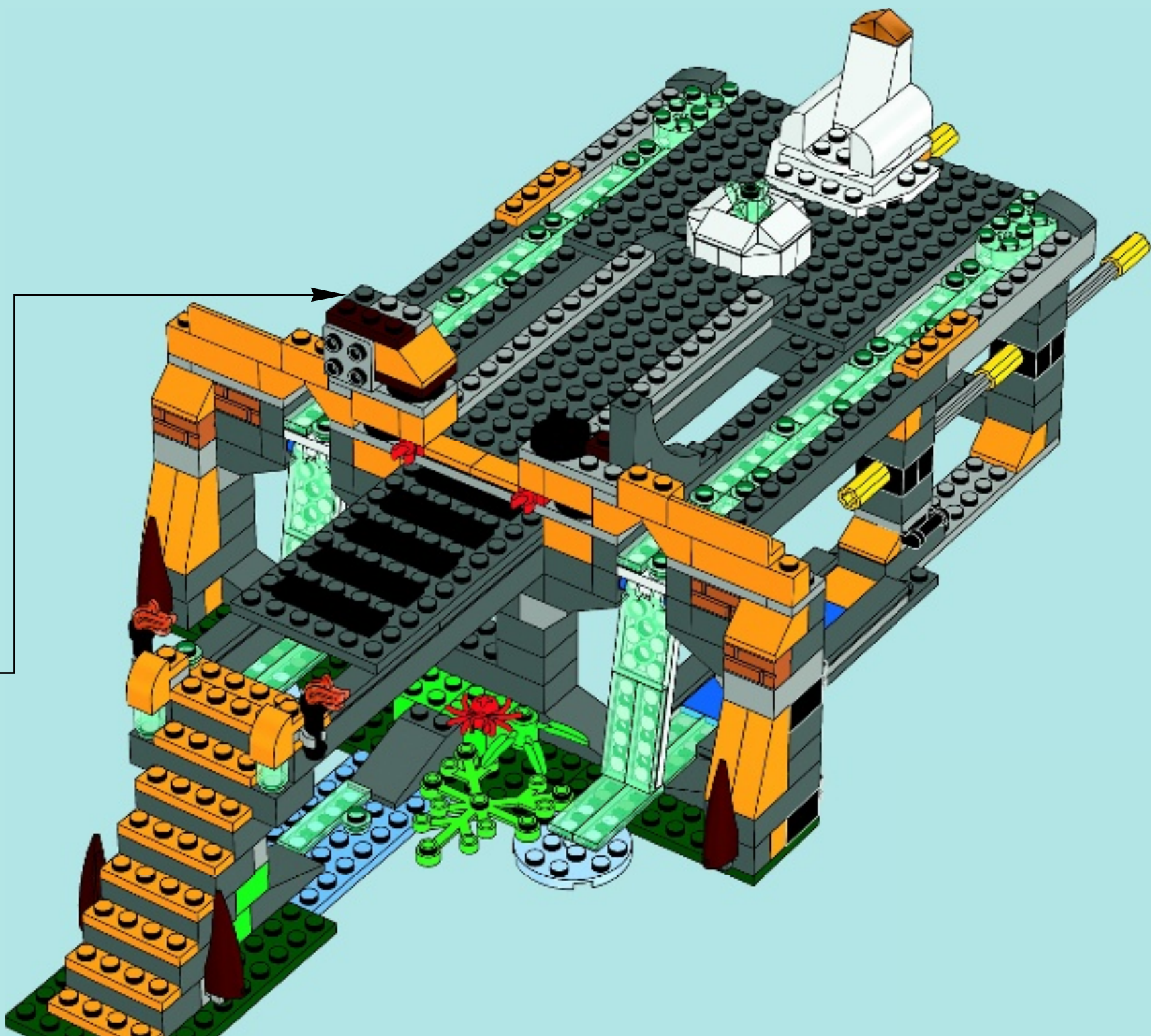

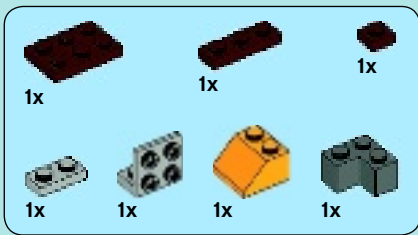

51

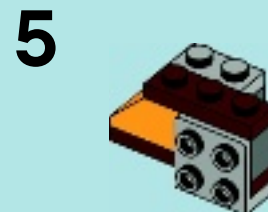
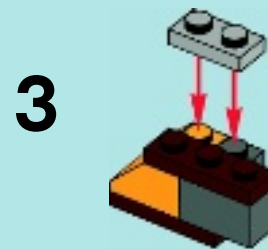
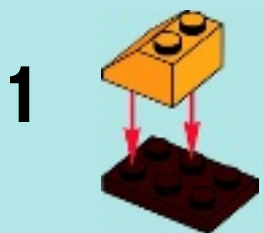

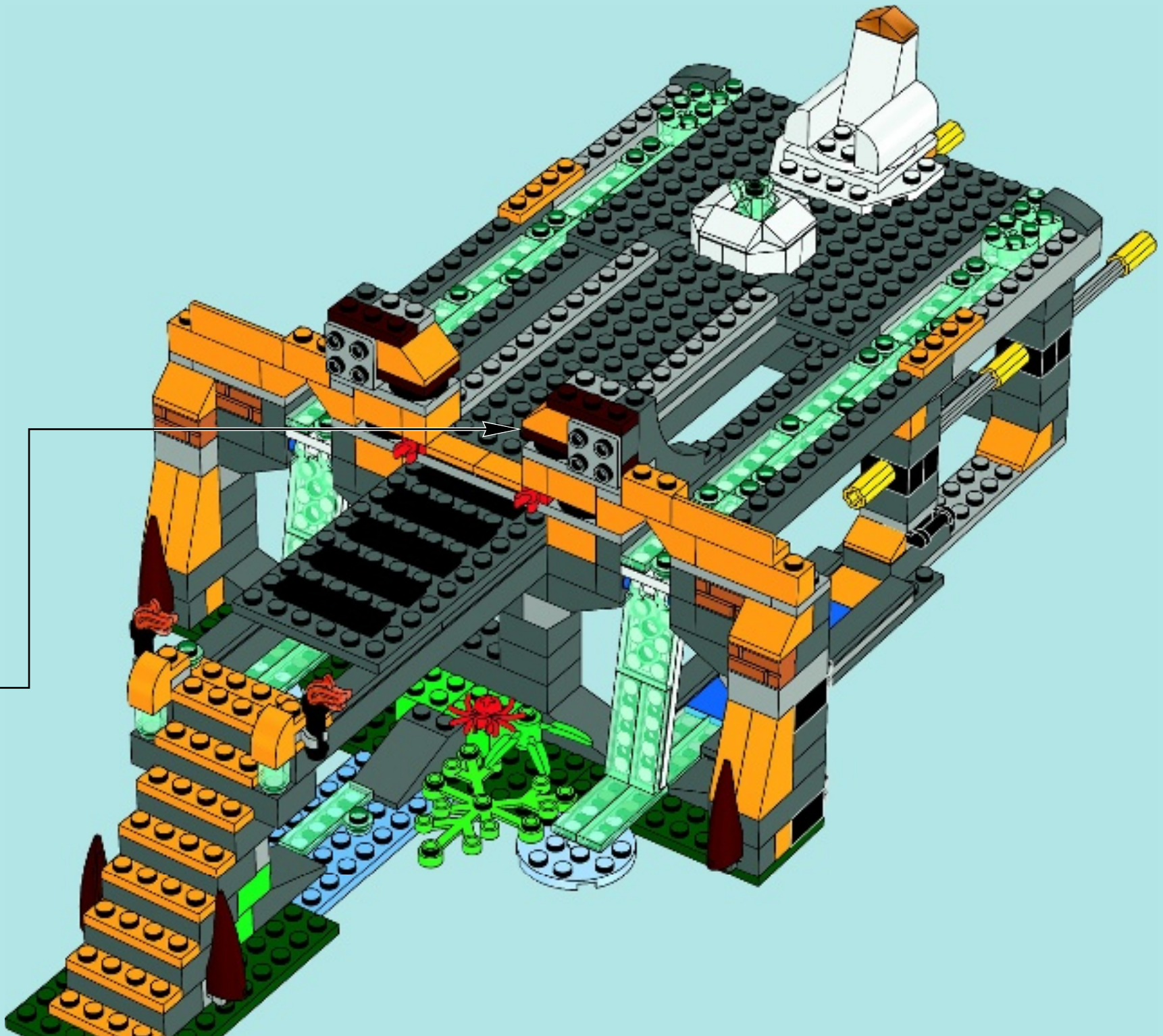





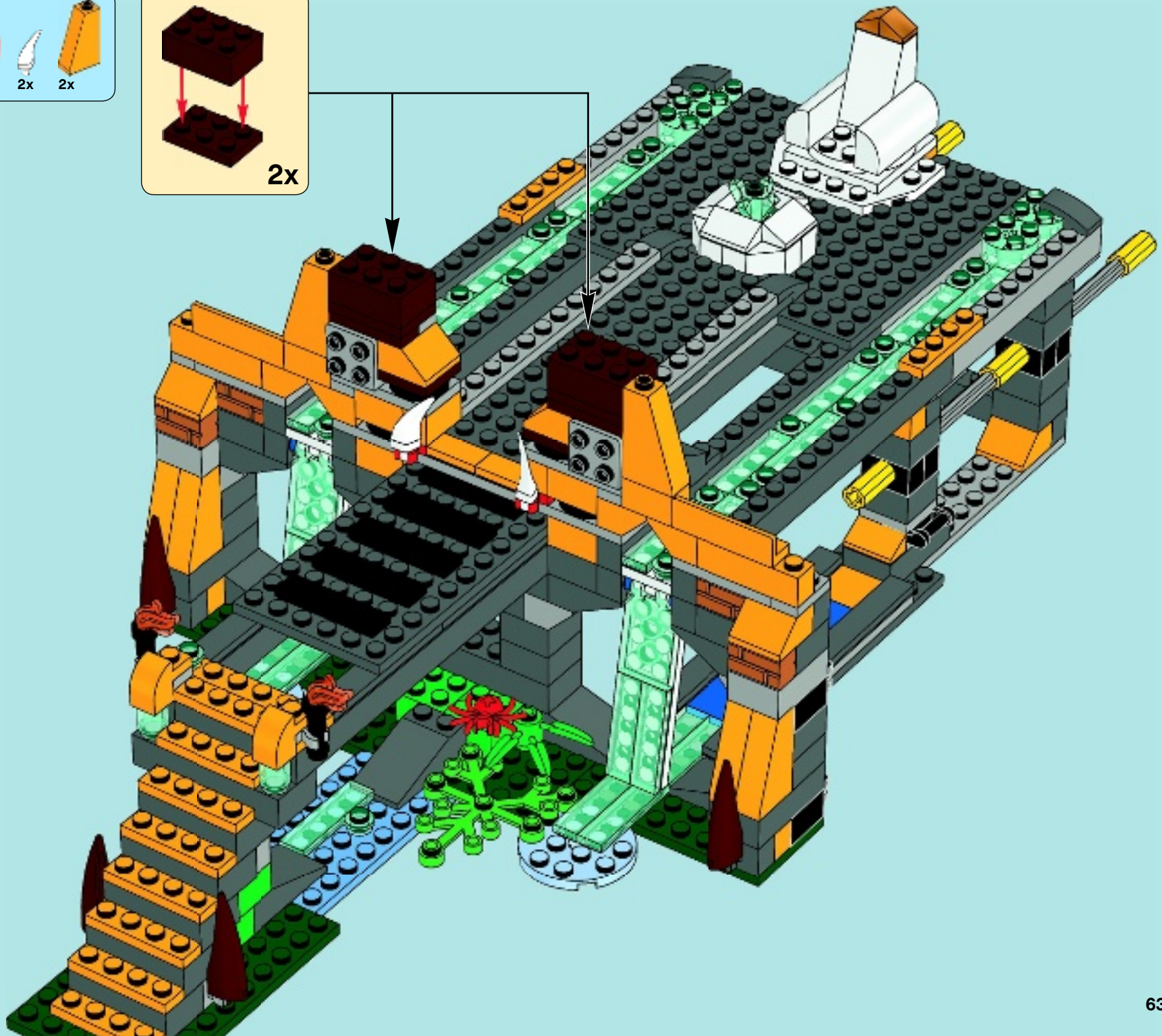
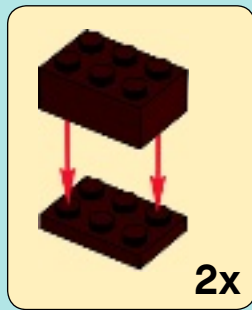

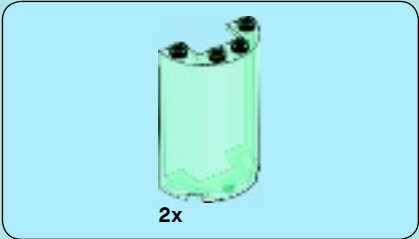
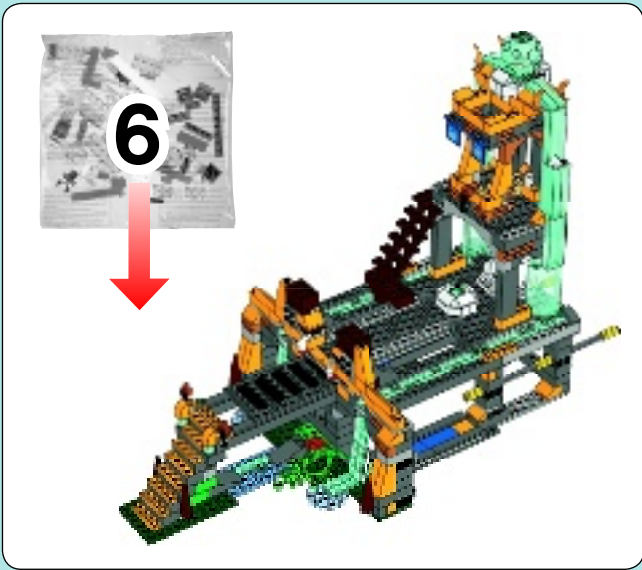
52



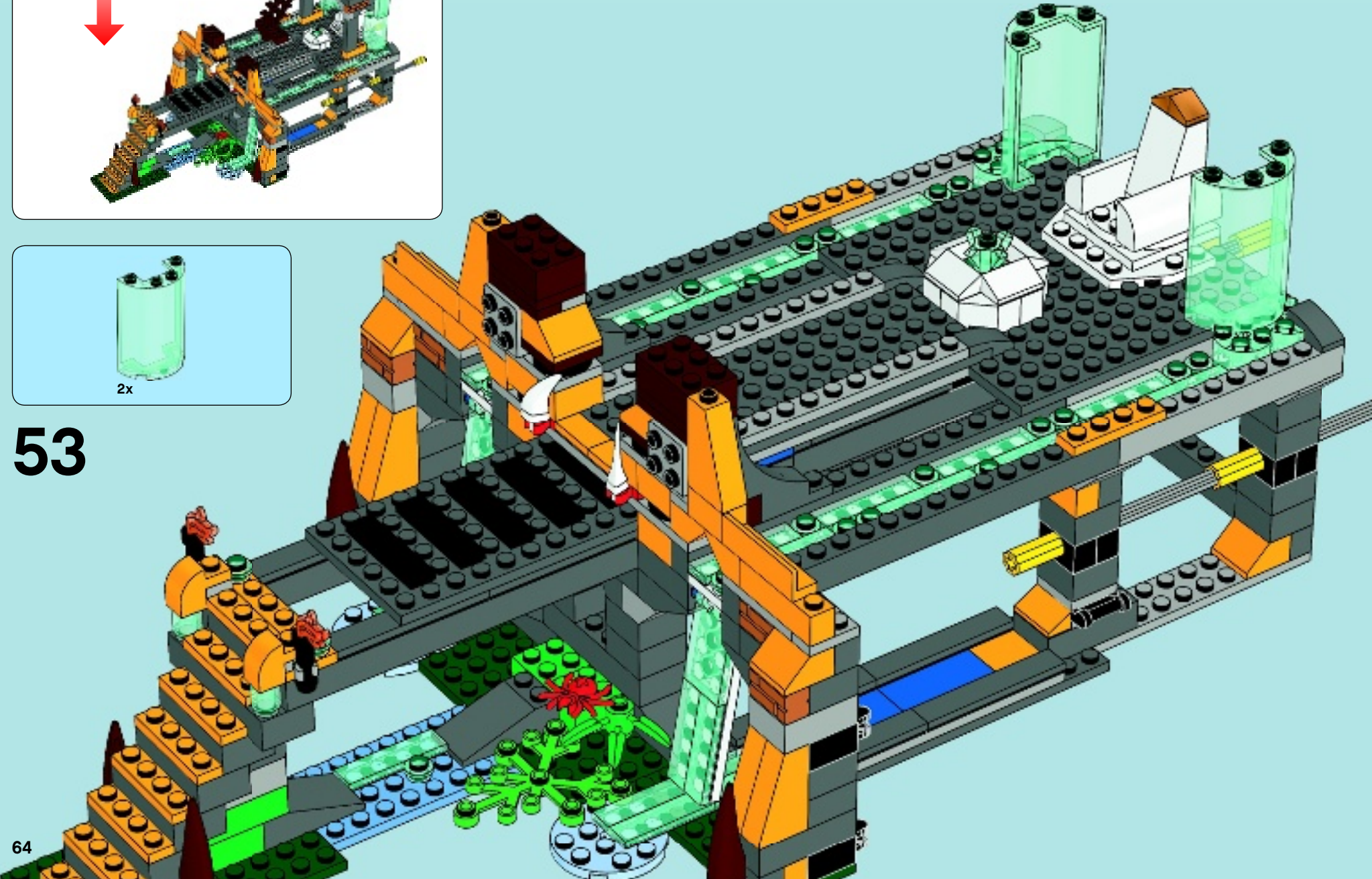

53



2x  1x  1x 

54



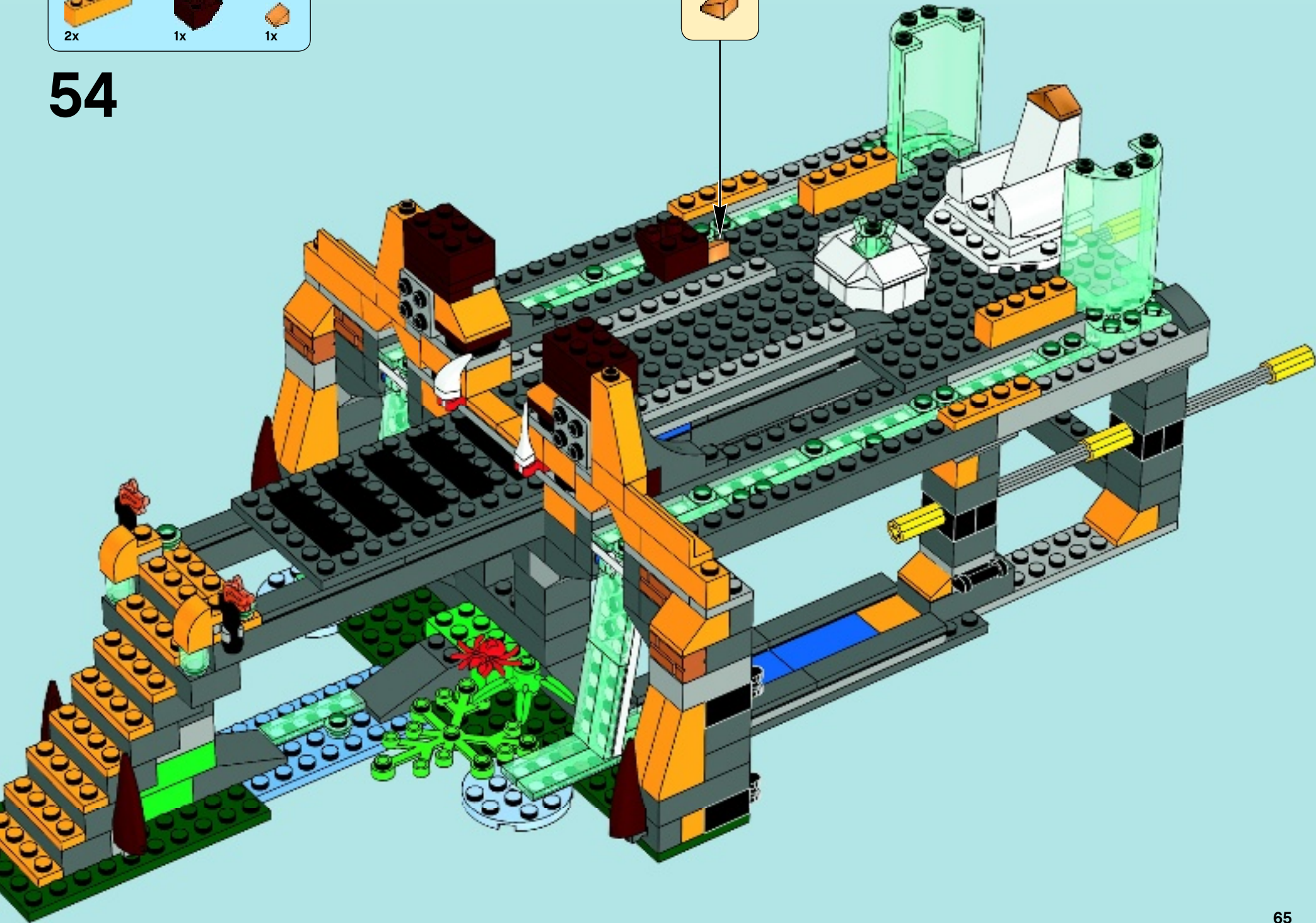

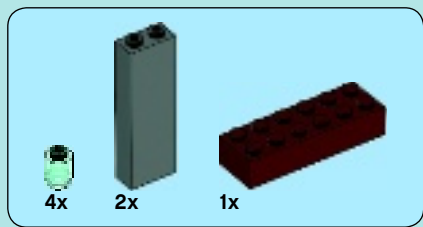

55

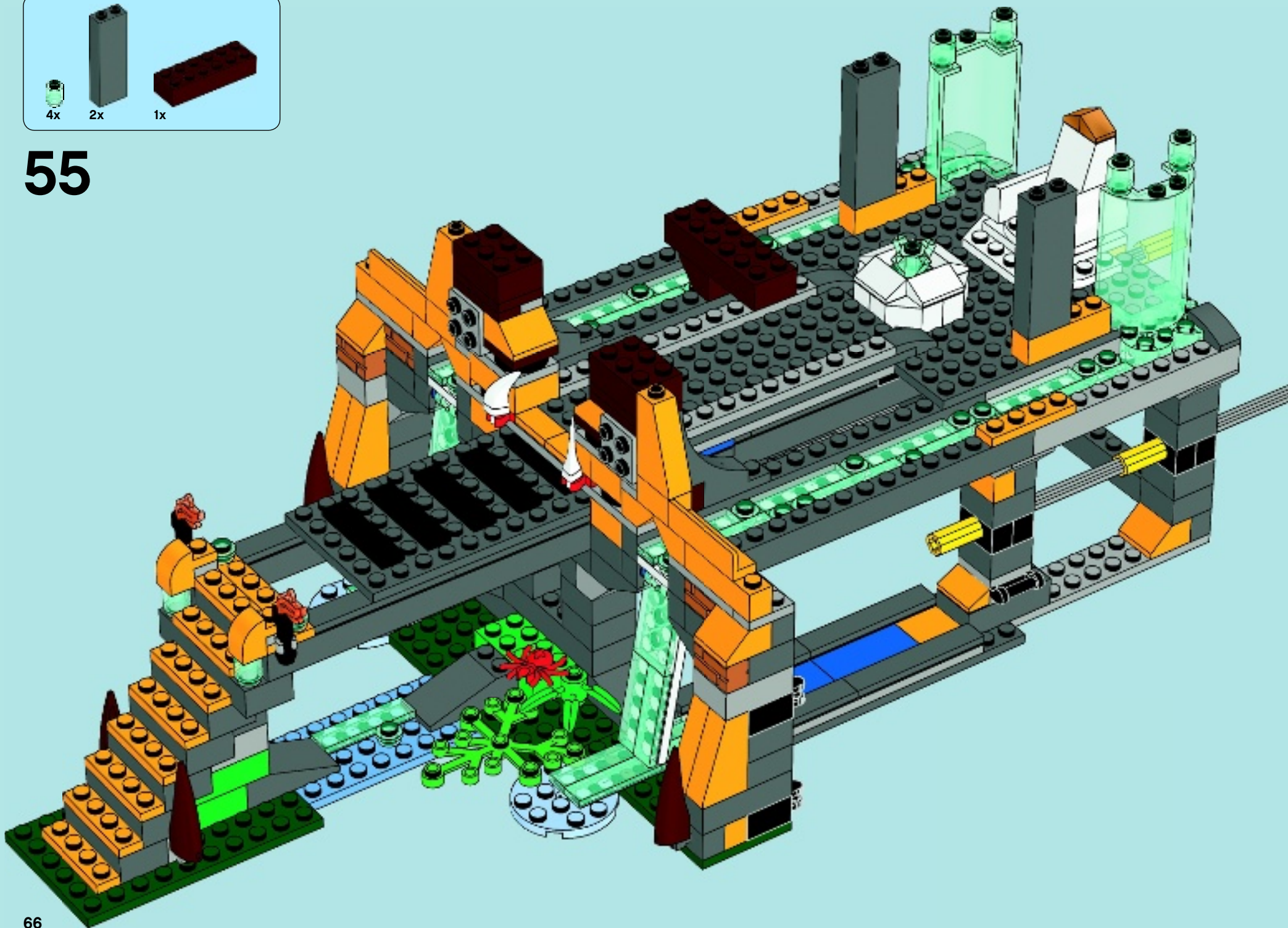

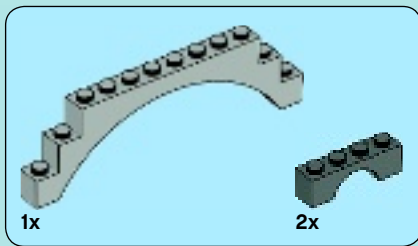

56

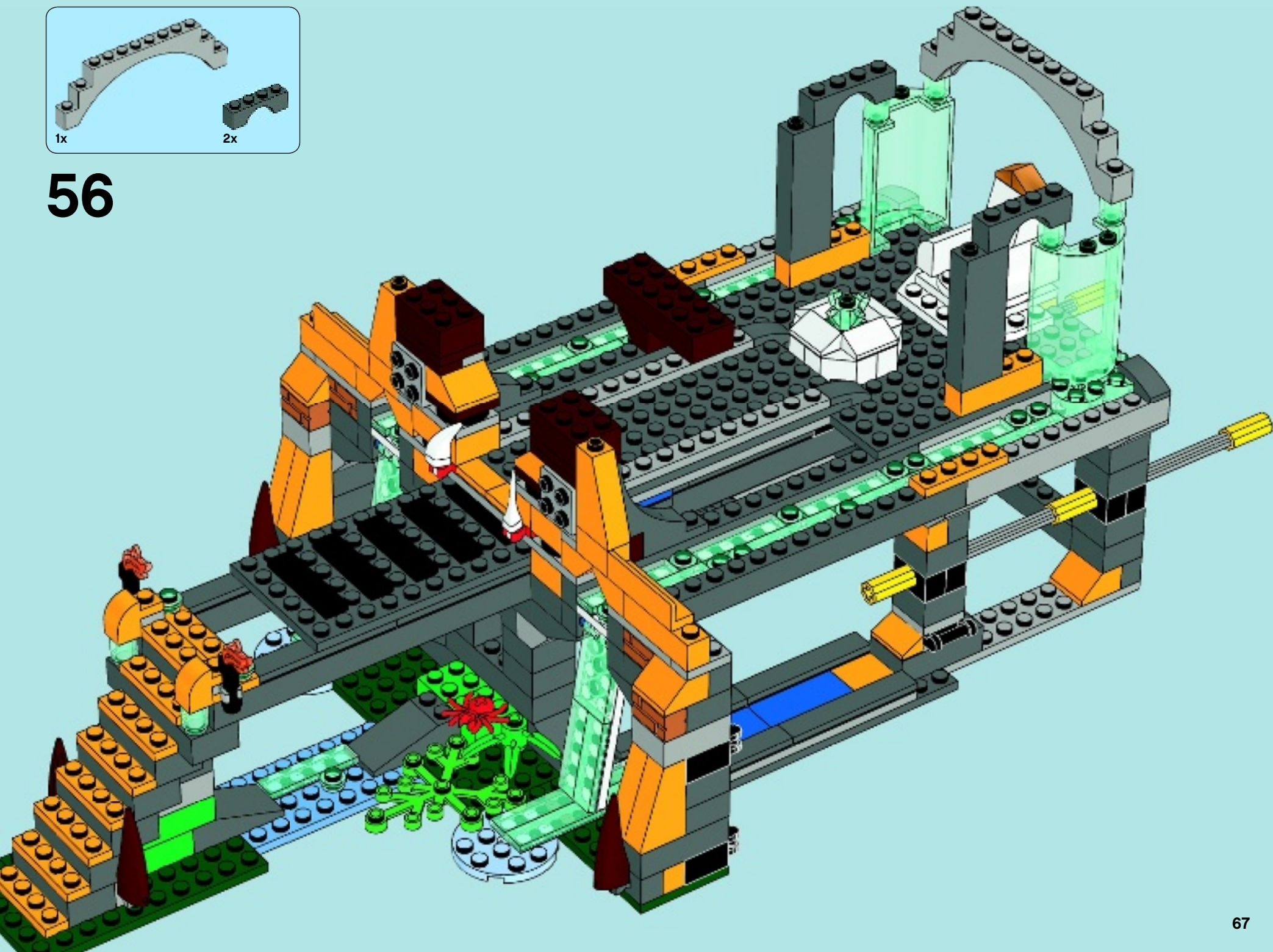

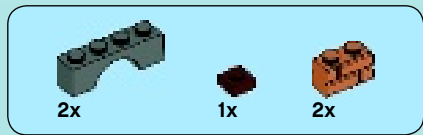

57

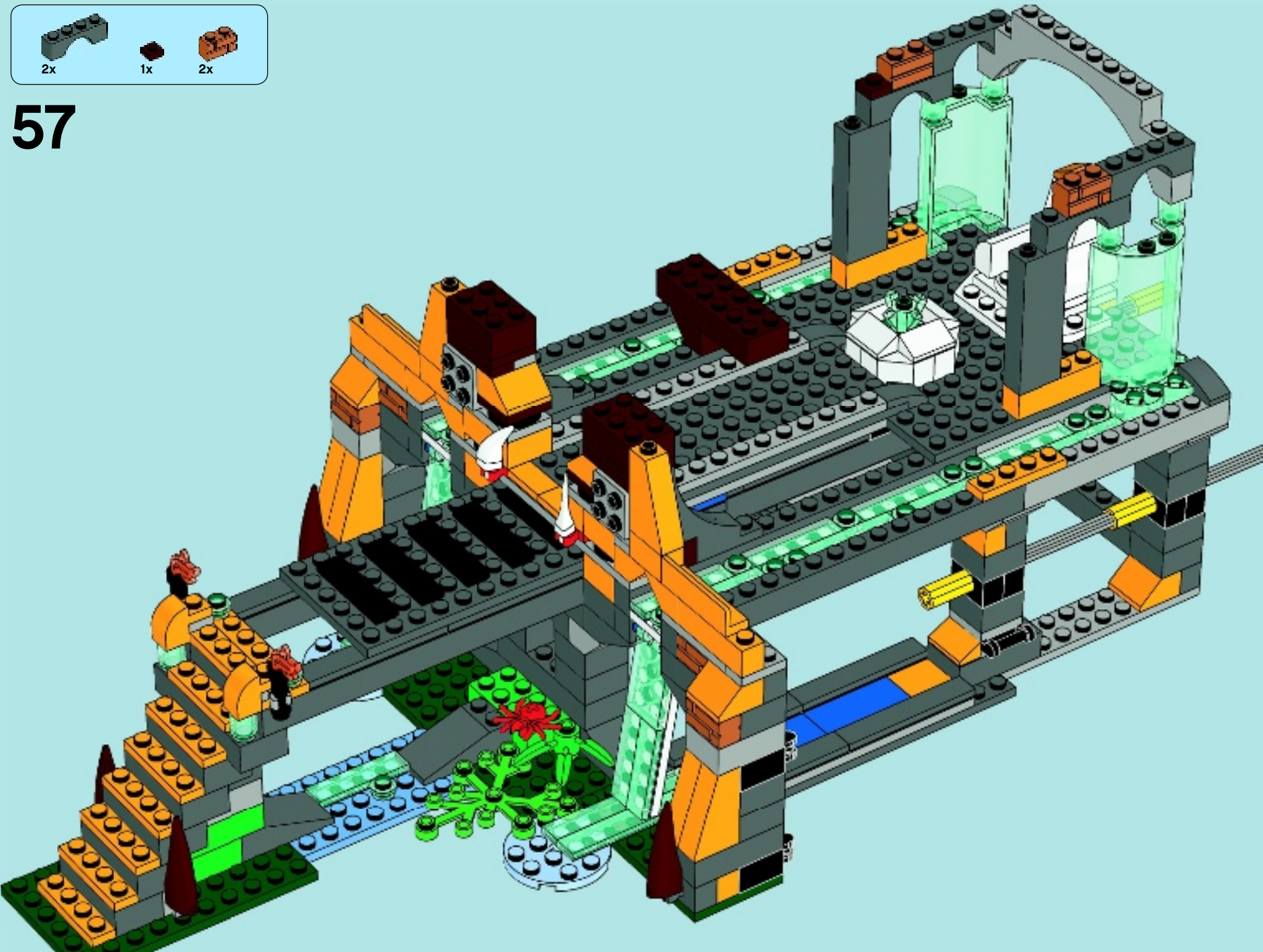

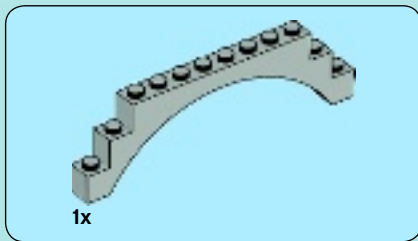

58

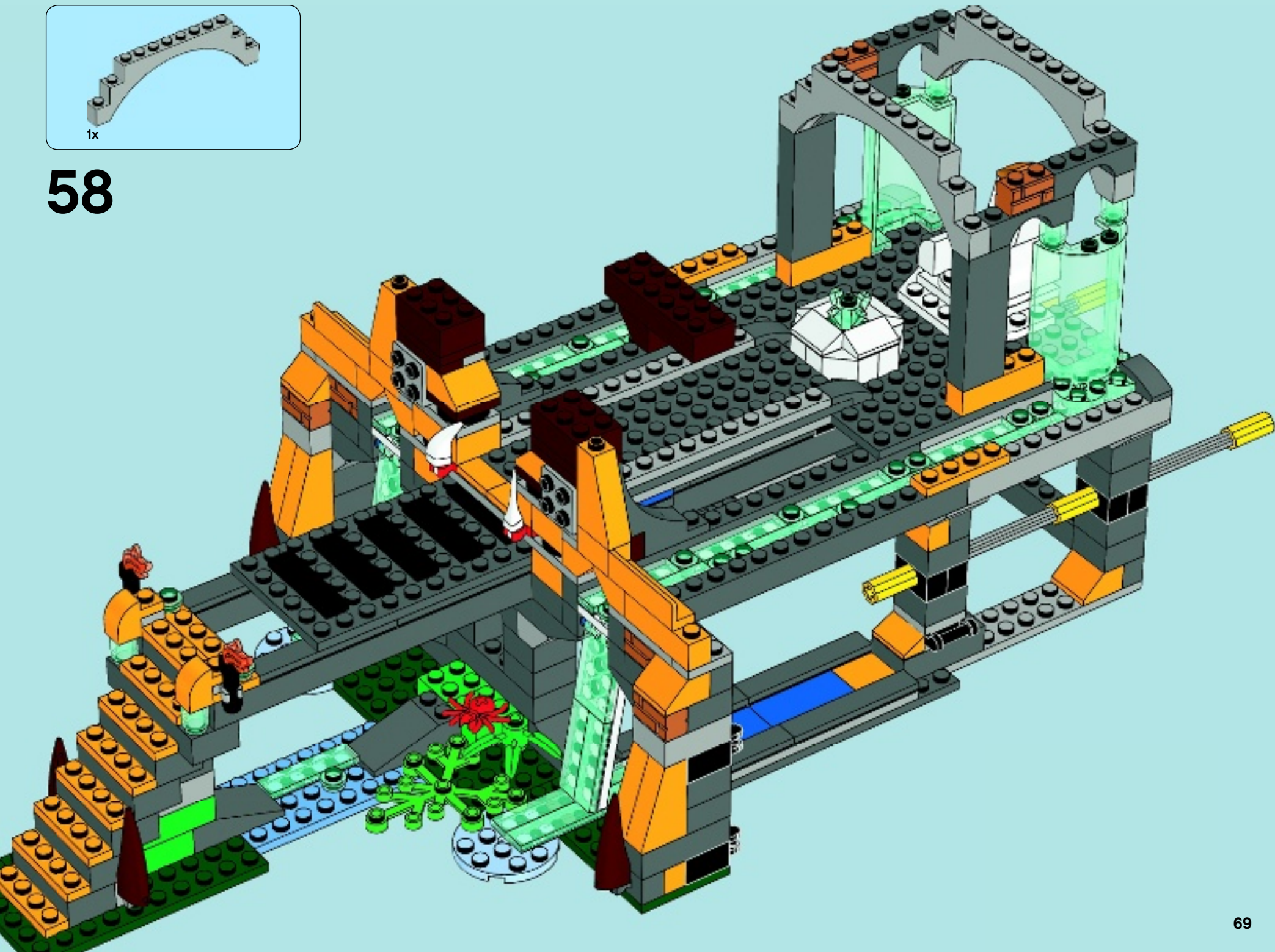

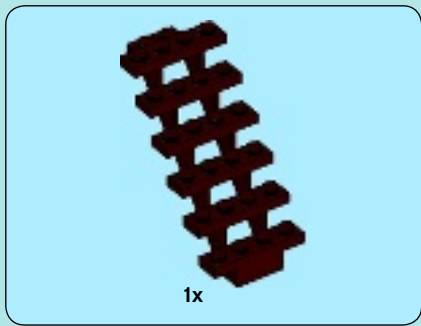

59

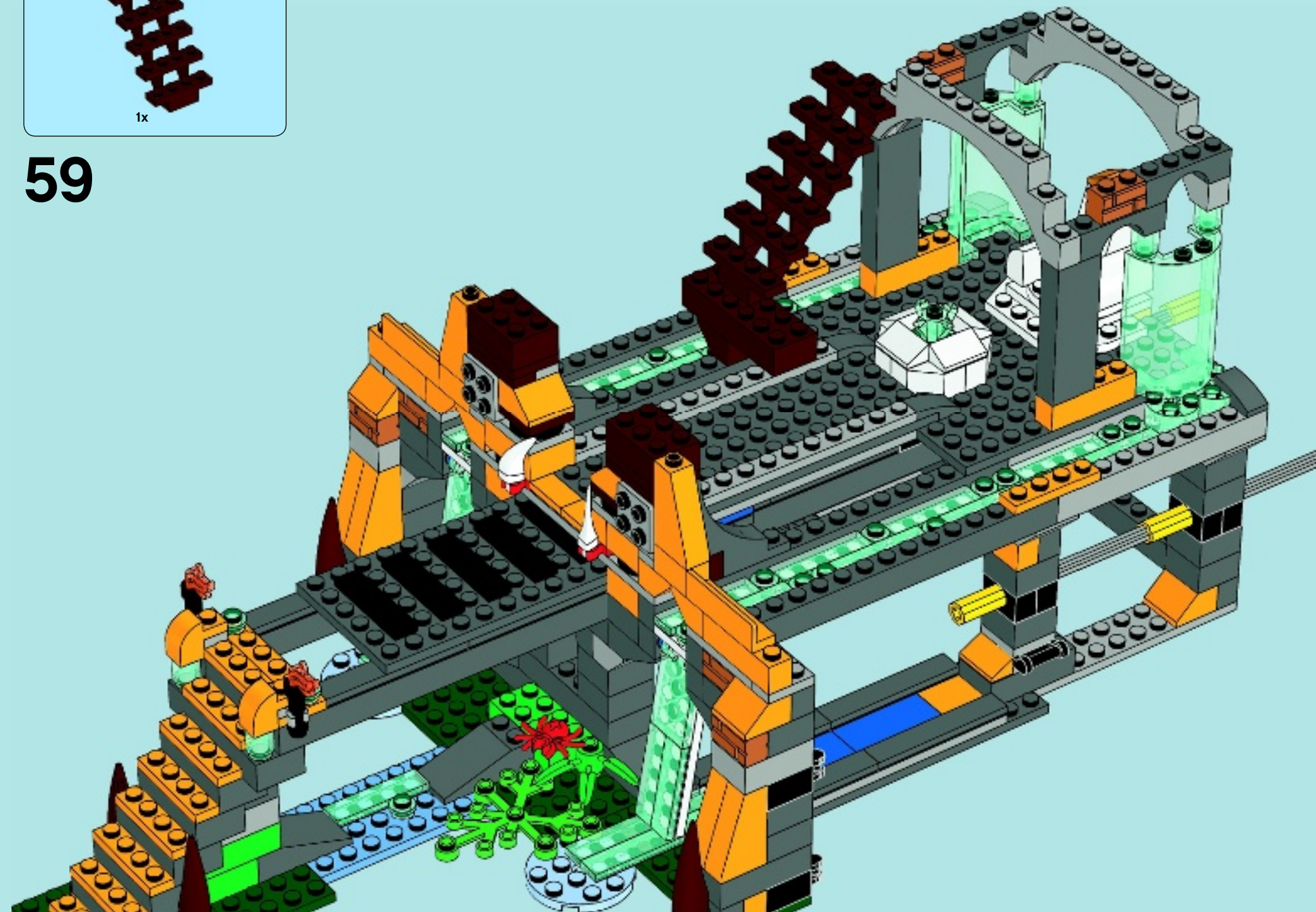



60

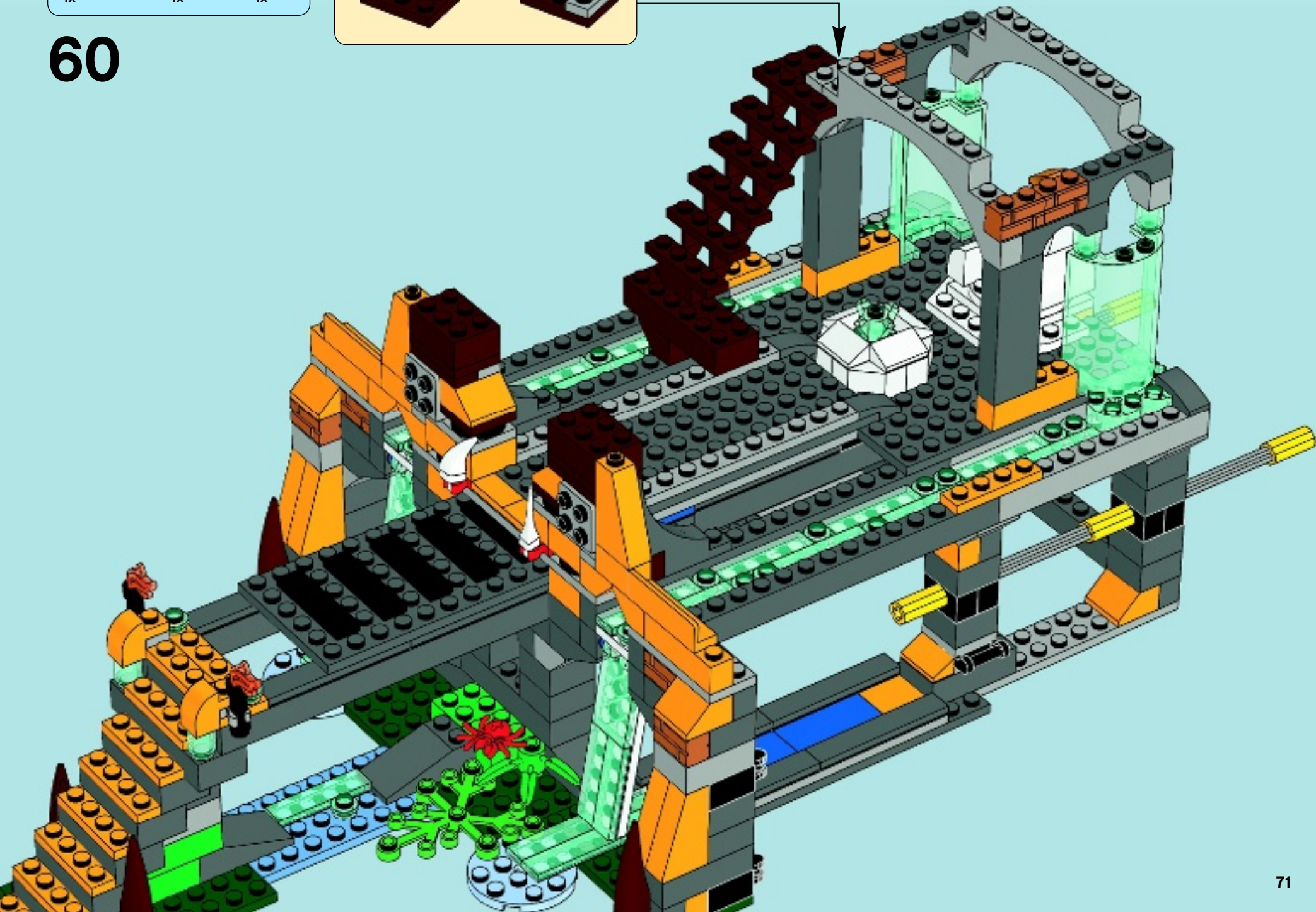



4x

61

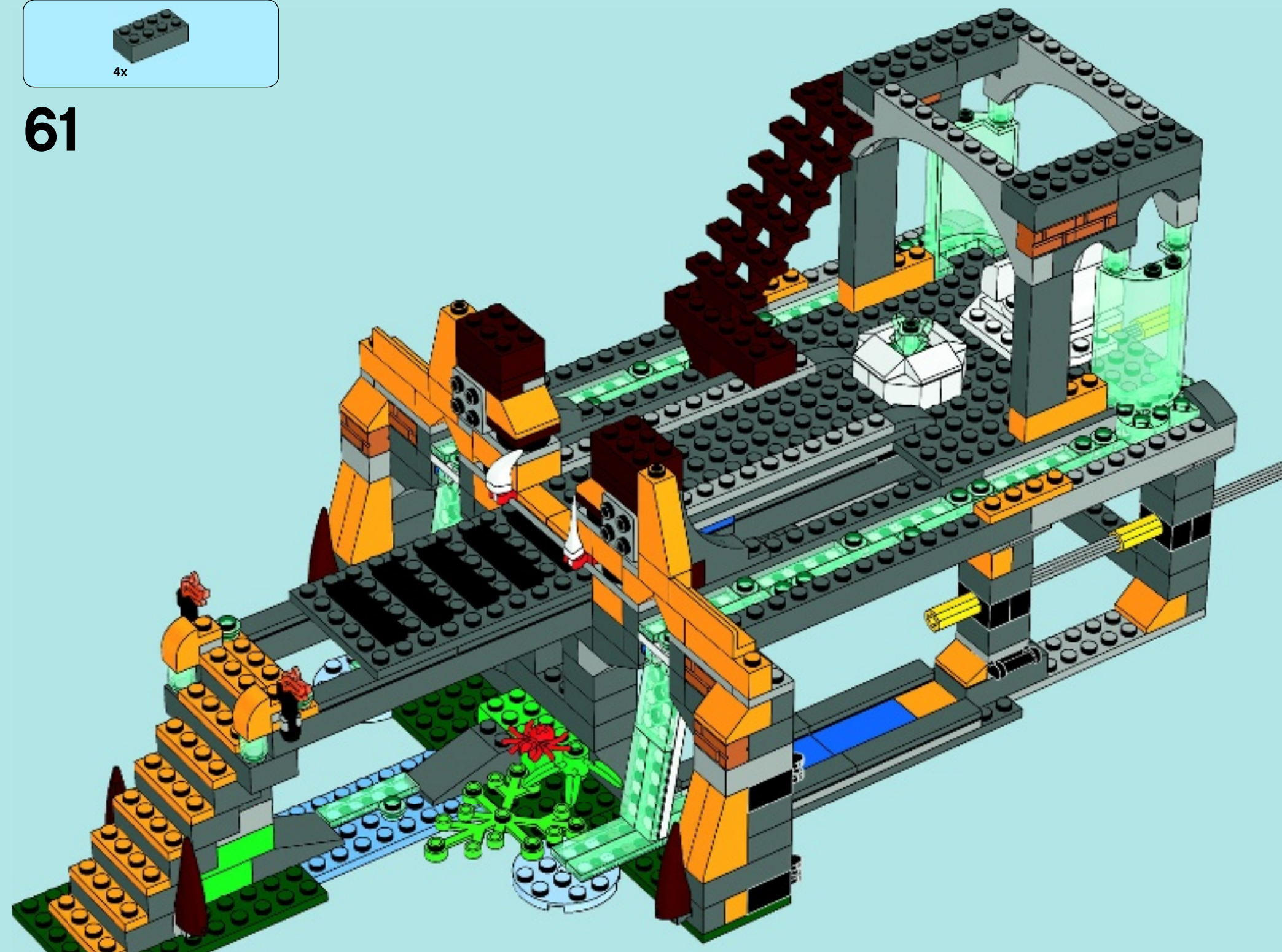

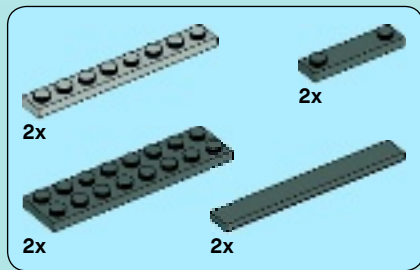

62

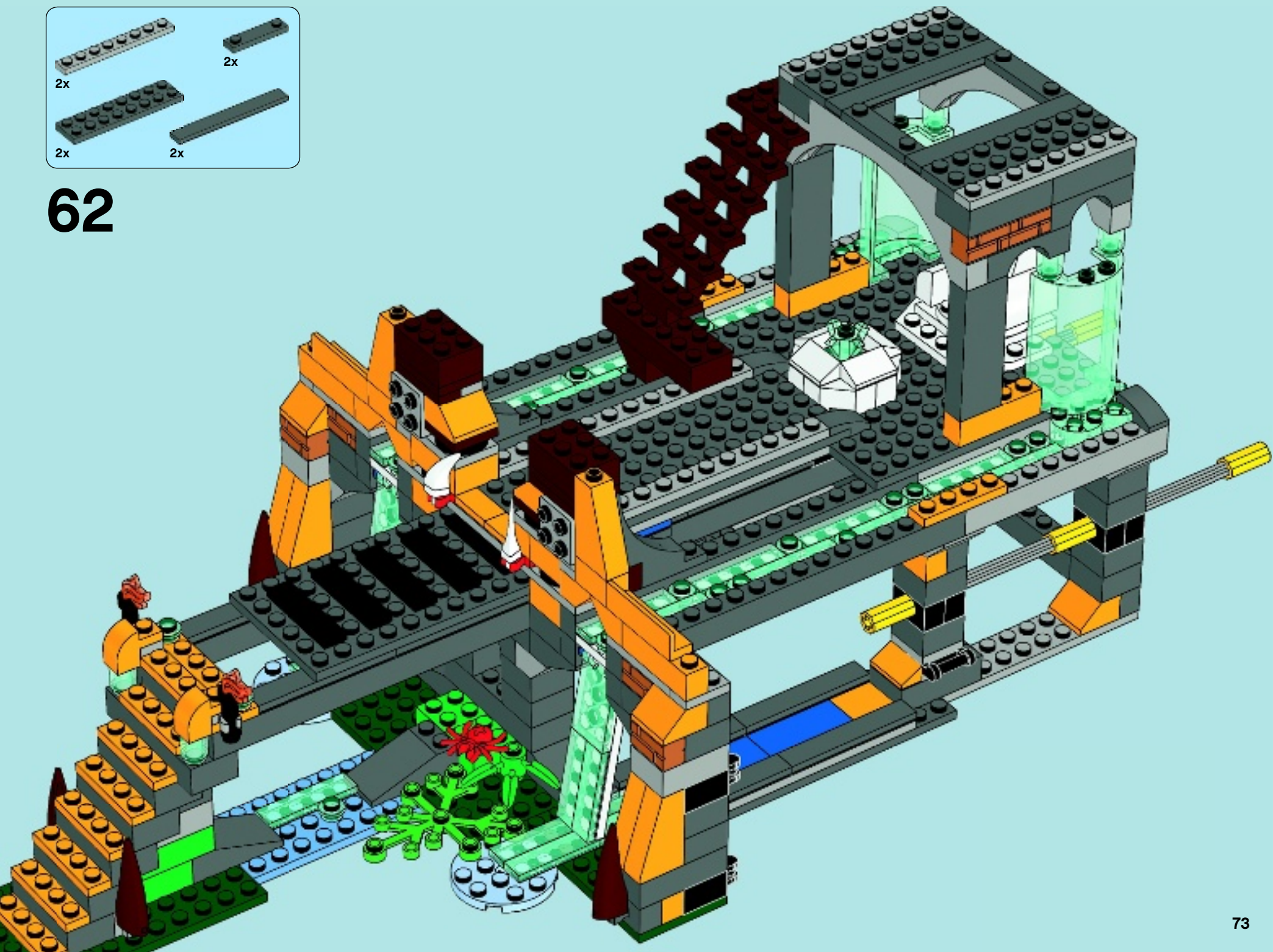

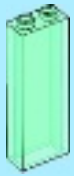

2x

63

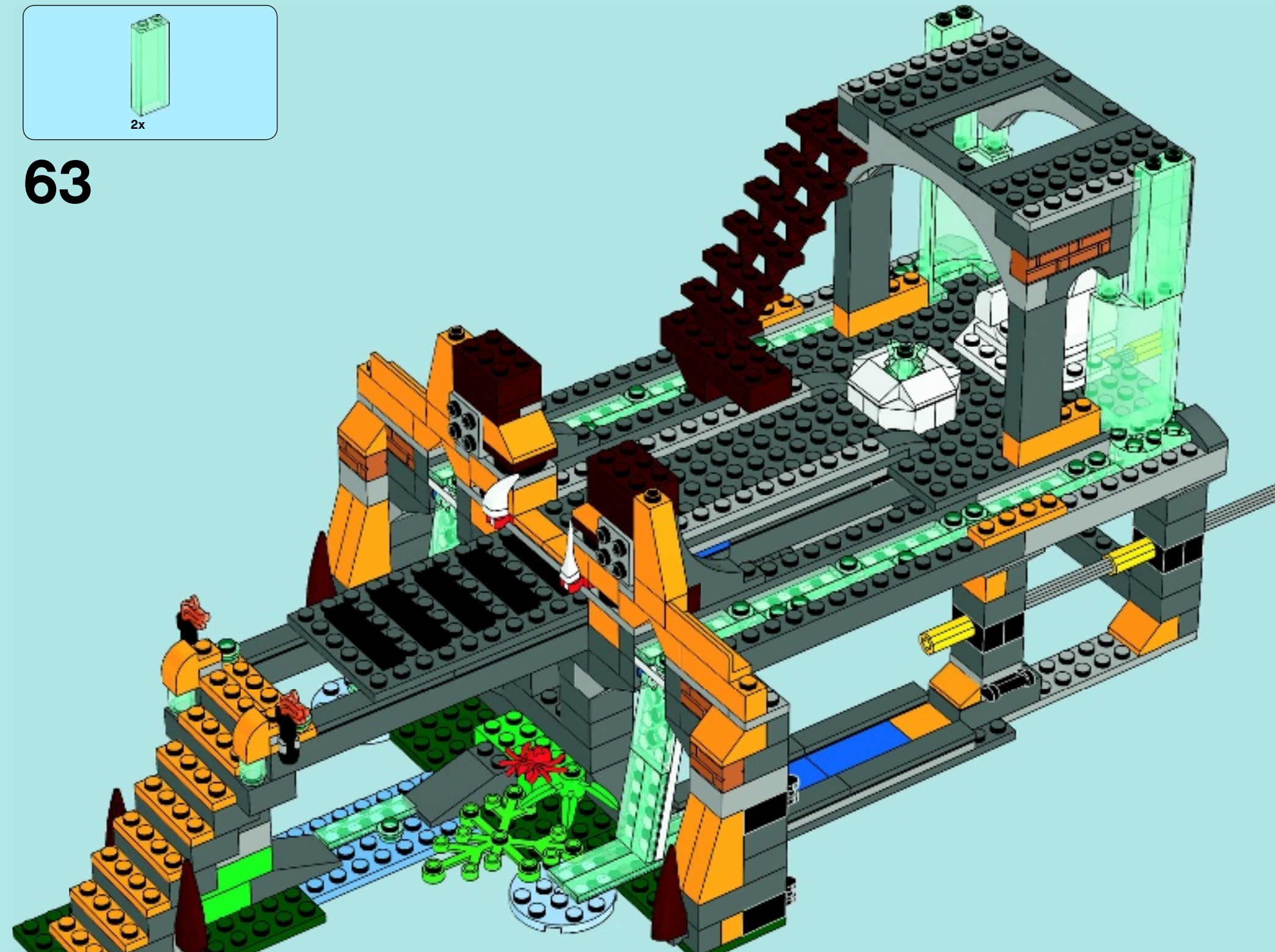



2x



4x

64

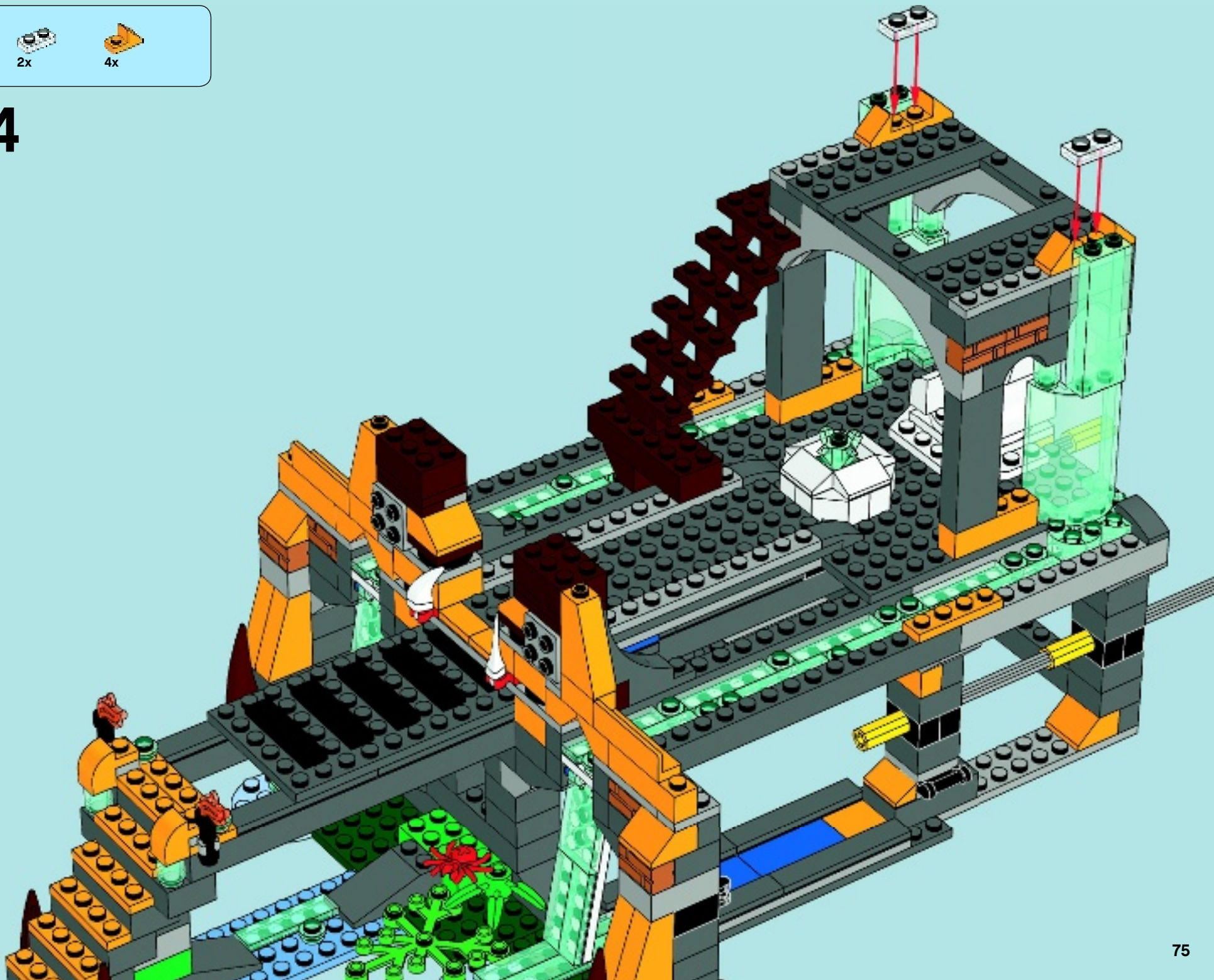

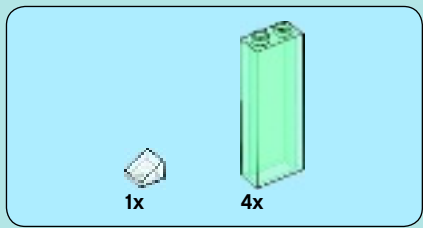

65

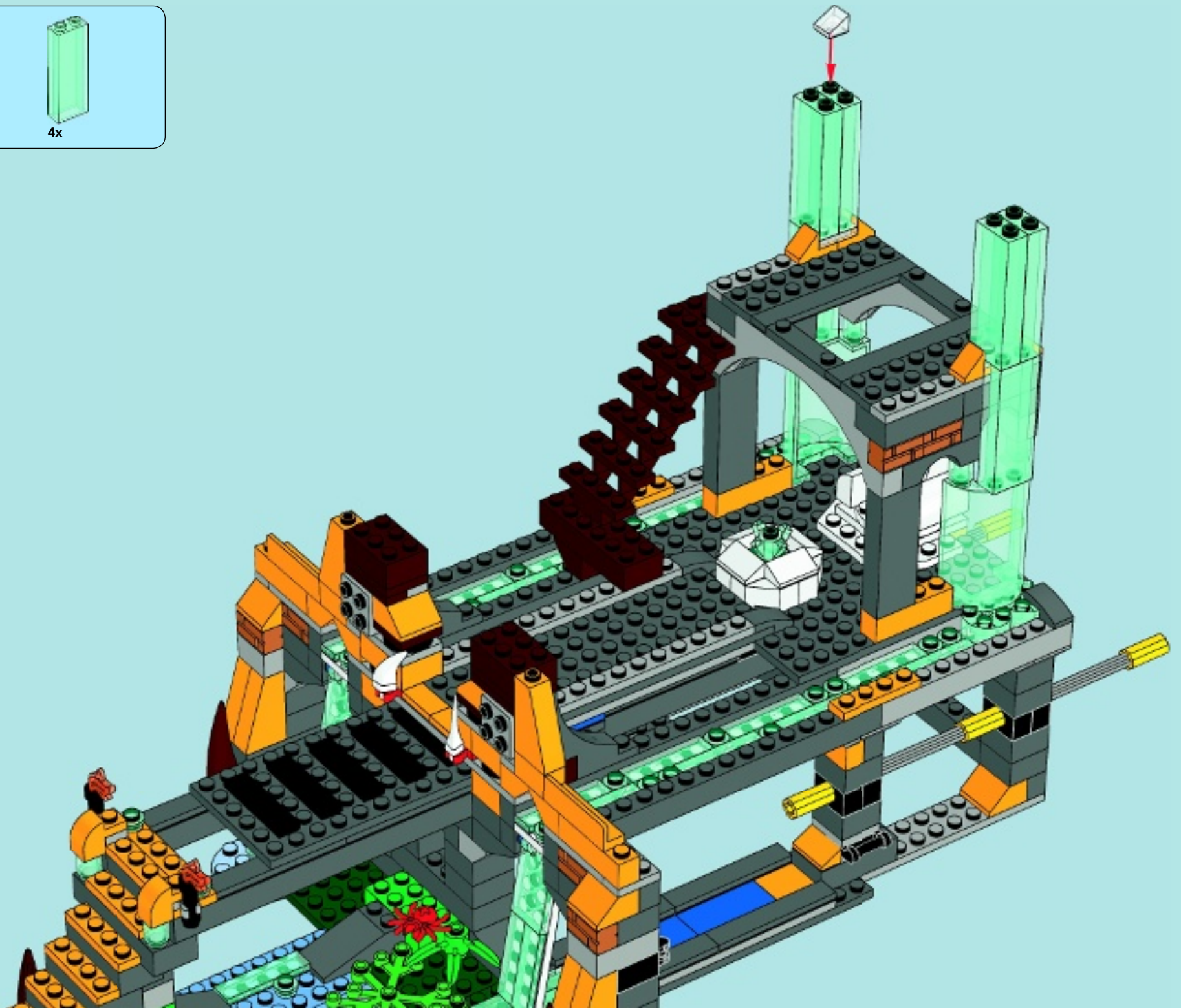

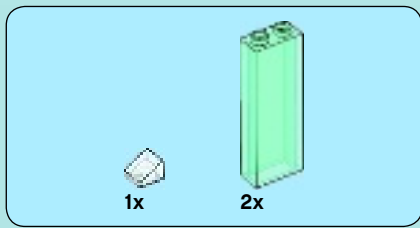

66

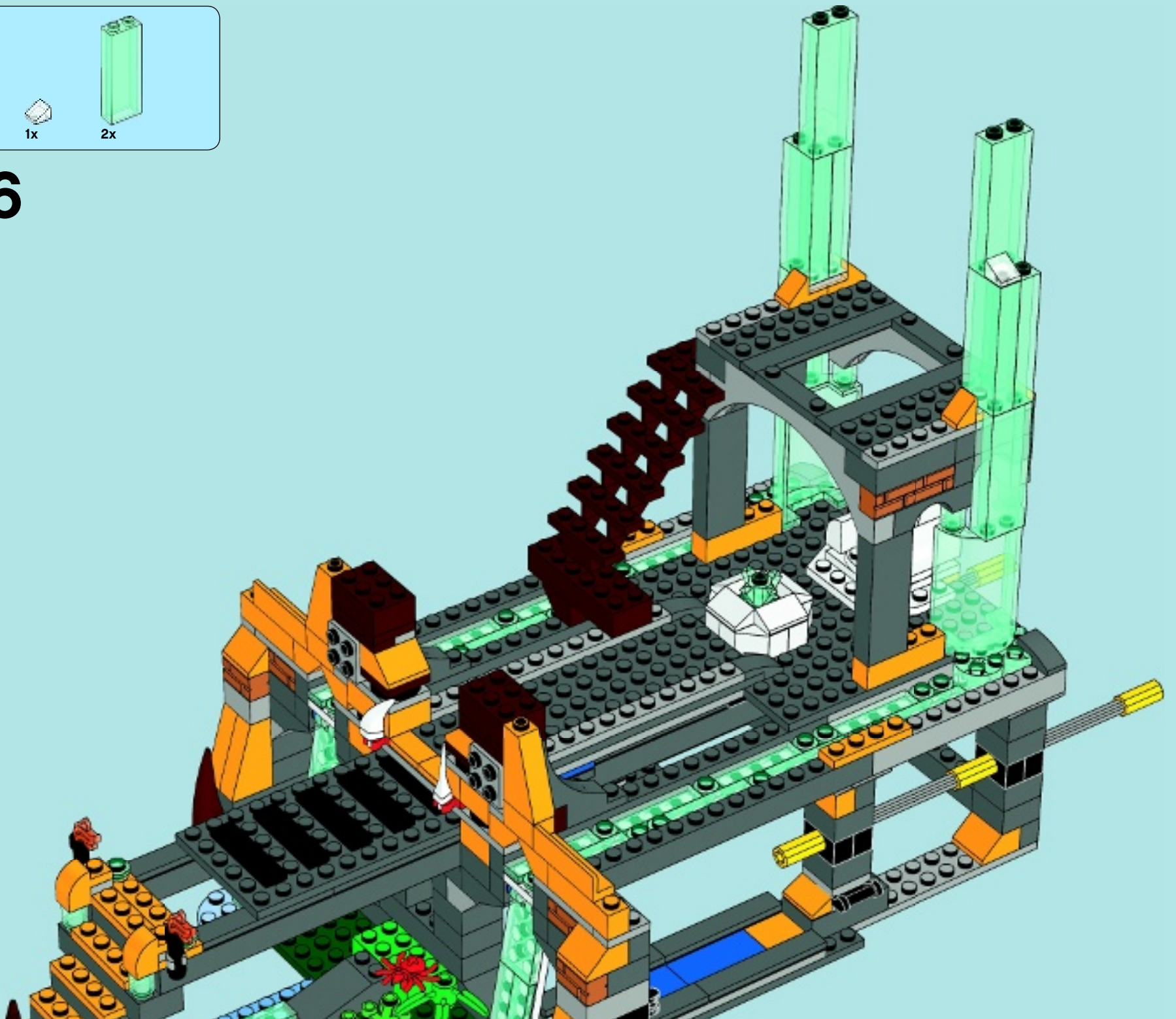

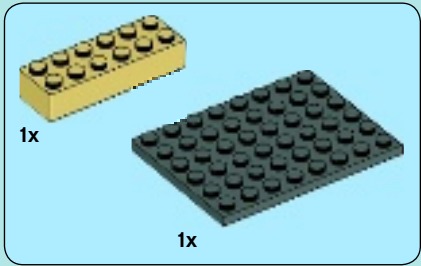

1

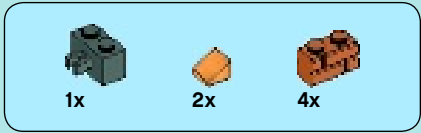

2

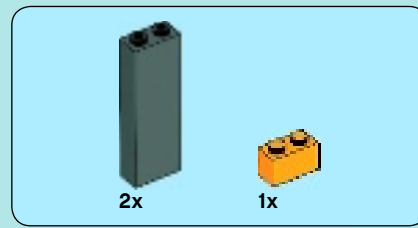
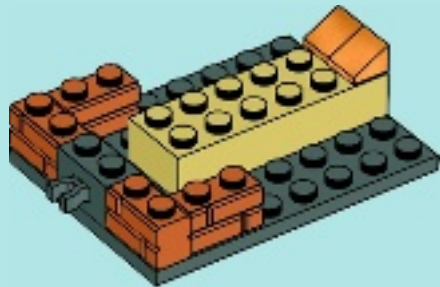

3

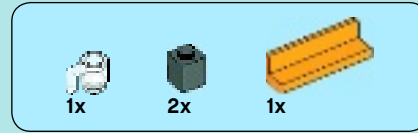
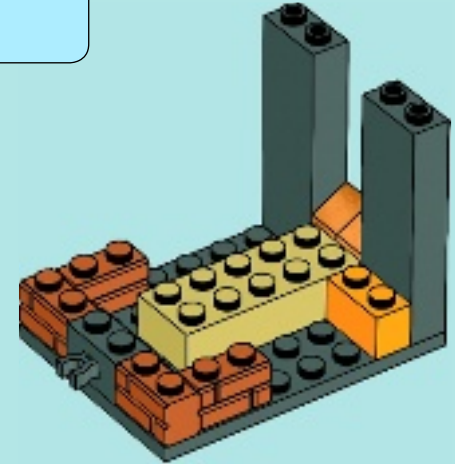

4

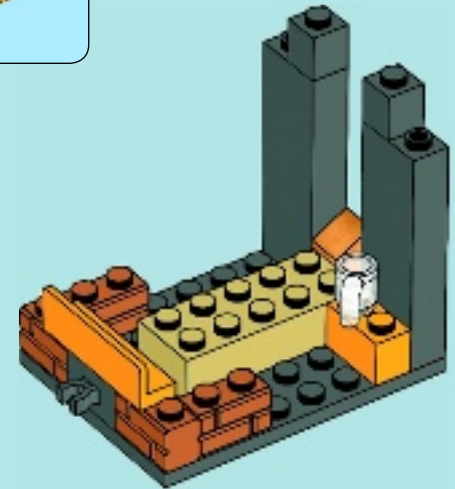



5

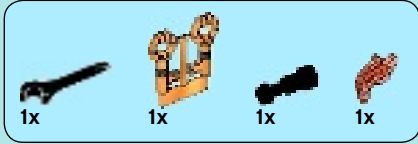
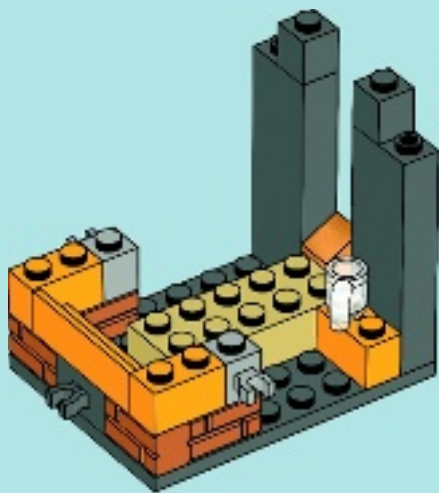

6

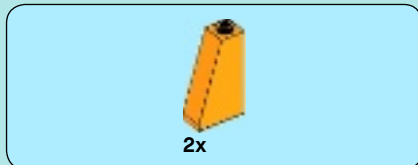
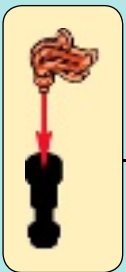

7

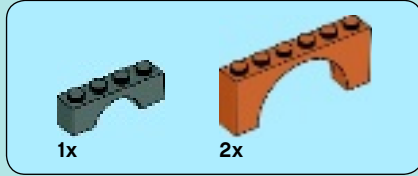
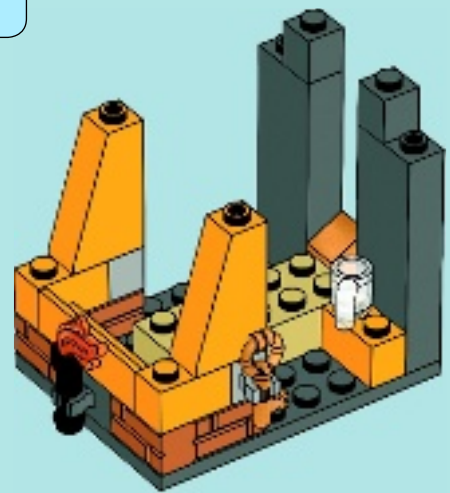

8

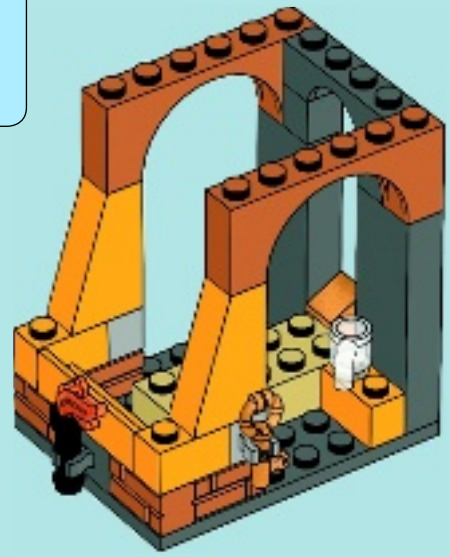

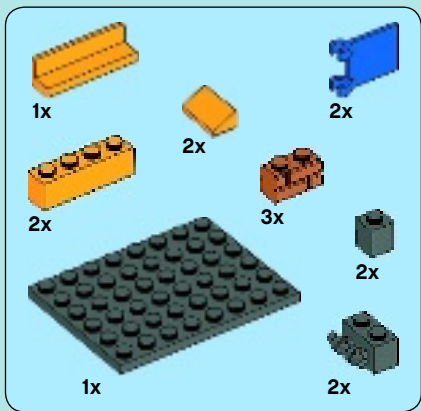

9

1



2

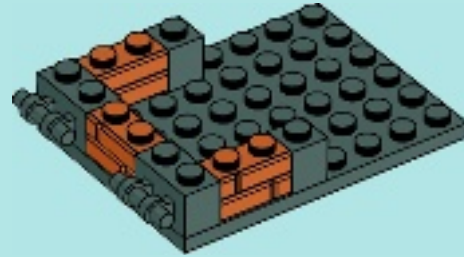

3

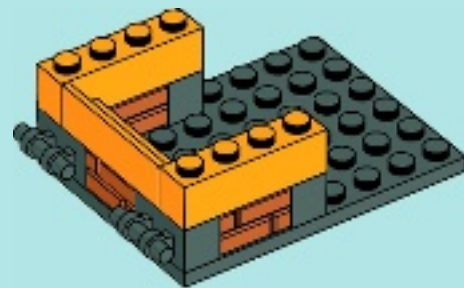

4

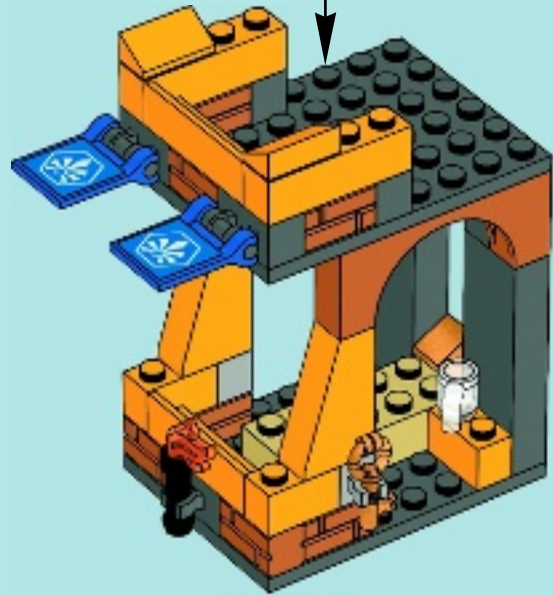
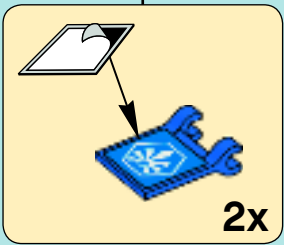
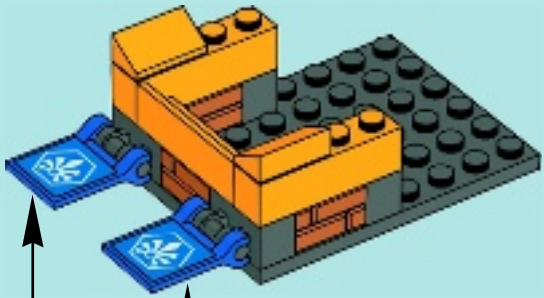

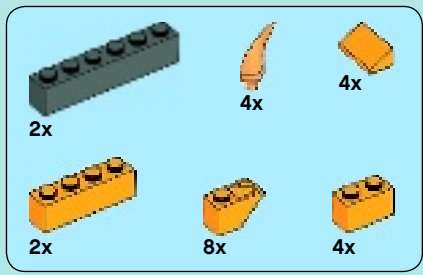

10

1

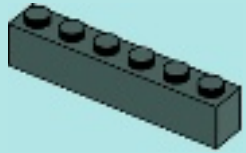

2

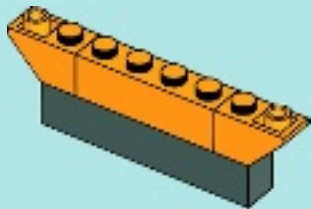

3

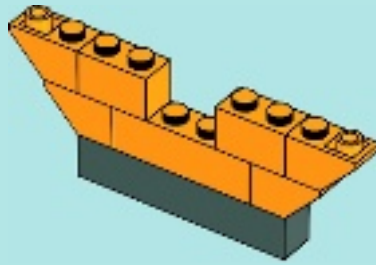

4

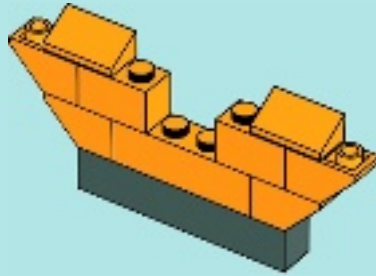

5

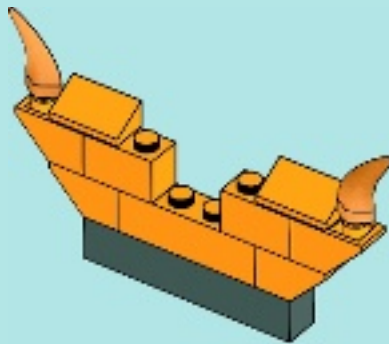

2x

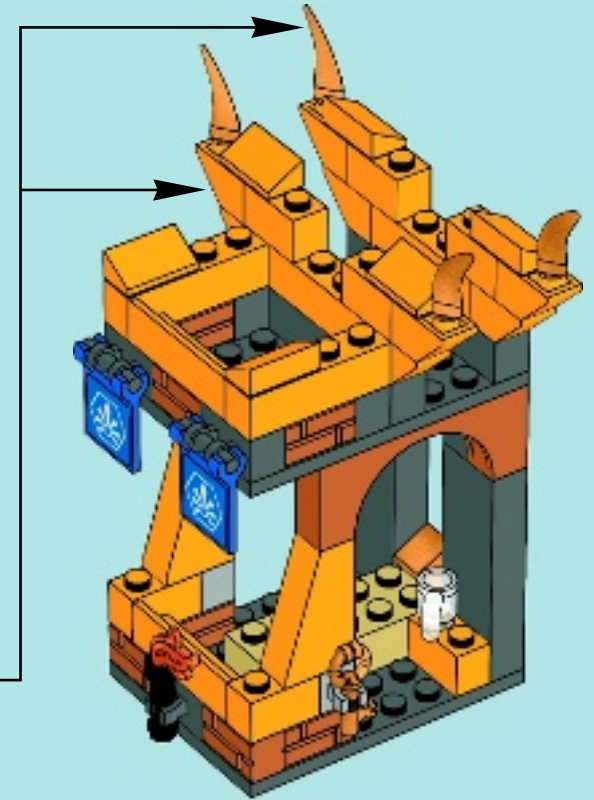

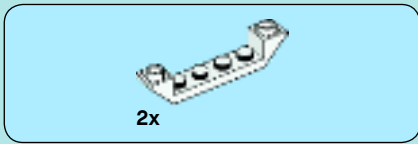

11

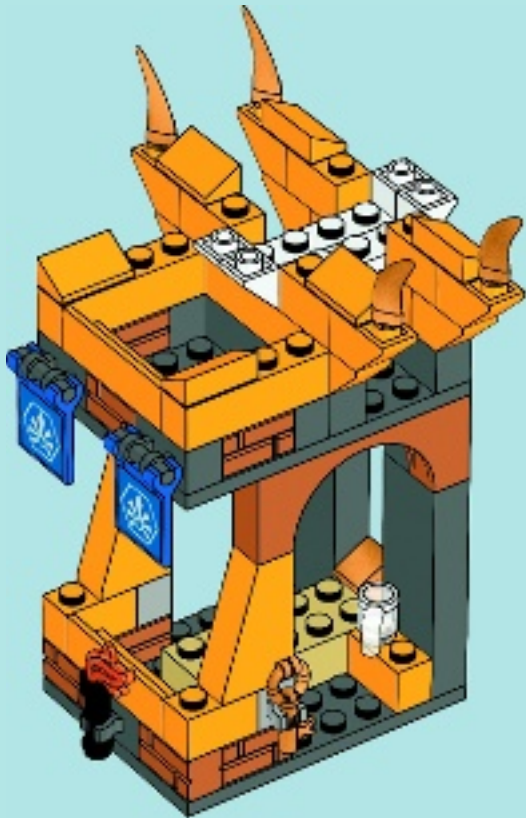

12

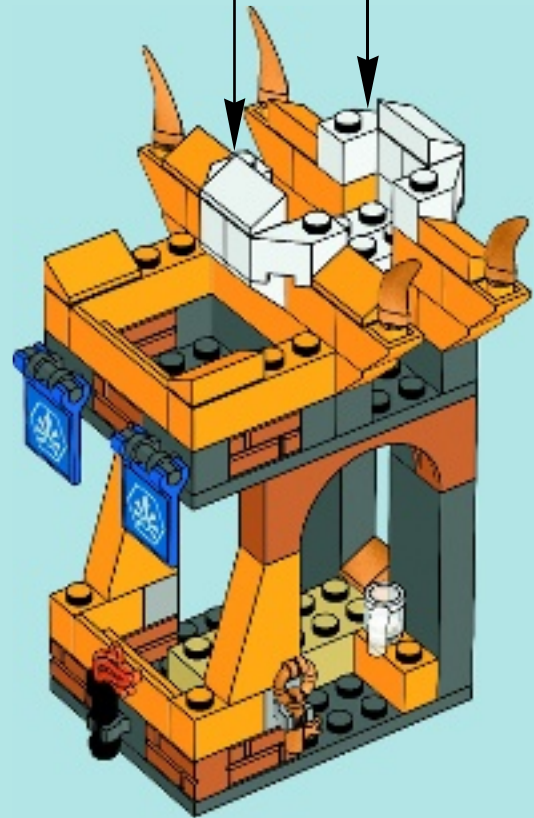
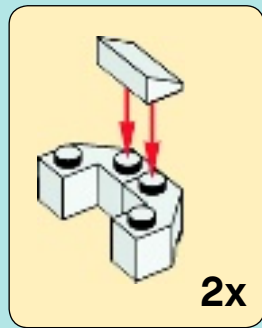

67

