



PIRATES

6253

Treasure bay



1

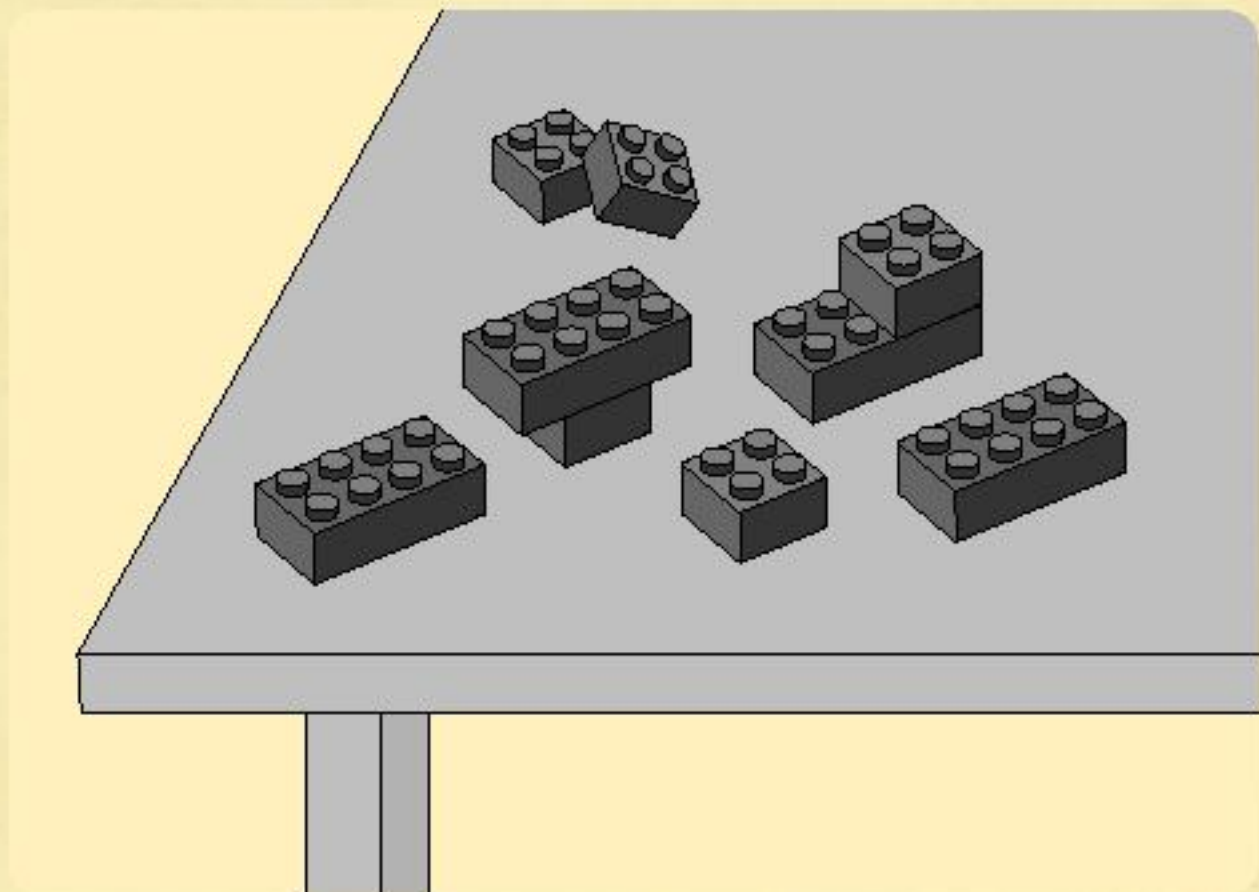
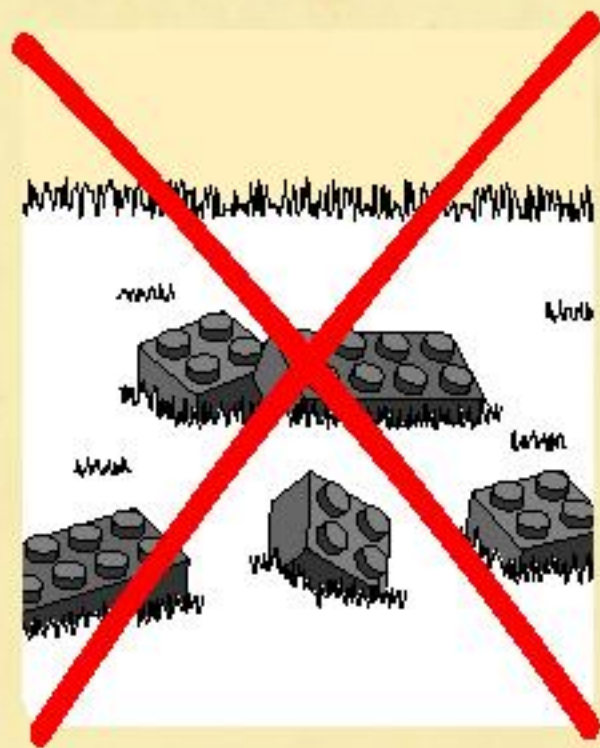

2





3

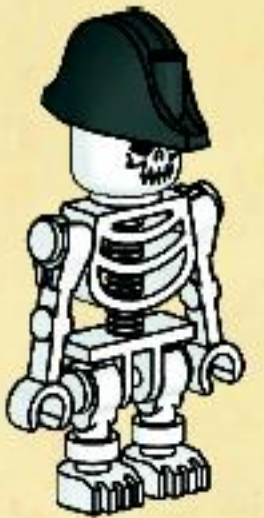
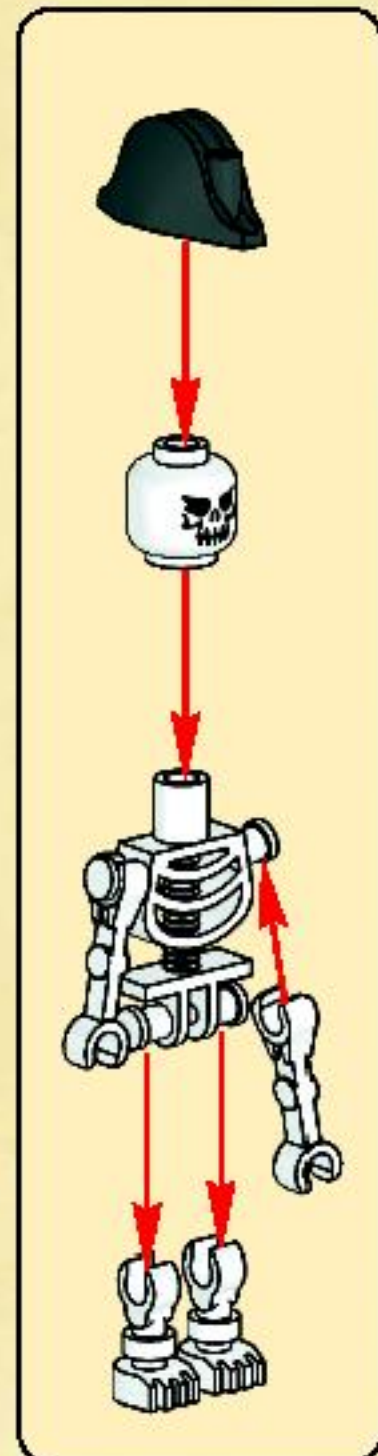
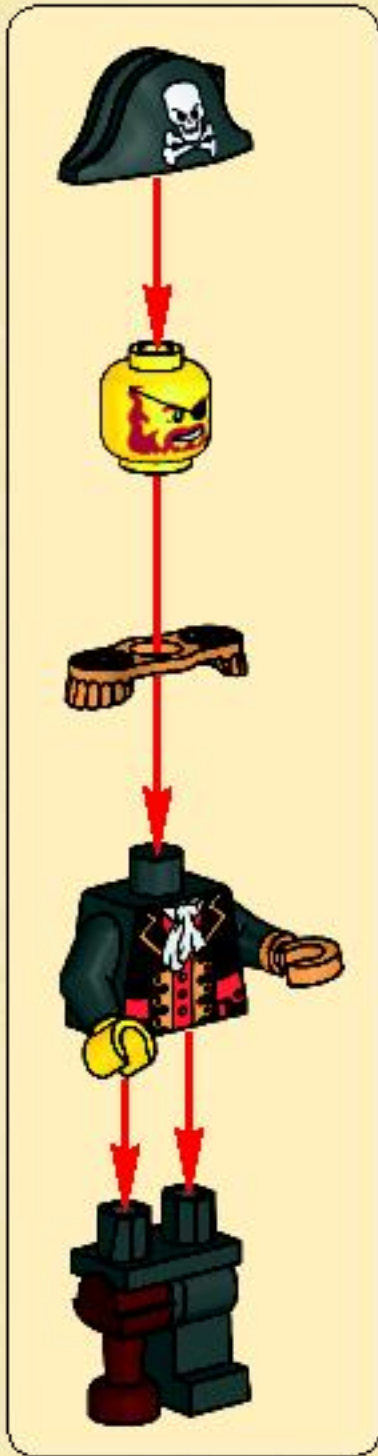

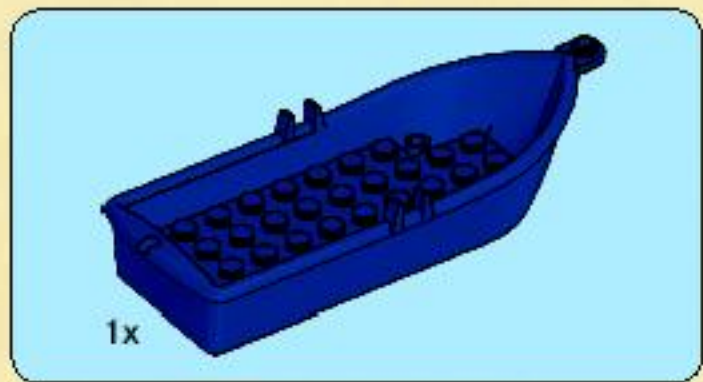

1

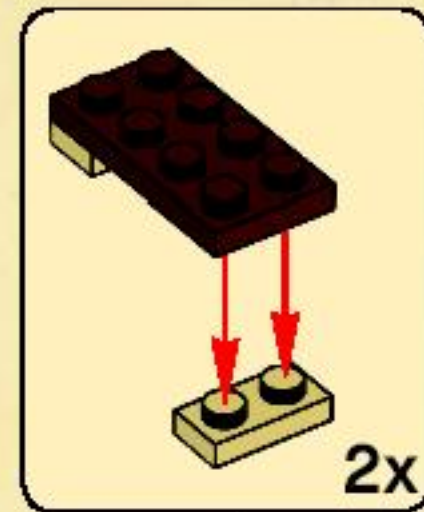
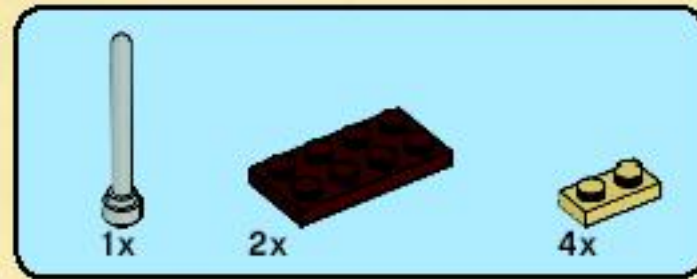
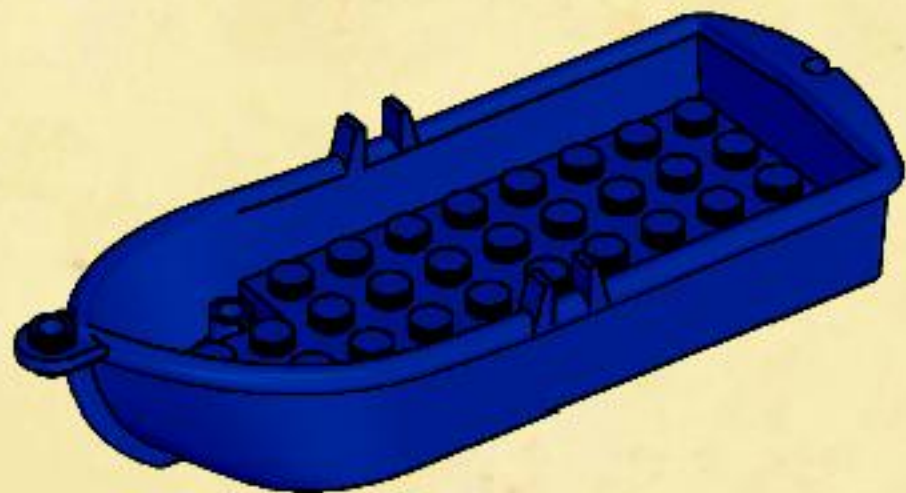

2

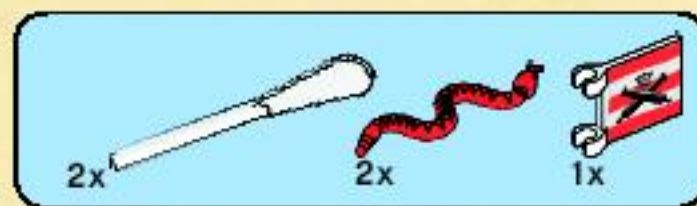
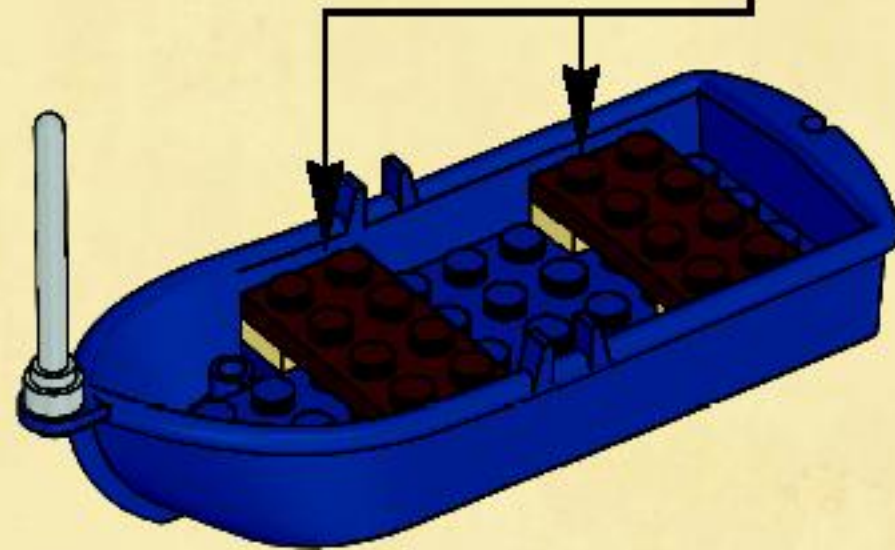

3



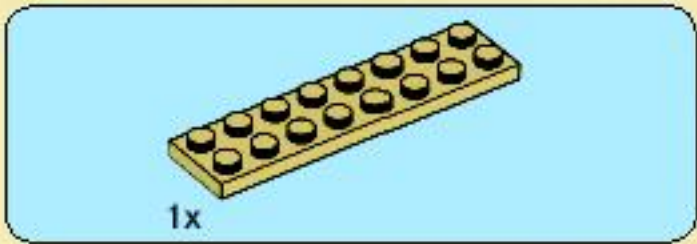
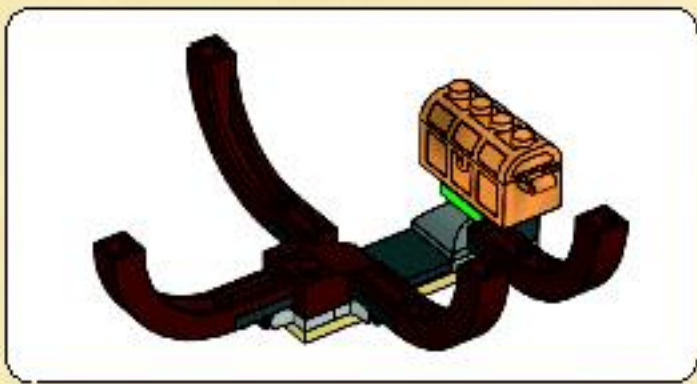

1

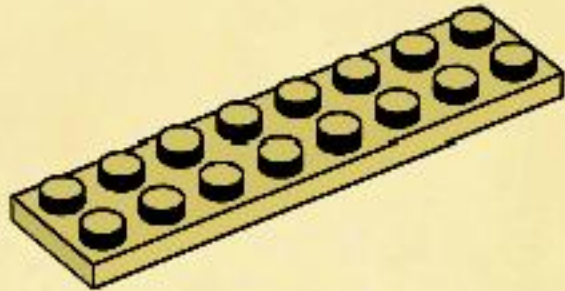

2

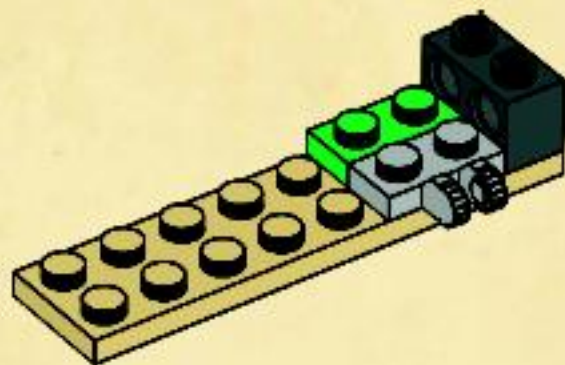

3

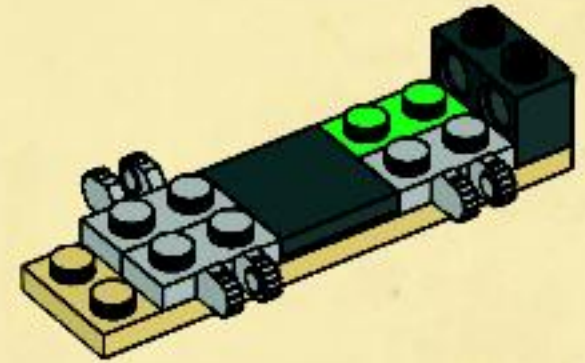

4

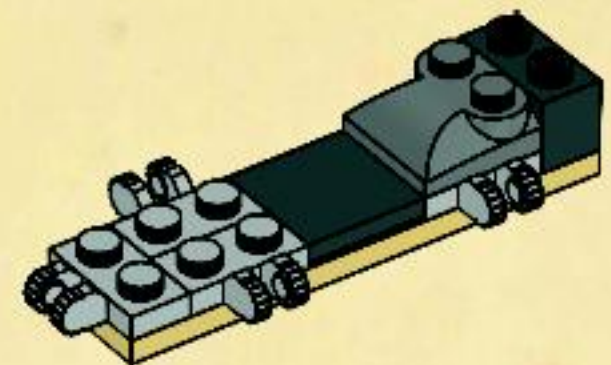



5

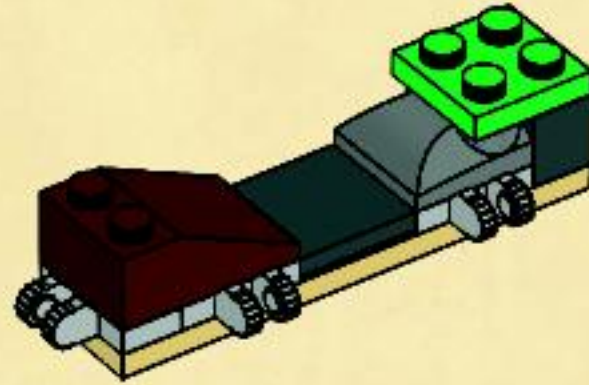

6

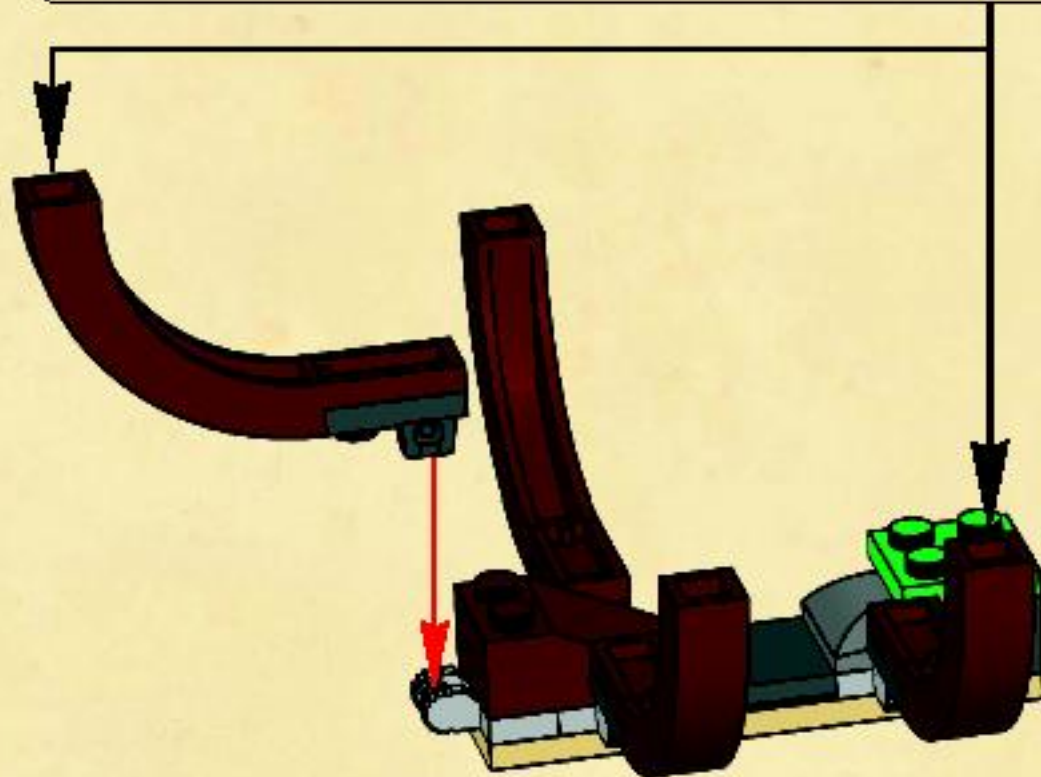
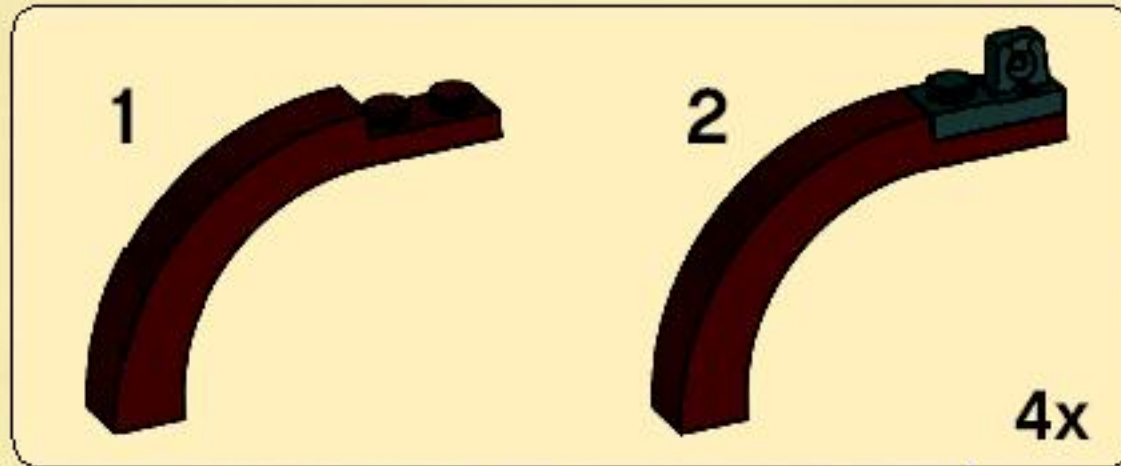

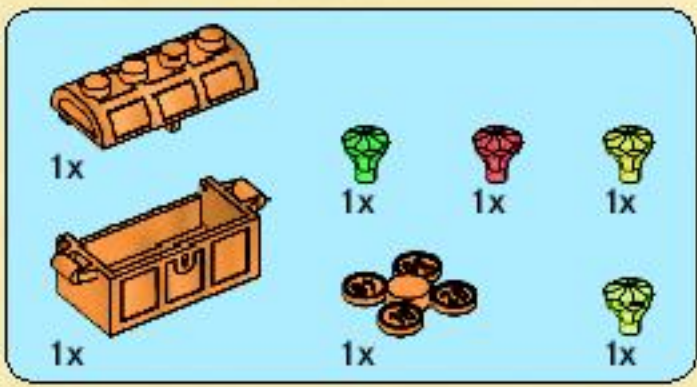

7

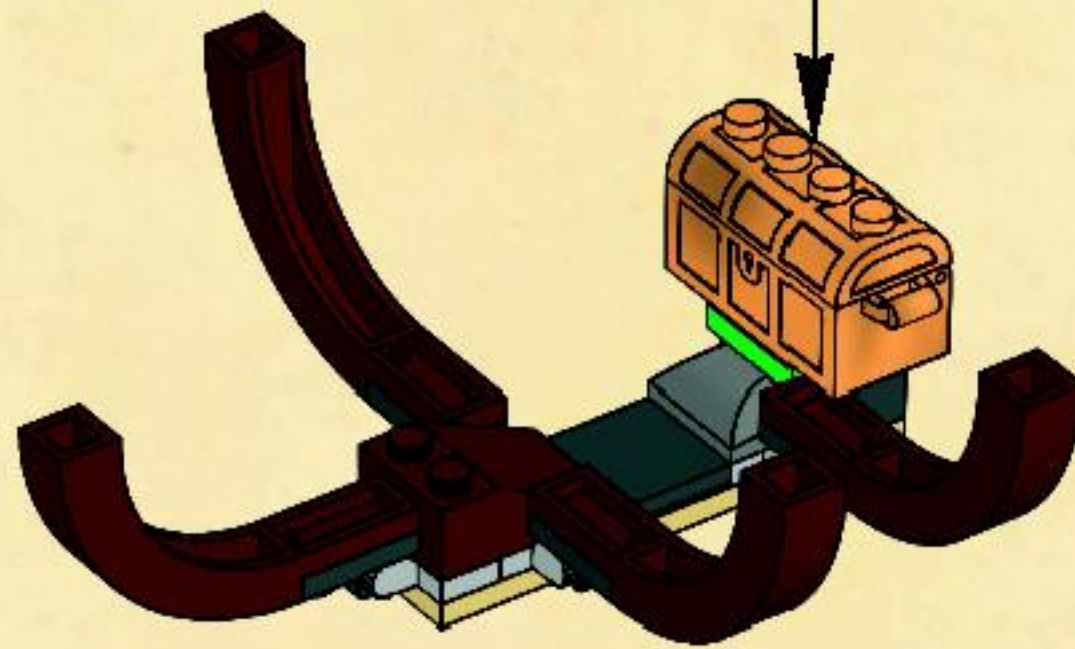
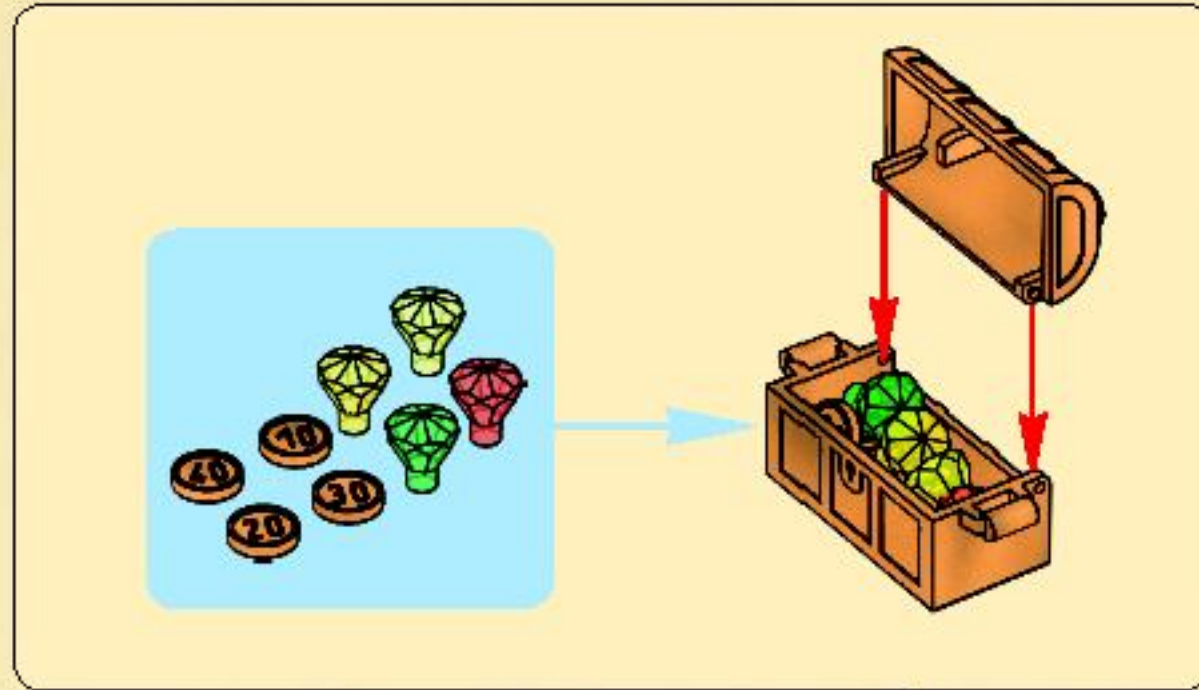

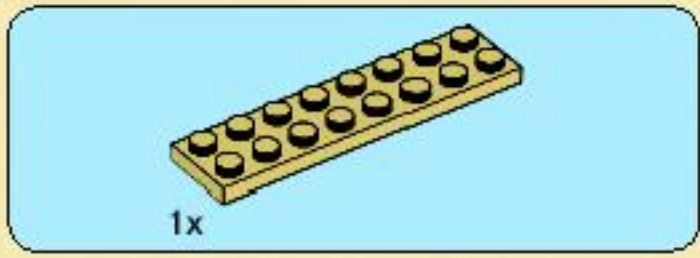
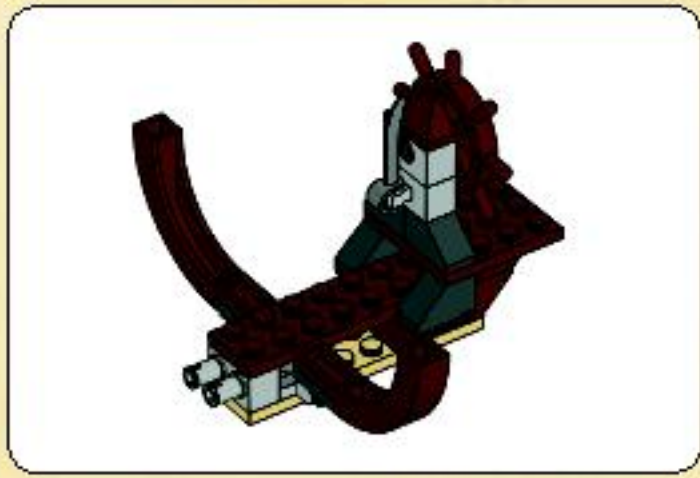

1

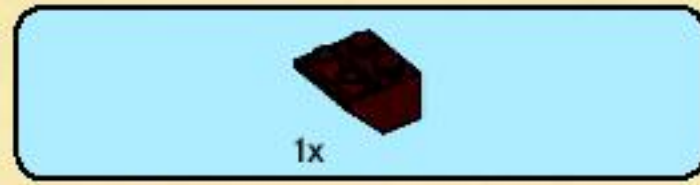
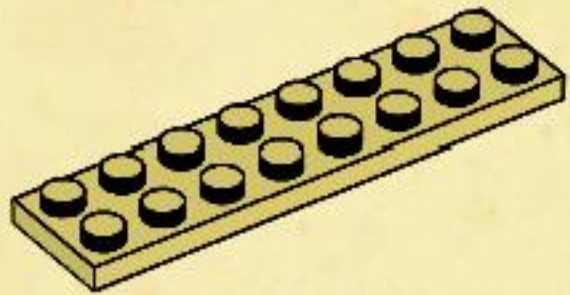

2

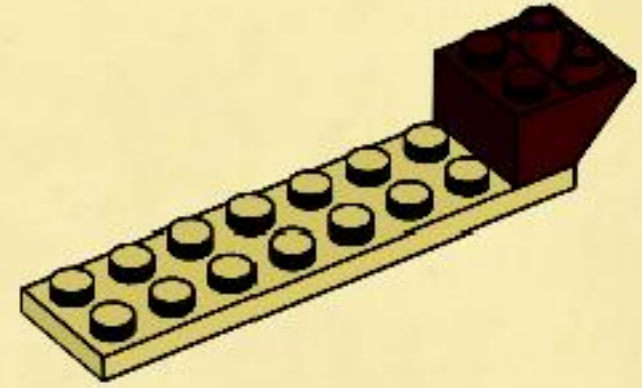

3

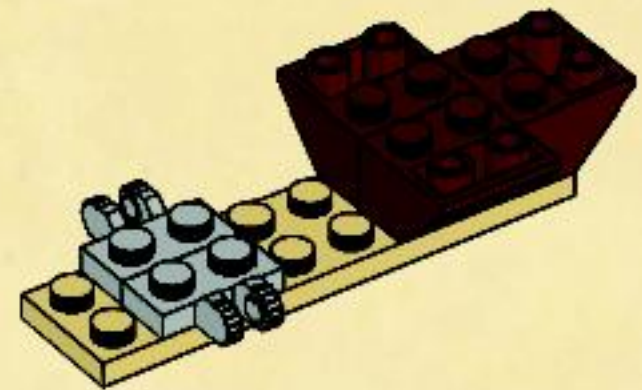



4

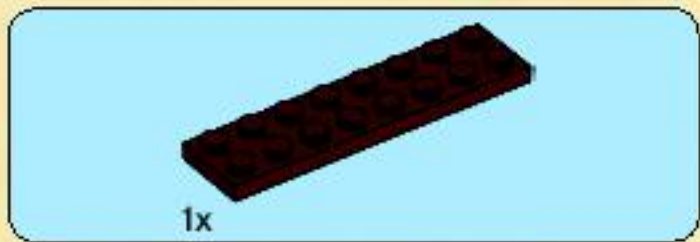
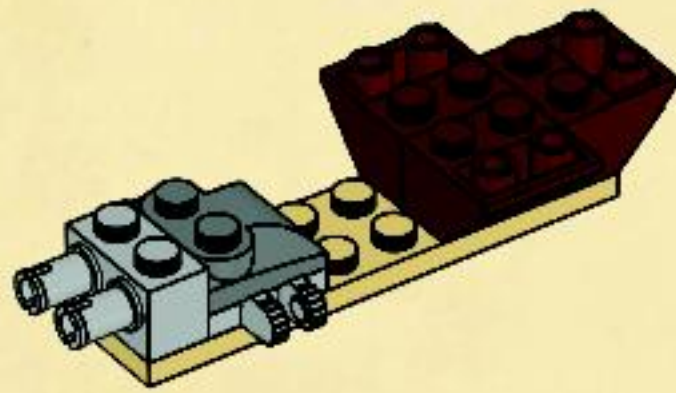

5

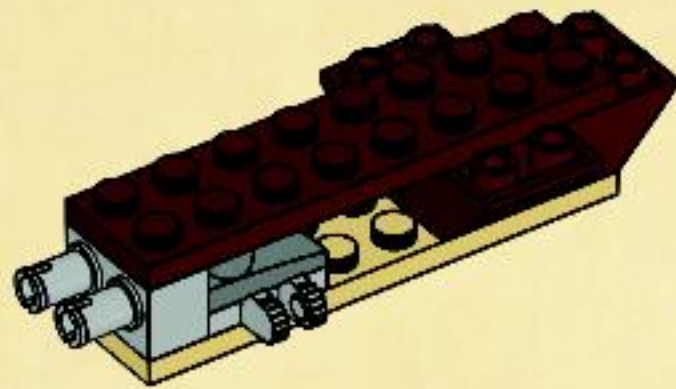

6

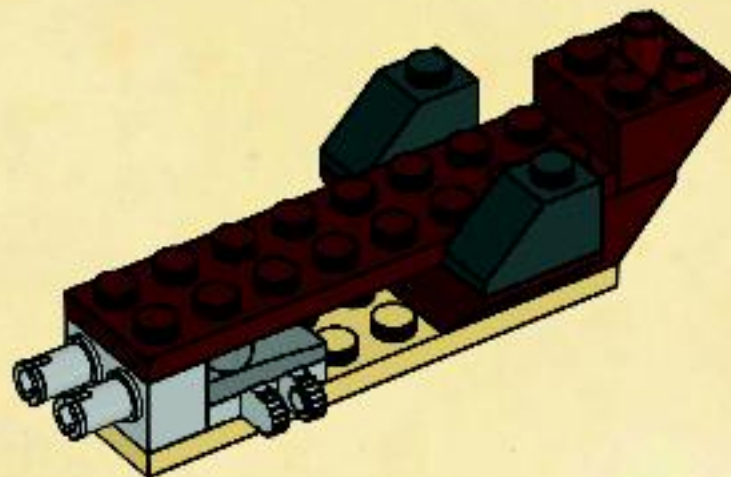

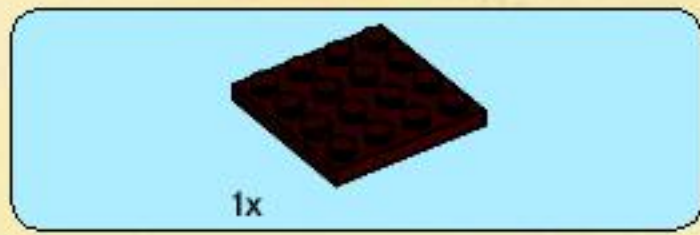

7

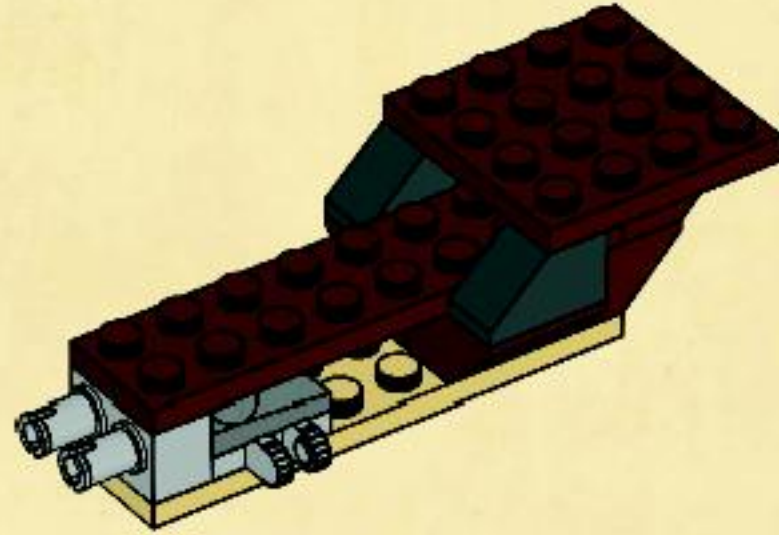

8

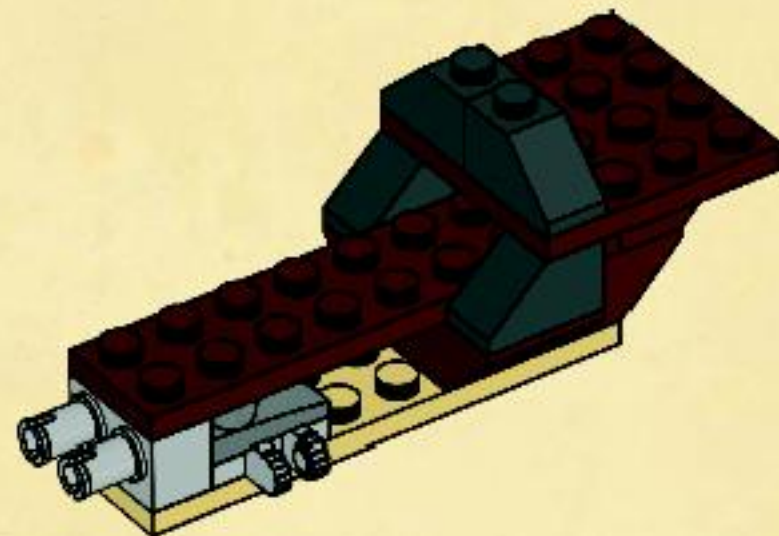

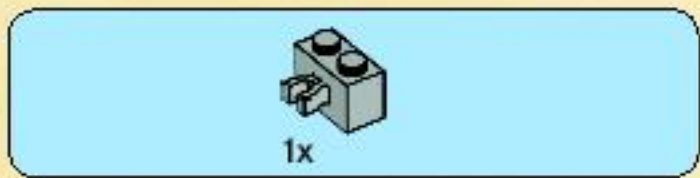

9

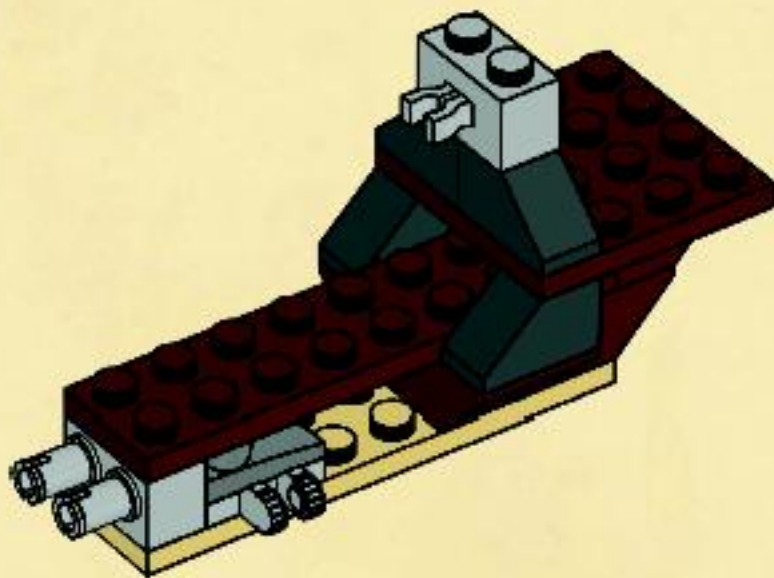

10

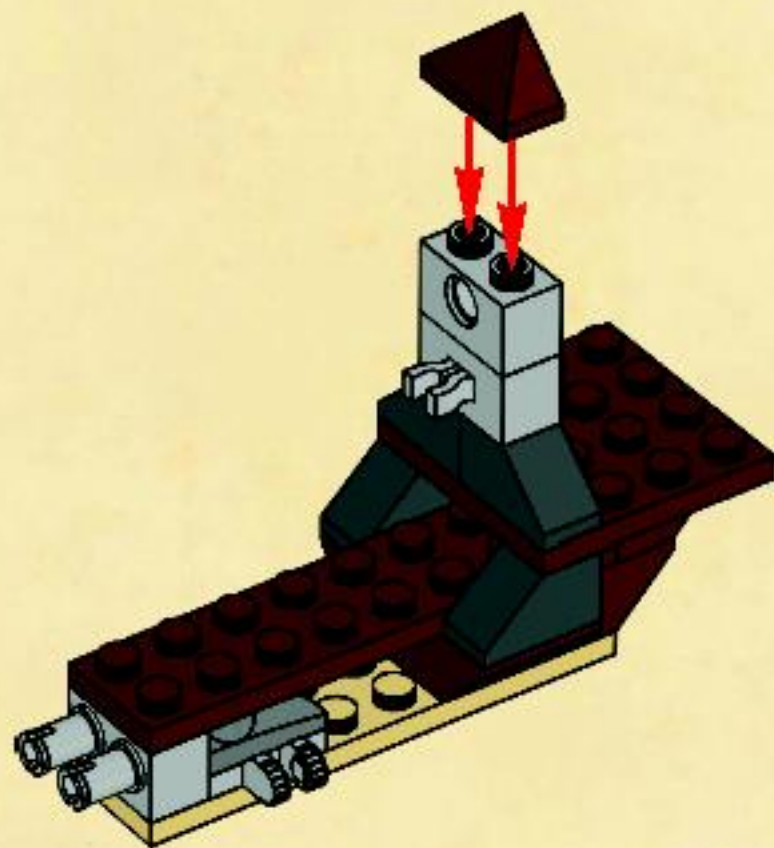



11

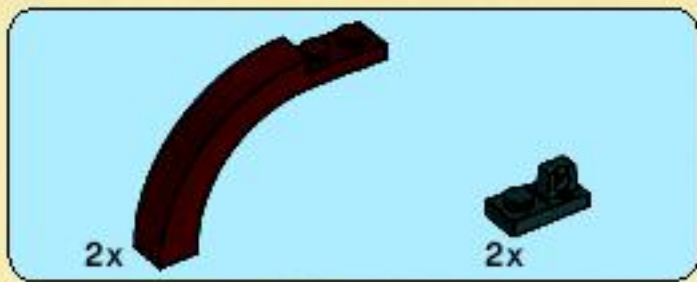
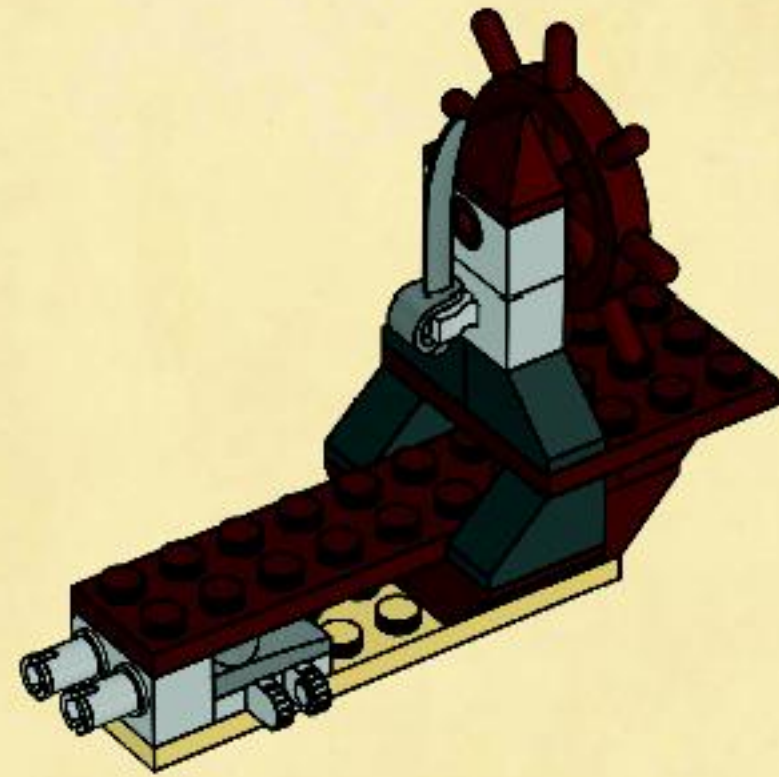

12

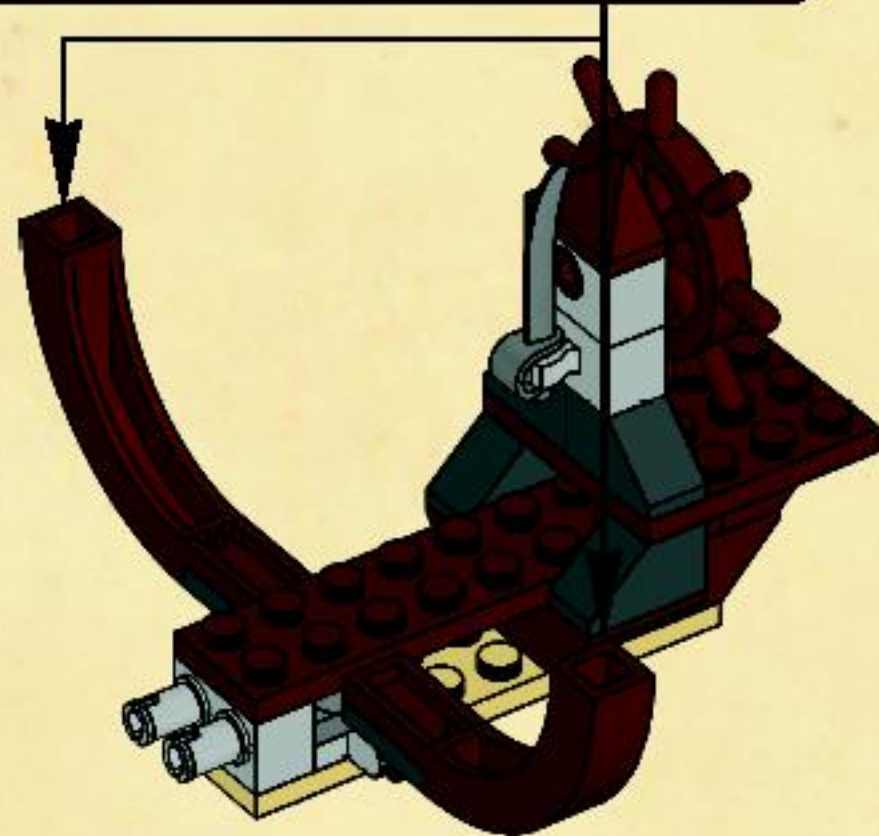
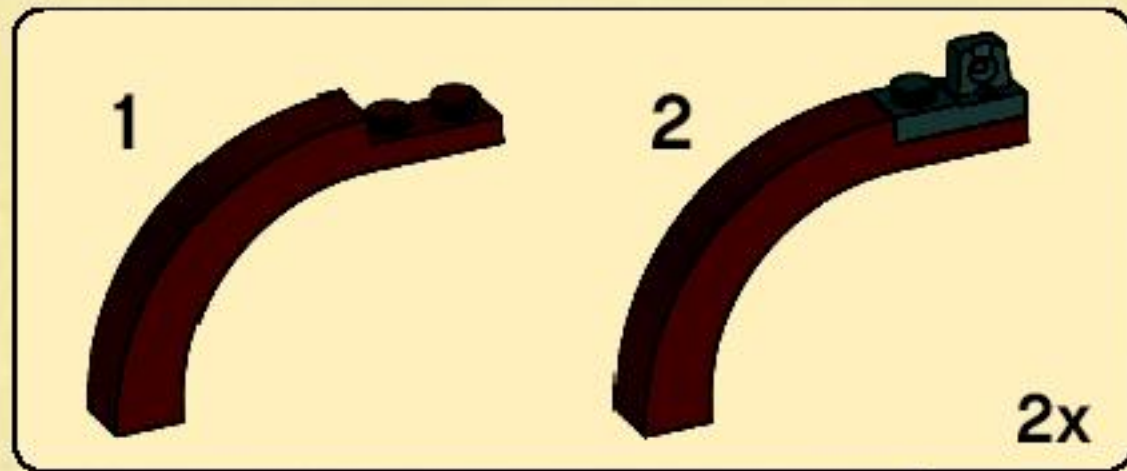



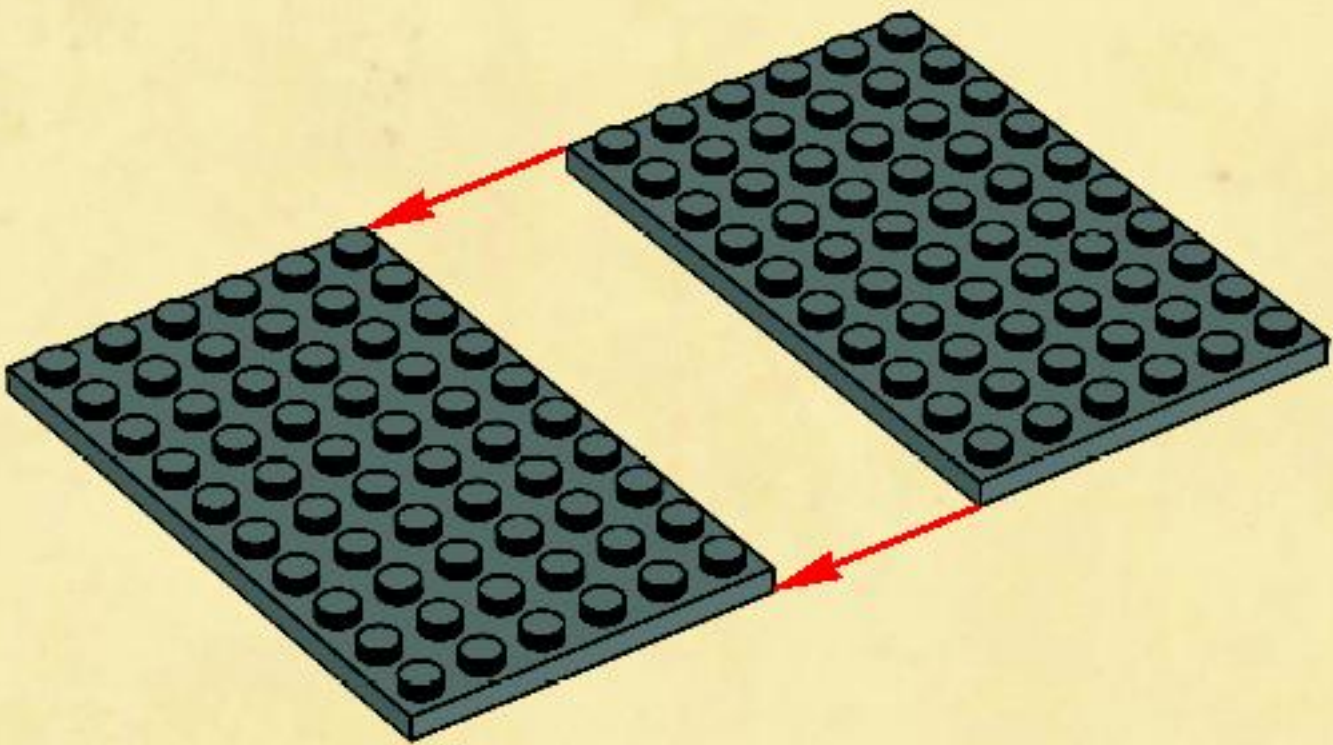
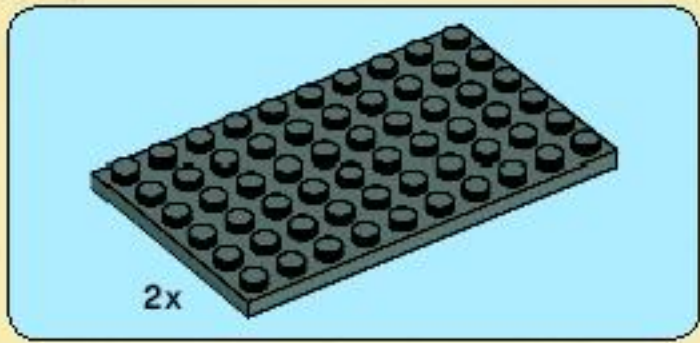
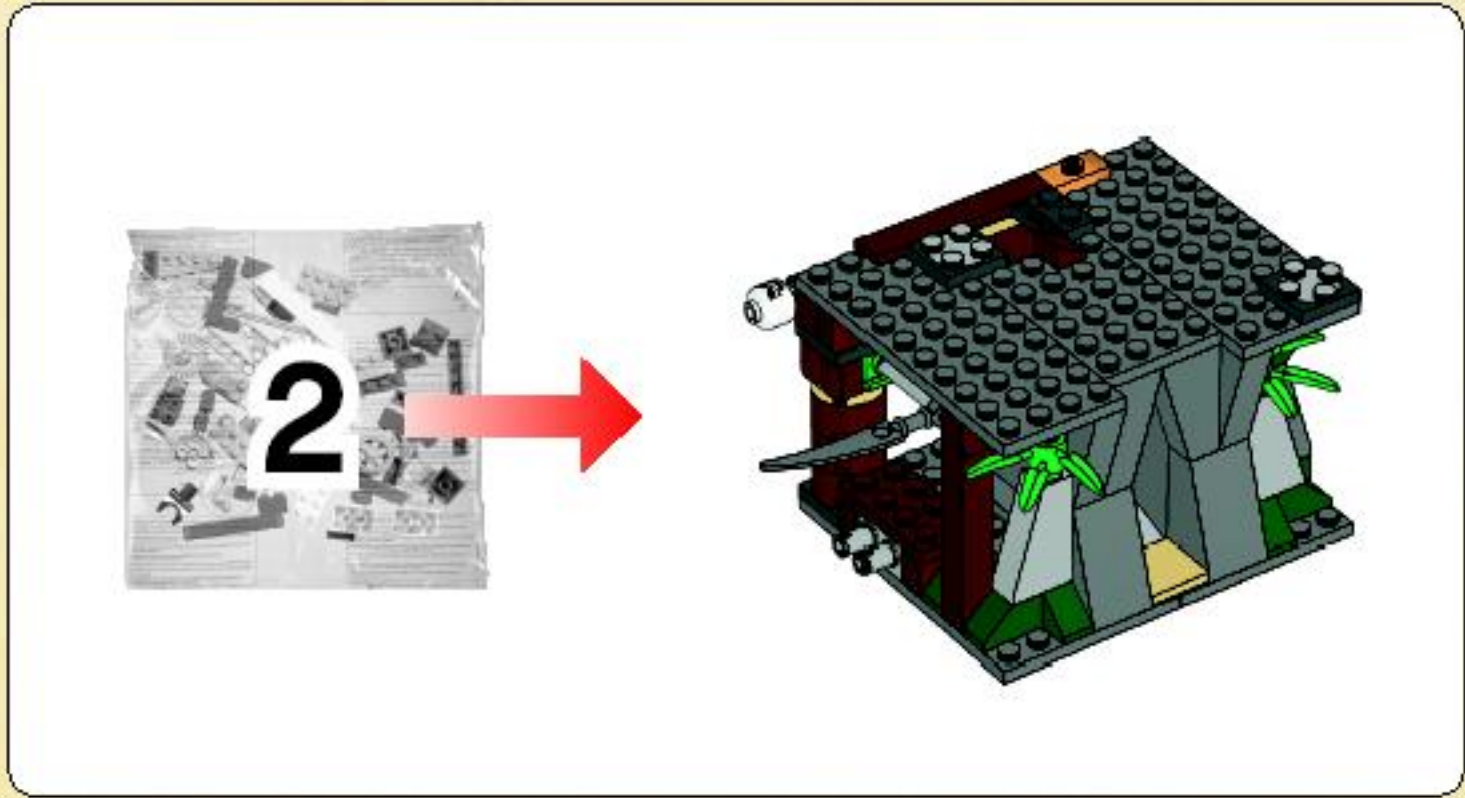

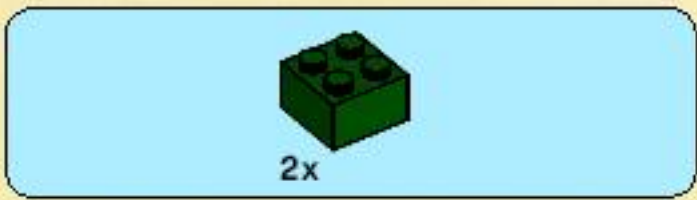

2

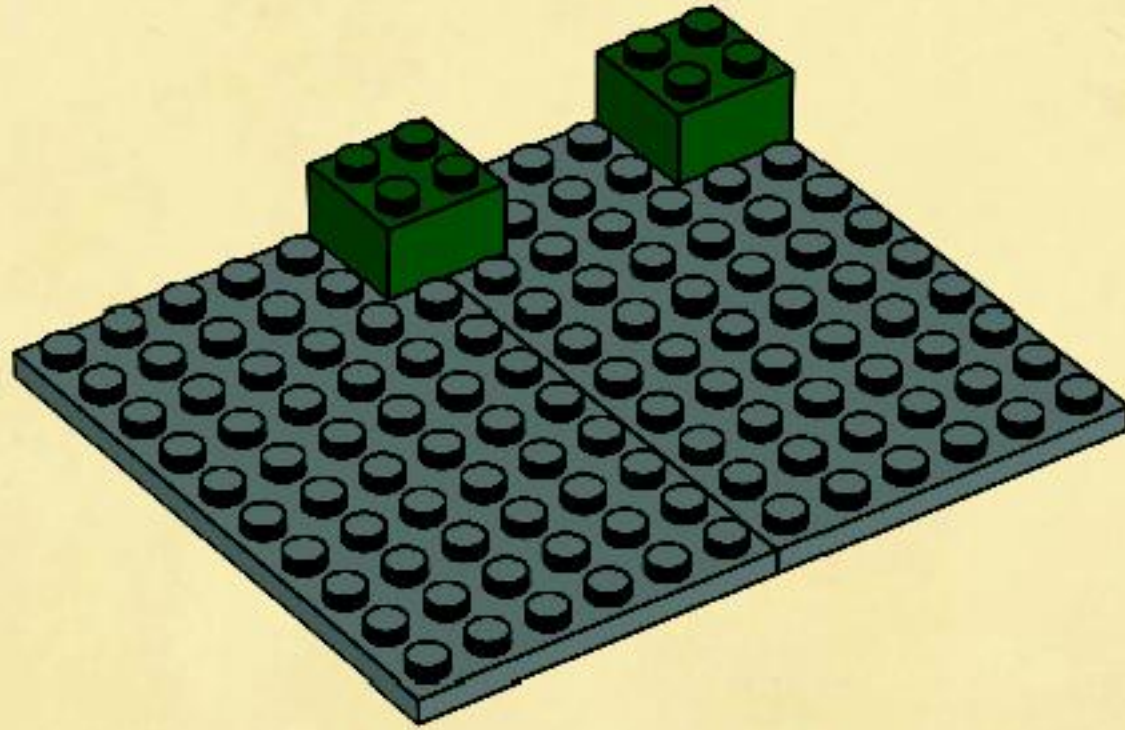

3

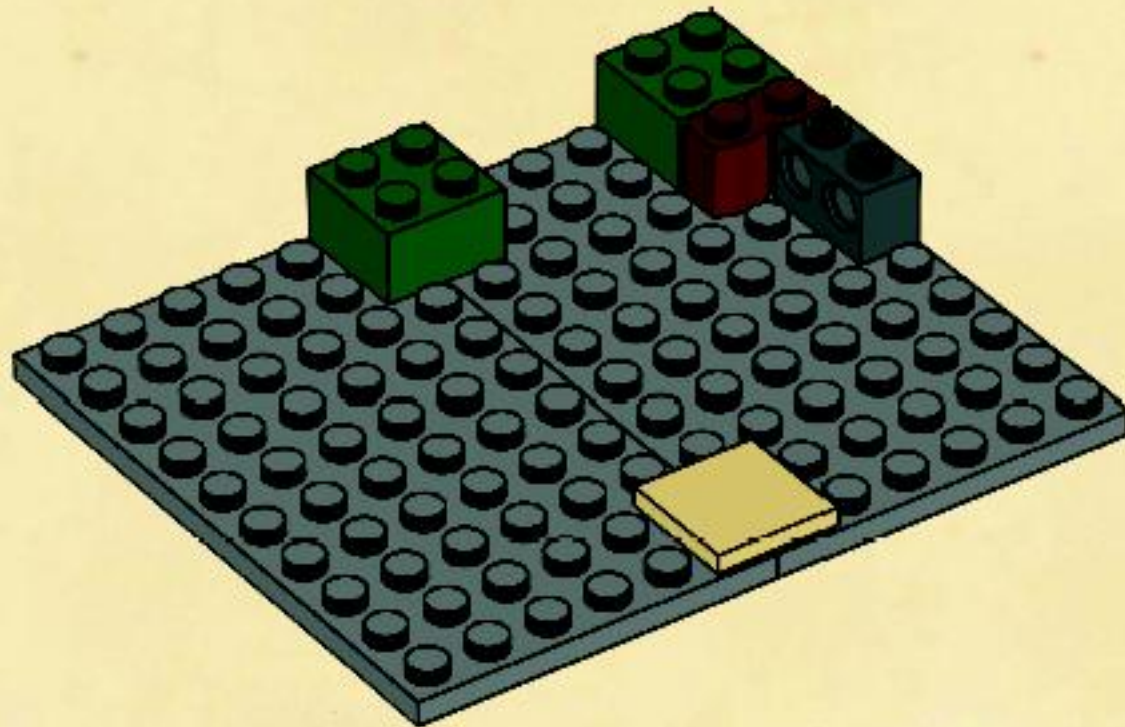



4

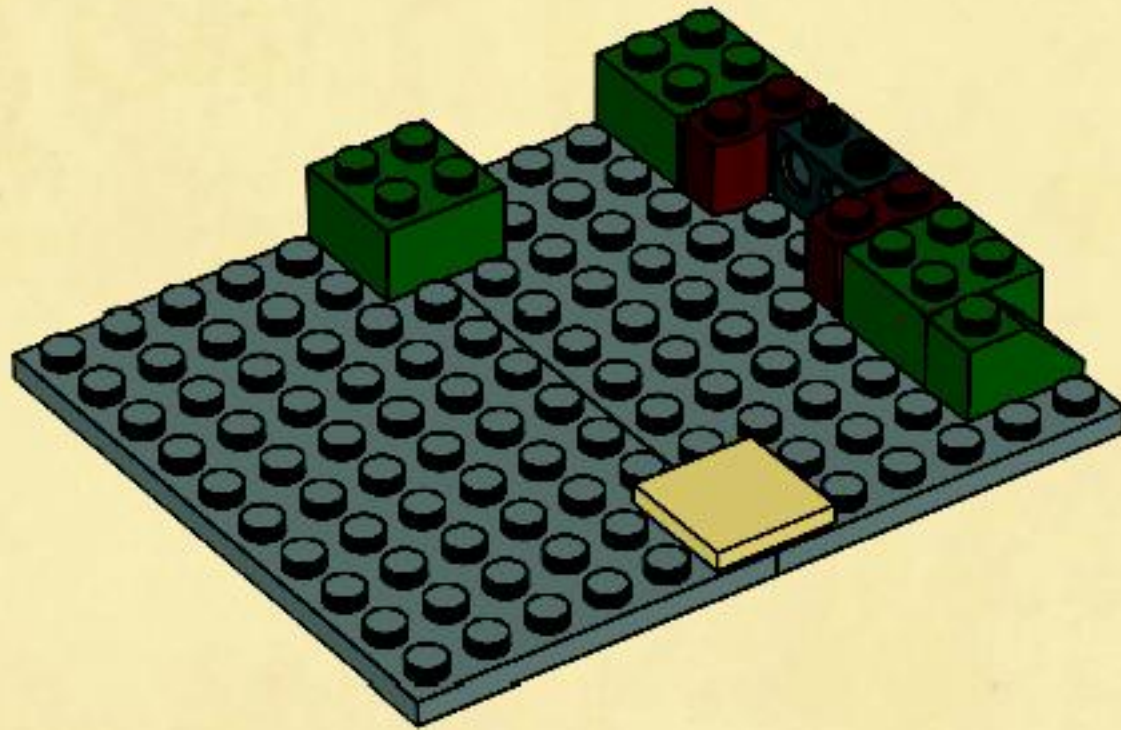

5

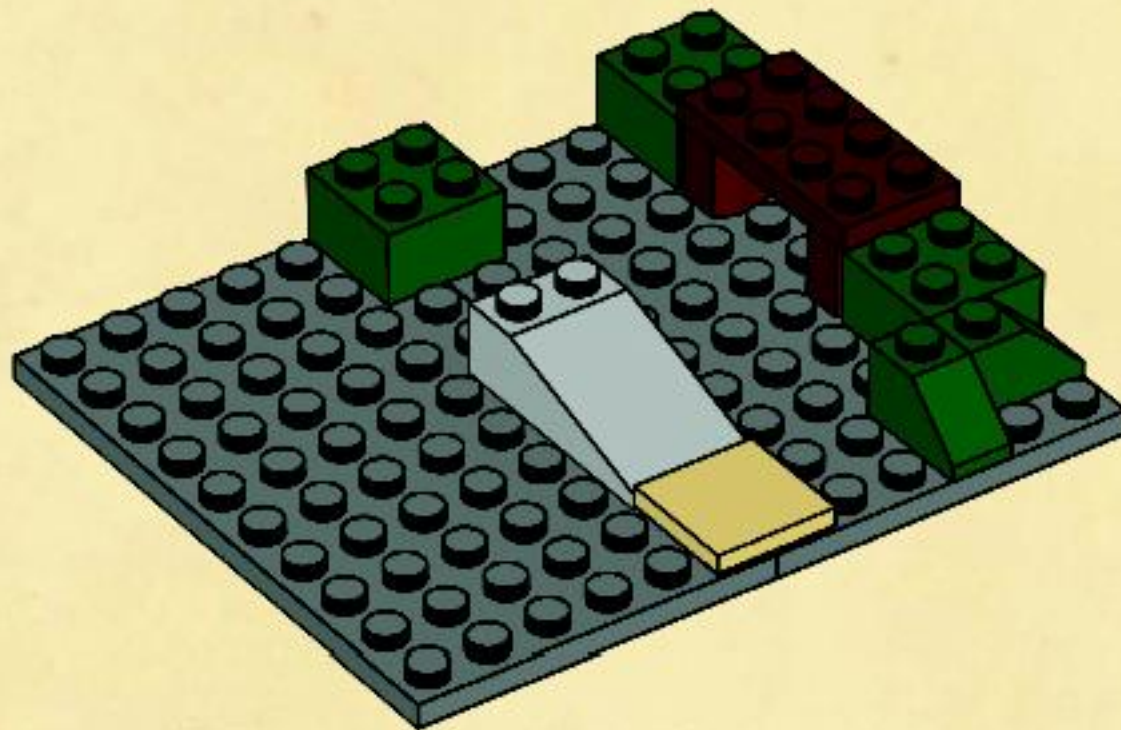

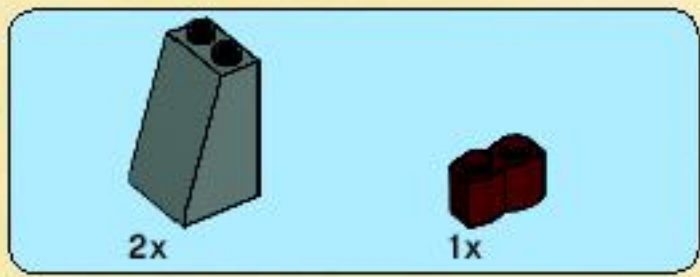

6

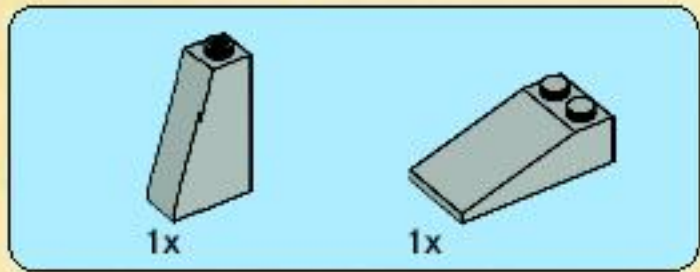
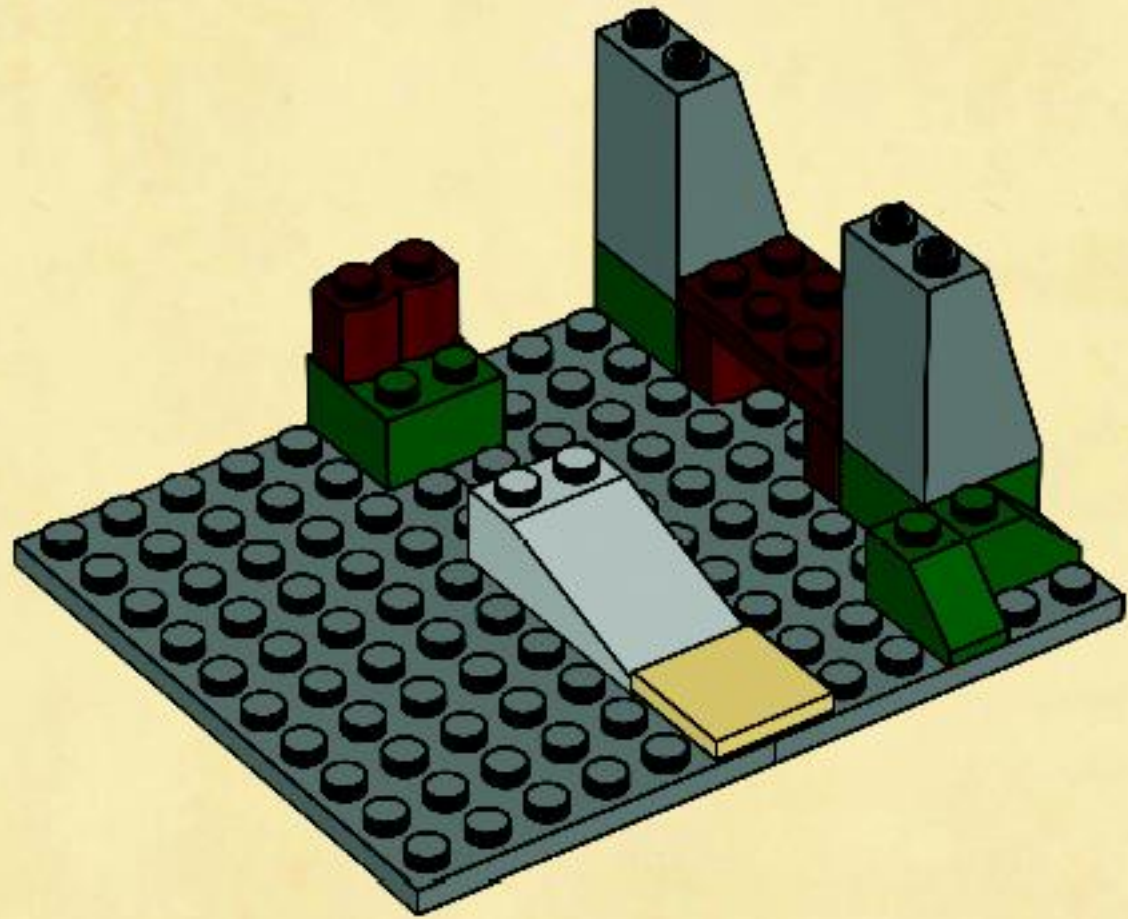

7

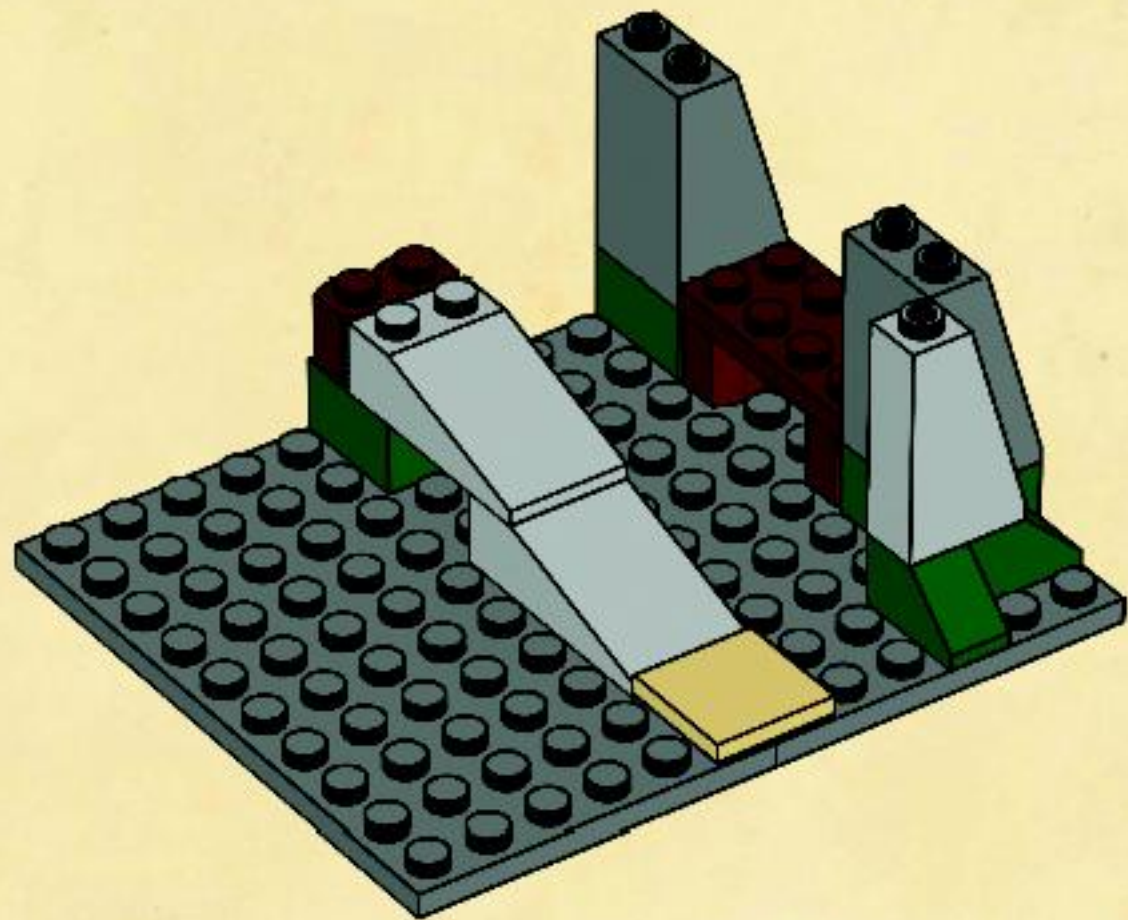

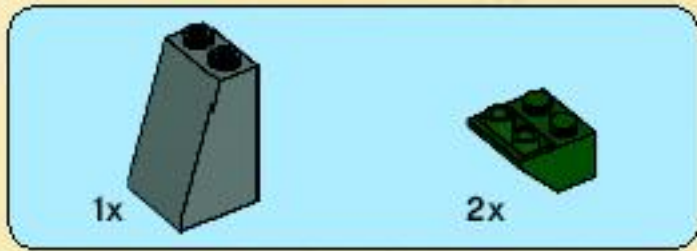

8

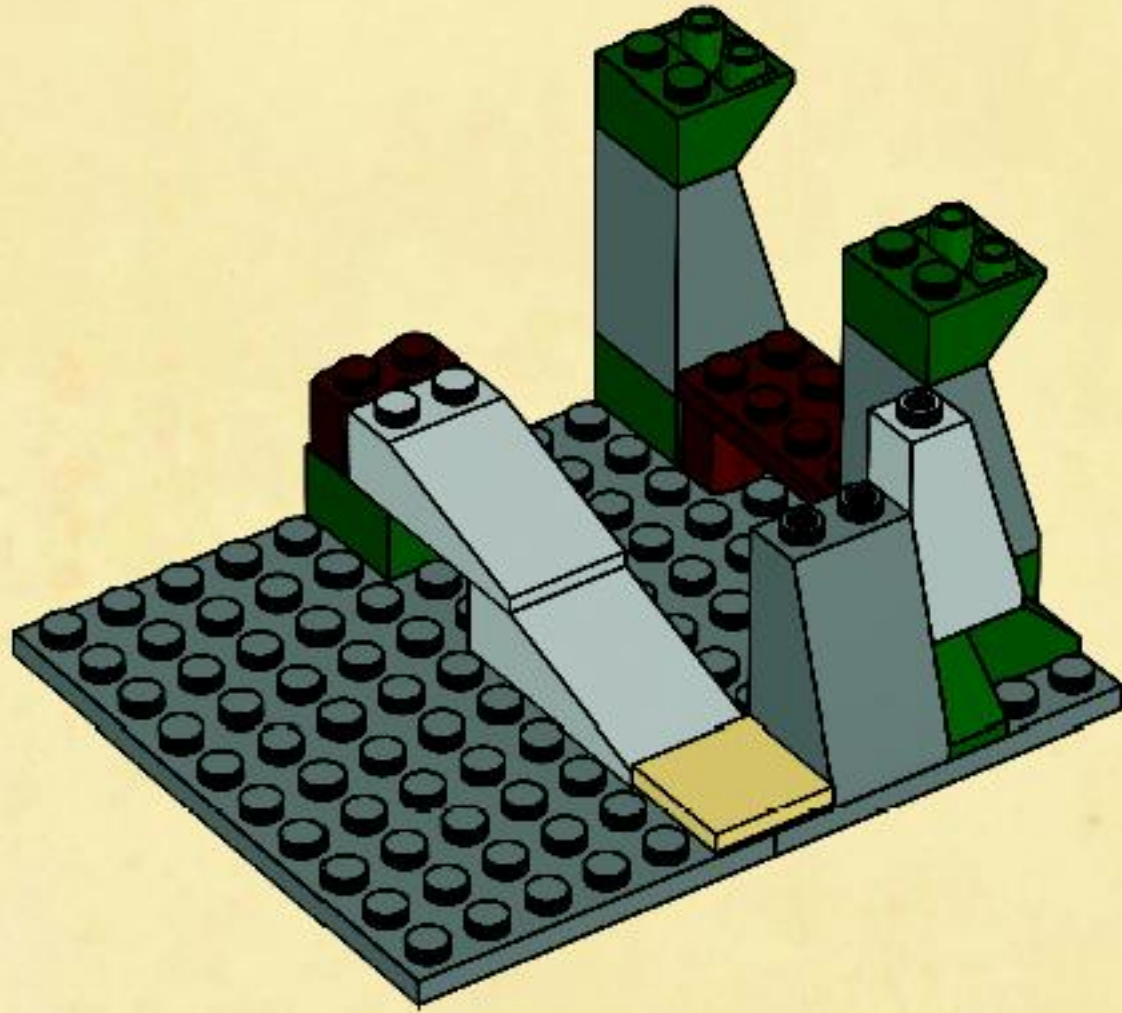

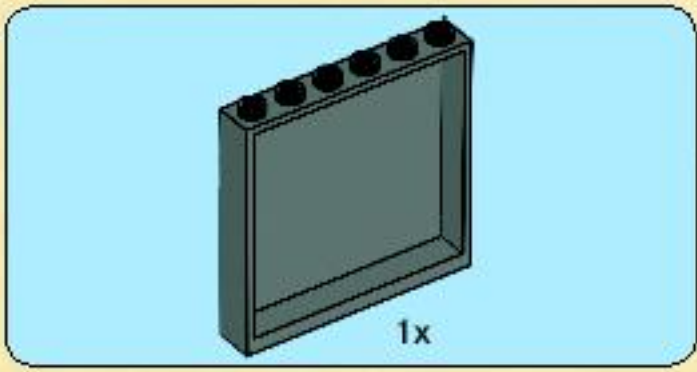

9

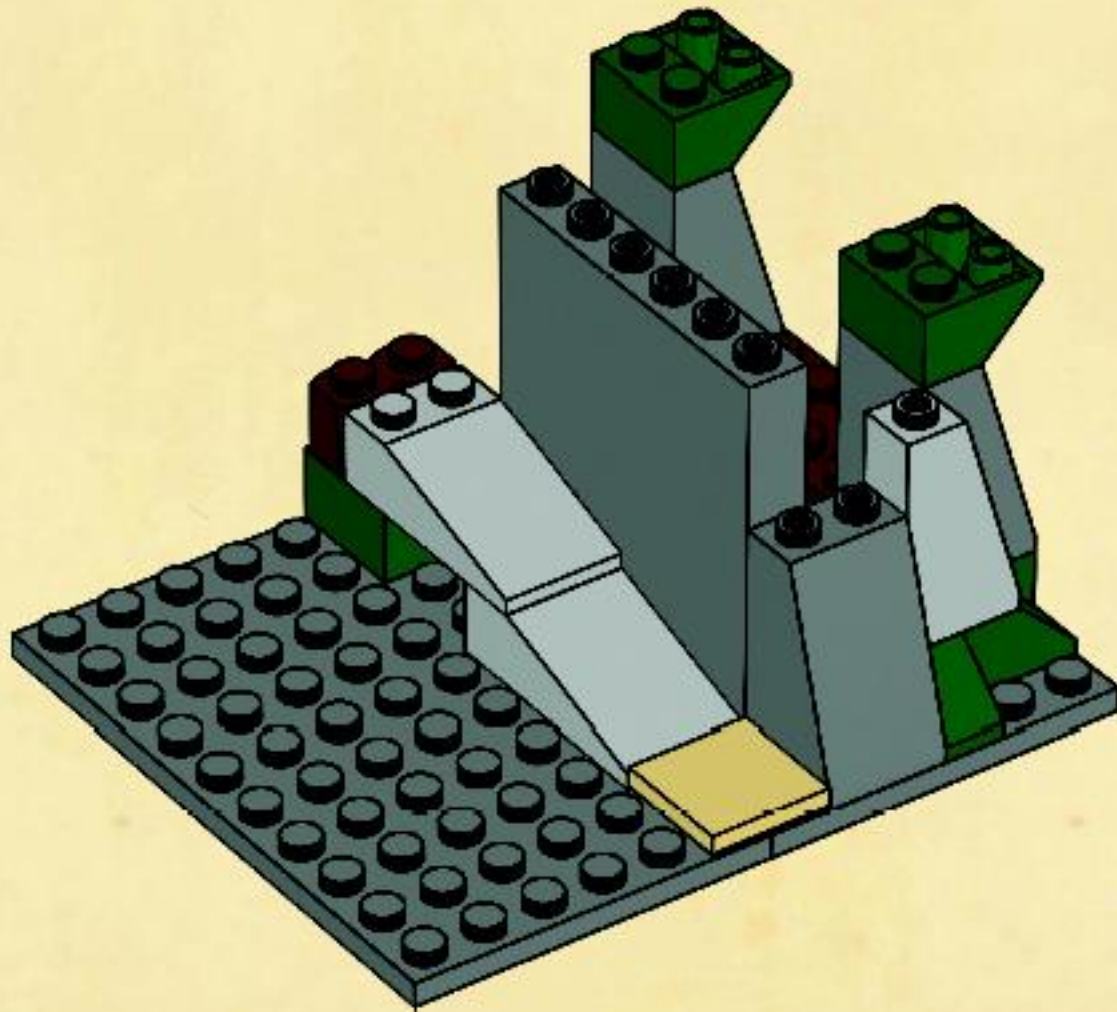

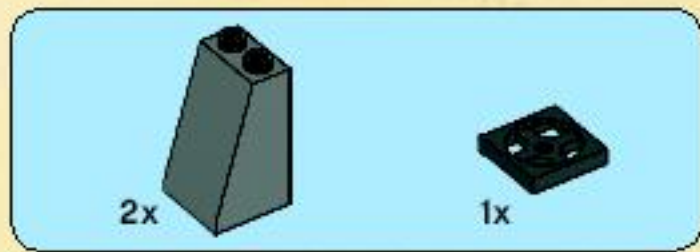

10

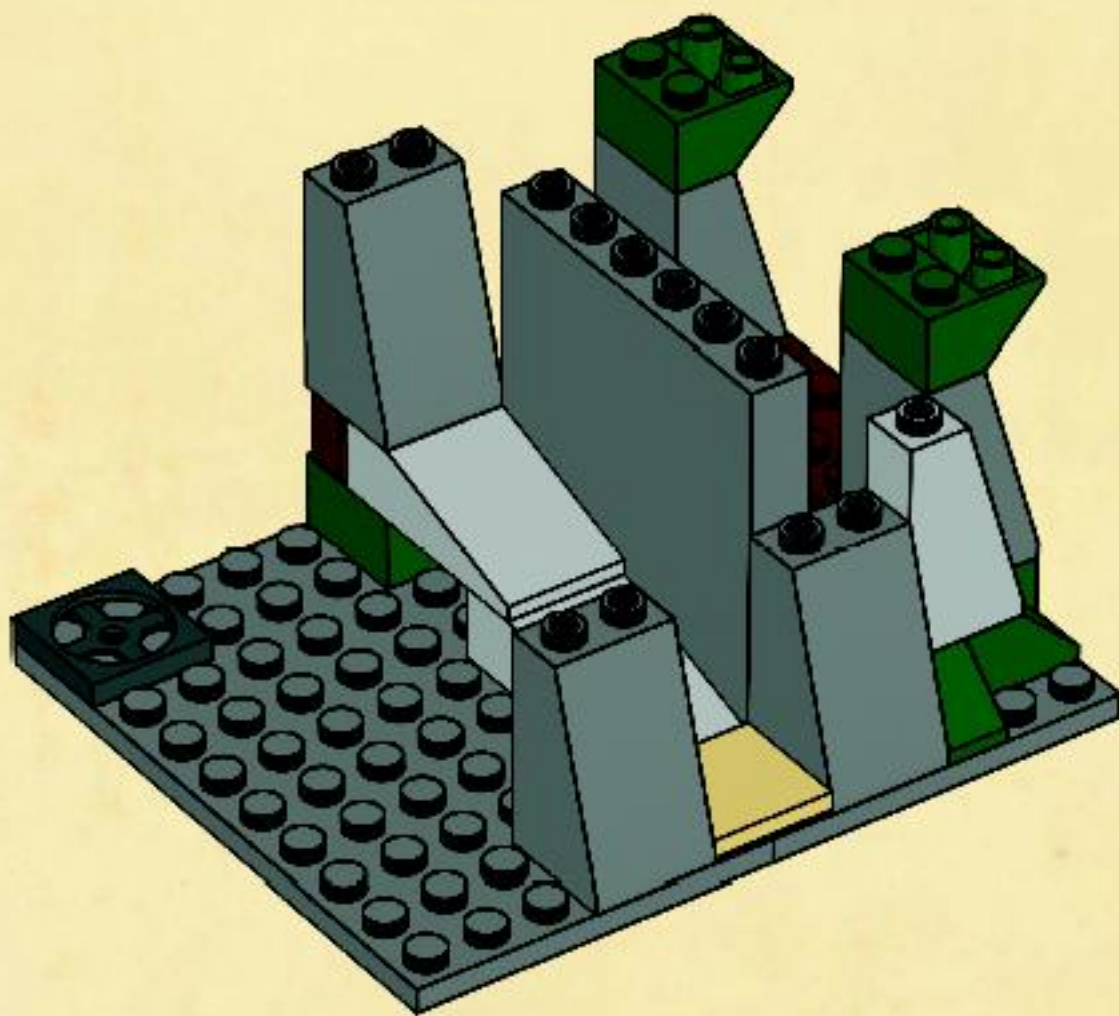

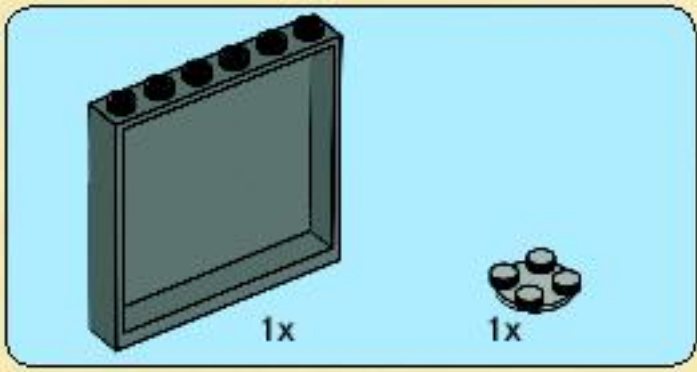

11

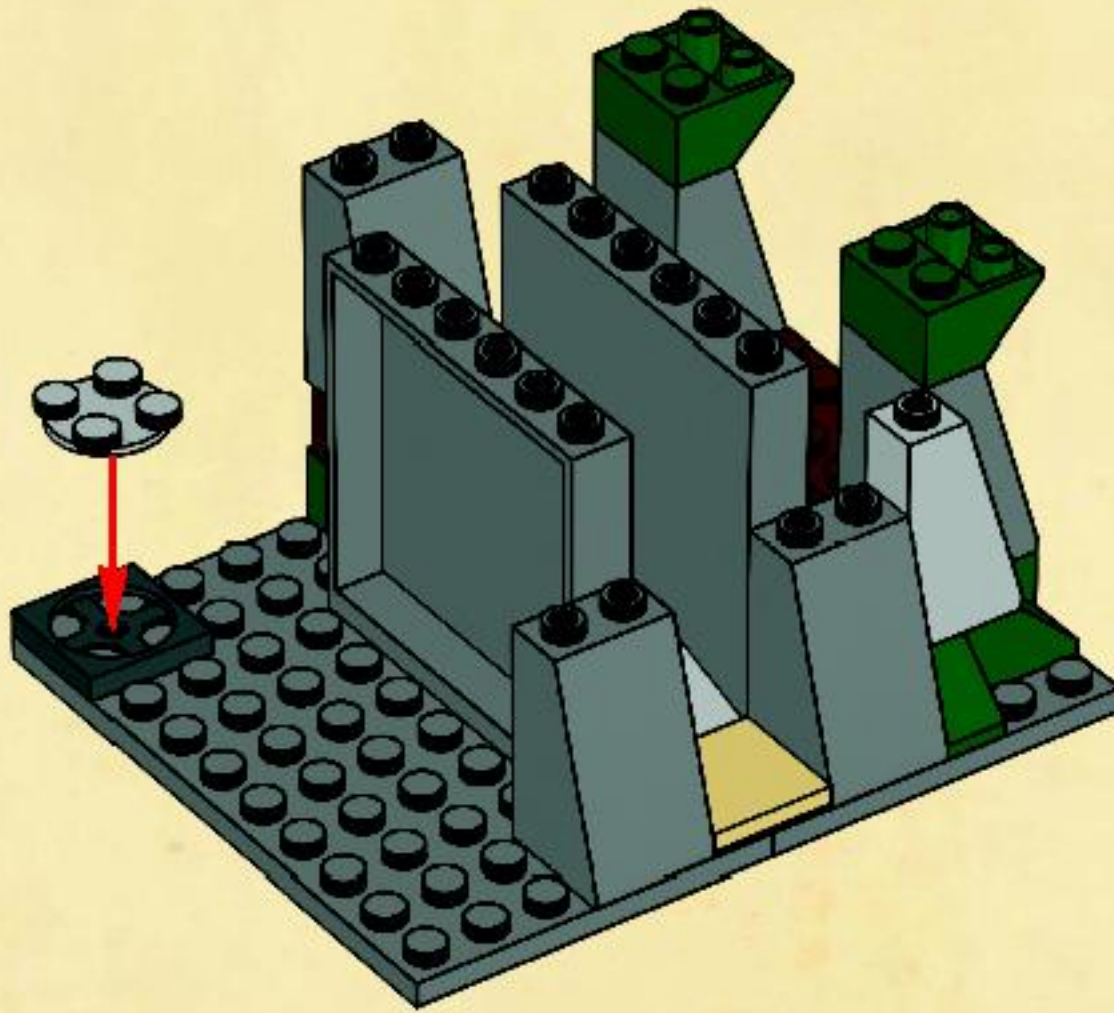



12

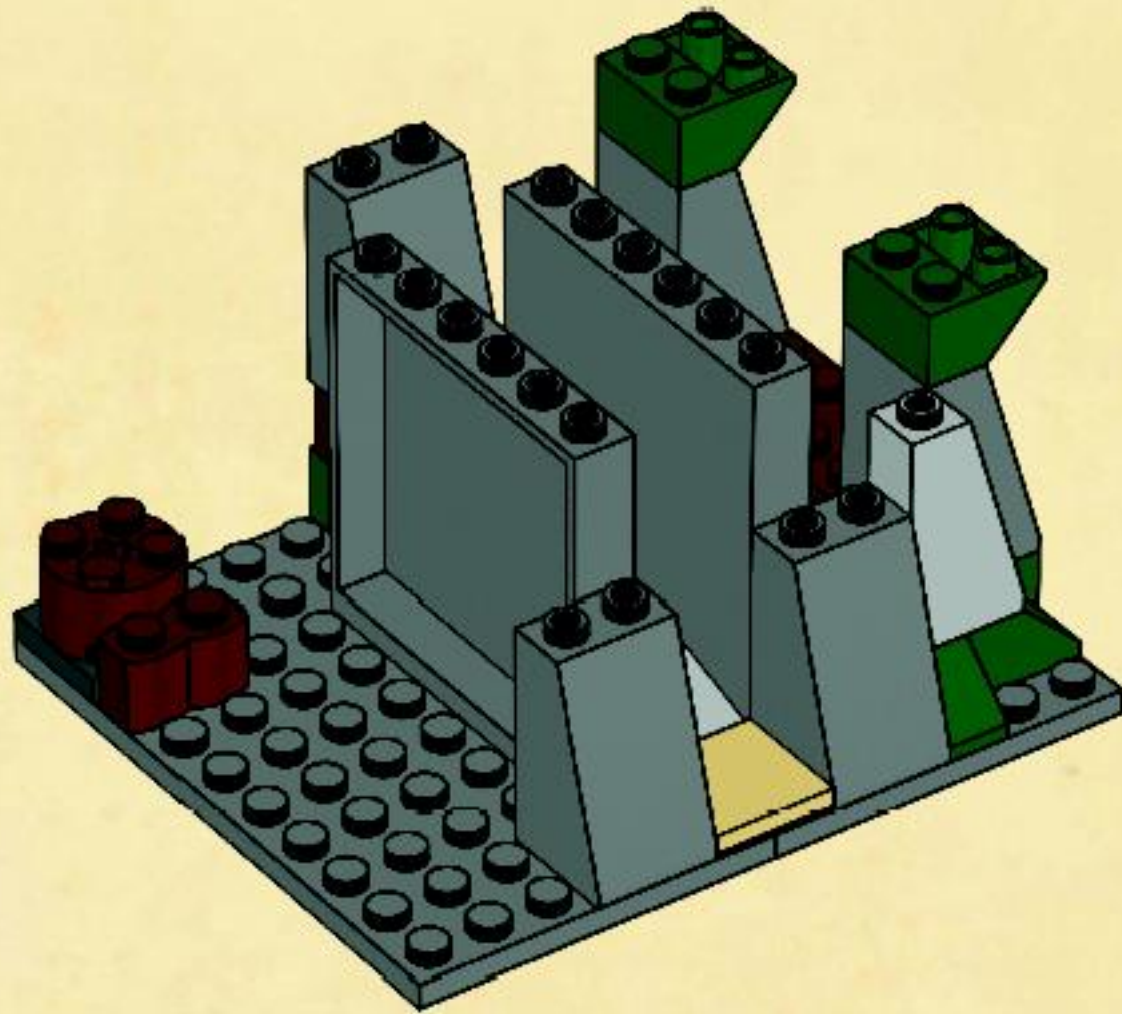

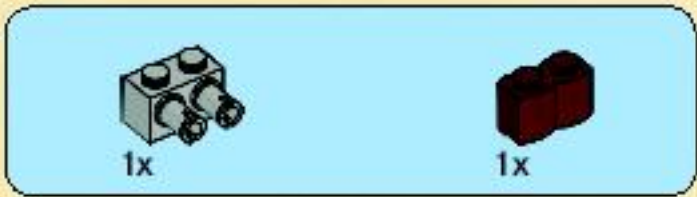

13

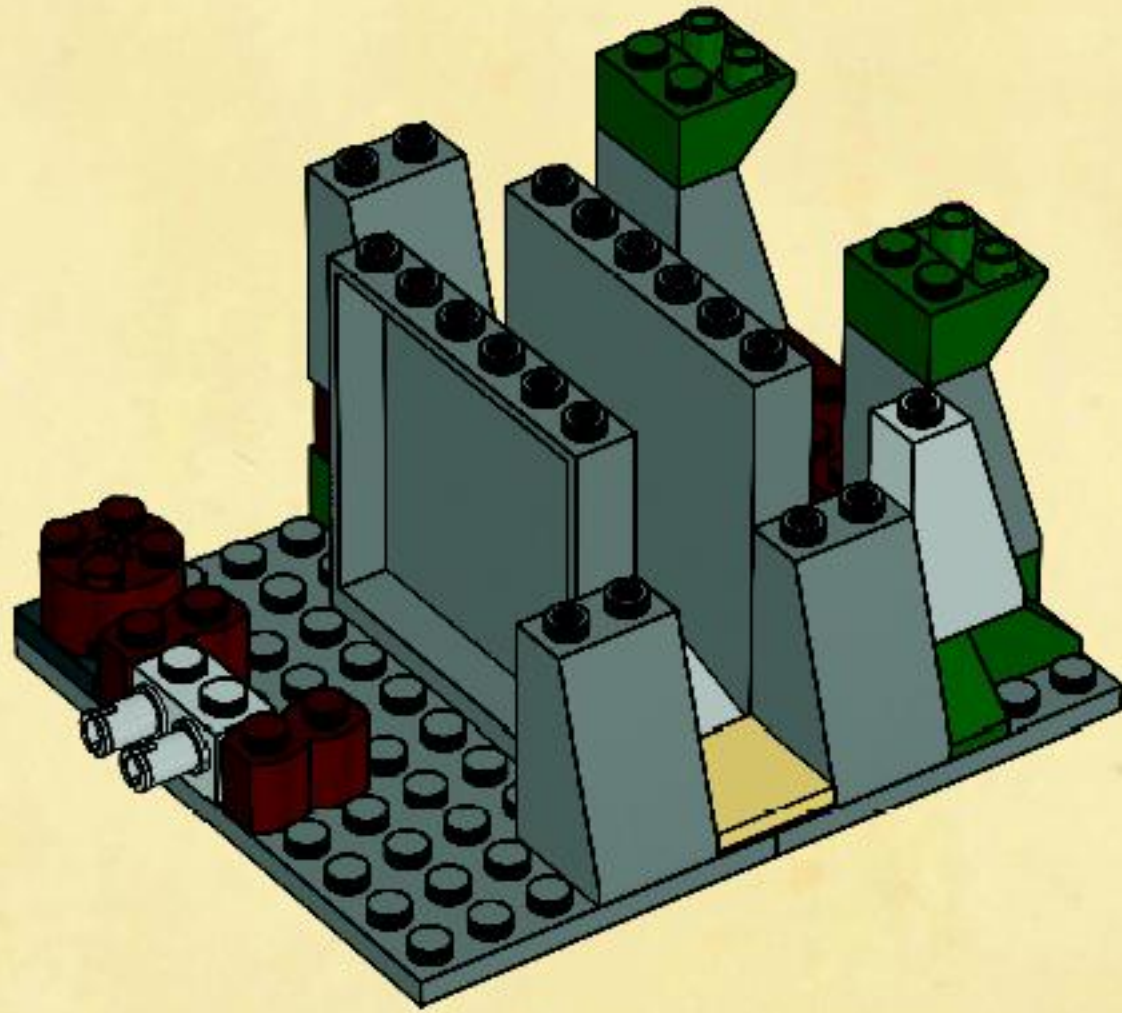



14

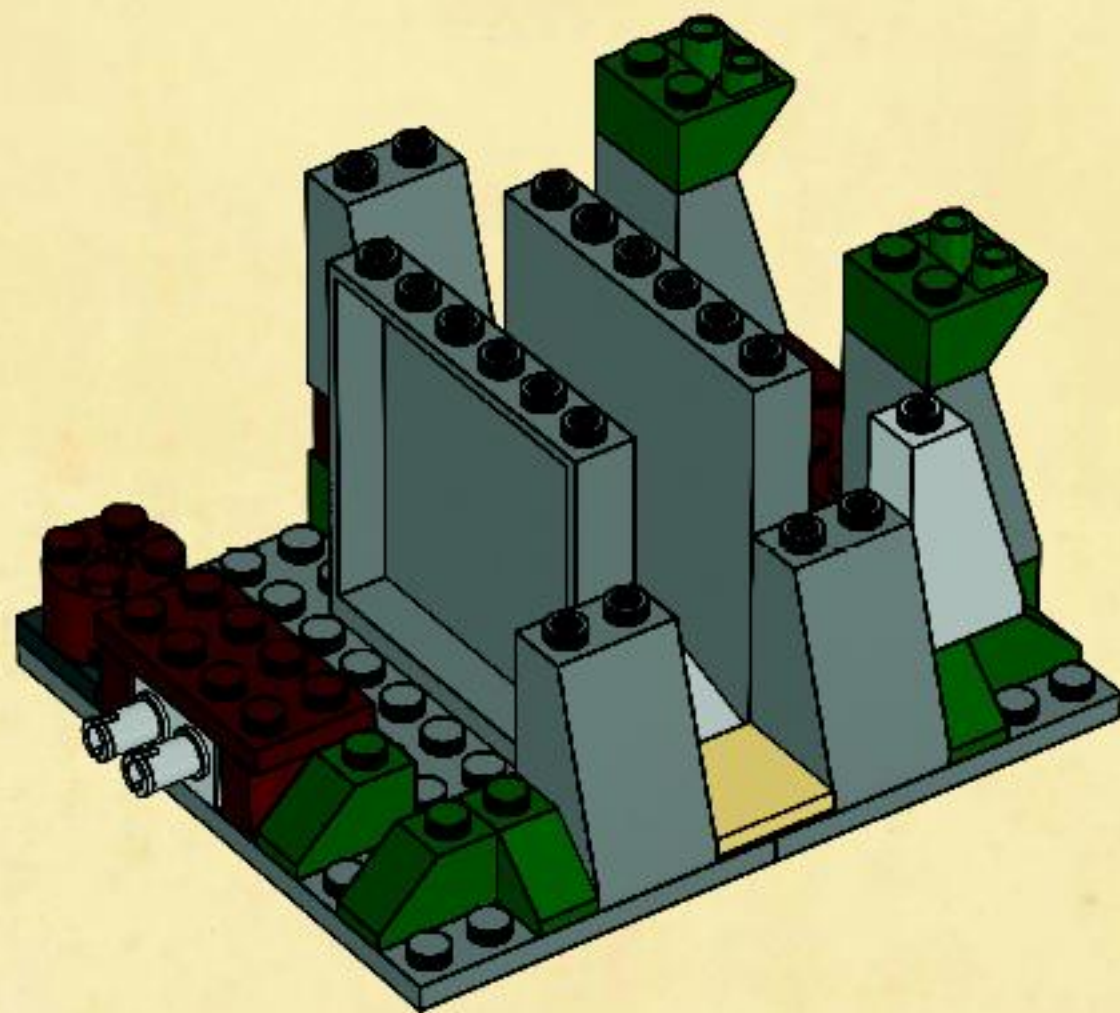

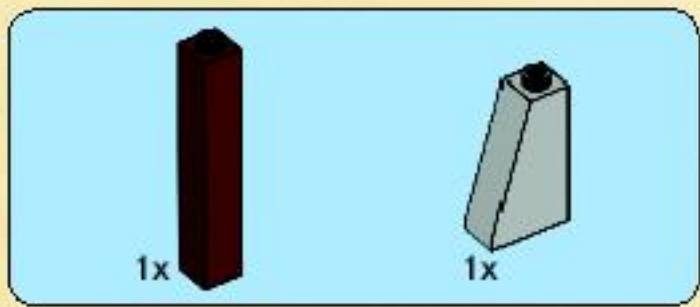

15

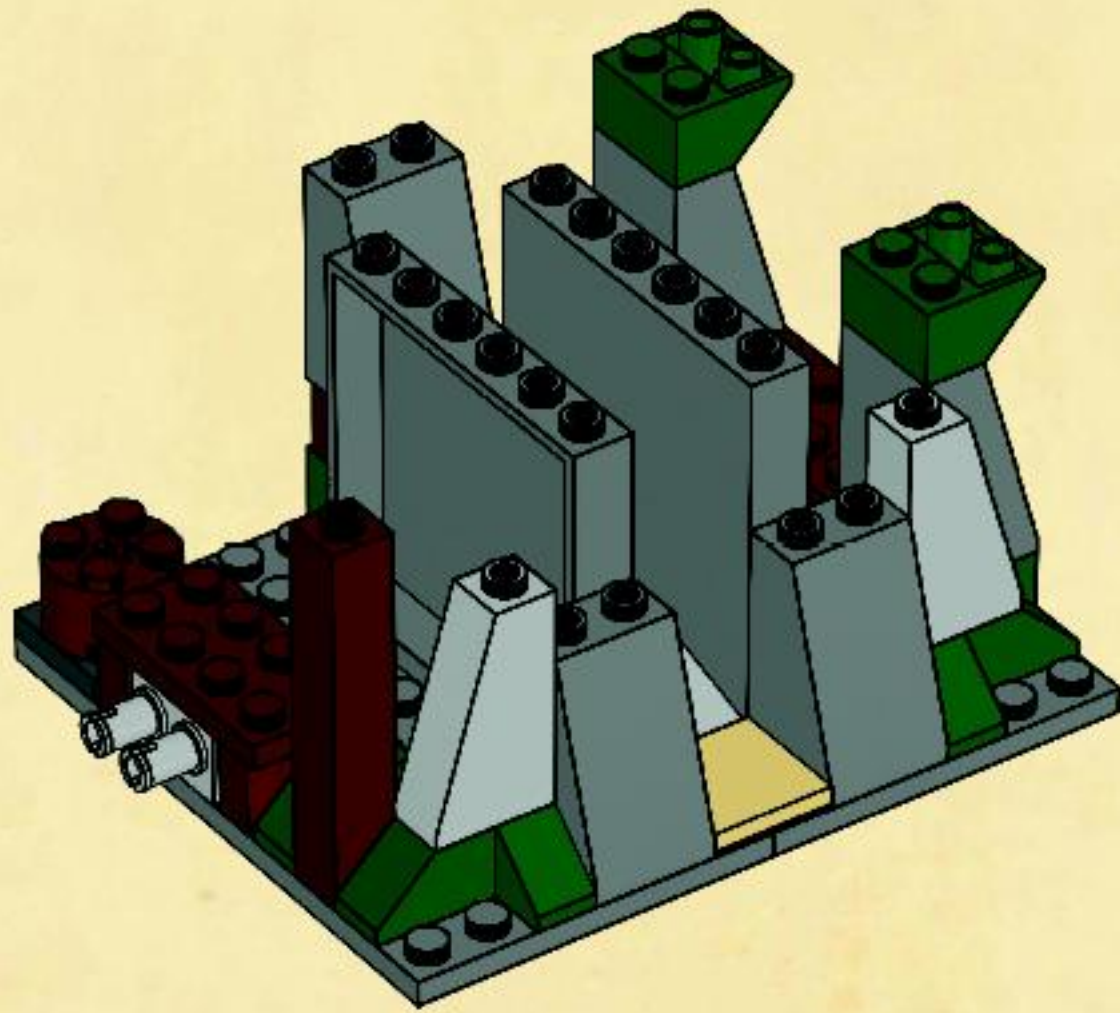

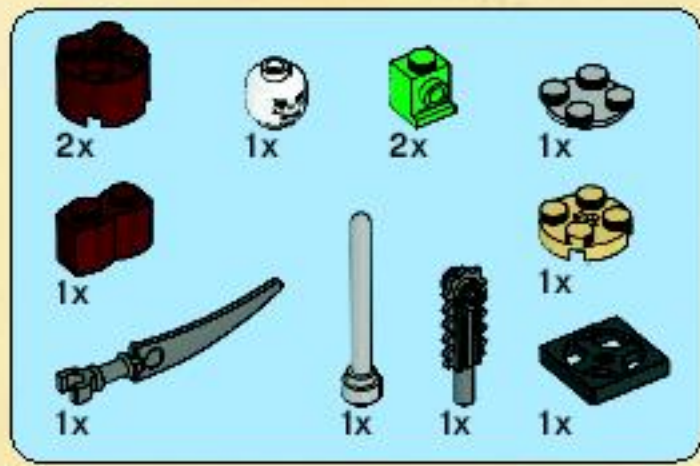

16

1



2



3



4



5



6



7

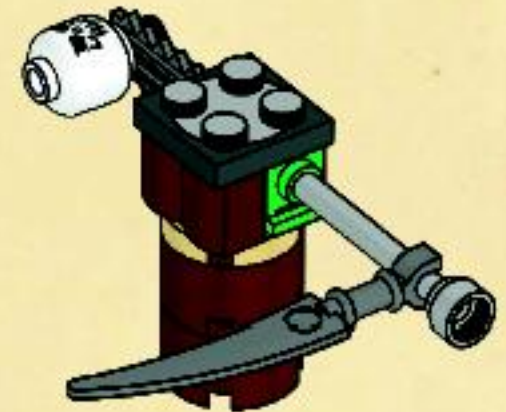

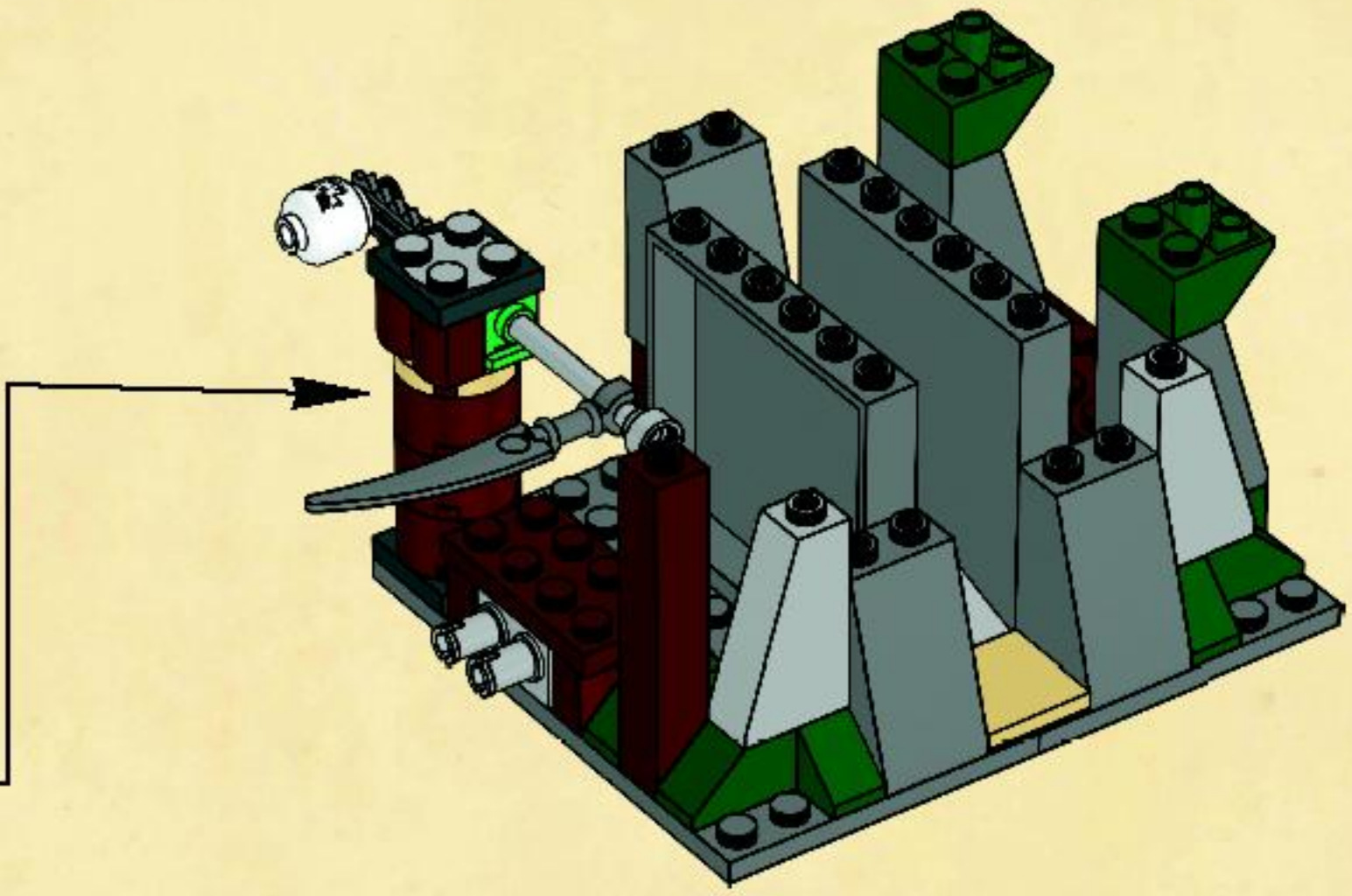

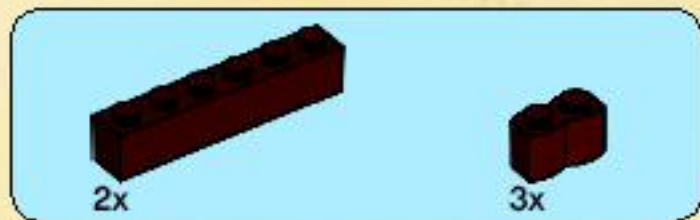

17

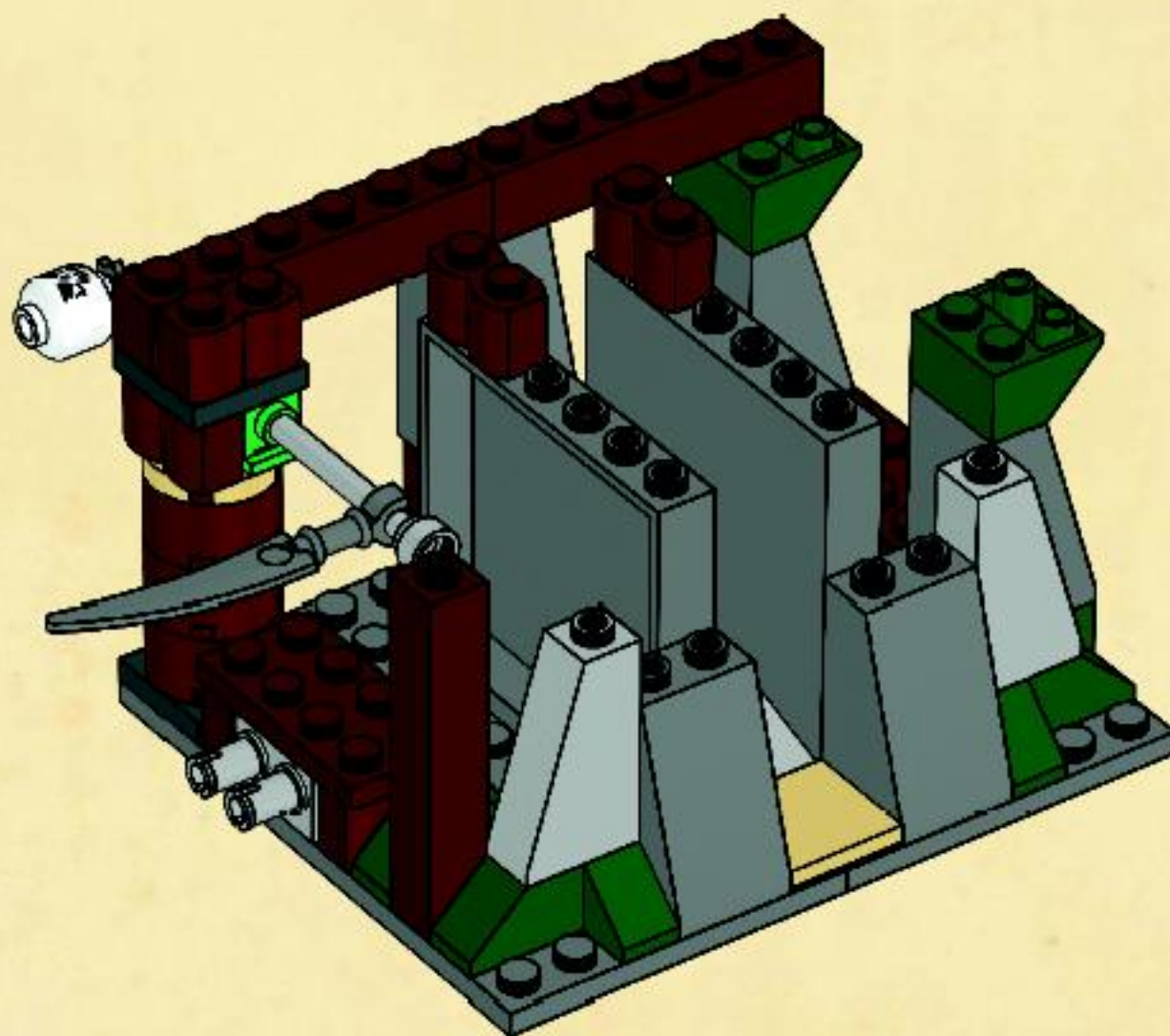

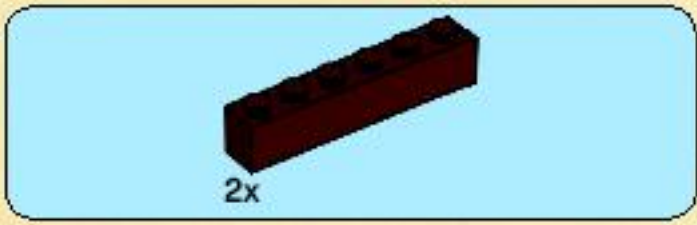

18

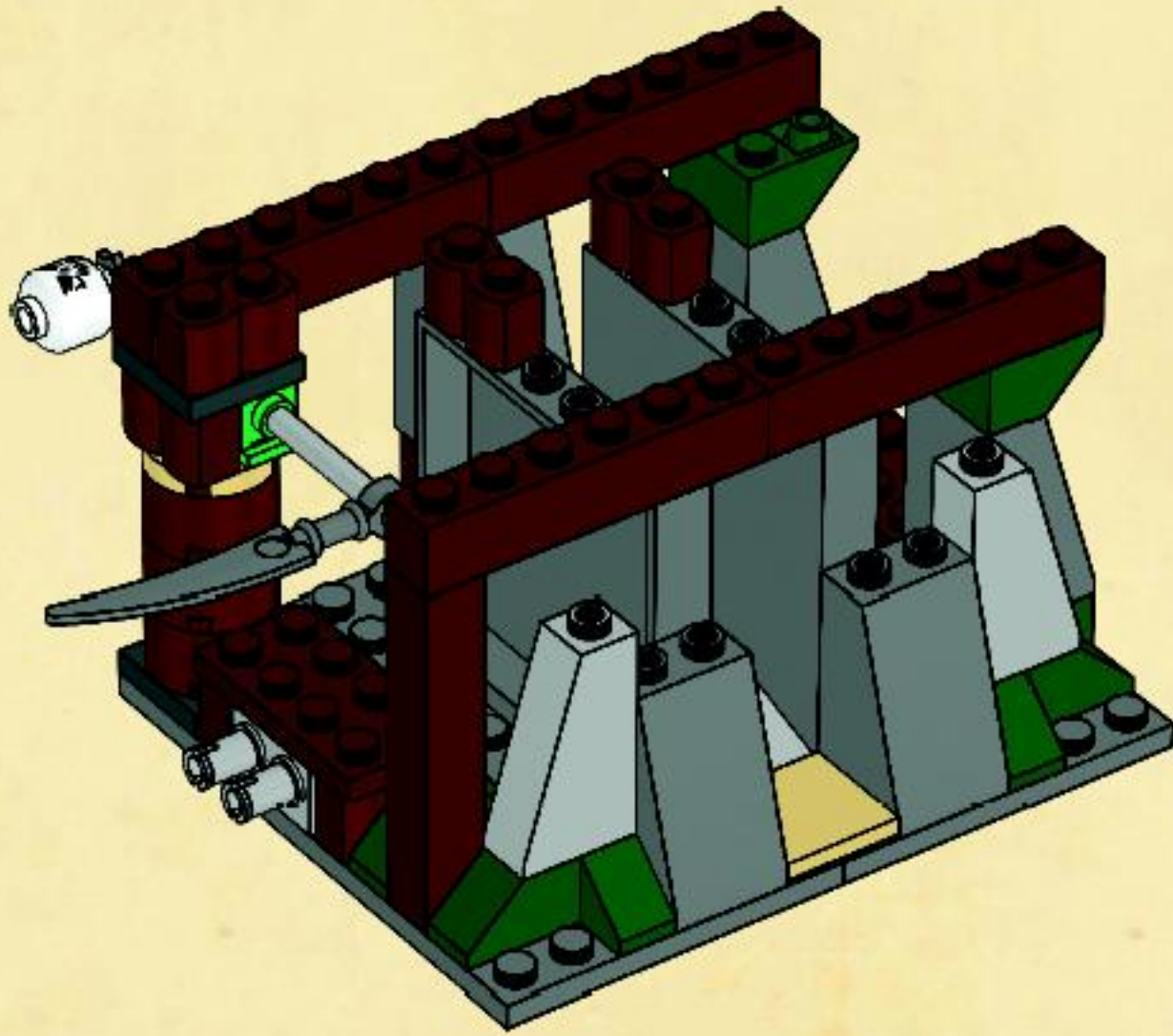

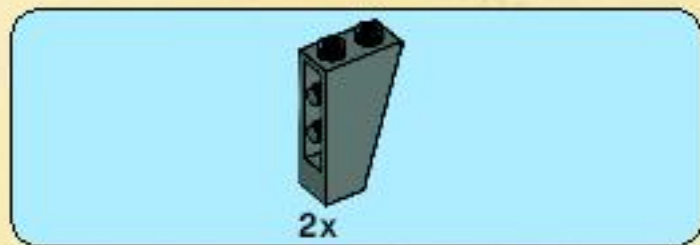

19

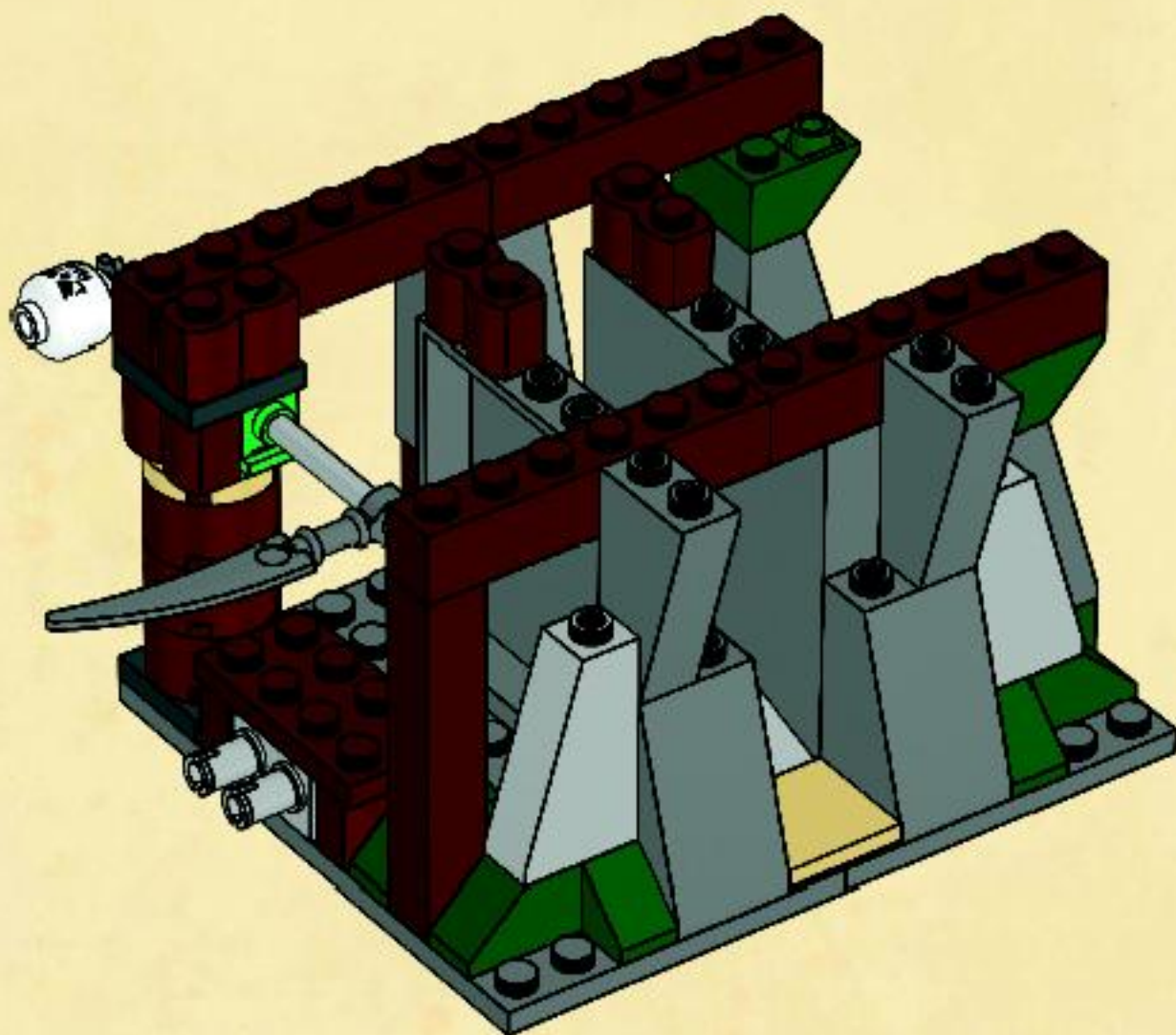

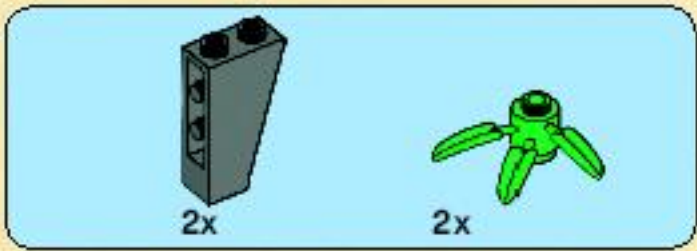

20

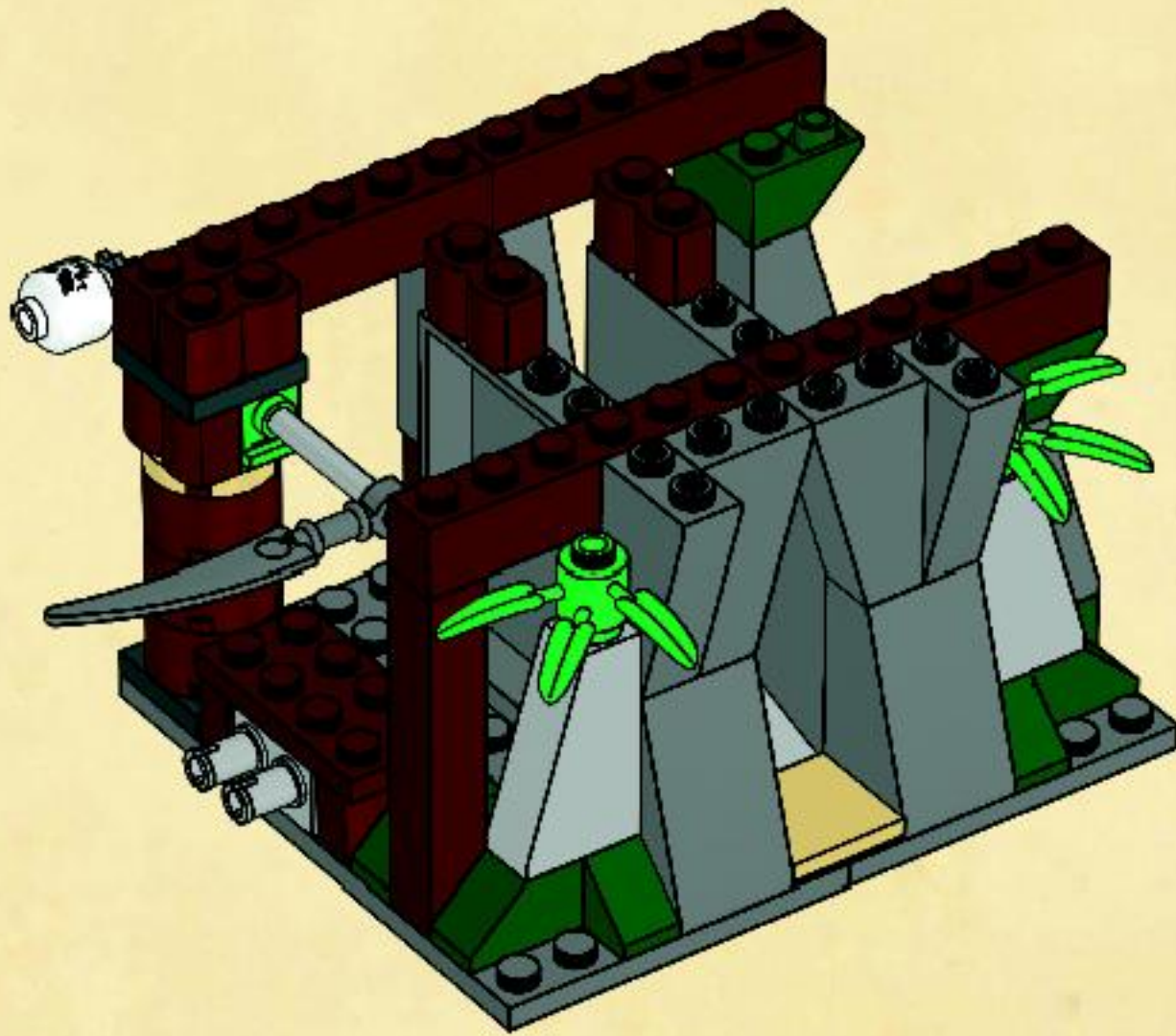

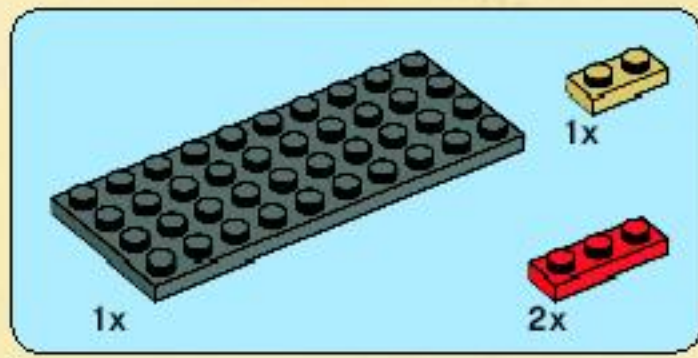

21

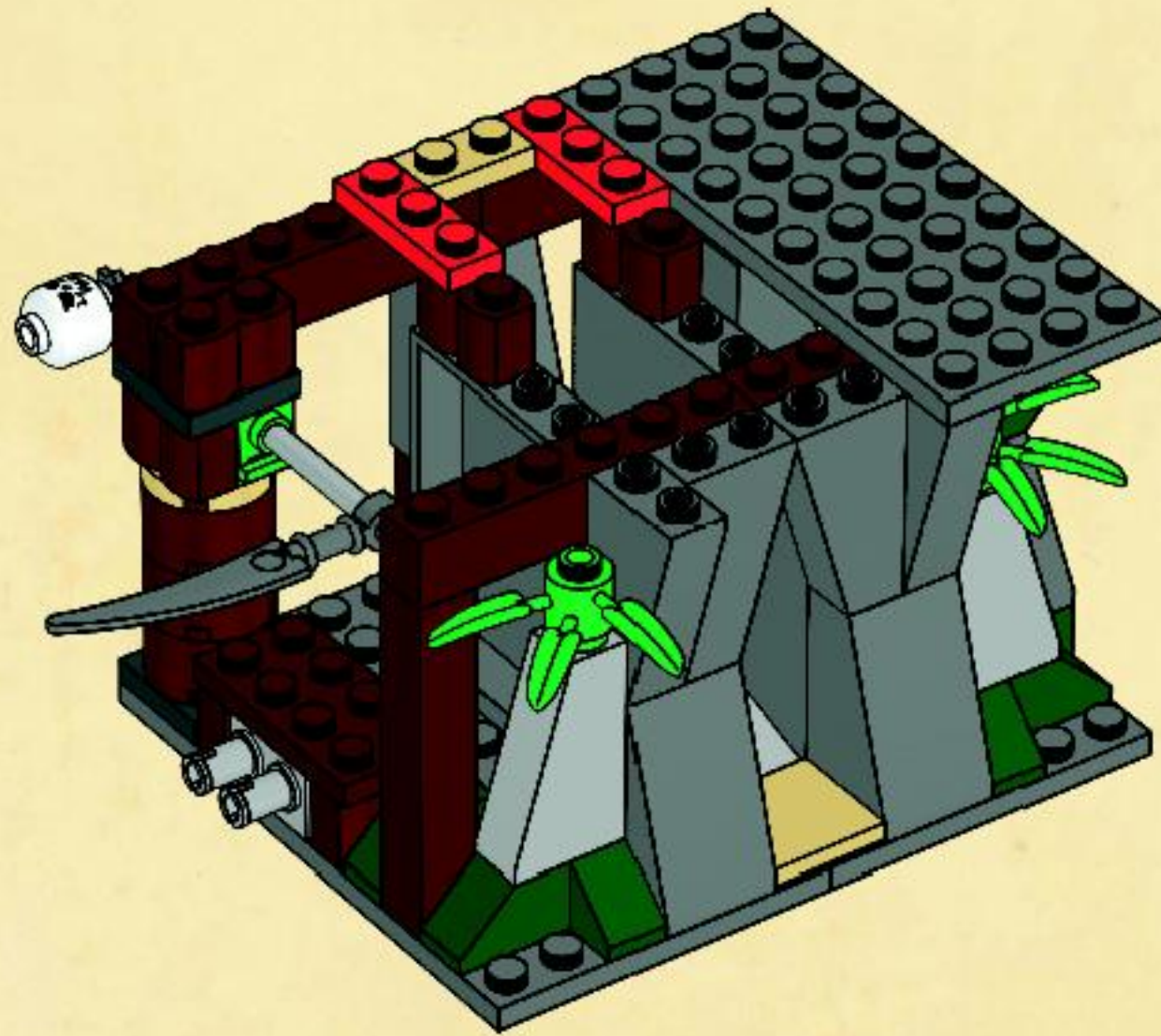

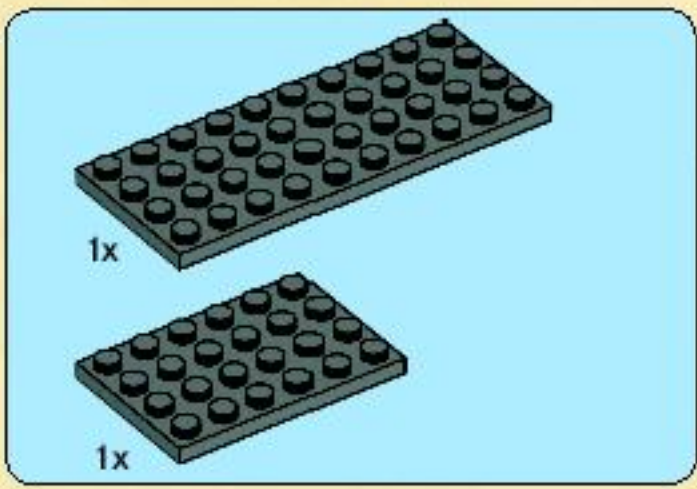

22

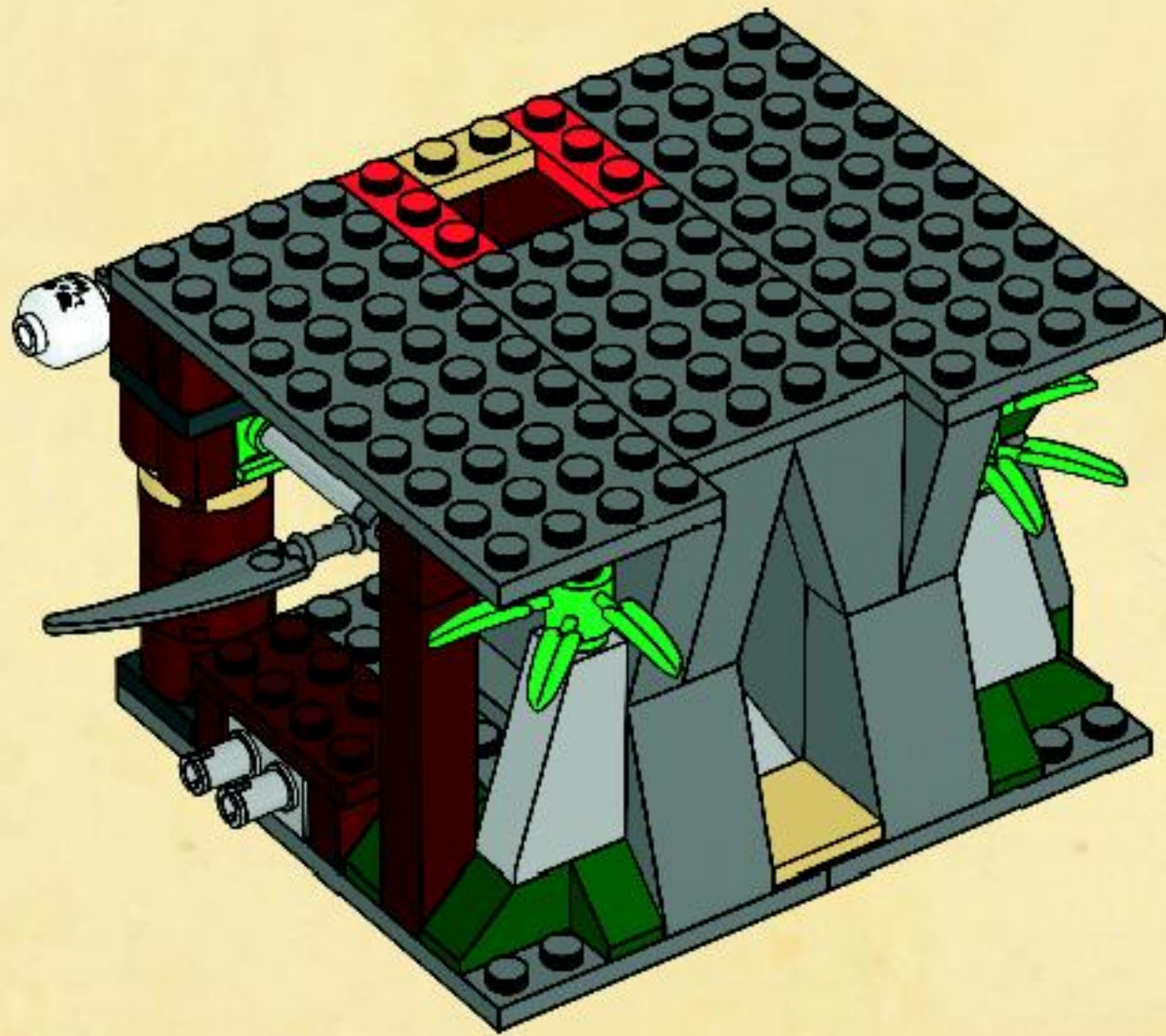

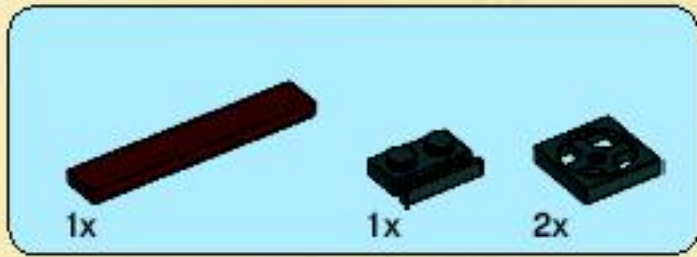

23

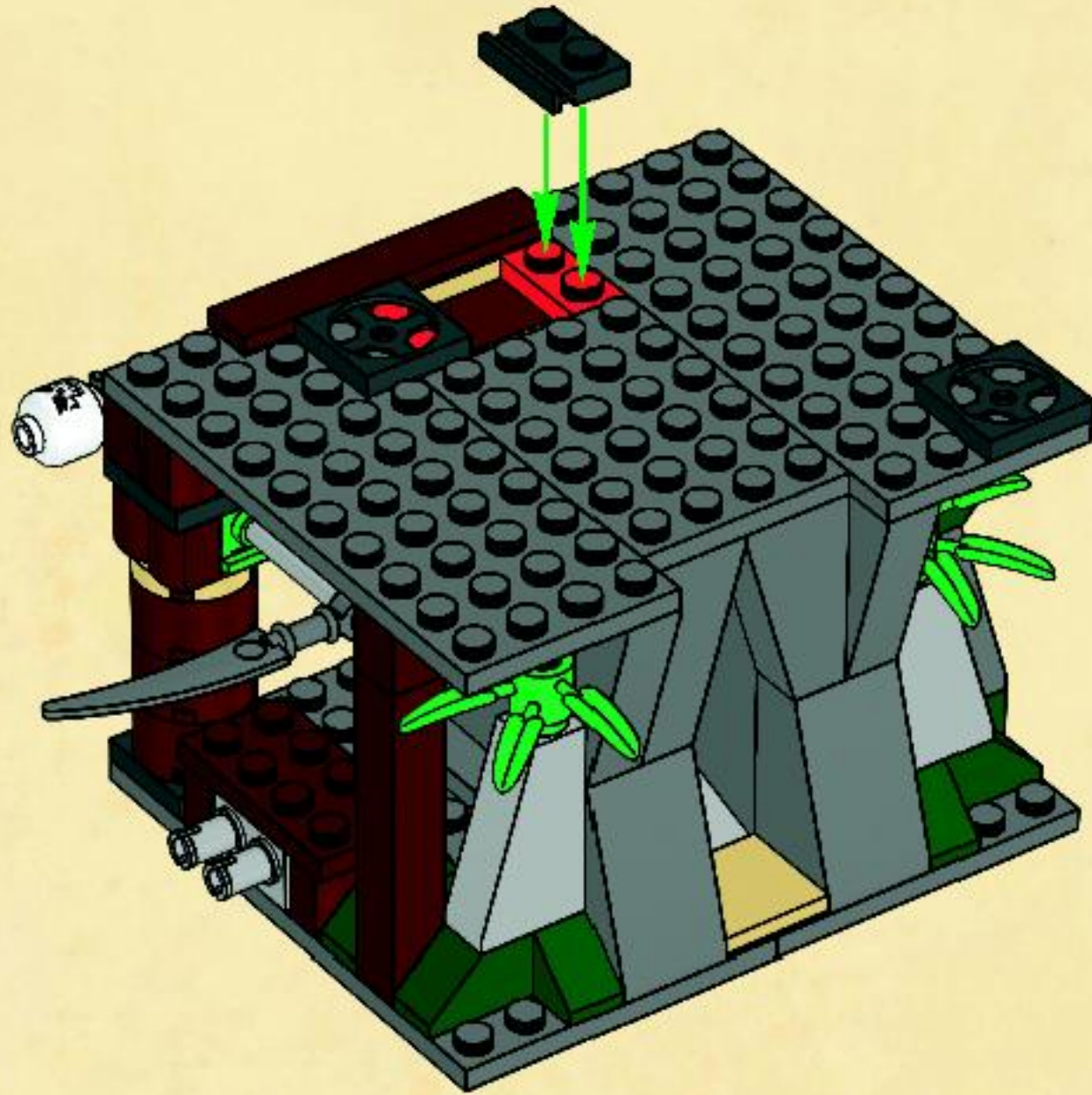



24

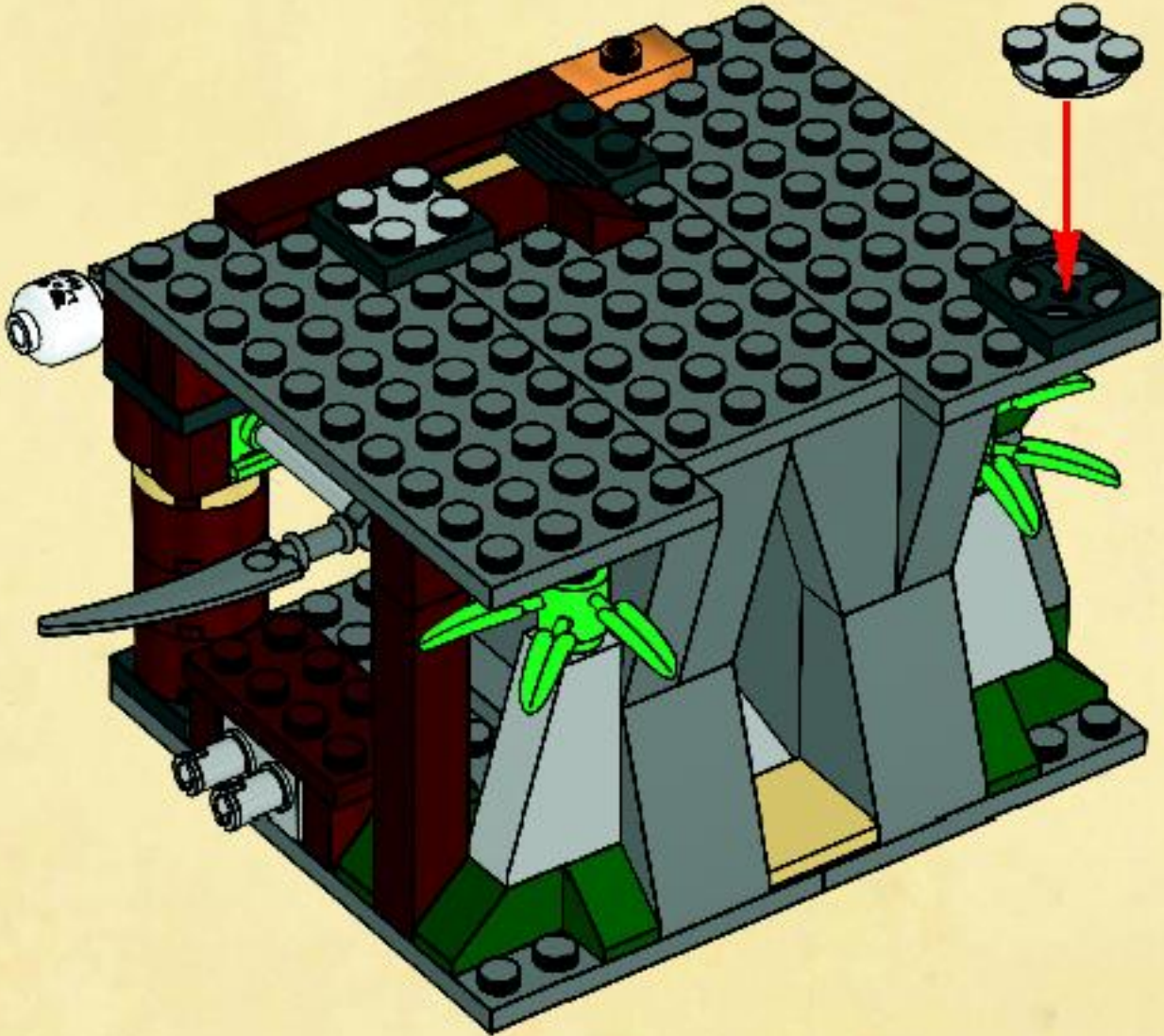

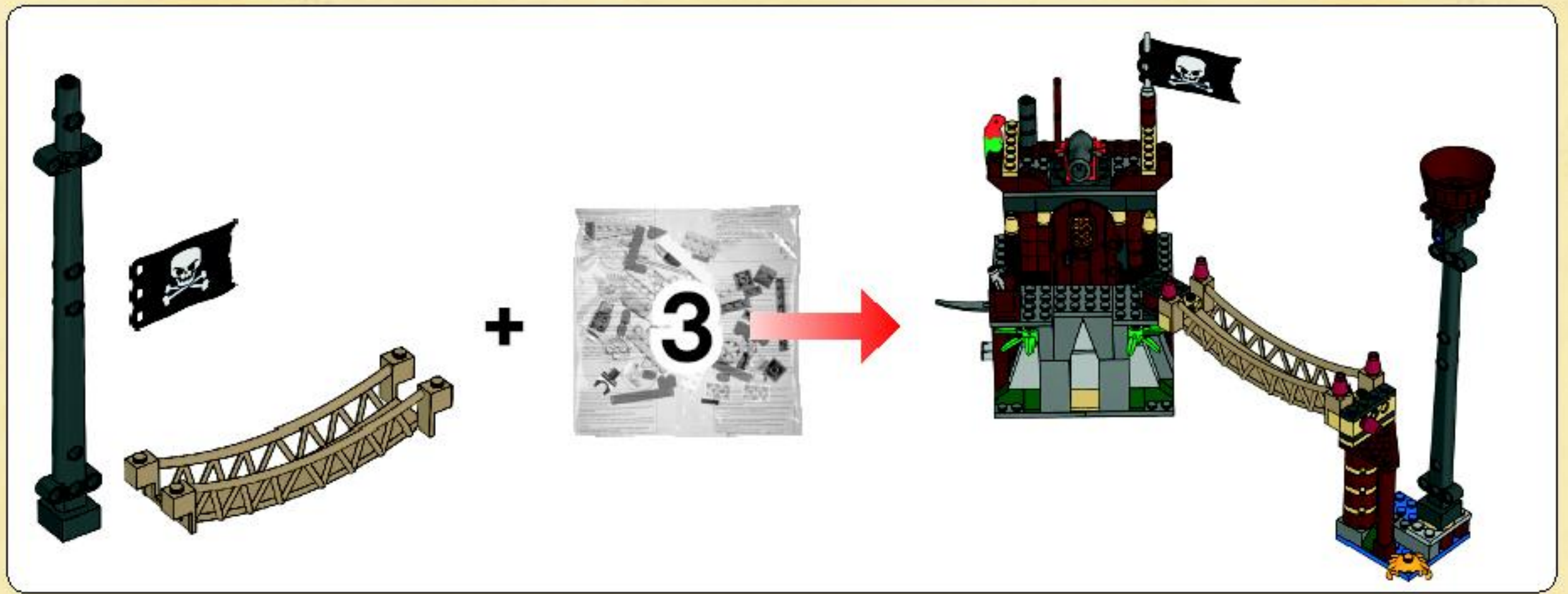

25

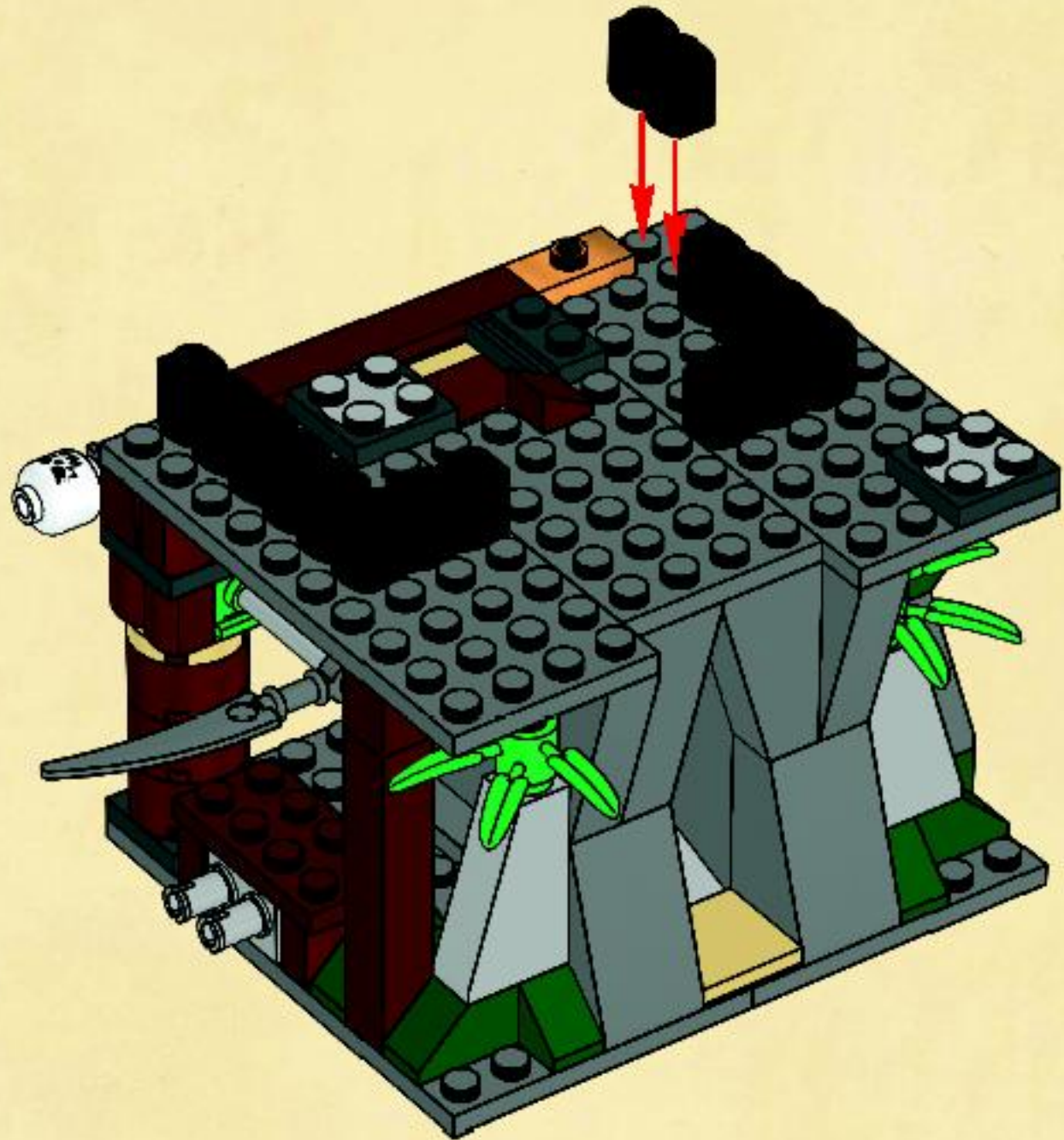

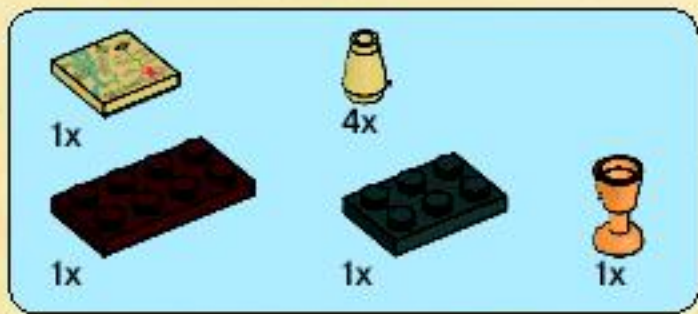

26

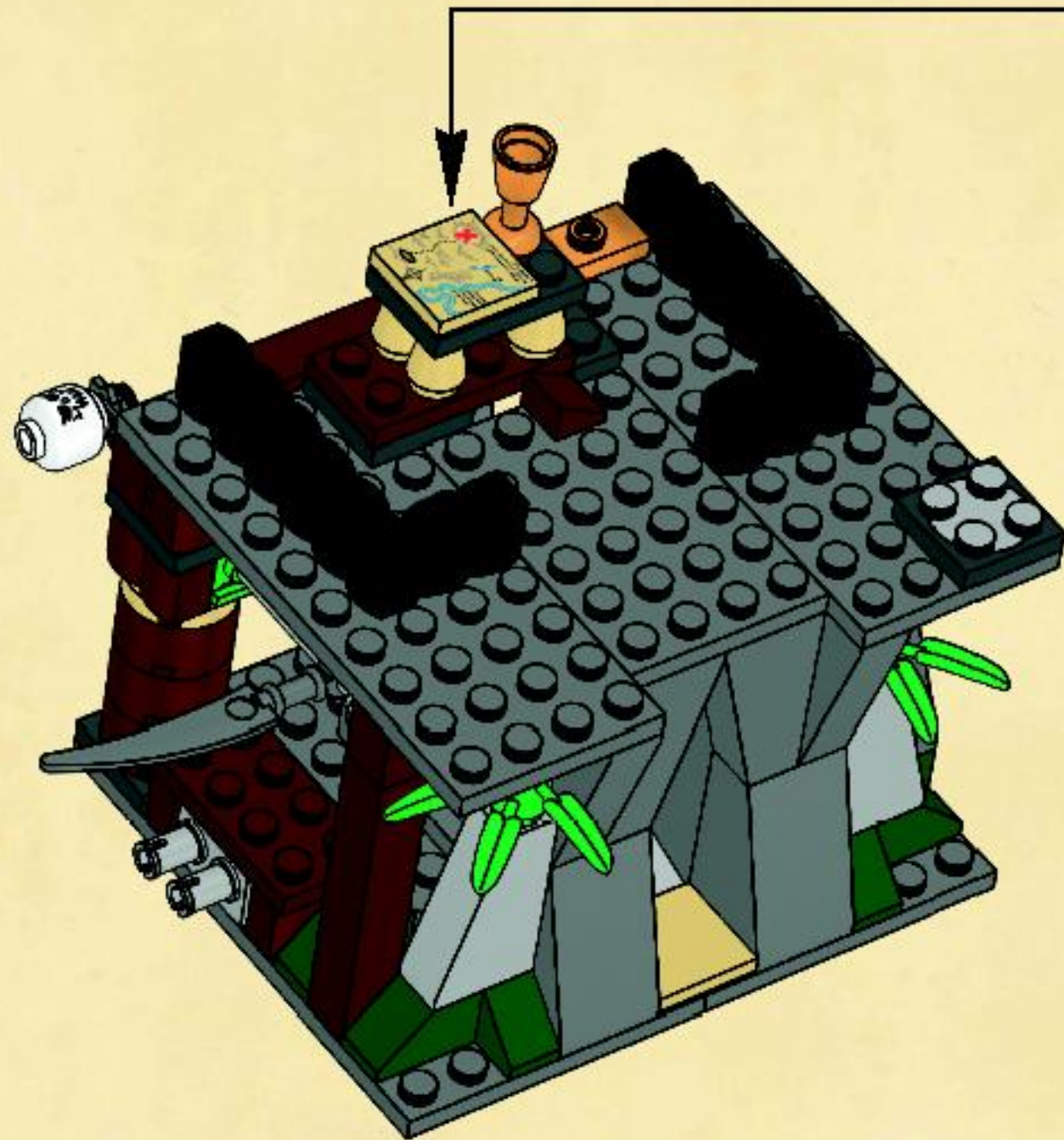
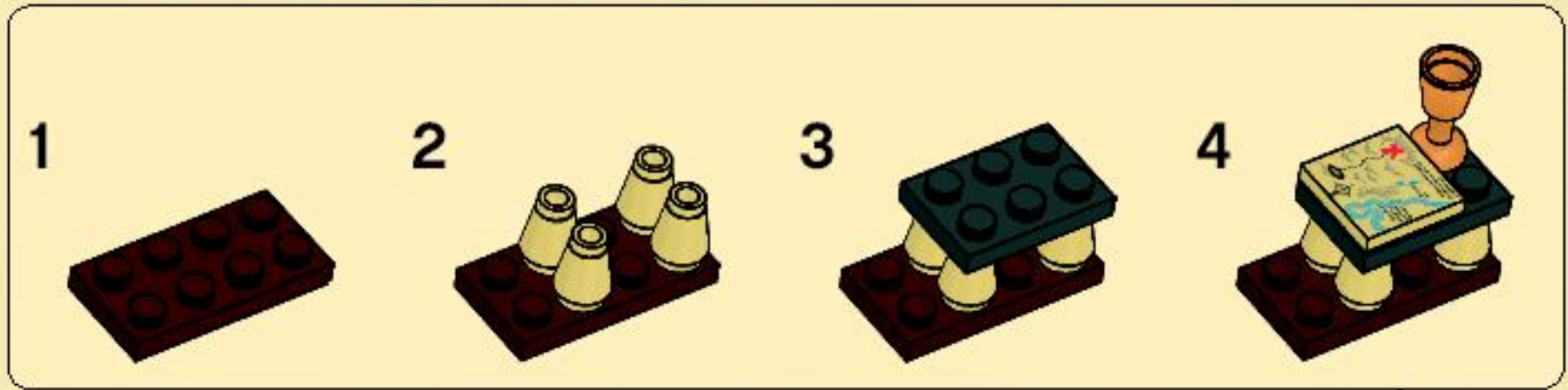

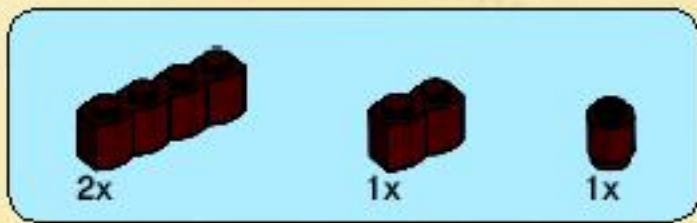

27

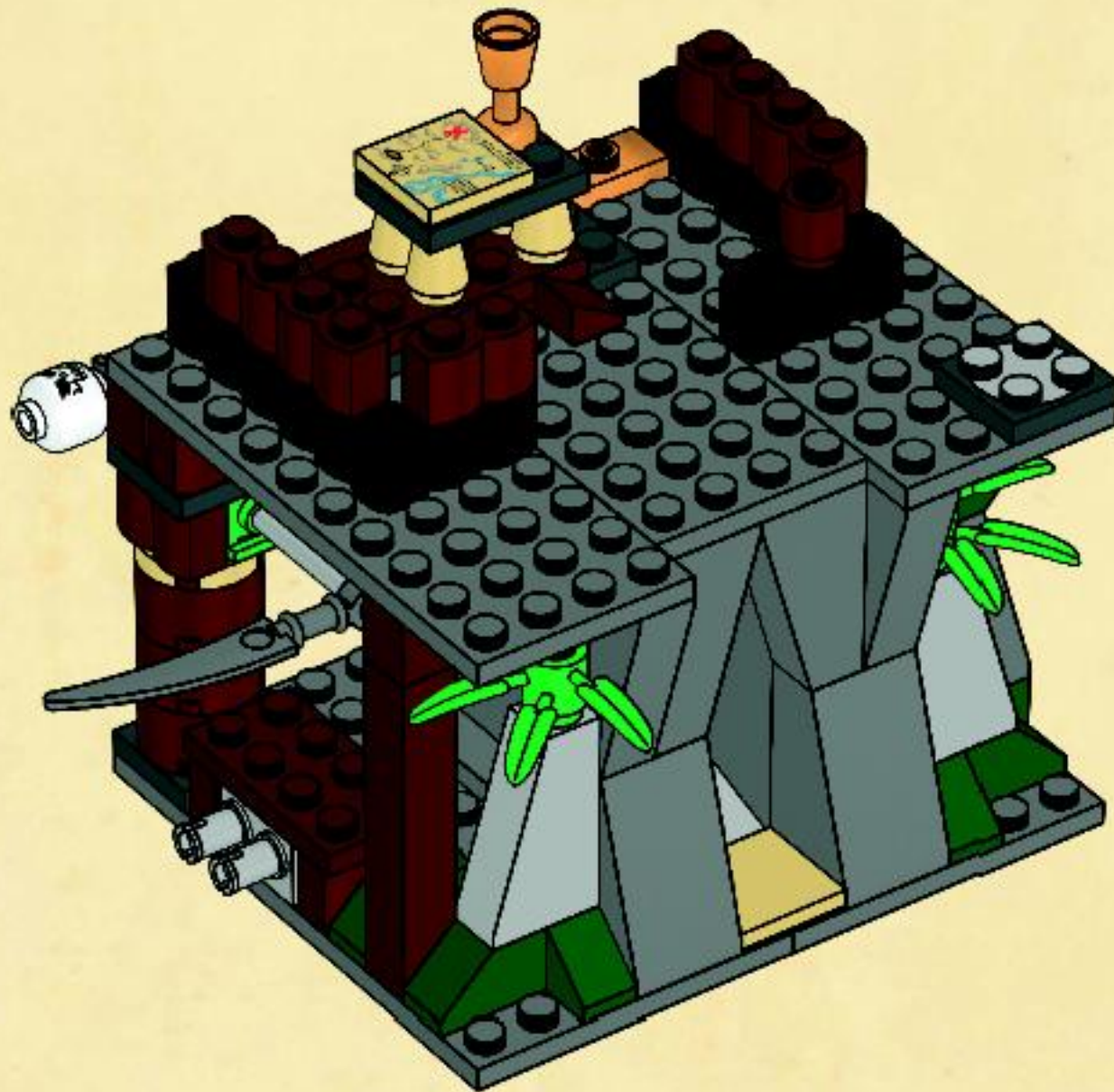

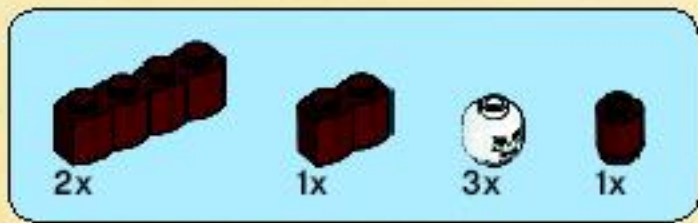

28

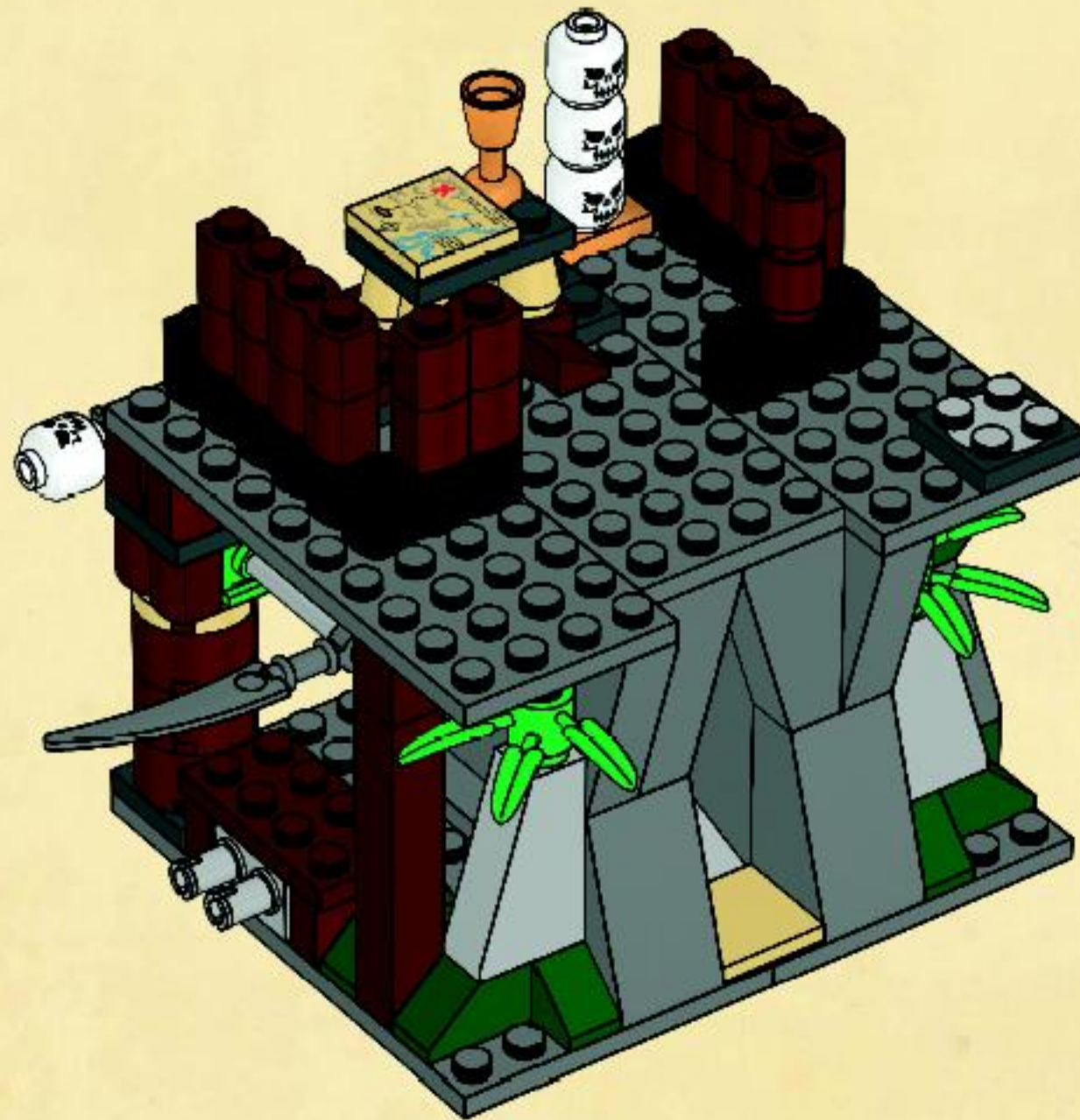



4x

29

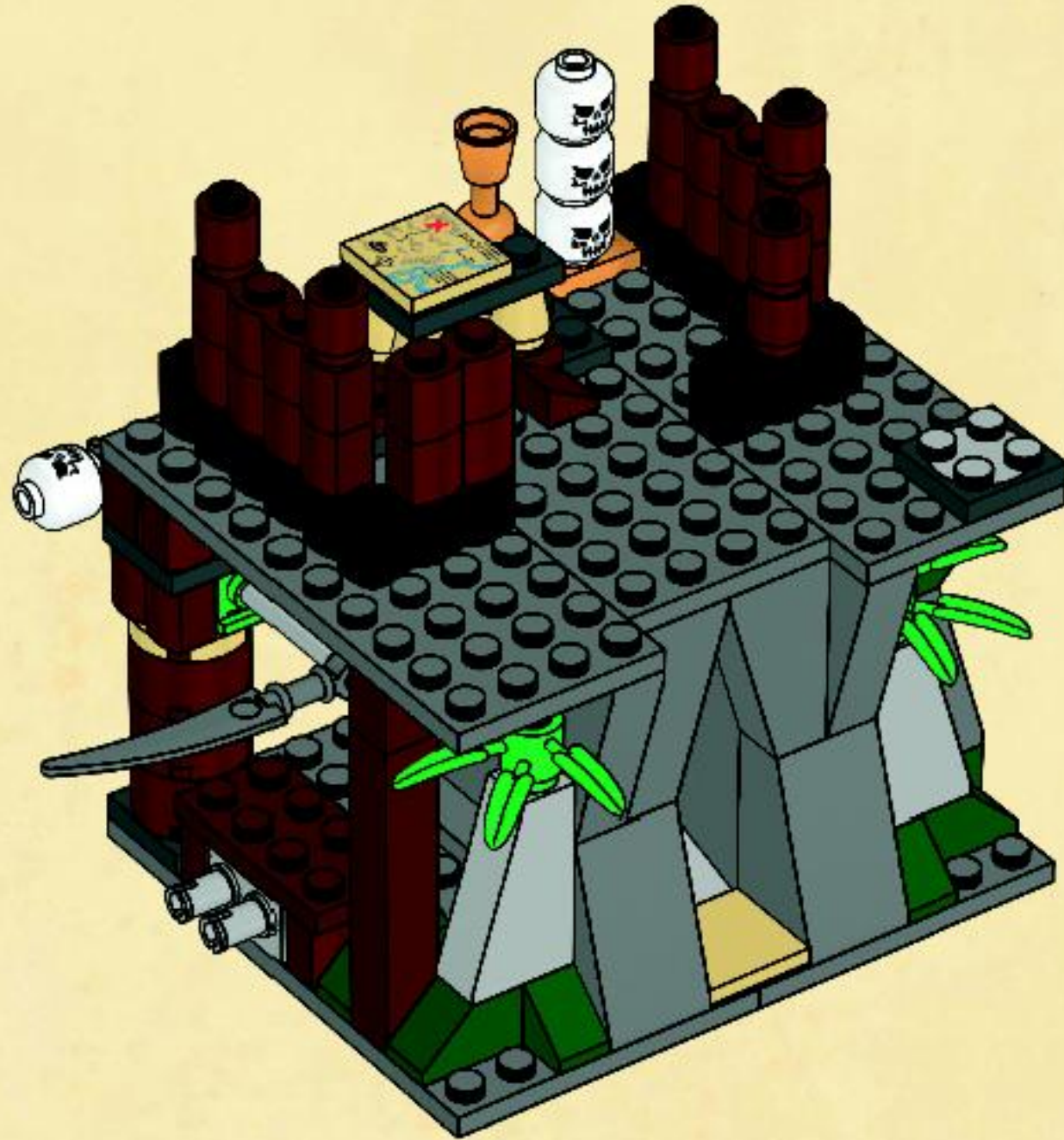

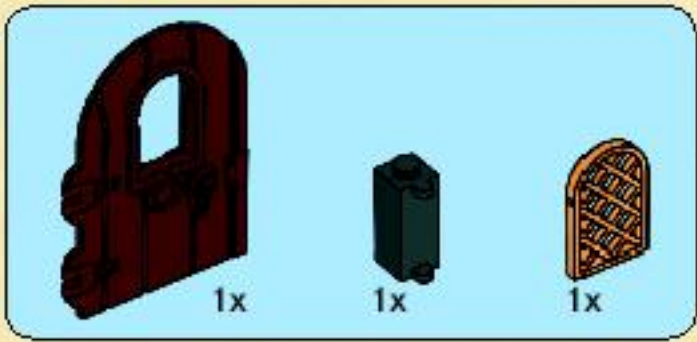

30

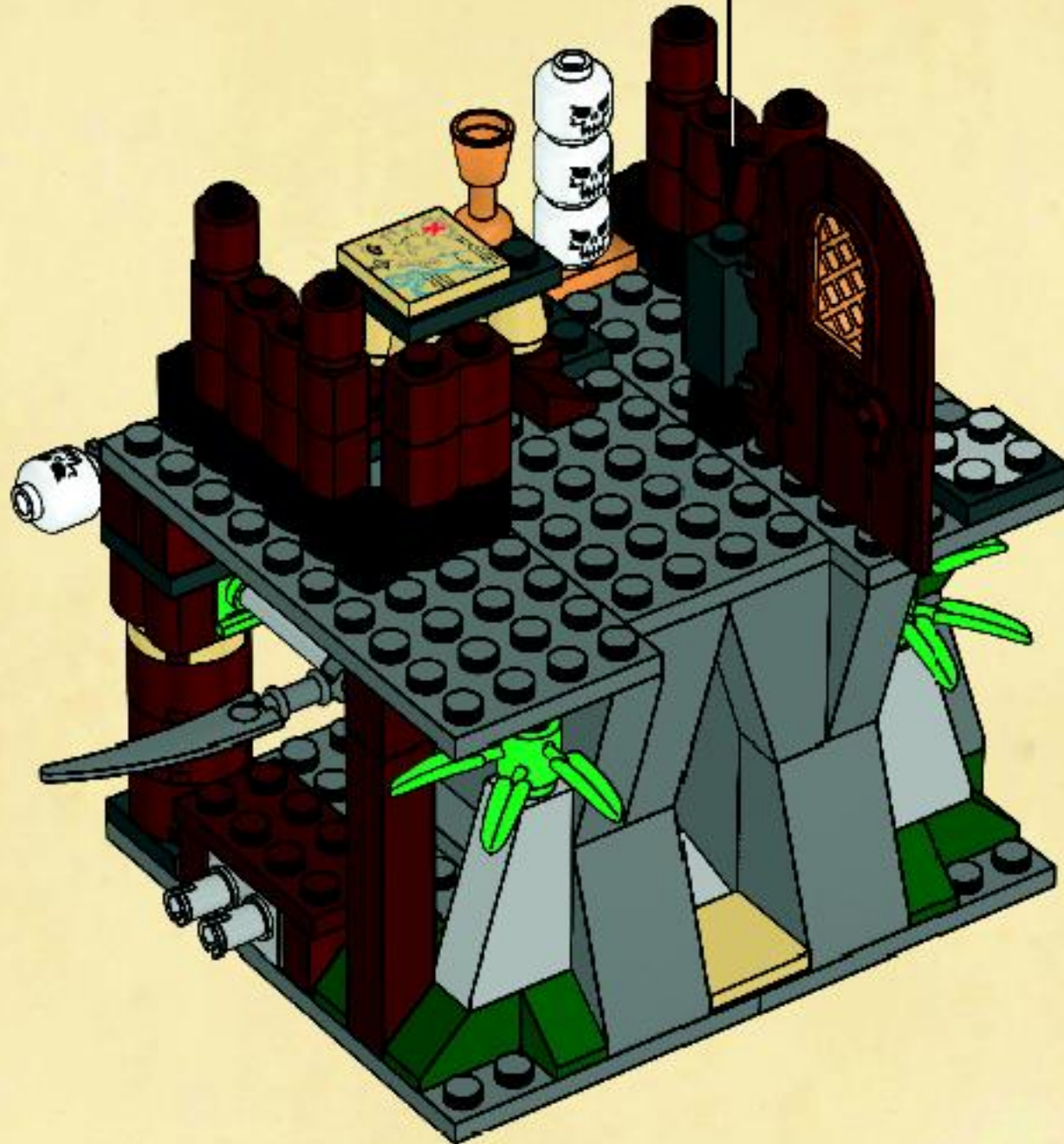
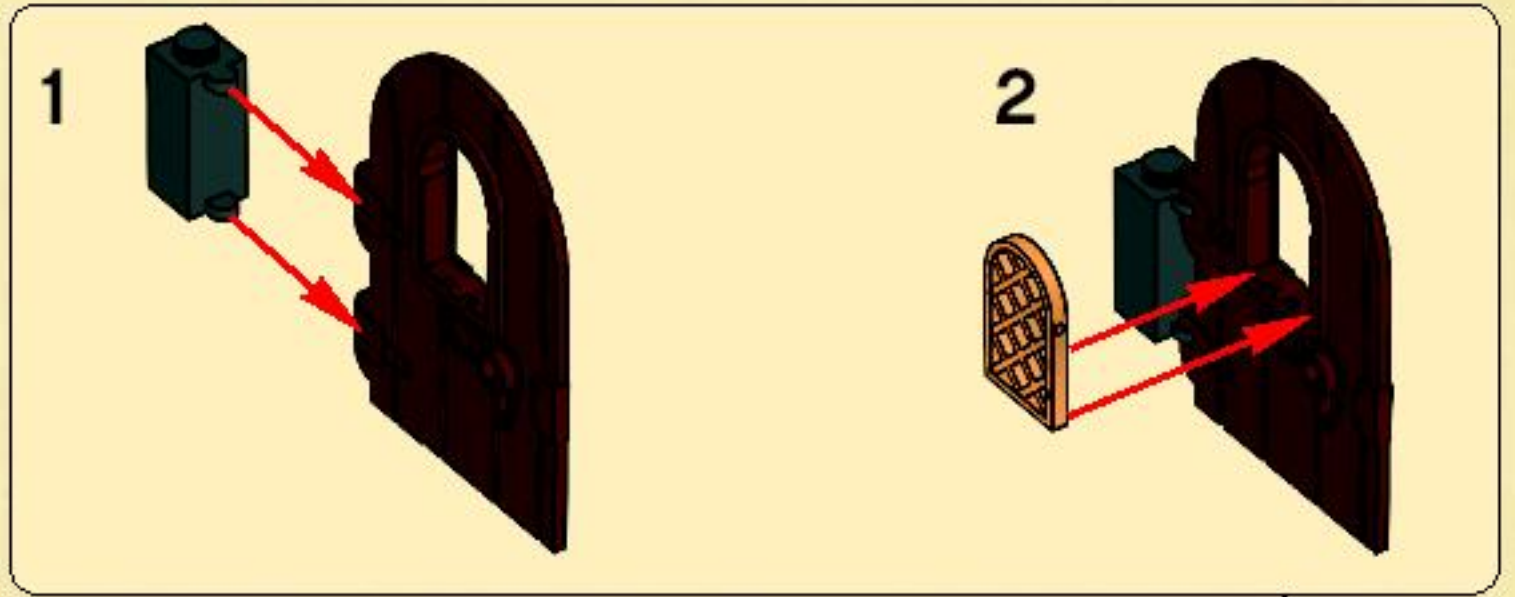



2x

31

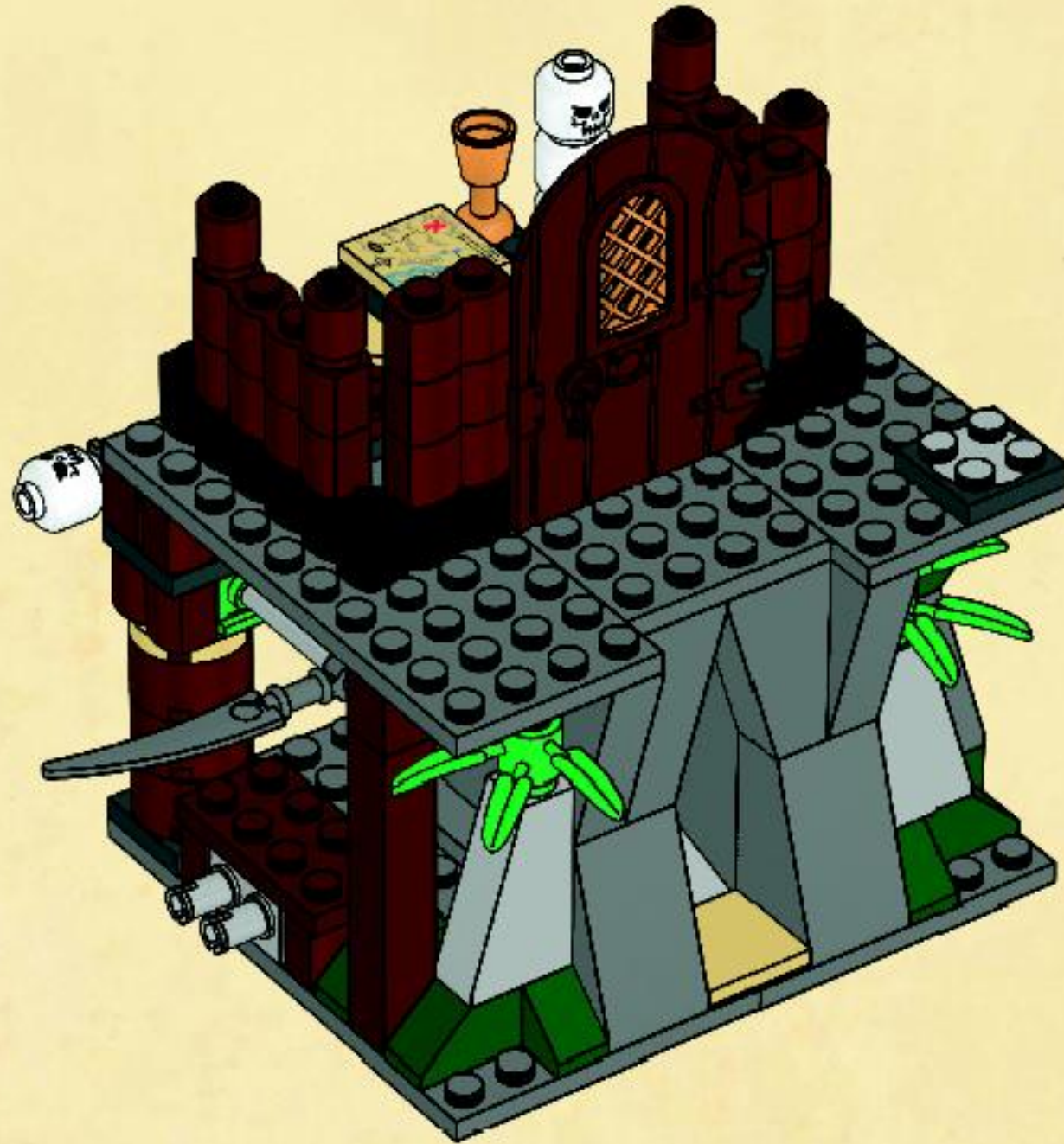

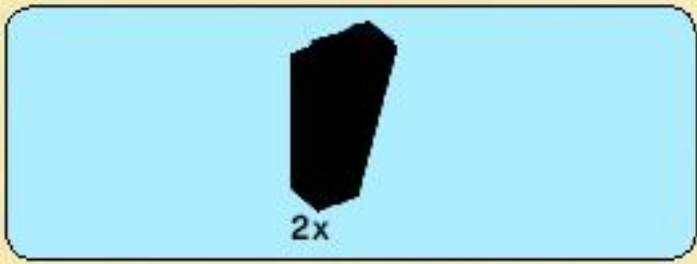

32

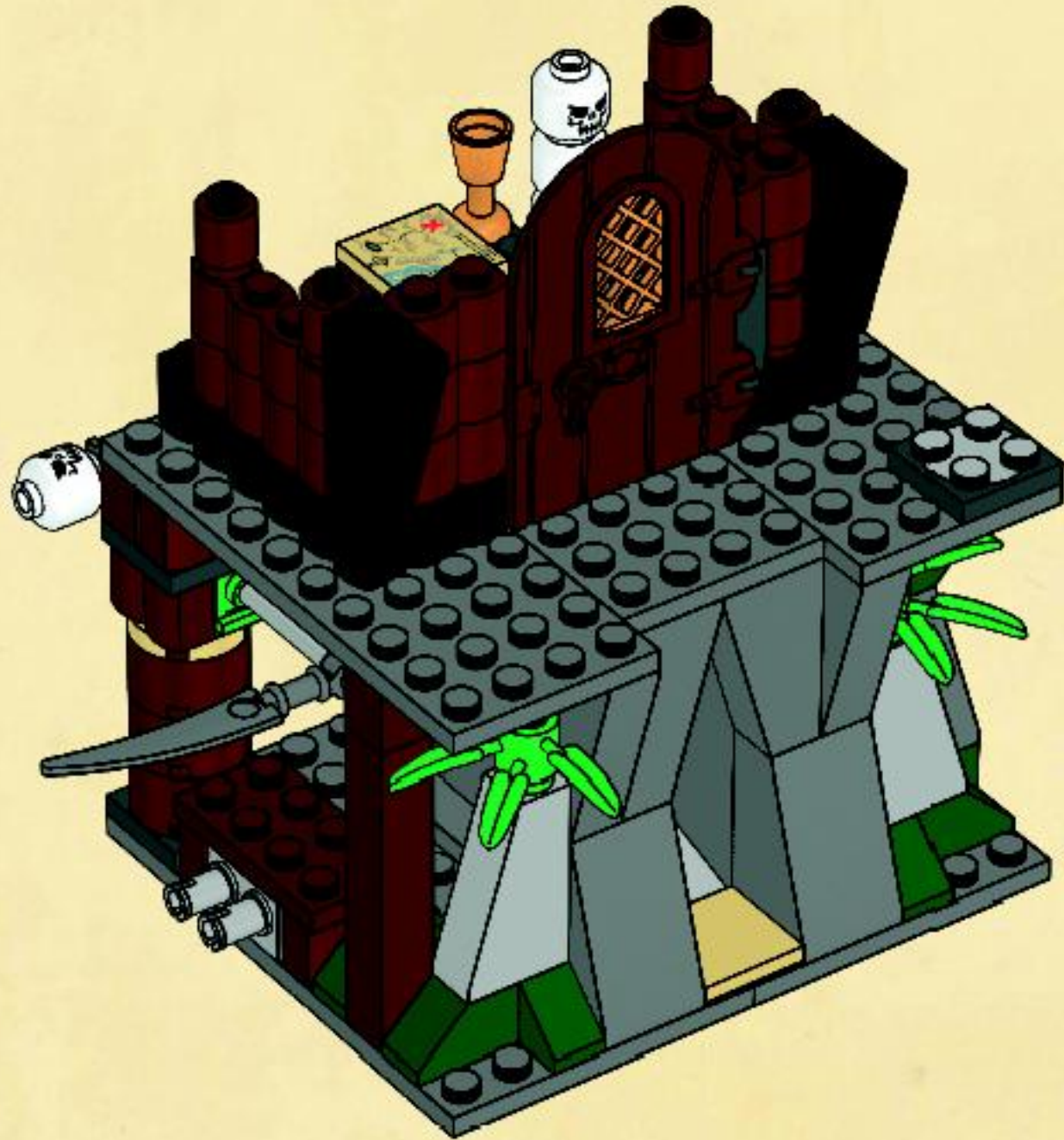



4x

33

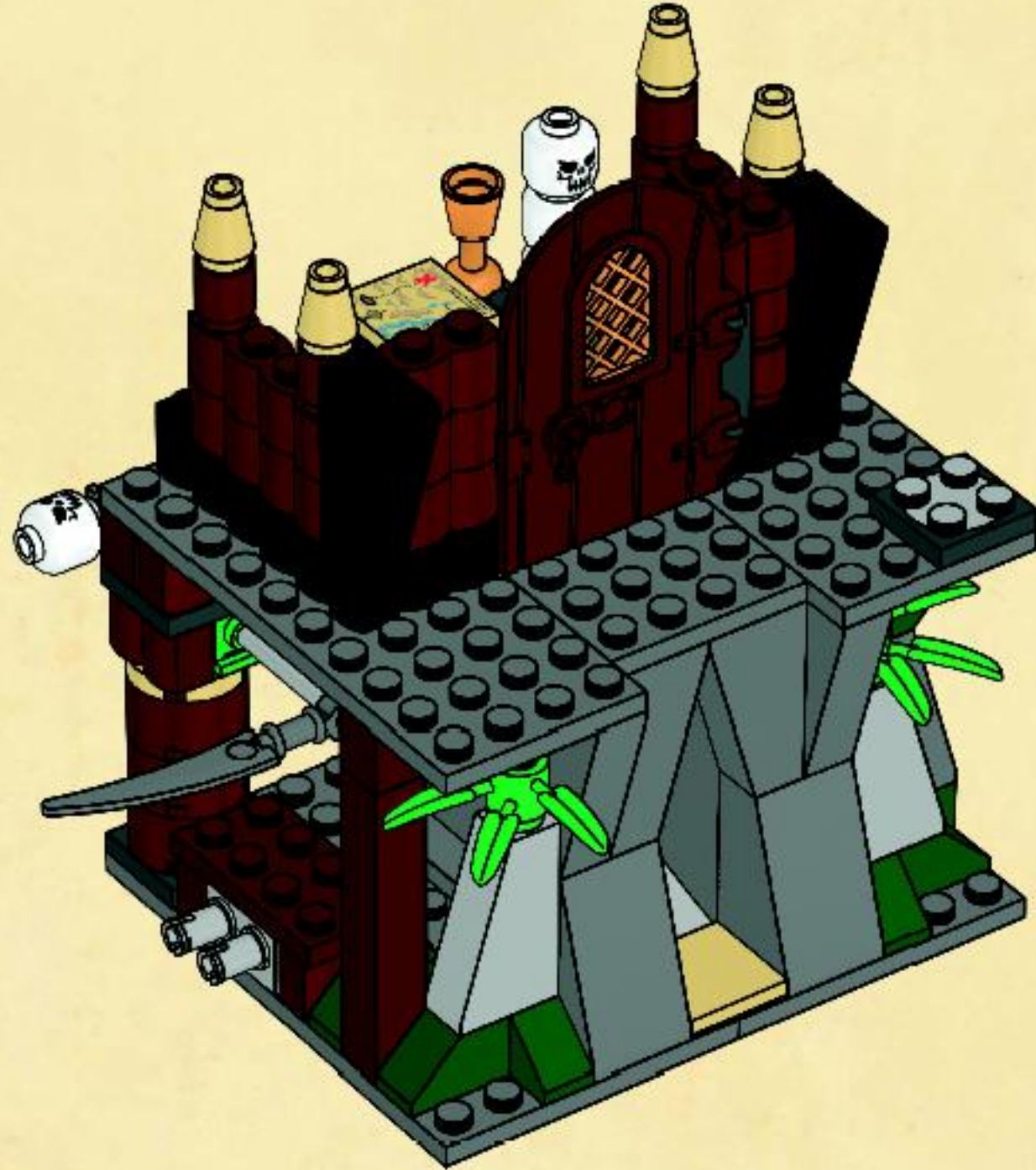



2x



2x

34

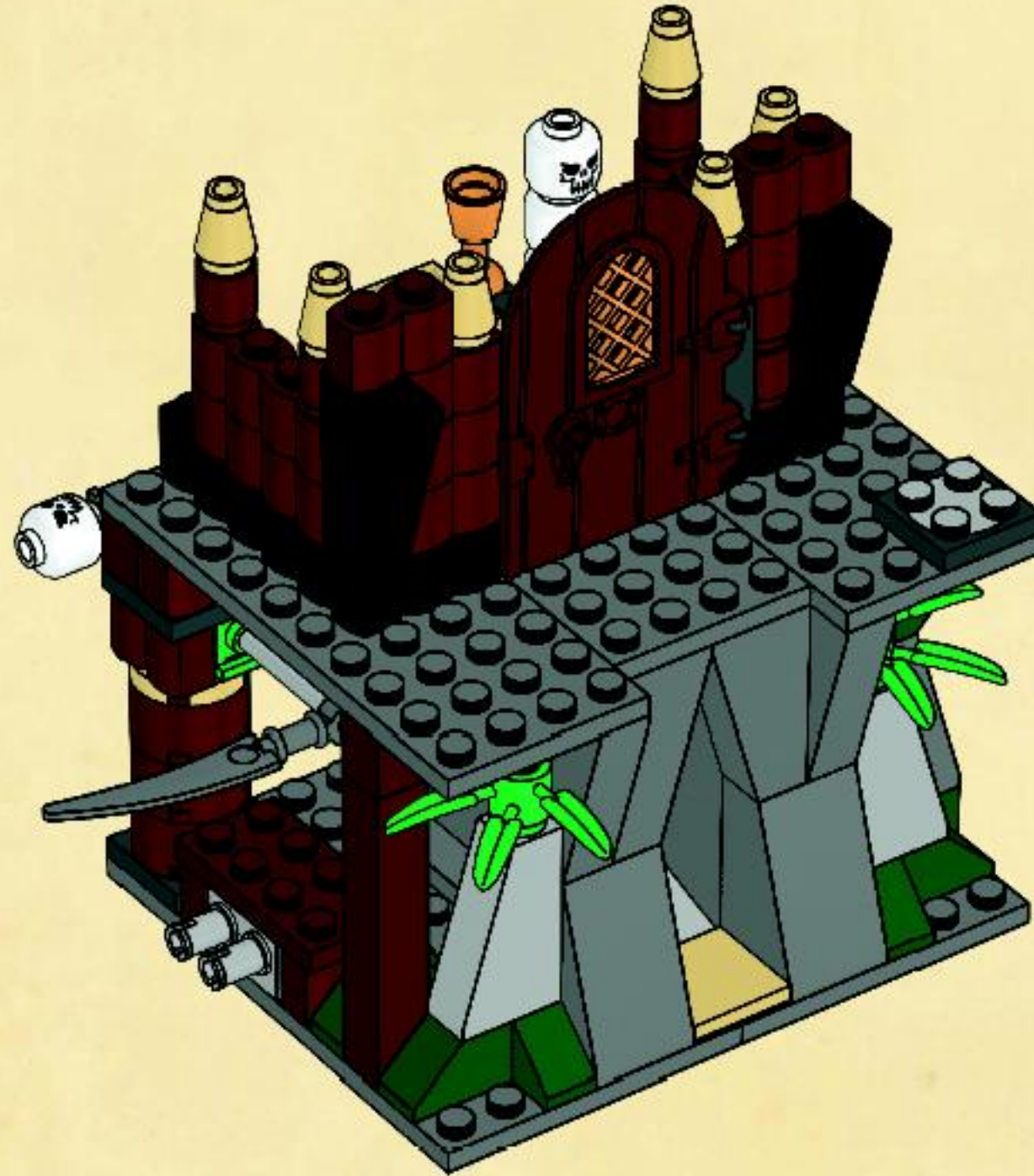



35

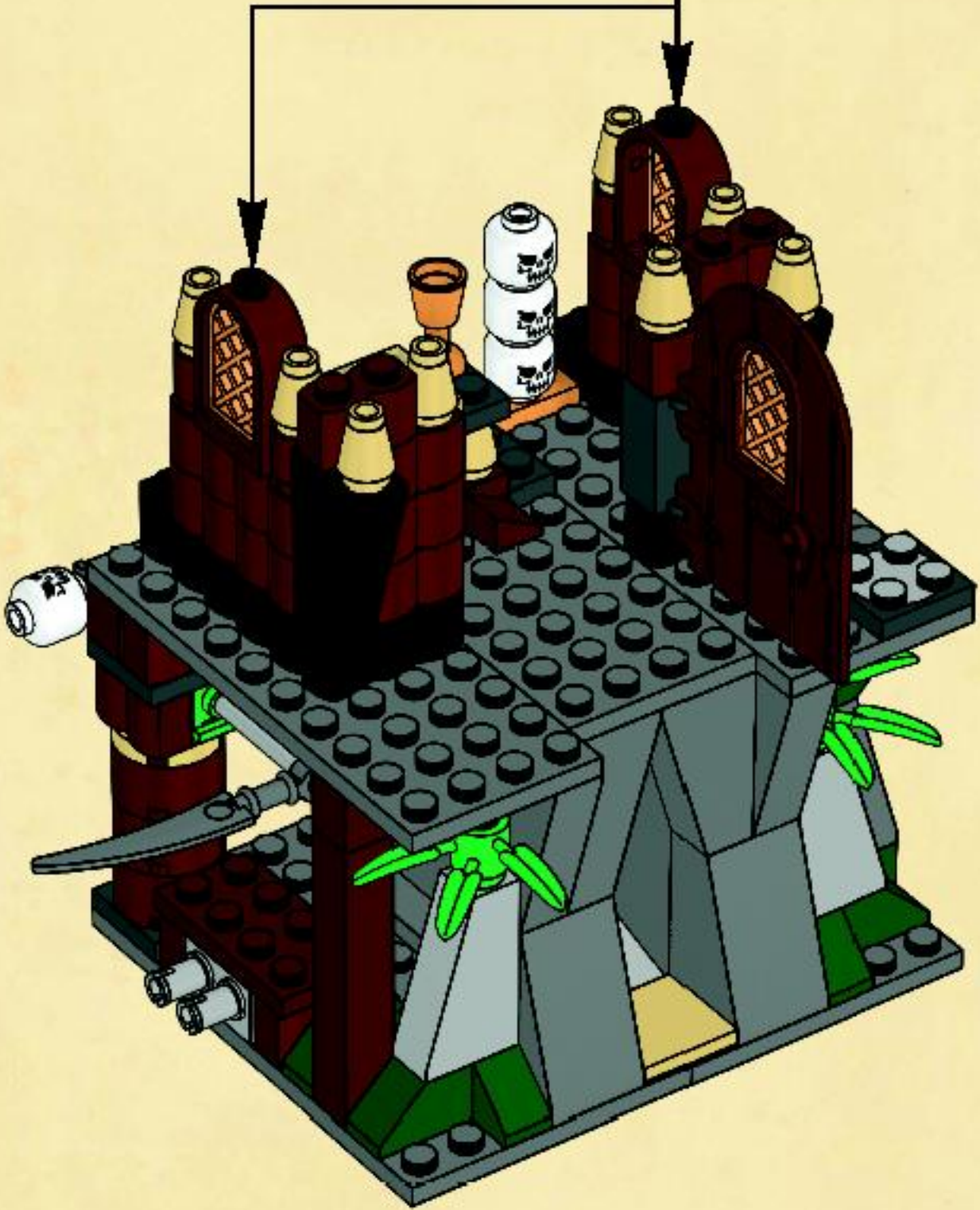
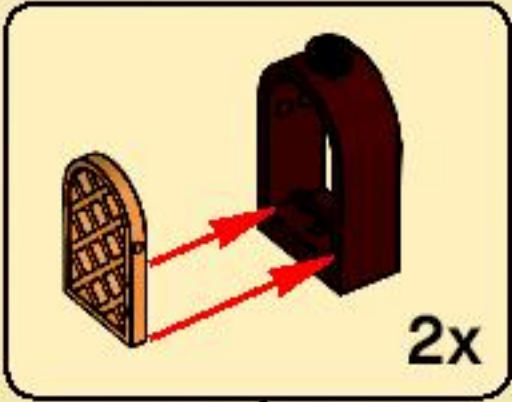



36

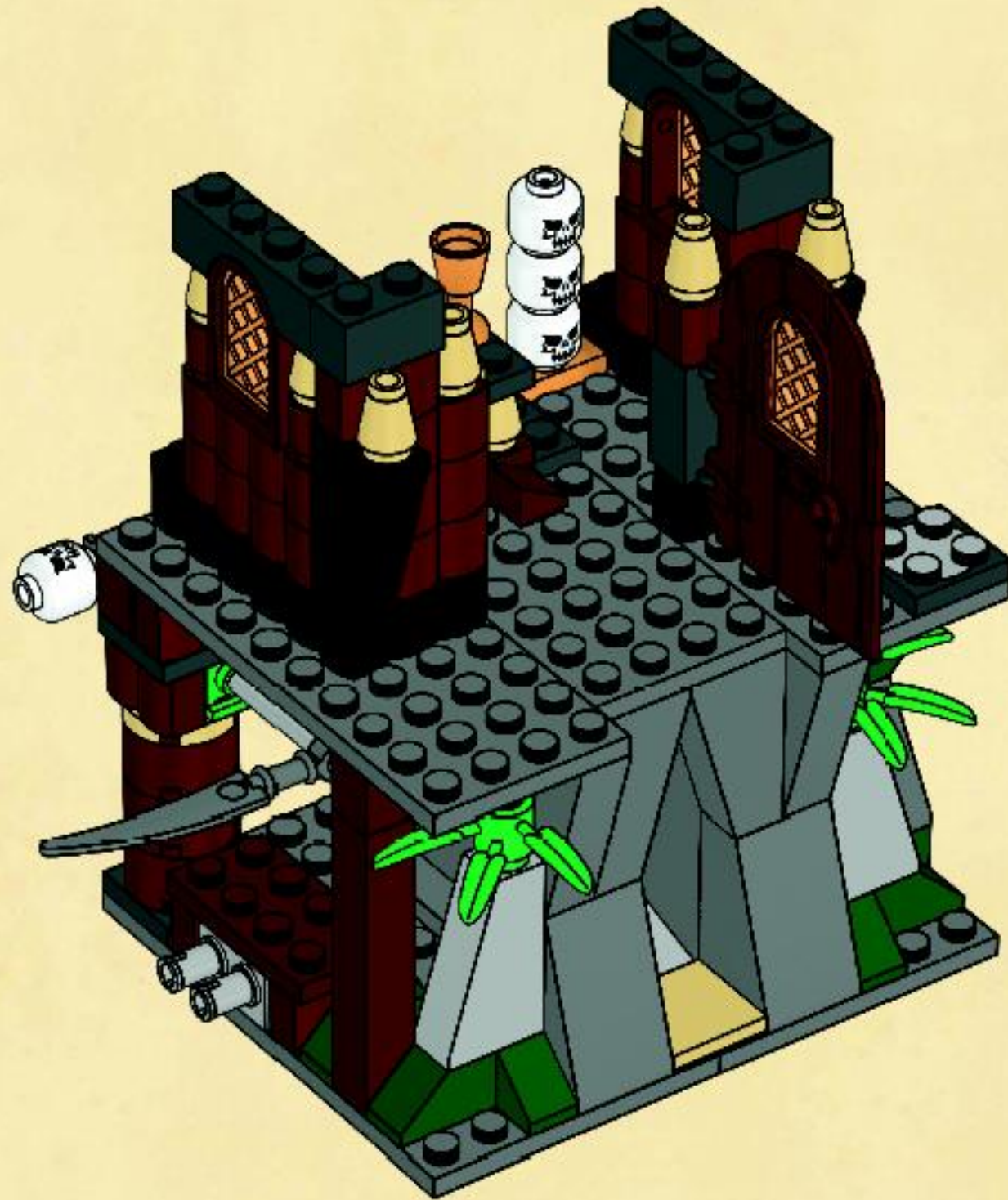

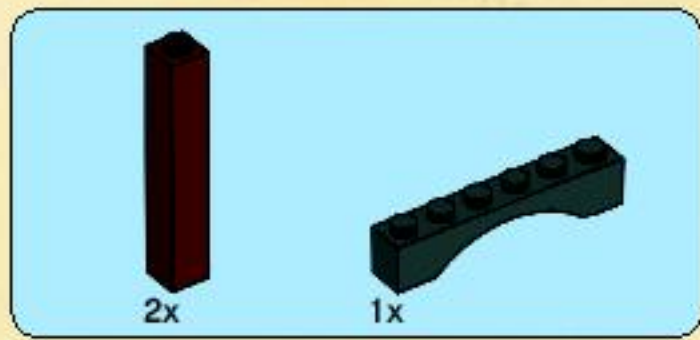

37

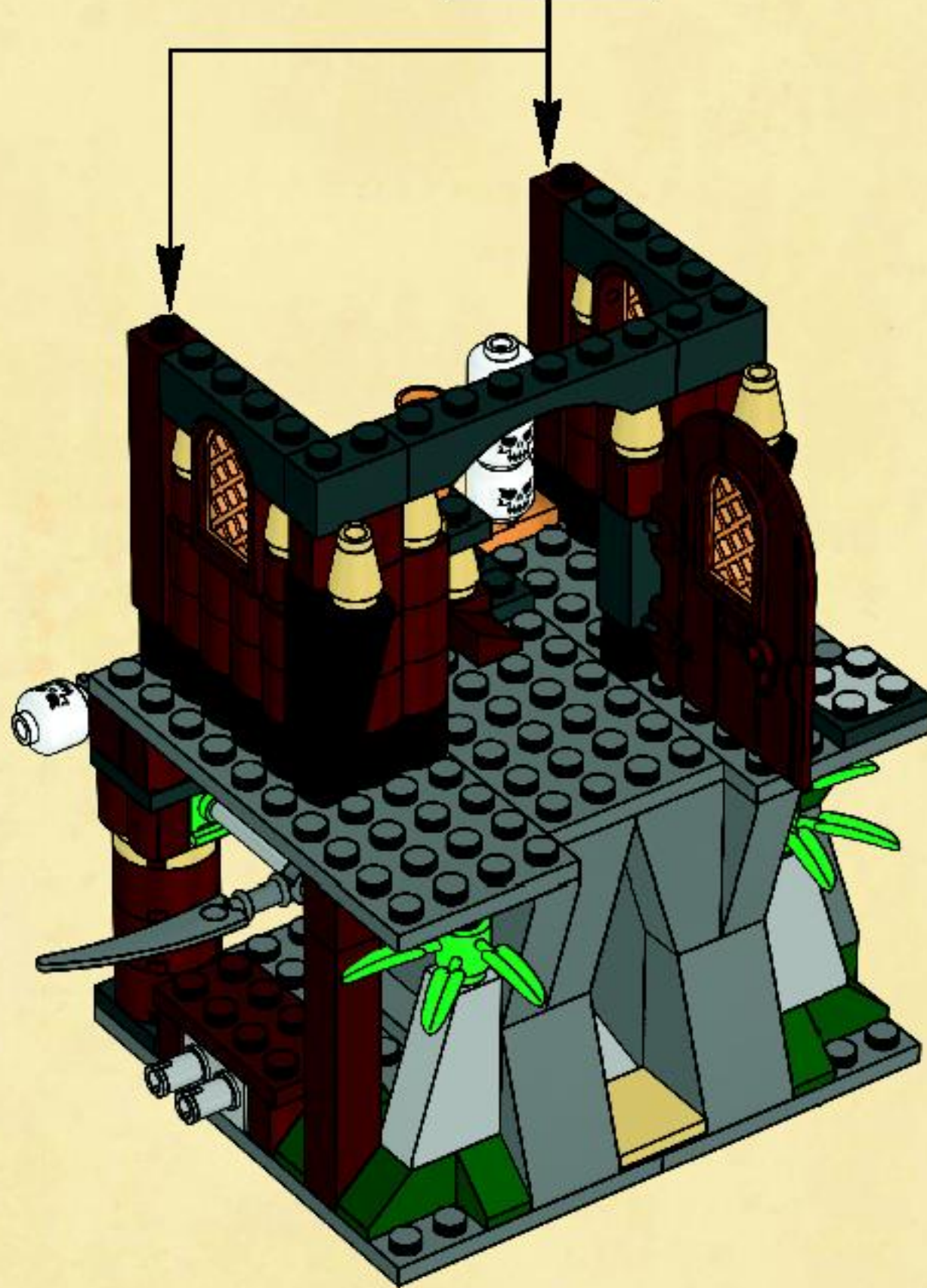
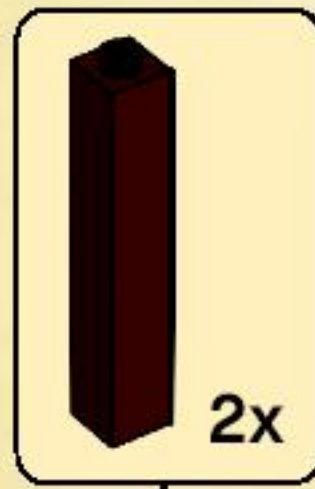

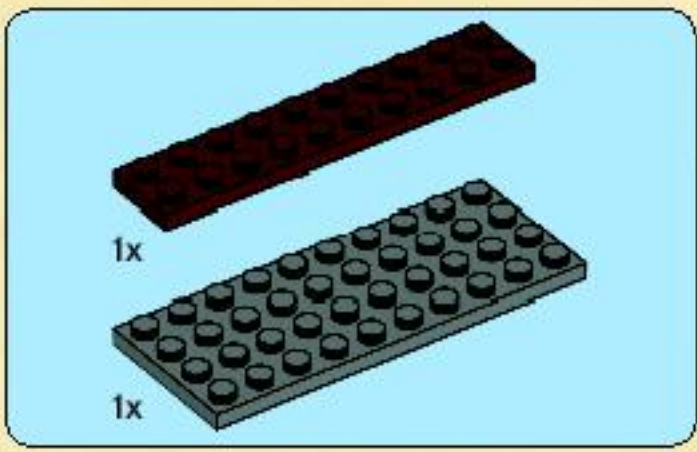

38

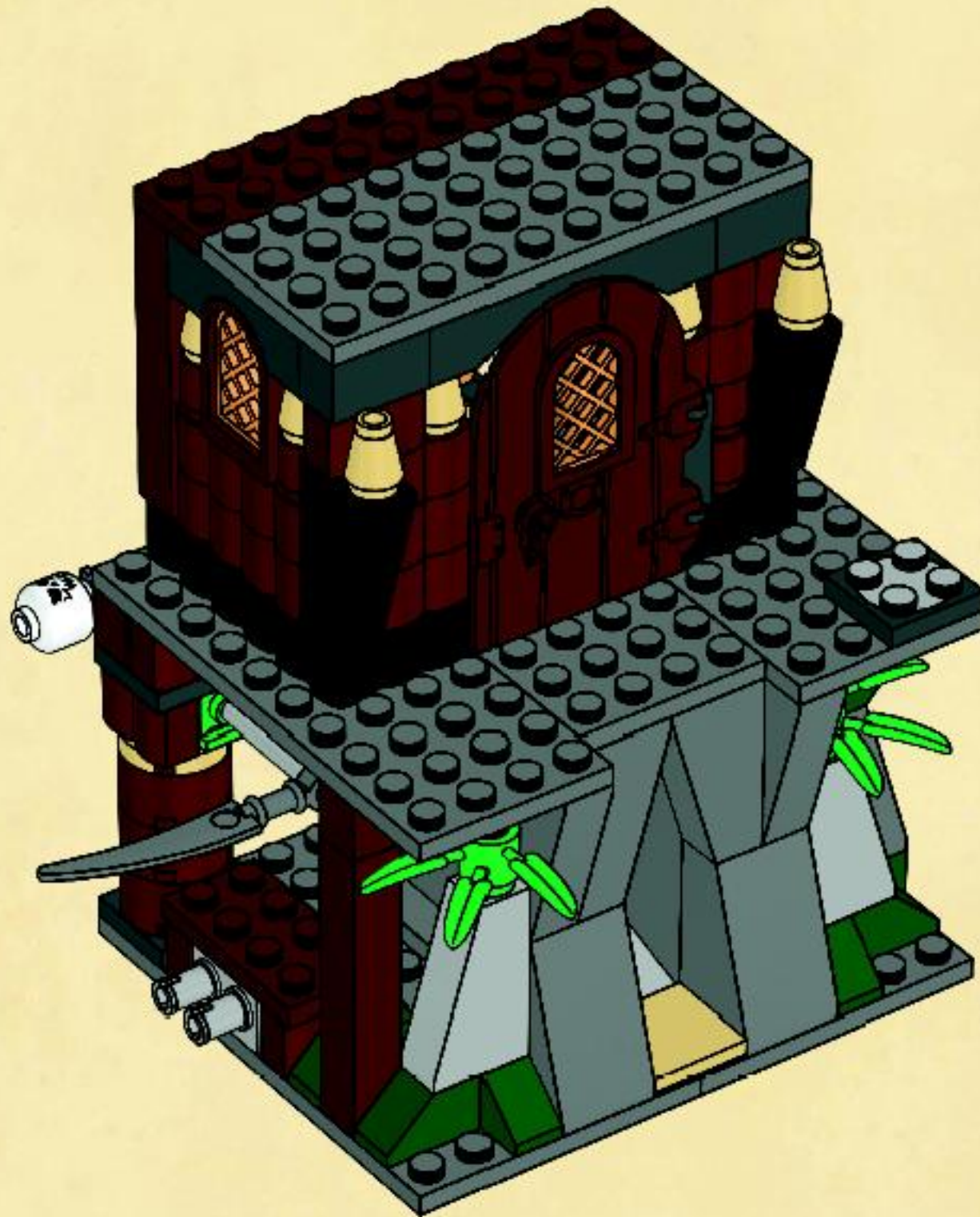



39

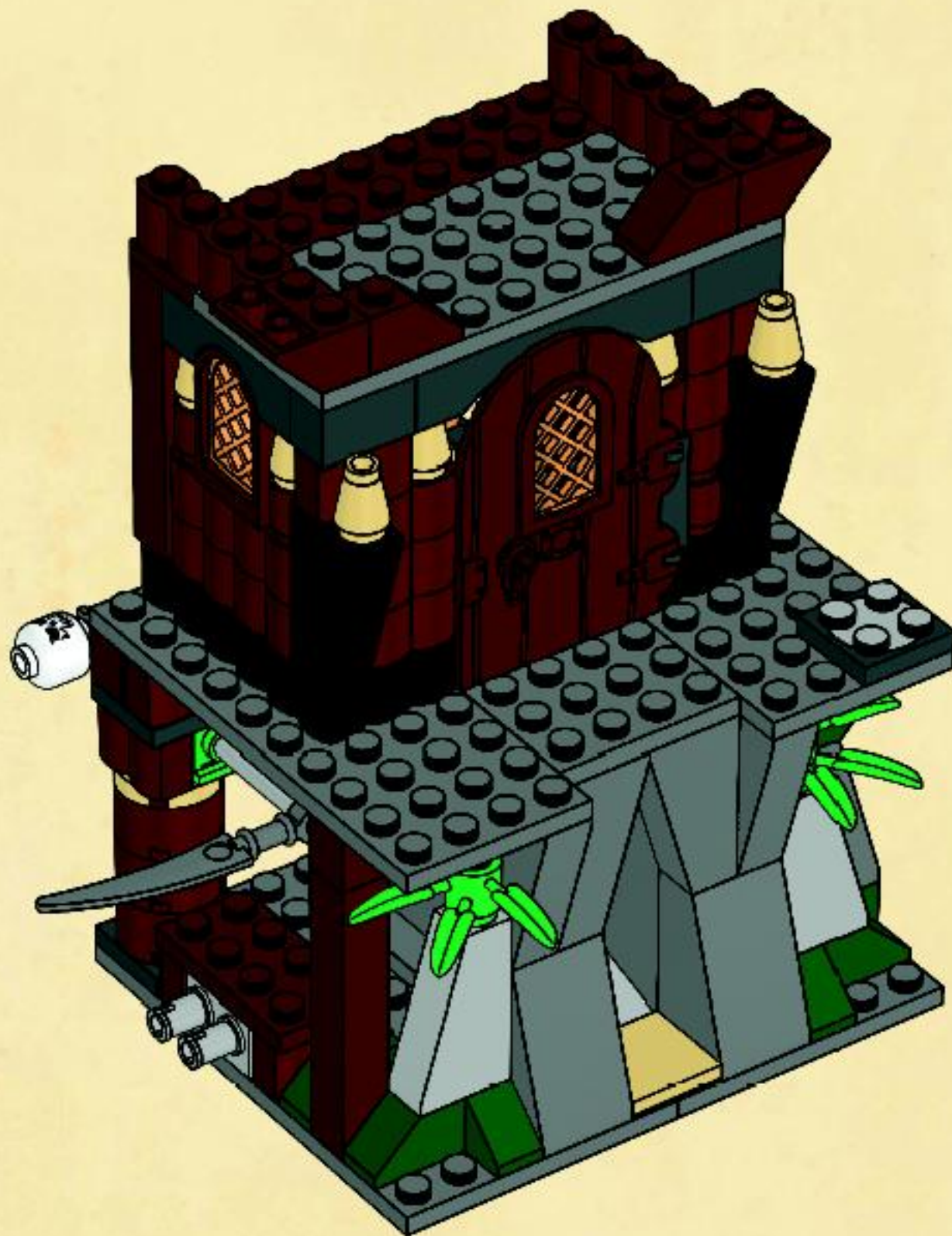

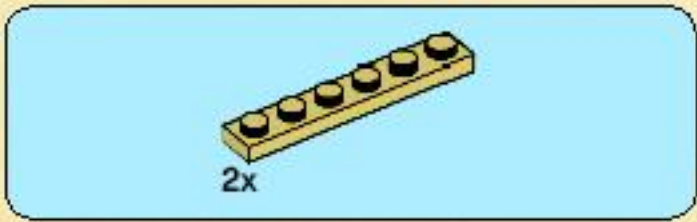

40



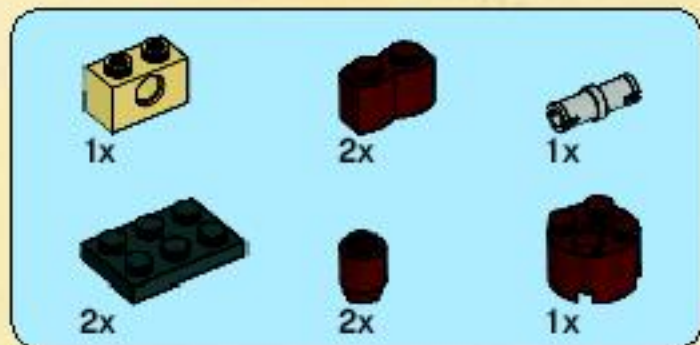

41

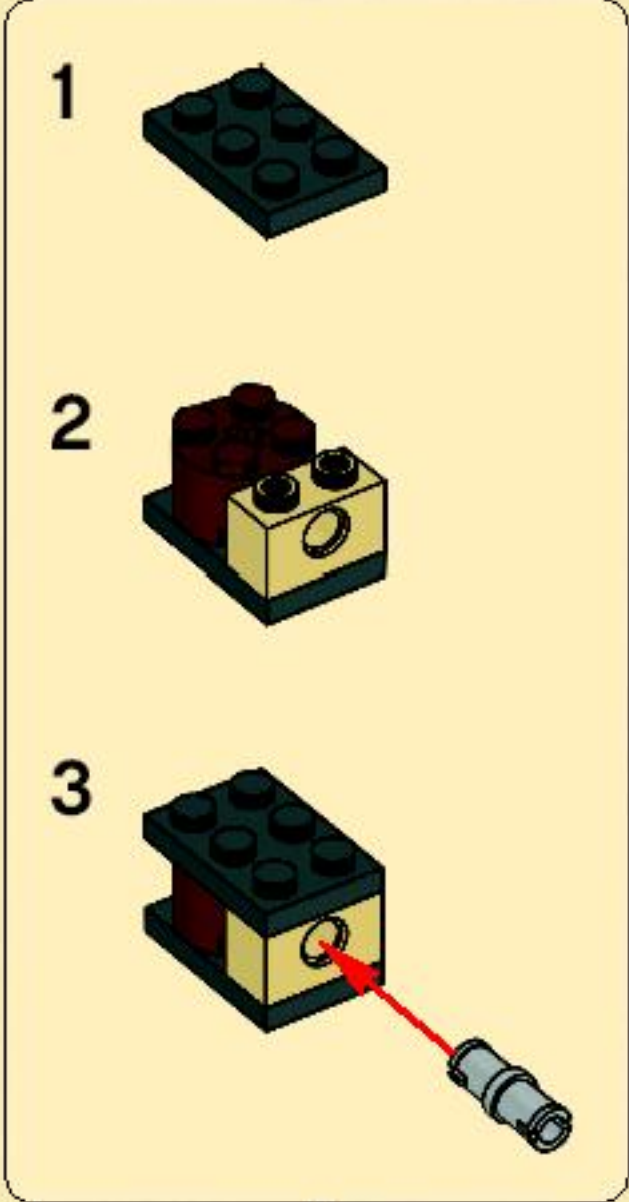
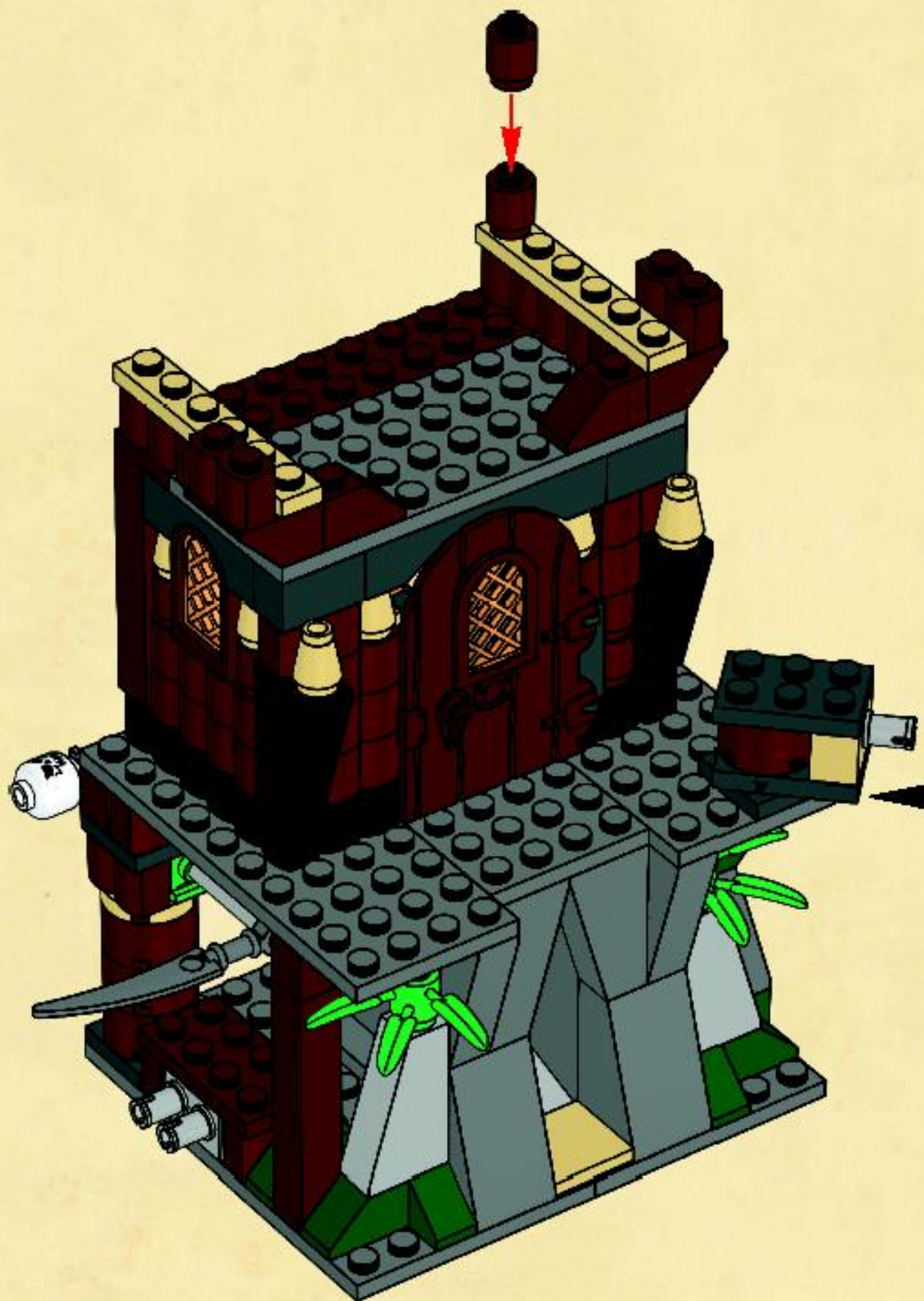

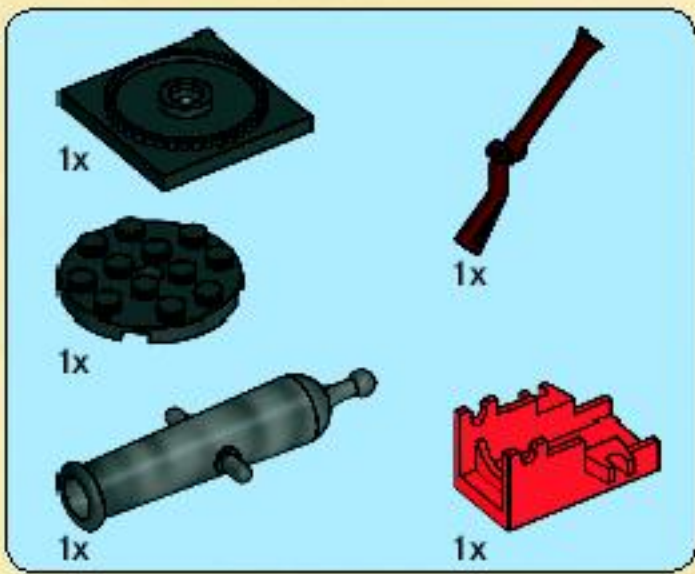

42

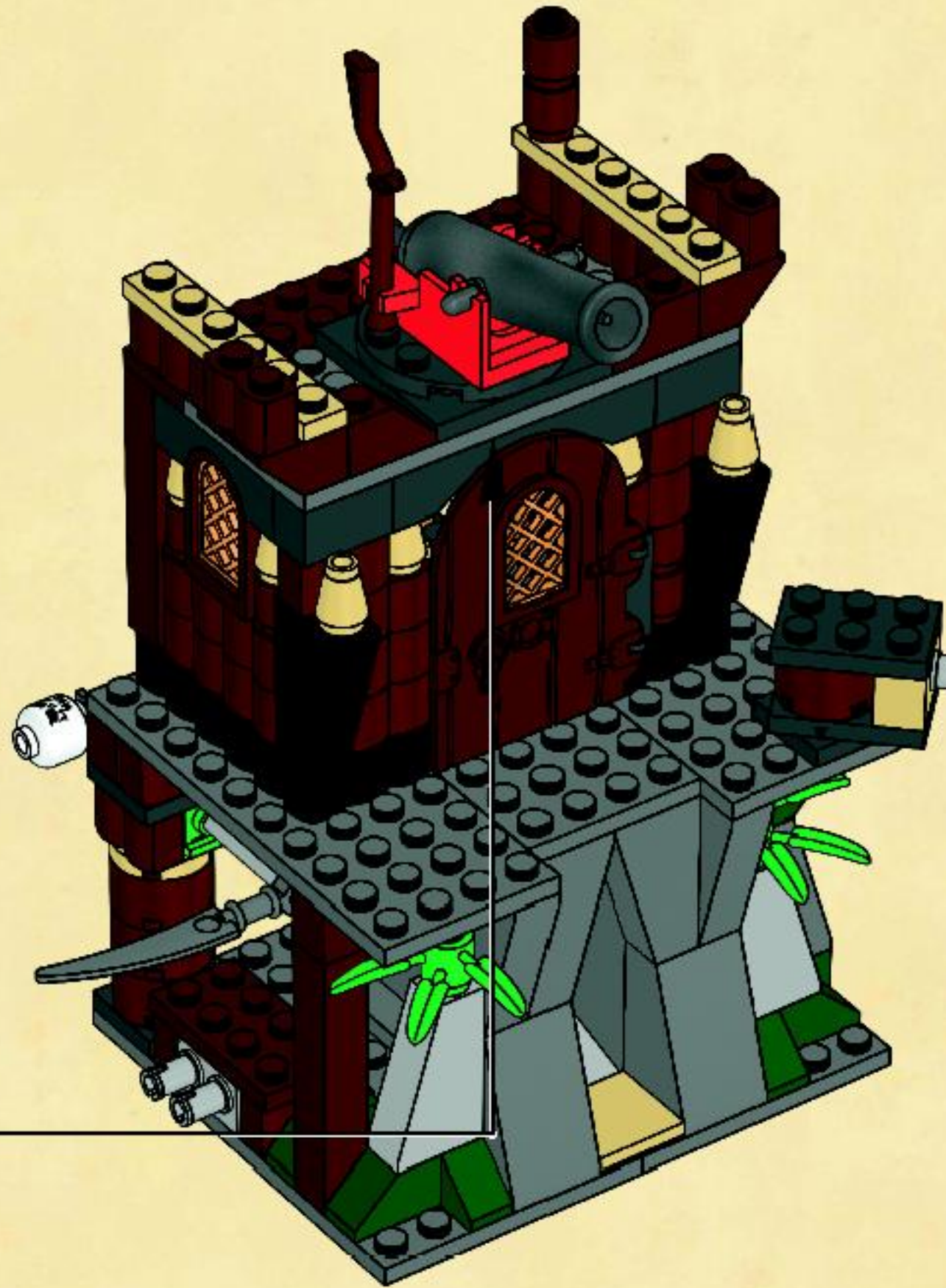
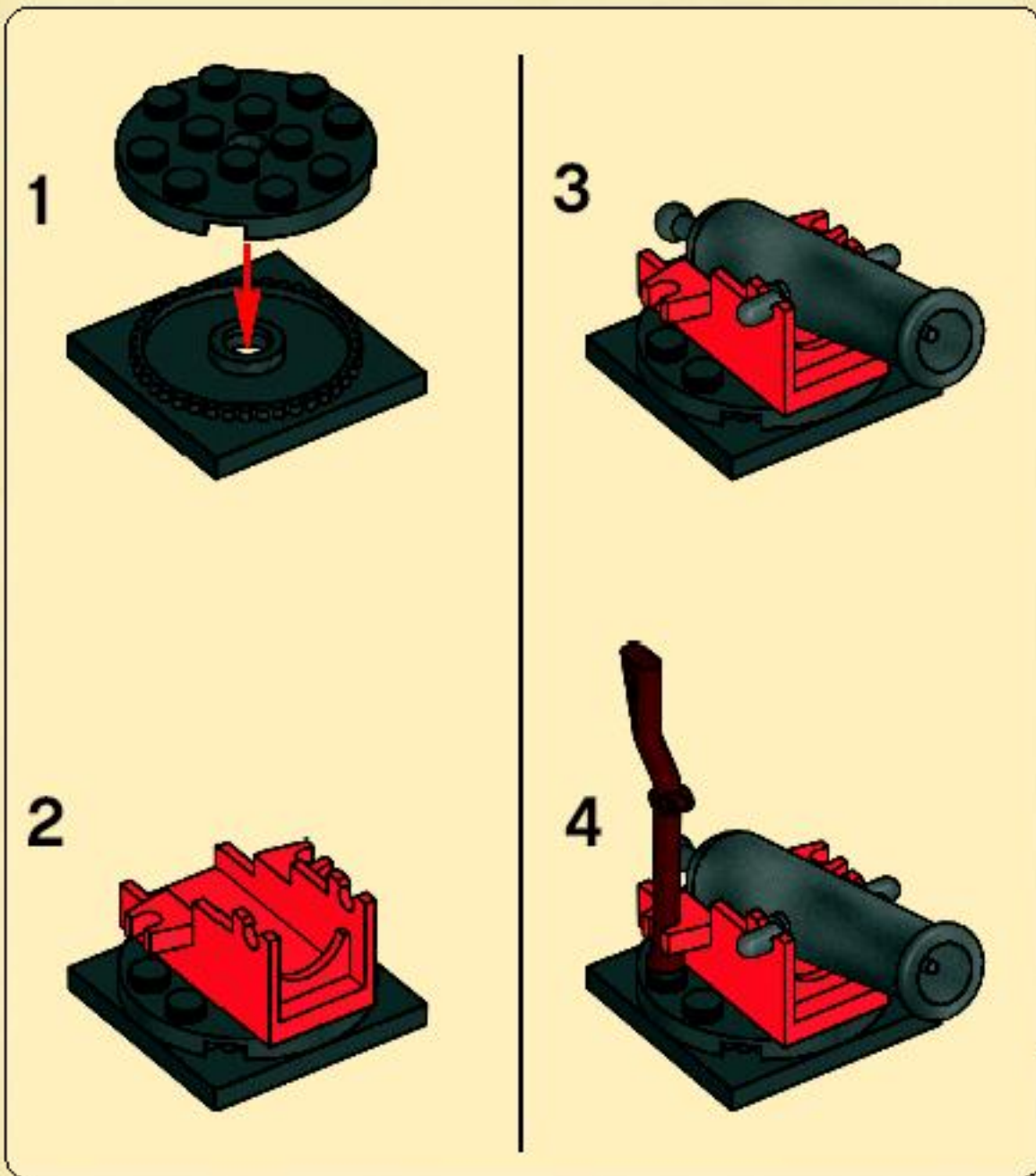



43

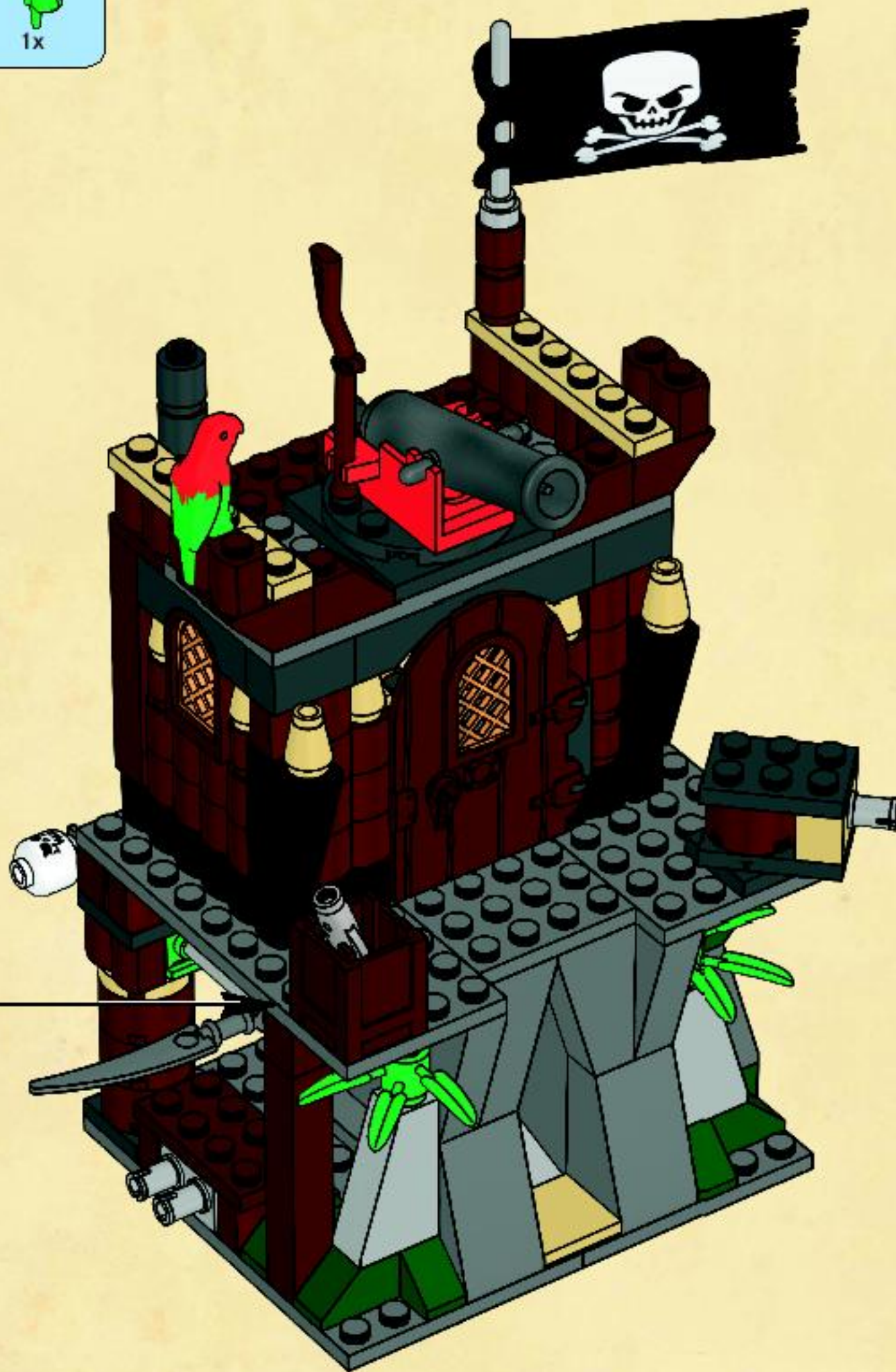
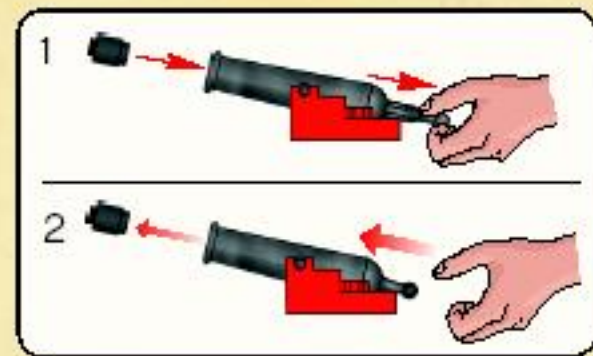

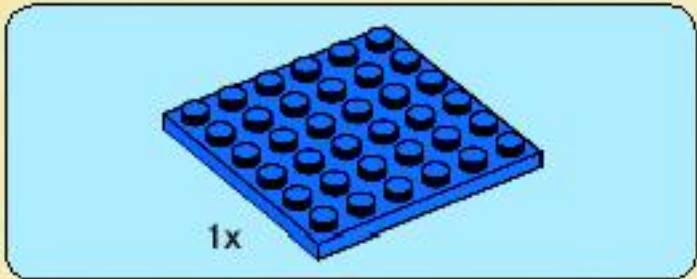

1

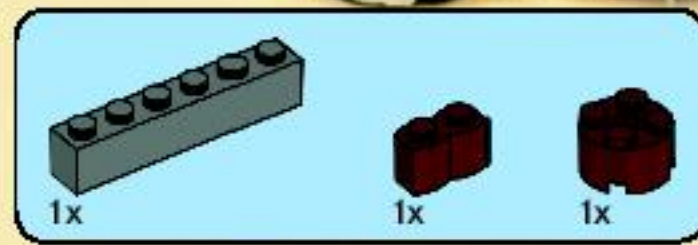
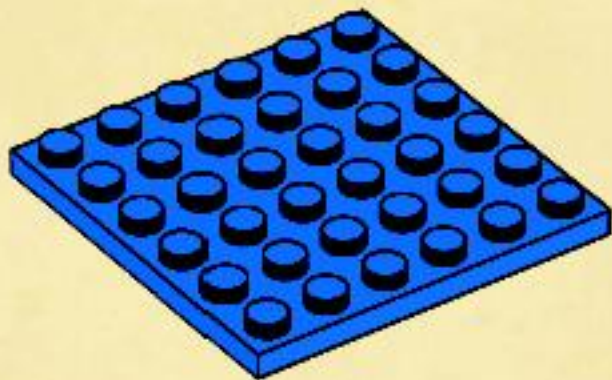

2

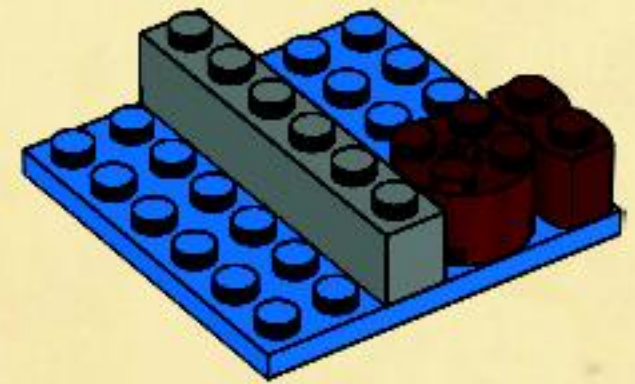

3

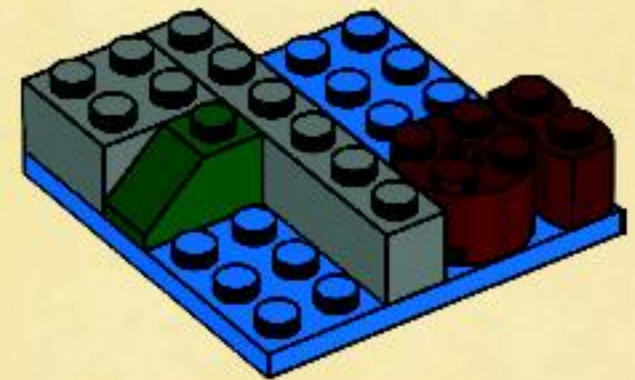



4

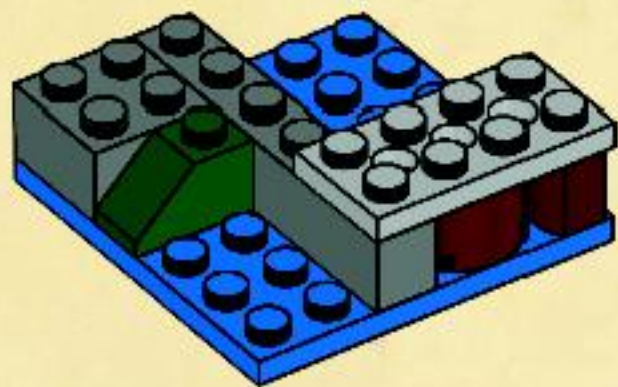

5

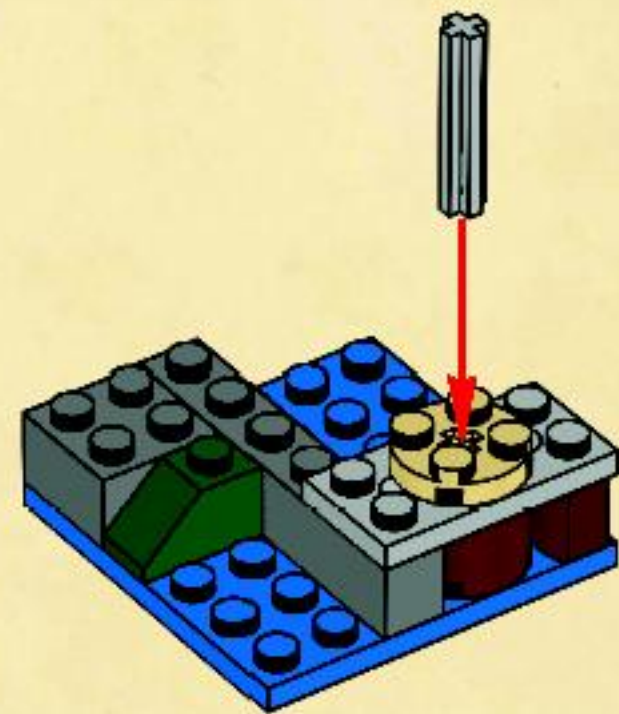

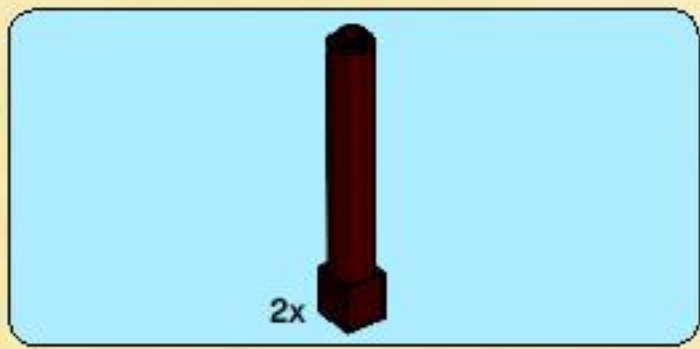

6

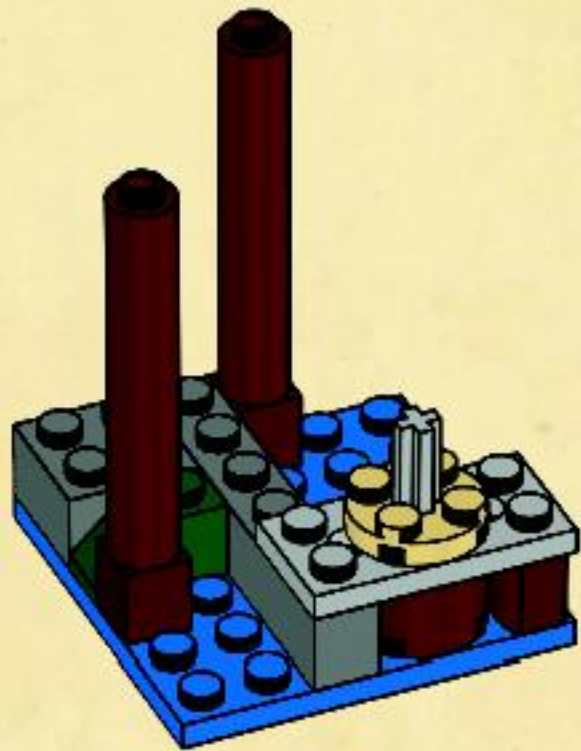

7

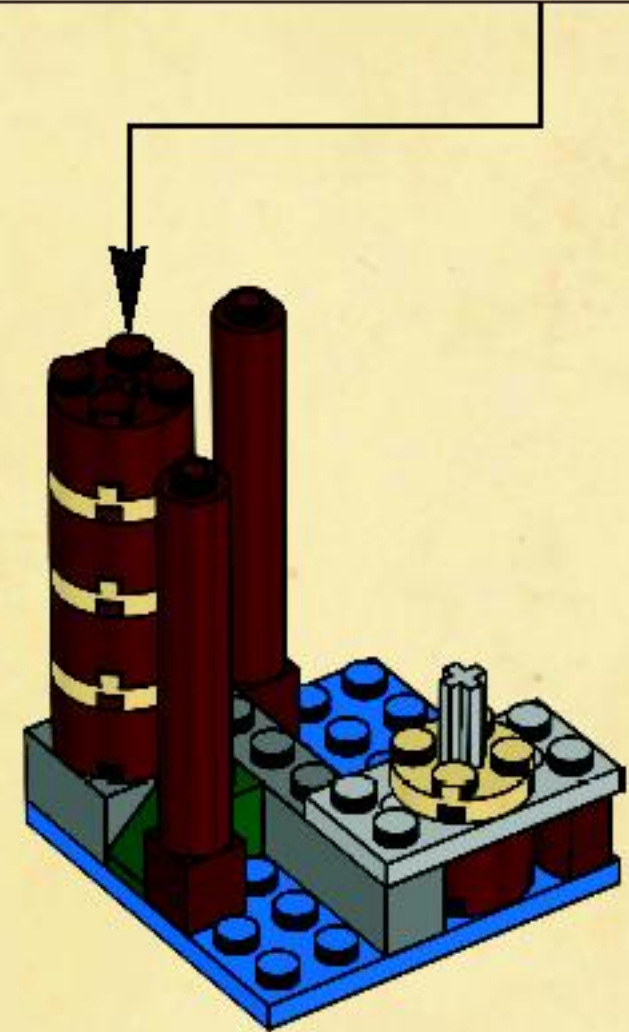
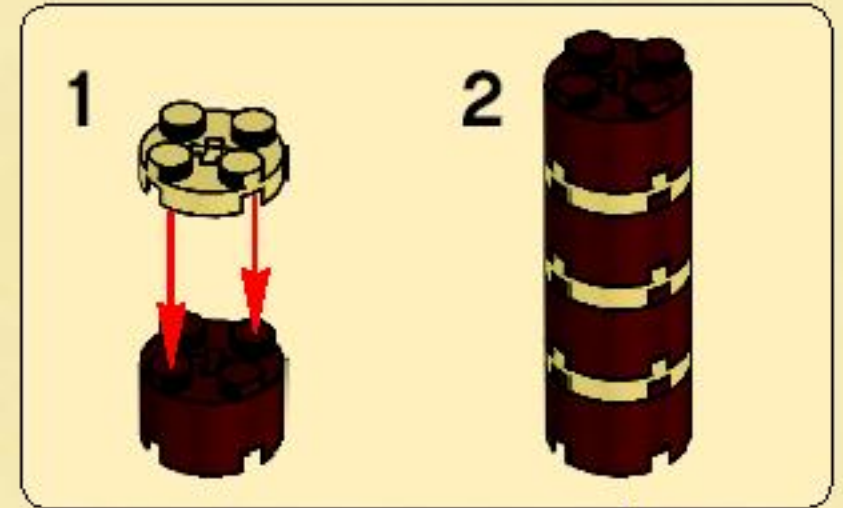

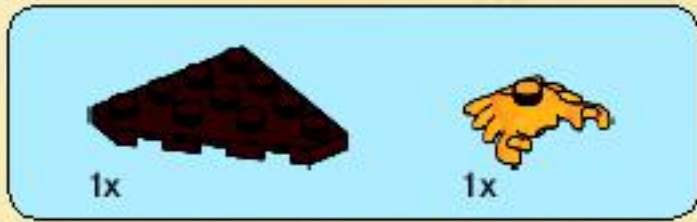

8

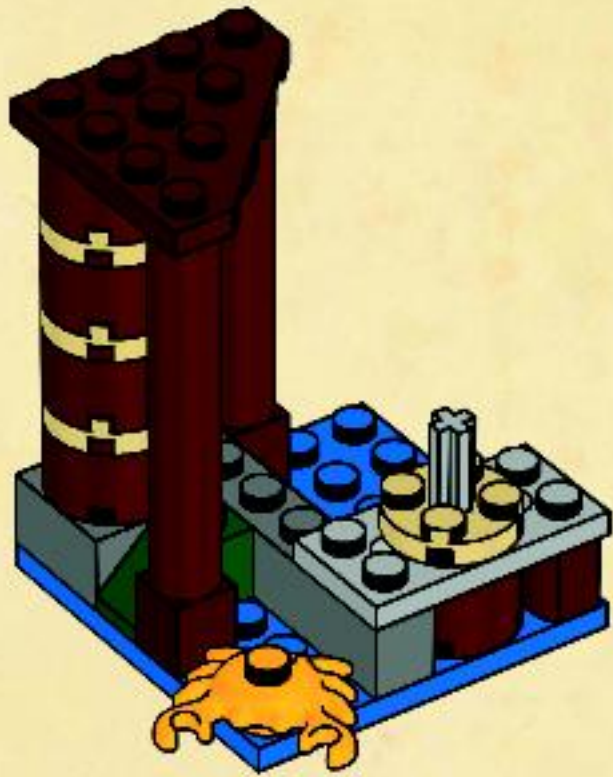

9

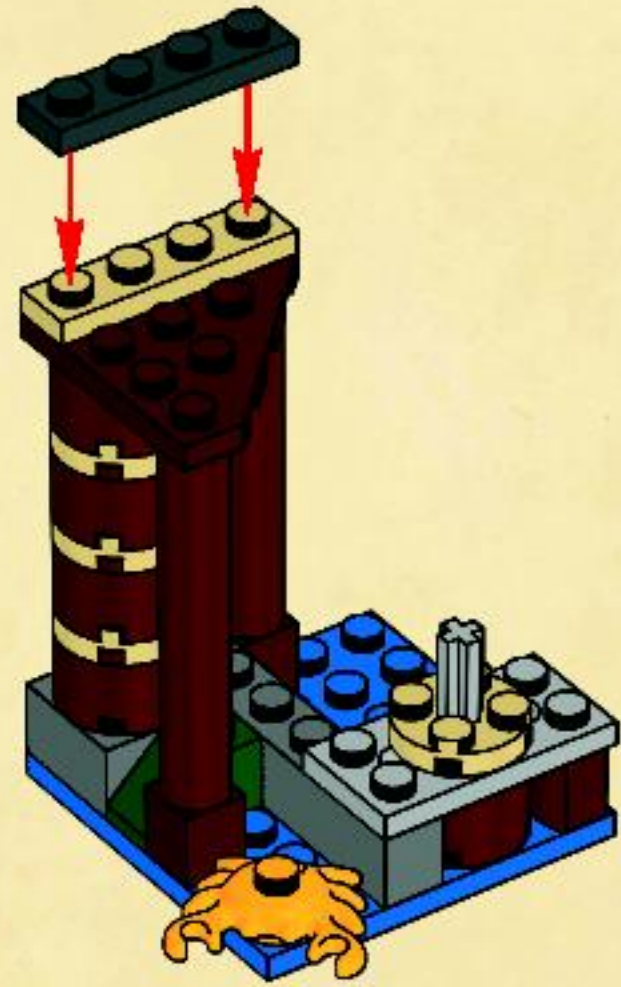

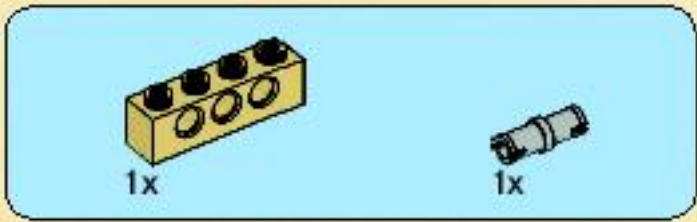

10



11

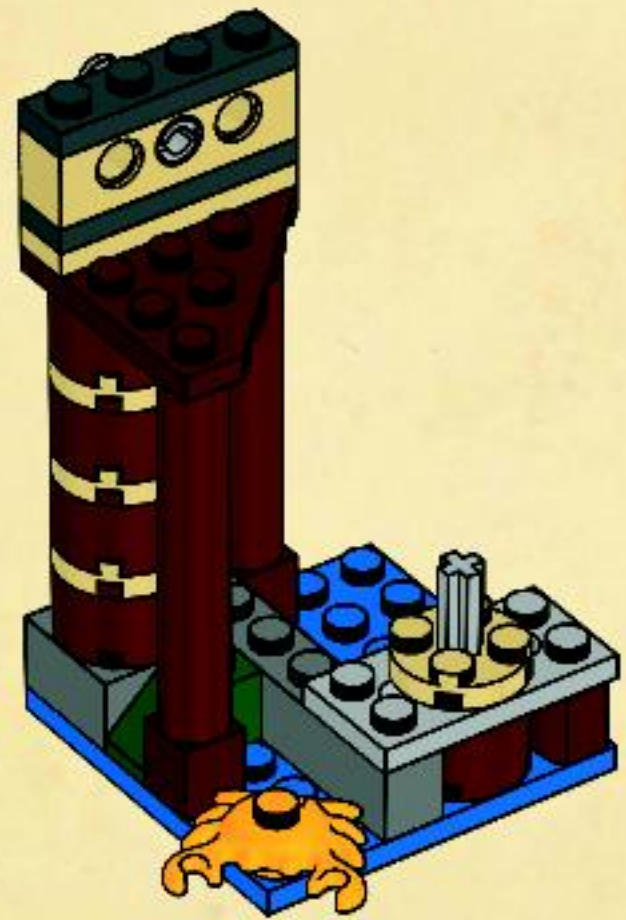

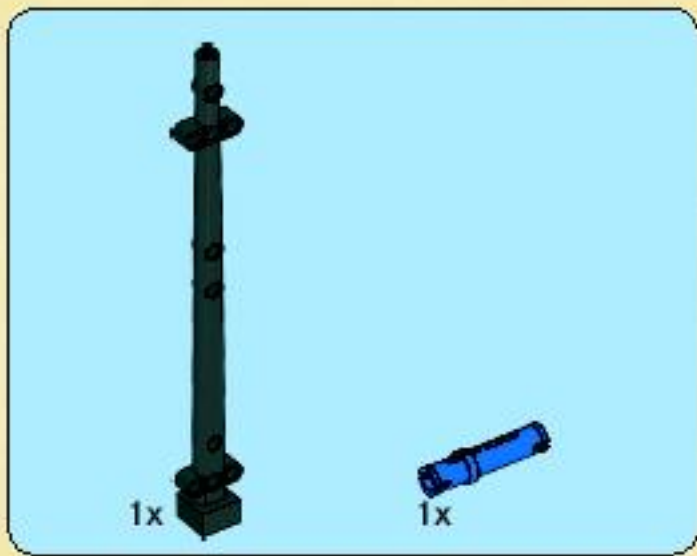

1

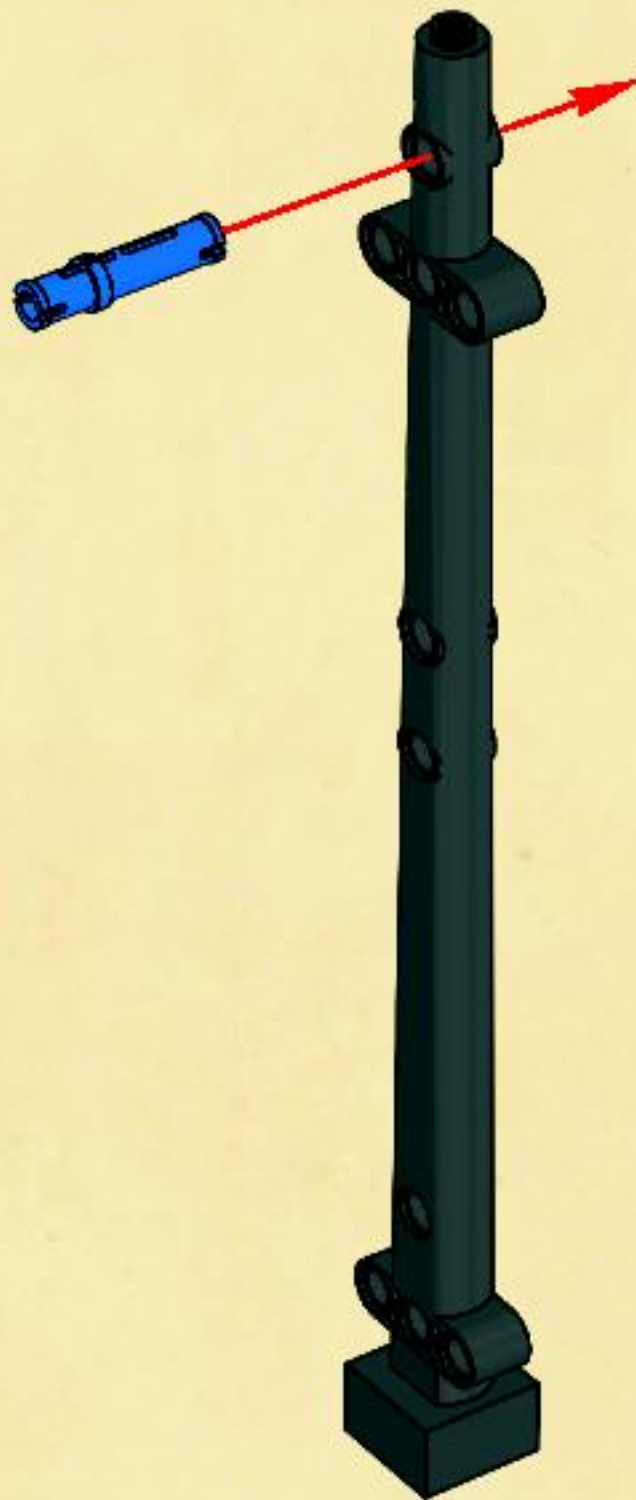



2



3



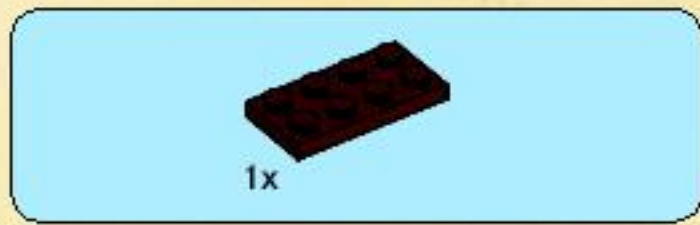

4

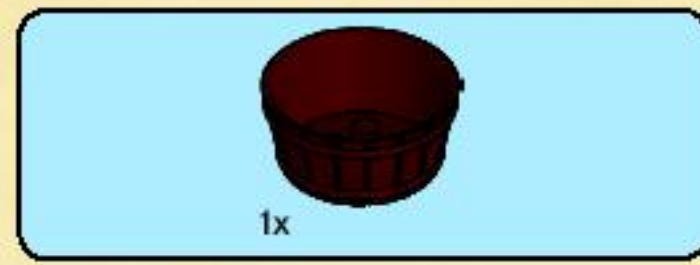

5



12



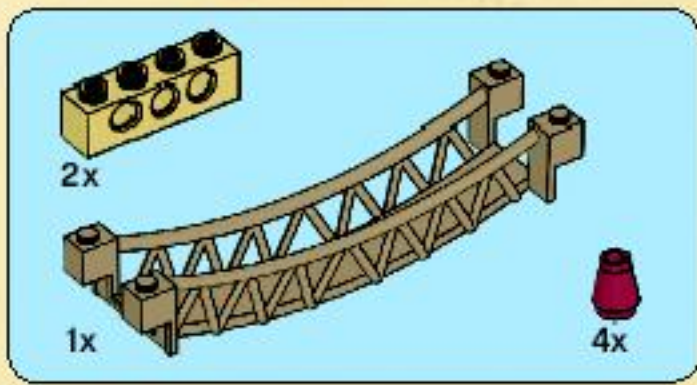

13

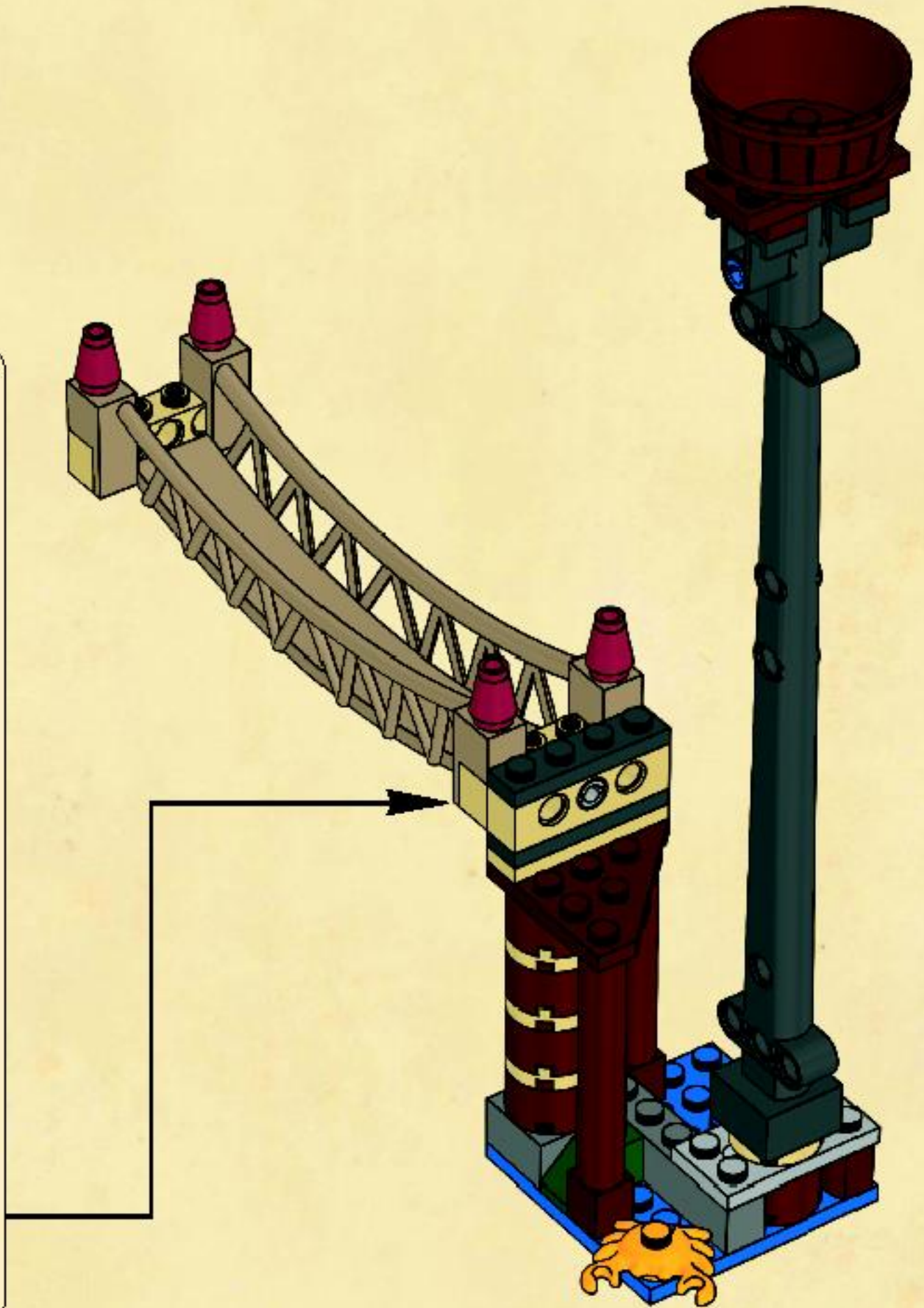
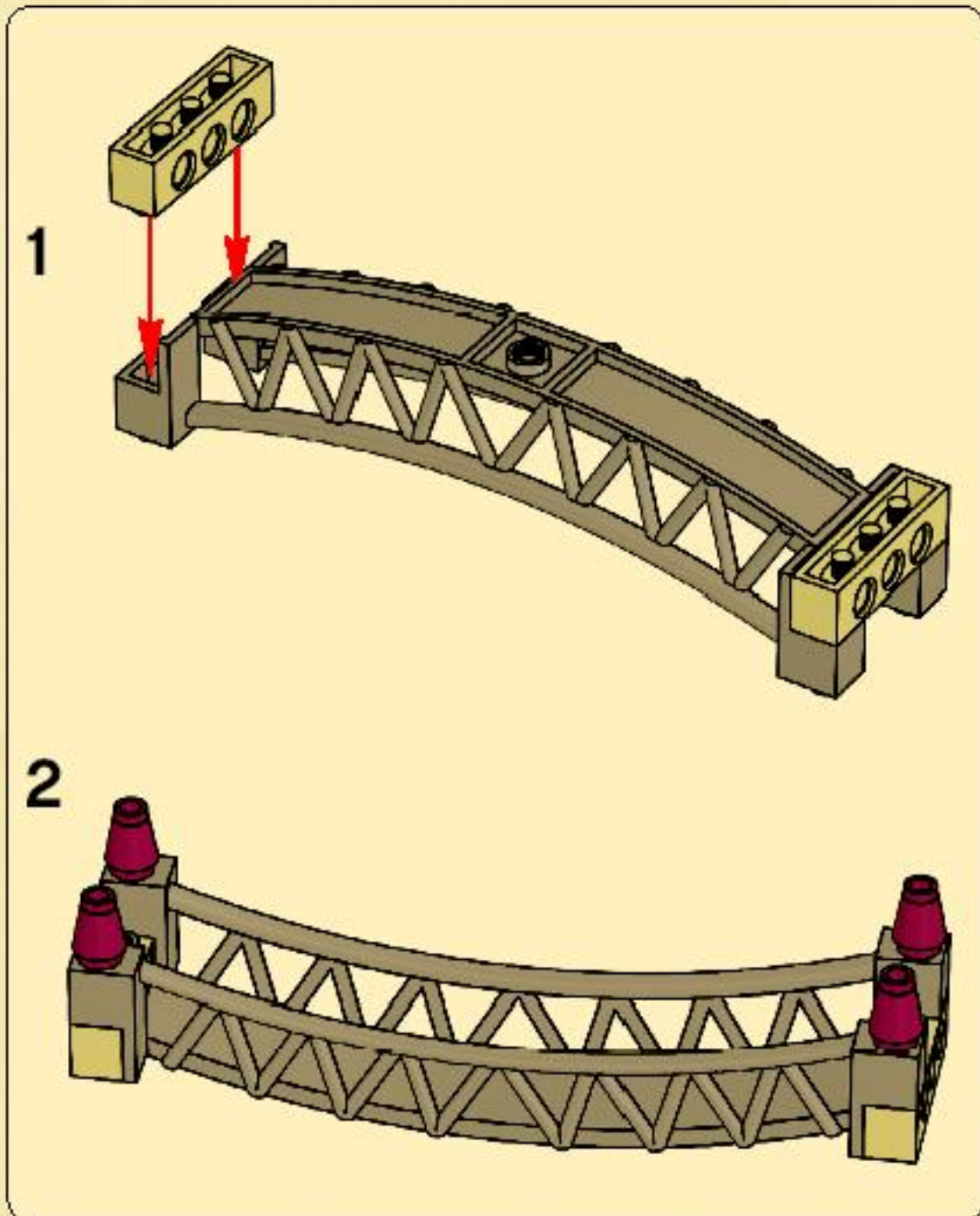

14





15

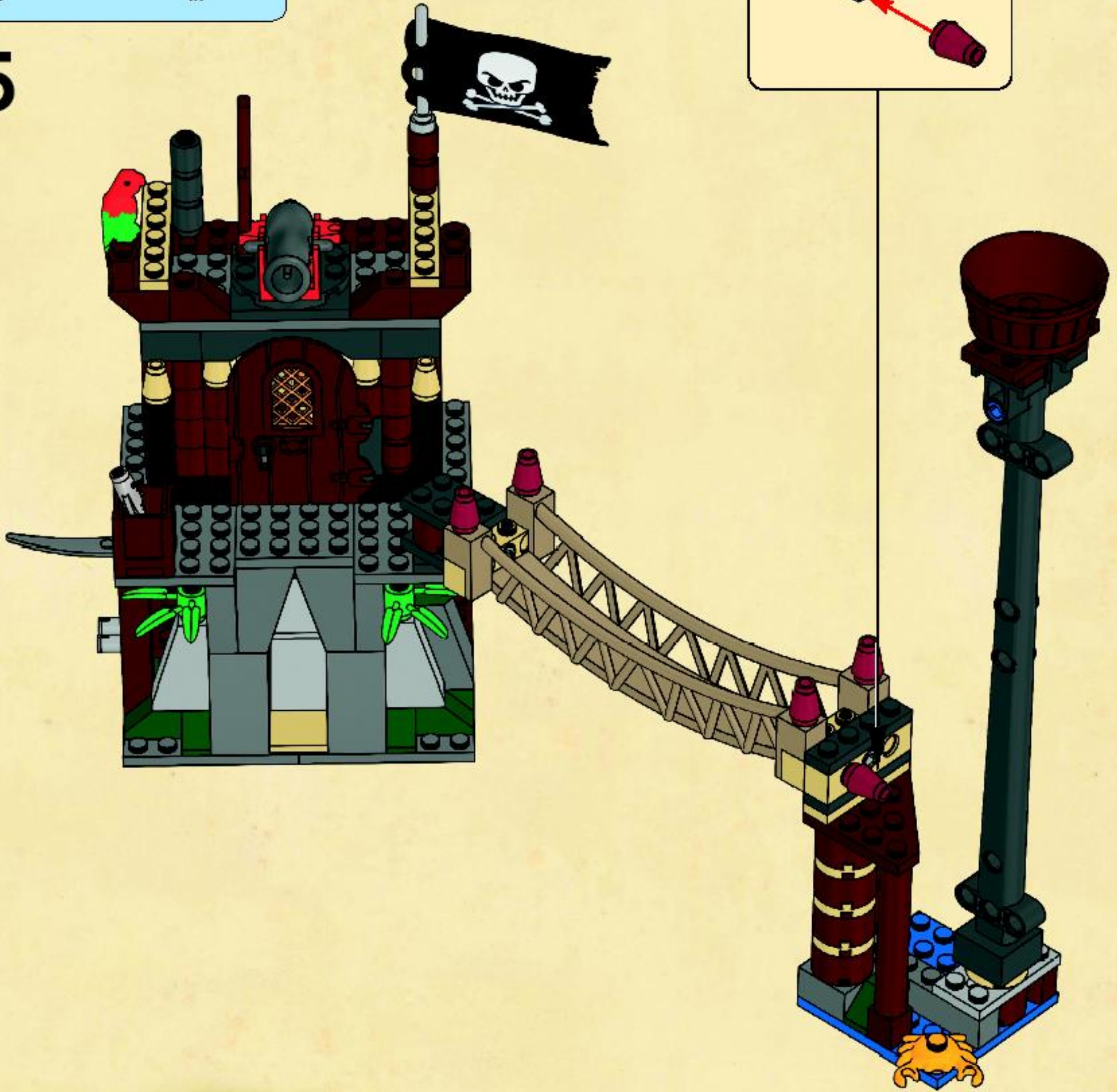
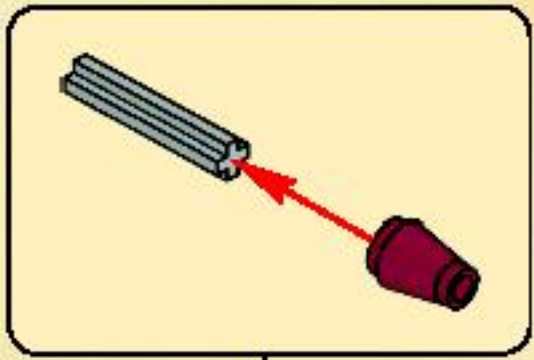

16

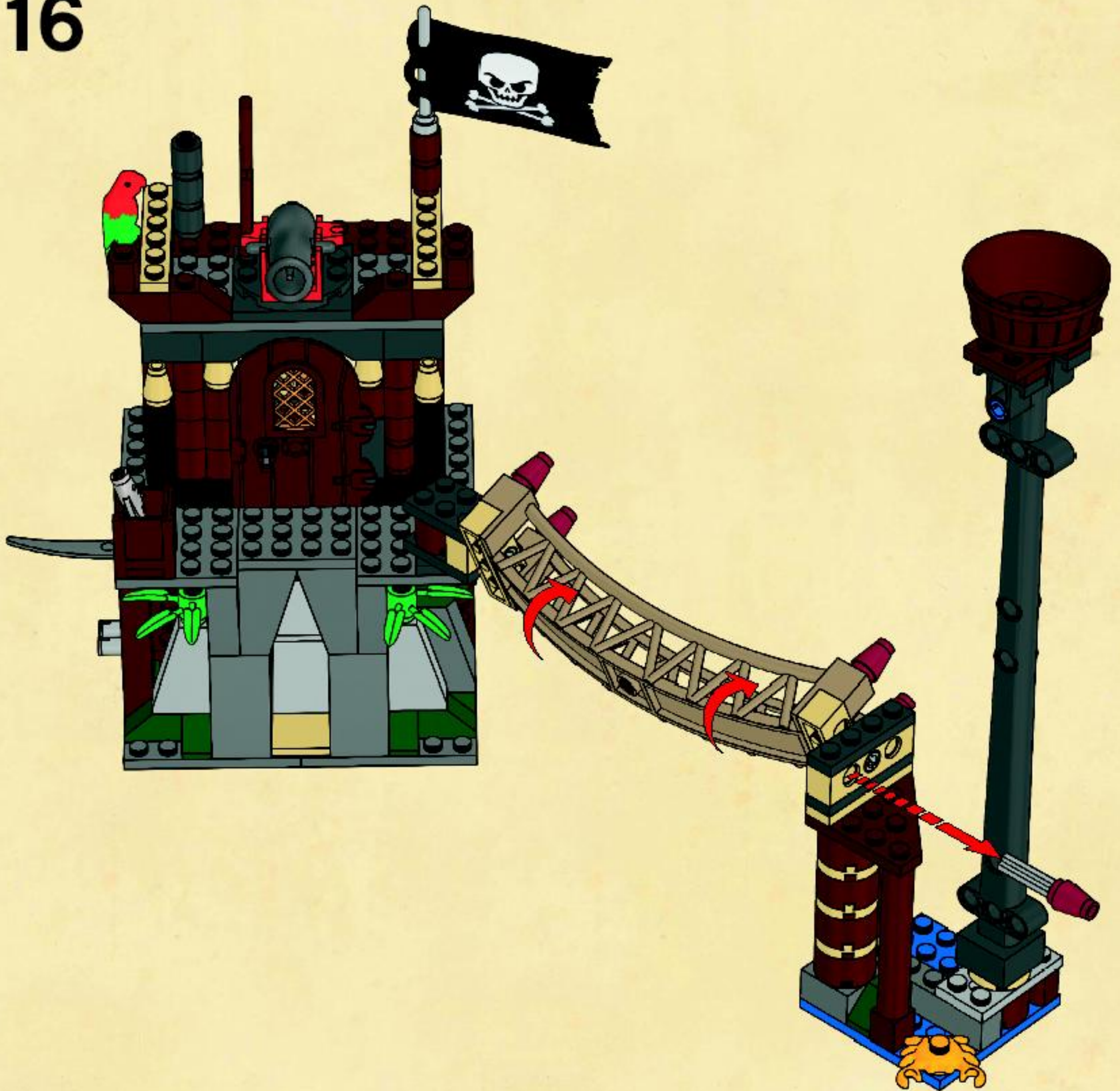

17

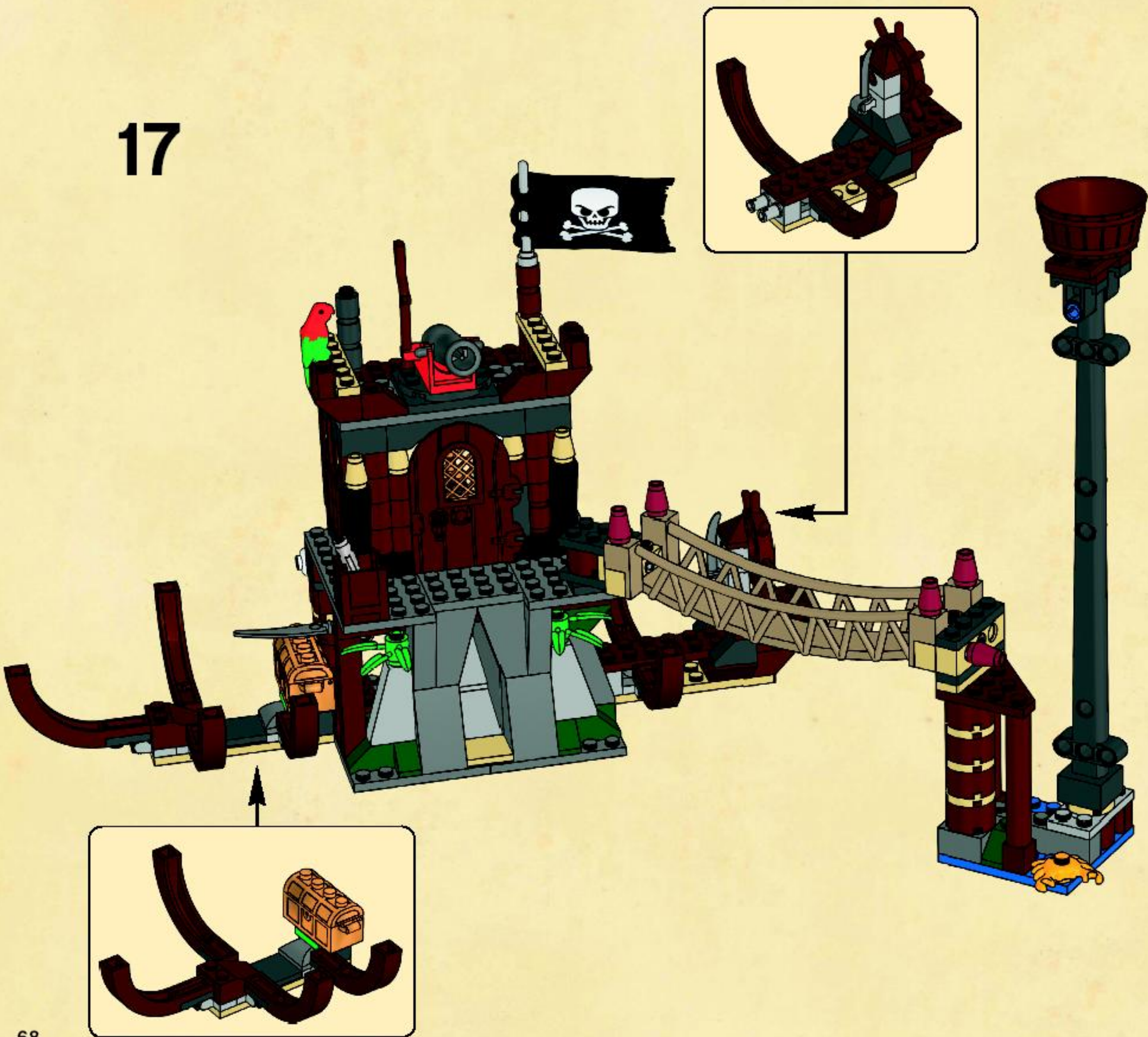





Treasure Map







PIRATES

6239



6240



6242





6241

6243



1x
4540610



2x
9327



5x
4162427



2x
4538969



2x
626601



2x
4505109



1x
4508143



1x
4277338



1x
4520638



3x
4226966



2x
4219726



8x
4211183



4x
4211193



6x
4541894



9x
4211166



2x
4520612



1x
4224732



1x
4219729



1x
4211251



1x
4541893



1x
4211204



2x
4536847



3x
4211311



18x
4211180



6x
4211181



1x
4211214



6x
4211186



1x
4211211



1x
4243838



1x
4504376



2x
4211199



6x
4211221



1x
4216625



1x
4541875



2x
4542131



1x
4540552



1x
4540534



2x
4540514



2x
362321



2x
4114052



1x
4113954



5x
4541498



1x
4514553



2x
4541677



1x
9341



1x
4540446

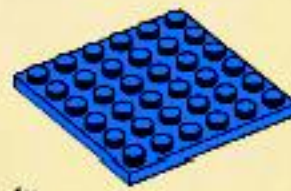

1x
4199519



1x
4185177



1x
4524449



12x
4529237



5x
4113917



1x
4113233



2x
4124067



5x
4140562



2x
4113988



1x
4205107



3x
4234365



1x
4528206



1x
4225875



1x
4539507



1x
4539520



1x
4259916



1x
4128576



1x
4539951



1x
4540699



1x
4517986



2x
300426



2x
3200026



2x
365926



1x
345526



1x
306826



1x
4540696



1x
4263506



1x
4540656



1x
4541678



1x
4541064



1x
4540698



6x
4144575



1x
4107761



2x
371026



3x
302126

1x 4515350
 4x 4121966
 3x 306226
 1x 4541684
 2x 4144023
 4x 368026
 2x 4187334
 2x 4114348
 1x 74040
 1x 302328
 1x 302228
 1x 4113955
 1x 4114505

3x 4266895
 1x 4541096
 6x 4255624
 2x 4529174
 1x 4541846
 2x 4211660
 1x 4211598
 2x 4211807
 2x 4211815
 6x 4515341
 1x 4211444
 2x 4211494

2x 4509915
 1x 4211440
 4x 4540203
 3x 4211473
 1x 4211100
 1x 4211060
 1x 4211048
 3x 4211122
 1x 4211115
 2x 4211114
 2x 4218696

4x 4500975
 5x 4210696
 1x 4509194
 3x 4210789
 2x 4505068
 1x 4540070
 1x 4540642
 1x 4539486
 2x 4518561
 1x 4527065

3x 4541895
 1x 4541393
 1x 4541394
 1x 4505990

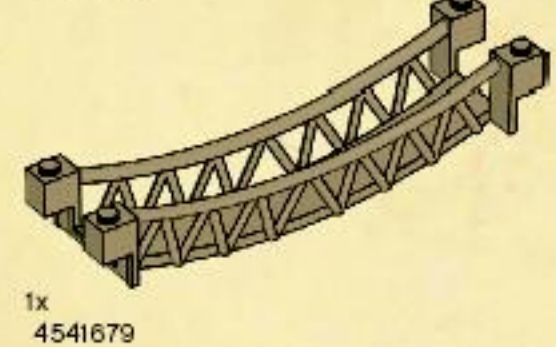

1x 4523157
 1x 4538126
 8x 4519970
 1x 70501
 1x 4540700

Customer Service
 Kundenservice
 Service Consommateurs
 Servicio Al Consumidor
 www.lego.com/service or dial
 : 00800 5346 5555
 : 1-800-422-5346



www.nielsen.com/LEGO



WIN LEGO® PRODUCTS

Fill out a survey and you might WIN a cool LEGO product!
NO PURCHASE NECESSARY

Open to all residents where not prohibited
Go to www.nielsen.com/dk/LEGO to fill out a survey for a chance to win a LEGO product.

WIN LEGO® PRODUCTEN

Vul een enquêteformulier in en maak kans op een cool LEGO® product!

Kopen niet nodig

Iedereen uit landen waar geen enquêteverbod geldt mag deelnemen.

Ge naar www.nielsen.nl/dk/LEGO, vul een enquêteformulier in en maak kans op een LEGO product.

GEWINNE LEGO® PRODUKTE

Nimm an der Umfrage teil und GEWINNE ein tolles LEGO® Produkt!

Die Teilnahme am Gewinnspiel führt zu keinerlei Kaufverpflichtungen

Teilnahme in allen nicht ausgeschlossenen Ländern möglich

Wir verlosen unter allen Teilnehmern der Umfrage auf www.nielsen.nl/dk/LEGO LEGO Produkte.

GAGNE DES PRODUITS LEGO®

Réponds à un questionnaire et tu pourrais GAGNER un produit LEGO® très cool!

Aucune obligation d'achat

Ouvert à tous les résidents des pays autorisés.

Visite www.nielsen.nl/dk/LEGO pour répondre à un questionnaire et avoir une chance de gagner un produit LEGO.

レゴ®製品を「当てよう」

アンケートに記入して、かっこいいレゴ®製品を当てよう!

お買い上げの必要はありません。

禁止されていない限り、すべての皆様にご利用いただけます。

www.nielsen.com/dk/LEGOにアクセスして、アンケートにご記入ください。当選者にはレゴ製品を差し上げます。



 www.LEGO.com

©2009 The LEGO Group. 4549579